



# AIC Colour 2013

12th Congress of the International  
Colour Association  
8-12 July, 2013  
Newcastle upon Tyne, UK

## Proceedings Volume 3

Editors:  
Lindsay MacDonald,  
Stephen Westland,  
Sophie Wuerger

The Colour Group (Great Britain)

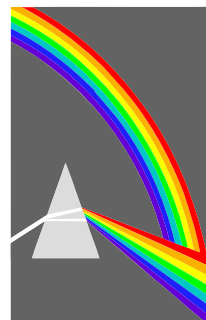

International Colour Association  
Internationale Vereinigung für die Farbe  
Association Internationale de la Couleur



Sunday 7th July		Monday 8th July		Tuesday 9th July		Wednesday 10th July		Thursday 11th July		Friday 12th July	
07:00	07:30	07:00	07:30	07:00	07:30	07:00	07:30	07:00	07:30	07:00	07:30
Registration and Exhibition Open		Registration and Exhibition Open		Registration and Exhibition Open		Registration and Exhibition Open		Registration and Exhibition Open		Registration and Exhibition Open	
Hall One Opening Ceremony		Hall One Keynote - Andrew Parker		Hall One Keynote - Fiona Jenvey		Hall One JUDD Award		Hall One Keynote - Hilary Dalke		Hall One Keynote - Stephen Palmer	
COFFEE		COFFEE		COFFEE		COFFEE		COFFEE		COFFEE	
Special Symposium: LED Lighting		Special Symposium: Fashion		Special Symposium: MCS2013		Special Symposium: AIC General Assembly		Special Symposium: Aesthetics		Special Symposium: From the Retina to the Cortex	
Hall Two Colour and Food		Hall Two Architectural Colour		Hall Two Product Design and Branding		Hall Two AIC General Assembly		Hall Two Colour Colormetry		Hall Two Colour Education	
Hall Two Wellbeing		Hall Two Colour in Art		Hall Two Colour Technology		Hall Two The Colour of Culture		Hall Two Difference		Northern Rock Room Interior Design and Lighting	
LUNCH		LUNCH*		LUNCH		LUNCH		LUNCH		Foyer LUNCH, Posters and Exhibition	
Foyer Posters and Exhibition		Foyer Posters and Exhibition		Foyer Posters and Exhibition		Foyer Coaches depart for city excursion		Foyer Posters and Exhibition		Hall One Special Symposium: Colour Harmony	
Hall One Special Symposium: Museum Lighting		Hall One Special Symposium: Sustainable Coloration		Hall One Special Symposium: Colour Imaging		Durham City City Excursion		Hall One Special Symposium: Environmental Colour		Hall Two Colour and Music	
Northern Rock Room Ergonomics		Northern Rock Room AIC Study Groups		Northern Rock Room Colour Imaging		The Sage Gateshead Concert		Hall Two Colour Printing		Hall Two Colour Naming	
The Hatton Gallery Official Congress Opening		The Sage Gateshead Concert		The Sage Gateshead Concert		Coaches depart for Alnwick		Coaches depart for Alnwick		Hall One: Capstone Presentation	
Welcome Drinks + Registration Open		* 13:00-14:15 - SDC Networking Lunch (invitees only)		* 13:00-14:15 - SDC Networking Lunch (invitees only)		The Alnwick Gardens Official Congress Banquet		The Alnwick Gardens Official Congress Banquet		Hall One: Closing Ceremony	
07:00	07:30	07:00	07:30	07:00	07:30	07:00	07:30	07:00	07:30	07:00	07:30
BALTIC Terrace		Lit & Phil		AIC Executive Committee Meeting							
08:00	08:30	08:00	08:30	08:00	08:30	08:00	08:30	08:00	08:30	08:00	08:30
09:00	09:30	09:00	09:30	09:00	09:30	09:00	09:30	09:00	09:30	09:00	09:30
10:00	10:30	10:00	10:30	10:00	10:30	10:00	10:30	10:00	10:30	10:00	10:30
11:00	11:30	11:00	11:30	11:00	11:30	11:00	11:30	11:00	11:30	11:00	11:30
12:00	12:30	12:00	12:30	12:00	12:30	12:00	12:30	12:00	12:30	12:00	12:30
13:00	13:30	13:00	13:30	13:00	13:30	13:00	13:30	13:00	13:30	13:00	13:30
14:00	14:30	14:00	14:30	14:00	14:30	14:00	14:30	14:00	14:30	14:00	14:30
15:00	15:30	15:00	15:30	15:00	15:30	15:00	15:30	15:00	15:30	15:00	15:30
16:00	16:30	16:00	16:30	16:00	16:30	16:00	16:30	16:00	16:30	16:00	16:30
17:00	17:30	17:00	17:30	17:00	17:30	17:00	17:30	17:00	17:30	17:00	17:30
18:00	18:30	18:00	18:30	18:00	18:30	18:00	18:30	18:00	18:30	18:00	18:30
19:00	19:30	19:00	19:30	19:00	19:30	19:00	19:30	19:00	19:30	19:00	19:30
20:00	20:30	20:00	20:30	20:00	20:30	20:00	20:30	20:00	20:30	20:00	20:30
21:00	21:30	21:00	21:30	21:00	21:30	21:00	21:30	21:00	21:30	21:00	21:30
22:00	22:30	22:00	22:30	22:00	22:30	22:00	22:30	22:00	22:30	22:00	22:30
23:00		23:00		23:00		23:00		23:00		23:00	

programme overview



# **AIC Colour 2013**

**12th Congress of the International  
Colour Association  
8-12 July, 2013  
Newcastle upon Tyne, UK**

## **Proceedings Volume 3**

**Editors:  
Lindsay MacDonald,  
Stephen Westland,  
Sophie Wuerger**

### **Contents**

Poster Session 1  
Author Index

757-1292  
1293-1308



# poster session I



# Using B-phycoerythrin from Microalgae as a Natural Colorant to Reproduce the Color in Commercial Strawberry Yogurts

Ruperto BERMEJO,<sup>1</sup> Piedad LIMÓN,<sup>1</sup> F. Gabriel ACIÉN-GERNÁNDEZ,<sup>2</sup>

J. María FERNÁNDEZ-SEVILLA,<sup>2</sup> Manuel MELGOSA<sup>3</sup>

<sup>1</sup> Department of Physical and Analytical Chemistry, High Politechnical School of Linares, University of Jaén, Jaén (Spain)

<sup>2</sup> Department of Chemical Engineering, University of Almería, Almería (Spain)

<sup>3</sup> Department of Optics, University of Granada, Granada (Spain)

## ABSTRACT

In order to study the usefulness of B-phycoerythrin as a natural colorant, an extract of this phycobiliprotein was obtained from the microalga called *Porphyridium cruentum* by expanded bed adsorption chromatography, and this extract was used to generate pink colorations in white (natural) yogurts. As expected from the intense pink color of the B-phycoerythrin extract, by adding increasing amounts of B-phycoerythrin to white yogurts, the CIELAB  $a^*$  coordinate increased, while  $b^*$  and  $L^*$  decreased, following almost asymptotic trends (in particular the  $a^*$  coordinate). We analyzed whether the color of four different commercial strawberry yogurts with pink synthetic dyes can be also achieved using the B-phycoerythrin natural colorant. For one of these four commercial yogurts, the addition of a small amount of B-phycoerythrin extract (0.05 ml) to the white yogurt led to a minimum color difference of 2.9 CIELAB units with respect to the strawberry yogurt with synthetic dyes, which means an acceptable color reproduction. However, for the other three commercial yogurts, we needed to add to the white yogurts 0.125, 0.175 and 0.200 ml of B-phycoerythrin extract to obtain color-differences below 5.0 CIELAB units. Current results are encouraging about the usefulness of B-phycoerythrin as a natural colorant in some industrial applications.

## 1. INTRODUCTION

Colorants are additives widely used in industrial sectors such as food, drinks and cosmetics. Actually a high percentage of colorants used are synthetic and many of them can produce toxic reactions in susceptible organisms. Thus, there is a growing interest in searching new molecules with good coloring capacity to expand the catalogue of natural colorants available in the market. In this sense, phycobiliproteins are proteins that form light-harvesting antenna complexes (phycobilisomes) acting as photosynthetic accessory pigments in cyanobacteria and red algae. Phycobiliproteins consist of three main groups: phycoerythrins, phycocyanins and allophycocyanins. B-phycoerythrin has been found particularly useful because of its intense and unique pink color, spectroscopic properties, stability, high absorption coefficient and high quantum yield. B-phycoerythrin may be interesting as a natural colorant for use in food, cosmetics and pharmaceuticals, particularly as substitute of current synthetic dyes.

A number of different studies have reported that synthetic colorants are potentially toxic and even carcinogenic, producing also allergic reactions in susceptible people (Arad and Yaron, 1992). Therefore there is a growing consumers' demand to replace synthetic colorants by other natural compounds, and this demand must be considered by the corresponding affected industrial sectors. In this context, it is important to emphasize that most previously

mentioned health problems do not appear using natural compounds from living organisms known as biocolorants. Unfortunately, only a relatively reduced number of natural colorants appear in the recently approved European catalogue (EFSA, 2012), in comparison with the number of synthetic colorants, and it can be said that currently the use of synthetic colorants is predominant in most industrial applications.

Biliproteins are water-soluble biological macromolecules present in some photosynthetic organisms like microalgae, which have the property of collecting surrounding light. These proteins are employed in different biotechnological applications (Glazer, 1999). In addition, biliproteins have high extinction coefficients and intense attractive colors, which make the corresponding biomolecules particularly interesting as potential natural colorants. Most abundant biliproteins in nature are phycoerythrins, exhibiting pink, red and orange colors, and phycocyanins, exhibiting blue and purple colors. The relatively abundant amount of these proteins in some living organisms together with their diverse and intense colors make them appropriate candidates as colorants. In fact nowadays they are a good alternative to increase the offer of natural colorants available in the market.

Although natural colorants are widely found in nature, the major obstacle to introduce them as additives is the high investment required in their purification processes. We developed a new methodology called “expanded bed adsorption chromatography” to obtain large quantities of phycobiliproteins simplifying the downstream-processing flow sheets for the recovery of phycobiliproteins, with concomitant savings in equipment and operating costs (Bermejo et al., 2007; Bermejo and Ramos, 2012; Ramos et al., 2010). In this paper we analyze the color properties of a new B-phycoerythrin enriched solution, obtained from the microalga called *Porphyridium cruentum*, studying its usefulness as a natural colorant to produce yogurts with similar colors to the ones found in four commercial strawberry yogurts incorporating synthetic colorants.

## 2. METHODS

A B-phycoerythrin enriched solution (Figure 1) was obtained from the *Porphyridium cruentum* microalga using our own procedure described in the literature (Bermejo et al., 2007). This solution was employed as a natural colorant added in different amounts to different commercial white (natural; without any colorant) yogurts. We tried to reproduce the color of four commercial strawberry yogurts (Danone, Clesa, Auchan and Macedonia Clesa) by adding increasing amounts of the B-phycoerythrin solution to the commercial white yogurts from the same trademarks. The prepared samples were properly homogenized after addition of the colorant before the corresponding color measurements. B-phycoerythrin solution additions stop when color differences below 5.0 CIELAB units were found with respect to the commercial strawberry yogurts.



Figure 1. B-Phycoerythrin solution, the natural colorant extracted from *Porphyridium cruentum* microalga which has been used in our coloration experiments.



Color measurements of all our samples were performed using a Konica Minolta CM-5 spectrophotometer with the SpectraMagic NX PRO USB software. After proper calibration of the instrument, the CIELAB color coordinates were measured for 15 g samples placed in 4.2 x 3.2 x 1.0 cm transparent quartz cells, assuming D65 illuminant and CIE 1931 colorimetric observer.

### 3. RESULTS AND DISCUSSION

The main characteristics of the B-phycoerythrin solution (enriched extract) employed in our coloration experiments, measured under the conditions indicated in the previous section, are as follows: Protein concentration=0.23 mg/ml;  $L^*=37.42$ ,  $a^*=72.57$ ,  $b^*=-8.25$ .

Figure 2 (left) shows the change in CIELAB coordinates when different amounts of the B-phycoerythrin solution are added to the white yogurt. Horizontal lines in this Figure indicate  $a^*$  values corresponding to the four commercial strawberry yogurts, indicating that they have considerably different colors. It can be noted that the three CIELAB coordinates changed with B-phycoerythrin additions following asymptotic trends, which in the case of  $a^*$  closely approach to the target values of three of the four commercial strawberry yogurts. For each commercial strawberry yogurt, Figure 2 (right) shows CIELAB color differences with respect to the white yogurt with increasing amounts of B-phycoerythrin solution. Note that using 0.05 ml of our B-phycoerythrin solution it is possible to obtain a very close color to the one found in the Macedonia Clesa commercial strawberry yogurt ( $DE_{ab}^* < 5.0$ ). However, for the Clesa, Danone and Auchan strawberry yogurts, color differences below 5.0 CIELAB units can be found using 125, 175 and 200 ml, respectively, of the B-phycoerythrin solution added to the white (natural) yogurt.

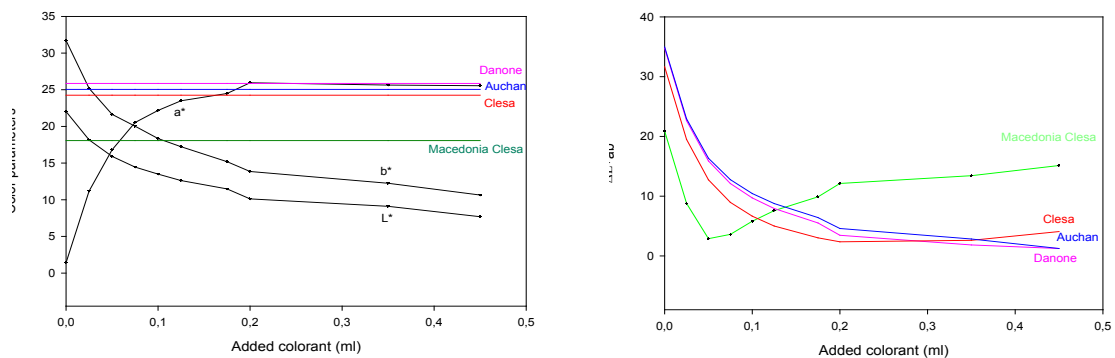

Figure 2. Left: CIELAB coordinates of the white (natural) yogurt with additions of B-phycoerythrin colorant (the horizontal bars indicate  $a^*$  values for the four commercial strawberry yogurts). Right: CIELAB color differences between each commercial strawberry yogurt and the white yogurts with additions of B-phycoerythrin colorant.

### 4. CONCLUSIONS

From *Porphyridium cruentum* microalgae, a B-phycoerythrin enriched solution was obtained in our laboratory using the expanded bed adsorption chromatography methodology developed by us. This B-phycoerythrin enriched solution was characterized and showed interesting properties as an efficient natural biocolorant. It was found a good solubility of bili-proteins in the white (natural) yogurts considered in our research, in such a way that small

amounts of our B-phycoerythrin extract solution produced strong coloration changes in the white yogurts. The specific amounts of B-phycoerythrin biocolorant to be added in order to reproduce the color of specific strawberry commercial yogurts were different. Anyway, with the B-phycoerythrin biocolorant produced here, color differences below 5.0 CIELAB units can be achieved with respect to the colors of four commercial strawberry yogurts, and for one of them the amount of B-phycoerythrin extract solution to be added was considerably small (0.05 ml). These results are encouraging with respect to the use of biliproteins from microalgae as food natural colorants.

### ACKNOWLEDGEMENTS

This research has been supported by Junta de Andalucía, Research Project P06-TEP-01362, and Ministry of Economy and Competitivity, Research Project FIS2010-19839 with European Regional Development Fund (ERDF). The Department of Chemical Engineering of University of Almería (Spain) performed microalgae cultivation allowing the extraction of the natural colorants employed in this research.

### REFERENCES

- Arad, S., and A. Yaron, 1992. Natural pigments from red microalgae for use in foods and cosmetic, *Trends Food Sci. Technol.* 3, 92-91.
- European Food Safety Authority, 2011. <http://www.efsa.europa.eu/fr/topics/foodcolours>
- Glazer, A.N., 1999. *Chemicals from Microalgae*. In: Z. Cohen (Ed.), Chapter 11, Taylor and Francis Ltd., 261-280 (UK).
- Bermejo, R., E. Ruiz and F.G. Acién, 2007. Recovery of B-phycoerythrin using EBA chromatography: scale-up of the process. *Enzyme and Microbial Technology* 40, 927-933.
- Ramos A., F.G. Acién, J.M. Fernández, C. González and R. Bermejo, 2010. Large-scale isolation and purification of C-phycoerythrin from the cyanobacteria *Anabaena marina* using EBA chromatography. *J. Chem. Technol. Biotechnol.* 85, 783-792.
- Bermejo, R., and A. Ramos, 2012. Pilot scale recovery of C-phycoerythrin from *Spirulina platensis* using expanded bed adsorption chromatography. *Chromatographia* 75, 195-204.

*Address: Prof. Ruperto Bermejo, Department of Physical and Analytical Chemistry,  
High Politechnical School of Linares, University of Jaén,  
C/ Alfonso X El Sabio, n°28, 23700 Linares, Jaén (Spain)  
E-mails: rbermejo@ujaen.es; pidilv@gmail.com;  
acien@ual.es; jfernand@ual.es; mmelgosa@ugr.es*

# Role and Functions of Colour in the Drawings of Portuguese Architects

Maria João DURÃO,<sup>1</sup> Natacha MOUTINHO<sup>2</sup>

<sup>1</sup> Faculdade de Arquitectura da Universidade Técnica de Lisboa

<sup>2</sup> Escola de Arquitectura da Universidade do Minho

## ABSTRACT

Drawings made by architects have been the object of several studies and publications, however, usually focused on themes that encompass skills, methods, conventions, or representations. This paper addresses drawings done by Portuguese architects, from a completely different standpoint: an enquiry directed to the role of colour. It is generally accepted that colour is a very significant tool and a powerful means of expression, operating at many perceptive levels that can add information and meaning to an image. However, specifically when related to drawings made during the development of an architectural project, how significant is colour in the actual ‘making of the drawing’ and what meanings are attached to it when part of a range of steps and different stages of this complex process? These were the leading research questions that initiated an ongoing investigation within a PhD program in Fine Arts – specialization in Drawing that responds to more overarching issues such as how colour triggers the imagination and thinking process. From the analysis of drawings and discussion with their authors, significant functions and uses of colour began to emerge. Some applications of colour are more straightforward and illustrative in essence than other more personal interpretations and explorations of colour. In fact, this research demonstrates how colour is used for conceptualization of the architectural project; the extent to which colour can operate as an organizational tool; how it can complement the use of only one colour such as black; or even how colour helps disentangle the drawing, as Le Corbusier put it.

## 1. INTRODUCTION

The use of drawing as a design tool has been subject of several studies but rarely focusing on the use of colour. Even when drawing’s graphic or expressive qualities are concerned, colour is diminished as the quality of an instrument and dismissed to the last phases of the design process to illustration or depictive drawings.

In this paper we aim to shift the spotlight towards colour, regarding the way it is used as a visual element with operative functions, important in decision making and also as a complex and subjective way to give meaning to a drawing. We will do so through the study of drawings made by Portuguese architects and their own thoughts and experiences in the field, collected through interviews, and interactively analysed within the scope of theories that embrace colour.

## 2. CASE STUDY PROCEDURES

As part of the adopted methodological procedure which includes case studies, drawings have been categorized according to a conceptual framework grounded in interviews with the respective author/architect. The interviews were such as to allow for the input of the experience of architects, regarding the design process and specifically how they used colour in handmade drawings. All the gathered material was subject to analysis under the premise that handmade drawing is a privileged tool within the design process that extends its action to creative thinking, materializing ideas and concepts of the author, responding to cognitive

and communicative functions. Drawing as such results from the personal abilities but also from learned skills taken together with the medium qualities and the way we perceive and think.

Colour is also regarded as a multidisciplinary phenomenon that needs to be read under the domain of several disciplines that include psychology, anthropology, neurology or art. Psychology, especially in the domain of perception, helps understand how colour affects the individual and explain how the eye and the brain perceives colour. Anthropology can explain why and how we establish meaning to colour, we relate and use it under cultural and social influence and shared knowledge. Neuroscience can explain how we make sense of the world and we can see or appreciate a drawing, even if our eyes only respond to wavelengths of light or our brain to electrical stimulus. Art has been a fertile territory where colour has been fully embraced and the most interesting challenges have been placed. Being aware of such developments can help understand the way we relate today to this complex phenomenon. Through these procedures we observed several expressive and operative functions of the use of colour in freehand drawings: colour in illustration; colour as an organizational tool or colour as an architectural theme.

### 3. COLOUR IN ILLUSTRATION

Architect Nuno Brandão Costa made this drawing (Figure 1) for “Casa de Afife” (also presented in grayscale). It is an illustration of the project, in this type of drawings no problems or conflicts are resolved, instead, the author visualizes and makes sure of his choices or solutions. It helps to visualise the project and easily communicate all this information, establishing an emphatic relation with the observer through the addition of colour and using a less abstract graphic representation. Here the author explains to some extent the chosen materials, light, transparencies, implantation among other important aspects of the project.

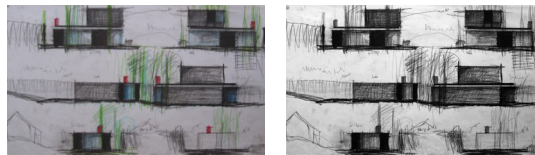

Figure 1: Nuno Brandão Costa, “Casa de Afife”, private collection.

In grayscale it is not easy to discriminate as clearly and as fast the different elements that are represented showing how colour helps to depict forms and determine the materials of the house and its surroundings. Green is used for vegetation, blue for glass, red for the chimney and black or gray for the walls. This strategy is especially effective for object recognition of vegetation helping to identify lines with no distinguishable shape as trees. In fact, several studies have shown that especially natural objects are colour-based. This use of colour explores a straightforward relationship with colour associating the normal and more direct way we relate an object with a given colour. All the colours, except one, use the optical relations between the material and respective colour, the red in the chimney is the exception, by exploring a more synaesthetic relation to colour such as temperature.

### 4. COLOUR AS THEME

From the collected data it was possible to observe that when a colour is chosen to be a theme in architecture it is used in the drawings, and from the very beginning, i.e. right from the first sketches.

For São Paulo Biennale of Architecture Portuguese Pavilion (Figure 2), its author, Archi-

tect Ricardo Bak Gordon chose the colour blue, specifically Klein blue<sup>1</sup>, seeking to incorporate in his work the strong meanings that we usually associated with this hue. Colour has a strong impact in the built environment affecting space perception, enhancing form or built elements, transforming the image or the experience of an architectural space. Once settled that blue was the colour to be used in this project it seems only logical to use that same colour when drawing. Using this colour helps to acknowledge the effects or qualities that it has on the author's perception or on his collaborators.

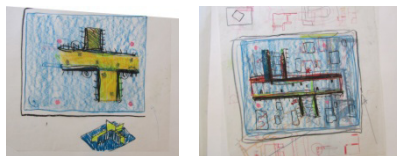

Figure 2: Ricardo Bak Gordon, Portugal Pavilion, private collection.

In this drawing colour also has an illustrative function even when form are not definite and still being worked in sketches. Still colour is an important illustrative function that enables an emphatic relation between the observer and the subject, engaging the gaze and offering a seductive experience that can preview some sensations common to those when inhabiting the built space.

## 5. COLOUR AS TOOL

When the use of colour in the drawing does not correspond to the colour used in the built space it can assume different roles, as in the work of the architect Egas José Vieira. In this drawing (Figure 3) also reproduced in grayscale, colour relations or contrasts are used as an organizational tool. Red and green are a special pair of complementary colours that create dynamic relations. Through colour the author organized hierarchically the architectural elements and this helps to read the drawing in an organized way, accordingly.

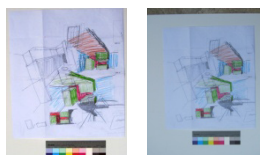

Figure 3: Egas José Vieira, private collection.

Contrast between colours is of a double nature: contrast of tone (chroma) and of value. The tone contrast is used to classify different materials used and the value contrast-between light or dark green- establishes directions, e.g. front or side planes: “*There is only gradation when there is the same material in diferent planes*”<sup>2</sup>. Colour is used to organize different materials and also different directions of the volume surfaces. Colours are the same in these representations, changing only in size or shape, helping to understand what we see and to relate it with other images. So colour can work also as a code to relate different views or projective systems used.

1 International Klein Blue was developed by the French Artist Yves Klein with collaboration of the French pharmaceutical company Rhône Poulenc. In 1960 this colour was patented not to guarantee any commercial outcome but to validate the metaphysical idea that this colour represents and to make it impossible for others to corrupt the authenticity of his creation.

2 From the original: “Só existe gradação quando existe o mesmo material com planos diferentes”, extract from the interview with Architect Egas José Vieira (18th July 2011).

The same colour can be read as a complete form even when several colours are used and superimposed, so even when the drawing is very complex and full with information we can still make sense of all of it. This visual organization through colour corresponds to a visual disposition of the elements that may clarify the interpretation of the drawing and manage the communication of a great deal of information.

## 6. CONCLUSIONS

Colour can respond to the organization of information or it can add new levels of information to the drawing without loss of integrity or understanding of what is presented. These drawing strategies are possible because of the intrinsic qualities of colour and for the way we see and interpret the information received by our senses. Colour is especially complex because of its synaesthetic dimension, and extends associations to different contexts and meanings that can unleash our memories, individually and culturally built.

Even if colour has not been observed when studying drawing in the design process it seems relevant as a complement or alternative to different graphic or expressive solutions. As we have seen it can be used in different functions, operative or communicative, particular to an author or as common ground. This diversity reveals a need to look closer to more drawings and authors, seeking for a platform of similarities or particularities.

Colour is a complex phenomenon and as such it amplifies the possibilities of its use in the design process. It proves fundamental to understand the role it plays so we can explore new applications for this visual, symbolic or expressive resource not only in architectural drawings but also in other creative activities.

## ACKNOWLEDGEMENTS

We would like to thank all the architects that helped in the part of the research addressed in in this paper, especially to Ricardo Bak Gordon, Egas José Vieira and Nuno Brandão Costa.

## REFERENCES

- BALL, P., 2008. *Bright Earth: The invention of colour*. Londres: Vintage. ISBN: 9780099507130
- DURÃO, M.J., 2002. *Colour in the Built Environment. FABRIKART-Arte, Tecnología, Industria, Sociedad*. nº2, Ed. Universidad del País Vasco-Euskal Herriko Unibertsitatea.
- HERBERT, D.M., 1993. *Architectural Study Drawings*. Nova Iorque: Van Nostrand Reinhold.
- HERBERT, D.M., 1988. Study Drawings in Architectural Design: Their Properties as a Graphic Medium. *Journal of Architectural Education* (1984-), 41(2), 26-38.
- TANAKA, J.W., and L.M. PRESNELL, 1999. Color diagnosticity in object recognition. *Percept. Psychophys.* 61, 1140-1153.

*Address: Prof. Maria João Durão, Colour Lab-Faculdade de Arquitectura da Universidade  
Técnica de Lisboa, Rua S. Nogueira,  
Alto da Ajuda, 1349-055 Lisboa, Portugal  
Natacha Antão Moutinho, Escola de Arquitectura da Universidade do Minho,  
Campus de Azurém, Guimarães, Portugal  
E-mails: mariajoaodurao@gmail.com; mjdurao@fa.utl.pt , natacha@arquitectura.uminho.pt*

# The Project for the Silesian Park

Anna KMITA  
Academy of Fine Arts Katowice, Poland  
The Design Department, Color design studio

## ABSTRACT

“The project for the Silesian Park” is a creation of the strategic image, color, corporate identity and wayfinding system for one of the largest downtown-city parks in Europe (640 hectares).

One of the main aspects of the project was to develop a comprehensive color schemes for the Park and all entities subordinate to it. The color project was based on the colors of nature, inspired by the colors of the four seasons, preceded by studies and photographs of nature and architecture of the Park. The research was conducted on the semantics of colors of the seasons, in accordance with the place and the Silesian region characteristic.

The project was developed as a color manual, a set of promotional posters and a set of instructions for the staff making promotional graphic elements for the Park. The implementation of the system of identification, color and visual information was accompanied by training courses in color design, typography, and conscious, ecological and sustainable management of the visual side of the Silesian identity Park.

## 1. INTRODUCTION

“The project for the Silesian Park” is a creation of the strategic image, color, corporate identity and wayfinding system for one of the largest downtown-city parks in Europe (640 hectares). The Silesian Park is visited by three million people every year, who can enjoy the natural beauty of the Park as well as many attractions such as the astronomical observatory, amusement park, zoo, museum, restaurants, swimming pools, cable car and botanical garden. Main assumptions of the project were:-

1. **Stressing the form of the Park as a whole.** Uniform identification of activities of the trade mark – the Silesian Park and defining the interrelation as well as marking sub trademarks – “we are one body and we act together”.
2. **Observance of tradition and history of the Park.** You feel at home in this Park.
3. **The Park as a common good – open to the public.** We take care of you and your needs.
4. **The most important are nature, relaxation and leisure.** We respect the nature, take care of it and cultivate it for the future generations.

## 2. METHOD

The method was based on analysis of the existing space of the Park- a report entitled “The analysis of the state of existing labeling and analysis of space of the Silesian Park for the needs of a new System of Visual Information” was prepared. Next, the design team consisting of designers, product designers and consultancy team was created.

The design team composed of designers, marketing managers and sociologists, decided to develop strategic image of the Park in accordance with sustainable development idea on every level of realization of the task:

- there was created one common image for the Park and several entities located in its territory,
- there was developed a coherent program to manage the elements of promotion (for the media, the quality and quantity of printed materials - for example, one poster informing about all the events, instead of 50 leaflets),
- there were selected organic materials from recycled sources (paper, fabric, gadgets from renewable materials) that reflect the idea of the Park being a place close to nature, protecting nature, taking care of the surrounding environment of its users,
- information system was made of durable materials, not subjected to rapid destruction and not containing plastics,
- existing heritage of the Park was preserved (existing landscaping elements, commemorative plaques, and characteristic logos),
- there was a reduction of the amount of information printed in favor of implementation of all the data available online (QR bars, applications for mobile devices, maps, thematic lanes).

During the implementation of the project users of the Park were directly interviewed, according to a principle “a user is an expert” and next, the information gathered in the project process was verified.

### 3. PROJECTS RESULTS

One of the main aspects of the project was to develop a comprehensive color schemes for the Park and all entities subordinate to it. The color project was based on the colors of nature, inspired by the colors of the four seasons, preceded by studies and photographs of nature and architecture of the Park. The research was conducted on the semantics of colors of the seasons, in accordance with the place and Silesian region characteristic.

As a result of the research, there was designed the set of 4 ´ 20 colors pallets for promotion of each season at the Park. These colors, in combination with the main color of identity, make the identification of the institution, its activities and events organized by it.

Each set of colors contains colors divided into groups: background colors, graphics, typography and photography. Graphic elements involved in the character of the promotional materials include vector graphics of stripes which can have different patterns inspired by the strip form of the trade mark of the Silesian Park. The most characteristic plant elements were chosen from the park surroundings such as rose (from the biggest rosary in Europe), crocus, rowanberry, water lily and others and next, they were converted into the graphic elements.

12 color sets were designed for each season and in that way each poster of an event organized in the Park in a given season of the year has its own set of colors (3 months, each with 4 weekends) consistent with the general color of the seasons. The colors of the project allow the designers to use the designed color palette for many years (there are a lot of combinations of colors), without the need to change the image every season which makes it more universal and timeless.

The parameters of colors were established in NCS, the CMYK color model and the RGB color model. The main color of identification (green) was additionally defined in RAL Classic system considering the possibility of appliquéing it into carriers with varnish, powder or other coating.





Figure 1: Preparation of the color for a chosen season in the Silesian Park.

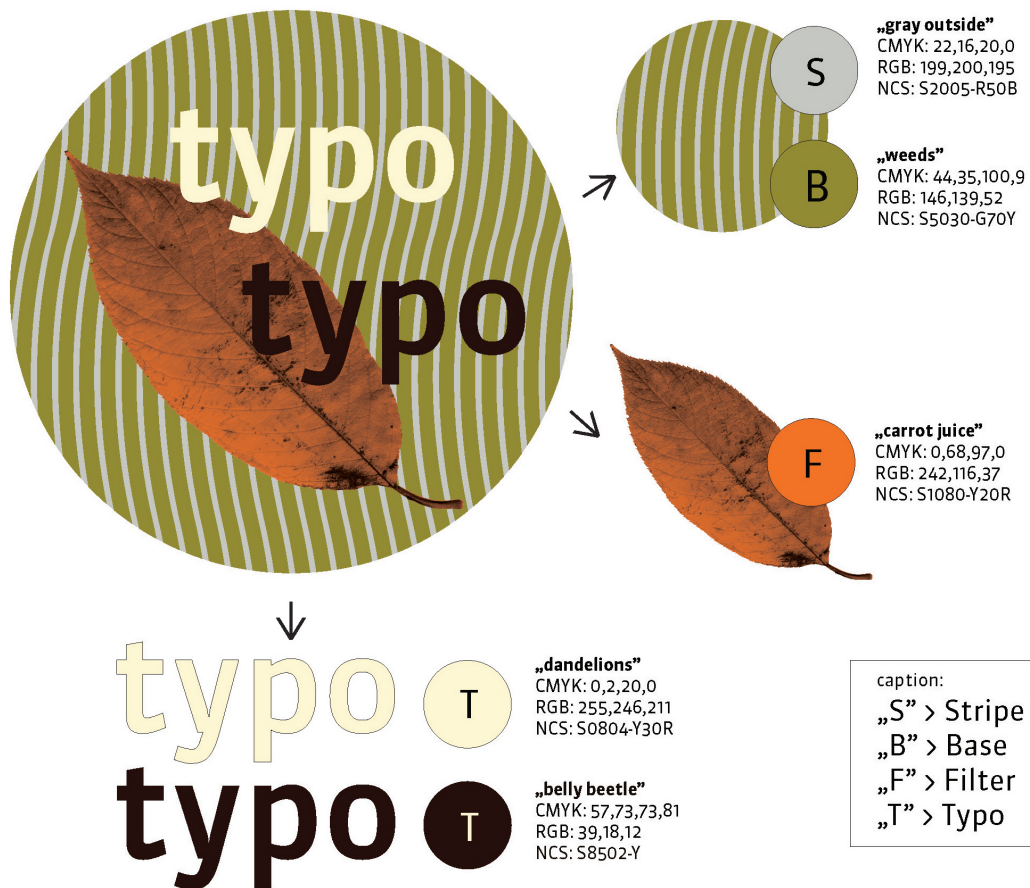

Figure 2: An example of instruction of creating a set of colors for the promotional materials in the Silesian Park.

The project was developed as a color manual, a set of promotional posters and a set of instructions for the staff making promotional graphic elements for the Park.

The designed system of information (maps, schemes, markings of the entrance to the Park and the attractions located in the Park) was also prepared in accordance with the chosen color. All information elements are in the color of green and grey (park color + neutral applied color). Each entrance to the Park is marked with two flags, one, with the name of the park and the name of the entrance and the other, with color of the season.



Figure 3: An example of implementation.

#### 4. CONCLUSIONS

The project included analysis, plan of graphic elements and data carrier of maps and schemes in the Park, training courses, supervision of the implementation as well as comprehensive consultancy. The implementation of the system of identification, color and visual information was accompanied by training courses in color design, typography, and conscious, ecological and sustainable management of the visual side of the Silesian identity Park. The project is still being implemented. It has been implemented since 2011 and it is planned to be completed in 2014.

The authors of graphic design and the concept of image: Anna Kmita, Ph.D. (submitted a proposal of this presentation), Justyna Kucharczyk, Ph.D., Andrew Sobaś, Ph.D., Jadwiga Rataj, M.A., Agnieszka Nawrocka, M.A. (staff from Academy of Fine Arts in Katowice / design department). The team's marketing strategy - Business Consulting Katowice. The team of sociologists – Paulina Rojek - Adamek, Ph.D., Grzegorz Gawron, Ph.D. Panel on implementation of the project – The Silesian Park staff led by Łukasz Buszman.

Sources (figures and photos) are part of project's manual - compiled by the author.

*Address: Anna Kmita, Ph.D., Ul. Raciborska, 37 Katowice, Poland  
E-mails: [annakmita@gmail.com](mailto:annakmita@gmail.com), [a.kmita@asp.katowice.pl](mailto:a.kmita@asp.katowice.pl)*

# Perceptions and Emotions of Urban Coloured Lighting Atmospheres

Daria CASCIANI, Maurizio ROSSI  
Politecnico di Milano, Design Department, Laboratorio Luce

## ABSTRACT

The development of LEDs based lighting technology has brought a wider range of possibilities in terms of coloured lighting in the design practice. An example of this is the increased and slightly disordered use of coloured lighting in the outdoor environment that is transforming, both positively and negatively, the nocturnal image of cities. The aim of this research was to test the perception of users towards different coloured lighting atmospheres using a double image-based questionnaire. Results identify three contrasted perceived atmospheres: warm lighting for safety, comfort and orientation; coloured lighting for positive, interesting and pleasurable experiences; lighting from shopping windows experienced both safe and positively impacting the image of the city. Understanding the role of coloured urban lighting toward people is an important challenge for an extensive user oriented approach in the lighting design practice.

## 1. INTRODUCTION

The recent development of new lighting systems based on LEDs technology has brought to the lighting practice a wider range of possibilities in terms of coloured lighting design. Observing the city, it is evident that this is slightly disorderly transforming the night-time image of the cities: if on one hand, coloured lighting is used as the key element of lighting design to accent urban elements or determining the urban atmosphere at night enriching people visual experience, increasing the social accessibility with a deeper urban safety perception and marketing its image (Van Santen, 2006), on the other hand, coloured lighting is also an uncontrolled phenomena with certain negative impacts. Coloured lighting can be associated to negative perception, can create disturbance of the historical and civic identity of the city (Gardner, 2006) and sometimes could result in poor vision and disorientation in travelling the city at night (Stylianou, 2010). Moreover, in the Western culture, in some cases, colours and coloured lighting are also conceived as trivial and related to the realm of the superficial, the supplementary, the inessential (Batchelor, 2000). Conversely, the meaningful use of coloured lighting contributes positively to the urban environment experience (Schanda, 2000). Understanding coloured lighting role toward people is an important challenge for its better use with a social aim in the lighting design practice. This paper is about people evaluation and perception of coloured lighting in the urban environment: what impacts does coloured lighting have on people?

Hypothesis 1: Coloured lighting has a significative effect on people's perception and appreciation of urban atmosphere, both in a negative and positive way.

Hypothesis 2: Variables such as hue, brightness and distribution of light modify and signify the effect on users perception of the urban atmosphere.



A, warm white uniform dynamic lighting, is perceived safer than atmosphere C and more comfortable than atmosphere D. Conversely, despite it is conceived as the least interesting compared to B and D, it is also perceived that white lighting is better and more positive for the city nighttime image than blue lighting (C). Atmosphere B, warm white static and distributed lighting is perceived better in terms of colours, pleasantness, interest and positive image than blue lighting (C). Atmosphere C, is negatively perceived in terms of safety and comfort, pleasantness and positive characterization: the presence of full saturated lighting with lower brightness and without any other contribution could be the reason why the atmosphere is perceived in a negative way. Atmosphere D, cyan distributed dynamic lighting, is perceived as the best in terms of colour of lighting, positive characterization, pleasantness and interesting experience in comparison with all the other atmospheres. In this, the presence of a double source of lighting coming from windows seems to have a positive contribution. Cyan is also warmer and brighter than deep blue (C).

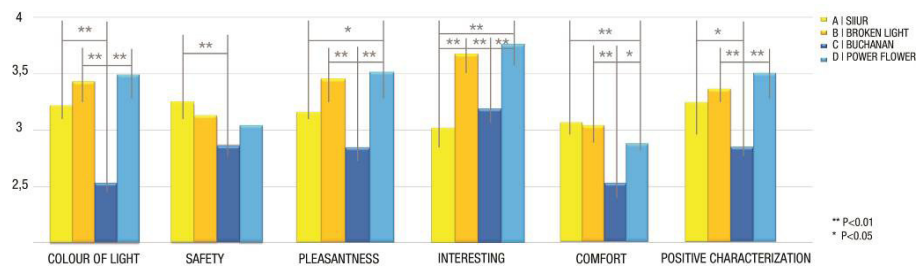

Figure 3: Statistical results for different perceptible variables in 4 luminous atmospheres.

## 2.2 Second Experiment

The second experiment took place with an image-based projection test with 90 participants (74% male – 26% female; ave. age 21 years old; 100% undergraduate student) in order to confute or confirm the results of the previous one. The atmosphere C was tested (Figure 4) varying lighting variables: C1 and C2 without and with white lighting from whopping windows, C3 with full monochromatic magenta lighting, C4 with full monochromatic green lighting. 3 questions about preference, safety and comfort perception were asked and Statistical analyses (Chi<sup>2</sup> tests) were performed.

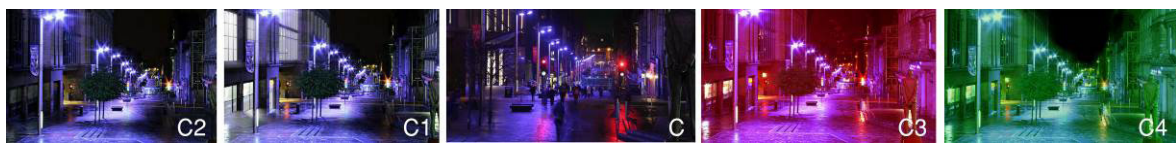

Figure 4: Lighting stimuli and different lighting variations of atmosphere.

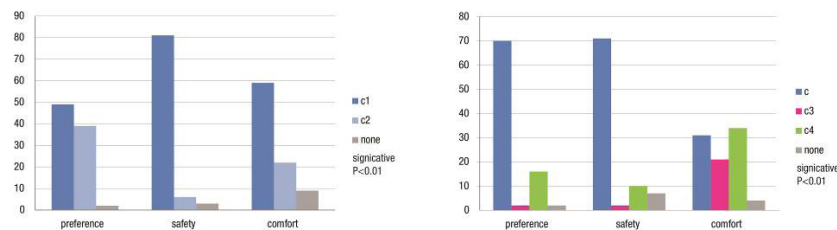

Figure 5: Statistical analysis between different lighting variation with people perception.

Results show a significant statistical relation between atmospheric descriptors and lighting variables: there is a relation between the lighting variables and high perception of safety and comfort (C1-C2). This is due to the fact that the contribution of white lighting from shopping windows define a brighter atmosphere that is experienced more lively. On the other

side, the general preference for the luminous atmosphere was split between C1(55%) and C2(44%) showing that it is not directly correlated with the perception of safety and comfort (Figure 5). When comparing full saturated images with different hues, the general preference goes toward the blue lighting and this is correlated to the perception of safety but not with the perception of comfort that is split between C(34%) and C4(37%) (Figure 5). The reason could be that green is perceived brighter.

### 3. RESULTS AND DISCUSSION

The results of the experiments show that coloured lighting is not always preferred over warm white lighting: a sort of chromophobia occurs when the colour of lighting is really saturated, is involving the whole visible urban area and it doesn't show clear functions or meanings. Conversely, "chromophilia" (Batchelor, 2000) occurs when coloured lighting is dynamic, contributing to the positive characterization of the nighttime image of the city and for better, more positive and interesting experiences of the urban environment.

### 4. CONCLUSIONS AND NEXT STEPS

In conclusion, we have identified three contrasted atmospheres based on meaningful colour of lighting, each one related to specific atmospheric feedback: warm lighting related to safety, comfort and orientation; coloured lighting related to interesting, pleasurable experiences; lighting from shopping windows related to safety, comfort but also liveliness and positive. Our results shows that people prefer white lighting or a mixing technique of white and coloured lighting over monochromatic highly saturated lighting. If they are asked to choose between full monochromatic atmosphere they are more likely to choose the blue hues (Van Santen, 2006), with a preference for warmer ones. Due to the limitation of the image-based tests, further experiments are in progress to observe the effects of coloured and distributed lighting in real setting deeping its relationship with urban materials.

### REFERENCES

- Batchelor, D., 2000. *Chromophobia*, Published by Reaktion Book Ltd. Singapore, ISBN 1 86189 074 5
- Gardner, C., 2006. The use and misuse of coloured light in the urban environment, *Optics & Laser Technology*, 38(4-6), pp 366-376
- Schanda, J., 2001. City beautification by coloured lights – an art or kitsch. *Istanbul Lighting Conf.*
- Stylianou, A., 2010. *Introducing Chromatic Light Pollution*, retrieved 28/04/2013  
<http://issuu.com/stylianou.axiotakis/docs/clp?mode=embed&layout=http://skin.issuu.com/v/light/layout.xml&showFlipBtn=true>
- Van Santen, C., 2006. *Light Zone City: Light Planning in the Urban Context*, Birkhäuser Publishers for Architecture

*Address: Daria Casciani (PhD student), Prof. Maurizio Rossi,  
 Design Department, Politecnico di Milano, Laboratorio Luce,  
 Via Durando 10, 20158 Milano  
 E-mails: daria.casciani@polimi.it, maurizio.rossi@polimi.it*

# Colour, Time, Architecture and Urban Environment

João Carlos de Oliveira CESAR  
Faculdade de Arquitetura e Urbanismo da Universidade de São Paulo

## ABSTRACT

The objective of this work is to make a connection between the way colour changes over time and the changes in the perception of architecture and the urban space.

The passage of time leaves its imprint on architecture by changing the chromatic characteristics of surfaces and volumes of the urban space. The processes of inserting new buildings and the maintenance (or not) of the existing ones provide the city with some dynamics that can alter not only the way its inhabitants perceive it, but also the sense of the passage of time itself.

The white and voluptuous curves of Oscar Niemeyer's works in downtown São Paulo quickly interact with pollution, therefore demanding constant maintenance. What once stood out, over time becomes camouflaged, hidden by the same grime that covers the dingy and dirty buildings of the region.

Likewise, the vegetation changes rapidly, generating new chromatic relations in the city. In some urban landscape interventions, such as the ones by Roberto Burle Marx, colours change and renew themselves as if they were anticipated in the design.

The intended chromatic insertions in architectural and urban designs may go astray over time or acquire new characteristics, anticipated or not.

“What, then, is time? If no one asks me, I know (what time is). However, if I wish to explain it to someone who asks me, I do not know.” (XI.14.17) (Augustine, in Matthews 2005).

## 1. COLOUR, TIME, ARCHITECTURE AND URBAN ENVIRONMENT

Just like a piece of music, with its own rhythm, harmony, and melody, the insertion of architecture in the city generates a quasi-synesthetic relationship (colour and music) that changes over time, flowing and mingling. What very often begins at a fast tempo, sometimes harmonious, sometimes not, may gradually fade, approaching drabness, as if the surroundings “absorbed” the building, incorporating it into a uniform urban landscape.

Minah points out three roles that colours play in architecture: colour dynamics, colour imagery and colour tectonics. Colour dynamics describe the visual hierarchies that use figure and background in diagrams, also influencing the relationships or interactions based on contextual juxtaposition, colour tectonics refers to the potential colour has to define and clarify the three-dimensional shape, and colour imagery deals with colours in the perceptual architectural experiences that convey materiality, physical context, cultural context, symbolism and the emotional response, as well as the conceptual objectives and formal relationships (Minah, 2006).

Dynamics is characterized in the city by a perceptive “rhythm” which changes as its original characteristics are lost over time.

This process is directly related not only to weather conditions, intensity of solar radiation,

and pollution, but also to the quality of the materials employed and the process of maintenance and preservation of buildings.

The choice of materials in some architectural designs ends up being the main determinant of chromatic options and, consequently, of their relationship with the surroundings and time itself. There is still the possibility of defining materials according to chromatic options previously selected.

Seeking the eternal, increasingly resistant materials have been employed, such as granite, glass and, more recently, metal plates of titanium or aluminum composite, which offer greater resistance to the effects of the sun, atmosphere, and pollution. On the other hand, as a rule, these materials offer few chromatic options. The pace is set not so much by the wear of materials but especially by the movement of light interacting with the volume, whether the one of the building itself or of its relationship with the surroundings.

The relationship with the surroundings may be either in the sense that the work is absorbed and visually incorporated or it is involved by a rhythm of constant chromatic changes, especially characteristic of commercial or lower-middle-class residential areas; that is, a pace that goes from a constant and almost stagnant one to one that is dynamic and not very predictable.

The lack of resources has led over centuries to the preponderance, especially in countries that get a great deal of sunlight, such as Brazil, of an architecture predominantly white, as a result of the use of lime which, due to the facility of acquisition and application, enables easy and constant maintenance. This architecture stands out, emphasizing the presence of mankind, because of its usual proximity to a chromatically diverse natural landscape.

In today's large Brazilian cities, lime is not as present, and popular architecture uses low-cost materials for the most part, often with chromatic options of high saturation, which afford fairly simple and constant maintenance. This process sometimes begets a fast tempo in the landscape, since colors change rapidly, either due to wear or to constant replacement.

Under these conditions, methodologies of urban chromatic analyses that take into account not only hues, but also place special emphasis on contrasts of saturation and brightness can sometimes be more effective as a means of understanding and intervention in cities.

Nevertheless, most ubiquitous are buildings made of uncoated ceramic bricks which, in spite of their precarious conditions, keep a chromatic regularity, with a reddish characteristic that does not undergo maintenance processes. These constructions contrast with the intensely chromatic laundry being line-dried in frequent fluttering motion. Time plays its part in the speedy multiplication of these buildings and in the slow improvement of finishes, which eventually alter the colour and rhythm of the landscape.

Oscar Niemeyer's architecture, as well as that by some architects of the 20th century, features the predominance of white paint which wears off fast in a transformation process of its relationship with the surroundings. The volumes that at first are conspicuous due to the chromatic brightness created, gradually and mimetically fade, getting their prominence back only after being repainted. This transition at times resembles the passage of time itself which is marked by the chromatic characteristics of the different seasons.

This process can be observed at the Latin America Memorial in São Paulo, designed by Niemeyer. The surroundings of the architectural complex is composed of warehouses and railroads that display a dingy and grimy aspect, thus, by contrast, the works stand out, but only for a long as their white colour is maintained.



The buildings of the so-called Classical Period for centuries employed materials that gave them prolonged chromatic stability and, at the same time, some of them had in their vicinity a landscape that reflected the same intention. The strict control of both the design, which changed very little as time passed by, and the vegetation chosen, which presented little variation in colours, suggested a quest for power by mankind over nature and time itself.

In contrast to that, Roberto Burle Marx's landscape interventions aim at absorbing the natural changes in the elements that make up the design, either in colour or in shape, to some extent incorporating the passage of time into it as a constituent element.

Resembling nature, architectural works can be regarded as ever-changing living organisms and such changes, perceptible through the chromatic variations, may or may not be incorporated in the architectural ideals they represent.

The building, from a platonic perspective, according to Mitrovic, can be understood as the representation of an architectural idea or reflections, in a virtual world, of the real one.

If the dynamic relationships of architecture with the surroundings change, the same happens to imagery and tectonics, as defined by Minah.

The use of different materials in the same building, aiming to accentuate formal aspects may, depending on their characteristics, lead to different reactions in time. These changes create new perceptual possibilities that are not always in sync with the initial objectives.

The Roman Pantheon, according to Jordan, is a building originally dedicated to the seven planetary deities. It had a dome overlaid with golden plates to represent the Sun, as well as external walls covered with marble. If on the one hand the objective of constructing durable buildings has remained the same until today, on the other hand the symbolic purpose evanesces as original materials become worn out and are replaced by different ones over the years.

There is a certain fascination that some buildings create with new chromatic configurations which indicate the passage of time, as if claiming a victory, though partial, of the human works.

Works inlaid with copper, in a short span of time, tend to acquire a dark greenish tint which is not there at first. The same happens to some steel structures that oxidize, as the material seeks protection against environmental conditions, and end up adopting a rather different colour from the one that was present at the time of installation. In this case, the chromatic changes are anticipated in the design because these reactions are widely known and thus expected.

It is worth noting the position of the historical preservation organizations in Brazil, which create new symbolic relations by changing colors during restoration processes. The original colors are usually ignored and replaced by others so as to give the building a more striking appearance, either with the purpose of making it more attractive to tourists or due to political reasons. This position entails the need for frequent maintenance work.

## 2. CONCLUSIONS

Buildings, and therefore the urban space to which they belong, reflect the relationship between time and humans, who at times try to conquer it and at other times seek an alliance with it. Colour is one of the elements for the understanding of how this relationship develops. Cities that respect their history try to maintain a chromatic steadiness as if trying to reach eternity. Other urban concentrations reflect conflict, a quest for identity, at a fast and some-

times chaotic pace of chromatic changes while some others simply surrender to time, either by absorbing its designs or capitulating, sometimes to the point of extinction.

#### REFERENCES

- Minah, G., 2006. Color as Idea: using color as the conceptual basis for architectural and urban design. *Mysty Hills: AIC Interim Meeting, Proceedings*, 66-69.
- Mitrovic, B., 2011. *Philosophy for Architects*. Princenton Architectural Press, New York, Kindle Edition loc.610.
- Matthews, G.B., 2005. *Santo Agostinho (Augustine)*. Jorge Zahar Editor Rio de Janeiro, 128.

*Address: Prof. João Carlos de Oliveira Cesar,  
Departamento de Tecnologia da Arquitetura, Faculdade de Arquitetura e Urbanismo,  
Universidade de São Paulo, Rua do Lago 876, 05508-080 São Paulo SP Brazil  
E-mail: jcocesar@usp.br*

# Recovering Color in the Historic Urban Landscape Rua da Junqueira in Lisbon

Ana TORRES,<sup>1</sup> Jorge LLOPIS,<sup>1</sup> Juan SERRA,<sup>1</sup>  
Ángela GARCÍA,<sup>1</sup> M<sup>a</sup> Isabel BRAZ DE OLIVEIRA<sup>2</sup>  
<sup>1</sup> School of Architecture, Polytechnic University of Valencia (Spain)  
<sup>2</sup> Lusíada University of Lisbon (Portugal)

## ABSTRACT

In this paper we discuss on some studies and recovery actions on architectures made in European historic centres, showing the techniques and research methodologies performed. The solutions and strategies used in colour plans were operated by various interdisciplinary work groups. As an example, we gather the works carried out by the Group of Colour in Architecture at the Polytechnic University of Valencia (Institute of Heritage Restoration) during over twenty years with some of the interventions in historic centres of great heritage value in Eastern Spain, this allows knowing some similarities with related methodologies. The scientific methods and technologies used during the colour recovery process makes clear the participation of interdisciplinary teams sensitive to expectations of recovery, management and appraisal of colour topics and to possibilities for intervention in the urban landscape. Architectures are the cultural landmark of a city and an example of its built value.

## 1. INTRODUCTION

In official organizations of European cities, sensitive to architectural interventions and new constructions in historic districts, they have discussed in the last 50 years the issues relating to recovering historic urban landscape. Among other aspects, topics such as the recovery of colour in architectural heritage of cities whose historic centres have cultural values of interest are studied. The possibility to act and preserve the materials and colour as a configuring element of buildings are fundamental nuances that define the urban landscape and its effective conservation must be taken into consideration in restoration projects. Likewise, instrumental and scientific methods are established to help in protecting buildings, favouring the specific character and cultural identity to each place and territory.

To stand up for the protection of natural and cultural heritage, is a consensus objective in recent sessions conducted by UNESCO, ICCROM and ICOMOS which include recommendations on the study of the material nature and the preservation of colour in architecture. The UNESCO General Conference held in Paris in 2011 specifies the following recommendation on training, research, information and communication for historic urban landscape projects.

## 2. COLOR AND HISTORIC CITY. ANALYSIS METHODOLOGY

The whole of the work developed by the Color Research Team of the Heritage Restoration Institute at the Polytechnic University of Valencia is placed along this line of work aimed at preserving the image of the historic centers through the study, analysis and development of proposals of color intervention in historic architecture. During the last twenty years there have been many papers and studies about urban centers in which it has been proposed and implemented an analysis methodology that aims to ensure the determination of the original

color characteristics of urban space and the valuation of correct structural methodologies which guarantee the preservation of historical color understood how patrimonial value.

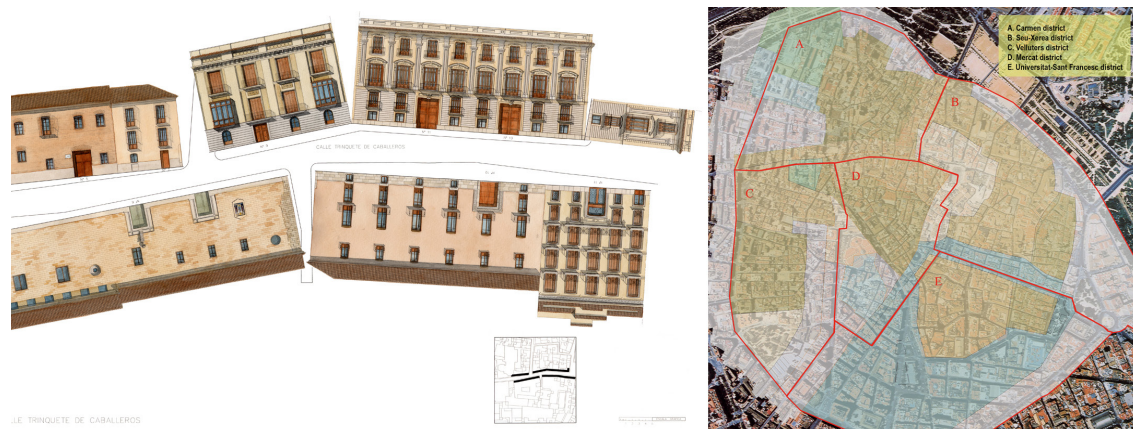

Figure 1: Chromatic stratification of Valencia and chromatic proposal of a specific area.

The whole of the developed work<sup>1</sup> has shown a direct relationship between the historical color and the original architectural typology, which eventually leads to the existence of an intimate connection between architectural form and color (Figure1). Since this relationship it would be room for determine the existence of an urban zoning directly related to architectural characteristics of buildings, just like the existence of several chromatic areas in the historic city relative to the time of construction, architectural characteristics of buildings and the social class which used them. Preserving this chromatic structure is preserving the city history itself, so that the development of color planes transcends the simple strategy of formal preservation to become a strategy of preservation of the cultural, social and anthropological characteristics that the city carries (Garcia et al.; 2009).

### 3. RUA DA JUNQUEIRA IN LISBON

An example of application of this analysis method, its objectives and its potential to develop strategies of intervention in the field of urban heritage is the project funded by *Fundação para a Ciência e Tecnologia* of the *Ministario da Ciência e Ensino Superior* of Portugal, developed by an international team constituted by researchers from the Polytechnic University of Valencia and the Lusíada Univesity of Lisbon to make the study and development of a chromatic intervention project in Rua da Junqueira in Lisbon<sup>2</sup>. It is a road axis fully representative of the architecture from the Portuguese capital, where buildings belonging to diverse typology coexist, so that the application of the analysis methodology developed by the EIC-UPV team, adapted to the specific characteristics of Lisbon, aims to become a representative model that allows a subsequent normative generalization for the whole of the historical center of the capital.

1 The whole of the work developed since the application of this analysis methodology is very large. In Spain they have developed the esencial studies of Valencia, Cartagena, Ontinyent and Burriana, just like other studies of numerous protected areas and catalogued buildings. Additionally they have developed the studies of *Plaza Vieja* in Havana and *Rua da Junqueira* in Lisbon.

2 *Metodologia para a elaboração de um plano de cor em ambiente urbano* (PTDC/AU-RÁQI/108794/2008).

## 2.1 Analysis Methodology

The analysis and determination of the original chromatic colors has been carried out using a combination of technical analysis and study of the city council archives. This historical information has been added to by the use of two techniques of color measuring. In the first phase, the color of paint superficial coats was studied *in-situ* and ‘chromatic’ maps were made since instrument readings. The instruments used were: an adapted contact color meter (measuring mode: absolute and differential) and a spectrophotometer (Color systems: XYZ, Yxy, L\*a\*b\*, L\*C\*h°, from CIE; Hunter Lab and Munsell. Absolute values and increments. Total color difference). In a second phase, the study has been broadened with laboratory chemical analysis to determine the exact composition of the original materials – construction materials and mortars, as well as the pigments used in the pastes and the resulting colors. This process of analysis and classification of the samples leads to a third phase of the study. The pigmentation samples were prepared for an optical photographic study with a binocular magnifier for a physical/chemical analysis and determination of components. The analytical instruments and techniques used were: Scanning Electron Microscope (for the morphological study of the samples) and X-Ray Diffraction, or Scanning Electron Microscope/Energy Dispersive Using X-Ray (SEM/EDX) for the mineralogical analysis of samples.



Figure 2: Card of chromatic analysis of a building in Rua da Junqueira in Lisbon.

## 2.2 Project Results

The application of this methodology is formalized in a set of intervention guidelines which are organised depending on the diverse architectural typologies that configure Rua da Junqueira. Since analysis and intervention cards (Figure 2) it is possible to guarantee the connection of color process assigned to each building individually, and through it, to guarantee the preservation of formal, material and structural logic of historic buildings, ensuring their integrity through a series of directives which come from public organizations in order to preserve the spatial image of the city.

The proposed intervention should be understood as a “pilot intervention” prior to extending it to the whole historic center. It aims to extrapolate the interventions developed in the Spanish litoral to other cultural and social areas, passing the material-structural limits of previous

interventions and including new native structural techniques like the tiling in the Portuguese case, which can be treated with similar parameters to those developed for continuous coatings, typical of the Mediterranean area.

#### 4. CONCLUSIONS

Colour is a key variable in the process of urban rehabilitation of historic cities. The respect for the original color is more than a matter of preservation of the architectural integrity a matter of preservation of the spatial, cultural and social values that the city carries. Ignoring the connection between color and architectural form, we fall into a process of destroying the own spatial coherence of the city, emerging the risk of dissociating color and architectural form in each specific building and destroying the coherent spatiality of the different city areas which are a product of the layers that their own historical development has determined.

#### REFERENCES

- Garcia, A., J. Llopis, A. Torres, R. Villaplana and J. Serra, 2009. Color as a structural variable of historical urban form, *Color Research & Application*. 34 (3) 253-265.
- Garcia, A., J. Llopis, A. Torres and R. Villaplana, 2012. *El color de Valencia: El centro histórico*. Generalitat Valenciana.
- García, A., J. Llopis, A. Torres, R. Villaplana, J. Serra and P. Cabezos, 2010. *La arquitectura tradicional de Ontinyent*. El color histórico. Ajuntament de Ontinyent.
- Morlacchi, M., 2003. *Colore e architettura: il linguaggio del colore nel disegno delle superfici architettoniche*, Gangemi. Roma.
- Raimondo, C., 1997. *I piani del colore. Manuale per la Regolamentazione cromatica ambientale*. Maggioli Editore, Rimini.
- VV.AA., 2012. *2º Seminario Internacional da Cor*. Universidade Lusíada Editora. Lisboa.

*Address: Prof. Ana Torres, Department of Architectural Graphic Expression,  
School of Architecture, Polytechnic University of Valencia,  
Camino de vera s/n. 46019 - Valencia (Spain)  
E-mails: atorresb@ega.upv.es, jllopis@ega.upv.es,  
juaser11@ega.upv.es, angarcia@ega.upv.es*

# Kansei Engineering: a Tool for Evaluating Chromatic Integration of Architecture in Landscape

Susana IÑARRA,<sup>1</sup> Carmen LLINARES,<sup>1</sup> Juan SERRA,<sup>2</sup> Ana TORRES<sup>2</sup>

<sup>1</sup> Lab Human Institute, Universitat Politècnica de València (Spain)

<sup>2</sup> Color Research Group, Escuela Técnica Superior de Arquitectura, Universitat Politècnica de València (Spain)

## ABSTRACT

Kansei Engineering was developed by Professor Nagamachi at the Kure Institute of Technology (Hiroshima, Japan). This methodology aims to relate product design with the sensations it awakens in users. Study of observers' emotional responses to variations in product attributes enables this information to be included in the design process in order to create products that satisfy users' needs. This communication aims to analyse the application of Kansei methodology as a tool for evaluating the chromatic integration of architecture in landscape. Given that chromatic integration of architecture with its surroundings is aimed at improving the sensations perceived by observers, the sensations associated with the concept of integration need to be defined and quantified. When this set of impressions or emotions has been defined they can be related to the different chromatic parameters in the architecture. Kansei Engineering applications are mainly found in the field of product design, where colour is studied as a product attribute, and variations can influence the observer's emotional response. Several works apply Kansei Engineering in the urban space to determine citizens' perceived impressions, such as the relationship between pedestrians' impressions of certain areas of the city and the neighbourhood they choose to live in. The communication begins with the state of the art on Kansei Engineering applications, for evaluating urban and landscape spaces and product evaluation, considering colour as the study attribute. After this analysis, an action protocol is proposed for application to studies on the chromatic integration of architecture in urban and natural environments.

Keywords: Kansei Engineering, chromatic integration, architecture, landscape

## 1. INTRODUCTION

Studies on perception of the environment show that assessment of the environment is a complex process involving emotional responses with cognitive judgments about environmental characteristics. The aesthetic response to an environment starts with the initial sensory impression, but with the addition of post-perceptual factors, such as knowledge, and a kind of internal critical discussion about the scene before us, the response changes (Bell, 2001).

The integration of architecture in its environment has been studied extensively in the rural environment (Cloquell-Ballester et al., 2011, Garcia et al., 2006). These authors consider color as one of the aspects that define the relationship between a building and its surroundings. Furthermore, the literature on the "Aesthetic response to building attributes" also suggests that the color of facades is an attribute worth studying as it can influence the aesthetic response to buildings (O'Connor, 2008). However, although there is an extensive literature on the visual impact of buildings and their integration in the environment, they do not provide an in-depth analysis of the structure of observers' emotional reactions and how that relates to their overall assessment. Analysing this emotional structure requires techniques

which enable measurement of human perceptions of products and the words people use to communicate their perceptions.

## 2. KANSEI ENGINEERING

From the area of user-oriented product development, the Kansei Engineering technique has been applied, which is able to quantify perceptions and relate them to design criteria. Nagamachi defines Kansei Engineering as a “translating technology of a consumer’s feeling and image for a product into design elements” (Nagamachi, 1995). Kansei Engineering is a methodology developed in the 1970s in the Kure Institute of Technology (Hiroshima, Japan).

The introduction of a Kansei Engineering system requires the following process (Schütte et al., 2004). In a first phase, user response is obtained and quantified in terms of evaluating the product’s “sensorial attributes”. The most commonly used technique for measuring user perception of a product in Kansei Engineering studies is semantic differential (Osgood et al., 1957). It can currently be considered the most powerful quantitative technique available for measuring the affective significance of concepts (Ishihara et al., 1997). This technique consists in following a given structure in questionnaire design using kansei words as scales for evaluating the sample stimuli. Principal components factor analysis is the technique most commonly used to reduce dimensionality. The advantage of this technique is that the emotional attributes used to find relations with design parameters are not defined by experts but by the consumers themselves. In this way, it can be ensured that the perceptions to be measured are really those valued by the consumers or users and those they are capable of expressing. In a second phase, after obtaining users’ affective dimensions or semantic axes (Kansei words), attempts are made to obtain inference rules between the design elements and semantic axes or perception variables. The most commonly used statistical technique to obtain this relationship is known as Hayashi’s (Hayashi, 1976) Type I Quantification Theory. It is a linear regression statistical technique for quantitative variables.

There are very numerous applications of Kansei Engineering in other areas. For example, in the automotive industry for the design of steering wheels, speedometers or frontals (Nagamachi, 2002, 1995). In the field of telephony (Lai et al. 2006), footwear (Alcántara et al., 2005), wine glasses (Petiot and Yannou, 2004), cameras (Yang, 2011), tools (Vergara et al., 2011), industrial machinery (Huang et al., 2011) and even of sports mascots (Lin et al., 1999). However, use in the field of architecture is still scanty, where the only studies found focus on the design of facades (Nagasawa, 1995), real-estate products (Llinares and Page, 2007) and even the design of public spaces (Kang and Zhang, 2010) and users’ perceptions of different city areas (Llinares and Page, 2008). In all these works the colour is studied as an attribute of the product, among other design parameters such size, shape, texture and style. All these parameters can influence to the user’s emotional response to a greater or lesser extent and therefore acceptance or rejection of the product. In the area of the impact of colour in urban landscape, we find the work by Kinoshita et al. (2006). These authors propose to colour planning support system for townscapes. This system is based on the evaluations of three models: (1) a Kansei evaluation model that relates town impressions and street colours of the townscape, (2) the color harmony model and (3) the cost evaluation model.

## 3. PROPOSED METHOD

Below is the proposed scheme for the application of Kansei Engineering for evaluating chromatic integration of architecture in landscape.



### Phase 1. Modeling user perception

The objective of this phase is to extract semantic space structure sensory attributes defining the concepts under which the user perceives the landscape. This set of words or semantic field constitutes valuable knowledge for assessing landscapes from the observer's own language. This phase requires the following steps:

- Creation of a word list by collecting expressions that non experts and professional observers use to describe the emotional reaction to the landscape under study.
- Creation of stimuli that provide information on the different models of chromatic integration of architecture in the environment.
- Development of the field study to obtain basic evaluations of the landscapes under study.
- Extraction of semantic axes or emotional attributes that qualify observers' perception of landscapes.
- Analysis of the relationship between semantic axes and the observer's overall assessment.

### Phase 2. Generating design criteria

The aim of this phase is to define guidelines or design criteria related to colour, based on modeling perception obtained in the previous phase. The development of this system requires the following tasks:

- Measurement of the chromatic composition of landscapes by objectives indicators.
- Creation of representations by virtual simulations: After identifying the different colour compositions that in some degree can determine perception of the landscape, we then create virtual stimuli. These simulations make it possible to modify the study variables independently.
- Development of the field study to obtain a base of simulated landscape assessments.
- Definition of chromatic strategies for improving the integration of architecture in the landscape.

## REFERENCES

- Alcántara, E., M.A. Artacho, J.C. González and A.C. García, 2005. Application of product semantics to footwear design. Part I – Identification of footwear semantic space applying differential semantics. *International Journal of Industrial Ergonomics*, 35, 713-725.
- Bell, S., 2001. Landscape pattern, perception and visualisation in the visual management of forest. *Landscape and Urban Planning* 54, 200-211
- Cloquell-Ballester, V-A., V-A. Cloquell-Ballester, R. Monterde-Díaz and M-C. Santamarina-Siurana, 2006. Indicators validation for the improvement of environmental and social impact quantitative assessment. *Environmental Impact Assessment Review* 26, 79-105.
- García, L., J. Hernandez and F. Ayuga, 2006. Analysis of the materials and exterior texture of agro-industrial buildings: a photo-analytical approach to landscape integration. *Landscape and Urban Planning*, 74, 110-124.
- Hayashi, C., 1976. *Method of quantification*. Toyokeizai, Tokyo.
- Huang, M.S., H.C. Tsai and T.H. Huang, 2011. Applying Kansei engineering to industrial machinery trade show booth design. *International Journal of Industrial Ergonomics*, 41, 72-78.

- Ishihara, S., K. Ishihara, M. Nagamachi and Y. Matsubara, 1997. An analysis of Kansei structure on shoes using self-organizing neural networks. *International Journal of Industrial Ergonomics*, 19(2), 93-104.
- Kang, J., and M. Zhang, 2010. Semantic differential analysis of the soundscape in urban open public spaces. *Building and Environment*, 45, 150–157.
- Kinoshita, Y., E.W. Cooper, Y. Hoshino and K. Kamei, 2006. Kansei and colour harmony models for townscape evaluation. *Journal of Systems and Control Engineering*, 220 (8), 725-734.
- Lai, H.H., Y.C. Lin, C.H. Yeh and C.H. Wei, 2006. User-oriented for the optimal combination on product design. *International Journal of Production Economics*, 100, 253-267.
- Lin, R., P.C. Lin and K.J. Ko, 1999. A study of cognitive human factors in mascot design. *International Journal of Industrial Ergonomics*, 23, 107-122.
- Llinares, C., and A. Page, 2007. Application of product differential semantics to quantify purchaser perceptions in housing assessment. *Building and Environment*, 42, 2488-2497.
- Llinares, C., and A. Page, 2008. Differential semantics as a Kansei Engineering tool for analysing the emotional impressions which determine the choice of neighbourhood: the case of Valencia, Spain. *Landscape and Urban Planning*, 8(4), 247-257.
- Nagamachi, M., 2002. Kansei engineering as a powerful consumer-oriented technology for product development. *Applied Ergonomics*, 3, 289-294.
- Nagamachi, M., 1995. Kansei engineering: a new ergonomic consumer-oriented technology for product development. *International Journal of Production Economics* 15, 3-11.
- Nagasawa, S., 1997. Kansei evaluation using fuzzy structural modelling. Paper presented at the *Proceedings of the First Japan-Korea Symposium on Kansei Engineering – Consumer Oriented Product Development Technology*.
- O'Connor, Z., 2008. *Façade colour and aesthetic response: Examining patterns of response within the context of urban design and planning policy in Sydney*. PhD. Supervisor: Moore GT, Ass. Supervisor: Hayman S. Available on-line: <http://usyd.academia.edu/ZenaOConnor>
- Osgood, C.E., G.J. Suci and P.H. Tannenbaum, 1957. *The Measurement of Meaning*. University of Illinois Press, Urbana, Illinois.
- Petiot, J.F., and B. Yannou, 2004. Measuring consumer perceptions for a better comprehension, specification and assessment of product semantics. *International Journal of Industrial Ergonomics*, 33, 507-525.
- Schütte, S.T.W., J. Eklund, J.R.C. Axelsson and M. Nagamachi, 2004. Concepts, methods and tools in *Kansei Engineering*. *Theoretical Issues in Ergonomic Science* 5(4), 214-231.
- Vergara, M., S. Mondragón, J.L. Sancho-Bru, P. Company and M.J. Agost, 2011. Perception of products by progressive multisensory integration. A study on hammers. *Applied Ergonomics*, 42, 652-664.
- Yang, C.C., 2011. A classification-based Kansei engineering system for modeling consumers' affective responses and analyzing product form features. *Expert Systems with Applications*, 38, 11382-11393.

*Address: Prof. Susana Iñarra, Lab Human Institute, Universitat Politècnica de València, Camino de Vera s/n, 46022, Valencia, Spain*  
*E-mails: [suiab@ega.upv.es](mailto:suiab@ega.upv.es), [cllinare@omp.upv.es](mailto:cllinare@omp.upv.es), [juaserll@ega.upv.es](mailto:juaserll@ega.upv.es), [atorresb@ega.upv.es](mailto:atorresb@ega.upv.es),*

# Colour and Light in the Requalification, Regeneration and Valorisation of Residential Buildings

Pietro ZENNARO, Katia GASPARINI, Alessandro PREMIER  
Dept. of Design and Planning in Complex Environments, University Iuav of Venice

## ABSTRACT

A PRIN research (Research Program of National Interest) which involved four Italian universities: University of Ferrara, Turin Polytechnic, University of Chieti-Pescara, Iuav University of Venice, has just been completed. The theme of the research concerned the “Requalification, regeneration and valorization of intensive social housing settlements built in the suburbs in the second half of the Twentieth Century”. Within the Venetian Research Unit, the three authors have dealt with the “Environmental quality as result of requalification, regeneration and valorization of the building envelope skin”, focusing their attention on how environmental regeneration is achieved through technological, chromatic and lighting interventions, aimed at improving the last physical frontier of the building. The case study used as a reference for the test and the validation of the obtained results is a medium-large scale intervention, located in the city of Verona, in Zancle street. The authors carried out on the intervention all the required simulations to verify as the only chromatic and lighting improvement of the last physical frontier of the buildings is capable of generating a significant environmental improvement that reverberates, as well as on the building itself, on the surrounding areas and on the entire neighborhood.

## 1. INTRODUCTION (P. ZENNARO)

A good number of European countries have a large architectural heritage that needs to be re-qualified, regenerated and valorized, i.e. brought to an overall condition of adequacy to the current standard of living, issue involving not only Italy. These buildings, some of them once the expression of the most advanced instances of design and construction, today represent the symbol of certain conditions of decay and inefficiency that characterize the contemporary city. To improve their environmental quality, the authors carried out a scientific research that has satisfactorily demonstrated that the most significant interventions from an environmental point of view, obtained by colour and light use, give significant social consequences, taking place around the interface called: architectural envelope.

Here the architectural envelope is not conceived as a functional package, but as an external boundary, in which the technologies that make use of colour and light are capable of ensuring the building quality and ameliorate the environment where it is placed, as well as to provide an adequate protection to the functional layers underneath. Today, this external boundary has considerably evolved: since the skin of buildings has become active, adapting to external environmental conditions, the relationship with the outside and the materials that underlie gave to this external boundary functions that are most similar to an interface than to a passive element which future is degradation and to be destroyed. Today, all the interventions relating to the architectural envelope can produce drastic effects on the improvement of the environmental quality of the entire building and its surroundings: better energy performances, better environmental and appearance performances, life extension and increased value of the asset.

The effects produced by the requalification, regeneration and valorisation operations on the building envelope are mainly social, economic and environmental. The social effect minimize the discomfort of the inhabitants and could also improve the aesthetic quality get by colour and light solutions; economic effects consist mainly maintaining the existing building, saving time and money; the environmental consequences are focused on the reuse of the building functional parts, involving a small environmental impact and reusing the demolished parts, encouraging recycling, trying to minimize the quantity of material to take to the landfills.

The intervention strategies for the building envelope requalification pivot around the choice of the technical solutions to be adopted. They are derived from the identification of performance deficiencies and inadequacies, closely connected with the existing materials and construction technologies and with the building and the surrounding context history.

The better technical solutions we found during the research are mainly oriented to the cladding, re-cladding, over-cladding and re-sheeting works. But positive effects are only possible if the designer adopts appropriate intervention strategies, directing the project and the execution of the work on goals that make programming and planning the fundamental reasons of the intervention (strategic planning).

## **2. COLOUR IN HIGH-INTENSITY RESIDENTIAL BUILDING'S ENVELOPES: THE EVOLUTION OF TECHNOLOGIES (K. GASPARINI)**

From the technological point of view the architectural cladding is represented by the finishing last layer of the envelope. In recent years such a layer has increasingly evolved, multiplying the functions, the characteristics and performance. This constructive evolution, typical of many contemporary architectural envelopes, doesn't match the same result in residential buildings. F. O. Gehry in the eighties of the last century was a pioneer of this new way of design that has now become standard practice in architecture.

Minimal finishing can be found in residential Italian public buildings, built after World War II. They are envelopes where the maximum level of complexity is represented by marble or stone panels, prefabricated panels or plaster or brick finished. In those days the colour of the surface was depending from the type of coating material. The colour of the surface was strictly neutral or of earthy colours. Therefore they were (and still are) suitable for building gray surfaces, such as unpainted concrete prefabricated panels, or with prevalence of colours like marble beige of some local stone used as overcoat the base of the buildings. When the surfaces were plastered the colours range was from all shades of beige to dark brown. Over a time of the seventies of the last century it's possible to find green variants: from the shade pea green to a moss green, tending to the colour of the vegetation in an advanced state of decomposition.

In this analysis we can easily understand the low level of environmental quality of Italian public housing built at that time. Buildings are still inhabited, often in poor maintenance conditions. In the research carried out were found and filed 25 study cases, made both in Italy and in Europe. The analyzed buildings are distributed among France, Germany, Switzerland and Italy. We analyzed envelopes built after World War II, in which were made works of requalification over the last decade. The research purpose was a scientific assessment of the type of intervention carried out on the scope of requalification and valorization made by the use of colour and lighting in the external perceived surfaces.

From the research we collected interesting data for the built envelope analysis, both in terms of construction and stratigraphy, and in terms of perception. A specific analysis section is focused on the type of materials used for the cladding, re-cladding, sheeting and over-sheeting. The materials were classified into: traditional, innovative and smart. At this stage the study is focused to analyze in-depth the pattern, the technologies and the consequences of the intervention.

In the analysis of the new envelope the perceptual system has been classified relating to the environment, components and materials used. The analysis of the perceptual system was conducted by a classification of “pattern surface”. This analysis has allowed the split of architectural surface from the point of view of the drawing, of the regularities that are found within a set of observed objects (the pattern identifies a geometric repetition of a graphic pattern on a surface) and of the techniques used to capture the visibility of the facade. The second part of the analysis of the perceptual system took care of the technologies used to emphasize the perception of the facade pattern named “the colour technologies”.

They are distinguished by monochrome or polychrome colours, typical of glassy, plastic and metallic materials. The primary colours are the most common; at most we can find few shades of orange or green, always in deep saturations. It was found, therefore, that the colours and shades, used compared to the situation prior to requalification works, completely change. In certain cases the material itself defines the colour of the facade, in other cases thin films are applied or paints and dyes to get different gradations. These are synthetic colours, resulting from the processes of application of graphic elements obtained by graphics software, which primarily use the colour range of the additive and subtractive synthesis (RGB monitors or four-colour printing: cyan, magenta, yellow, dark).

On the other hand the perception resulting from the use of lighting technology is completely different. In this case the perceptual system is influenced by the use of lamps and / or LEDs. These systems allow more dynamic built envelopes, extending the colour combinations available. Sometimes we can detect the use of mixed technologies, using both the colour and/or the light. In this category, it has been suggested also the application of technologies such as urban-media screens or coatings employing smart systems. These systems are frequently used nowadays for reduction of energy consumption.

### **3. CHROMATIC TECHNOLOGIES APPLIED TO A CASE STUDY (A. PREMIER)**

We chose, as a tool for the validation of the PRIN research, the competition for the environmental requalification of ATER residential buildings of Via Zancle in Verona, built in the Seventies of the Twentieth Century. In the new design intervention, made by the three authors, the traditional solutions have been abandoned in favour of innovative and smart chromatic edge technologies. The set of buildings perfectly belonged to the tradition of Italian post-war neighbourhoods. It was made up of three buildings with the typical services of the neighbourhoods of that time. The buildings were characterized by outer surfaces treated with plaster, subjected to strong degradation. The façades still had the original colours. The external paths were covered with local white stone, often damaged. The parapets of reinforced concrete bore the signs of an obvious degradation: mould, peeling, sagging. The vertical elements of the arcades on the ground floor were painted with earthy colours, mostly beige, while the façades, for the first four floors were entirely white. The various overhangs of the buildings (balconies etc..), especially on the upper floors, were painted in beige or red ochre. Beige and ochre were also used to highlight the crowning of the buildings. The metal

railings of the balconies were coloured in a faded beige or in a rusty ochre. Even the outer car boxes had the same colours. The buildings were also characterized by a series of changes and accretions accumulated over the years: shutters of different colours, satellite dishes, double windows in anodized aluminium. Overall, the building features confirmed the result of the research.

With the design competition, the ATER Agency of Verona, owner of the property, wanted to heal all these situations in order to improve the environmental quality of the neighbourhood. The interventions were then concentrated on the outer surfaces of buildings. The building envelope has been upgraded by means of an over-cladding operation with the use of a layered system composed of nano-structured thermal insulation and an outer skin of corrugated aluminium which gave uniformity of colour and pattern to the whole building. The silver colour of the aluminium interacted differently with the sun shading systems provided in the north and south sides. A second layer of glass blades with photovoltaic integration was superimposed to the south façades. The blue colour of the blades draws a pattern that fades towards the upper part of the façade thanks to the convexity of the support structures of the sun screens. The north façade has two different configurations: the daytime mode and night mode. Over the monochromatic aluminium skin there is a metallic fabric that, during the day, blurs the appearance of the façade contributing to a sort of dematerialization of the building envelope. The façade changes completely at dusk. The energy produced by the photovoltaic system is capable of powering a system of LEDs merged into the metal fabric, turning the entire northern façade in a transmitter of messages, images and video in low resolution. The entire façade is tinged with coloured pixels transmitting information that enhance local culture and resources.

In conclusion: the operations of requalification, regeneration and valorisation that are performed on the building's surfaces, as shown, have an enormous capacity of improvement of the environment even just making a wise (or qualified) use of colour and light.

## REFERENCES

Zennaro, P., K. Gasparini and A. Premier 2012. *L'involucro Rivestito*. Rimini: Maggioli.

*Address: Prof. Pietro Zennaro, Dept of Design and Planning in Complex Environments,  
University Iuav of Venice, Dorsoduro 2206, 30123, Venice, ITALY  
E-mails: [pietro.zennaro@iuav.it](mailto:pietro.zennaro@iuav.it), [katia.gasparini@iuav.it](mailto:katia.gasparini@iuav.it), [alessandro.premier@iuav.it](mailto:alessandro.premier@iuav.it)*

# **Colour Revival of Residential Estates Built of Prefabricated Large Panels in Poland: between Art and Kitsch**

Justyna TARAJKO-KOWALSKA  
Faculty of Architecture, Cracow University of Technology  
Cracow University of Economics

## **ABSTRACT**

The aim of this article is to present the problem of the revival of post-communist prefabricated blocks of flats in Poland. The process of thermal efficiency improvement entails a chance for the aesthetic renovation of these blocks, which is sometimes actually implemented but in many cases unfortunately abandoned. Successful projects of colour revival will be presented on selected examples. There will also be negative examples shown that give rise to a range of social initiatives promoting the aesthetic renovation of large-panel blocks.

## **1. A MACHINE FOR LIVING – A TROUBLESOME LEGACY**

As in other post-communist states, the Great Housing Estates, i.e. housing estates consisting of multi-storey blocks of flats built using the prefabricated-sections technology, make for an enormous part of Poland's housing stock. The modular construction system based on concrete structural elements prepared off the construction site became popular in the Polish housing construction industry especially in the 1970s and 1980s (Makowski 2010). Just as proposed by Le Corbusier, elevations of buildings were left with raw concrete, without applying costly plaster or linings. This minimalist, raw aesthetics became inextricably associated with the socialist time, and the general lack of colour, not only in architecture but also products available in the market, made the ubiquitous greyness a synonym of the time. In the 1990s, the deteriorating technical conditions of those buildings and related technical infrastructure made the problem of redeveloping, renovating or demolishing them grow more serious. In Poland, apartments in those now 40-year-old buildings are marked by a low value on the secondary market and low operation cost. These factors make them very popular living places, especially as the first apartment or for rent. Due to a high rate of flats in prefabricated housing estates (today some 40% in Poland), the buildings are not demolished and replaced by higher-standard developments as this is the case in the former German Democratic Republic, for instance. They are renovated instead. Due to the lack of comprehensive revitalisation schemes and funds to finance comprehensive redevelopment, the housing estates are only subject to minor repairs and thermal renovation (Gronostajska 2010).

## **2. THERMAL RENOVATION – AN OPPORTUNITY FOR VISUAL AND AESTHETIC RENOVATION**

The necessity to raise thermal insulation standards of walls of the prefabricated-section buildings became an opportunity to change their look by imparting new colours to them. At the beginning, even the most daring colour combinations appearing on renovated elevations seemed to be a positive change, an act of breaking with the grey of the communist era. As this spontaneous colour activism became more popular in the urban environment, the fact that the

activities conducted were not coordinated became more evident. In most renovation cases, the colouring is bright and not correlated with any compositional divisions of the elevation. Hues are sometimes picked by members of housing cooperatives, often according to their personal colour preferences – without considering tectonics of the building or its spatial location. It is often the case that housing estates or even single buildings are managed by several cooperatives, as a result of which various blocks within a single estate are renovated at a different time and painted according to different colour concepts, often incongruous and disharmonious. This blurs town-planning concepts of housing estates, usually quite clear in the original design. The design of many buildings is often marked by good proportions, thought-through divisions and details making them stand out against the mass building production. However, their walls are treated like multidimensional painting canvass covered with images of rainbows, zigzags, stripes, flowers and animals that bring to mind kindergarten art classes. Historic buildings are the only buildings to be subject to city art consultant's supervision and owners of those buildings need to consult the conservator on their design before painting anything. All other buildings can be objects of free colour experiments (Maciejowska 2012). Main defects of elevation renovation projects completed include: acting "locally" – no comprehensive solutions for the whole town-planning complexes; colours being selected in a way that does not consider the immediate proximity and background of the buildings; excessively bright and saturated hues; improperly selected colour combinations with excessive saturation and intensity; elevations being painted without considering architectural divisions; the use of multidimensional patterns, maladjusted to the human scale and perception.

### 3. THE PHENOMENON OF "COLOUR CONTAMINATION" SEARCHING FOR A SOLUTION TO THE PROBLEM

The phenomenon of "colour contamination" or "pastelosis" that "contaminates" housing estates and blocks of flats has become a subject of enormous social concern, which has rarely happened through the history of colour in architecture. Numerous initiatives are undertaken to prevent renovation projects that can mar prefab-section buildings. One of the ideas aiming to improve the visual quality of prefab-section housing estates is to bring large-scale reproductions of paintings by famous painters onto building elevations. This idea is to humanize housing estates made up of blocks of flats by creating innovative outdoor galleries. A successful attempt to introduce high art on building walls was made in Gdańsk in the Zaspas housing estate. To date, over 40 murals have been delivered as part of the MONUMENTAL ART European Monumental Painting Festival organised since 2009. ([www.monumental-art.eu](http://www.monumental-art.eu)) One of the items in the new Krakow Promotional Strategy 2008-2012 included a plan to revitalise prefab-section estates: "Great Prefab-Section Estates – Great Art." That idea was to develop the largest outdoor contemporary art gallery, with large elevations of prefab-section buildings used as giant canvass featuring works by famous painters. (Wójcik 2008) Despite the support of the Mayor of the City of Krakow, the project was not implemented, probably due to its high cost. It seems, though, that the underlying idea of those projects, indeed quite interesting as an artistic event, is not a solution to the problem of all block-of-flats estates and may be perceived only as a local intervention on precisely selected buildings. One of the most interesting projects aimed at improving the aesthetics of Polish cities through properly used colours is the Pospolite Ruszenie campaign, put forth by a Wrocław-based musician and performance artist Łukasz L.U.C. Rostkowski. The originators of the project want to stimulate as well as educate the society with the aim to improve



the city landscape and encourage the development of other projects seeking to change the look of elevations marred with kitsch colours. ([www.pospoliteruszenie.com](http://www.pospoliteruszenie.com)) The campaign commenced back in June 2011 with a successful colour renovation of the block of flats at Świeradowska Street in Wrocław, dubbed “Cud na Gaju” (“Gaj Miracle”). Despite the painterly treatment, in this case the building’s prominent location and potential were successfully used to deliver a new spatial quality. Another result of the Pospolite Ruszenie campaign was a 2011 competition for the renovation of the building elevation at Przestrzenna Street in the Huby estate in Wrocław. (Saraczyńska 2011) Pospolite Ruszenie activities inspired the Krakow reFRESH (“Refresh your block”) project held in 2012. The project consisted in creating a graphic design for the building’s elevation at 18 Lipińskiego Street in the Ruczaj estate. Paulina Lichwicka’s winning project proposed to paint a large-format composition inspired by a house on tree. For financial and legal reasons, the project has not been implemented. It seems, however, that the main reason was that the project was overly complex and it would be quite difficult to precisely put it into practice ([refreszkrakow.blogspot.com](http://refreszkrakow.blogspot.com)). Campaigns aimed at the positive redevelopment of urban space meet with huge social response. From all over Poland, the website of [www.pospoliteruszenie.com](http://www.pospoliteruszenie.com) receives not only examples of “contaminated” buildings but also examples of designs delivered and design proposals for the existing blocks of flats. We are also witnessing more and more successful thermal renovation projects such as the one at Waryńskiego Street or at the Chrobrego estate (both in Poznań, by Ultra Architects) (Henzel 2012), or for the Wrocław estate of Popowice (the AQ7 group) (Gołębiowska 2012) A governmental revitalisation and renovation scheme for prefab-section blocks of flats is also likely to be developed soon. A related debate began back in December 2012, but as early as 2006-2007, the forum of Visegrád Group featured talks aimed at uniting Poland, Hungary, the Czech Republic and Slovakia in the efforts to gain EU funds to finance such a project. These activities are to be focused on improving the technical conditions of the buildings and the attractiveness of the living space for greater satisfaction of housing estate residents.

#### 4. SUMMARY AND CONCLUSIONS

Prefab-section housing estates have become one of identificatory elements of many Eastern Block countries, including Poland. This architecture is marked by a kind of nobility and raw, minimalist aesthetics, which has shaped millions of people for 40 years of its existence and is tied with social and cultural identity (Sołoucha 2010). Their revitalisation, consisting at least in renovating buildings’ elevations, may raise the value of housing estates, only if conducted in a proper way, though. Numerous campaigns for the improvement of the aesthetic image of Polish prefab-section housing estates, show that the society is seeking for something more than kitsch and random colours in its surroundings and calls for comprehensive solutions. Each housing estate and each building should be considered separately, approached in conjunction with their specific nature, and their new colouring should be designed in a conscious manner. Many blocks of flats show interesting architecture and it often suffices to return to the original plan to bring their original look back. Painterly treatment of the blocks of flats makes sense only if elevations are free from prominent details and may be applied only to a small number of buildings (Saraczyńska 2011). An analysis of the successful examples shows that the best projects are those that do not make architecture a hero of the space, but just the background for the life around it (Wybieralski 2012). These are projects that rest upon understanding of what a block of flat is and bring the essence of the architecture to the fore with a minimalist and efficient use of colours while at the same time imparting them with a new quality and identity.

## REFERENCES

- Gołębiowska, M., 2012. *Czy spodobają się nowe kolory bloków na Popowicach?* Available online [http://wroclaw.gazeta.pl/wroclaw/1,35771,11549288,Czy\\_spodobaja\\_sie\\_nowe\\_kolory\\_blokow\\_na\\_Popowicach\\_.html](http://wroclaw.gazeta.pl/wroclaw/1,35771,11549288,Czy_spodobaja_sie_nowe_kolory_blokow_na_Popowicach_.html), Accessed 4.05.2013.
- Gronostajska, B., 2010. *Zespoły mieszkaniowe z wielkiej płyty w XXI wieku – problemy, perspektywy*, *Architecturae e Atribus*, 2 (4). Oficyna Wydawnicza Politechniki Białostockiej.
- Henzel, P., 2013. *Plan rewitalizacji osiedli obejmie całą Polskę. Andrzej Adamczyk: to olbrzymie wyzwanie*, Available online <http://wiadomosci.onet.pl/kraj/plan-rewitalizacji-osiedli-obejmie-cala-polske-and,1,5385540,wiadomosc.html>, Accessed 04.05.2013.
- Maciejewska, B., 2012. *Osiedla zmieniają się w koszmarki. Czas to powstrzymać*, Available online [http://wroclaw.gazeta.pl/wroclaw/1,35771,11591368,Osiedla\\_zmieniaja\\_sie\\_w\\_koszmarki\\_Czas\\_to\\_powstrzymac.html#ixzz2EpJkZJ9x](http://wroclaw.gazeta.pl/wroclaw/1,35771,11591368,Osiedla_zmieniaja_sie_w_koszmarki_Czas_to_powstrzymac.html#ixzz2EpJkZJ9x), Accessed 04.05.2013
- Makowski, Ł., 2010. *Rewitalizacja terenów otwartych w osiedlach z wielkiej płyty*, Available online [http://www.nfosigw.gov.pl/gfx/nfosigw/userfiles/files/aktualnosci/2010/kwiecien/prace\\_magisterskie/lukasz\\_makowski.pdf](http://www.nfosigw.gov.pl/gfx/nfosigw/userfiles/files/aktualnosci/2010/kwiecien/prace_magisterskie/lukasz_makowski.pdf), Accessed 4.05.2013
- [refreszkrakow.blogspot.com](http://refreszkrakow.blogspot.com)
- Saraczyńska, A., 2011. *Pomalowanie bloku nie poprawi wyglądu całego osiedla*. Available online <http://wroclaw.gazeta.pl/wroclaw/51,35771,10155452.html?i=1#ixzz2SKagrHDR>, Accessed 4.05.2013
- Sołoduha, K. *Krótką historią blokowisk*. Available online [http://www.sztuka-architektury.pl/index.php?ID\\_PAGE=258](http://www.sztuka-architektury.pl/index.php?ID_PAGE=258), Accessed 4.05.2013
- [www.monumentalart.eu](http://www.monumentalart.eu)
- [www.pospoliteruszenie.com](http://www.pospoliteruszenie.com)
- Wójcik, M., 2008. *Wielka płyta – wielka sztuka*, Available online <http://krakoff.info/2008/01/11/wielka-plyta-wielka-sztuka/>, Accessed 4.05.2013
- Wybieralski, M., 2012. *Na Piątkowie będą mozaiki zamiast pisanek*, Available online [http://poznan.gazeta.pl/poznan/1,36001,12937346,Na\\_Piatkowie\\_beda\\_mozaiki\\_zamiast\\_pisanek.html#ixzz2SKAQn3ur](http://poznan.gazeta.pl/poznan/1,36001,12937346,Na_Piatkowie_beda_mozaiki_zamiast_pisanek.html#ixzz2SKAQn3ur), Accessed 4.05.2013

*Address: PhD. arch. Justyna Tarajko-Kowalska,  
Faculty of Architecture, Cracow University of Technology,  
Warszawska str.24, 31-155 Cracow, Poland  
E-mail: justarajko@tlen.pl*

# URBAN SIGNALS: Smart Technology and System for Contemporary Landmarks

Katia GASPARINI

Dept. of Design and Planning in Complex Environments, University Iuav of Venice

## ABSTRACT

Historically a Landmark identified a geographical place, a reference point for seafarers and explorers to find the way back or their way in the middle of nowhere. Lighthouses could be Landmarks for sailors as pyramids could be for explorers. They acquired a geographical or historical importance by identifying a place through their shape, but, above all, through the visibility conferred to them by the emitted light or colours. Nowadays the role of Landmarks and their relationship with the landscape they identify have completely changed: from urban signals to symbolising themselves. The Landmarks are now the place for the most inventive experimentations of the latest colour and light technologies: multi-coloured or mirrored materials, new materials or innovative materials tested in buildings. The Agbar Tower in Barcelona is now a Landmark with the coloured pixels of its envelope in contrast with the Sagrada Familia. Also the “Alba di Milano” installation by Ian Ritchie, covered with 120 km of coloured fibre optics, was a Landmark.

The paper will describe the analysis carried out at Università Iuav di Venezia on new light and colour smart technologies available nowadays for the cladding of architectural surfaces and with visibility and communication purposes. It will deal with media systems realised using low-environmental impact smart technologies and materials, possibly energy self-sufficient (from Zero-Energy to Energy-Plus). The paper will describe the research results and the possible fallouts that a Zero-Energy intervention may have on the local area and the landscape.

## 1. COLOR AND LIGHT TECHNOLOGY FOR NEW LANDMARK

Nowadays a Landmark, intended as a reference point, is an artifact easily identifiable, such as a monument, a building or an infrastructure. For example belong to this generic category: the Statue of Liberty, the Colosseum and the Tower of Pisa (monuments); the Brooklyn Bridge or the more recent Constitution Bridge in Venice (infrastructures); the Empire State Building or the Basilica of the Sagrada Familia (buildings). What do these Landmarks have in common from an architectural point of view? The traditional building systems and materials used: steel building systems and dry stone walling for the infrastructures and masonry walls, stones, plasters and enamels for the buildings, i.e. natural or, at most, industrialised materials, born out of the industrial revolution innovations. Moreover, they maintain the original colour of the material used: the white of the stone, the grey of the plaster, the red of the brick, the brown of wood. For example, the multi-coloured enamels of Gaudi works in Barcelona.

Similarly, in the contemporary era, some interesting landmark, are designed to be built with information and electronic technology. For example, the Indemann project in Germany.

It is a huge luminous and colourful robot covered by a Mediamesh system, as well as the enlargement of the KunstHaus in Graz are Landmarks, as many others.

Modern low-environmental impact light and colour technologies, coming from the electronics field, allow for large-scale experimentations and great visibility of contemporary architectural envelopes. In this new context, buildings take on a new role while functions blend with types. Visibility, perception and the identification with the landscape, rather than the function, are now important. Any structure, properly covered with light and colour technologies, can be identified as a Landmark, regardless of its location. In a few lines it seems difficult to deal with all the different types of currently known landmarks. Which parameters can be used to classify a landmark? The parameters may be: the period of construction, the location, the building type, the cladding materials, the original function, and so on.

Usually Landmark is a keyword that identifies an object emerging from the surrounding area. For this feature, the landmark is visible at 360 degrees from many observation points. Usually, the Landmark is a construction that identifies the land on which it is located. Therefore, we may place into the category of Landmarks (in addition to historic buildings such as the Pyramids or the Sagrada Familia): radar towers, smokestacks of factories, other types of towers (castles towers, water towers, telemetry towers, etc.) and temporary installations located in strategic places. This last category, of temporary installations, is relatively recent phenomenon. In this category we may insert, for example, the Indemann project before mentioned, the D-Tower designed by Nox, defined as *urban branding*, installed near the city gates of Doetinchem. It's a project of 5-symbolic towers 12 meters high, designed by the Dutch Architects NOX, in cooperation with the Dutch artist QS Serafijn, the V2\_Lab group and the Machine Vision studio (who worked on the prototyping-production work).

The overall project includes the input of the towers in a media circuit which makes the towers catalyst for the city. In this way, the towers become extenders and amplifiers of the city mood. The project doesn't end only in the form production (Architecture? Object? Sculpture?), but also and above all as data transmission through a website and in its interaction with a survey available by different groups of people. The towers, made of fiberglass, are lit by a color changing LED system. Their luminance is obtained with 12 large lamps, located where spindles open in the wide dome; the twenty LED, of which each light source is made, allow the color variation.

Still in the field of contemporary Landmark, the example of the airport tower in Berlin, 31 meters high, seems to be interesting. The project BBI-Info Tower was designed by the Kusus + Kusus Architekten. During the night, the tower is lit from within by a LED color changing system. In this way the BBI Infotower is integrated into the landscape and became a symbol in Berlin. On the exterior, the tower is a series of isosceles triangles that, on each level, are rotated six degrees counter-clockwise. This result an unusual and striking form that creates different perspectives from each angled viewed. The idea of dynamic twisting can be rationalized as an architectural interpretation of wind or motion, as associated with the airport. The exterior, a white ETFE membrane, allows a certain degree of visual transparency during the day and creates a light tower at night, as different colors burst through the translucent skin. The tower's spatial impression is the effect of the membrane stretched between the triangular steel frame<sup>1</sup>.

---

1 <http://www.archdaily.com/60155/bbi-info-tower-kusus-kusus-architekten/>

## 2. COLOR AND LIGHT TECHNOLOGY FOR ARCHITECTURAL ENHANCEMENT OF THE OLD TOWERS

Recent installations described above are just an evolution of what happened with the Tower of Winds designed in 1987 by Toyo Ito. Already in that project one could recognize the use of electronic systems for interactive development of the first electronic Landmark at urban scale.

The use of color and light technologies for the architecture valorization seems to be interesting in the case of historic buildings. In these cases it is possible to make projects using color to valorize the work with materials such as paints, smart films or nanotech, ceramic or metal components, etc. Above all using some special smart paints it is possible to simultaneously obtain both chromatic and bright effects. In this way, with a single material, energetically self-sufficient, we may perform two functions, without energy consumption and environmental pollution.

These experiments were proposed and suggested to valorize two types of Landmark featuring some of the Venetian valley and Venetian landscapes in particular: the piezometric towers (water towers) and the telemetric towers.

Water towers are constructions used on water distribution pipelines. They are constructions of considerable height because bound to respect the hydraulic grade line of the water pipeline. The water towers are usually built in normal or prestressed reinforced concrete, but may also be made in steel.

The telemetric Towers are artifacts typical of the Venetian coast, built during the war period, emerging from the flat and uniform lagoon. These towers were used during the wars to sight the enemy and to calculate the distance, to be communicated to the gun batteries scattered along the coast. They were called this way because on their top was positioned a “rangefinder”: an instrument able to quickly measure distances and then spot and identify the target enemy.

The Cavallino-Treporti is full of discharged military settlements built to protect Venice, the port, the arsenal and the industrial center during the last two world wars. The telemetric Towers are part of a unique historical and architectural heritage in Italy both for the high buildings concentration and for their different shapes. The valorization project of the telemetric towers was presented in a recent IUAV<sup>2</sup> research, in which the towers were placed in a testing phase of an innovative model for the area development. Because the towers are bound and historical buildings it has been proposed for their valorization the only use of lighting technologies, due to their temporary nature and removability. In this case have been proposed LED systems for lighting design and architectural projections, alternated with mapping projects for the realization of cultural events.

The case of not bound water towers is different and therefore it's possible to work in a less ephemeral way. The water towers, usually built in concrete, are affected by visible material degradation, especially on their external surface. These towers emerging from the landscape disqualify the environment with their surface degradation: by lines, mold and patches of degradation.

---

2 SI.S.SY - Site Specific System. The valorization of Venetian fortified system: guidelines for the project aimed to the protection, requalification and valorization of the disused military patrimony through digital media systems and smart technologies.

In a recent conference held at the Fondazione Cà Vendramin in Veneto Region, entitled “Architecture and landscape of reclaim” I have proposed a valorization of these towers with the use of paints. These materials are relatively inexpensive, but effective. In these cases, action can be taken in two ways: by integrating chromatically the tower surface with the landscape, as in a work of J.Tornquist, the chimney of incinerator in Brescia, or put it into prominence with color plays as the project of Alessandro Mendini in one of the water towers in Milan. In this project Mendini created a mosaic of polychromatic ceramic tiles.

In particular for the valorization of these towers we could use paint of iridescent dichroic color effects variable according to the ambient light, or using litrosphere paints. Litrosphere paints are made of a material emitting light for about 12 years, without electricity and without exposure to the sun. These paints can be printed, injected or painted on any surface, making the equivalent of an incandescent bulb of 20 W. Alternatively there are photoluminescent coatings, to be applied on a neutral or white background: paints are colorless to light and transparent up to 95%. The emission of colors like turquoise and green are loaded very quickly and can shine up for several days. The display dims gradually as the hours passed. The wear of the effect is almost non-existent, since in most cases the duration of the phosphorescent products exceeds 15 years.

These solutions have been proposed during the conference mentioned, for the valorization of hydraulic projects spread in the territories of the Veneto reclaim.

### 3. CONCLUSIONS

In the construction of contemporary Landmark generally it's possible to recognize the use of light systems to increase the construction visibility. The solutions employed often pivot around the use of LED systems, at low energy consumption and controllable color (Red-Green-Blue). In some circumstances, such as for the D-Tower lighting system, the matter is to the interactivity and adaptation to environmental parameters dictated by the user or connected via web.

The use of smart materials, such as those proposed for the valorization of water towers; however, allow significant energy savings, with low environmental impact, both in terms of consumption (and costs) and of light pollution.

### REFERENCES

Gasparini, K., 2012. *Schermi urbani. Tecnologia e innovazione. Nuovi sistemi per le facciate mediatriche*, Milano: Wolter Kluwers.

*Address: Katia Gasparini, Department of Design and Planning in Complex Environment,  
Iuav University of Venice, Dorsoduro 2206, 30123, Venice, ITALY  
E-mail: katia.gasparini@iuav.it*

# Colour and Townscape: Experimental Intervention Methodology in Historic Areas

Ana COSTA, Joana CARVALHO, Maria NETO  
Colour Lab, Lusíada University of Lisbon

## ABSTRACT

This article aims to focus on the ways colour study can address the problem of the façades covered with tiles. Taking Lisbon as a case study this article argues that tiles could be at the forefront of a colour study of the surrounding buildings due to its influence on colour perception and to the impact of its historical ballast.

### 1. TILE CLADDING IN LISBON: HISTORY AND CONTEXTUALIZATION

The first contact with mural ceramic in Portugal dates from the early sixteenth century and has an Islamic origin. Although Islamic people mostly applied ornamental ceramic to buildings exteriors, in Portugal its use was predominantly oriented towards interior decoration, courts and balconies within conventual buildings, palaces and churches (Almasqué, 1989). The resort to tiles in exterior façades only begins at the end of the eighteenth century, emerging for the first time in the *Condes da Guarda* Palace, in the place where currently stands the Cascais City Hall. One can notice the multiplication of rental buildings and the use of semi-industrial tile to cover façades since the first quarter of the nineteenth century, due to several factors as, for instance, the advent of liberalism and the return of Portuguese emigrants from Brazil, This kind of cladding was attractive and well-accepted not only for its chromatism or due to enamel's shine but also because it is an economical material, durable, easy to clean and that has insulating characteristics, which partially explains the predominance of its use in coastal areas, as well as the strategic localization of tile industry. The use of tile to cover buildings of several architectural programmes in Lisbon is, therefore, very frequent, presenting a wide pattern spectrum that creates rhythms through geometric motifs. It also influences the perception of Lisbon's light, creating chromatisms that, at a distance, are dissolved thus giving rise to a particular light. We wonder if could be the presence of a significant number of façades covered with tiles related to a well-grounded urban identity and to a collective memory?

### 2. DIFFERENT PERCEPTIONS OF TILE CLADDING

The decision to explore the tile's role in colour study is related with the difficulties that emerge in reading its chromatic definition in urban context, in contrast with the immediate identification of the plaster coating buildings. Due to its enamelled surface, tile's perception changes depending on the direct effect of light, which fluctuates between high levels of sunrays reflectance, thus acquiring the effect of a mirrored surface that, in the limit, annuls colour or emphasizes its chromatic components. Depending of the distance between the observer and the façade, the reading of this kind of cladding can change. Tile covering in façades, especially pattern tile, is based on the regular repetition of one or more tiles to create patterns, normally composed by modules of four equal tiles, which implies a non-isolate reading of it. This composition is allowed by the repetition of the same tile that usually has between one and four symmetry axis. Patterns can also be obtained through the combination

of two or more different tiles, although these cases are rare due to the simplification processes induced by semi-industrial techniques and to drawing standardization. Thus, even if we can read tile separately, it works through modules that can be repeated and which impact differs depending if the observer approaches or moves away, providing diversified effects concerning geometric forms and colours. On the other hand, the kinematic experience also influences the impact caused by this kind of cladding. While observing from a static position implies variations according to the distance, dynamic observation of a route is characterized by a relation of variables and the perception alternation of a bright or matte surface, which animates serial vision (Cullen, 1961). We assume that, concerning the reflectance level and the progressive distance of the observer, in the conjunction of pattern, colour, distance and surface, the perception of façade covered with tile reaches, in the limit, a uniform tone or the annulation of colour.

### 3. TILE: KEY ELEMENT TO THE ELABORATION OF COLOUR PLANS

This study presents itself as an experimental methodology in the interpretation of the impact of the buildings covered with tile in the urban chromatic reading, raising some questions concerning tile cladding as a key element in the elaboration of colour plans in Lisbon. However, this elaboration consigns to a global study integrated in the city and to the integrated management of several kinds of analysis, thus combining a primary survey work of the actual colours with a perceptive analysis of the presence of tile in urban space and its particular characteristics. Therefore, for this methodology we intersect an historic and morphological analysis with typology and townscape. The case study reflects the importance of these analyses and its practical application.

### 4. CASE STUDY: *LARGO DO EMBAIXADOR*

#### 4.1. Historic and Morphologic Analysis

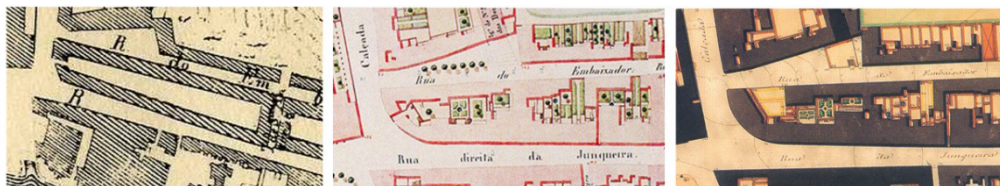

Figure 1: Plan of Duarte José Fava, 1826; Plan of Filipe Folk, 1856; Plan of Silva Pinto, 1911. Embaixador Plaza is bordered in West through Calçada da Ajuda, in East, through Salésias Street, and it ends with Embaixador Street.

*Embaixador* Plaza is located in west Lisbon within *Santa Maria de Belém*'s parish, which is delimited by *Algés*' and *Alcântara*'s streams. Its location, close to Tagus, was a crucial historical factor to the development of a small village that served as temporary housing for sailors. This area was progressively occupied, nowadays being an integrant part of the urban fabric. The area also reflects the progressive urbanization of *Sítio da Junqueira*, with the opening of the old *Direita de Belém* Street (França, 1997). Through a cartographic analysis of this area we can notice that *Embaixador* Street was already stabilized since the beginning of nineteenth century (1908-26). To apply the proposed experimental methodology we chose this square as case study not only due to its historical relevance but especially thanks to its specific features: analysing the spatial organization of *Embaixador* Plaza and confronting it



with the historical information of the morphologic urban evolution, we can deduct that its triangular form is a result of the secluded establishment in relation to the *Embaixador* Street and the previous location of *Nossa Senhora das Dores* church dated from 1787 (Fig. 1) with a small public square. The urban fabric followed the location of the church, which in turn allowed the permanence of this square and gave a higher profundity to *Embaixador* Street narrowing at *Calçada da Ajuda*. The disposition of the buildings enables a greater distance observer-façade, rather different from the possible perception that a traditional street allows to, providing a dynamic and wide reading of urban space.

#### 4.2. Analysis of Topology and Townscape

The typological analysis of the case study splits in two dominant typologies: religious architecture, where we include the church, and civil architecture, which is subdivided in single and collective housing.

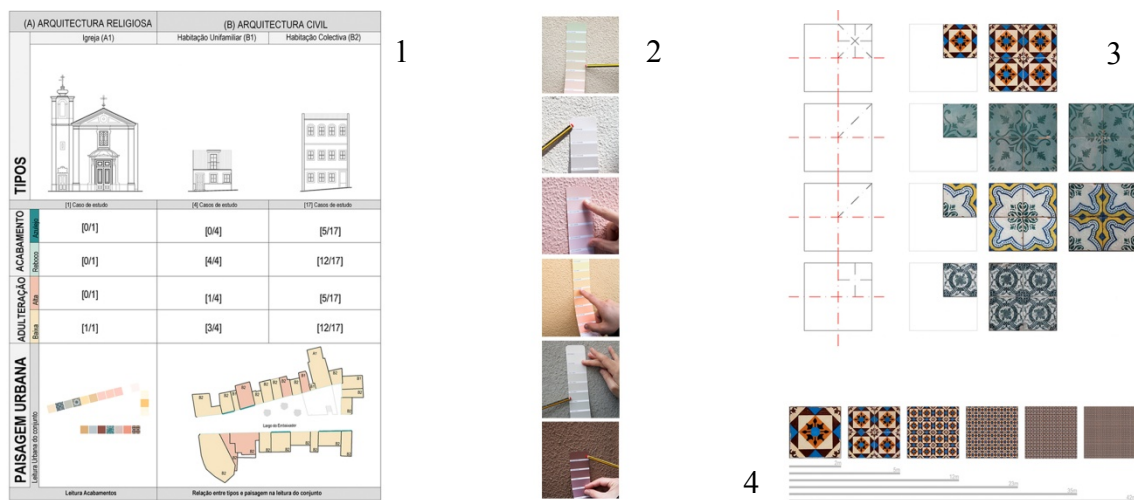

Figure 2: Analysis of the case study.

Resorting to a square rather than a street, the case study fostered the perception of buildings and global façades at different distances, enabling the analysis and exploration of the buildings covered with tiles from different point views within the square (Fig. 2, scheme 1). After the identification of the existing tiles we propose the analysis of their patterns through symmetry axis and the conjugation of modules (Fig. 2, scheme 3). With an arithmetic study we concluded that, in the limit, the distance could annul the pattern and generate a uniform tone (Fig. 2, scheme 4), but the same is not possible in this case. The colour of the other buildings was identified through a NCS colour chart with more than 1950 samples (Fig. 2, scheme 2). Its code was converted to RGB and  $L^*a^*b^*$  systems. After that, we made the cross-checks of this information with historical registration. The buildings' surface study was made through visual and tactile perception, exploring the relation between bright and matte, flat and rough. The fieldwork led us to find out that the buildings covered with tiles, in this case study, were the ones with the strongest impact on the square. We came to this conclusion considering its changes throughout the day, depending on light, and stressing the permanent character that its historical value confers to them. Its role is constant in the aesthetical perception of the square, since the existing tiles date from the nineteenth century, therefore affecting the collective memory of the square.

### 4.3. Results

We verify that in this particular case study, the buildings covered with tiles set the boundaries of the square. The buildings located in the side facing South present brighter tones, and the existing tiles have a significant white percentage. As counterpoint, the buildings located in the side facing north have darker and more saturated tones, as well as its tiles. Contrary to the general idea that North-facing side should use brighter tones, related with healthy motifs, and South-facing side might use more vivid tones, due to sunlight, we verify the inverse tendency of the more “rational” use of colour in this particular case. Even if the effect of the tiles’ colour annulation is possible, thanks to the distanced viewpoints allowed by the square organization, the presence of trees minimizes its own reflectance. Relating the size of the square and the necessary distance to obtain a uniform tone, we conclude that the distance observer-façade is not enough to have that perception. Thus, in this particular context, tiles’ chromatic characteristics acquire a new importance on the process of the experimental methodology initially proposed.

Moreover, we can perceive that, in this particular context, tile’s individual patterns’ colours can serve as a guide in the definition of colour plans. This partial conclusion is supported by the existing relation between the colours present in the tiles and the buildings with plaster coating along the corresponding side, thus allowing to establish an implicit relation between the existing and the methodology advocated. Therefore, the tile’s chromatic components are emphasized in the relation with this space, which in turn justifies the actual tendency for tonal differentiation between North and South sides in the surrounding buildings. This shows that the methodologies for elaboration of colour plans are dependent of the study of historical values, collective memory and the actual urban identity.

## 5. CONCLUSIONS

The dialectic relation on reading a tile façade – which alternates between constant and mutable elements and by the own experience of walking through space – shows that tile, although has the most changeable character concerning visual experience, it is the element that presents itself as the most constant. Tile’s technical characteristics and its resistance to interventions through time – it is important to emphasize its presence in Portugal for five centuries – explains why we propose it as an important element of Lisbon’s townscape, as well as sheds light in its historical and social value, allowing to propose tile as a permanent element, a basis and guide in the elaboration of colour plans in Lisbon.

## REFERENCES

- Almasqué, Isabel, 1989. *Azulejos de Fachada em Lisboa*, Lisboa: Câmara Municipal.
- Costa, José Manuel Aguiar, 2002. *Cor e cidade histórica: estudos cromáticos e conservação do património*, Porto: FAUP.
- França, José Augusto, 1997. *Lisboa: Urbanismo e Arquitectura*, Lisboa: Livros Horizonte.
- Freitas, Eduardo [et al.], 1993. *Lisboa freguesia de Belém*, Lisboa: Câmara Municipal.
- Arquivo Municipal [et al.], 1990. *Bellem Belém: Reguengo da Cidade*, Rio Tinto: Edições Asa.

*Address: Laboratório da Cor, Universidade Lusíada de Lisboa,  
Rua da Junqueira 188-198, 1349-001 Lisboa, PORTUGAL  
E-mail: labcor.lusiada.lis@gmail.com*

# Environmental Colour Assessment and the Creation of Local Palettes

Jem WAYGOOD  
Waygood Colour Associates

## ABSTRACT

Designing with colour for the exterior environment is little understood in the UK. New building developments at the higher end are subject to international architectural trends, and in the mass market by the marketing campaigns of the large paint companies. The result is a more homogenised environment with a dispiriting similarity between towns and cities that are miles apart. The UK however, despite its modest size is a country of great variation and regional distinctiveness. Environmental colour assessment builds on that distinctiveness by developing colour palettes for exterior application that relate strongly to the indigenous and unique colours of different parts of the country, such that new developments feel fully grounded within the context of their site.

## 1. INTRODUCTION

The United Kingdom is a country characterised by diversity: complex underlying geology and powerful geophysical forces have created wide ranging scenery, modified through intensive land use and dense patterns of human settlement. Physical differences across the country are matched by cultural ones expressed through local customs and folklore, ethnicity and language, accent and cuisine, to name but a few. Whilst cultural differences are tolerated and even celebrated, physical variations seem much less acknowledged, particularly in the case of new building developments. Genuine vernacular expression in architecture seems to have ended in the the early twentieth century, and certainly since the demands of post war reconstruction, the emphasis has been focused more upon the economies of scale through standardisation, rather than tailored response to the particularities of a locality. Add to this the advance of global economics and the need for universal brand recognition turning every high street into a clone of itself, and the spread of homogenization can be clearly seen. My practice has been in some small way to challenge this trend and restate the importance of local identity through the design of colour palettes for external finishes derived from the locality. This process is termed environmental colour assessment.

## 2. METHOD

Environmental colour assesment, (ECA), is built upon the principle that colour is never seen in isolation to its site. Analysing and documenting existing or indigenous site colours therefore provides the context against which imported colours will be seen. Using this information to develop new colour palettes establishes a dialogue between the environmental intervention, be it building development or highway infrastructure, and the locality in which it is based. Whilst this process does not guarantee seamless integration it does at least acknowledge that not everywhere is the same. Environmental colour assesment is a logical and disciplined approach to colour design, and it is also a highly flexible and creative tool.

The study area, whether it be an individual site, a town or a region, is first divided into areas of similar character as a way of understanding its make up. Characterisation may be

broad or fine, depending upon the the sensitivity of detail that is required. Each character area is intensely studied both within the area and from its zone of visual influence to identify its main colour range and its dominant tonalities which are recorded using the NCS (Natural Colour System) as a means of classification. Site observations would typically involve a range of viewing distances and light and weather conditions, and, if the timescale allowed, differences in seasonality. As well as gathering colours from the character area, research is also undertaken into any significant cultural or historic facts that may influence local perceptions and expectations for the area. From this data a synthesis of key indigenous colours is collated and from which the process of palette development can take place.

If the purpose of the commission is to produce a palette design for a specific building or development then the design process can immediately address known elevations and frontages etc. Using the data and the NCS spatial colour model, a palette of linked colours can be derived to relate the form of the building to its site context. If however the commission is to be used as a regulatory tool to guide future development, then the palette will be more general in its recommendations for application. In these circumstances groups of related colours will be identified for different aspects of a typical building facade: integration colours with which to treat the main elevations, complementary colours for accent to particular features, harmonising colours to achieve balanced harmonies, colours with increased or decreased chromaticness for emphasis to detailing and tonally responsive greys for linking disparate architectural elements. Coloured surfaces, particularly when seen in the middle distance always seem brighter and lighter than the colour sample seen in the hand, this effect is countered by selecting duller colours for the palette. The completed palette for that character area is laid out as a series of colourways allowing the user to select those elements of that colourway which relate to his building or development, confident in the knowledge that the inherent relationship between elements of the colourway will always work.

### 3. APPLICATION OF ECA

The modulation of colour and effect is made possible by the rigor with which the NCS is laid out. Locating indigenous site colours within the three dimensional colour space according to their hue and tonal value allows the designer to locate all other related colours. By introducing various design criteria, colours may be selected for application to achieve different results in relation to the site: buildings may advance or recede, appear larger or smaller etc. Environmental colour assessment provides the conceptual framework, NCS facilitates the creative freedom. Palettes developed in this way still provide users with a sense of personal choice, but within the guarantee of the designed range. Sequencing colours along an extended length of townscape is of course more complex than specifying colours for an individual building, but it also offers opportunities to work with the broader urban form. Colour, tonality and saturation can all influence the legibility of urban form and affect how people interact with it. Colour planning on this scale has certain similarities with musical direction, with the designer/director modulating the tempo, texture, warmth and resonance of the complete work. Despite the creative potential of working at this scale, there are few good examples in the UK. Architects, designers and planners, confident in their abilities to work with scale, form and proportion, often struggle when it comes to colour. Regulatory bodies charged with assessing the suitability of development proposals, rely heavily upon previous precedents when commenting on finishes, often perpetuating the problems of the past. What is lacking is a body of evidence to provide a more coherent and authoritative basis for commenting upon colour choice, environmental colour assessment helps to fill that void.

## 4. CASE STUDIES

The following projects illustrate some of my work in developing ECA

### 4.1 The Colours of Mann, ECA for Douglas and its surroundings, Isle of Man

This work was commissioned by the Douglas Development Partnership as one of a series of multidisciplinary studies to regenerate the retail heart of the town. Most of the four storey rendered buildings which made up the main shopping thoroughfare, were painted in grey or cream, and though the area was actually composed of three streets the effect was the same throughout. The colour plan identified three groups of colours for each of the three streets: earth colours, sea colours and sky colours allocated in relation to the position of the streets, between cliff face and sea. Research into these indigenous colours was augmented by research into the collection of seascape and landscape paintings held in the Manx National heritage Museum, and from this data palettes were developed for each of the three areas. The colour plan is now in operation with building owners offered incentives to use the palette to achieve the vision set out in the plan.



Figure 1: pages from the sea palette, Isle of Man study.

### 4.2 Blackburn with Darwen Borough Council, Colour Atlas



Figure 2: Pages from the Blackburn colour atlas.

This project originated from the preparation of a supplementary design guide to the Local Development Framework for the borough. Five character areas were designated and palettes developed for each area. The most sensitive area was the junction of the urban edge with

the Pennine landscape, where low grade out of town development in the form of distribution warehousing was damaging the definition of the town boundaries. Blackburn developed in a valley bottom with most approaches to the town from the hills giving aerial views of the settlement. Whilst a considerable amount of building had taken place, the Council now had a document in place which would moderate future development. The colour range of the Pennine landscape was studied in detail to provide the developed palette for this character area.

#### 4.3 Ty Mawr Book of Colour

Ty Mawr is a specialist Welsh company who offer sustainable and environmentally friendly building materials and building systems. A significant part of their business is the sale of breathable paints: limewash, silicates and plant based resin wall paints, As well as caring about the make up and nature of the paints, Ty Mawr also wanted a colour range that had an identifiable provenance, and felt the process of ECA would offer them a unique approach to creating a colour collection. The Welsh landscape was selected as the source of the colours, and this was divided into mountain colours, coast colours and valley colours. Using the NCS colour space a collection of some three hundred colours set out in colourway suggestions has been produced.

### 5. CONCLUSIONS

Environmental colour assessment offers a responsive and sensitive approach to colour selection. It celebrates local distinctiveness and diversity and supports the idea that people enjoy the differences in places rather than the similarities. It also elevates colour preferences from matters of taste or style into the area of design, a discipline with rules, to be followed (or broken) in the full knowledge of cause and effect.

*Address: Jeremy Waygood, Waygood Colour Associates  
Kent Cottage, Blakeney Hill, Blakeney, Gloucestershire, UK. GL15 4BS  
E-mail: [jeremy.waygood@btinternet.com](mailto:jeremy.waygood@btinternet.com)  
[www.waygoodcolour.co.uk](http://www.waygoodcolour.co.uk)*

# Light and Colour as the Genesis of a Daily Metamorphosis: NIGHT AND DAY in Urban Landscape Perception

João PERNÃO

CIAUD - Research Centre for Architecture, Urban Planning and Design  
Faculty of Architecture, TU Lisbon, Portugal

## ABSTRACT

The city is a complex texture of happenings, derived from human needs and wills. This network, a multitude of single life's intertwined in a 24-hour cycle, keeps cities alive, but with huge differences in the way its inhabitants live and feel the experience of day and night. These two sides of the same coin coexist but usually with no sense of continuity concerning urban landscape perception. Most of the times there is a complete metamorphosis from day to night, with different outputs in meaning and emotional atmosphere perception. Colour and light are the two main actors in this act of transfiguration. This paper aims to define parameters for a better knowledge of day/night urban space perception through colour and light analysis, and how it can promote continuity or difference, tensions and even complete transfigurations, taking as case study the city of Lisbon, Portugal. The conclusions state the importance of the day/night differences in urban perception, suggesting the necessity of include this line of research in the strategies of urban planning, for a better continuity, unity, permanence and significance of the city memory in its inhabitants and visitors.

## 1. INTRODUCTION

Light and colour are the key elements for our emotional response to any space, and therefore to the urban space. Is through light and colour that we capture and preserve visual memories, allowing our orientation. But day/night perceptions are completely different and could convey conflicting outputs for the citizens. For instance, colours and skyline are references in daylight, but could be completely lost at night (Figure 1).



Figure 1: The red chimney, the skyline and some strong colours disappear into the night.<sup>1</sup>

1 All photos by Margarida Dias (margarida.dias@mac.com)

## 2. METHOD

For this study we define various viewing points in the city of Lisbon, always at street level, considering their importance for the recognition of the city identity. Two photos were taken for each site, one in the afternoon (5 to 7 pm) and one at night (10 to 12 pm).

We used a free open-source software (*GIMP*) to apply a filter (*Edge Detect*) that recognizes differences in the picture colour areas in order to “draw” a black and white image (placed beside each photo here presented). Differences are the source for our perception, as we know, and therefore this process could simulate, and clearly demonstrate the day/night transfiguration in the urban space perception.

## 3. DAY/NIGHT DIFFERENCES IN URBAN LANDSCAPE PERCEPTION

Based on our research we have established eight parameters for urban landscape analysis concerning light and colour perception:

- a) *Scale*: We deal differently with city scale in the dark/light cycle. Night illumination tends to emphasise the lower and commercial part of the buildings conveying a minor scale in street perception (Figures 2 and 3).
- b) *Visual structure and rhythm*: In daylight colour assumes a leading role in defining the visual perceptual structure of urban landscape. With the night comes a shift towards texture perception, and artificial light rules and defines rhythms and the whole visual field (Figures 2 and 3).



Figure 2: At night, artificial lighting defines new rhythms and another scale.



Figure 3: The presence of colours is replaced by the presence of artificial light at night.



- c) *Aesthetics*: Colour represents an aesthetical choice in the city appearance, a private statement in the whole city puzzle. But at night, the municipality lighting turns all more equal and democratic while colours are subdued by the obscurity. Commercial signs and colours with their own brand aesthetics rule the city (Figure 3).
- d) *Comfort and safety*: Colour gives visual comfort in city perception in daylight, but in the night-time, light gathers people together, celebrating the sense of community opposed to the unknown and dark “outside”. Light is safety (Figure 4).
- e) *Identity and Continuity*: There is a general lack of unity between day/night city perception, even turning hard to recognize some places in this variation. At night the buildings surfaces, depending on artificial light, appear to us as incomplete glimpses of significance, appealing to our memory to build a whole that could be connected with daylight memories. The building outlines are disrupted at night due to uneven lighting (Figure 5).
- f) *Way-Finding*: References are different in the day and in the night: strong colours like the ochre and reds on the facades, the red from the ceramic roof tiles, the green from the trees, all disappear in the night. But we are able to recognize some lighted references that punctuate the night, like the monuments (Figure 5). Monuments have an important role in maintaining a recognizable structure in space perception bridging day and night.

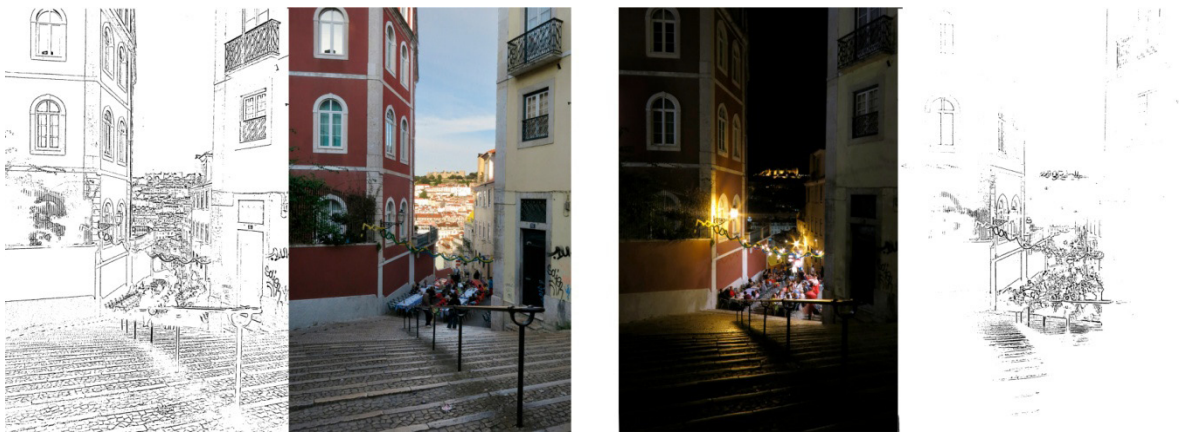

Figure 4: Colour gives references in daylight; light brings people together at night.

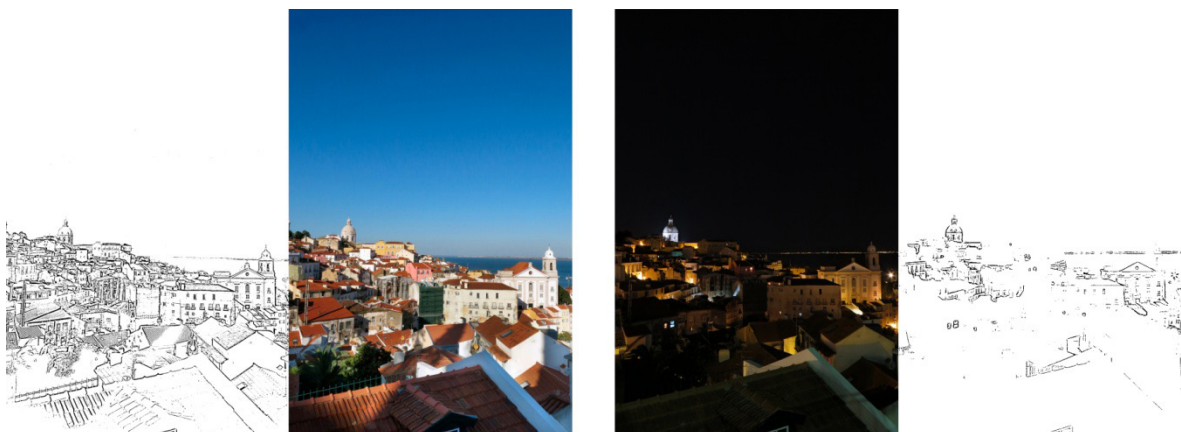
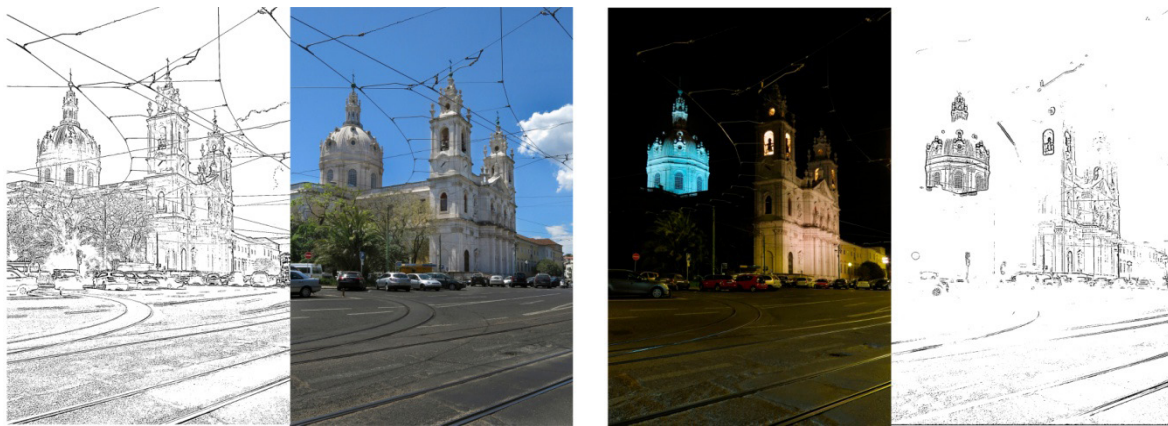

Figure 5: Skyline is lost, colours are gone, but monuments keep the day/night continuum.

- g) *Adequacy in morphological, typological, historical and cultural meaning*: This is an important issue that should be of concern when lighting historical buildings and sites. Important cultural testimonies and landmark references, monuments are many times illuminated at night in a “commercial” way, as if they are using cheap cosmetics to sell

themselves better, with lights downward up, contradicting centuries of architecture design and craftsmanship which took into account that light always come from above. Others are illuminated with no respect for the identity and unity of the architectural object, undermining his perceptive reading through unnecessary differences in light intensity and color temperature (Figure 6).

- h) *Exterior/interior space*: Artificial illumination frequently contradicts the daylight relationship of inside/outside and private/public. At night we can see private office buildings illuminated from the inside in a nonsense practice, void of any functional goal. On the contrary, we see important public spaces like gardens that constitute places of permanence with meaningful colour presence, closed and dark at night. Reflecting façades during the day become transparent with artificial lighting revealing the entire interior.



*Figure 6: A wrong lighting affects the perception of the architectural unity.*

#### 4. CONCLUSIONS

Each city has its own identity, and should be remembered as a complex whole in its different levels of understanding. With a planning that does not take in account the image perception level, based on light and colour perception, we are contributing to divide its meaning as an entity, resulting in the mental idea of two different realities in one place: night and day.

Monuments and heritage sites should be studied in order to preserve their fundamental characteristics throughout day/night changes, namely with a better and more consistent illumination at night.

The importance of day/night differences in urban perception, stated in this research, suggest the necessity of inclusion of this concern in the strategies of urban planning, for a better continuity, unity, permanence and significance of the city memory in its inhabitants and visitors.

*Address: Prof. João Nuno Pernão  
Faculdade de Arquitectura, Universidade Técnica de Lisboa,  
Rua Sá Nogueira, Pólo Universitário do Alto da Ajuda, 1349 -055 Lisboa, Portugal  
E-mail: jnpernao@fa.utl.pt*

# The Chromatic Identity of the Ancestral Architecture of the Ksour of Bechar

Racha GHARIRI

Department of Civil Engineering and Architecture, University of Mostaganem-Algeria

## ABSTRACT

In this paper I present a part of my research on the colors of the city of Bechar (Algeria). It is about a chromatic study of the ancient architecture of the Ksour. Being a subject of intervention, regarding their degradable state, the Ksour are the case of my study, especially that the subject of color does not occupy, virtually, the involved on these heritage sites. This research aims to put the basics for methods which allow to know what to preserve as a color and how to do so, especially during a restoration, and to understand the evolution of the chromatic state of the city.

## 1. INTRODUCTION: PRESENTATION OF THE CONCEPT “KSOUR”

Bechar is a city of the Algerian Southern, situated at 950 km to the south-west of Algiers, the Ksar (local pronunciation “gçar” which means a village consisting of an inhabited part and a territory. It is the place of the typical ancestral agglomeration of Saharan cities. A set of “gçûr” (pl. of gçar) form an entity with the same generic toponym, it is what is known as an oasis, a term which does not, paradoxically, have an equivalent in the local dialect. The inhabited part of the Ksar is surrounded, generally, by a “çur” (wall) Figure 1.

Bechar contains several Ksour in the city and in the suburbs (Taghit, Mougheul, Lahmar, Kenadsa ...), but, unfortunately, they are almost all in a degradable state, so that, they are in a permanent restoration. But the methods used to restore them require thinking, because some interventions do not seem to respect the nature of these constructions, concerning materials and the original construction techniques, not mentioning the colors!



*Figure 1: A view of the Ksar of Taghit (One of the Ksour of Bechar).*

## 2. THE CONCEPT OF “MEMORY COLORS”

The colors are a means of communication that reflects emotions. Their role in architecture goes beyond the simple decorative application, to achieve goals that tend to transform the

architectural space and create its identity (2). The notion of “memory colors” Proposed by J.P. Lanclos ensures that the geographical feature of a site products the regional color palette through a complex interaction of several factors. Those regional colors are important chromatic features and prominent aspects of the site’s identity, a patrimony.

On the other side, in her book “chromo-architecture”, M.P. Servantie, tackles the issue of the use of colors in architecture. She presents four attitudes which are necessary to build using colors: camouflage, integration, development and neutrality. These attitudes depend on the nature of the site and the building, in addition, to the intention of the architect.

The architecture of Bechar is an earth architecture based on a know-how inherited by generations, an architecture linked to the culture and the traditions. That’s why the situation of the tonal dominants of the Ksour, regarding the concept of memory colors and their chromatic attitude, seems very useful to define the chromatic identity of the city.

### 3. METHOD

The basic concept of my research is “the memory colors” but this notion seems complex: on the one hand there is “colors” and on the other there is “History”. The aim behind the used methodology is to determine the complexity of this concept objectively. For this reason, several methods are used in parallel, which I can classify into two main categories:

The first one is all about history, culture and sociology. The second, which itself consists of two sub-parts: the first is rather technical; it deals with construction techniques, the used local materials, the typology of the building and the light. The second is based on the observation that allows us to understand the chromatic nature of the environment of the Ksour.

Concerning the historical, cultural and sociological analysis, the goal was to understand the origins of the architecture of the Ksour and the circumstances of their birth and their implementation. I used the consultation documents stored in the local authorities and some academic, works already established that deal with this subject. The sociological methods of analysis (surveys) are used to understand the vision that people have towards the colors and determine their chromatic culture. For that purpose, I conducted surveys on people in different Ksourian sites from different categories of age to answer questions that revolve around the chromatic culture and symbols of colors for these people.

This socio-historical analysis was complemented by a typo-morphological study of the concerned sites. It allowed me to classify these constructions according to their forms and architectural character, regarding, their construction techniques throughout history. This study also allowed me to understand the philosophy of light in the Ksour.

As an earth architecture, based on a local know-how, the chromatic aspect itself is the result of the use of local materials. In this context, it was necessary to have a fairly broad idea of these materials and their employment techniques. In this domain, there have been numerous laboratory studies established at the University of Bechar by specialists. These studies archived were of a great support for my research.

The study of the chromatic nature of the Ksourian environment was conducted through the analysis of the geography of the concerned sites, natural features and climatology. It was supported by the observation to determine the natural chromatic character of these sites in order to locate the attitude that the Ksour take in their environment on the scale ranging from camouflage to neutrality, previously presented.

#### 4. RESULTS AND DISCUSSION

As a result of the historical analysis, the Ksar is always in the downstream of the hydraulic path. For obvious reasons of “water saving” the housing part of the Ksar is always located in the upstream, allowing the water to serve domestic needs first before reaching the culture zone. When the territory is able to grow to accommodate the population increase, the Ksar multiplies. Another “neighborhood” is then juxtaposed to the first one and so on until the capacity of the region comes to a limit. At that time, another oasis develops further with its Ksar that could call for others, which, seen from the air, gives to the oasis habitat that insular aspect surrounded by a wall.

In architectural terms, the type of homes is quite simple. Rooms are built around a courtyard. One of these rooms is without a roof and acts as a kitchen. The Space is hierarchized, so that, the corridor is limited to one person inside the Ksar, for privacy reasons: the space in the Ksar is only explained to his habitants. For the same reason, the light is hierarchized, a strategy is installed to keep the foreigner’s eyes away, inside the Ksar, in the streets serving the houses, the light is almost absent, houses’ windows overlook the courtyards, often white niches for lamps are dug into the walls. Foreign person who is outside, where the light intensity is important, lose vision for a few seconds once inside the Ksar. This attitude is also applicable on the colors, depending on the surveys I conducted: Ksourian people consider bright colors as elements that attract attention.

The main building material is the “Tub” a kind of solid brick made of local clay. The stones are also an essential material. The use of wood is limited to doors and windows because it is rare in the region; it is sometimes replaced by palm trunks that serve as beams “khashba”. The ceilings are made of wattle palms “jrid”. The walls are relatively thick and covered on the outside with a coating consisting of clay pellets. The resulting surface is very irregular and creates shadow zones that keep the freshness. The facades are in most cases left in their natural state without being colored, but the doors, windows, niches and rare decorative elements are highlighted with white lime paint.

Regarding natural colors, Bechar is a deserted city where the sky is often clear. In the summer, the blue of the sky is very clear because of the intense sunshine, in the winter the blue is less saturated, and the sky is rarely cloudy. The dark days are rare. They characterize the days of sandstorms where the sky is blue-red and the rainy days where the blue sky is less saturated. The palms are the most important type of the vegetation of the city which often gives a less saturated green. The landscape surrounding the Ksour is characterized by yellow ocher of dunes but the red ocher earth characterizes some areas.

#### 5. CONCLUSIONS

From the results of the analysis I have done on several levels, I can deduce that the chromatic character of the ancient architecture of the Ksour which defines the chromatic identity of the historical city is closely related to two main factors: the inhabitants’ culture and the geographical nature of the site. These two factors play an important role for other secondary factors to come into play, such as construction techniques and materials of which the color dominates the landscape. These factors are themselves conveyed by the inhabitants’ culture and traditions.

The nature of the landscape determines a limited regional palette, so that the Ksour are born in a naturally poor environment of color. They are built by people who culturally be-

lieve that the color artificially added to the building is an element of attraction which should be avoided, and prefer to remain discreet. This is what creates an attitude of camouflage approved and supported by the materials directly coming from the environment.

Finally, we noted earlier that the solutions applied to restore this type of construction do not take into account several characteristics of the constructions which obviously generate an ignorance of the values hidden behind the colors. Thereby, the restoration directly affects the chromatic identity of the Ksours which is the result of a delicate interweaving of all these cultural and natural factors which reflect the own lifestyle and the way of thinking of the inhabitants.

#### REFERENCES

- Servantie, M. 2007. *Chromo-architecture : L'art de construire en couleur*. Paris: Edition Alternatives.
- Lenclos, J., and D. Lenclos. 1999. *Couleurs du monde: géographie de la couleur*. Paris: Le moniteur.
- Bonte, P. 2006. Abderrahmane Moussaoui Espace et sacré au Sahara: ksour et oasis du Sud-Quest algérien. *L'Homme* (177/178): 529-532.

*Address: Mme Racha GHARIRI, Department of Civil Engineering and Architecture  
University of Mostaganem-Algeria (27000)  
E-mail: master\_racha@yahoo.fr*

## Colour goes 3D

Veronica BRUSTOLON, Roberta DE MONTE  
Faculty of Architecture, IUAV University of Venice

### ABSTRACT

The use of colour undoubtedly identifies and defines an object or a space and is often one of the main elements for the development of an architectural project. Colour is taken into consideration in conceiving and realising every architectural project since it is an inevitable presence in everyone's life. Therefore, the choice concerning the envelope is of key importance both in terms of architectural language and environmental quality.

It is interesting to note how the colour applied on façades is now considered as a “designed” colour, a means of expression, separated from the rest of the building both in terms of culture and use and requiring a specific design, since it is deeply related to people and the surrounding environment. Nowadays colour is one of the main elements in designing new architectural envelopes. It is used to convey a specific message or as part of a certain layout, becoming a distinguishing feature of the surrounding area. Precisely by using light and colour on the architectural envelope of d'Ancap s.r.l., an internationally renowned chinaware manufacturer, it was possible to give the company a new identity, renovating both its look and function.

### 1. INTRODUCTION

“Man needs colour to live, it is just as necessary an element as water or fire”.<sup>1</sup>

This statement, true as ever, by the painter Fernand Léger was rediscovered by Le Corbusier in the 1930s. At that time, he was paying a special attention to the study of colour and of its use in art and architecture. Even one of the masters of rationalism and the Modern Movement, who placed the importance of form's purity before anything else, was perfectly aware of the weight of colour in architecture. Our existence, our lives flow in environments and spaces constantly immersed, soaked up in colours that change in a continuous motion, through the passing of the day, the flow of sunlight. This is an aspect that is often forgotten, neglected, but if we think about it even for a moment, it is almost impossible to imagine a life in black and white.

“Colour is constantly present in everyone's life: when we are awake or sleeping, when there is light, that produces colours, or when we are in the dark.”<sup>2</sup>

For every human being colour basically means perception, feeling: the eye detects a certain shade, which is redefined by the brain resulting in impressions and emotions. Artists and painters were the first - always ahead of the others - to try to theorise and analyse the colour, to understand the importance of the study and teaching of this particular matter. One of the first artists to do this was Delacroix: in *Les Artistes de mon temps* he wondered why the analysis and principles of the colour theory were not taught at art and architecture schools since it was clearly obvious that: “Colour is life, for a world without colour seems dead. [...]

1 A. Ruegg, *Le Corbusier: Polychromie Architecturale – Le Corbusier's Color Keyboards from 1931-1959*, 1997, Arthur Ruegg

2 P. Zennaro, *Colore e luce in architettura: fra antico e contemporaneo*, 2010, Knem-esi Edizioni, Verona

As a flame produces light, light produces colour. [...] Light, the first phenomenon of the Universe reveals, in the colours, the vital spirit and the soul of our world.”<sup>3</sup> However, it seems obvious that analysing and assigning colour a category in a scientific and objective manner is difficult, since it involves both the physical and mental spheres. Therefore it requires a specific and accurate study. In his book *Art of Color*, Johannes Itten himself admitted that, in an attempt to analyse colour and formulate the relevant principles, poetry vanishes leaving only the brute matter behind.<sup>4</sup>

Architecture is undoubtedly one of the fields in which colour developed at a faster pace playing an increasingly important role. As a matter of fact, it allows the identification or definition of a space or object, as well as the restoration of any environment, giving it a new life. In contemporary architecture projects, in particular those by Jean Nouvel, Sauerbruch & Hutton or UNStudio, colour is playing the leading role, being it the best ally in creating envelopes increasingly more effective and evocative. Moreover, colour, together with the new lighting technologies, is becoming a means for urban redevelopment; an essential method to bring abandoned and dismissed architectural constructions back to life.

The Sports and Leisure Center in Saint-Cloud by KOZ Architectes is a perfect example of this: it is significantly different from the surrounding buildings featuring a clear Haussmanian style. The main façade, in fact, is characterised by a series of laminated glass sheets, in wide bands, with lively and flashy colours, a palette ranging from red to green, yellow, pink and orange. Inside, the same colours are systematically repeated, so as the different internal areas can be identified also from outside: a means to help even the younger kids to find their way.

## 2. THE PROJECT

Starting from this new design approach, which does not have only aesthetic and superficial purposes, but it can also bring about useful results in terms of structural and energy redevelopment; we conceived the project for the new envelope of d’Ancap plant, a mix between a modernist white and a bright palette full of light. d’Ancap has been producing chinaware since 1964, strengthening its position on the Italian market and at international level: it is the second largest company in Italy for ceramic objects. The building includes a production area of 20,000 sqm, where approximately 170 professionals are employed; it is surrounded by soft green hills and located close to the railway line connecting Verona and Milan.

The project involved the construction of a new envelope and the design of an acoustic and anti-dust barrier to limit the noise generated by the high-speed and freight trains on the nearby line. The design aim was to provide the company with a clear identity and visibility, both from a design and communication point of view, while respecting the integration with the surrounding landscape. Therefore, the study and the application of colour and lighting systems were crucial, as they were the only elements that could be used to characterise the work, defining it in the context. Moreover, we wanted to transfer on the building façades the curvy and sinuous profile of the surrounding hilly landscape. There are, however, other cultural and design references to the works of great design masters, in particular the work of Achille Castiglioni for the “Bavero” line that he designed for Alessi.

3 J. Itten, *The Art of Color: the subjective experience and objective rationale of color*, 1974, Revised Edition

4 J. Itten, *The Art of Color: the subjective experience and objective rationale of color*, 1974, Revised Edition



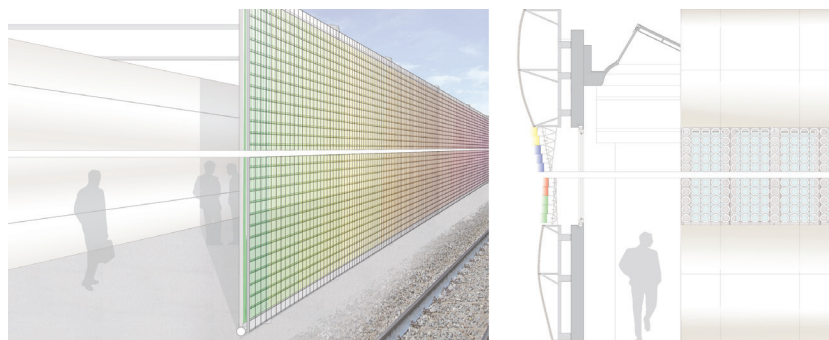

Figure 1: The acoustic barrier (on the left), section and prospect of the new façade.

The entire building was then wrapped in a white ceramic ‘veil’, interrupted only at plant’s openings, such as doors, gates and windows. The curved ceramic panels, creating the new façade profile, are to be manufactured directly by the company in order to facilitate the production of the new envelope. The panels are mounted on a stainless steel frame made from tubular cantilever elements welded unto the uprights. This structure is then fixed to steel profiles, directly anchored to the existing concrete panels. The panels are drilled through the thickness and milled along the lower and upper parts, where an L-shaped metal element, previously welded unto the tubular elements, was inserted. The shell extends beyond the façade top line, bending horizontally to partially cover the roof and provide continuity. We opted for white right from the beginning since the plant building is extremely long, yet not high: a neutral colour could easily adapt to the surrounding context and serve as a base for the subsequent study of lighting. The company visibility was another key issue: this made, therefore, necessary to reproduce on the façade the products realised by d’Ancap, whose main distinguishing feature is an absolutely pure white.

## 2.1 The natural and artificial lighting system

The white ceramic shell is interrupted by a continuous horizontal band at the openings to maintain the plant natural lighting level. A filter was installed next to the windows to allow the light to pass through: it consists of a perforated mesh, made by connecting a series of ceramic cones placed perpendicularly to the envelope. Each cone features side flaps. A metal wire passes through them and is attached to the brackets that support the ceramic panels. An RGB LED strip is installed in each conical element, to provide greater visibility to the company at night. The electronic lighting system is programmable via dedicated software to allow for the realisation of colour light games, graphics or texts. This leads to a sort of dynamic contrast between the white of the curved ceramic panels and the coloured effects created by the RGB LEDs placed inside the cones. Colour and light thus become two inseparable elements: the light turns into colour and the colour is defined by the light that can also be used to convey particular impressions, emotions and feelings. Therefore, while, during the day, the white highlights the building, making it stand out in the landscape, it becomes a perfect stage where the lighting system can play the leading role at night, reproducing any colour shade.

## 2.2 The acoustic barrier

As far as the design of the acoustic barrier is concerned, we opted for a tubular metal structure which also serves as gate while limiting the noise produced by the adjacent railway line. The load-bearing structure consists of crossbars and uprights, made from tubular steel

elements, which support a two-layer glass panel featuring a sound absorbing interlayer. The outer glass pane is silk-screened with a graphic design inspired by Optical Art works, in this case a work by Marcello Morandini, a prominent figure of this movement. We chose this movement as it is primarily based on the creation of optical illusions through the combination of particular abstract subjects or the use of colour. Optical Art, which is often included in the wider movement of kinetic art, is essentially a graphic type of art, based on the rigorous definition of the operating method. The artists want to achieve an effect that induces perceptual instability by placing lines in modular and structural grids. In this way, they involve the observer. Our aim was to create a double perceptual effect thanks to the colour dynamism obtained by combining the movement of the train and the optical effect of the graphics. In fact, the glass sheet is actually a mirrored design, a colour scale that goes from the outer part of the barrier to the central part, from the highest point back down, thus creating an image which is animated only through the eyes of the passengers.

Another structure, consisting of a metal grid on which matt plastic square elements were hung fluctuating with the movement of air caused by the trains or simply by the wind, was installed in front of the barrier. In this case the user plays therefore a role similar to a passive spectator, who can only observe the transformations that take place on the envelope, without intervening directly. The project, as a whole, can be deemed to have a communicative value thanks to its ability to convey messages, feelings and emotions.

### 3. CONCLUSIONS

Colour becomes a rather important aspect in our everyday life, an intangible value that affects everything around us. In the architecture field, it can expand and emphasise spaces, define individual elements as well as become part of the work itself: not a simple ornament or surface finishing but an actual architectural language. Almost a structural component as any other material: it can modify the way space is perceived, influence and interact with users and arouse feelings. As a great art historian, Rudolf Arnheim, said: “Colour is always tied to the context in which one operates: spatial, historical, cultural and, of course, psychological.” And this applies also to the project proposed for the environmental, technological and architectural redevelopment of d’Ancap: Both colour and light became an integral part of the construction, privileged tools to communicate with the surrounding environment and even subjects of the redevelopment intervention.

### REFERENCES

- Arnheim, R., 2004. *Art and Visual Perception: a psychology of the creative eye*, University of California Press.
- Gasparini, K., 2009. *Design in superficie*, FrancoAngeli.
- Zennaro, P., K. Gasparini, 2010. *Colore e luce in architettura: fra antico e contemporaneo*, Knemesi Edizioni.
- Ruegg, A., 1997. *Le Corbusier: Polychromie Architecturale – Le Corbusier’s Color Keyboards from 1931-1959*, Ruegg Editor.
- Itten, J., 1974. *The Art of Color: the subjective experience and objective rationale of color*, Revised Edition.

*Address: Veronica Brustolon, Faculty of Architecture, University IUAV of Venice,  
Via Sottorogno 14/c, 32012 Forno di Zoldo, Belluno, Italy  
E-mails: veronixarch@hotmail.com, roberta\_de\_monte@hotmail.it*

# Colour Injection in Vessels of City

Mahmood MAZAHERI TARI  
Formino Art & Design Studio

## ABSTRACT

The contents of this paper are part of an ongoing research about thematic of street art and graffiti and different aspects of art in underground space in modern communication. These serial researches started five years ago as a theoretic part of my dissertation in Tehran University.

This article as a section of my serial researches about, regards colourful presence of graffiti and street art and its visual effects as a principal side of this modern social phenomenon. It is a dialectical comparison between graffiti artworks and other aspects of art and design in colour utilization. In this paper I survey main reasons of graffiti grace and try to find a rational relationship between visual tastes of mankind and this modern appetite. Finally I regards to graffiti in different cultures specially in eastern countries and focus on effects of persian culture in colour harmony in iranian graffiti.

Keywords: graffiti, street art, colour harmony, multicolour stratum, colour schemes

## 1. INTRODUCTION

Most of us have visual experiment in modern cities and metropolitans similarly. Speculative advertisements cover everywhere from store shelf to facade of buildings in high quality, and use advanced level of communication knowledge and high technologies to attract passerby's attention collaboratively. Against this repetitive situation, there are erratic images everywhere which create an ambiguous atmosphere and cover urban spaces by their forms and colours bizarrely. This multicolour stratum which elongated over modern cities by unknown inventors named graffiti.

When we speak about graffiti we are confront with a broad term that encompasses different meaning from vandalism and anarchy to an aspects of art and design. As a modern phenomenon, graffiti by its related cultures, various techniques and especial styles cause widespread impacts in today's society and as an arguable subject provokes strong reaction in governments and various viewpoints in theoretic fields of humanism, philosophy, psychology, sociology and art.

As a complicated form of art, graffiti or street art has an especial usage of colour and new approach in colouring. Questions arise; What graffiti artists really seek? Is it an anarchistic reaction against neutral feature of cities? How they plan their colour harmonies in their large format pieces? What is their principal in colouring? How they identify these special colour schemes? What are differences between city advertisement and graffiti, especially in colour usage for their results achievement?

## 2. FIRST STORY

I remember a dark midnight after a dinner gathering; I was walking to home with a great guy in a street of Tehran center. After awhile in a corner of a crossing, we saw a tragic scene. A soothsayer; sad little girl was sitting in sidewalk, leaning on a wall under lighting and was

looking at passersby entreatingly. But when we passed it, we were shocked because what we saw. What happened? She was flat. So we look back again to reviewing it. It was just stencil graffiti on the wall.

This story is my first serious experience about graffiti for a long time in Tehran that make a simple definition for graffiti in my mind initially; a monotone high contrast stencils that shock passersby by their amazing design and define their concept briefly.

But when I started my serial researches about graffiti, especially internet searching I confronted by many photos from all over the world which showed me a whole collection of colourful writings and images that covered everywhere and make amazing space against neutral civil features without any clear concept. So I decided to research about graffiti colouring and its typicalities in different regions.

### 3. INITIAL DEFINITIONS

Graffiti artists use colours in different manners and wide spectrum. They work by manipulative tones of colour in various contrasts, extraordinary saturation, and unusual balance, to attract passerby attention and deep their observers mind in a supernatural colour scheme. Sometimes their masterpieces make an iridescent panoramas and direct viewers attention in a mystic atmosphere and strange surroundings. We can break down graffiti in two main categories as colour harmonies or colour schemes:

1. Colourful graffiti which include piece, throw up, some stickers and most big writings or other large format works
2. Index colour or refracted colouring graffiti which include almost stencils, tagging, most of stickers.

Inspiration, artist's favorites, and surroundings colours are three main factors which graffiti artists regard in colouring.

#### 3.1 Inspiration

Usually an artist choice of colour is intuitive but in graffiti it is exaggerated. Graffiti artist believe that first parameter in colouring is inspiration. Sometimes their compositions are like action painters works and especially Jackson Pollock masterpieces. Like Jackson Pollock who worked on big canvases without any easel, and used his colour palette with a certain Spontaneous technique but have a control on final composition, graffiti artist use colour to have a sovereignty over their largeformat works- especially in wild style writing- and create better composition. It seems that rebel characters follow inspiration more than thinking.

#### 3.2 Favorites

It seems that some graffiti artist has a favorite colour harmony. If you follow their work serially in a period of time, you can explore a common scheme between them. Even for some famous, you may recognize creator by colours which help you as a signature more than any tagging. But this recognizing is so complicated when you observe a crew which did a teamwork for example in a throw up on a train.

#### 3.3 Surroundings

Obviously surrounding is one of principals in graffiti and street art. Because frequently what we named graffiti known as a subcontent of another term; street art, and street is not a de-

lined space and has different feature whit various colour harmony. Graffiti artists have two different approach against surroundings in design and colouring; positive and negative.

Positive: Sometimes graffiti artist regards colour harmony of surroundings and use an appropriate scheme and create an artwork which is solvable between its space. They use this method to fool their observers to founding a work as a part of its area especialy when they want to create a virtual prespective.

Negative: In most of graffiti artworks artists tried to create a negative scheme to attract more attention and fight against their surroundings because their common anarchistic concept.

#### 4. CULTURE

These three parameter ( inspiration, favorits, and surronding) reffer us to another parameters which effect in all aspects of art; culture. Graffiti as a modern phenmenon is part of hip hop culture which effect in it all time. But as an aspects of art it is effected from different cultures in every geographic area. In this section I survey certain factors in colouring of graffiti in my city; Tehran which is capital of Iran.

In every culture, colours have a simbolic role. Certainly simboles are changable in time. Also Iran include many different subculture because its historical background and extent area and relationships between simbols are so complicated. But in almost eastern countries like Iran which culture and art based on religens; often simbols are loyal.

So colours have an important role in traditional architecture in Iran and in old street which costructed by old building you may confront by purposely usage of colours. But in Tehran as a metropolitan that developed in this hundred years, most of buldings structured on modern design.

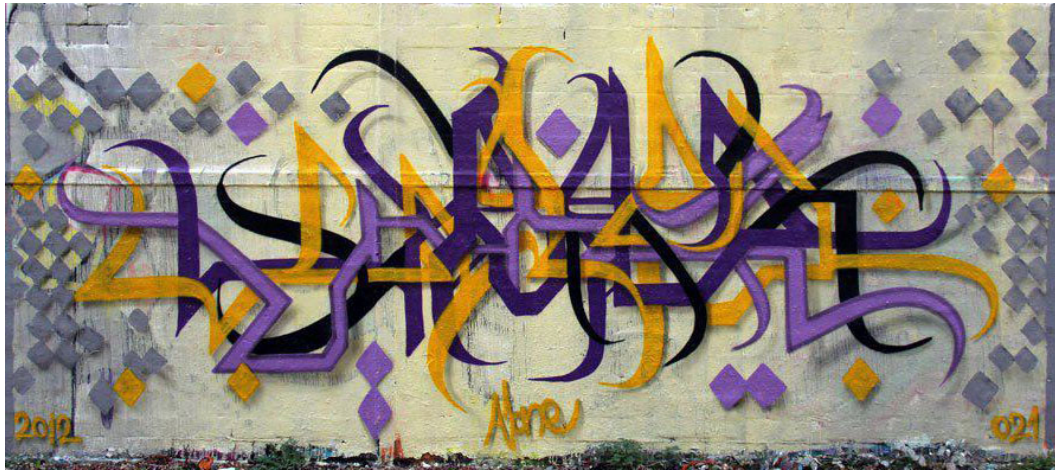

*Figure 1: Iranian stenciling.*

Most of effective graffiti artworks in Tehran are stencils or stickers and have positive aprouch against their surroundings (see Figure 1). Also Iranian graffiti artist like to leave their comments clearly on walls whitout any mystic writing. So they do public style graffiti which have not various colours or other ornamental elements like shadows or highlights in their design potentially. Accordingly most of graffiti artworks in Tehran and other cities in Iran are index colour works and have limited schemes.

It seems that Iranian graffiti focused on concept, so form and colour is last majority for

artists. But now, in this last year I observe an advanced style of persian typography in graffiti which is issueing new wave with a multicolour taste in graffiiti works in Iran and can cause a colour injection in vessels of cities (see Figure 2).



*Figure 2: new wave with a multicolour taste in graffiiti works in Iran.*

# Color and Place: New Ways of Expression in the Contemporary City

Darío SUÁREZ

Institute of Color. Faculty of Architecture, Town Planning and Design  
National University of Córdoba, Argentina

## ABSTRACT

The clear trend towards the global city, a virtual city of flows, as the expression of the contemporary city makes us focus our attention on the Urban Place and its insertion in the present urban condition. The urban exteriors display new expressive and communicative functions of color that facilitate the promotion of pleasant experiences and contribute to the construction of urban places. Light, color and sound are sensory effects with the relevance of new ways of expressions established by present technologies (Bahamón 2010).

In the unique Latin-American context, and especially in the city of Córdoba, the intervention of color is essential. The iconic-linguistic potential of color, which has been enhanced by new production ways, boosts its capacity to communicate by creating atmospheres that go beyond materiality into new perceptive dimensions. This experience of the city and the resulting promotion of urban life are very important for the production of the urban place.

## 1. INTRODUCTION

The contemporary world witnesses essential changes in the production of urban environments which are shown in its architecture. Moreover, these changes take place in the new possibilities of expression of color and the different signs that go with its perception such as cesias, chromatic contrasts and textures that facilitate a bigger variety of environmental experiences and make us reflect on the Urban Place and the context that produces it.

The new interventions related to the structure, expression and meaning of the urban place, which in some cases involve the appearance of new architectural and urban components as well as a renewed value of spaces that already exist, have as a main objective to re-value the urban environments for the enjoyment of their inhabitants and to generate experiences in the social life context.

The combined impact of worldwide events such as globalization together with the local effects of the changing social-economic and cultural Latin-American context leads us to focus our attention on the interventions and transformations that have taken place in the urban public space in the last decades, especially in the city of Cordoba, Argentina.

## 2. URBAN PLACE AND URBAN CONTEXT

The concept of urban place has changed throughout time together with the evolution of societies and the research contributions of many disciplines. Nevertheless, the close relation between the concepts of urban and existential space (Norberg Schulz 1975) proves that the perceptual expression of the city and its places matches the ideas of city throughout time.

This is shown in the leading roles of different components which, according to the perception of each historical time, are predominant. Consequently, every place or net of places in the city is the result of their previous history.

At present, the issue of public space and place is considered a priority. The present debate explains different perspectives. The urban condition is presented as an ideal kind of city connecting the physical-spatial with the mental-imaginative. On the other hand, the new technologies, communications and global deals place flows before places, dividing the city between hyper-mobility and stagnation. This meaning of urban city is expressed by the so-called global cities (Mongin 2006).

In this context where the traditional concept of place is under discussion, new urban interventions show a change of meaning of the concept of urban place. The expression of urban language takes advantage of new technologies but its inherent meaning, its essence, may not have changed completely. Urban places keep on being an environment of communication and socialization. The urban image does not belong to the city, but to its inhabitants since this image is born in the way it is represented in the minds of inhabitants. The city makes sense when it satisfies its inhabitants' needs (Pérgolis 2005).

In this context regarding the perception of Place, emerging urbanity elements rise with the purpose of regaining the traditional idea of urban place in the present socio-cultural contexts. Consequently, color and other components of language, renewed by their new ways of production, participate actively in the construction of the concept of Place.

As living meaningful environments, both individual and collective, the social production and construction of the urban public place must be understood as a dialectic relationship which changes along time, creating new ideas, social structures and meaningful places.



*Figure 1: Different ways of production in urban places of the last decades in Córdoba city.*

### 3. THE CHROMATIC EXPRESSION IN THE CONTEMPORARY CITY

The urban color, as one of the structural components of the language of the city, contributes, as a quality, to fulfilling the needs of man; if these are fulfilled in city places, they become urban places. At present, other spatial configurations reveal that the expression of urban language has changed taking advantage of new materials and technologies developments. By means of new expressive forms of color, these urban places propose a different way of suggesting, informing and stimulating the sense of place in the city. This prompted a chromatic survey and the subsequent analysis of uses and behaviors in paradigmatic places of the city of Córdoba, Argentina in the last decades.

#### 3.1 Method of the chromatic survey

Light, color, textures and cesias are main components of urban language, and as a consequence, of the created spatiality. These elements work on the whole configuration of limits having influence on the perception and communication of the urban environment.



By recognizing paradigmatic urban places in the city of Cordoba in the last decades, it is proved that color has accompanied the development of the concept of place in the city. The aim is to prove how the new materials and architectural trends have changed the chromatic expression creating changes for those who perceive and inhabit those environments.

The steps to conduct the chromatic survey are as follows:

- The paradigmatic environments are chosen according to their chromatic expression and temporal condition of urban place.
- The Natural Color System (NCS) is used to measure color since it is the most appropriate way to reveal the different chromatic modifications produced in urban spaces.
- Simultaneously, the performing cesia degree is measured and textures are surveyed to determine more accurately both the perceived color and the inherent one.
- A synthesis matrix is laid out to present the survey of different variables as well as the perceived color and the inherent one.
- The chromatic survey is conducted at different times of the day and in different seasons.

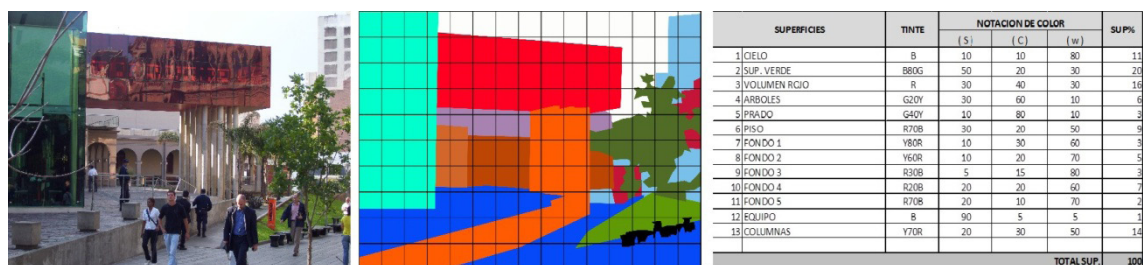

Figure 2: Urban color in urban places of the contemporary city – N.C.S.

### 3.2 Analysis of uses, appropriation and sense of place

The appropriation and use of urban environments are determined by the satisfaction of physical and psychological human needs. When these take place, the sense of place becomes real and is expressed by the emotional behavior and reactions of the inhabitants. To confirm the new relations between space and sense an analysis of uses and behaviors is carried out to prove the meaning given by inhabitants to the urban experience. The steps to analyze the uses and behaviors are as follows:

- An interpretative observation is carried out with the aim of determining the behavior and appropriations in the different selected testing environments. This observation takes place at different times of the day, on different week days and different seasons.
- with the aim of completing the analysis, questions are made to casual users to verify the association and the meaning the inhabitant relates to the perception of chromatic elements influencing public spaces.
- A synthesis matrix is laid out to present the analysis of recorded uses and behaviors.

## 4. PROVISIONAL CONCLUSIONS

In accordance with the above mentioned it is stated:

- According to the perception of each period of time, the notion of place proves the main function of color and different components of language and the different role they play.

- In the contemporary city the new urban architectural expressions affect not only the physical aspect of the city but they also condition the use and appropriation of the public urban space, changing the meaning of the concept of traditional place the inhabitants have.
- At present, the perceptual variation between the applied color and the inherent color is broadened as a consequence of the performance of perceptual signs as cesias, textures and the synesthetic process shown in the new expressive possibilities of innovative technologies and materials. Besides, an appearance variety is displayed, sometimes short-lived, supported by the new role of sensory effects such as light and sound.
- The chromatic survey and the survey on uses and behaviors show that the perception and meaning the inhabitants confer to color are associated to the different periods of time.
- The role of color in the contemporary city exhibits its potentiality to promote real experiences of city environments which have become Urban Places, both in new sites or in re-valued spaces. This highlights the need for chromatic design at different performance degrees in the city.

### ACKNOWLEDGEMENTS

I wish to express my gratitude to the Secretary of Science and Technique (SECyT), National University of Córdoba for the economic support to the Institute of Color; without their support, the research project “Colour and Production of the Urban Pace within the contemporary City” would have not been possible.

### REFERENCES

- Bahamón, A., A. Alvarez, 2010. *Luz, color, sonido: efectos sensoriales en la arquitectura contemporánea*. Barcelona: Parramón Ediciones.
- Mongin, O., 2006. *La Condición urbana: la ciudad a la hora de la mundialización*. Buenos Aires: Paidós. *Traducido por Alcira Brixio*. 1º ed.
- Norberg-Schulz, C., 1975. *Existencia, Espacio, y Arquitectura*. Barcelona: Blume.
- Pergolis, J., 2005. *Ciudad deseada: el deseo de la ciudad y su plaza*. Buenos Aires: Nobuko. 1º ed.

*Address: Darío Suárez, Institute of Color, Faculty of Architecture,  
Town Planning and Design, National University of Córdoba, Argentina  
Deán Funes 1752 (Torre 2) Piso 7-Dpto “C”- CP 5003 – Córdoba, Argentina  
E-mail: radasuarez@yahoo.com.ar*

# Analyzing Vivid Polychromy in Contemporary Architecture: Overview of the *Coloured Sequence* Method

Anne PETIT,<sup>1</sup> Daniel SIRET,<sup>1</sup> Nathalie SIMONNOT<sup>2</sup>

<sup>1</sup> CERMA, Graduate School of Architecture of Nantes, France

<sup>2</sup> LEAV, Graduate School of Architecture of Versailles, France

## ABSTRACT

The purpose of this paper is first to question vivid polychromy as a new component of contemporary architecture and then to present the research of an appropriate method of surveys to analyze this new phenomenon. To this end, we particularly present the exploratory method of the *Coloured sequences* based on drawings and graphic analysis.

## INTRODUCTION

In architecture, this last decade has witnessed the profusion of an unfamiliar and insistent architectural polychromy displaying a new typology of attractive urban frames. Our PhD research questions the sudden visual “exp(1)osure” of these garish colors on façade. Our objectives are to identify the factors of this emerging phenomenon, to analyze the effects of showy colors on our perception of spaces, and to question the issue of the “aesthetic sustainability” of these new facades. In this paper, we first interrogate color as a new ornamental component of contemporary architecture and then, we expose the method of the *Coloured sequences*, an experimental method that we are trying to develop.

## 1. POLYCHROMY AS A NEW ORNAMENTAL COMPONENT

### 1.1. An exhibited polychromy

An exhibited polychromy is particularly noticeable on new neighborhoods in mutation in French cities. It produces unusual “urban frames” intensified by the effect of mimesis between buildings. Visible on new constructions as well as external refurbishments, it is an element of visual animation in landscape. Capable of converting an inhospitable site into an attractive space, it can be seen as a factor of homogeneity and appropriation of space. Skillfully applied to the design of the buildings, it seems to push the walls, deform the volumes, approach the ground... However, the brutal nature of its implementation and the apparent mismatching between the buildings in the landscape can lead to the fear of a visual confusion. The architectural polychromy produces a focusing effect and imposes its presence visually. It leads to a forced eye capture of the public space users.

### 1.2 A skin and surface architecture

As expressed by Picon (2010), “*New energy constraints provide a set of practical arguments in favor of superficiality.*” Contemporary facades assume many vital functions in the building: ventilation, regulation of its internal temperature and brightness, capture of energy, and so on. The palettes of coloured materials are constantly reinvented (ever more visible, powerful, subtler, interesting, accessible, lasting). They play with light, movement, reflection, transparency and surrounding landscapes. “*Amplified or reduced, enlightened or intensified, exalted or submerged in a harmonic chromatic atmosphere, ephemeral colors become*

*tangible fostering rich re-definitions of color and light interactions and also defining a new color vocabulary, a new trend and approach to achieve new kinds of urban atmospheres and spatial interpretations*” as l’Atelier CLER (2011) expressed it. Far from the association of crime and ornament introduced by Adolf LOOS in 1910, those extremely coloured buildings targeted by our research seem to grow unabashed of more conventional esthetic judgments. Showy colors, among the multiple lenses of ornament, seem to be fantasized as a supplementary dimension in the freedom of expression and communication. Polychromy highlights the sensory quality of ornament in architecture and awakens the senses of perception of users.

### 1.3 Polychromic ornament at the service of a communicative architecture

Cities are rivals in the context of globalization, and each of them seeks to emphasize its peculiarities. Following the enhancement of historical, cultural, industrial, environmental, and artistic heritage, cities now open the race to “icon architecture”. Architecture must be photogenic in order to be “sold” as an icon. In *The Iconic building* (2005), Jencks proposes to assign to contemporary buildings a qualification of signs or logo. The recent chromatic freedom applied to architecture, sometimes becomes a pretext to give to the façade the role of the signage of a company. This raises the question of the risks of applying graphical communication to architecture in the urban landscape.

## 2. THE METHOD OF THE COLOURED SEQUENCES

In order to identify the factors of this emerging phenomenon, to analyze the effects of showy colors on our perception of spaces, and to question the issue of the “aesthetic sustainability” of these facades, we search for an appropriated method of surveys. Our objective is to interrogate both urban actors of color and the users of the coloured spaces. Polychromy is essentially a visual phenomenon, so it seems necessary that the interviewees visualize examples of colored buildings to be able to talk about them. Our method, still under development, is called the “*Coloured sequences*”: *sequences* due to the phenomenon of the observer in movement, and *colored* to illustrate a certain freedom maintained in the chromatic choices.

A coloured sequence is composed of a set of graphical prints. To demonstrate the diversity of the urban polychromy, our approach consists in realizing readings of “urban frames” (urban landscapes) of the city. This method uses hand drawing (Figure 1) that we complement with a graphical approach. At the present time, eight “coloured sequences” have been carried out since October 2011 in the city of Nantes, France. About forty drawings begin to constitute a notebook of “local colors”, a colorful portrait through which the city can be identified. A sequence is a route among the most colorful districts of the city. This route is located near public transports or pedestrian paths. Each sequence is composed of “urban frames” presented in their chronic order.

Three graphical elements compose the sequences (see Figure 1): the drawing of urban frames, the chromatic patterns and the process of fragmentation. The elements of Coloured sequences are graphical syntheses of landscapes, buildings and routes.

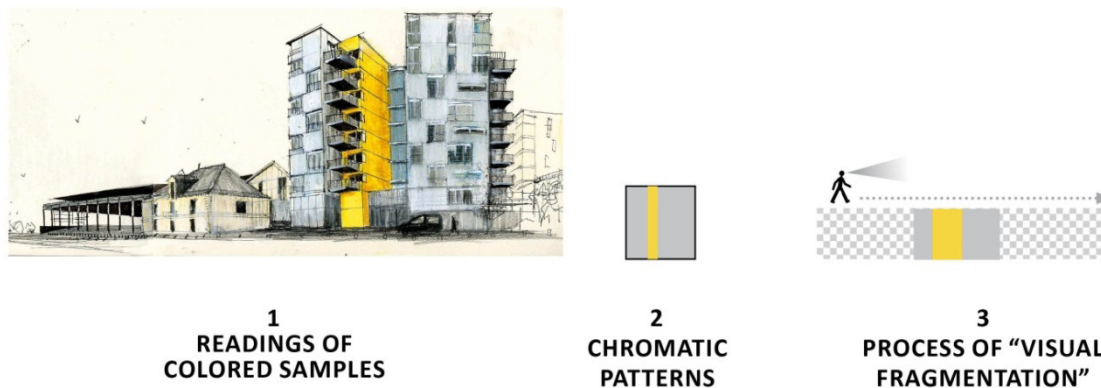

Figure 1: Method of reading and graphic analysis: drawings, chromatic patterns and schematic fragmentation process (Graphic documents A. Petit).

## 2.1 The « urban frames »

In this reading exercise, our objective is to draw a synthesis of the real coloured landscapes. This synthesis is a graphical representation of coloured buildings in their environment. We try to capture « urban frames » using some filters. The first filter is the reestablishment of the framing; it usually reconstitutes the view on landscape to reintroduce the immediate surroundings. The second one lightens or erases elements from the first plan that disturb the vision (trees, road signs, vehicles and others moving objects). The third filter prioritizes the colors of buildings and erases ephemeral colors such as colors of sky, urban advertisements, urban furniture, road signs, or vehicles. The last filter is the personal, artistic and sensitive interpretation of the researcher that we try to limit. As possible, we seek to respect the pedestrian points of view and the perspective. We try to keep close to the shades during our presence on the site. Those one vary depending on light, time of day, seasons, and colors of background.

We justify the use of the sketches rather than photographs through several arguments. The drawing is an aesthetic and methodical means passing by the mobilization of tools specific to the architects. The use of a common graphical language between the investigator and the architects for example, can facilitate expressions during the investigations. By the shift produced between reality and the drawn image, it brings a distance necessary to the value judgments. This approach differs from the use of photographs in which all colors appear with the same degree of visibility. Furthermore, sketches have a friendly characteristic which can facilitate the verbal expression on colors.

## 2.2 The chromatic patterns

Through the chromatic patterns, we synthesize every building in a square of a few centimeters across the colors used, their chromatic number and their associations. These colors are composed in the square in a schematic way (see Figure 2). The definition of a coloured pattern for every architectural object proved thereafter to be a synthesis tool facilitating the study in terms of analysis programmatic, cartography, color composition, chromatic association, and colors redundancy.



Figure 2: Extract of the Coloured sequence “Ile de Nantes”; three projects observed on our way (Graphic documents A. Petit).

### 2.3 The process of “visual fragmentation”

This part will be used during the in-situ surveys. It is a means proposed to report and then to analyze the eyes-capture of those buildings along a predefined way. The process of “fragmentation” outlines a re-transcription of the coloured visual prints, broken up by layers according to the speed of movement and a landscape chromatic pallet. Still under development, it represents visual prints that can have buildings along chosen routes. For example, what could be the visual print of a red building after a ten minutes long path of grayness?

### 3. APPLICATION OF THE METHOD (FUTURE WORK)

The *Coloured sequences* method is addressed to people who have, in preference, an experiment of the city of Nantes. The investigations will take place in a neutral room. We will ask the interviewees to speak about the visual documents that will be presented. People will be invited to consult the documents, and then to talk about the “urban frames”, trying to remember their in-situ feelings. Then, they will be asked to express their experience of the site, their opinions and tastes on the phenomenon of polychromy, in this particular case and in general. We choose to dissociate two groups of future investigations, first, the urban actors of color (planners, architects, developers, etc.), and secondly the users of public space (inhabitants, workers, passers-by, tourists, etc.). The results of these surveys will be analyzed to give answers to the general issues of our research.

### REFERENCES

- Cler, M., F. Cler and V.M. Schindler, 2011, Colour and light in urban planning: Policy, palletes and the sense of place, mood and movement, *Interaction of colour & light in the arts and sciences, AIC 2011 midterm meeting, Zurich*, 348-351.
- Jencks, C., 2005, *The iconic building*, London: Frances Lincoln.
- Picon, A., 2010, *Culture numérique et architecture, Une introduction*, Vol. 217, Basel: Birkhäuser GmbH.

Address: Anne Petit, CERMA, 6 quai F. Mitterrand, BP16202, F44262 Nantes Cedex 2  
E-mail: anne.petit@cerma.archi.fr

# Colour-Light-Concerts: Experience – Close to Our Senses

Gisela MEYER-HAHN  
atelier farbton, D-Pinneberg

## ABSTRACT

My colour-light compositions are my manifestation about the relationship between light, colour and sound to space and human perception. I focus on two fields: science and cognitive ability. My fundamental work consists of watching, researching, perception and the knowledge about colour and light as nature phenomena and its effects on human senses. The term 'nature' for me also implies 'space'. Space has its own resonance and sound, its breathing. Thus for every performance/concert I create a colour-light arrangement which refers to the musical composition. But it also includes my impressions of the spatial conditions. I realise that in these concerts the audience feels the relationship between seeing, hearing and space. Body and psyche react, while the attendees are becoming aware of their own perceptual processes. Although we have to take into account that our brain basically stores all our learnt individual cultural background.

## 1. INTRODUCTION

In these phenomena lies the idea for developing the colour-light-concerts, who – in addition – will let us experience the presence. I register, I feel the space, deal with its sound, its architecture and colourfulness, its surfaces. A first illumination-colour-concept comes into being. At the same time I listen intensively to the music chosen for the concert.

After the analysis of space and music I work out a composition for the appearance of colour and light, depending on those two basic parameters - and prepare a score for the light-mixing-panel. This score contains all specifications for tempi, crescendos, decrescendos, amount of light, number and position of the sources of light to be selected. But there still is some scope for spontaneous actions/improvisations. The light-composition comprises complex content: it correlates with colour-shades and light-quality to keys, instruments, voices, visual axes, structure of surfaces, respectively the musical oeuvre. Temporarily interpreting the musical composition or setting particular accents, becoming visible in the room by colour and light. Or it can give special accent, which people can visual in space in the appearance of colour and light. The mixing-panel is my instrument, its console my keyboard.

The number of flood lights, the quality of light, the colours of the lighting gel filters arise as a result from the light-composition and are specified in the lighting-plan. This is the basis for positioning the lamp and its colours. Each lamp must be individually selectable from the light mixer. There are no electronic effects or digital pre-settings. All setups are done manually.

The environment breathes with the performance.

From time to time I integrate my special 'lightcube' into the room who, in that case, will be illuminated very explicitly. Or I stretch long transparent coloured silk-panels, as 'breathing lines', where the light can follow after.

Each room has different wall-surfaces and its own acoustics. In the process of realizing

a concert I coordinate the planned light-colours with the walls and live-sound of the musicians. Preferably exactly at that time the performance will take place. I use the variety of NCS (Natural Colour System). This phase I call ‘tuning my instruments (lights and their colours)’.

- music: classical compositions and/or instrumental improvisations
- artists: orchestras, vocalists, bands, choirs or instrumental soloists
- solo instruments: f.e.cello, piano, organ, trumpet, saxophone, gong, percussion, harp, marimba,...
- environment: churches, urban spaces, facades, amphitheatres, parks, waters,...

### Background and source

I’m interested in watching, perception and knowledge of colour and light as nature phenomena. And in complex connections of colour and human live. Many years I have been concerned with the colour BLUE in several cultures and thereby became acquainted with a large diversity of its facets. Due to my intense involvement with this colour-phenomenon and its appearance I acquired knowledge, inside and awareness what has an effect on my light-compositions.

In classical notated compositions my light-compositions have to be adjusted to the tempi as well as to the arrangement of the musical pieces by the conductor. Temporarily the light composition plays along ‘just’ like another part. Working together with improvising musicians we get to know a further component of interpretive options: light and colour become an independent ‘instrument’ and are so generating an equal partner to the musical instruments.

## 2. RESULT AND CONCLUSIONS

As an artist being mainly engaged in the public area I gather wide experiences about similar perceptions in the European cultural area as well as in many cultures of the world such as:

- certain single tones become allocated to colour-shades and vowels
- musical keys causing the same coloured atmospheric pictures

This is the scientific section behind the art.

My further awareness for the illumination is:

- The musical composition determines location and placement, time and speed.
- The room, its surfaces and its architecture determine the quality and quantity.

I constantly improve my colour-light compositions based on the knowledge about the relationships between colour, light, space, cultural influence and its impact on our senses. In this way I realize more and more regularities concerning the dependence of the light-compositions on sound, space, instrument and musical-composition.

*Address: Gisela Meyer-Hahn, artist/performer  
atelier farbton  
1 Hogenkamp, D-25421 Pinneberg, Germany  
Email: gisela@ meyer-hahn.de  
www.meyer-hahn.de*



# Chromatictownscape – Colour Concepts for Urban Space: Case Study of Neyron

Michel CLER,<sup>1</sup> France CLER,<sup>1</sup> Verena M. SCHINDLER<sup>2</sup>

<sup>1</sup> Atelier Cler Etudes Chromatiques, Paris

<sup>2</sup> Faculty of Philosophy, University of Zurich

## ABSTRACT

In this paper the authors first describe ‘Chromatictownscape’, a colour manifesto published by the authors (Cler 2005), and then present the methodology and its application of Atelier Cler, which promote an understanding of the cultural significance of chromatic expression in the design and development of contemporary urban space. The current paper extends the work of Atelier Cler featuring a colour concept for urban space completed in 2011 for Neyron in the department of Ain in France.

## 1. CHROMATIC TOWNSCAPE AND CHROMATIC STUDIES

Chromatictownscape is concerned with the development and implementation of material and colour policies and concepts in urbanism and architecture. Based upon chromatic studies, Chromatictownscape addresses and investigates a broad range of colour aspects including: colours within urban space; the colour of architecture as an element inserted into the immediate built surroundings, general urban fabric and natural environment; colour within natural surroundings such as mineral and vegetal shades, nuances of the sky and water surfaces considering day-and-night as well as seasonal changes; understanding of colour independent of form; and colour applied to enhance space and volume. Chromatictownscape aims to stimulate, reinforce and support in situ cultures of colour. This entails working with the client – policy makers, firm managers, administrative councils, inhabitants, etc. – to set up a mutual, communicable colour vocabulary, which can be used as a language of expression and means of identification. More precisely, Chromatictownscape aims: to create a way to further colour memory specific to a site; provide a colour vocabulary that is easy to decipher and that relates to technical aspects of building construction, topographical conditions, as well as political, economical, historical, social and cultural aspects; identify, position and personalize the colour of the built environment with respect to its context and surroundings; to enhance a distinctive chromatic atmosphere; and enhance and harmonize urban space through re-evaluating existing colours and creating chromatic significations that enrich existing colour vocabularies by introducing compatible external colours or colour harmonies.

## 2. CASE STUDY OF NEYRON

Neyron is located in the department of Ain in France. Its immediate proximity to the city of Lyon is crucial to its development. Mostly working in Greater Lyon, Neyron’s population has been growing constantly since the 1960s. Recently a revision of the local master plan including a colour chart conceived by Atelier Cler has been approved. Some major issues include conflicts between advocates of preservation and proponents of economic development; interests of people living in the area for generations versus those of newcomers; and community and individual values.

## 2.1 Topographical Analysis of the Site

Three different topographical strata or areas of the site can be specified.

Neyron is situated at the southern edge of the Dombes Plateau, which was created by Pleistocene glacial sediments at the base of the French Alps. Overlooking the Ain and Rhône valleys at 314 meters above sea level Neyron-le-Haut is the highest area. The ancient core located in the Saint Didier district includes a Romanesque church (10<sup>th</sup> century) with adjacent cemetery, which was reshaped over the years especially in the 19<sup>th</sup> century. A striking chromatic characteristic of the Saint Didier church is the ochre rubble stone of its tower (Figure 1, left). In this district single-family houses are common, density is low and vegetation is abundant. The district has developed to the west and south where the terrain slopes down gently.



*Figure 1: Existing colours of Neyron: Ochre rubble stone is a chromatic characteristic of the ancient city core.*

The highest urban density, however, is in Neyron-le-Bas along the main street (*Grande Rue*), which is oriented east–west and until 1972 was part of the ancient trunk road (*route nationale*) connecting Lyon with Geneva, Switzerland. Today it is a secondary road running parallel to the nearby railway tracks (since 1856) and the water canal (since 1858). Groups of contiguous houses with their roofline parallel to the street (see Figure 2, right) alternate with empty lots and perpendicular streets that provide corridors of light and also make the gables visible. The most common treatment of residential façades is paint. Some striking colours range from reddish to orange shades (Figure 2 and 3). The main urban space Victor Basch Square is framed by the townhall (1874-75) to the south and the Saint-Exupéry Hall to the north. Here the existing colours, however, range from shades of very light yellow to light rose.



*Figure 2: Striking characteristic of existing colours of Neyron range from reddish to orange shades.*



*Figure 3: Existing colours of Neyron: Contour, profile and decorative elements are the touchstone of (traditional) architecture.*

A third stratum or area includes the riverbanks. The Canal of Miribel, a waterway of the Rhône River, was of major importance in Neyron from the mid 19<sup>th</sup> century until 1940 when the Miribel Bridge was opened. Before then a cable ferry was the only rapid way to cross the Rhône River to reach Lyon. Today industrial buildings are located here and define the surroundings along the river shore.

## 2.2 Fundamental Questions

The influx of a new generation of inhabitants from neighbouring Lyon is evident in the resultant disparity of colour of residential façades: new choices contrast with the pre-existing colours of Neyron. Some basic questions arise: What is the trend? What is the policy of Neyron towards the application of colour? Should the pre-existing chromatic atmosphere be preserved? Or should so-called traditional colours be enriched with compatible new ones? According to the understanding and approach of Chromatic townscape colours as well as materials are constituent aspects of chromatic studies and resulting applications. The methodology acknowledges cultural heritage and aims to preserve and reinforce it. In this sense a main goal of chromatic studies and applications is to enhance local colours and building materials. However, tradition cannot simply be an aim per se and should especially not be used to fix or block the development of a colour chart. As new inhabitants from outside the pre-existing local community settle into an area, new colours external to pre-established choices naturally appear. As well, progressive economic development means that as new urban spaces are built and integrated in the pre-existing urban fabric, new functions will be introduced. These new functions often require a new range of colour options as well.

## 3. RESULTS AND DISCUSSION

### 3.1 Colour Chart

Taking into account the three different areas mentioned above, we distinguish three different dominant chromatic strata.

**Neyron-le-Haut:** Synthesizing the visual statements of chromatic and material aspects, the dominant chromatic feature is yellowish ochre (Figure 1). Our proposal includes re-enhancing and reinforcing golden ochre aspects and extending the palette with shades of copper. The colour palette for window frames, shutters and doors includes green colours in harmony with vegetation.

**Neyron-le-Bas:** This area is characterized by the deep perspective view of the main street as well as the gables of detached houses. Our proposal includes reinforcing the chromatic

dominance of shades ranging from oxide red to oxid orange that are common to this area; strengthening the chromatic dialogue of opposite-facing residential façades; and bringing such alternating rhythms as compact and open spaces and light and shadow into play. A separate colour palette for window and door frames underlines these rhythms.

Canal of Miribel Industrial Zone: The notions of chromatic vibration and movement created by the lightness of the aquatic atmosphere underscore the choice for materials with nacre effects ranging from chromatic greys to blue and turquoise to metal-coated green in harmony with the vegetation of the riverbank.

In general, a special treatment of the buildings' basements, contours, profiles and decorative elements is suggested to contribute to colour mood, identity and a sense of place.

The result of the chromatic studies is a Colour Chart that consists of different tools, such as colour palettes, colour fans, colour cards as well as colour schemes and a colour plan which identifies specific chromatic aspects and atmospheres. This visual material will be presented at the Congress.

### 3.2 Traditional and Contemporary Chromatic Aspects of Materials

Chromatictownscape emphasizes the importance of assuring chromatic harmony and enhancing distinctive chromatic ambiences and atmospheres in addressing the relationship between the patrimony, residential buildings and new urban spaces. While maintaining the spirit of the town, the suggestion of new colours and new materials, e.g., acrylates, methacrylates, etc. are necessary and part of the process. These additional colours will facilitate the development of the chromatic aspect of urban space according to the needs and choices of (new) inhabitants.

## 4. CONCLUSIONS

The Colour Chart remains a dynamic colour guide that needs to be adapted to economic growth over time, influx of new inhabitants and added and changed meanings that new generations attribute to colour. Thereby, the task facing involved professionals is to ensure coherence within the evolving urban context. Colour choices of individuals, however, are also to be considered in relationship to the Colour Chart as effective and successful urban planning incorporates the interaction of individual and community interests and choices. Understanding and applying colour as a key element in the creation of environmental, urban and habitat space results in a higher quality and stimulates, reinforces and supports the positive development of colour culture.

## REFERENCES

Cler, M., F. Cler and V.M. Schindler, 2005. Chromatictownscape, In *AIC Color 2005, Proceedings*, ed. by J. L. Nieves and J. Hernández-Andrés, 2 Vols., Granada: Sociedad Española de Óptica and Comité Español de Color, Vol. 1, 405–408; and Vol. 2, 1581–1584.

*Address: Atelier Cler, 64 rue Vergniaud, 75013 Paris, France  
E-mail: atmfccler@wanadoo.fr*

# Spiritual Dimension of Design and Architecture: Utopia or Necessity?

Helena SOARES<sup>1,2</sup>

<sup>1</sup> PhD Researcher of Faculty of Architecture, The Technical University of Lisbon

<sup>2</sup> Portuguese Colour Association (APCor), Portugal

## ABSTRACT

This study analyzes the multisensory atmospheres in architecture and interior design, bringing some of the values Gandhi brought to the West via that which Satish Kumar refers to as Reverential Ecology (Kumar, 2010). It is an attempt to reflect on the holistic model of the continuum matter / life / mind (Smuts, 1926), questioning the importance of humanizing spaces through their spiritual dimension, where multisensory atmospheres of light and colour have a crucial role.

In recent years, the global human discontent has opened space to questioning the exclusively material well-being that leads to the impoverishment of life in the midst of wealth, instead of a good life, with its psychological and spiritual dimensions. Assuming that our balance as human beings on planet earth comes from the realization of the world as non-dual, the study is based on the paradox that it is dealing with the world's duality that we can be aware of its non-duality.

Through the appropriation of the concept of "Reverential Ecology" by design and architecture, we intend to demonstrate how the spiritual dimension of space is more a necessity than an utopia, contributing to a truly sustainable practice.

## 1. INTRODUCTION

Without being demagogic, we can say that the ideologies of progress are very fragile at the moment, and that we need a new paradigm for the design and architecture, and also for the discourse about sustainable development. All humans are subject to the same vital and deadly problems of mass destruction weapons, ethno-religious conflicts, environmental degradation, economic excesses, but the awareness of our common destiny is still very scattered and marginal. Our western civilization incorporated and continues to incorporate many positive features, but the negative traits are growing. According to Edgar Morin (2003), it suffers from profound deficiencies, and should thereby receive from other civilizations that which it is lacking.

I try to overcome the western-centrism that gives us the monopoly on reason and truth, and I fight so we can recognize the virtues of all civilizations, including the most archaic ones. All of them, including ours, have their superstitions, their blindness, but also their knowledge, their skills, their arts of living.<sup>1</sup> (Morin, 2003)

The trinity – Soil, Soul, Society – referred by Satish Kumar for the time of ecology, under the name of Reverential Ecology, is inspired by a true holistic thinking that joins nature, humanity and spirituality.

<sup>1</sup> Tento ultrapassar o ocidentalocentrismo que nos dá o monopólio da razão e da verdade, e milito para que possamos reconhecer as virtudes próprias de todas as civilizações, incluindo as mais arcaicas. Todas, incluindo a nossa, têm as suas superstições, as suas cegueiras, mas também os seus saberes, as suas habilidades, as suas artes de viver. - Free translation from the author.

Thus, recognizing the need for an holistic approach to this impasse, in which the *Homo Religious* and the *Homo Economicus* are currently stuck, the appropriation of this concept by design and architecture helps us reflect on the importance of humanizing the spaces through their spiritual dimension, where multisensory atmospheres of light and colour play a key role. In fact, the atmosphere of a space, with great formal and communicative impact, act as structured process of time and sensitivity. By revisiting its emotional content, charismatic projects are addressed, identifying and analyzing areas that touch all our senses and explore the richness of meanings in the world, thus making us thrill, amaze and exceed.

## 2. REVERENTIAL ECHOLOGY AND SUSTAINABILITY



Figures 1,2,3,4<sup>2</sup>: “Soil” (unknown author); *Dream of flying* (Oszvald, NS); *Gilardi house in Mexico City/Barragan* (Llamas, JT); *Eternity* (Eye, S).

When we think of sustainability, we think of durability, longevity and respect for the environment, and this idea should not just be reserved for the physical environment, the material world, but also for thought, human behavior and society as a whole.

According to the *Bhagavad Gita*, whose work serves as guiding philosophy to the study presented here, nature, society and the individual as “self”, form an interconnected triangle of which we have to take care all the days of our lives. Through three key concepts – *Yagna*, *Dana*, *Tapas* – it shows us a path of reflection where our thoughts should dwell: *Yagna* brings us to the need to take care of nature, repairing the damage we cause; *Dana*, whose meaning can be translated as offers, reminds us that all art, culture and science are collective offerings of past generations to the present so that, in return, it must reciprocate with its talent, work and knowledge. *Tapas* is a form of self-listening and self-purification and refers to the need to nourish our soul with meditation, silence, contact with nature, etc. Recognizing that our souls are often polluted by excessive desire, anxieties and too hectic a life, *tapas* is the need to regain balance; inner solitude and silence are often a way to do this. *Tapas* is a positive concept with a positive meaning. It flows from the deep awareness of our own limits. Those who practice *tapas* realize what is enough, and are satisfied with it, getting free from obsessive consumption

In fact these three concepts are not distinct. The three together are part of the natural order of the Earth and it is on this trinity, renamed by Satish Kumar as “Soil, Soul, Society” and synthesized by the same author under the concept of Reverential Ecology, where now rests our intention and reasoning.

2 Figure 1: accessed 02 Mai 2013, <http://nuvemdeestrelas.blogspot.pt/2011/09/natureza-sonha.html>; Figure 2: accessed 02 Mai 2013, <<http://richard-ahlstrom-wm2a.squarespace.com/?tag=Oszvald>>; Figure 3: accessed 02 Mai 2013, <<http://sabinasblues.blogspot.pt/2008/10/luis-barragn.html>>; Figure 4: accessed 02 Mai 2013, <<http://flustermagazine.files.wordpress.com/2012/01/2-stalker-eye.jpg>>

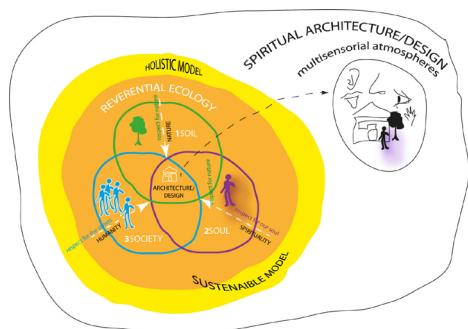

Figure 5: Reverential Ecology illustrating the holistic process of sustainable design and architecture.

*Soil* is respect for nature, the earth, all life forms, air, fire and water. More than an object of utility, *soil* symbolizes life; *Soul* represents the respect for ourselves. In the context of this study and according to the philosophy contained in the Indian treatises *Upanishads*, it represents the soul, the spiritual, immaterial and eternal, not only of Man, but of all living beings; *Society* is respect for others. The feeling of gratitude that should be present in a social order based on reciprocity and mutuality, i.e. on giving and receiving.

The replenishment of the natural world, of society and of our soul, this is the great work for our time. But they cannot be placed in separate boxes, thus having to be considered together because they are complementary to each other. Design and architecture that aspire for a truly sustainable practice should raise their level of awareness in the formulation of new approach paradigms, reflecting on the fullness implied in this trinity.

### 3. SPIRITUAL DIMENSION OF MULTISENSORIAL ATMOSPHERES OF LIGHT AND COLOUR

Urban Man, living inside constructed artificial spaces, does not consider himself a part of nature and, in his cosmological model, separates man / environment, I / world, subject / object, unable to make his integration in the whole to which he belongs. It is a progressive enhancement of over-intellectualizing things, instead of an individualized learning resulting from a greater attention to what is happening around us and within ourselves. Additionally, the overstatement of the sense of sight compared to other senses, especially in terms of architecture, pushed us away from an holistic view of reality, thus setting the path to the current ecological, social and spiritual crisis.

According to Pallasmaa, the task of architecture is to make visible the way the world touches us – “*In my view, the task of architecture is to make visible how the world touches us*” (Pallasmaa, 2010). But what is lost when sacredness is set aside and everything is questioned in a rational and incomplete way?

When sensitivity is lacking (...) and ethical limits are dissipated, as are the forms of symbolic articulation and dream among humans, it is because they have ceased to be able to relate<sup>3</sup> (Duarte, 2012),

thus creating the conditions for fear, anguish, violence, hatred and dogmatism.

According to Barragan, “Serenity is the great and true antidote against anguish and fear, and nowadays, Man’s housing must propitiate it.”<sup>4</sup> (Barragan, quoted by Durão, 2010). Barragan, as well as Le Corbusier (2003), considers emotion as an essential vehicle of poetic ex-

<sup>3</sup> Quando falta sensibilidade (...) e se dissipam os limites éticos, as formas de articulação simbólica e de sonho entre os humanos, é porque estes já deixaram de se saber relacionar. - free translation from the author.

<sup>4</sup> La *serenidad* es el gran y verdadero antidoto contra la angústia y el temor, y hoy, la habitación del hombre debe propiciarla. - free translation from the author.

perience, where beauty is a kind of spirituality and where colour and light are key elements in the forming of a visual language. Projects such as *Casa Gilardi*, Mexico, conceive colour as something more than a mere decorative element. Colour triggers a sensory and perceptual experience that transports us to a universe of sacred beauty that echoes in our depths. Also for Maria João Durão (2010) colour is material and spiritual, where nothing is offered directly, nothing is obvious and each compartment of memory has to be discovered and amaze us by the fluidity of spaces, which are materialized by the effects of light and shadow and a proper handling of all our senses.

In fact, light and colour have always been a place of ultimate answer to the mystery of existence, rescuing the strongest feelings, what is intimate and inexplicable. As a requiem in music, it is the main elements of a space that answer the essential question of humanity. What exists after the end?

#### 4. CONCLUSIONS

According to *BhagavadGuita*, the world has no absolute reality, but we cannot say that it is an illusion. Manifestation is always duality but it is important not to lose sight that it is dealing with duality that we can be aware of non-duality. We frequently think that it is the mind, the dream, the fantasy and the imagination that connects us to the cosmos, to that utopia of other possible sources and purposes. But it is the touch, smell, sounds, light and colour that open the door to these spiritual worlds that connects heaven to earth.

#### ACKNOWLEDGEMENTS

Satish Kumar and Resurgence & Ecologist Magazine.

#### REFERENCES

- Durão, M.J., 2010. Colour as pathway of light: searching the shadow in Luis Barragan, *Journal of the International Colour Association*, **05**.
- Duarte, R.B., 2012. *Os paraísos perdidos de éavum: sobre a incomunicabilidade*, Caleidoscópio, Lisboa.
- Morin, E., 2003. *A cabeça bem-feita: repensar a reforma, reformar o pensamento*, Bertrand Brasil, Rio de Janeiro.
- Kumar, S., 2010. *You are therefore I am: a declaration of dependence*, 6th ed., Green Books [UK].
- Pallasmaa, J., 2010. *The thinking hand: embodied and existential wisdom?*, Chichester.
- Smuts, J.C., 1926. *Holism and evolution*, The Macmillan Company, New York.
- Saraswati, S.D., 2007. *Bhagavad Gita*, Arsha Vidya Centre, Mylapore [India].
- Zumthor, P., 2009. *Atmosferas*, Editorial Gustavo Gili, Barcelona.

*Address: Helena Soares,  
Av. Menéres 234, 1º frt/esq Blc3, 4450-189 Matosinhos, PORTUGAL  
E-mail: helenasolaris@gmail.com*



# A Study on the Evaluation Model of Color Image in Architectural Space

Eunmi YU  
 Faculty of Interior Design, Semyung University, Korea

## ABSTRACT

This paper investigates human being’s affective responses on the artificially made architectural space through empirical methodology used by environmental psychologists. Controlling for various space attributes, experiment is carried out by changing wall colors with the largest stimulating effect.

## 1. INTRODUCTION

When we face the various situation and environments in every day life, we judge beauty or ugliness and feel pleasant or unpleasant for those factors. The main concern in environmental psychology is human responses to a variety of stimuli leading to approach-avoidance behavior. Architects and space designers create ‘pleasant and beautiful’ spaces based on the creative idea and learned-and-accumulated experiences. Whether beautiful spaces suggested by architects and space designers mean the same feeling to laypersons has been posed by professional designers for long. Each person is talking about his/her own favorite color. And they evaluate an object by their favorite colors in an area of urban, architecture and interior environment. Professional designers use common languages in building up, conveying and implementing concrete concepts form beginning through evaluating outcomes for design works as well as architectural and space ones. Of these common languages are adjectives by which people evaluate perceived attributes and express feelings.

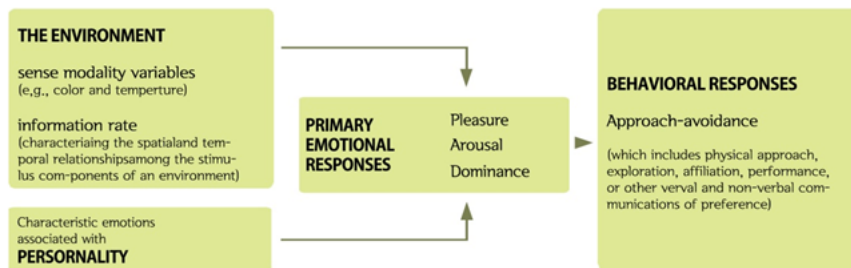

Figure 1: Concept of Environmental Psychology<sup>1</sup>

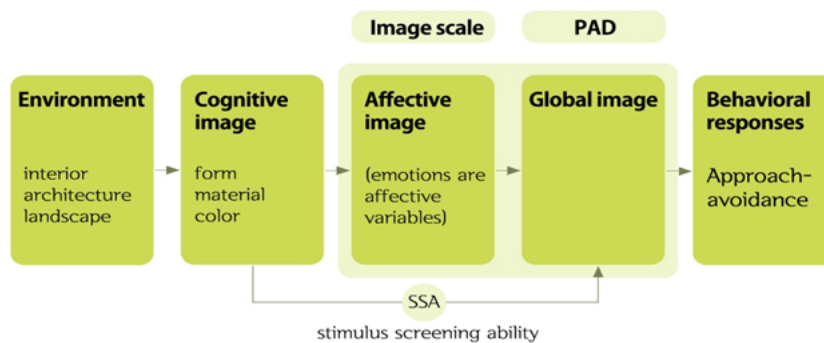

Figure 2: Flowchart of the Process of Image Formation.

<sup>1</sup> Albert Mehrabian and James A. Russell, An Approach to Environmental Psychology, Messachusetts: The MIT Press, 1974, p.8

## 2. THREE PRELIMINARY EXPERIMENTS AS A PREPARATORY STUDY

This paper investigates human being's affective responses on the artificially made architectural space through empirical methodology used by environmental psychologists. Controlling for various space attributes, experiment is carried out by changing wall colors with the largest stimulating effect. Three preliminary experiments as a preparatory study are performed. The first experiment is about people's favorite colors. The result of this experiment is that in verbal expression Blue is most preferred but it is not consistent with the preferred color in color chips and physical objects. In the second experiment, participants were required to evaluate the adjectives for single color chips and interior space images which had been chosen by consulting experts.

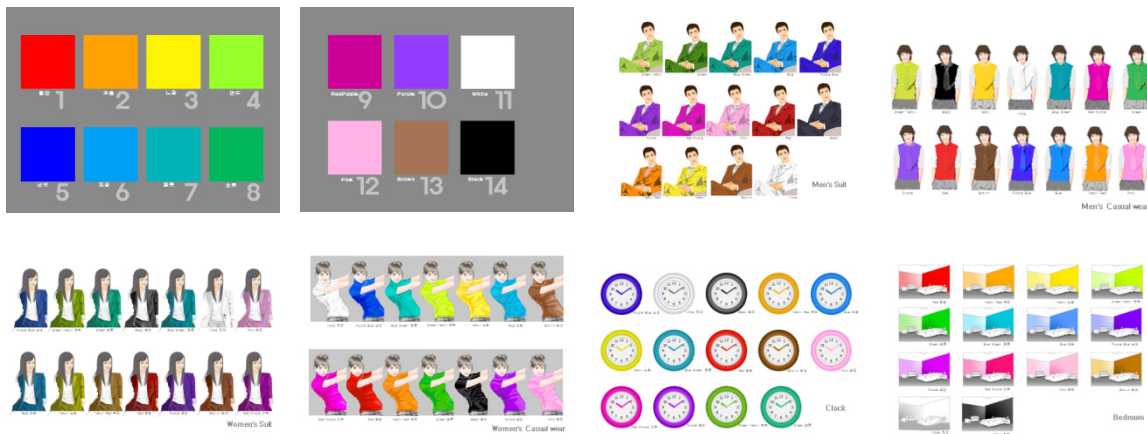

Figure 3: Images for the Second Experiment.

These adjectives were factor analyzed and some factors were found, but grouping was not easy because adjectives in the same factor had ambiguous common attributes or redundant meanings. Most of these adjectives are cognitive ones that are applicable criteria in an area of planning, implementation and evaluation, and they are characteristic languages not to be overlooked in design in the process of people's recognizing and responding to environments. Meanwhile, to investigate the relationship between those adjectives and PAD (pleasure-arousal- dominance) which had been developed to express only human affective feelings, 18 adjectives belonging to PAD were factor analyzed. As a result of factor analysis, three factor of pleasure, arousal and dominance were extracted accurately and individually. That is, whereas adjectives in cognizing step could be extracted innumerably according to environments, the pure affective responses can be condensed into PAD which is reasonably stable even in changing situations. In a third experiment, professional designers were asked to express their affective feelings about physical environment and CG (computer graphic). There were no significant difference between those two environments.

## 3. MAIN EXPERIMENTS AND DISCUSSION

In the main experiment, a total of 202 subjects with different occupations participated in the experiment. Occupations are classified into five groups, namely, architects, space designers, other designers (visual, product, fashion etc.), college students majoring in space design and laypersons. The space to be evaluated is a college classroom equipped with comparatively simple space forming elements in which only wall colors are changed into 15 images with different hues under the same conditions of size, finishing materials, lighting and furniture.

And participants were asked to express their feelings (PAD), preferences (approach-avoidance) and appropriateness as a learning space about spaces using large screen and printed 3D perspective Image.



pleasure-displeasure		arousal-nonarousal		dominance-submissiveness	
happy	unhappy	stimulated	relaxed	controlling	controlled
pleased	annoyed	excited	calm	influential	influenced
satisfied	unsatisfied	frenzied	sluggish	in control	cared-for
contented	melancholic	jittery	dull	important	awed
hopeful	despairing	wide-awake	sleepy	dominant	submissive
relaxed	bored	aroused	unaroused	autonomous	guided

Figure 4: Classrooms for Main Experiment.

Table 1: PAD adjectives<sup>2</sup>.

Finally, to assess individual differences in automatic screening of and habituation to irrelevant stimuli, participants were asked to complete the 34-item stimulus screening ability (SSA) questionnaire. Repeated measure MANOVA revealed that there were significant differences in dependent variables according to gender, colors, hues, occupations and SSA. Pleasure ratings were significantly higher (1) for female than male. and (2) for pale tone than vivid or dull tone and (3) for space designers than other groups. On the other hand, arousability ratings were higher (1) for male than female and (2) for vivid or dull tone than pale tone and (3) for laypersons than other occupations. People feel more pleasant in pale tone than in dull tone and preferred pale tone. Compared to other occupations, space designers rated dull tone as pleasant. Peculiarly although space designers' SSA was the lowest, they felt more pleasant about space than any other occupation and showed no negative responses to almost all hues and tones. Architects' SSA was the second lowest. But these architects showed negative responses to strong hues in space. Most of space designers positively agreed that any color can make environments pleasant with designer's creativity and lighting. Other designers frequently dealing with colors showed passive or negative responses to space colors, in spite of high SSA which could be interpreted as arising from the fact that there are various forming attributes and other designers did not experience the attributes of a larger space than the one they deal with.

Table 2: Rates of PAD.

Table 3: Preferences & Appropriateness.

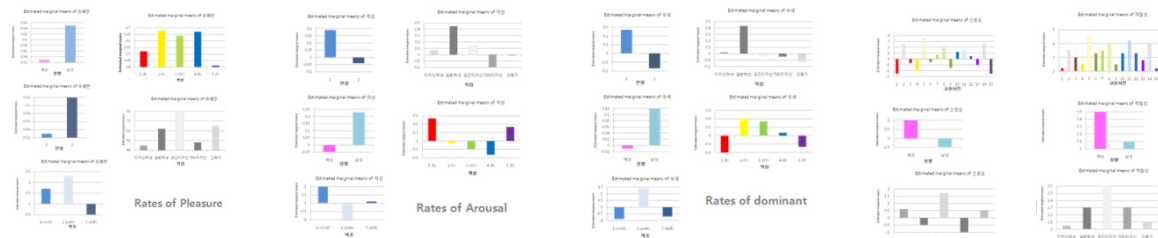

This study, via empirical experiment, elicited diverse results about space colors that are key factors causing affective responses to environments. They may be different preferences, appropriateness and cognitive evaluations about space environments according to changing objects and situations, but affective responses occurring concurrently and continuously could be measured by these factors of PAD which can be distinctly discriminated and evalu-

ated. Above all, SSA may be a moderating factor in the effect of space environment on affective feelings. But SSA can be used to evaluate only personal inclinations to ordinary environments and it is questionable whether SSA could be applied to environments with intentions of 'pleasant and efficient function' such as architectural environments.

#### 4. LIMITATIONS

The limitations of this study bring forth some future research areas. Subsequent researches in which new development of SSA in architectural and space design and researches on affective responses in cognition step assumed as design characteristic should be performed can make a great contributions to researches in environmental psychology of design fields.

#### REFERENCES

- Gil, S.M., and J.R.B. Ritchie, 2009. Understanding the Museum Image Formation Process, *Journal of Travel Research*, 47(4), 480-493.
- Kwallek, N., K. Soon and C.M. Lewis, 2007. Work Week Productivity, Visual Complexity, and Individual Environmental Sensitivity in Three Offices of Different Color Interiors, *Color Research and Application*, 32(2), 130-143.
- Russell James, A., and A. Mehrabian, 1977. Evidence for a Three-Factor Theory of Emotions, *Journal of Research in Personality*, 11, 273-294.
- Yildirim, K., A. Akalin-Baskaya and M.L. Hidayetoglu, 2006. Effects of Interior Color on Mood and Cognitive Performance. *Building and Environment*, 42, 3233-3240.

*Address: Prof. Eunmi Yu, Division of Interior Design,  
Semyung University, Jecheon-si, ChungBuk-do, 390-711, KOREA  
E-mail: aninolka@daum.net*

# Bringing Colours to Urban Nightscapes: Spotlights on the Built Environment

Pauline ROBERT,<sup>1</sup> Georges FARHAT<sup>2</sup>

<sup>1</sup> Laboratoire de l'Ecole d'Architecture de Versailles (LéaV),  
Université de Versailles Saint-Quentin, ENSAV, France

<sup>2</sup> JH Daniel's Faculty, University of Toronto, Canada, LéaV, Versailles, France

## ABSTRACT

Spectrometric data on nocturnal illumination (LED) has been gathered at the parks of La Villette, Paris and Gerland, Lyon to assess intracellular and physiological responsiveness of *Acer saccharus* (sugar maple) and *Betula pendula* (birch tree) to the EMR in the red and blue spectral regions. The methodology consisted of incorporating the data collected in situ into a series of graphical plates concerning each case study and consisting of: a hemispheric photograph taken by night under an assigned angle; recorded measures of the radiant existence; and the latter's location within the visible spectrum. Next, the same data were cross-examined with relevant intracellular parameters of light inhibition in plants, with a focus on cryptochromes and phytochromes. The plates described above were eventually re-used to verify how the spectral data collected correlates with microbiological markers. The study isolated two patterns of night-time chromatic interventions into the built environments, and suggested that these can lead to numerous structural and functional alterations in floristic populations. The changes were found to depend on light quality and spectra, and span from parenchymal enhancement to canopy shrinkage. These suggest impending opportunities and challenges for architectural and landscape architectural praxes, and calls for further explorations of landscape's cultural-byophysical dichotomy.

## 1. INTRODUCTION

Colour manipulation is commonplace in the architectural lighting design in the architecture of the metropolitan night (Zardini and Schivelbusch 2005). In Europe, the cities of Paris and Lyon have been highly praised for bringing colours so ingeniously into their vibrant nightlife. Nocturnal coloration of the Eiffel Tower is a case in point, attesting enough to the rising significance of colour in place- and ambiance-making in the French capital. Lyon, the "bright" rival of Paris, has been credited with one the most comprehensive outdoor lighting programme integrated into its urban development strategy. These two cities are also famous for their impact on the globalisation of nocturnal urbanity: the *plan lumiere* of Lyon has been transposed to many other cities (e.g. Montreal), and the Paris-born *nuit blanche* can now be considered as an undeniably transnational festivity (Jiwa et al, 2009).

Yet, in the depth of the urban night featuring such abundance in colour, even an unaided eye will detect a shade of frustration over the extended electromagnetic radiation induced by the outdoor lighting (Davis et al, 2013; Menegaux et al; 2013). Recent research demonstrated both positive and the adverse effects of over-illumination on human and other living species' health (Turner et al, 2010; Terfa et al, 2013; Brüning et al, 2011). Landscape studies can add to this scholarship as they help locate spatiotemporal, biophysical and semantic dynamics of the built environment (Farhat 2011a; Farhat2011b) within the larger trends and developments in science, technology, and their cultural construction (Latour 2012).

This paper is concerned with night-time chromatic interventions in parks and gardens. Stemming from earlier research on light ambiances (Robert et al, 2012), and nocturnal urbanity (Robert and Farhat, 2013), it questions the appropriateness of the targeted nocturnal illumination (coloration) of selected species of flora in the parks of La Villette, Paris and Gerland, Lyon. It seeks to verify plant sensitivity to the radiant flux, and contribute to the ongoing interdisciplinary research on the optimization of nocturnal lighting in parks and gardens aimed *inter alia* at gaining knowledge on plant stress, adaptation, and potential morphological alterations (Combes, 2007).

## 2. RATIONALE

The choice of the sites and species conformed to a set of criteria defined in advance of the experiment. The sites had to be culturally and artistically important landscapes with sophisticated chromatic nocturnal lighting regimes sustained over a lengthy period of time, and in function since the park's opening. Other criteria for the selection were size, location, integration into the city infrastructure, and the presence of native plants.

Out of some thirty parks and gardens matching these markers, we chose the park of La Villette in Paris, famous for its nocturnal lighting, and the park of Gerland in Lyon, featuring a *jardin chromatique* (a chromatic garden). Singular in their perceived color expression (Robert et al, 2012), divergent in the light ambiance they generate (Robert et al, 2012), these landscapes share a common feature with regard to night-time lighting conceived in both cases to be the integrant part of their initial design. In this sense, La Villette and Gerland constitute unique laboratories for the studies of nightscapes. Similar approach was adopted in selecting the species: sugar maple at La villette and the birch tree at Gerland.

## 3. MATERIALS AND METHOD

A tunable radiospectrometer with a fiber-optic interferometric component (supplied by the INRA Lusignan) was used within a protocol established to ascertain the power of EMR, its frequency, and distribution on and in the proximity of the species selected. Such variables as hour, temperature and other meteorological conditions were taken into account. The distance variable was set arbitrarily because the procedure aimed at gathering information about the quality of the light.

Data systematisation and analysis were processed by the INRA-created software application, and the results were reproduced by means of graphical plates. The latter concerned each case and consisted of three parts: 1) a hemispheric photograph taken by night under an assigned angle; 2) the variations in radiant flux (radiance vs wavelength) in the form of a graph, and 3) the reproduction of the same chart on the visible spectrum background. In these plates was ascertained the hiatus between the perceived and measured spectra (fig.1).

At the next stage, the same data was cross-examined with relevant intracellular parameters of light inhibition in plants, with a focus on the cryptochromes (blue light sensitive flavoproteins) and phytochromes (red light photoreceptors). The plates described above were re-used to verify how the spectral data collected fits in the sensitivity range of these microbiological markers.

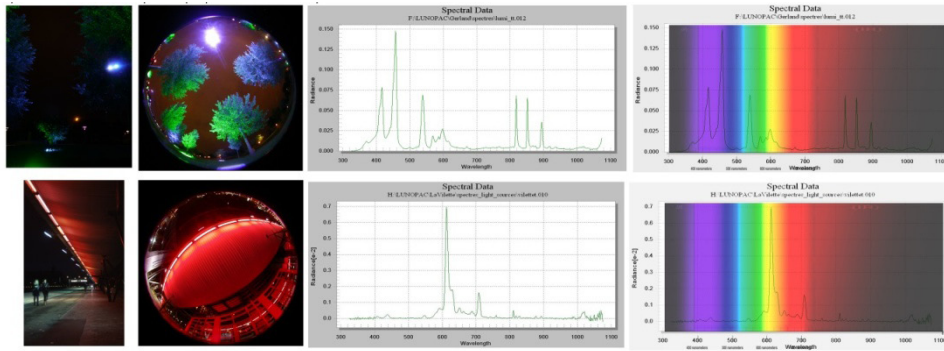

Figure 1: Graphical plates showing the perceived colors, radiant existence and spectral composition in nocturnal illumination of *B. pendula* and *A. saccharum* illumination in the parks Gerland, Lyon (top) and la Villette, Paris (bottom).

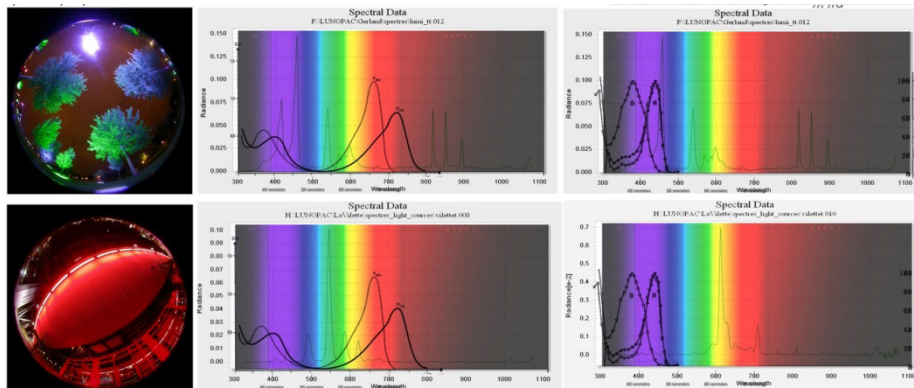

Figure 2: Graphical plates showing the juxtaposition of the data from Fig. 1 with the spectra of sensitivity of cryptochromes and phytochromes in *A. saccharum* and *B. pendula* in the parks Gerland, Lyon (top) and la Villette, Paris (bottom).

#### 4. RESULTS AND DISCUSSION

It ensues from the analysis that the type of lighting in the case 1 (Gerland/ *Betula pendula*) is composed of the wavelengths that have a certain impact on betulaceae and related floristic species, which a sensitive to the blue spectrum. It can be further assumed that this type of light (and outdoor lighting) may have an even more considerable impact on phytochromes. The results from case 2 (La Villette/ *Acer saccharum*) demonstrated that, in spite of the dark Red identified by the naked eye, the radiant flux is dominated by Orange and Yellow. It is currently thought that these wavelengths are received by neither phytochromes nor cryptochromes.

It can be argued that La Villette-type lighting solutions would eventually lead to the deficit in Blue and the parenchymal enhancement in sapindasceae, such as the rock maple, and, possibly, other species of its genus and family. Such a conclusion points to the broader dilemma over the hiatus between environmentally ethical and economically effective ways to produce landscape the urban space. Gerland-type chromatic interventions are believed to provoke morphological and functional alteration in flora, and especially in betulaceae. Such changes may vary from canopy shrinkage to various irreversible intracellular changes with outcomes suggestive of both new opportunities and challenges for the human society.

## 5. CONCLUSION

Developments in outdoor lighting technology and bio-physiological evolution of flora belong to the expanding continuum of variables that define and will keep defining not only the shape of our landscapes, construed as a living patrimony. They will also expedite and accompany a reappraisal of the societal and moral norms such heritage is associated with. Consequently, any prevention or preservation measures, including optimizing chromatic interventions or other types of environmental stress, are pointless. Current and future changes in landscape morphology will call for other meanings and paradigms. And these have been already arising out from the encounters between culture, science, and practice.

## ACKNOWLEDGEMENTS

The authors thank Dr. Didier Combes of the INRA Lusignan for guiding the experiment and Plantes et Fleurs association (Paris) for their generous support of fieldwork. The authors extend their thankfulness to three AIC 2013 anonymous reviewers who commented the first draft of this paper.

## REFERENCES

- Davies, T.W., J. Bennie, R. Inger, N.H. Ibarra and K.J. Gaston, 2013. Artificial light pollution: Are shifting spectral signatures changing the balance of species interactions? *Global Change Biology*, 19(5): 1417-1423.
- Farhat, G., 2011a. « Archives et paysage : du site comme agent historique », *Introduction to the dossier "Archives de paysage"* ed. by G. Farhat, *Colonnes, Archives d'architecture du XXe siècle*, 27, 50-55.
- Farhat, G., 2011b. "Infrastructural Landscape: beyond Memory and Metaphor", in *Infrastructural Urbanism* eds. T. Hauck, R. Keller, & V. Kleinekort. Berlin: DOM publishers, 273-287.
- Combes, D., L. Bousquet, S. Jacquemoud, H. Sinoquet, C. Varlet-Grancher and I. Moya, 2007. A new spectrogoniophotometer to measure leaf spectral and directional optical properties. *Remote Sensing of Environment*, 109 (1), 107-117.
- Jiwa, S., J. Andres Coca-Stefaniak, M. Blackwell and T. Rahman, 2009. Light night: An "enlightening" place marketing experience. *Journal of Place Management and Development*, 2(2), 154-166
- Latour, B., 2012. *Enquete sur l'anthropologie des modernes*. La Decouverte. Paris (à vérifier)
- Robert, P., D. Combes, L. Mudri and G. Farhat, 2012. « Extérieur nuit: pour une anthropologie biophysique et culturelle des paysages nocturnes des parcs urbains », in *Ambiances en actes / Ambiances in Act, 2nd International Congress on Ambiances*, Canadian Center for Architecture, Montreal.
- Robert, P., and G. Farhat, 2013. Biophysical and cultural nightscapes: three protocols for sensorial perception and representation of an artificial day. In *EEIA 11 2013 Congress for Envisioning Architecture*. Proceedings. Milan. (forthcoming)
- Zardini, M., and W. Schivelbusch, 2005. *Sense of the city: an alternate approach to urbanism*. Montréal, QC: Canadian Centre for Architecture = Centre canadien d'architecture.



# The Implementation of New “Colour and Light” Urban Scenarios through New Lighting Technologies and Design Methods

Henriette JARILD-KOBLANCK,<sup>1</sup> Jan EJHED,<sup>2</sup> Monica MORO,<sup>3</sup>

Siddharta DELLA SANTINA<sup>4</sup>

<sup>1</sup> LTU Luleå University of Technology, Sweden

<sup>2</sup> KTH Royal Technological University and LNU Linnaeus University, Sweden

<sup>3</sup> Polytechnics of Milan, Italy

<sup>4</sup> UBC The University of British Columbia, Canada

## ABSTRACT

The following Lighting Design research project is collocated inside the ongoing larger research named LCS-Light, Colour and Space. It has been carried out in China, at the Shanghai-based University Campus, the ATDF (Aalto-Tongji Design Factory), the Sino-Finnish Centre part of the Tongji University and of the Aalto University Design Factory. The course was a collaboration between the Swedish Linnaeus University LNU, the Swedish Royal Technological University KTH, the Swedish Faculty of Design Research and Research Education and the Sino-Finnish Tongji University.

The idea behind the workshop was to further test the ITK - Identity Tool Kit - design method in a different social and cultural environment in order to consider the value of this tool in communicating beyond language and culture, making thus efficient communication bridges. In particular the course was intended to give the students a greater knowledge of lighting design and modern light sources such as LEDs. The participants were guided to learn more about how to work in groups as a stake holder, about testing ideas in full scale and developing deeper knowledge through reflections on the meaning and employ of light, colour and shape.

## 1. INTRODUCTION

This Lighting Design research project is collocated inside the ongoing large research named LCS-Light, Colour and Space, which is a research carried out through workshops in academic surrounding. Light, colour and space are seen as necessary tools for designers, architects and professionals working with ideating and creating human environment. Hence the need to be able to communicate different views and issues, regarding these three main themes, with the final user and with the commissioner. One of the ways to investigate these qualities is to proceed through a series of workshops involving students in the field of design.

Given the fact that design is not fixed but is continually developing, we need to distinguish between how it is constituted as a subject for design researchers and those who educate them and how subject matter is constituted for scientists and scholars in the humanities. When we study design, we study a form of human action that arises from a social situation. Design is thus part of the study of society rather than nature. According to the social constructivists, society itself is a contingent phenomenon whose structure and organisation, like design products, is human made rather than decreed by nature. Like design research, social research may be concerned with what has been done, what currently is and what might be. (MARGOLIN 2009: 1)

The possible development of research in the field of Design was previously pointed out by professor Richard Buchanan in the paper he presented at the London Design Council in 1999, UK and at the Design and Research Symposium in 2000, at the Polytechnics of Milan, Italy.

The workshop has been carried out in China, at ATDF Aalto-Tongji Design Factory, which is a concrete cooperative project shared by both the Finnish and the Chinese Universities as well as the starting point of shared didactics. ATDF hosts various multidisciplinary and international courses, happenings, projects and initiatives. It is “a creative environment bringing together universities, business and society to create new ways of learning, research and innovative collaboration”. It is in other words a platform where students and researchers encounter enterprises and society. ATDF is also testing how the Finnish Aalto Design Factory concept functions and develops in a different culture.

The lighting Design Course took place in Shanghai, March 26th to April 15th , year 2012 and it was a collaboration between the Swedish Linnaeus University, the Swedish Royal Technological University (KTH), the Swedish Faculty of Design Research and Research Education and the Sino-finnish Tongji University.

The idea behind the workshop was to further test the ITK – Identity Tool Kit – design method in a different social and cultural environment in order to consider the value of this tool in communicating beyond language and culture, making thus efficient bridges, so to build platforms from which design plans may develop where the jointed visions of designers and commissioners a s o encounter.

In particular the course was intended to give the students the acquisition of a greater knowledge of lighting design and modern light sources such as LEDs. The participants were guided to learn more about how to work in groups as a stake holder, about testing ideas in full scale and developing deeper knowledge through reflections on the meaning and employ of light, colour and shape.

It was also a workshop about the identity of a place and its aesthetic aspects and how new technology has changed much aspects of our everyday life, especially in urban context.

## 2. METHOD

The goal to be achieved by the students was focused in the attempt to integrate the design Faculty building, which is a converted old engineering school, with the still underdeveloped rural surroundings, through the use of colour and light. The students worked, in a first step, on their own, exploring, describing and gathering documentation about the areas and the building to be illuminated, during day time but also after dark. Then, in a second step, they worked on the development of a concept based on their observations using the ITK methodology.

The ITK (identity tool kit) method was designed by Henriette Jarild-Koblanck on the purpose of assisting designers and clients in the creation of visual platforms and identities in relation to product and service development. The method creates a more inclusive and easily accessible design procedure applicable to a wide array of design projects, both academic and professional.

The formulation and testing of the method began several years ago and has complexively been employed by more than 600 university students within several disciplines and also in numerous projects outside of academia.

Many students have continued to use the method as they have embarked on a professional career within the field of design. The identity tool kit has proven to achieve set goals within different areas of design and in relation of different types of design processes. Crucially, the identity tool kit is more than just a design method since it has extensive management implications. (KOBLOCK 2009: 2)

The method consists of six individual steps and the process initiates with mood boards describing what the company presently stands for and what the future visual identity should express (Figure 1).



Figure 1: Image illustrating the process of ITK by the Orange Group.

The position board is the second step and it is aimed to describe the context within which the organization operates, followed by step three and then four, the shape and colour. At this point a maximum number of colour and forms to take in consideration in the design process are decided, in order to obtain a clear final visual profile.

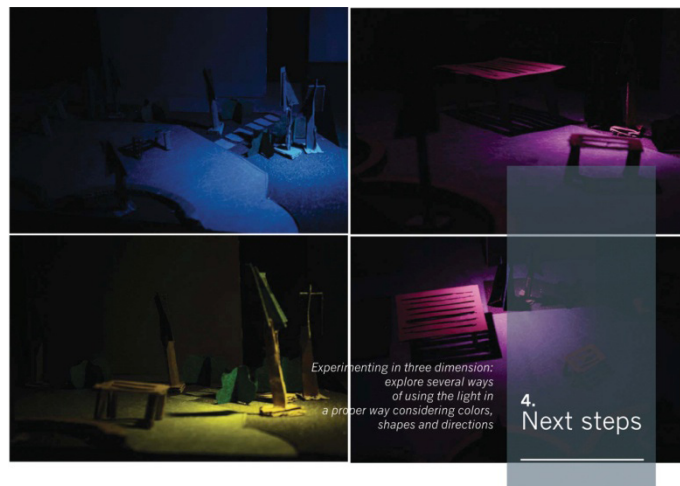

Figure 2: Image illustrating the final presentation by the Orange Group.

The tone, step number five, taking the form of key words, has the goal of arriving at an idea of the emotional and conceptual framework for the future profile and visual identity. Finally we arrive to the guidelines, step six, of the project. All the material is compiled as guidelines for the following design work, as at this stage all components of a new visual

identity are present, shape, colours and tone will be easily employed by the designer in order to create his design.

The students participating in the workshop were asked to continually making reflections on the connection between their concepts and the final full – scale installation, reflections such as: when was it time to take advantage of lighting design in the process of making the identity of places in the city, how to save energy and how to give a feeling of security, aesthetics and identity to a place.

### 3. RESULTS AND DISCUSSION

The final presentation comprehended the completion of a full scale installation (Figure 2). The students thought that employing ITK greatly improved and facilitate their final design in reducing and making clear the choice of colour, light and shape.

### 4. CONCLUSIONS

On the whole the projects developed by the students were very satisfactory and the use of the identity tool kit conformed its value in overcoming communication issues where there were different views.

### ACKNOWLEDGEMENTS

Thanks to all who have helped carrying out this research, to all the Universities involved and the students that have participated.

### REFERENCES

- Buchanan, R. 1999. *Design Research and the New Learning*, Paper based on the conference Researching Design. Designing Research, London Design Council.
- Koblanck, H. 2009. *ITK*, Nordic Design Research Conferences, Engaging Artifacts.
- Koblanck, H. and M. Moro 2010. *In search of Linnaeus' colours*, Colore, Quaderni di cultura e progetto del colore, Ed IDC Colour Centre.
- Koblanck, H. and M. Moro 2012. Color and shape applied to product design, In *the VIII National Color Conference proceedings, Bologna, Italy, Colour and Colorimetry, Multi-disciplinary contributions, Vol VIII/B*, Ed Maggioli.
- Margolin, V. 2009. *Doctoral Education in Design*, Design Education, ELISAVA TdD 26.

*Address: Prof. Henriette Jarild-Koblanck, Department of Art, Communication and Learning, Luleå University of Technology, 971 87 Luleå, Sweden*  
*E-mails: henriette-jarild.koblanck@ltu.se, Jan.Ejhed@sth.kth.se, monikamoro@yahoo.it*

# Study on the Emotional Color Characteristics of Reflectance and Transmittance of Exterior Glass Architecture

Jiyun CHEON, Gyouun-sil CHOI, YungKyung PARK  
School of Art and Design, Ewha Womans University

## ABSTRACT

Glass facades of modern architecture are appearing very prominently in major cities in Asia, and the Americas as well as in domestic properties. This is due to advantages such as ease of processing glass ash exterior materials, light weight, high specification, as in the creation of the modern space that have been used extensively. In this study, glass facades of buildings which were completed in Republic of Korea since 2007 were carefully selected and grouped in four by the reflectance and transmittance physical properties of glass. The brightness and saturation values were analyzed through clustering of images taken and hue was excluded. Then a survey was conducted to correlate emotional adjectives to the physical attributes. The results of this study are as follows. Reflectance affects the saturation, and transmittance affects the lightness and this is due to the amount of sunshine. Therefore, for the actual planning of the glass facade of a building color saturation should be considered to change the reflectivity of the glass and brightness for the transmittance. High reflectivity-low transmittance of buildings reveals a tendency of high brightness-low saturation while, low reflectivity-high transmittance reveals high saturation-low brightness. From the results of the survey, emotional adjectives associated with reflectance sum up to modern, sleek, and perfect and the most closely related to the transmittance is crisp.

## 1. INTRODUCTION

In the terms of design, glass having superior workability has been regarded as a main exterior material of the modern architecture with the technological development in pursuit of lightening and simplification of the architectural exterior materials. As the architectural material, applying glass to the exterior makes flexible design according to the various intentions of architects rather than makes simple mass beyond the concept of the surface surrounding the interior structure. Glass, though transparent and durable, has a very fragile image in the terms of energy. To improve such a thing, glass preserving a transmission property of visible radiation and cutting heat energy was developed for the exterior material. Exterior glass, having an outstanding heat insulation property and appearance, is used widely but it has a difficulty in the color planning if only there's information on reflectance and transmittance.

With increasing interest in glass for the exterior material, this study intends to identify a correlation between reflectivity· transmittance of a building and color shown from the appearance. In addition, questionnaires were conducted about whether it's possible to feel a change of Brightness and Saturation values according to the difference of reflectance and transmittance when seeing with the naked eye. So it aims at examining a correlation and suitability with sensitivity adjectives. Comparing relative color values rather than correct ones, it's expected to be helpful for more accurate color planning of exterior glass.

## 2. METHOD

This study was done for domestic buildings of glass exterior completed after 2007. Researching domestic glass exterior construction cases firstly, it identifies reflectivity· transmittance of visible radiation of glass used for exterior finishing. 7 buildings having distinct physical differences were selected for image photographing. The photographing position is located at the place away from 50-150m according to the height of a building. As an image photographing of a building is much influenced by the condition of the outside air, sunny climate was established in principle so the condition of the air wasn't considered. With the same camera specifications (Panasonic Lumix DMC-FX36), photographing was done between 12 and 3 p.m. The research was done as follows:

- 1) Photograph 7 buildings according to the schedule.
- 2) Extract 30 RGB values through clustering of 7 photographing images.
- 3) After transforming analyzed RGB values into  $L^*$  and  $C^*$  values on CIELAB (CIE, 1976) according to the sRGB criterion, make a graph of data and compare Brightness and Saturation.
- 4) For 20 persons majoring in color, conduct questionnaires about 7 photographic images and examine a correlation between reflectivity, transmittance and sensitivity of glass exterior buildings and adjectives.
- 5) Consider findings of clustering and questionnaires synthetically.

### 2.1 Photographing Setting

Image Photographing-Most of all, sunshine amount is important in photographing of glass exterior. When the amount of sunshine shone on the surface of a building is constant, correct comparison is possible based on reflectivity· transmittance. Therefore, as shown from (Fig. 1), photographing position was set as the northeastern direction of the building to secure constant amount of sunshine. In order to reduce influence of neighboring circumstances, reflection of the surrounding buildings was minimized through setting a photographing angle from the bottom to the top. Camera photographing images were assumed as sRGB.

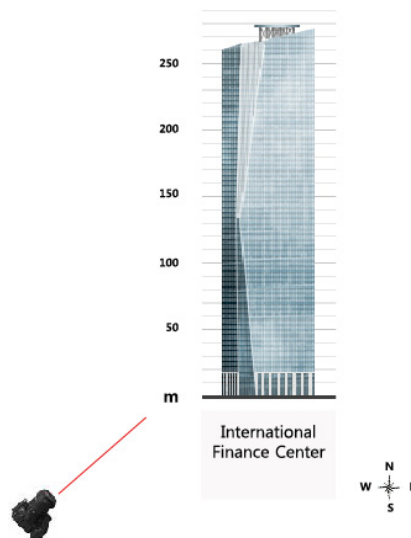

Figure 1: direction photographing.

## 2.2 Questionnaire Contents

For 20 persons majoring in color, questionnaires were conducted by selecting 16 adjectives related to glass exterior. Presenting images of 7 buildings directly photographed, they were asked to check on the questionnaire using the Likert 5-point scale of the interval scale much used in the social science. (Table 1) shows emotional adjectives.

Table 1. Emotional adjectives.

1. light	2. transparent	3. cheerful	4. sleek
5. modern	6. innovative	7. futuristic	8. novelty
9. newest	10. clear	11. perfect	12. solid
13. bright	14. vivid	15. crisp	16. dark

## 3. RESULTS AND DISCUSSION

In this study, as for color analysis, 5 colors of the top frequency were selected from 30 values of each image to get rid of the reflector of neighboring buildings. Because even when natural conditions excepting a building are excluded, parts to be reflected or transmitted can't be overlooked in terms of the characteristic of glass exterior buildings. Using other finishing materials with glass should be considered.

### 3.1 Findings of Color Analysis

It shows that visible radiation reflectance of glass exterior relates to the value of saturation like (Fig. 2). The higher reflectance is, the lower saturation is. The lower reflectance is, the higher saturation is. It also shows that the higher reflectance is, the higher brightness is. However, there's no significant difference under certain level of reflectivity. The visible radiation transmittance of glass exterior relates to the value of brightness significantly like (Fig. 2). The higher transmittance is, the lower brightness is, the lower transmittance is, the higher brightness is. The value of saturation showed almost similar level in the transmittance. Furthermore, as transmittance is lower, brightness is higher. It seems to be related to higher reflectivity.

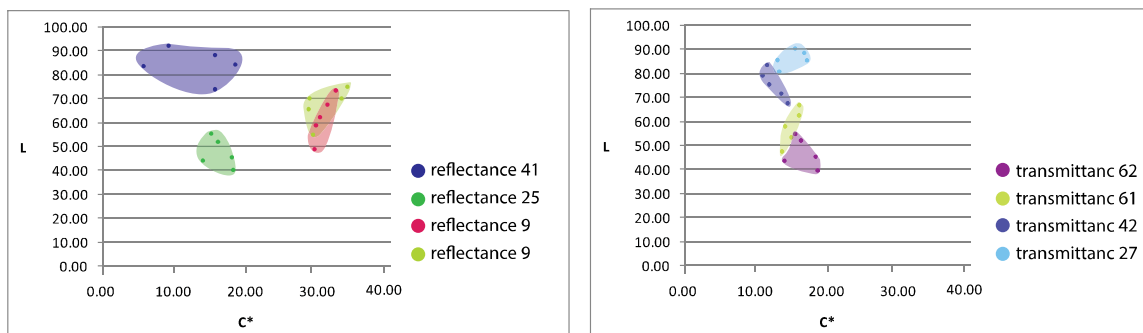

Figure 2: Color Difference according to reflectance and transmittance.

### 3.2 Analytic Results of Questionnaire

When reflectance is higher, it's likely to give impression of modern, sleek and perfect. When transmittance is higher, it's likely to give impression of crisp.

#### 4. CONCLUSIONS

Selecting 7 domestic glass exterior buildings completed after 2007 and dividing them into 4 each according to reflectivity· transmittance of physical properties of glass material, this study conducted color analysis and questionnaires. Considering similar colors caused from characteristic of glass finishing material, values of brightness and saturation were only analyzed excepting color. As the result, it shows that reflectance has an effect on saturation and transmittance relates to brightness. In addition, in case of a building having high reflectivity-low transmittance, it has a tendency of high brightness-low saturation. On the contrary, in case of a building having low reflectivity-high transmittance, it has a tendency of high saturation-low brightness. Also, it shows that sensitivity adjectives related to reflectance contain modern, sleek and perfect. Transmittance has the closest relation to the adjective of crisp.

#### REFERENCES

- Arbab. M., and J.J. Finley, 2010. Glass in Architecture. *International Journal of Applied Glass Science* 1(1): 118-129.
- Choi. Y.J., S.H. Yoon. G. Kim and K.H. Lee, 1999. A Study on the Expressional Characteristics of Glass in Contemporary Architecture. *Architectural Institute of Korea* 19 (1): 3-8.
- Jeon. Y.H., and M.J. Cha, 2009. A Study on the Evolving Conception of Glass-Envelope Expressed in Contemporary Architecture. *Architectural Institute of Korea* 25 (11): 13-20.
- Kweon, J.H., 2010. A Study on Spatial Visibility Network Analysis Considering Visibility of Glass. *Architectural Institute of Korea* 12 (4): 125-136.
- Park, J.Y., 2007. Characteristics & Use Tendency of Glass as Architectural Material. *Society of Air-conditioning and refrigerating engineers of Korea* 36 (8): 11-18.
- Quan. M.Z., M.K. Kim and J.S. Lee, 2010. A Study on the Form Configuration Characteristics and the Design Factors of the Skyscrapers in China. *Architectural Institute of Korea* 12 (3): 29-38.

*Address: Jiyun Cheon, Department of Color Design, International Education Building  
1301, Ewha Women's Univ., Daehyeon-dong, Seodaemun-gu, Seoul, Korea  
E-mails: jyjy4@gmail.com, gschoi@ewha.ac.kr, yungkyung.park@ewha.ac.kr*



## Alvar Aalto and Kazimir Malevich: Second Thoughts on Colour Environment

Joaquim SANTOS

Faculty of Architecture and Arts, Lusíada University, Lisbon, Portugal  
Architect, Docent in History of Art and Theory of Architecture.

Researcher at the Research Centre in Territory, Architecture and Design,  
Colour Laboratory (CITAD) at the same university.

Doctor of Philosophy, Tampere University of Technology, Faculty of Architecture, Finland

### ABSTRACT

Kazimir Malevich's painting *Black and White* (1915) is an intellectual statement in colour, that is, in it he made colour precise, in other words, he gave colour an infinitesimal precision, a mathematical precision that colour has never lost. Alvar Aalto made the whiteness of snow and ice an active part of his architectural designs, which he would combine either with *other* white matter or other colours of architecture. Northern environments, perhaps due to what is regarded as the eight seasons that have been modulating culture for thousands of years, pay special attention to the colour of the natural environment where white may be so objective or enigmatic and thus become central to the artistic act. Among his works, Villa Mairea, Muuratsalo Experimental House, Seinäjoki Town Centre, Säynätsalo Town Hall, *Vuosenniska Church*, *Finlandia Hall* and the often criticized *Enso-Gutzeit Headquarters* certainly reveal a precise work in the white-colourful-environment. It could be said that Malevich provided the selective intellectual framework, a perfect geometrical-mathematization of colour, whereas Aalto provided a sensitive interpretation of the environment. Nonetheless, both meet at the end because white nature seems more accurate than the painting. There is no such thing called white, but whites, and they change according to the intensity and direction of light. Thus one may claim that there is a certain white discourse in Aalto's oeuvre that is not the common discourse often associated with some modern architecture but a careful discourse of a white-colourful environment.

### EUCLEDEAN SPACE HAS NO COLOUR

The creation of orders is based on the laws of geometry. The perception of orders must bring other factors into play. The geometrical structure of a visual design can never, by itself, allow us to predict the effect it will have on the beholder. In one respect this is obvious: structure is independent of scale while perception is not. Merely enlarging or reducing a pattern may change the effect dramatically. (Gombrich 2002: 116)

The western art and scientific tradition of understanding space and working in accordance with space made a sense of "emptiness" reliable that easily accepts some kind of geometrical-mathematical structure, but it hardly accepts colour as a constituent part. "Emptiness" is the perfect territory of events and these might be colourful – but space itself is not. That is, spatial organization brings afresh a sense of bounded "emptiness" that the physical limits of floors, walls, ceilings and roofs, windows and doors, organized under some type of arrangement, make architectural and architectural thought possible. The laws of geometry seem to have determined our sense of order.

The natural world might be geometrical-mathematizable and yet it is not given under that shape unless we superimpose such a reading on it. The *artificial* order symbolizes what

is *natural* to *human nature*. Abstraction has no scale, but the human *body-mind-word* is a set of relations in which scale certainly is one of the most important. Basic concepts such as *size* are colourless and yet fundamental and basically grounded on individuals *being-in-the-world*. The vast mountain landscape, the wide breath-taking landscape of a prairie or the deep seascape are certainly colourful and hardly mathematizable but everything is somehow measurable in relation to my body which moves through the same “emptiness” that allows my eyes to see through the distance. These might mean that *colour* and *colourless* combine with each other at former moments that ground perception and thus consequent human manifestations at the levels of art and science might easily separate and combine both notions.

We thus have a symbolic struggle at the core of architecture. The architectural object must both be and symbolize some kind of physical space. Through the understanding of the classical orders as a metaphor for the human body, we should have in mind that the *canon* is a *geometric-mathematical motif* that gives a proper scale to the chaotic scale-free order of geometry. But once we have solved the paradigm of order (which seems to be the main issue), all that is not order must be undertaken by that order or, in other words, it is secondary to that order. Consequently, we hardly ever place colour at the core of architecture. It might occur occasionally, but has it the strength to superimpose its will? Besides, as far as colour is always the colour of *something*, the tendency seems to give colour a figurative character, along with human representation, by making some geometrical pattern readable and thus making colour tell a story that is not its own. Colour hardly comes to be an end in itself despite the splendour that it reveals. And yet, in what might be taken as a paradox, it is the sense of colour being an autonomous thing that makes it flexible and of use for very many purposes.

### PERFECTLY WHITE SPACE, NOT SO WHITE!

Modern craft-based architecture worked on sensible material, that is, a colour-texture-material synonymous of being-in-the-world by possessing an individual life, an inner truth that could not be replaced by any kind of upper geometrical order. Thus, following some sense of Renaissance Mannerist rustication, according to which material might become tangible to the senses by embodying another type of order, a new sense of materiality seemed strong enough to replace the former order of geometry. Thus, the architectural structure itself would emphasize the material that would make it stand up. Yet we can say that by stressing materials that bound and construct space, “emptiness” as a sense of being in space soon arrived and turned into a precise logic under Adolf Loos’s *raumplan* and, for instance, by taking the ceiling as something basic to architecture, that is former to colour. And Le Corbusier’s *promenade architecturale* proceeded according to similar lines. The classical tradition claimed a colourless world for its geometric-mathematical abstract order.

White then seemed to give architecture the clarity that also democracy was said to have given to architecture through the transparency of glass facades. And architectural thought should be transparent, too; *Architecture parlante* became not an end in itself but a method by which the architectural means of space production should elucidate human revelation. In this sense, white is symbolic of architectural thought and bounds the emptiness that design claims to make space liveable. Design would be the last canon that moves from the table and chair to the cup and to the lipstick. And somehow, smaller objects, whose *spatio-temporal* lives seemed shorter than that of architecture, seemed more attractive to received colour, a colour that we can easily touch.

## COLOUR-BLACK-WHITE ENVIRONMENT

The willow ptarmigan (*lagopus lagopus*) might be the bird that best symbolizes the colour metamorphosis of the northern spirit and the *colour-black-white-life-environment* seems a permanent unity, though nonetheless changeable. Extreme environments have a strong colour expression and *white-snow-ice* are able to present white in a relativistic way that displays a large variety of expressions and colour variations. One hardly sees colour perception free of the *natural-cultural* environment. Nature and natural colour expression frame a background to culture.

The white vernacular architecture of the Greek islands was not alien to Aalto, and his critic Demetri Porphyrios leaves us in no doubt about that. And it is certainly evident that Finland's extreme environment became an aesthetic inspiration. Aalto's Villa Mairea lives in accordance with different contrasts and similarities that change throughout the year and its white or green "screens" give the architecture a special touch. Here the logic of geometry and the logic of materials seem to combine perfectly. And the Muuratsalo Experimental House works in a similar way: white painted wall surfaces contrast with a display of natural brick or wood. We could think of similar themes in the *Vuoksenniska Church and the Finlandia Hall, too*.

The Seinäjoki Town Centre is similarly remarkable. The perception of the building complex in winter and summer is radically different. When snow covers the main street we move on a white surface that is interrupted by black stone steps and the floor that constitutes the atrium to the building. At this point the white colour that we have stepped on seems to move up to the ceiling. Certainly the town hall is best known for the particular shape of the blue (tile) covered surface, but the power of the white and black certainly plays a strong role in stressing that blue and it is particularly impressive that the black-white arises from an environmental logic.

And last but not the least, in the *Enso-Gutzeit Headquarters, le maudit*, white stands over the white-winter Helsinki sea displaying a monumentality that makes it a central focus for the whole environment. Its square windows become black and the logic of geometry and white return to the whole environment from where they previously arose in accordance with a classical viewpoint.

## BLACK-ON-WHITE

Much remains to be said about how Kazimir Malevich made the painting *Black and White*. Perhaps he could not think of *black-and-white* or express *black-on-white* if he had not fashioned an extreme white environment. Also, he would not have been able to think in that way if we would not have fashioned the geometrical Euclidean tradition.

We can think that within the extreme white environment, phenomenology and epistemology, the sensitive and the abstract, meet at the core of the subject and the *body-mind-world-colour-black-and-white* finds a precise eidetic meaning.

This brings to mind my first experience of the winter snow in Aalto's homeland, more than twenty-five years ago. In the early morning, as viewed from the window of my sixth-floor room in the city of Tampere, I could see the first winter snow arriving, covering all around. It was cool. In the distance a band of crows flew around some birch trees, now without leaves, their white spotted black trunks and branches giving a natural poetics of black-and-white. The blue sky had turned grey and was lost in a deep ancestor time. The glass window could

not mirror myself and the winter nature infused my entire sense of being. I no longer had colour. Colour no longer existed, but nature was still alive, and Friedrich Hölderlin's perfect colourful poem *In Lieblicher Bläue...* gave way to Malevich's *Black-on-White!*

### ACKNOWLEDGMENTS

Professor Isabel Braz de Oliveira, Head of the Colour Laboratory, Research Centre in Territory, Architecture and Design Lusíada University, Lisbon.

Lusíada University, Faculty of Architecture and Arts, Lisbon, and Minerva Foundation.

Portuguese Foundation for Science and Technology (FCT).

Gareth Griffiths, Architect, Helsinki.

### REFERENCES

Argan, G.C., 2004. *Arte Moderna. Do Iluminismo aos movimentos contemporâneos*. São Paulo: Companhia das Letras.

Gombrich, E.H., 2002. *The Sense of Order. A Study in the Psychology of Decorative Art*. London and New York: Phaidon Press.

Gravagnuolo, B., 1995. *Adolf Loos*. London: Art Data.

Harrison, C., and P. Wood (Eds.), 2001. *Art in Theory. 1900-1990. An Anthology of Changing Ideas*. Oxford: Blackwell.

Heidegger, M., 2002. *Ensaaios e Conferências (Vorträge und Aufsätze)*. Petrópolis, Rio de Janeiro and São Paulo: Editora Vozes and Universidade São Francisco.

Jellicoe, S., and G. Jellicoe, 1996. *The Landscape of Man*. London: Thames and Hudson.

Mosser, M., and G. Teyssot, 1999. *L'architettura dei giardini d'Occidente. Dal Rinascimento al Novecento*. Milan: Electa.

Santos, J., 2001. *The Architectural Object as Aesthetic Object. Alvar Aalto's House of Culture*. Tampere: Tampere University of Technology Publications.

Schildt, G., 1997. *Alvar Aalto in His Own Words*. Helsinki: Otava.

Schildt, G., 1984. *Alvar Aalto. The Early Years*. New York: Rizzoli.

Szadkowska, M., 2009. Van Duzer, Leslie; Černoušková, Dagmar. *Adolf Loos – Works in the Czech Lands*. Prague: City of Prague Museum and Kant Publishers.

*Address: Joaquim Marcelino Santos  
Rua Maria Lamas, 4 – 6º Esq. 1500-438 Lisboa. Portugal.  
E-mail: marcelino.c.santos@gmail.com*

# Color Bound: Book Artists Seek Inspiration from Color Theory

Jae ROSSMAN

The Robert B. Haas Family Arts Library, Yale University

## ABSTRACT

This exhibition took place at the Robert B. Haas Family Arts Library, Yale University, New Haven, Connecticut, United States, from January 2 through April 12, 2013. The materials presented are part of the Faber Birren Collection of Books on Color, part of The Robert B. Haas Family Arts Library Special Collections. The exhibition is a distillation of an ongoing research project about how artists have explored color theory in the book format. Rossman theorizes there are three recurring themes in bookworks made in this vein: 1) embracing systems of color, often in homage to well-known figures in the history of color theory, 2) referencing color nomenclature or identification, 3) conceptual.

## 1. INTRODUCTION

Drawn from the Faber Birren Collection of Books on Color at The Robert B. Haas Family Arts Library, Yale University, this exhibition explored how the discipline of color theory has influenced the makers of contemporary artists' books and *livre d'artiste*. Book artists have engaged color theory in a rigorous, yet not specifically scientific, manner. How has the work of important color theorists been employed by book artists? How have more ephemeral, but equally important, color resources, such as paint chip catalogs, inspired works of art in the book form? How has research into color preference and visual phenomena been interpreted by artists?

## 2. TRENDS IN THE FIELD

The extensive examples in the exhibition explored three major trends in this surprisingly fertile subset of book art. The first category is bookworks that embrace systems of color, particularly by well-known figures in the history of color theory. Many of these works are an homage to the original work. The bookworks of the second category reference color nomenclature or identification. The third category emphasizes conceptual bookworks. As works of art, all of the bookworks that were on display defy easy categorization; many of the works have characteristics of more than one category. For the purposes of this paper, one example of a contemporary bookwork from each of the three categories is discussed.

### 2.1 Systems of Color / Homage to Theorist's Work

Inspired by historic color systems, artist Barbara Hodgson and fine book binder Claudia Cohen collaborated on a series of three fine press works published by Heavenly Monkey Editions, British Columbia, Canada, between 2007 and 2012. In all three books, on each page spread, Hodgson and Cohen summarize and visually re-present historical color systems through letterpress printing and hand-colored images. The first in this series was *The Temperamental Rose: And Other Ways of Seeing Colour*. The evocative title of the work is taken from a color wheel developed by Johann Wolfgang von Goethe and Friedrich Schil-

ler in 1799 that equates color and temperament. *The Temperamental Rose* includes entries for canonic names in the history of color theory, such as Goethe, Michel Eugène Chevreul, Philipp Otto Runge, and Friedrich Wilhelm Ostwald, as well as more quirky systems like the Alphonse Bertillon system for identifying criminals based on physical characteristics, including eye color.

For each entry in the book, the artists give a citation of the specific historic object that inspired them. The Faber Birren Collection of Books on Color holds many of the cited works. For instance, Hodgson and Cohen cited an 1860 English translation of Chevreul's classic work, *The Principles of Harmony and Contrast of Colours, and Their Applications to the Arts*. The Birren Collection holds a similar 1859 English translation and the original 1839 French publication, as well as many other editions of this important treatise. Hodgson and Cohen's book is an exemplary specimen of contemporary fine printing with all its hallmarks: beautiful designer binding, hand printed letterpress text on high-quality paper, exquisite illustrations, very limited edition. The choice of expensive materials and production methods to create a rare and expensive object is a commentary by the artists on how highly they revere the subject matter.

## 2.2 Nomenclature & Identification

Angela Lorenz, an American who has been living in Bologna, Italy, for over 20 years, was inspired by architecture and color research projects like Jean-Philippe and Dominique Lenclos' *Les couleurs de la France: maisons et paysages*, as well as by her personal interest in ephemera, such as commercial paint samples and the salesman's sample book. Lorenz's introductory essay describes the history of Bologna's nickname "la rossa," which is a relatively modern nickname, starting sometime shortly after the unification of Italy in 1860, when buildings were cleaned and the original red bricks were uncovered. Many citizens of Bologna think of their city as red, despite its long history that incorporated lighter colors for the facades of buildings when that was in vogue, then darker colors as citizens attempted to obscure disrepair with darker paint. Lorenz approached her study with this history of the red city in mind. She created swatches of color that she remembered from her experience of the city, and then walked the city to find those colors in real life. Only then did she assign the street address to the color swatch. Reds, oranges, and ochres were strongly represented, yet the attuned eye of the artist also noticed the lighter cream colors and even a few greenish tones. The artist chose a binding structure that evokes a salesman's sample book. The four displays of hand-painted color chips can be folded into a 27 cm square with a handle on the spine for transportation.

The Birren Collection holds a wealth of samples and swatch books for paints, inks, and dyes, from a variety of geographic locations and time periods. The strongest holdings are paint samples from late-nineteenth century America. The Collection also has notable holdings of dyed cloth and thread samples from Europe at the turn of the twentieth century. Of particular relevance to Lorenz's bookwork is a paint sample from Philadelphia, PA, circa 1905, titled *Harrisons' New Tuscan Red*. This is the kind of ephemera that inspired Lorenz for not only the attractive small shapes of color, but also for the marketing and nomenclature that in retrospect seems charming and is representative of a particular cultural zeitgeist. *Tuscan Red* shows how long the romantic idea of "colorful Italy" has been part of American popular culture. As a representation of a type of artifact, this commercial paint sample shows how this kind of ephemera has become increasingly important to researchers as a way to obliquely understand color popularity of different time periods.

### 2.3 Conceptual Bookworks

Anne Thompson (Yale MFA 2002) surveyed systems that attempt to codify the more emotional aspects of color and then used the variety of information gathered to create her own system. She consulted many works in the Faber Birren Collection of Books on Color, such as Birren's *Color in Your World* and Max Lüscher's *The 4-Color Person*. Thompson's invented system uses a "color-word value index" to "define all aspects of all things" (Thompson 2008). Eighty-eight words (called the first framework) are associated with ten colors (the second framework) and also grouped into positive, negative, and neutral judgments (the third framework). Thompson generated lists and diagrams detailing the relationships of these various frameworks, resulting in the fourth framework, in which pairs of words (each with a color association that one can look up) are categorized as spiritual, emotional, tactile, physical, or material. These word pairs are the basis of her second book, *The 5 Suits of the 44 Dualities: (Fourth Framework)*.

For example, in *Proposition for the Reversal of Opposites*, the second framework is illustrated by a hand-colored "10 Color Wheel." Thompson used this palette to generate works on paper based on her proprietary system outlined in her artist's book. The colors were applied in many variations based on the "attributes and judgments" found in her research of color systems. Thompson's rules are intended to create objects that one can contemplate, such as *Positive Wheel: Outside In 1947* in the collection of the Yale University Art Gallery. The image is a series of concentric circles, the color and order determined by the list of positive attributes and their assigned colors. Thompson writes in *Proposition* that by contemplating an object that embodies "at least one aspect of the reversal of opposites," the viewer will perceive the "Real Truth." She also presents the truth of her system: that it, itself, is arbitrary:

The lists of opposites and associations in this book seem no more true than any other categories. Yet their truth lies in the freedom from the error of denying their innate arbitrariness (Thompson 2008: [3]).

This conceptual artist's book acknowledges and plays with the fact that the myriad systems that equate color and attributes or emotions are often in conflict with each other.

### 3. CONCLUSIONS

Contemporary book artists are contributing to revitalization of interest in historic color theory in art enthusiasts and students through their prominent use of color theory and nomenclature in works of art in the book format. The *Color Bound* exhibition at the Yale University Arts Library showed historic inspirations paired with the contemporary work in the same vitrine. This allowed the viewer to not only see the relationship between the page spreads selected by the curator, but also to make their own inferences about the relationship between the physical characteristics of the objects. When did the artist use materials and/or printing techniques similar to the object of inspiration and when did the artist vary? What relationships could be seen between bookworks in each of the three categories? How often did these works hold attributes of more than one category? What relationships can be seen across the historic works that artists have chosen as sources of inspiration? The exhibition format allows the viewer to move between parts of the display in a non-linear fashion, highlighting the multiple connections between the objects on display and ideas discussed. While only three bookworks were discussed in this paper, scores more are part of this trend that marries history and theory with contemporary art through an interest in color.

## ACKNOWLEDGEMENTS

Thank you to my colleagues at the Yale University Library for your support that made it possible for me to pursue this research, and to the artists for generously allowing me to use images of their works on the poster.

## REFERENCES

- Birren, Faber., 1962. *Color in Your World*. New York: Collier Books.
- Chevreur, M.E., 1839. *De la loi du contraste simultané des couleurs*. Paris: Chez Pitois-Levrault.
- Chevreur, M.E., 1859. *The Principles of Harmony and Contrast of Colours, and Their Applications to the Arts*. London: Henry G. Bohn.
- Harrison Bros. & Co., 1905. *Harrisons' New Tuscan Red*. Philadelphia: Harrison Bros.
- Hodgson, Barbara and Claudia Cohen. 2007. *The Temperamental Rose: And Other Ways of Seeing Colour*. Vancouver, British Columbia: Heavenly Monkey Editions.
- Lenclos, Jean-Philippe and Dominique, 1982. *Les couleurs de la France: maisons et paysages*. Paris: Éditions du Moniteur.
- Lorenz, Angela, 1992. *Bologna Sample*.
- Lüscher, Max, 1979. *The 4-Color Person*. New York: Simon and Schuster.
- Thompson, Anne, 2007. *Positive Wheel: Outside In 1947*. Gouache and graphite on paper. Yale University Art Gallery 2009.2.1 The Mary Jane Taft Fund for Emerging Artists.
- Thompson, Anne, 2008. *A Proposition for the Reversal of Opposites*.
- Thompson, Anne, 2010. *The 5 Suits of the 44 Dualities: (Fourth Framework)*.

*Address: Jae Jennifer Rossman, Robert B. Haas Family Arts Library, Yale University  
180 York Street, New Haven, CT, 06520 United States  
E-mail: jae.rossman@yale.edu*



# Colour, Art & Fashion

Larissa NOURY  
 « Couleur-Espace-Culture » / « Colour-Space-Culture »  
 Paris, FRANCE

## ABSTRACT

Beginning from the XIXth century major changes both emerge in the role of fashion and in the place of art in society. Growing affluence and new social structures gradually turned art, colour and fashion into ways of expressing personal taste and identity. Our study raises a historic panorama of the colour in the fashion design during the XXth century, highlighting certain symbolic movements such as the Art nouveau, the Russian avant-garde, the modernism, pop art or the kinetic art. It lists the colour's harmonies for modern fashion design and describes the tools, ranges, palettes, techniques which allow personalizing a dress with fantasy and subtlety.

Art and design were more closely tied at the turn of the twentieth century than they are today. Artists did not see the difference between creating an original work of art, such as a painting, and designing a textile pattern that would be reproduced many times over. Each was a valid creative act in their eyes. We have a lot of vivid illustrations of the centuries-long love affair between fashion and art of colour. Couturiers are past masters at capturing the contemporary zeitgeist in their designs, while artists have frequently used clothing as a way to give all-round expression to their aesthetic ideas.

## 1. INTRODUCTION

Art has often been a major source of inspiration for dress designers of XXth century: we remember some creations by Liberty, Sonia Delaunay, Liza Schiaparelli, Coco Chanel, Yves Saint Laurent, Givenchy and Jean-Paul Gauthier. In their practice art of colour is in fashion. The designers paraphrase the masters of painting. This connection between art and fashion is particularly obvious starting in late XIXth century.

## 2. FASHION AND IDENTITY OF COLOUR PALETTE

### 2.1. Belle époque / Belle Epoch

The artistic principles of the "Art nouveau" combine the personal style of expression where the sinuosity of the shape harmonized well with the mosaic of contrasted colors. The synthesis of practical considerations and of an aesthetic natural forms and lines is characterized by colour palettes of a great richness. The modern time influenced a lot the development of the fashion design and produced profusion of the polychromy in it. The large selection of paintings by Giovanni Boldini, Auguste Toulmouche, James Tissot, Jean Beraud and Alfred Stevens, – visual artists, who reflected the best on the fashion style of Belle Epoch, – is an example of what could be called fashion inspiration in fine arts. Artworks were created in realistic manner and have not even a touch of stylization typical of modernist art. Figures depicted in these paintings are precise and realistic. However, it would be fair to say that style itself is the subject matter instead of a particular model. Fashion is the main theme and inspiration for these paintings.

Followed beautiful symbolic women dresses by famous Austrian artist Gustav Klimt, in which he introduced his frescoes and paintings of portrait. Klimt himself drew the blue caftan, a long tunic of oriental style and many other dresses for Flöge Emilie, his companion for many years, who owned a fashion house in Vienna.

After a visit of a workshop in Vienna the avant-garde fashion designer Paul Poiret brought the idea of mixing art and fashion to Paris. He opened a Martine school (1911), a place which was also attractive for artists. He then employed Parisian artists such as Lepape, Ibibe, and Erte on fashion illustrations. He employed the artist Raoul Duffy to design fabric prints and to invent tissues. He went to art galleries and showed his artistic sensibilities by preferring Impressionist paintings at a time when they were new and unappreciated by the public. Poiret became very interested in modern art and said, "I have always liked painters. It seems to me that we are in the same trade and that they are my colleagues." The couturier considered himself as an artist first.

## **2.2. Russian constructivisme & suprematisme**

The artists of Russian avant-garde in 1915-35 initiated probably the most intensive and creative art and architectural movement of the 20th century, and became a significant source of any art movement since that. The constructivists defined the chromatic surfaces as fundamental coloured elements where the straight lines, the rectangular forms, the principal colors (yellow, red, blue, black and the white) are used to make a unified composition. The colour interdependence simultaneously with the community of ideas formed by the uniformity of geometrical contours and the absence of force of gravity, the balance of the unit and the dynamism of the parts - all form a kind of representation of an ideal cosmos.

Varvara Stepanova, Alexandre Rodchenko, Liubov Popova and others show their creativity thorough re-energizing new forms and meaning in art and dress design. The key fragments of Russian revolutionary creativity still glow like radium, living on futuristic art and design into the imaginations of some most influential couturiers of the XXth and XXIst centuries. Christian Dior Haute Couture was inspired by colour palette of Malevich painting in 2002.

## **2.3. Simultaneous Contrasts & Sonia Delaunay**

In the 1920s, abstract painting inspired a variety of fabric designs by successful designer and artist Sonia Delaunay. Married to Robert Delaunay and friends with artists like Mondrian, Arp, Vantongerloo and Kandinsky, she was a member of the contemporary artistic avant-garde in her own right. It was her own abstract paintings that she translated into rhythmic designs composed of squares, lines, circles, diagonals and colour planes. In all, Delaunay created over 2,000 of these fabric designs, around 200 of them produced especially for fashion house Metz & Co in Amsterdam.

## **2.4. Surrealism & Elsa Schiaparelli**

Fashion designer Elsa Schiaparelli, Coco Chanel's main rival in the 1920s and '30s, produced clothing and hats heavily influenced by Surrealism. Her sweaters incorporating knitted ties or sailor collars were a sensation and she worked in close cooperation with artists like Salvador Dalí and Jean Cocteau. An example of her work with Dalí is her famous lobster dress, the original design sketch for which will be included in the main presentation.

## 2.5. Coco Chanel & Japanese art

The designer's passionate interests inspired her fashions. Her apartment and her clothing followed her favorite color palette, shades of beige, black, and white. Elements from her art collection and theatrical interests likewise provided themes for her collections. The ornament of the dress, in both pattern and color palette, resembles the Asian lacquered screens which the designer loved and collected. The convergence of Art Deco line, the modernist impulse was married with pure form and Japanese's potential.

## 2.6. Art of Neoplasticism & BAUHAUS

Piet Mondrian changed the face of modern art. His influence extends to painting, sculpture, graphic design, and fashion. In search of plastic harmony he introduced a universal language of shapes and primary colors that goes beyond the painting, Mondrian was the central figure and the most famous of the De Stijl movement. This style was baptized as neoplasticism and intended to achieve real objectivity by releasing the work of art from its dependence on the momentary individual perception and temperament of the artist. Yves Saint Laurent has created his famous dress with Mondrian's colour composition. The colour in fashion design was developed by the school of Bauhaus and was also very enriching and interesting. The relationship between the form and the color within the framework of visual perception was defined starting from the colour theories of Kandinsky, Klee, Itten, Albers in this School of visual arts and the Technics.

## 2.7. Op-art, Minimalism and Pop-art in fashion

Since the Second World War, there has also been frequent interaction between art and fashion. In the 1950s Karel Appel produced signed fabric designs, in the 60s the Bijenkorf department store sold dresses inspired by Op Art, and since then the emergence of Minimalist art has given rise to a widespread taste for sober, often asymmetrical designs. For instance Jean-Charles de Castelbajac was inspired by Andy Warhol and his pop art "Campbell's Soup" painting. Victor Vazarely, Yvaral and others representatives of "Optical Art" as well as Friedensreich Hundertwasser's art continue to influence modern fashion design and modern life.

In 2007, Christian Dior designed a unique piece: hand painted and enhanced with spectacular embroidery Manteau Suzurka-San. Dior Haute Couture was inspired by The Great Wave of Kanagawa, emblematic work of Japanese artist Hokusai. Focusing on the relationship between art and creations of the house Dior we can say that the original works have been in one way or another influenced by different artists. Certain highlighted artworks influenced not only the collections Haute Couture and *pret-à-porter*, but also the unique world of fine jewelry, perfumes and accessories. Because they reflect light and velocities, colors and shapes of the paintings of Sonia Delaunay emphasized the dancing model dressed in her parade by Ungaro Fall-Winter 2003-2004. His whole existence Yves Saint Laurent revolutionized fashion and gave the woman her freedom of movement that has inspired artists, poets, painters. "The profession needs an artist to exist," he said. He loved painting, painters such as Matisse, Mondrian, Braque, Picasso, and Van Gogh. Saint Laurent began in 1988 in Georges Braque, whose famous birds seem to fly stuck to the bride's dress. Then he designed a jacket inspired by "Iris" of Van Gogh. It took 800 hours to sew the whole Van Gogh. Flakes, tubes, seed beads, ribbons were all embroidered by hand to make the effects and lighting of the canvas. Yves Saint Laurent, veritable artist influenced in some way other couturiers. For instance stylist Erin Fee has been inspired by flowered textile design and

some kind of “camouflage” for his fashion collection. Jean-Charles de Castelbajac, on the other hand, brings a joyful colour palette from BD art graphics. Nowadays, fashion designs have increasingly been regarded as autonomous works of art. Some creations by designers like Viktor & Rolf now go so far in that direction as to be scarcely wearable at all. Viktor and Rolf spread in Dazed and Confused at their CUT-UP COUTURE.



Figure 1: Painted dress “White Lily” by Larissa NOURY with J.M.Pujol, couturier.

### 3. TACTILE COLOUR & HAUTE COUTURE

Nowadays, the collaboration between art and fashion continues. My personal inspiration comes from my painting, from within. Jean Marie Pujol, couturier who worked with Dior and Yves Saint Laurent at the time, designed several dresses to be painted by my means to perpetuate the art and fashion marriage. With this personal style we created a series of hand painted dresses presented during the exhibition at Faubourg’s gallery in Paris, amidst boutiques of Christian Dior, Jean Paul Gauthier, Chanel and other creators of fashion.

Architecture’s evolution of colored strata in constant transformation, beauty unsuspected by nature, the interaction of forms... It is towards this universe of harmony that visitors were entailed. Everything lies in the pondering of both visual and tactile beauties which conceal thus created space. A perception an eye discovers which is then transfigured and transformed by the feeling of touch. This art, beyond the visible, enriches us by its power and its self-fulfilment.

*Address: Dr. Larissa Noury, « Couleur-Espace-Culture »,  
14 rue de la Chapelle, 75018 Paris, FRANCE  
E-mails: [larinoury@gmail.com](mailto:larinoury@gmail.com), [larinoury@neuf.fr](mailto:larinoury@neuf.fr)*

# The Role of Outlines and the Relationship between Art and Psychology

Andrej SKRBINEK, Vojko POGACAR

University of Maribor, Faculty of Mechanical Engineering, Engineering Design Lab

## ABSTRACT

When we evaluate outlines in painting by Gestalt psychology, we agree that in addition to imaginary world, a symbolic world exists. The difference between art and Gestalt psychology in symbolic field is determined by mutual relationship, but many unanswered questions remain. Symbolic structures can be illustrated by a series of fundamental symbolic elements and different relationships by trans-disciplinary comparisons or confrontations. Our aim was to find a common point between Art and Gestalt psychology and to redefine the essence of psychology in art in particular within the structure of technological unconsciousness.

According to Gestalt psychology our minds simplify visual environmental perceptions to understand and explain the complex environmental forms by geometrically regular shapes (triangles, squares, circles etc.) faster and better by using simple primary forms – to extract the essences by basic forms.

In conclusion the outlines have an important role in shape-forming, enabling in cooperation with colours in a wide-range of expressions in design and visual art. In this sense outlines are explained by the gestalt theory as having an important role in shape-forming that enables, in cooperation with colours, a wide-range of dramaturgical expressions in design or in all kinds of visual arts generally.

## 1. INTRODUCTION

Gestalt methodology is a comprehensive observation system regarding design that incorporates the principle of geometric simplification as a means of better understanding an observed subject or object.

Respectively, it enables us to interpret and manage a design by its individual segments. Here we mean the basic image of a shape as such by its Contour lines and, on the other hand, the forms of its surface properties.

In this article, we focus primarily on the elements of those contour lines that can have a crucial impact on the appearance, and thus the importance, of the same design concept. In this paper we therefore present examples that clearly illustrate the effects caused by contour lines in regard to certain stylish classifications.

Using methodology from the field Gestalt psychology, we have managed to establish a kind of semantic evaluation system regarding those contour lines that outline the shapes. On a pragmatic level, these forms of formative contour lines represent the boundaries between the different entities, surface-colour samples, whilst consequently also affecting the importance of the shapes within the broader context of images in art and design, and the subjects of sculpture, architecture, and design.

## 2. METHODS

Art works (paintings, sculptures, spatial layouts, etc.) are fundamental structures, built from multiple heterogeneous layers. Each layer is composed of the primitives of different classes as distinguished by their different characteristic materials. Despite their diversities, the building blocks of individual layers in art work are amorphous sets of randomly arranged blocks, but with unique organic structures grounded in the specificity of the individual layers. Some specific layers connect all the elements and structural frameworks of art. These layers implicitly require all the other layers of blocks, some also define themselves so that the building blocks of the elements of the work of art depends on their properties and are inherent within these layers (Ingarden 1965).

Each work of art necessarily contains a certain minimum number of layers as the essential structure that allows different but not always essential roles, and the emergence of new layers that could not be present in every artistic work. These basic primary structural layers are:

1. Building blocks of first category are the colours, as a skin of anything visual.
2. Building blocks of second category are classified rows of dots which are manifested as the building blocks for all of the following categories.
3. Building blocks of third category are classified as genre lines.
4. Building blocks fourth category are classified as genres surfaces.

All of these building blocks that represent the layers of “venomous formations” in the language of art make up the basic structures of works of art. In addition to these, it would be necessary to define the building blocks of semantic layers, “presented objectivity” and the layer “schematic designs” (Ingarden 1965), namely, more complex layers of art work by linking them together and creating the basic structure of the composition. We will focus on the basic morphological structure.

## 3. RESULTS

Gestalt psychology confirms that our minds at the primary physiological levels tend to simplify visual images of our environment to look at the visual environment with faster and better sensors to understand often complex visual structures at all. Therefore, simplified and more accurate geometrical shapes are just trying to explain all the complex shapes within our environments (Ching 2007).

The diversities regarding the components and functions of individual layers create the polyphonic nature of the artwork. The properties of the individual layers of primitives causing the layers are fully visible, each in its own way. By contributing at least some of its very nature to the whole work of art does not interfere with the unity of the pop art work. Each layer of the artwork has its own set of features that help to build specific aesthetic-value qualities. The resulting set of aesthetic qualities contributes towards creating the single complete value regarding the quality of the overall work of art.

The difference between Gestalt psychology and art is that Gestalt is the repressed, unconscious part of the technology that represents the symbolic structure, which is worth of re-awareness regarding deconstruction and reflections from scratch. Furthermore, can we find within the essence of art the symbolic structures of Gestalt?

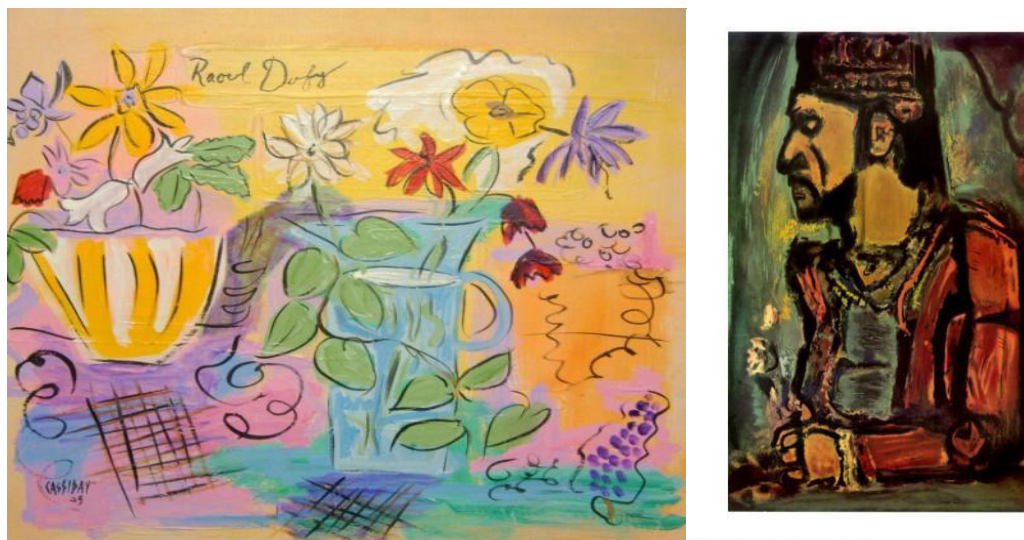

*Figure 1: Examples of two different types of outline thicknesses on paintings by Raoul Dufy and Georges Rouault, the first one appears as light, gentle, easy, and vivid, but the second appears as heavy, dramatic, and profound. The thickness of the drawings line plays the role of adjective, which greatly affect the final appearance of dramaturgy.*

Symbolic structure can be illustrated by a number of basic symbolic elements and different relationships, through trans-disciplinary comparison or confrontation with the natures of the problems such as Art and Gestalt psychology, show the serial structural (in terms of rhythm) problems, deficits and analogies. In this context, we can put a logical question: Wearing a set of symbolic functions within the culture of suppressed technology, organised into different relationships between the disciplines of art and Gestalt theory? Unfortunately, at this point there is no room for in-depth answers to all the above questions.

Gestalt methodology is best manifested in 2D surface model viewing and observation that refers to the flat, perfect visual field as the illusion of 3D space. All the elements of the observed object are present within your specific environment with each other in a relational attitude. The Gestalt methodology is a pragmatic model of classification and evaluation regarding relationships in the two-dimensional field of illusions, which can be illustrated by the so-called Intensity classification of individual typographic lines: HL (Hair Line), SL (Slim-light), L (Light), N (normal), LM (light medium), M (medium), MB (medium / semi / demi bold) B (Bold), HB (Heavy bold), BB (black bold), ...). In Art work it results in extremely different appearance of dramaturgy (Figure 1).

It can be concluded from the aforementioned that it is in different thicknesses of the contours of the displayed works of art for building blocks of the second-order, intensity classified lines (for Mondrian images we have six variants, whilst the classifications of 'typographic lines' have ten, it is necessary to determine to which category each version falls when dedicated to Mondrian), representing layer formation in various works of art. Pictures seem to be like each other at first glance, lightness (L, Light) and the other normal (N, normal), and the third medium light (LM, light medium), fourth medium (M medium) solid fifth (B, bold) and fourth hard (HB, heavy bold) (Figure 2).

The differences between the strengths of the second-order primitives that are reasonable within a particular type of sounding, play an important role in the structure of the artwork. The types of primitives depend not only on the specific natures of the various layers corresponding to a work of art that is reflected in the character of the whole picture, but also the

mode of functioning by the language layers in between the other layers of artwork. Already quite content *foetic sound* of individual visual elements and their elemental sound contains aesthetically relevant qualities. So different, “good” or “bad” sounding visual elements comparable to the aesthetic predicates such as “may”, “difficult”, “funny”, “serious”, “festive”, “pathetic”, (Ingarden 1965) and the like. All these are the characteristics that are the embedded sounds of artistic elements with different strength line primitives of the second-order.

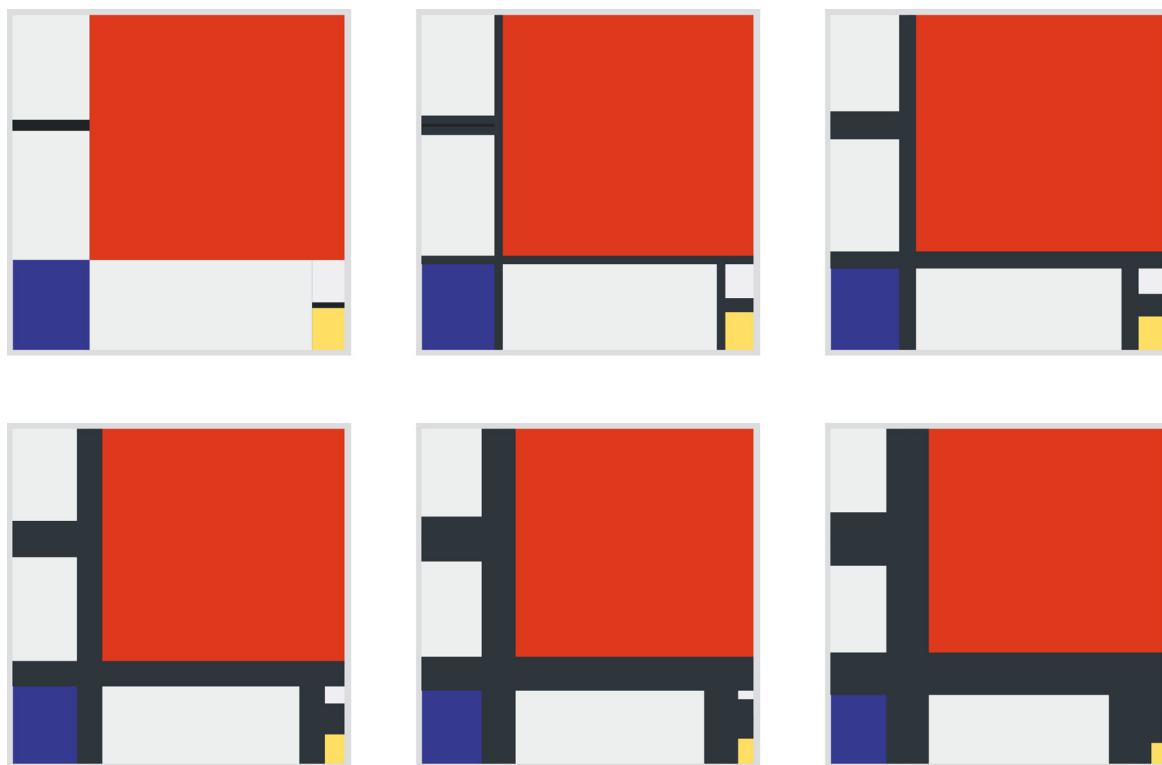

Figure 2: A picture by P. Mondrian (rightmost primarily) is borrowed as an example for introduction the Gestalt principles, which result in dramatic visual transformations of the same painting, provoked by gradual changes of the outline thickness only.

## REFERENCES

- Deleuze, G., 1992. *Woran erkennt man den Strukturalismus?* Prev.: Eva Brueckner-Pfaffenberger, Donald Watts Tuckwiller. Berlin: Merve. ISBN 3-88396-092-6, p. 9-14
- Ingarden, R., 1965. *Literarna umetnina*. Prev.: Franc Jerman. Orig. izd. Das literarische Kunstwerk. 3. popr. izd. Tübingen: Niemeyer. Ljubljana: ŠKUC, 1990. (Studia Humanitatis), cf. p. 63-67, 92-93
- Ching, F.D., 2007. *Architecture – Form, Space, and Order*. Wiley, p. 38.
- Skrbinek, A., 2004. *Fotem “barva” v likovnem jeziku – barvna skladnja, barvne harmonije*. V: JELER, Slava (ur.), LEGAT, Dunja (ur.). Strokovni seminar Pomen barve na pragu 21. stoletja, Rogla, 10. junij 2004. Zbornik referatov. Maribor: Društvo koloristov Slovenije

E-mail: vojko.pogacar@um.si



# Serial Imagery: the Continuing Capacity of Painting to Reveal the Colours of the World

Ken SMITH

Faculty of Art Design and Architecture, Monash University

## ABSTRACT

This paper describes a process of colour analysis using methods of perceptual painting and reports on findings made through this inquiry. Specific landscape sites have been painted multiple times over many days and the range of colour variation revealed through this process is very large. Presenting these paintings together in serial formats attempts to make clear the continual change of colour that occurs in and because of natural phenomena. These variations may not be so clear without the mechanisms of simultaneous appraisal and comparison that serial imagery provides.

## 1. INTRODUCTION

This study follows from two previous investigations of colour in landscape. The first of these attempted to objectively analyse the colour of clear blue skies (Smith 2007), the second, colour at the interface between sea and sky (Smith 2011). Both of these studies revealed the range and variation of colour in natural phenomena so common that they are often ignored, overlooked or simply taken for granted. Both of these studies have stimulated and informed my method of making sets of paintings of the same landscape subject from the same location at different times of the day and year. These multiple images continue a tradition of serial painting that has added significantly to the awareness and knowledge of colour in the natural world.

Serial painting has its origins in the Western tradition at around the turn of the nineteenth century with the increasing practice of painters to create landscape imagery outdoors and within the location that was their subject rather than indoors in a studio working from visual studies, memory and imagination. The first extant examples of serial paintings appear to have been made by Pierre-Henri de Valenciennes (1750-1819) and are studies of architectural and natural forms made in and around Rome from 1782-84. These led, in the nineteenth century, to the most well-known sets of serial paintings made by Claude Monet (1840-1926). His series of paintings of; *Haystacks*, *Poplars*, *Waterlilies* and especially *Rouen Cathedral*, are exemplary examples of the genre and powerfully demonstrate the diversity of colour in the natural world created by changing lighting and atmospheric conditions.

While this type of investigation and manner of pictorial construction became much less common during much of the twentieth century and beyond it has continued to attract artists interested in landscape. David Hockney's (1937- ) recently completed sets of landscape images in a variety of media, and particularly his series of paintings of *Woldgate Woods*, (2006) are notable examples of the persistence of this tradition. Serial painting is an almost inevitable consequence of the type of visual analysis that landscape painting engenders, for it is impossible not to be aware of colour change when working with this subject, especially when these paintings are largely made outdoors, in-situ and in a landscape of constant transformation.

## 2. METHOD

The research process for this ongoing project is direct and empirical, that is, paintings made on-site and outside in a range of landscape locations from the immediate environment where the author resides. The whole project is premised on the understanding that making painted images in response to an external stimulus; that is painted from life or *en plein air*, is still a useful tool for visual investigation. The process of image making described here has evolved in response to the variability of atmospheric conditions and lighting, and as a consequence the colour that is experienced in these locations. The aim always has been to be as objective as possible in the analysis and transcription of this colour. While challenged by photography, and increasingly so by this medium's advancing technical sophistication, the direct and immediate connection between sensate experience and recording gesture that painting offers still makes it a valuable research method for visual discovery.

At the core of this particular painting process is the mixing of coloured paint to attempt to match perceived colour phenomena in the studied landscape locations. The human visual system can discern an extraordinarily large number of colour variations; possibly in the order of two million subtle gradations of spectral and non-spectral colours (Pointer and Attridge 1998: 52-54). The character and quality of modern pigments, if well chosen to make an effective palette of mixing colours, gives the contemporary painter the opportunity to achieve something of this order of magnitude in discernible variations. This level of mixing ability does require time and persistence to achieve the necessary subtlety of judgement, both in evaluating colour in the visible world and then matching it in a pictorial organization.

As involvement with this investigation has developed it has become increasingly apparent that single images may not be the most effective way to reveal the constant variability that is intrinsic to the experience of landscape. Colour changes so much over time that that it is hard to do justice to its plenitude. Pierre-Henri de Valenciennes was certainly aware of this when in 1800 he stated:

It is well to paint the same view from different hours of the day in order to observe the differences that light produces in the forms. The changes are so apparent and so astonishing that one scarcely recognizes the same objects. (Taylor 1987: 256)

The most obvious changes in landscape colour are in atmosphere, through diurnal change of the sun's position in the sky and through variability of air temperature and pressure that result from this. Many of the landscape sites observed throughout this study are in a coastal region and so involve expanses of sea water and the interplay between these and atmospheric change further extends colour variation. Expanses of water reflect changes in sky colour and are a powerful multiplier of colour transformation in landscape. Increasingly serial imagery has seemed to be the most logical way to attempt to pictorially represent the diversity of these phenomena. Sets of images have been painted from exactly the same physical locations, in formats of exactly the same size, and often during the same times of the day to make clear that it is the colour that changes most in these locations over time.

### 3. RESULTS AND DISCUSSION

#### 3.1 Procedural difficulties

Throughout this study I have taken as my reference point the actively analytical form of looking that painting directly from a subject can encourage. This being said it is important to acknowledge that there are procedural anomalies associated with this approach to image making as well as presentation questions that have to be addressed in order to make the whole process of this investigation comprehensible to a viewer.

#### 3.2 Adaptation

I have discussed in the two previously cited studies the aberrations caused to colour matching procedures by changing levels of illumination. Associated with illumination are mechanisms of adaptation; involuntary adjustments of the iris to accommodate changing light levels and retinal adaptation, the diminishing response to stimuli (especially colour) after long exposure to it. The complexities with this are, as with illumination, beyond the scope of this study, I am a painter and can only report on what I see, but my speculation is that the process of intense scrutiny of the contextual relationship of colour that painting can involve does seem to support current theories of colour vision (Purves and Lotto 2011). The making of frequent comparisons between colours in a scene and so evaluating their hue, saturation and lightness levels by association may diminish the influence of adaptive processes but at the same time reveal the breadth of change that colour in the natural domain can exhibit.

#### 3.3 Constancy

The cognitive stabilization of continually varying visual stimuli experienced in the world and especially those caused by changing levels and colour of illuminating light are known as lightness and colour constancy. These are important in; ameliorating or buffering fluctuations of perceptions that could be confusing, and facilitating a functional existence. While the exact mechanisms that create the experience of constancy are still debated (Foster 2003, Foley & Matlin 2010 ) what this discourse highlights, and seems to agree on, is that light and colour perception are dependent on an awareness of "... reflectance relationships among objects in our field of vision." (Foley & Matlin 2010: 209). Or in other words, that we see the visible world by comparative analysis between adjacent visual stimuli. This process of comparative analysis is certainly what painters do when attempting to match and record perceived colour. They are very conscious of the visual scanning that this energetic form of looking engages. So while I can only speculate, and have no means to do other than this, it may be that as in other aspects of vision one learns to see by experience (Lotto and Purves 2011), so the nature of the colour inquiry engaged by this project may train the perceptual system to be more alert and less influenced by the agency of colour constancy. Colour constancy may then be a necessary, but somewhat lazy mechanism in perception.

#### 3.4 Presentation problems

Having made many images from specific field sites the next question has been to decide how best to present these to a viewing audience in a manner that demonstrates the range of perceived and mixed colours that they reveal. The key consideration has been to resolve the arrangement and distance between many respective paintings in a set, maintaining the compositional and experiential integrity of each, but also creating a unified ensemble. Distance between images is the most important concern, too close and they may visually fuse into an ambiguous amalgam, too far apart and their identity as a series becomes lost and the view-

ers' ability to see the fully represented range of colours compromised. This is the fate that has befallen Monet's respective series which, after their creation and initial exhibition, have been dispersed and spread across numerous locations around the globe so making it difficult to fully appreciate their creative achievement.

#### 4. CONCLUSIONS

Painting's close connection between perceiving and making sharpens perceptions and maximizes self-reflective acuity, and it may be able to do this more powerfully than other visual media. The range of colour revealed by the painting process used to analyse the specific landscapes of this study is very large, much larger than imagined. As colour is best understood by its context, so serial painting's method of creating multiple images can make colour difference clear through comparative association. Ultimately this project is a balance between analytical evaluation and poetic evocation, using the remarkable capacity of the human visual system to discern diverse and subtle qualities of colour.

#### ACKNOWLEDGEMENTS

The author wishes to acknowledge the support given to this project by the Faculty of Art Design and Architecture, Monash University.

#### REFERENCES

- Barringer, T., E. Deveney, M. Drabble, M. Gayford, M. Livingstone and X. Salomon, 2012. *David Hockney: A Bigger Picture*. London: Thames and Hudson.
- Foley, H., and M. Matlin, 2011. *Sensation & Perception*. Boston: Allyn & Bacon.
- Foster, D., 2003. Does Colour Constancy Exist? *Trends in Cognitive Sciences*. 7 (10) 439-443.
- Galassi, P., 1991. *Corot in Italy: Open-Air Painting and the Classical-Landscape Tradition*. New Haven: Yale University Press.
- Pointer, M., and G. Attridge, 1998. The Number of Discernible Colours. *Color Research and Application* 23 (1) 52-54.
- Purves, D., and R. Lotto, 2010. *Why We See What We Do Redux*. Sunderland MA: Sinauer.
- Spate, V. 1992. *Claude Monet: The Colour of Time*. London: Thames and Hudson.
- Smith, K., 2007. Sky Blue But What Blue? A New Evaluation of the Colors of the Sky for Artists and Designers. *Color Research and Application* 32 (4) 249-255.
- Smith, K., 2011. The enigma of the offing: the representation of light and colour in sea and sky. In *AIC 2011, Proceedings*, ed. by V. Schindler, S. Cuber. Zurich: pro/colore, 106-109.
- Taylor, J., 1987. *Nineteenth Century Theories of Art*. Berkeley: UC Press.

*Address: Ken Smith, Department of Fine Art, Faculty of Art Design and Architecture,  
Monash University, 900 Dandenong Road, East Caulfield, Victoria, 3145, Australia.  
E-mail: ken.smith@monash.edu*

# About the Colour of an Antique Cypriot Bronze, Modeling, Computing, Molding and Casting

Patrick CALLET,<sup>1</sup> Kyprianos KOUNTOURIS,<sup>2</sup> Philippe DENIZET<sup>3</sup>

<sup>1</sup> Lab. MAS, Ecole Centrale Paris, France

<sup>2</sup> Local History Society Kypros, Dali, Cyprus

<sup>3</sup> AAVEC, Ecole Centrale Prais, France

## ABSTRACT

The presented work was realized in the framework of an international and interdisciplinary project France-Cyprus. The tablet of Idalion, an antique bronze (480-470 BC) found around 1850 in the antique city of Idalion (city of Dali today) was studied in detail. As the original archaeological piece is absent from the collections of the Museum in Dali, we decided to physically replicate the famous tablet. To do this we used 3D digitisation for creating a virtual replica of the tablet shape. With these data, we realised by rapid prototyping a physical copy of the tablet in wax, and cast the final copy in bronze. Exploiting some previously acquired results in virtual metallurgy we rendered, based upon its physical composition, the optical appearance of the tablet of Idalion. We present in this article the realisation of a "perfect" virtual copy of the tablet of Idalion, with the same shape and the same visual aspect as it was when the famous tablet was cast the first time. Spectral rendering requires the optical constants of the material to render ; these were measured by spectroscopic ellipsometry on several physical samples. Optical constants allow to compute the BRDF of the alloy for a given roughness. We realised the virtual copy with the data of the 3D digitisation, and by using our free spectral software Virtuelium. As the project was very original and unique, a didactic movie (28 min) relating the whole aspects of the project was produced and recorded in 6 european languages (french, greek, polish, german, italian and english).

## 1. INTRODUCTION

The metal copper was named after Cyprus, which had rich copper mines. Our work focus on the tablet of Idalion (Figure 1, left), an antique bronze (480-470 BC) found around 1850 in the antique city of Idalion (city of Dali today) in Cyprus. It has an important historical value for Cyprus, as it is the longest testimony of Cyprus sillabary writing. The tablet has been the property of the Bibliothèque Nationale de France (BNF) since 1862, and is absent from collections of the Museum in Dali. Our final goal was to realise a perfect copy of the tablet of Idalion (scale 1, with no patina) as a donation to the archaeological Museum. As the tablet has an important cultural and historical value, we were not allowed to handle it directly neither to realise a mold by physical contact. Therefore, we used 3D digitisation to create a virtual replica of the tablet shape. With these data, we realised by rapid prototyping a physical copy of the tablet in wax, and cast the final copy in bronze in partnership with the Centre Technique des Industries de la Fonderie (CTIF) and the Ecole Supérieure de Fonderie et de Forge (ESFF). Exploiting some previously acquired results in virtual metallurgy (mesopotamian alloys of silver and lead, true chinese bronzes) we rendered, based upon its physical composition, the optical appearance of the tablet of Idalion. We were not interested in the rendering of the visual aspect of today but in its original state, before the natural process of oxidization. We present in this article the realisation of a "perfect" virtual copy of the tablet of Idalion, with the same shape and the same visual aspect as it was when the famous tablet

was cast the first time. For this spectral rendering the optical constants of the alloy were measured by spectroscopic ellipsometry on several physical samples (Callet, 2004). Optical constants are also known as “complex indices of refraction” and allow to compute the BRDF of the alloy for a given roughness. We realised the virtual copy with the results of the 3D digitisation, and by using our free spectral software Virtuelium. To get the necessary data, the Centre de Recherche et de Restauration des Musées de France (C2RMF) took a sample of the alloy out of the tablet, and analysed its elementary composition using the PIXE method. With the elementary composition of the alloy, its complex index of refraction was computed accordingly to these measurements. It appeared after these composition measurements that the alloy had a very weak amount of tin and could appear almost as copper. This small amount of tin is well rendered in spectral rendering when an important spectral sampling is used. A didactic movie (28 min) relating the whole aspects of the project was produced and recorded in 6 european languages: french, greek, polish, german, italian and english.

## 2. HISTORICAL ASPECTS

Idalion was an antique city of Cyprus (close to the current town of Dali). According to the legend, Chalcanor, an Achaean hero of the War of Troy, funded it. The Kingdom of Idalion was at the top of its cultural and economic power during the 7th century BC and until the conquest of the town by the Phoenician Kings of Kition during the 5th century BC. Idalion is now one of the most important archaeological sites in Cyprus. The site contains two acropolis and a town. Very few buildings remain and the main one is the temple of Athena at the top of the west acropolis. The tablet of Idalion is made of bronze (Fig. 1). Some illegal excavators at the archaeological site of Idalion discovered it around 1850. It used to be hanged in the temple of Athena. A French collector, Honoré d’Albert, Duke of Luynes, bought it. In 1862, the Duke gave the tablet to the *Bibliothèque Nationale de France*, with all his collection. The dimensions of the tablet are, in cm: (X: 14.2; Y: 21.5; Z: 1.1) while its weight is 247.22 g.

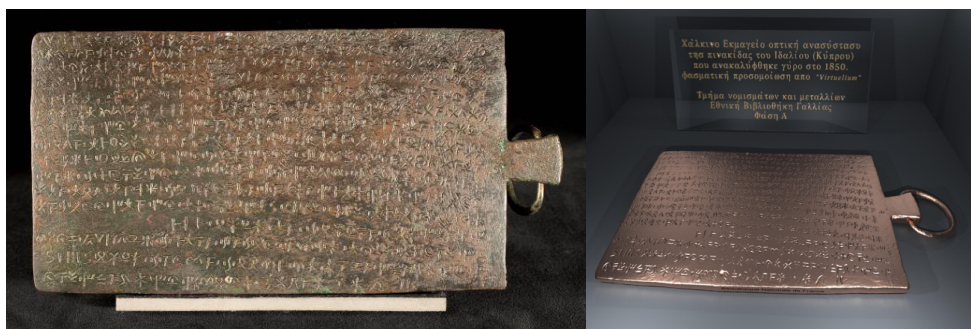

*Figure 1: (Left) The tablet of Idalion (A side) in its state of today, in Paris (BNF). Thin corrosion protective layer or intentionally patinated surface? (Right) Virtual presentation, computed by a spectral photon-mapping algorithm of the Tablet of Idalion in its original state, rendered with Virtuelium (4000 x 3000 px<sup>2</sup>) in 24h on a grid of 6 CPUs at about 2GHz each. CIE D65 illuminants, CIE 1964 (10°) colorimetric observer and ellipsometric data acquired on a physical sample of the alloy specially handcrafted.*

Cyprus syllabary writing covers the tablet on its two sides (Masson, 1983). This tablet is the oldest testimony known of this writing. It is also its longest and richest corpus. The knowledge of the existence of Cyprus syllabary writing was permitted by the discovery of the tablet of Idalion. The text was written in 480-470 BC. It describes an agreement between

the King of Idalion Stasikypros (probably the last king before the fall of Idalion) and the doctors Onasilos and his brothers. The doctors commit themselves to cure the wounded after the siege of the city by the Persians and the Phoenicians of Kition. In exchange of their help, they will be given lands near the city (the Kingdom of Idalion was certainly very rich).

### 3. SCIENTIFIC METHODOLOGY AND RESULTS

As the tablet has an important cultural and historical value, we were not allowed to handle it directly neither to realise a mould by physical contact. Therefore, we used 3D digitization to create a virtual and accurate (40  $\mu\text{m}$  resolution) replica of the today tablet shape. The main steps are described hereafter in Figure 2.

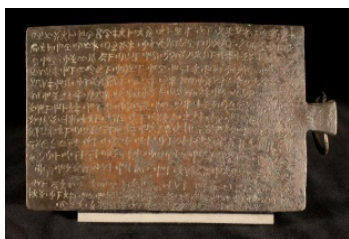

The original bronze tablet in Paris (BNF).

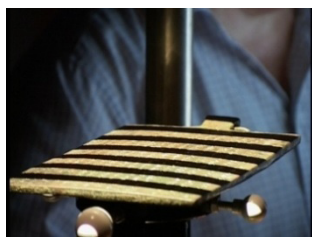

3D digitization in structured light (Breuckmann device).

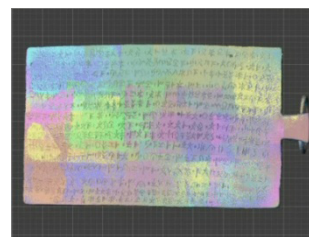

59 clouds of points are merged and triangulated .



CAD rendering with the whole mesh (40  $\mu\text{m}$  in spatial resolution).

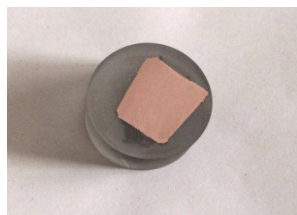

From a small taking, analyzed (PIXE), physical samples (diam: 2.5 cm) are prepared and polished.

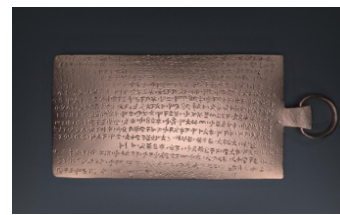

Spectral rendering with Virtuelium using Spectroscopic Ellipsometry results.



Modern wax replica obtained by rapid prototyping.



14 successive ceramic layers of increasing thickness are deposited. Drying: 4h each



Bronze casting, cleaning and ready for exhibition at the Dali Museum.

*Figure 2: The main steps of the making of the virtual and physical replicas.*

### 4. CONCLUSIONS

In an interdisciplinary way we gathered scientific fields for this international project. A complete chain of several knowledge fields involving historians, computer scientists, curators, engineers, metallurgists, students, chemists and our video team was very enthusiastic for collaborating with our cypriot colleagues. After this project, we still have many tasks to realize for continuing the quest for colour and visual effects with metallic compounds (e.g. *elec-*

trum). For those reasons the patinas, and in a more general meaning colored and nevertheless surfacic textures (Dorsey, 1996) make a great challenge for computer graphics rendering. Physical and chemical parameters involving analyses methodologies, non-contact acquisition, spectrophotometric measurements (UV-Visible-IR) as information sources are always necessary to retrieve the original appearance of objects. The making of a movie translated in 6 European languages was also an important and didactic work for our students. They contributed to the translations and voice recording too. After a better comprehension of the coloration of binary alloys we shall have to study more complex combinations. We experimentally worked on that point since 2004 but need to formulate a general model of the interaction of light with metallic objects according to their composition; this always requires the knowledge of optical data and for this purpose we assume that spectroscopic ellipsometry is one of the best techniques to use. A large description of the project, including scientific and technical details, is given in the proceedings of the international conference EuroMed 2010 (Callet, 2010).

### REFERENCES

- Callet, P., and A. Zymła, 2004. Rendering of binary alloys – Example and validation with bronze, *2nd International Conference on Computer Vision and Graphics, ICCVG'04*, Springer.
- Masson, O., 1983. *Les inscriptions chypriotes syllabiques: recueil critique et commenté*. Boccard, Paris.
- Ellipsometry principle and ellipsometers*, <http://www.jawoollam.com>
- Dorsey, J., P. Hanrahan, 1996. Modeling and rendering of metallic patinas. *Proceedings of the ACM-Siggraph*.
- Robbiola, L., J.-M. Blengino, C. Fiaud, 1998. Morphology and mechanisms of formation of natural patinas on archaeological Cu-Sn alloys. *Corrosion Science* 40 2083-2111.
- Callet, P., F-X. de Contencin, A. Zymła, P., Denizet, et al., 2010. An emblematic bronze from Cyprus – *The Idalion project. International conference Euromed 2010*, Springer-Verlag, 206-224, Cyprus.

*Address: Patrick Callet, Applied Mathematics and Systems Lab., Ecole Centrale Paris, grande voie des vignes., Châtenay-Malabry, 92290, France*  
*E-mails: patrick.callet@ecp.fr; d.kyprianos@gmail.com, philippe.denizet@ecp.fr*



# Effects of Colour and Emotion in Illustration

Chung-Yun CHEN, Dian LI, Tom CASSIDY and Vien CHEUNG  
School of Design, University of Leeds

## ABSTRACT

Colour and illustration have intimate and indiscrete influence to our experience. Understanding the associations, symbolic meanings and emotional impact of colour is important for creating successful illustration. To create a resonance illustration, in particular, colour plays an important role in emphasising the atmosphere and enabling the story to be coherent. More often, colour is used to enhance the expression of emotional feelings such as excitement, happiness and calmness. This enhancement can help the illustration elements to be more memorable or impressive and, hence, effectively increase the readers' engagements to the story. This study aimed to create a story using illustration book to reflect the loneliness phenomenon in modern urban cities. The story comprised of a main character who lives in a city with rapid changes for urbanisation. The challenge of this study was to demonstrate the behaviours and emotional expressions through illustrations with limited text. Changes of the character's colour were made with the intention to emphasise the emotion of the characters in illustration from being passionate to be discouraged.

## 1. INTRODUCTION

"The visual image is supreme in its capacity for arousal" (Gombrich 1972 cited in Nodelman 1988 p.4). Nowadays, as the huge amount of images from mass media increases the acceptance and the needs of images for people, illustration becomes not only an accessory to texts, but also a common way to present social issues in our daily lives. Many mature readers are in favour of the concept of illustration books. The requirement of mature readers is not only to obtain one-way information from books; it is also necessary to enable resonance for the readers. Illustrated book is a suitable communication tool for the illustrator to reflect current issues of the society. Colours evoke meanings and emotions. Various colours have a psychological effect and culturally we can associate emotions and properties to objects simply by virtue of their colour (Gage 2000). Lusher identified blue as the most widely preferred colour among Europeans in which it is seen to be concentric, passive, sensitive, perceptive and unifying, and thus to express tranquility and tenderness (Lusher 1940 cited in Gage 2000). However, the colour emotions of orange-red, for example, is opposite to blue; it can be associated with eccentric, active, offensive, aggressive, autonomous and competitive, and hence expressive of desire and domination.

The final outcome of this study is an illustration book that is to describe the status quo of the metropolis issue and depict the external behaviour of the innermost depths of humans. Therefore, the study was undertaken in order to understand the alienation and loneliness to analyse this phenomenon from the perspective of psychology-psychological projection. In this study, the overall goal is to clarify the relationship between association, symbolic meanings and emotion impact applied in illustration. Changes of the character's colour were made with the intention to emphasise the emotion of the character in illustration from being passionate to be discouraged.

## 2. METHOD

### 2.1 Collection of emotion descriptors for urbanites

A review of 15 published illustration stories in the area of lifestyles was carried out with particular attention to the use of colour associations, symbolisms and emotion expressions. Twenty participants – who live in urban cities alone, are single and aged 23-35 – were formed to each provide 3 emotion descriptors for urbanites.

### 2.2 Connections between emotion descriptors and colours

The same group of 20 participants were further asked to assign a Natural Color System (NCS) colour, as shown in Figure 1, to best represent each of the descriptors they have given.

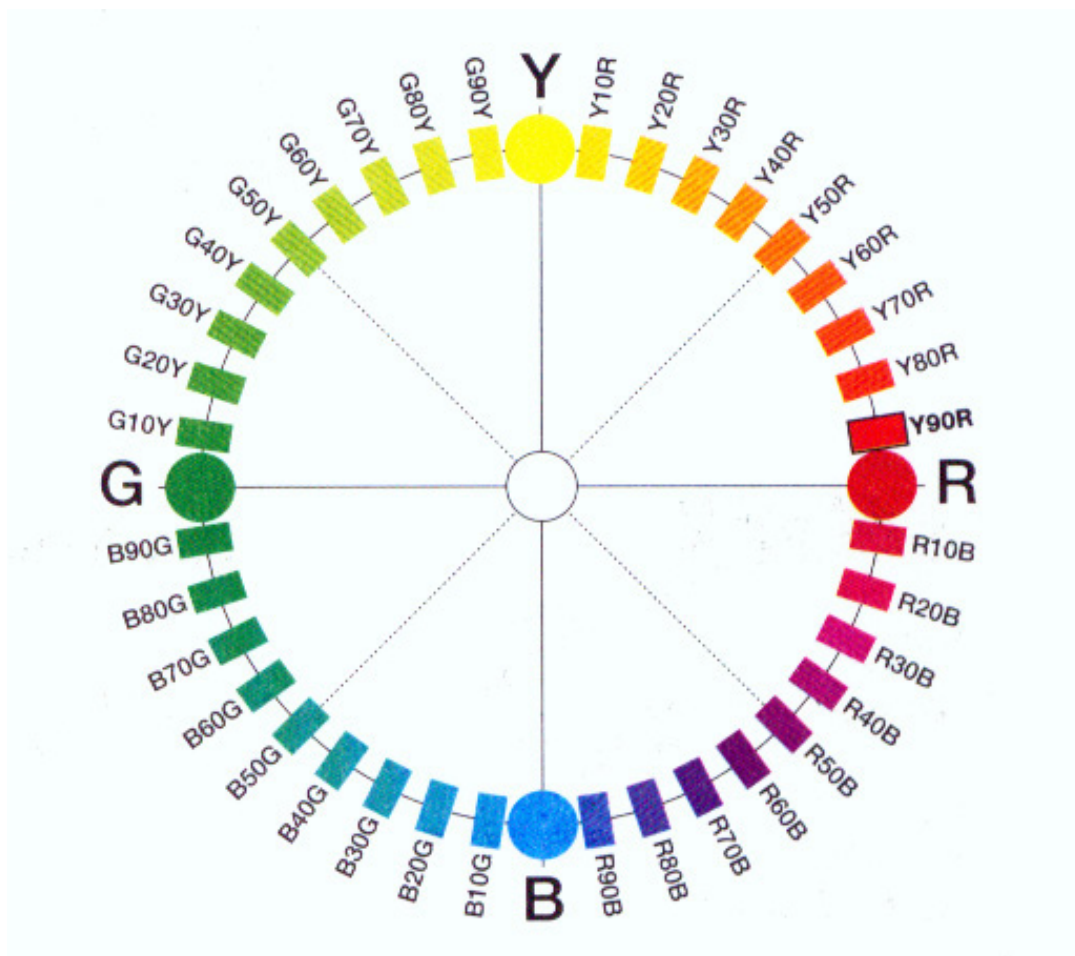

Figure 1: Schematic diagram of the Natural Color System (NCS) colours (reproduced from NCS, 2013).

## 3. RESULTS AND DISCUSSION

The most 12 popular emotion descriptors collected from the 20 participants are listed in Table 1. Furthermore, Table 2 reveals that the result of colour matching with emotion descriptors based on NCS.

Table 1: Top 12 emotion descriptors collected from the 20 participants.

Touchy	Aggressive	Excitable	Active	Outgoing	Leadership
Calm	Reliable	Thoughtful	Passive	Quiet	Anxious

Table 2: Emotion descriptors and their corresponding NCS colours selected from the 20 participants (number of responses is printed in bracket).

Emotion descriptors	NCS colours				
<b>Touchy</b>	Y (8)	Y40R (8)	Y80R (4)		
<b>Aggressive</b>	Y80R (8)	R (4)	R10B (8)		
<b>Excitable</b>	Y60R (12)	Y70R (4)	Y80R (4)		
<b>Active</b>	Y90R (15)	R (5)			
<b>Outgoing</b>	Y60R (7)	Y80R (3)	R10B (10)		
<b>Leadership</b>	R10B (10)	R90B (10)			
<b>Calm</b>	R80B (5)	R90B (7)	B (5)	B20G (2)	B30G (1)
<b>Reliable</b>	R70B (5)	R80B (7)	B50G (8)		
<b>Thoughtful</b>	Y10R (3)	Y40R (5)	B70G (7)	G (5)	
<b>Passive</b>	B (7)	B70G (5)	B90G (8)		
<b>Quiet</b>	R70B (3)	R90B (7)	B50G (2)	G10Y (8)	
<b>Anxious</b>	Y30R (2)	Y60R (8)	R (8)	G80Y (2)	

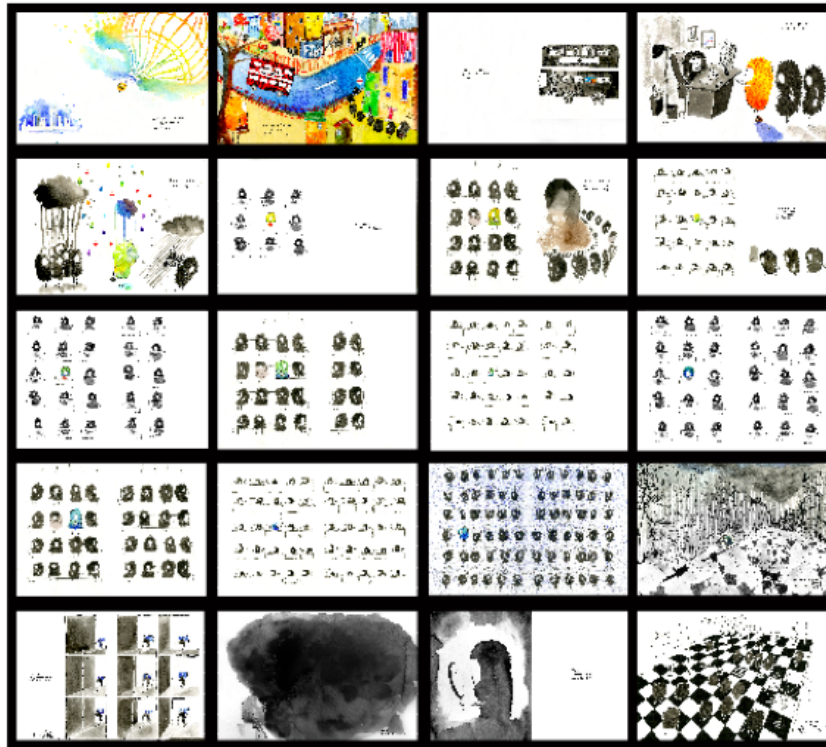

Figure 2: Example pages of applying colour to express emotions in the illustration work.

Through the study of social psychology, personality theory, the method to emphasised the atmosphere is based on colour emotions as mentioned above. The colours of character are changing with the main character's emotion from warm colour (red) to cool colour (blue and black). Even though all of the colours might includes both positive and negative meanings, based on the result obtained from the focus group's responses, the colour yellow and red attained a number of positive emotions such as active, passion and excitable which can associated happiness and hopefulness. During the alienation atmosphere in urban area, the feeling of isolation makes the main character stressful and disappointed. The final outcome of this study was a story book with 20 pages of illustrations. Figure 2 shows some example pages of the storyboard. The use of yellow and orange of the main character intended to illustrate the positive and optimistic personality. The proportion of vivid colours decreased with the story developed and gradually turned into dark when the character's emotions influenced by the surrounding loneliness phenomenon. The correlation with colours and emotions can emphasise a stronger image impression to allow a coherent story without narratives.

#### 4. CONCLUSIONS

This study is concerned with alienation issues and illustration expressions. The final outcome is a 20-page illustrated book with hand drawings. The characters are designed to have an urbanite look with untouchable appearance without facial features. The main character is designed to appear in vivid colour at the beginning of the story; however, whilst experiencing changes in the city, the colours on main character becomes duller and darker with the story developed. The story shows how the atmosphere in an environment affects people. Hence, colour emotion can be apparent in how people associate colours with feelings, personalities or environment.

#### REFERENCES

- Hard, A. and L. Sivik 1981. NCS-Natural Color System: A Swedish Standard for Color Notation, *Color Research and Application* 6(3) 129-138.
- Nodelman, P. 1988. *Words About Pictures: The Narrative Art of Children's Picture Books*, Athens: The University of Georgia Press.
- Gage, J. 2000. *Color and Meaning: Art, Science, and Symbolism*, University of California Press.
- NCS 2013. *Natural Color System*, <http://www.ncscolour.com/en/> [last accessed: 8 May 2013]

*Address: Chung-Yun Chen, School of Design,  
University of Leeds, LS2 9JT, UK  
E-mails: ml10c2yc@leeds.ac.uk, texdl@leeds.ac.uk,  
t.cassidy@leeds.ac.uk, t.l.v.cheung@leeds.ac.uk*

# Colours of Luminescent Glasses for Artworks

Andreia RUIVO,<sup>1,2</sup> Teresa ALMEIDA,<sup>1,3</sup> Fernando QUINTAS,<sup>1,4</sup> Robert WILEY,<sup>1</sup>  
Magda TROEIRA,<sup>1</sup> Nuno PAULINO,<sup>5</sup> César A.T. LAIA,<sup>2</sup> Carlos A. QUEIROZ,<sup>1</sup>  
António PIRES de MATOS<sup>1</sup>

<sup>1</sup> Vicarte, Faculdade de Ciências e Tecnologia, Universidade Nova de Lisboa

<sup>2</sup> Requimte, Faculdade de Ciências e Tecnologia, Universidade Nova de Lisboa

<sup>3</sup> i2ads, Faculdade de Belas-Artes, Universidade do Porto

<sup>4</sup> Faculdade de Belas-Artes, Universidade de Lisboa

<sup>5</sup> DEE-FCT-UNL/CTS-UNINOVA, Faculdade de Ciências e Tecnologia,  
Universidade Nova de Lisboa

## ABSTRACT

Lanthanide ions display intense photoluminescence under UV light. When incorporated in glass they are used not only in technological applications, but in artworks as well. Luminescent glasses with compositions similar to those used in utilitarian, decorative and architectural applications, doped with small amounts of several lanthanide oxides, namely europium, terbium, cerium, dysprosium, samarium and thulium, have been prepared in our laboratories. A few examples of their application in artworks will be presented.

## 1. INTRODUCTION

Special optical properties are constantly being explored by contemporary artists. Light has an exceptional effect in the art field. Several artists made neon installations in museums, cloisters and other public places (Shiess 1994) or artistic installations using fluorescent light tubes (Reis 1999) and fluorescent materials (Ritter 2009). Photoluminescent glass has also a very interesting effect for artists to explore, since luminescent colour only appears under UV-light (Almeida 2011, Almeida et al. 2008). Luminescent glasses can be understood as “smart materials”, a relatively new term for materials which have changeable properties and that are able to reversibly change their shape or colour in response to physical and/or chemical influences (Ritter 2009). Photoluminescent glass can be obtained by the addition of lanthanide elements. These glasses display interesting luminescent colours which can be tuned by changing the lanthanide and the composition of the glass matrix (Gorller-Walrand 1998). The light effects thus obtained improve the visual value of the artworks and seem to have extraordinary potential. The research unit *Vicarte “Glass and Ceramic for the Arts”* where scientists and artists are working together, is developing new materials with luminescent properties in collaboration with *Requimte* and *Uninova*.

## 2. METHOD

Different lanthanide oxides were added to different glass batch compositions in order to obtain luminescent glasses and apply them in artworks.

### 2.1 Sample Preparation

Two different types of soda-lime luminescent glasses were produced. One composition is similar to those used in utilitarian and decorative applications; the other one is the float glass composition, usually used in architectural applications. It was added 2% wt of  $\text{Eu}_2\text{O}_3$ ,  $\text{Tb}_4\text{O}_7$ ,

$\text{CeO}_2$ ,  $\text{Dy}_2\text{O}_3$ ,  $\text{Tm}_2\text{O}_3$  or  $\text{Sm}_2\text{O}_3$  to the two different batch compositions. These glass batches were melted in sillimanite or cordierite crucibles in an electric furnace at 1400-1500°C. Experiments with borosilicate glass were also made but in this case the melting temperature needed was 1600°C and alumina crucibles were used. The melted glasses were quenched by pouring them into a cold steel surface and annealed at adequate temperatures for one hour. Luminescent enamels were also synthesized by adding 5% wt of  $\text{Eu}_2\text{O}_3$ ,  $\text{Tb}_4\text{O}_7$ ,  $\text{Sm}_2\text{O}_3$ ,  $\text{Dy}_2\text{O}_3$  or  $\text{Tm}_2\text{O}_3$  to a  $\text{SiO}_2$ - $\text{B}_2\text{O}_3$ - $\text{Na}_2\text{O}$ - $\text{Al}_2\text{O}_3$ - $\text{PbO}$  glass frit. The mixtures were melted in platinum crucibles at 1250°C. The melted glasses were quenched by pouring them into water. The frit obtained was grinded and applied in glass surfaces. Compatibility tests of the several glasses prepared were made with a *Netzsch* 402PC dilatometer.

### 3. RESULTS AND DISCUSSION

#### 3.1 Soda-lime silicate glass

Luminescent glasses for utilitarian and decorative applications and for architectural applications (float glass) were synthesized. The soda-lime silicate glasses doped with small amounts of one lanthanide oxide had the following luminescent colours: red ( $\text{Eu}_2\text{O}_3$ ), green ( $\text{Tb}_4\text{O}_7$ ), yellow ( $\text{Dy}_2\text{O}_3$ ), orange ( $\text{Sm}_2\text{O}_3$ ), blue ( $\text{CeO}_2$ ) and violet ( $\text{Tm}_2\text{O}_3$ ). This is in agreement with the luminescent colours reported in the literature for these lanthanides in the trivalent state. (Gorller-Walrand and Binnemans 1998, Weyl 1951). The coefficient of expansion (COE) of lanthanide doped and undoped glasses were determined and the results showed that all glasses are compatible. Sculptures were made using several techniques: kiln casting, *pâte de verre* (Figure 1), slumping and fusing.

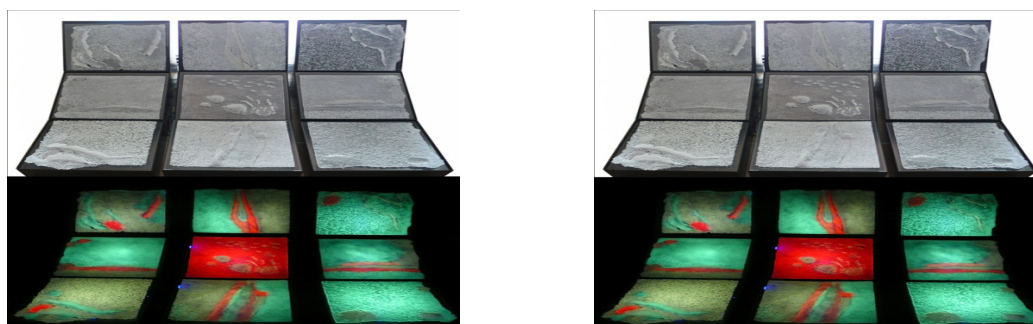

Figure 1: “Pâte de verre” artwork, using  $\text{Tb}^{3+}$ ,  $\text{Eu}^{3+}$  and  $\text{Dy}^{3+}$  doped glasses; Teresa Almeida, 2009. Left: shown under natural light; right: shown under UV-light (ca. 370 nm).

Luminescent float glasses were also prepared having in mind the application of these materials in float glass, due to the interest for modern stained glass artwork. Therefore, small luminescent float glass threads or flecks were prepared and applied directly on commercial float glass, further heated to 700 – 800°C, in order to fuse them (Figure 2). The glass was also milled and applied as enamel. The COE of the float glasses prepared was determined in order to preview the compatibility between the doped and undoped float glasses. The luminescent glasses were shown to be compatible with their base glass compositions by dilatometric analysis, as their COE were similar with a difference under 3.4% (Quintas et al. 2011).

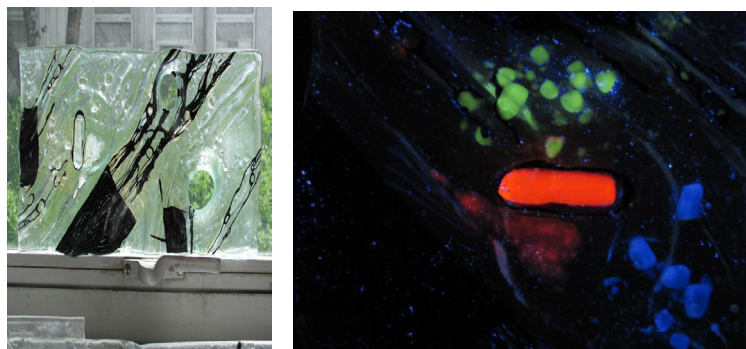

Figure 2: Float glass panel with europium, terbium and cerium doped luminescent thin rods and small pieces, using also commercial black enamels; Fernando Quintas, 2011. Left: under natural light; right: under UV-light (ca. 370 nm).

### 3.2. Borosilicate glass

Luminescent borosilicate glasses doped with lanthanide oxides were also prepared. In glasses doped with  $Tb_4O_7$ ,  $Dy_2O_3$ ,  $Sm_2O_3$  and  $Tm_2O_3$  the luminescent colours obtained were similar to those achieved with the soda-lime silicate glasses. But, in the case of  $Eu_2O_3$ , contrarily to what was observed in the other glass types, two colours were produced, pink and blue, without using a reducing atmosphere; these colours are known to correspond to two different oxidation states;  $Eu^{3+}$  (pink) and  $Eu^{2+}$  (blue). The COE of these glasses were determined and the values obtained showed that, once again, the luminescent glasses are compatible with the undoped glasses. Borosilicate glass is frequently used in lampworking. At *Vicarte* sculptures were made using this technique (Figure 3).

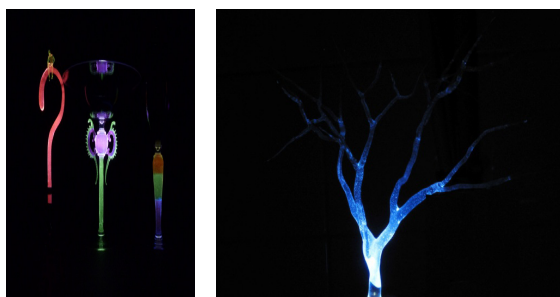

Figure 3: Left: goblet made with luminescent borosilicate glass doped with Eu and Tb under UV-light (ca. 370 nm); Cesare Toffolo, 2013; right: result of an experiment made with europium doped borosilicate glass (lampwork); Robert Wiley, 2012. In this case a 365nm UV LED was placed under the object.

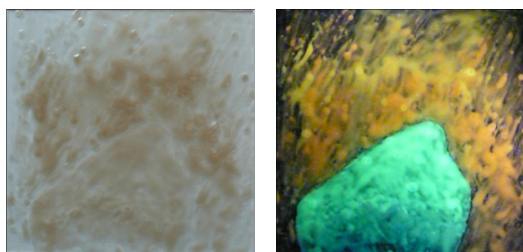

Figure 4: Glass enamels applied in float glass with  $Dy^{3+}$  and  $Tb^{3+}$ ; Teresa Almeida, 2010. Left: under day light; right: under UV-light (ca. 370 nm).

### 3.3. Luminescent enamels

A very rich palette of colours was obtained for the luminescent enamels prepared in our laboratories, which were applied over glass surfaces in order to obtain luminescent glass panels. An example is shown in Figure 4.

## 4. CONCLUSIONS

Several luminescent glasses doped with lanthanide oxides were prepared and used in sculptures, panels and artistic installations. Collaboration between scientists and artists allowed the preparation of new smart materials for artworks with an interesting palette of colours.

## ACKNOWLEDGEMENTS

The authors acknowledge *Fundação para a Ciência e Tecnologia* (FCT) for financial support (POCI/EAT/60496/2004, PTDC/EAT/67354/2006, PTDC/EAT/AVP/118520/2010 and PEst-C/EQB/LA0006/2011). A. Ruivo (SFRH/BD/46659/2008), T. Almeida (SFRH / BD / 30684 / 2006, SFRH / BPD / 73356 / 2010) and F. Quintas (SFRD/BD/42036/2007) acknowledge grants by FCT. We thank the former CRISFORM, at Marinha Grande (now integrated at CENCAL), for the production of luminescent glass using the recipes developed in our laboratories.

## REFERENCES

- Almeida, T., A. Ruivo, A. Pires de Matos, R. Oliveira and A. Antunes, 2008. Luminescent glasses in art. *Journal of Cultural Heritage* 9: e138-e142.
- Almeida, T., 2011. *O vidro como material plástico: transparência luz, cor e expressão*, PhD thesis, Aveiro University. <http://ria.ua.pt/bitstream/10773/5487/1/tese.pdf>.
- Gorller-Walrand, C. and K. Binnemans, 1998. *Handbook on the Physics and Chemistry of Rare Earths*, Elsevier Science B.V. 25 101-264.
- Quintas, F., A. Ruivo, C. Queiroz and A. Pires de Matos, 2011. Contemporary stained glass using luminescent materials. In *GLASSAC II – Glass Science in Art and Conservation: Innovative technologies in glass art, design and conservation from the 19th to the 21st century - the role of the sciences, Proceedings*, ed. by S. Rota and K. Wittstadt. Stuttgart: Fraunhofer Institute for Silicate Research and Fraunhofer-Verlag, 99-100.
- Reis, P.C., 1999. *Pedro Cabrita Reis: On light and space*, catalogue of exhibition at *Museum Moderner Kunst Wien* and *Museu de Arte Contemporânea de Serralves*, Sternberg, M. and Tighe, H. (Eds.), Charta, Milan.
- Ritter, A., 2009. *Smart Materials in Architecture, Interior Architecture and Design*. Basel: Birkhäuser – Publishers for Architecture.
- Shiess, C., 1994. *The Light Artist Anthology-Neon and Related Media*. Cincinnati, Ohio: ST Publications.
- Weyl, W.A., 1951. *Coloured Glasses*. Sheffield: Society of Glass Technology.

*Address: Andreia Ruivo, FCT/UNL, 2829-516 Monte da Caparica, Portugal.*  
*E-mails: a.ruivo@campus.fct.unl.pt, talmeida@fba.up.pt, ferndomus5@gmail.com wi-*  
*leyart@yahoo.com, m.troeira@campus.fct.unl.pt, nunop@uninova.pt, catl@fct.unl.pt,*  
*c.queiroz@fct.unl.pt, pmatos@itn.pt*



# Silent Colour Film Restoration: From Dyes and Grains to Digital

Ulrich RUEDEL, Kieron WEBB  
BFI National Archive, JP Getty Conservation Centre, United Kingdom

## ABSTRACT

The colours of the silent era, most predominantly tinting and toning, have been rediscovered and revisited in film restoration since Alfred Hitchcock's *The Lodger* has first been restored in 1984 by authentic chemical tinting and toning on modern black and white materials. Recently, the flexibility of digital methods have allowed to arguably even more closely approximate the original colours, if only in the digital realm. Yet knowledge of the original chemistries remains essential, to inform digital restorations where no comparison materials survive, or for the use of authentic chemistry for selected special projects to preserve the moving image experience in their original, material-chemical form and colour.

## 1. INTRODUCTION

Throughout the history of motion pictures, colour has been present, even before “natural” colour photography. In addition to adapting the selective hand or stencil colouring known, e.g., from postcards towards film, two chemical approaches that aimed at atmospheric and dramatic purposes rather than the evocation of actual colours were prevalent in silent movies. Drawing on traditional pigments and synthetic dyes, photographic silver images were converted into coloured grains by metal or dye toning, while via tinting, photographic emulsion was stained by dye chemistry, resulting in a crisp silver (or colour pigment) image on a coloured, transparent background. Even though an estimated 60-80% of early silent movies were coloured in some manner, this was ignored as added, or “applied,” colour for decades, with many of the duplicates made from the chemically unstable nitrate copies on safety stock merely in black and white. However, the applied colours of the silent era and their chemistry have been revisited and re-assessed since the 1980s, resulting in the consensus that they must be considered an essential part of the original moving image experience, its preservation and restoration.

## 2. TINTING AND TONING IN SILENT FILMS AND THEIR RESTORATIONS

The historical chemical routes for tinting and toning are extensively described in historical manuals of the period (e.g., Löbel, 1912), most notably those of trade companies Agfa, Kodak and Pathé (Eastman Kodak, 1916, 1918, 1922, 1924 and 1927; L. Didiée 1926, Agfa [undated]). In an invaluable reference resource, they have also been collected and extensively documented in the seminal work of film preservationist Paul Read (Read 1998, Read-Meyer 2000, Read 2010).

Tinting comprises the immersion of motion picture film into an acidic bath of typically an acid dye solution. Attachment of the dye to the gelatin carrying the neutral (black and white) silver grain image results in an even, transparent colouring of the entire film over its entire area and tonal range. The resulting image displays a subjective tonality ranging from the respective tinting colour, rather than from black to white.

Metal toning, in contrast, leaves the gelatin unaltered and is based on redox chemistry involving the silver grains. Upon a bleach towards a silver salt (halide or ferrocyanide), further

reaction yields ‘sepia’ silver sulphide, or coloured ferrocyanides – blue ferric ferrocyanide (Iron Blue, Prussian Blue), orange to red-brown uranium ferrocyanide, red-brown copper ferrocyanide, or yellow to olive green vanadium ferrocyanide (Read 1998). In dye toning, bleaching yields silver iodide, silver ferricyanide or ferrocyanide, or uranium and copper compounds are prepared as above, all of which act as a mordant to subsequently attach basic dyes (Read 1998). The resulting image ideally displays a tonality ranging from the tone colour towards neutral highlights. In combination with tinting, elaborate colour effects can result, such as Iron blue tone on a pink background (eosine or amaranth), or the blue tone – yellow tint combination discussed below.

### 3. SILENT COLOUR RESTORATION FROM ANALOGUE TO DIGITAL

To review the historic film colouring techniques, and the history of their restoration, the restoration performed by Read and others at the BFI’s National Archive is instructive. One important case is Alfred Hitchcock’s famous *The Lodger* (1926), a work not only acknowledged for its combination of Prussian Blue toning and yellow dye tinting, evoking the famous “pea soup fog” of London history and lore. Consulting surviving original coloured prints, the film has been restored a number of times, applying tinting and toning chemistries or, most recently, striving to digitally recreate the according colours. *The Lodger* was first restored by Harold Brown in 1982-84, using toning chemistry based on historic guides (presumably Iron Blue), as well as mixtures from metanil yellow, patent blue and rhodamine dyes as YCM primaries (Brown 1996). Later on, the film was the restored by Read and colleagues at Soho Images. Read and fellow chemist Mabberley (whose research files are kept at BFI) chose to employ historically authentic dyes, such as Orange G, Crocein Scarlet with Iron Blue toning (Read 1996).

However, authentic chemistries on modern materials do not guarantee perfectly correct colours. Even for a single dye, subtle colour shifts can occur, possibly related to dye loading and emulsion thickness (Ruedel, Currò, Hanley 2011). Toning relies on bleaching silver grains, a reaction that involves surface attack on the silver crystals and appears to be harder with modern materials. Contrast increase in duplication from surviving positives is a general issue, and Iron Blue toning adds further – albeit coloured! – density to the images, while tinting decreases their contrast when copied. Either way, this affects the tonal balance to be translated into a blue/yellow colour combination upon tinting and toning. Indeed, Paul Read reports that he resorted to fixing or “clearing” the blue tone (a historically described process to remove residual silver salt by photographic fixing), resulting in more transparent blues (Read 1998). In the chemical BFI restoration directed by João S. de Oliveira in the late nineties, the blue-yellow colour difference was even difficult to perceive, presumably due to these reasons (Webb 2010). Thus, as part of the recent *Silent Hitchcock* restoration project, a new restored version of *The Lodger* was created, with the scrupulous grading approaches discussed below, overcoming the limitations of the photographic-chemical workflow.

A different scenario than with *The Lodger*, which followed surviving colour prints, is offered by *The Great White Silence* (Herbert Ponting, UK 1924), the documentary on Scott’s ill-fated South Pole expedition, where original colour instructions scratched into film leader found with the film’s original negatives guided the colour restoration (a coloured Dutch print survives and was consulted also). Careful grading referencing known silent era dyes and colours resulted in a restoration available both digitally and recorded back on film with arguably superior visual authenticity. The restoration reveals the remarkable colour aesthetics chosen by director Ponting for a seemingly colourless subject. Liz Watkins, in her study

of the film and its restoration (Watkins 2013) argues that the colours are either geographical, or inspired by the subtle colour effects of light on ice that Ponting observed and described. Among the most remarkable effects revealed by the digital re-colouring is the ice smoke sequence, where the entirely unnatural colours of a digitally created blue tone (resembling Iron Blue) in a typical combination a pink, eosine like tint remarkably enhance a subtly structured natural phenomenon.

Rather than scientific principles or digital algorithms informed by them, the *Lodger* and *Great White Silence* projects employed the versatility of digital image manipulation visually, in particular colour grading over the tonal range, to achieve vastly improved results. Most notably, the huge range of controls (compared to photographic duplication) allows for proper representation of the neutrality of images (in tinting) and their progressive colouring, through the tonal scale from black to colour. Thus, one can choose (based on some experience/research of original examples) to make the sense of the image's neutrality more or less prominent based on the tinting hue. In other words, in *Great White Silence*, it was chosen to make the images appear 'more' black and white when the tint was yellow or green than when it was blue or amber. The saturation of the yellow tint, in contrast, visually/subjectively 'begins' higher up the tonal scale. In doing so, it was furthermore important to realise that one was grading a 'live' image – i.e. all the image elements (spatially within the frame and the tonal scale) are subject to change as the image moves. Similarly, the controls in the digital intermediate allow for great control over tint/tone combinations. Control of image contrast is especially relevant here. In terms of *The Lodger*, João S. de Oliveira (Prestech) provided an excellent duplicate negative from the nitrate print (which had, of course, to alleviate the effects of the tone/tint on the contrast discussed above), giving room both for the highlights needed for the tint, and the density needed for the shadows, without too much overall contrast, as efficiently controlled in digital grading. Also, conveniently the result could consistently be translated into the different media masters required – prints from a colour intermediate recorded back out to film, digital theatrical projection (DCP) as well as HD masters for broadcast, DVD and Blu-ray distribution.

#### 4. CONCLUSIONS AND OUTLOOK

With the demise of analogue film projection from commercial venues, there will be a shift in film restoration approaches. While scepticism towards the entirely different nature of digital moving images prevails among many archivists and curators, it makes sense to embrace its potential where it allows more faithful restoration of the original moving image experience. Alongside, appreciation for the visual appearance and material authenticity of film prints manufactured by original processes might increase. While most current tinting activities resort to suitable food dyes, often mixtures, rather than historically authentic chemistries, the latter approach, pioneered by Paul Read, and recently revisited at the Haghefilm Foundation, warrants further use and study, whether for actual restoration or for reference in digital restorations. Indeed, such activities are already underway to accompany the BFI's digital restoration of *The Epic of Everest* (J.B.L. Noel, UK 1924) and its future dissemination and discussion.

#### ACKNOWLEDGEMENTS

Our special thanks go to Paul Read, Film Restoration Consultant, for his support in continuing a materials science of early film colour, as well as to João S. de Oliveira (Prestech, London) for inspiring collaboration and discussions.

## REFERENCES

- Agfa (undated). *Agfa Kine-Handbuch*.
- Brown, H., 1996. *Recollections of the Task of Tinting 'The Lodger' in c. 1982*, unpublished memorandum, Bob Mabberley papers at BFI.
- Didiée, L., 1926. *Le Film vierge Pathé: Manuel de développement et de tirage*, Établissements Pathé-Cinema.
- Dixon, B., and K. Webb, 2012, London – Restoring Hitchcock, *Journal of Film Preservation*, 2012, Vol. 87, p89-94
- Eastman Kodak, 1916, 1918, 1922, 1924 and 1927, *Tinting and Toning of Eastman Positive Motion Picture Film*, Rochester: Eastman Kodak Co.
- Hertogs, D., and N. de Klerk, 1996. Disorderly Order: Colours in Silent Film, *The 1995 Amsterdam Workshop*, Amsterdam: Stichting Nederlands Filmmuseum.
- Löbel, L., 1912. *La Technique Cinématographique*, H. Dunod et E. Pinat.
- Read, P., 1996, Tinting and Toning as a Restoration Technique for Archive Film, *Image Technology*, Vol. 78 Issue 9 4-10.
- Read, P., 1998. Tinting and Toning Techniques and their Adaption for the Restoration of Archive Film, in: *All the Colours of the World, Colour in Early Mass Media 1900-1930*, Reggio Emilia: Edizioni Diabasis.
- Read, P., 2010. Unnatural Colors: An Introduction to Colouring Techniques in Silent Era Movies, *Film History* 21 9-46.
- Read, P., and M.-P. Meyer, 2000. *Restoration of Motion Picture Film*, Oxford: Butterworth-Heinemann.
- Ruedel, U., D. Currò and C. Op den Kamp, 2013. Towards a More Accurate Preservation of Color: Heritage, Research and the Film Restoration Laboratory, in: Brown, S., Street, S. and L. Watkins, *Color and the Moving Image: History, Theory, Aesthetics, Archive*, AFI Film Readers, Routledge, 219-229.
- Ruedel, U., Currò, D. and O. Hanley, 2011. Dye Tinting in *Film Restoration: Das Rätsel von Bangalor, The Reel Thing XXVII*, AMIA Conference, Austin, Texas.
- Watkins, L., 2013. Herbert G. Ponting's Materials and Texts, in: Brown, S., Street, S. and L. Watkins, *Color and the Moving Image, History, Theory, Aesthetics, Archive*, AFI Film Readers, Routledge, 230-242.
- Webb, K., 2010, Colour and the Restoration of Motion Picture Film, in: *Colour-Coded*, The Society of Dyers and Colourists, 59-73.

*Address: Dr. Ulrich Ruedel, Conservation Technology Manager  
Kieron Webb, Film Conservation Manager  
BFI National Archive, JP Getty Conservation Centre  
Kingshill Way, Berkhamsted, Hertfordshire, HP4 3TP  
E-mails: Ulrich.ruedel@bfi.org.uk, kieron.webb@bfi.org.uk*

# **Faber Birren Collection of Books on Color: at the Robert B. Haas Family Arts Library, Yale University, New Haven, Connecticut, USA**

Jae ROSSMAN

The Robert B. Haas Family Arts Library, Yale University

## **ABSTRACT**

Open to researchers from around the world, the Faber Birren Collection of Books on Color is part of the Yale University Library. Faber Birren was a consultant in the color industry in the early to mid-twentieth century. He advised on topics such as product color, environmental safety, and staff morale. In 1971, he donated a collection of historic books on color theory to Yale University and an endowment to aid the growth of the collection. Currently, the Birren Collection consists of over 3,000 titles on color systems, standards, and nomenclature as well as color in artists' manuals and treatises, vision, psychology, printing and the graphic arts, textiles, music, religion, biology, medicine, heraldry, and the occult. An image database is available on the Internet to assist researchers who wish to explore the collection from afar.

## **1. INTRODUCTION**

The Yale University Library, as one of the world's leading research libraries, collects, organizes, preserves, and provides access to and services for a rich and unique record of human thought and creativity. It fosters intellectual growth and supports the teaching and research missions of Yale University and scholarly communities worldwide. A distinctive strength is its rich spectrum of resources, including over 15 million volumes and information in all media, ranging from ancient papyri to early printed books to electronic databases. Housed in fifteen libraries across the campus, it employs a dynamic, diverse, and innovative staff of over 500 who have the opportunity to work with the highest caliber of faculty and students, participate on committees, and who are involved in other areas of staff development.

As part of the Yale University Library, The Robert B. Haas Family Arts Library provides collections and research services to the schools of Art, Architecture, and Drama, as well as the Department of the History of Art and the Yale University Art Gallery, in addition to the international arts community. The Haas Family Arts Library collection consists of almost 500,000 titles both onsite and at the offsite Library Shelving Facility. Additionally, Arts Library Special Collections (ALSC) contains rare and unique materials from the Art+Architecture and Drama libraries, as well as the Arts of the Book Collection. A highlight of the Arts Library Special Collections is the Faber Birren Collection of Books on Color.

## **2. WHO WAS FABER BIRREN?**

Faber Birren (1900-1988) was an early practitioner in the color industry, establishing his own consulting firm with a specialization in color in 1934. He was known as a strong proponent of "functional color," applying color preferences in an objective way to public spaces or commercial products (Blaszczyk 2012). He advised on topics such as product color, environmental safety, and staff morale. He is well-known for his advice to a billiards table company to change the color of felt from green to a purplish color. After this change, sales

in the home market “soared” and established his reputation (Kauffman 1974: 73). One of his major works is still used every day: in 1944, he worked with the E.I. du Pont de Nemours Company to develop a color designated safety code for business and industry. Over the years, as he gathered data on preferences for various consumer groups and performed or read professional-level research on the psychological effects of color, Birren branched out from advising on current preferences to also become a master at forecasting color trends. Birren applied his professional knowledge to popular culture products such as stationery or cocktail glasses that emphasized individual color preference. Birren was a prolific author, producing 25 books and scores of articles in a variety of venues from peer-reviewed journals to high-circulation popular magazines.

Birren’s very successful career allowed him to leave a permanent legacy of his work in color through the Faber Birren Collection of Books on Color. He donated a core collection of 226 books on historic color theory to the Art+Architecture Library at Yale University in 1971, as well as an endowment that allows for continued growth of the collection. In addition to books, the collection holds textile samples, photographs, paint chips, manuscripts, and more. Birren worked with library staff on the development of the collection from the time of its donation until his death in 1988. The Faber Birren Collection of Books on Color is particularly strong in color systems, color standards, and color nomenclature. Color theory, artists’ manuals and treatises, and color techniques are also well represented. In addition, the collection has materials on vision, psychology, printing and the graphic arts, textiles, music, religion, biology, medicine, heraldry, and the occult. The collection has materials ranging from the 16th to the 20th centuries with important editions by Renee Descartes, Isaac Newton, Moses Harris, M.E. Chevreul, and C.S. Greenough, among others. The Faber Birren Collection of Books on Color is considered one of the foremost gatherings of works on color.

### 3. BIRREN COLLECTION IMAGE DATABASE

To facilitate exploration of the Birren Collection, the Yale University Library has created the Birren Collection Image Database. It contains images from works in the Birren Collection and is available free of charge to all researchers. Readers access images in the database by searching for specific bibliographic information or browsing by subject facets, including the proprietary classification system developed for the Birren Collection by Yale art historian Robert L. Herbert in 1974. The database also connects to Orbis, Yale’s online public access catalog, giving the complete catalog record of each item and more information about its physical location in the Yale University Library system.

#### 3.1 Sample Search

This paper shows an author search for “birren” (no quotes) as an example of how the image database facilitates browsing of the physical collection, which is located in the closed stacks of Arts Library Special Collections. Searches can be done by author, title, imprint or year; browsing groups of materials is best done through the drop-down menu of subject facets (Figure 1).

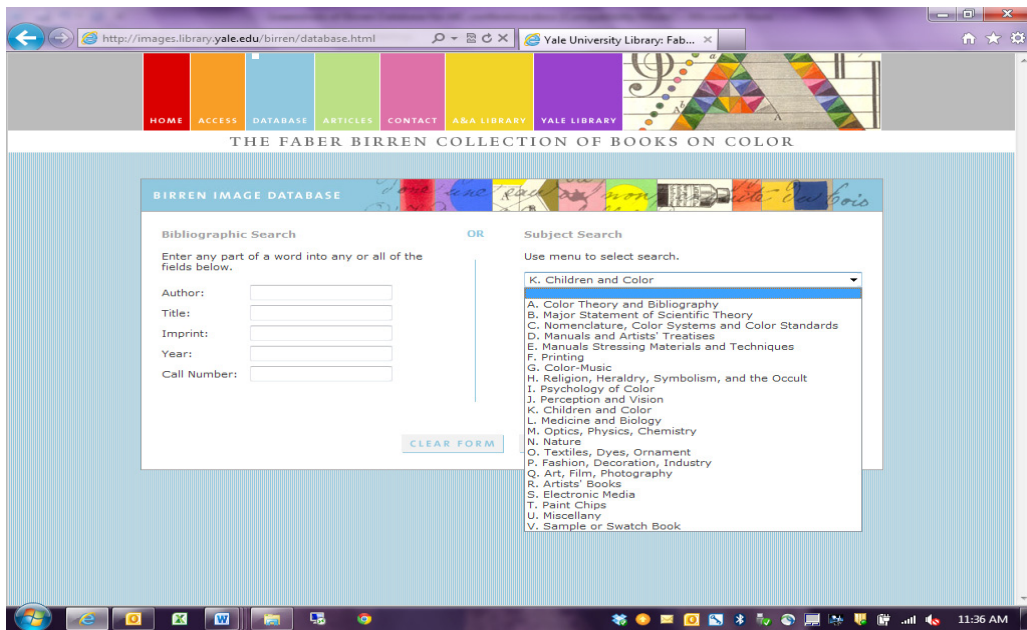

Figure 1: Search interface showing drop-down menu of proprietary subject facets.

After the initial search, the results screen populates with the titles that match the search terms or the subject facet. Author, title, imprint information, local call number and a representative image are shown in table format (Figure 2). Each title in the database has up to three images associated with it to show the researcher the range of illustration types in the physical material or publication.

Birren, Faber, 1900-	Color systems and standards. As part of the Faber Birren Collection of Books on color.	[New Haven, 1980]	ND1492 B58x (LC)	
Birren, Faber, 1900-	Color, form, and space.	New York, Reinhold Pub. Corp. [1961]	ND1488 B56 (LC)+ Oversize	
Birren, Faber, 1900-	Color; a survey in words and pictures, from ancient mysticism to modern science.	New Hyde Park, N.Y., University Books, [1963]	Birren QC495 B56 (LC)	
Birren, Faber, 1900-	Colorizer color atlas : a researched approach to color based on actual demand for interior and exterior paint finishes.	[s.l.] : Colorizer Associates, c1980.	TP937 B57 (LC)	
Birren, Faber, 1900-	Creative color.	West Chester, Pa. : Schiffer Pub., c1987.	ND1488 B571 (LC)	
Birren, Faber, 1900-	Creative color.	New York, Van Nostrand Reinhold Co. [1961]	ND1488 B57 (LC)+ Oversize	
Birren, Faber, 1900-	Eight geometric color studies.	Stamford, Conn. : The Author, 1975.	ND1492 B574 (LC)+ Oversize	
Birren, Faber, 1900-	Faber Birren	Detroit, Mich. : WTVS Detroit 56, [1983?]	VIM 33	
Birren, Faber, 1900-	Faber Birren palettes.	[s.l. : s.n.], 1980.	ND1492 B577 (LC)	

Figure 2: Results screen for author search "birren."

Each title has a record that shows the bibliographic information, subject facets, and thumbnails of all images available (Figure 3). Each thumbnail, when clicked, provides access to a larger image.

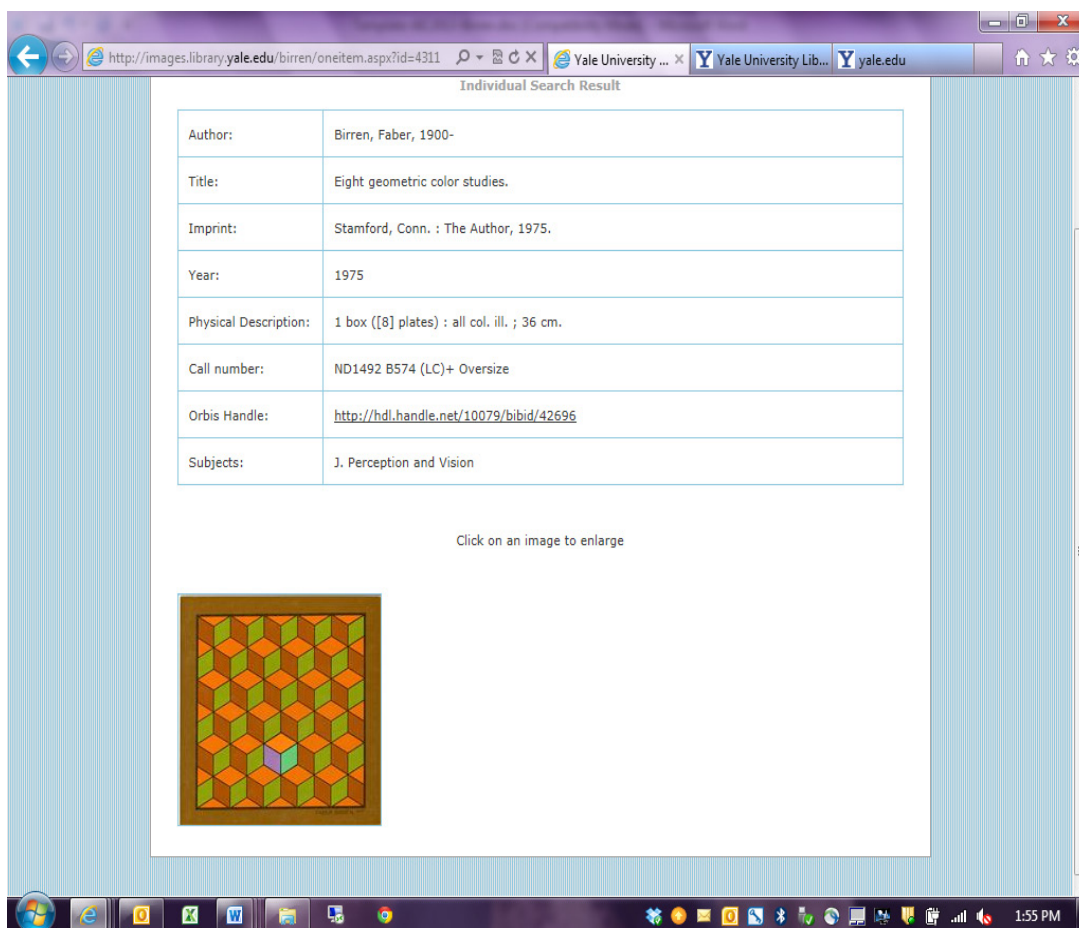

Figure 3: Individual listing for Birren's Eight Geometric Color Studies (1975).

#### 4. CONCLUSIONS

The Haas Family Arts Library welcomes researchers from around the globe. While walk-in hours are available for Arts Library Special Collections (ALSC), a consultation with a librarian well in advance of your visit is recommended. Additionally, using the Birren image database to explore the collection's holdings allows researchers to hone their requests prior to arrival, as well as communicate more effectively with Arts Library staff about their research needs. The Birren Collection supports the study of color in the Humanities and is not intended to collect or provide scientific research or industry standards about the field of color and related phenomena.

#### REFERENCES

- Blaszczyk, R.L., 2012. *The Color Revolution*. Cambridge, MA: The MIT Press.
- Kaufmann, R.C, 1974. A Biographical Note on Faber Birren, *Yale University Library Gazette* 49(1) 73-75.

*Address: Jae Jennifer Rossman, The Robert B. Haas Family Arts Library,  
Yale University, 180 York Street, New Haven, CT 06520 USA  
E-mail: jae.rossman@yale.edu*



# Realm Art-Science: By Colour We Think

Joaquim SANTOS

Faculty of Architecture and Arts, Lusíada University, Lisbon, Portugal

Architect, Docent in History of Art and Theory of Architecture.

Researcher at the Research Centre in Territory, Architecture and Design,

Colour Laboratory (CITAD) at the same university.

Doctor of Philosophy, Tampere University of Technology, Faculty of Architecture, Finland

## ABSTRACT

Could the possible adherence of *colour-like-thought* to conceptualization give a new perception of the world we live in? Could it take us to a new approach towards environment? Would such phenomena give *new* colours to the world? Would either literal objective meaning or metaphor be able to *construct colour-like-thought* on a *matter-word-concept*? Would such conceptualization be properly root in both western scientific and artistic traditions?

Segmentary colour arrangements taken from natural environments could be seen as representations and, as far as they can be basic isolate elements, they may mean chaos or order, reason or metaphor, creative tools to art and science. A peculiar difficulty arises in terms of complexity of thought and the object of thought. Would it be possible to talk about an inner complexity on «representational» or abstract colour thought that may express complex ideas such as those we fashion from the philosophical world, or there will be some kind of *bound- edness* that confines colour to basic approaches? Or, does the process of *colour-thought* run fast on the opposite direction? Twenty century explorations on *expressionist-figurative- abstract* art have given way to what might be a *colour-like-thought* as such.

## REASON AND METAPHOR

Gods created *cosmos* according to precise rules, to reason, and Man created metaphor according to understand both!

From chaos order was born, the world order, an abstract order, mysterious also because it is not directly visible. The world was achieved according to precise rules. It was a demiurge's work that has created that order due to calculus and measures. This conception is to be found later on Kepler to whom God always proceeds geometrically; and Galileu did not think otherwise: «The book of nature is written on mathematical language». Only this language permits the understanding of creation. Thus, mathematics grounds the harmony of spheres and beauty. (Neveux, 1995, pp. 137-138)

Duality between Gods' accurate knowledge and mortals' subjective, inaccurate, knowledge early put humans on a never ending struggle to figure out their place in the universe and their relations to Gods. To be blind to a material and to a spiritual environment turned humans into a prey that will never know completely the habits of the predator and therefore is fragile; an unique fragile destiny was set forward to mortals. Man became a creature in subjection in the hands of Apollo and to the freedom conveyed by Dionysus was not alien the fact that he was a powerful God (Lund, 1971, pp. 19-23).

Only the Gods know. We mortals can only guess (Popper, 2002, p. 97). This was a general accepted truth that we find in Homer, Hesiod, Heraclitus, Alcmaeon, or Xenophanes, and Parmenides put it clear:

Divine knowledge of reality is rational and therefore truthful, while human opinion of appearance is based upon our senses, which are not only unreliable but totally misleading. (Popper, 2002, p. 97)

But the struggle for reason found some early difficulties. Reason requires a straight objective language and,

Snell and others have argued that the archaic Greek Language was under change in another domain. He suggested that while earlier poetic language did not facilitate, as did prose, the generic use of the article, new developments in prose expression led progressively to the formation of substantive nouns that served as “stable objects” of philosophical and scientific thought. (Hahn, 2001, p.172)

Consequently, we may then say that metaphor worked as myth making, as image making, as knowledge making, long before a precise language could handle reason. Yet, this fact does not mean that metaphor was not able to create a comprehensive image of the world, of Gods and of mortals. Yet, it was comprehensive for the mortals and imperfect to the Gods. One could poetically say that mortals became delighted and acquainted with metaphor and poetics and they expect Gods to enjoy human creations!

The *reason-metaphor* problem seems to have had a major role in the realm art-science. Metaphor involves a kind of nonstandard meaning that, nonetheless, needs a literal concept as reference, otherwise metaphor would not be understood as such and its meaning could be indeterminable. (Engström, 1999, p. 151) Thus, metaphor works upon reason on a peculiar way that makes objective knowledge flexible and wide-ranging to an extent that reason alone cannot. Furthermore, metaphor works as a perfect creative tool and image making. And image making has an ontological constructive character.

In some sense Euclid’s Elements are an abstract metaphor of a how a perfect *cosmos* should look like. It is, also, a *perfect* code of signs and rules that can describe that *cosmos* exactly as it is. In that sense, metaphor created reason, and reason does not give any priority to colour, because colour is hardly seen as a constructive *thing*. The different cosmologic images that Greeks have successively developed shared this kind of *reason-metaphor* characteristic. Platonic solids work likewise.

“The five solids are given the name ‘Platonic’ because it is assumed that Plato has these forms in mind in the Timaeus, the dialogue in which he outlines a cosmology through the metaphor of planar and solid geometry.” (Lawlor, 1990, pp.96-97)

These basic solids, already known to the Neolithic peoples of Britain at least 1000 years before Plato as the spherical stones in the Ashmolean Museum at Oxford proof (Lawlor, *ibid.*), meant, for the Greeks, the entrance into Gods’ reason, into the unseen world that a colourful fashionable word hides right in front of our eyes. How could the colours of sunflower hide, exactly, themselves? We hardly expect a visual world to hide another similar visual world. But, perhaps, the preference for the constructive character of things was due to the intuitive recognition that geometric properties of the two dimensional and three dimensional physical space we live are permanent and immutable. (Bronowski, 1973, p. 174-176) They represented, at the core of the subject, a constancy that could not be experienceable by any other means and could not be avoidable by “the Greek preference for deduction.” (Kline, 1964, p. 28) Thus, a *natural* scientific law was sharply seen.

We may now bring together the early linguistic development of Greek, the seen and unseen worlds of mortals and Gods and the way how Greek took ancient Egyptian technology to

build in stone their cosmos by using anathyrōsis in column-drum technical construction, and we may see how conceptual-visual thinking meant a strong constructive sense (Hahn, 2001, pp.149-200). What was actually made by the Greeks was an impressive synthesis of *art-science*, *metaphor-reason*, *matter-concept*, that could construct both a physical house and a spiritual house by erecting the same single temple. However, a close look may tell us, not so surprisingly, that it was the metaphor that, more than reason, could bind all the different pieces together. This characteristically synthesis may contribute to explain the great creativity that painters, sculptors and architects had on reformulating the classical from the renaissance onwards because any attempt to reason always needed some metaphorical intervention that challenged imagination.

When one takes renaissance concept of form as the contour of the object (Tatarkiewicz, 1980, p. 233) and Leonardo da Vinci's drawings and his famous *sfumato*, one should realize that contour means line as objective description, the anatomy of the object, and *sfumato* means metaphor. One needs to desiccate corps to understand properly contours, but *sfumato* comes from the empirical experience. Last but not least, contour means line, means *geometric-mathematization*, and *sfumato* means colour according to express its vigorous splendor. Colour is the *perfect metaphor* that can fill in the lacunae that reason cannot reach. Or, on another way, one may say that colour has strengthened and invaded the perfect realm of reason but, on doing that, it actually acquired a constructive character to the object that is not build of lines and shapes alone. Colour acquires a certain autonomy that moves away from being only used to fill in shapes defined by lines.

The *reason-metaphor* constructive character of an object is complex. The combination of single stable colours on Knossos palaces make a tectonic discourse more precise and may be seen as a reason-metaphor synthesis. Yet, they do not have the constructive character of *sfumato* that *acquires a trompe l'oeil* technique free from a *line-plan* perspective construction.

What Kenneth Frampton makes clear on architecture is the presence of the corporeal metaphor and the objective construction, where the image of construction performs a major rule is a cultural architectural synthesis that civilization has produced but that Greek heritage placed on the western culture (Frampton, 2001, pp.10-12). And colour might be put on the service of such *reason-metaphor* constructive character and to work as any other material does. Furthermore, only when we have understood colour as a strong material-like constructive material that is able to work on the *reason-metaphor* constructive character on any art that uses matter we may reflect on a scientific meaning of colour otherwise we would take colour from a minor level that probably would be meaningless to science.

Ibn al-Haytham's (Alhazen) experimental mind that produced his most well-known master piece, *Kitâb al-Manâzir* (Book of Optics, 1021) acquires colour at Newton's prisms. Direct observation and practical inventions seem to inquire into Gods's creations more effectively than intellectual creations alone. In that sense, a new balance between the seen and the unseen changed the rule of Man in *cosmos*. Thus colour became structural to scientific thought on a sense that there is some *thought-like colour-thought* that cannot be replaced effectively by any other way of thinking that might be acceptable, but that cannot be seen. Thus, colour means *colour-visual-constructive-matter*, a constructive acme that reveals a material, and represents a challenge to classical thought at the core of the subject.

Yet, what probably mostly impressively challenged colour were all electricity related phenomena that could bring about together the ultra microscopic atomic world and the macro world of lightning and thunder, the sensible world we live in.

Geissler's tubes are pure visual colour thought also found on spectrum analysis or crystallography. We may agree that association of a specific colour to precise frequency makes the sense of colour more reliable. A colourless device decides on colour! But to discuss who the master is, who the slave is, seems worthless at this stage.

### CONCLUSION

On a twentieth century of conflicts, whose acme were the world wars, when human madness seemed chaos, *expressionist-figurative-abstract* strategies broke through by inventing never ending *colour languages*. We hardly believe that artist's mind and soul was not a chaos of colours and shapes that arose to order by comprehensive thinking on a colour basis.

Without dismissing the important role of metaphor in science (e.g. to sharp image-constructions of the universe) (Lightman, 2005) we may stress that science put colour on a objective quantitative basis and *colour readings* of our environment are, after all, a *reason-metaphor* intricately *art-science thought* at the core of colour and the subject. Somehow, colour have undergone through an incredible creative process one which a new potential dialogue art-science have liberated artists and scientists from former classical ways of approaching the natural colour environment we live in.

### REFERENCES

- Bronowski, J., 1973. *The Ascent of Man*. British Broadcasting Corporation, London.
- Frampton, K., 2001. *Studies in Tectonic Culture. The Poetics of Construction in Nineteenth and Twentieth Century Architecture*. The MIT Press, Cambridge, Massachusetts.
- Hahn, R., 2001. *Anaximander and the Architects. The Contributions of Egyptian and Greek Architectural Technologies to the Origins of Greek Philosophy*. State University of New York Press, Albany, New York.
- Kline, M., 1964. *Mathematics in Western Culture*. Oxford University Press. New York.
- Lawlor, R., 1990. *Sacred Geometry. Philosophy and Practice*. Thames and Hudson, London.
- Lightman, A., 2005. *A Sense of the Mysterious. Science and the Human Spirit*. Pantheon Books. New York.
- Lund, E., M. Pihl and J. Sløk, 1971. *A History of European Ideas*. Edited, with a Preface by Ragnhild Hatton; translated from the Danish by W. Glyn Jones. C. Hurst & Company, London.
- Neveux, M., and H.E. Huntley, 1995. *Le Nombre d'or. Radiographie d'un mythe, suivi de La divine proportion. Éditions du Seuil, Paris*.
- Tatarkiewicz, W., and C. Kasperek, 1980. *A History of Six Ideas. An Essay in Aesthetics*. 1980. Martinus Nijhoff. Leiden.

*Address: Joaquim Marcelino Santos  
Rua Maria Lamas, 4 – 6º Esq.1500-438 Lisboa. Portugal  
E-mail: marcelino.c.santos@gmail.com*

# How to Show Colours in a Museum?

Natacha LE DUFF, Éléonore HAVAS  
International Association of the Museum of Colours

## ABSTRACT

To the best of our knowledge, there is no institution such as a museum proposing a pluridisciplinary approach for colours: this presentation aims at going further in the forms of a museum for the Colours. As museum, we think of an institution whose walls and spaces will be entirely dedicated to the presentation of colours considering the diversity of their cultural and scientific aspects. Linked to many disciplines and sciences, colours can be seen as a social and cultural referent as well as a working tool. Thus, setting colours in a museum requires to treat them with the diversity of their aspects, arts and sciences enlightening one another. We will pay a particular attention to the objects selected, regarding their capacity to illustrate and support the story of the exhibition. We will also sketch museographic and scenographic possibilities and ways to break the top-down institutional functioning.

## 1. INTRODUCTION

As a Museum of Colours, we think of a permanent building, whose spaces will be entirely dedicated to the presentation of colours considering the diversity of their cultural and scientific aspects. It is precisely because they are so present in our lives, as an everyday-life (un)noticed phenomenon and also as the cause of some of our more decisive reactions, that colours are a meeting place for various research fields.

Approaching the conception of such institution brings many questions about the ways to build an exhibition on the theme of colours. Following this goal, we will try to focus on different themes to finally present some drafts of such an exhibition.

## 2. METHOD

### 2.1 An epistemological frame for the study of colours

Colours being interesting to us basically as a human reality, we will start with what makes it existing for humans: a **light-object-receptor triangle** will thus be the base of our reflexion in thinking of colours as a general phenomenon. Taking this triple criteria as a reference notably permits us to overcome the limits of the arts/sciences duality.

At once a cultural phenomenon, subjective psychological association and object of scientific investigation, colours will obviously be looked at through art but also in a wider sense through anthropological developments such as symbols, language and other heritages. Colour is the cultural link that creates dialogue between disciplines and languages.

### 2.2 Thinking of colours in a contemporary museum

Museums are institutions dedicated to culture in its wide meaning, where diverse phenomena (scientific, artistic, ...) are observed and analyzed for the public's interest and satisfaction. They are no longer places where artworks are shown without any contextualization. They are laboratories where humans are challenged in their relation to nature, religions and

arts, among others. As explained by Paul Rasse, “*The museum cannot anymore be a temple whose primary function would be to canonise culture; it has to become a forum at the heart of the City*” (Rasse, 1997).

An ecomuseum is “the mirror where the population watches (itself) to recognise itself, where it seeks for explanations regarding the land that it belongs to” (Gorgus, 2000). From the idea of ecomuseum – the “land” tending to include various cultures and continents – we can picture a museology of colours that considers colour as a whole cultural phenomenon. Seeing colours from an anthropological point of view refers to a constructivist perspective: it aims at an evolutive critique of the exhibitions, by confronting different visions. Practically speaking, the Museum will lean on a scientific roster to make sure that the exhibitions make sense in the cultural and social lives of the City.

Museums have also to select and protect remarkable objects that testify to a specific culture and a society, to bring their symbolical value and shared meaning back to life, to express the identity of the community. These selected object then is what we call a musealia, which results from “the metamorphosis of the object, gaining museality in the musealisation’s process” (Panese, 2005): the properties and function that the object gains while entering a museum, with its musealisation. Then, every object entering the museum must be treated like any work of art.

At the same time, we observe a wide range of musealia artworks and objects to evoke colours, through its light and matter aspects. In this way, monochromes, low key paintings, prisms or other artificial rainbows, but also elements of clothing, interactive colour boards... will have a place in the Museum. The criteria of preciousness must lead the exhibition and collection choices, through the objects’ special capacity to illustrate or explain the colours’ narrative.

The object’s emotional load appears as another fundamental criterion in the choice of the exhibition’s content. For Pierre Demeulenaere, “the notion of pleasure is linked to the cognitive apprehension of an object through its form”.

### 2.3 The scenography supporting the narration

What we call scenography is putting objects so as to constitute the narrative and spatial thread of the exhibition. Scenography is about arranging with sense. It creates mechanisms and devices; it gathers materials and frames spaces. The way the object is presented influences the way it is perceived by the visitors. Scenography takes part in the visitor’s understanding of the objects. It is the making of a narrative context around the object and its viewer; it builds the link between the discursive thread of the exhibition, and the spatiotemporal and socio-cultural reality of the visitor. Thus, it is a tool to construct a whole address upon colours.

Today’s critique often focuses on the elitism of museal institutions, which tends to be progressively corrected. Thus, moving away from a vertical logic insisting on the holy “Beauty”, new museal logics bring more and more institutions to search for an alliance between culture and education. We will favour scenographic tools as supports or complements of the scientific speech, which remains at the foreground.

The colours on the walls, the type of light, and generally every decorative element that can enhance, lighten or influence the presence of the objects to the visitor’s eye, and design the exhibition’s different areas. Let’s underline that as colours being the theme of the exhibition, we will be very careful of the use of colours as support of mediation.

The presentation of some objects should sometimes be made to mean that they can be manipulated: open showcases, random presentations that depend on the visitors' interactions with them. For instance, with her "Psicolor", painter Jacqueline Carron created an intuitive and interactive tool to manipulate colours and their harmonies through magnetic coloured cards to place and move on a board. Different workshops will also bring visitors to the contact and manipulation of colours.

As noticed in the first part, scientific speech and cultural references must fit together. A scenographic application of this principle could be about ordering an artwork from an artist, created on the basis of a scientific phenomenon.

#### 4. CONCLUSION

The *Museum of colours*, is a place of aesthetic contemplation and transmission of knowledge. Colours must be thought about as part of humans' culture as well as a strong link between arts and sciences. In this transversal perspective, the objects, together with the scenography, support the museum's exhibition discursive frame. Consequently and simultaneously to this idea, the way to establish contacts with the audience will get a special attention.

#### REFERENCES

- Panese, F., 2005. L'opération scénographique : le façonnage des objets en musealia. In Mari-aux, A. (dir.). *L'objet de la muséologie*. Neufchâtel: Institut de l'histoire de l'art et de muséologie, p.123
- Demeulenaere, P., 2002. Une théorie des sentiments esthétiques. Grasset: Paris. In: Belaën, F. 2005. L'immersion dans les musées de science : médiation ou séduction ?. In: *Culture & Musées 5*, p.100
- Rasse, P., 1997. *Techniques et cultures au musée*. Lyon: Presses universitaires de Lyon, p.15
- Rivière, G.-H., 2000. L'écomusée, un modèle évolutif. Quoted in: Gorgus, N., V. Chabaud. L'Heimatmuseum, l'écomusée et G.-H. Rivière. In: *Publics et Musées 17-18*, p. 60

*Address: Natacha Le Duff  
Köpenicker Str. 4, 10997 Berlin, Germany  
E-mail: museumofcolours@gmail.com / eleonore.havas@gmail.com*





# Medieval Glass and Natural Lighting Rendered by Spectral Simulation

Remi CERISE,<sup>1</sup> Patrick CALLET,<sup>1</sup> Frederic MAGOULES,<sup>1</sup>  
Jerome JOHNSON,<sup>2</sup> Nathalie LE GONIDEC<sup>2</sup>

<sup>1</sup> Ecole Centrale Paris, Applied Mathematics and Systems Laboratory

<sup>2</sup> Fondation Royaumont

## ABSTRACT

Colour and the optical properties of material are studied for many years in the cultural heritage field. Here is presented a set of results of researches leading to the expression of the visual appearance of medieval glasses (XIIIth century). A multidisciplinary approach was successful for having the main parameters of materials, shapes and symbolism of the use of colours in the cistercian church of Royaumont. Simulations of visual appearances can be obtained from a set of complementary scientific methods, experiments and modeling, including spectral measurements of real samples, visual matching and texturing of a 3D shape. These results lead to the exposed methodology “Spectral Calibration by Textures”, using a combination of two parameters: strict spectral measurements, plus a distribution map built from hypotheses. The computed images inserted in the text are obtained with the free and opensource spectral software *Virtuelium*, designed and developed by our team at Ecole Centrale Paris.

## 1. INTRODUCTION

This work belongs to a more general study planed to virtually restore the natural lighting inside the abbey church of Royaumont (40 km north to Paris, destroyed in 1792). A 3D model has already been created but, in addition, we need to populate this virtual church with materials and light sources. As we want to make physical simulations, these materials must be not only historically justified but also fully described in terms of their optical properties. Thus, an important part of this work concerns the study of ancient stained glass windows as they might be used in the cistercian art in France in the middle of the XIIIth century. Several samples of medieval glasses were used to elaborate the present methodology, in particularly the one coming from the abbey of Maubuisson (Figure 1) which is very close to Royaumont in terms of geographic location and time. Furthermore, the visual matching method, as it will be explained later, requires the usage of modern samples. The complete set of Saint-Just glasses (Saint-Gobain group) we used presents the main advantage of having manufactured in a very traditional way (Cerise 2012).

## 2. SPECTRAL CALIBRATION BY TEXTURES

When defining the optical behaviour of materials, extrinsic and / or intrinsic properties can be used. On the one hand, extrinsic properties (roughness, waviness...) are today commonly used in spectral rendering softwares (Pharr 2010) and can be measured with *spectrophotometry*. For glasses, a good description can be obtained by measuring the spectral transmittance (how the light is altered by passing through the volume of the materials by unit length) and / or the spectral reflectance (how the light is reflected by the surface of the material). More precisely, the optical behaviour of a homogeneous glass material can be fully determined if

we measure for a regular sampling of incident and view angles the spectral transmittance. The function we obtain with such a method is called a bidirectional transmittance distribution function (BTDF). On the other hand, an important notion which should be used for the rendering of homogeneous and non-scattering materials is their *complex indices of refraction* (Palik 1998) which are defined as  $\hat{n} = n(1 + ik)$ . The couple of spectral functions ( $n$ ,  $k$ ), where  $k = nk$  is the index of absorption while  $n$  is the optical index, depends on wavelengths and can be calculated from *spectroscopic ellipsometry* (Callet 1998, Berger 2012). For materials filling the Fresnel conditions (must be homogeneous and non-scattering), the reflected light is polarized. Characterizing this elliptically reflected polarized light, an ellipsometer offers efficient values to compute the optical constants  $n$  and  $k$ . Optical constants are sufficient to fully determine the optical behaviour of regular modern glasses.

However, measurements on real medieval glasses are not so simple because they are not enough homogeneous. Figure 1 shows the complex nature of the Maubuisson sample which is a combination of two scattering behaviours: a surface scattering (the painted face with “grisaille”) and an internal scattering (the micro-bubbles inside the volume of the glass). The many variations of extrinsic parameters along the surface (paints, variable thickness and more) make a global photometric characterization almost impossible. In the same way, results of spectroscopic ellipsometry can vary a lot from one region of the sample to another. In both case, accurate measurements can only be done locally. That is why we will expose now a more general method in order to simulate the visual appearance of such a glass.

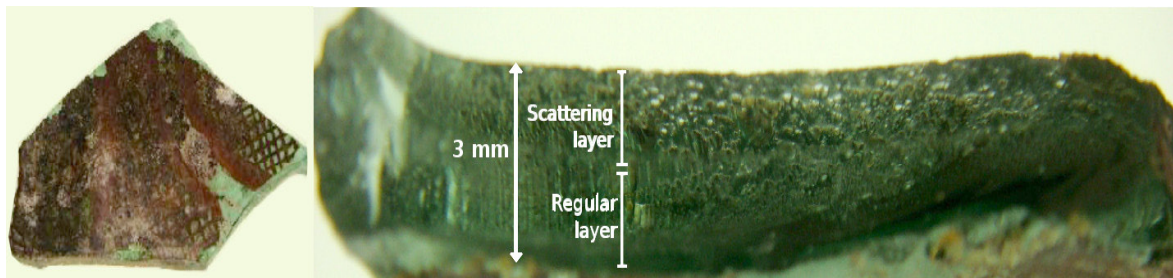

Figure 1: A sample of medieval glass (abbey of Maubuisson, XIIIth). Left: the surface paints (“grisaille”) on the internal face is responsible for light scattering.

Right: a section of the sample shows internal bubbles of air trapped inside the external layer which also plays a role in the distribution of the lighting inside the church.

The main idea behind the exposed method is still to determine a spectral distribution function (BTDF or similar ones). To achieve this, spectrophotometry and spectroscopic ellipsometry can be used as two complementary tools. Also this methodology is inspired by the graphic computing domain where textures are often used to describe the geometric distribution of a given parameter along a 3D surface. In order to estimate an average value of scattering behaviour, a physical solution is proposed, the RATS rule (Reflectance + Absorbance + Transmittance + Scattering = 1, according to the law of conservation of energy). Assuming this, we can evaluate R, A and T ; then, it is possible to deduce S from the previous equation. Since the spectral absorbance cannot be directly measured on medieval samples without modifying its surface conditions (by polishing, what is not always desirable), we can use equivalent modern glasses to estimate its global values. The notion of equivalence is given by visual matching and must be determined using a light booth. By comparing the target medieval sample with several reference samples (Saint-Just) under controlled view conditions (standard illuminants), we can select the modern sample which is visually the

closest. Spectral measurements on these glasses are very accurate because the Fresnel conditions are fully satisfied. The next step is to make hypotheses on how non-homogeneous parts are distributed along the geometry of the object. In order to locally simulate the scattering behaviour of the material, we need to create a map of spectral transmittances. This involves making a set of measurements at several points of interests on the medieval sample. In the model used by the rendering software, this map will act as a special texture. It does not contain colour information as traditional ones but can be accessed in the same way (with texture coordinates, a well known mechanism in computer graphics which can be easily optimized for parallel computations). Selecting a large number of points for measurements will make the distribution map to be closer to the apparent reality.



*Figure 2: Virtual restitutions of a stained glass window with Virtuelium.*

*Window size = 1.3 × 3 m; average glass thickness: 3 mm. Reference colorimetric observer used: CIE 1964 (10°). Natural lighting assumed to represent a possible position of the sun at midday in winter. A little variation in optical constants can drastically change the visual appearance of the glass material*

*(left: base ( $n, k$ ); middle:  $k$  multiplied by 1.5; right:  $k$  multiplied by 0.5).*

### 3. RESULTS AND DISCUSSION

Experimentations of the previous methodology are still a work-in-progress. Figure 2 shows however results of simulations when average optical constants and maps of variable thicknesses are used together. Simulating glass materials from their optical constants is one of the originalities of our software Virtuelium with its “OCRE” method (Optical Constants for Rendering Evaluation). The flexibility of the “OCRE” method also allows perturbations of the complex indices of refraction without exceeding physical laws. Indeed, the use of the Kramers-Krönig relationships ( $n$  and  $k$  spectral functions are not independent) guarantees the result of our modifications of materials are still physically coherent. Natural lighting is also simulated based on spectral measurements of daylight at several places in Paris. A sun

light system has been developed in Virtuelium using the Rayleigh scattering law. It allows the simulation of a theoretic solar light based upon three parameters: geolocation, date and time. Nevertheless, these renderings are still far from a whole simulation of the complex structure of medieval stained glass windows. For example, the variable thicknesses do not give any information about the light scattering. Thus, in the future, the current model for material will have to be completed in order to use at least two distribution maps, for the “grisaille” paints and for the spectral transmittance (which will replace the map of variable thicknesses).

#### 4. CONCLUSIONS

Combining spectrophotometry and spectroscopic ellipsometry is a fresh way to acquire spectral data for image computing. As many works in cultural heritage, focused on how to digitize 3D shapes (artefacts, buildings...), tend to become very efficient, we think the next step will be how to physically simulate visual appearances of these shapes. By using new fully-physical approaches, one of our objectives with Virtuelium is to answer to this future need. Concerning the virtual restoration of the church of Royaumont, many tasks have still to be done. By example, it has been proved the stained glass pattern used in Figure 2 does not match historical considerations about Cistercian churches in the XIIIth century. In the same way, we are not sure today if the micro-bubbles discovered inside the Maubuisson sample is simply due to the test of time or if this was a true researched result for medieval glass-maker masters. By using more samples, new hypotheses will be formulated on this “bubble technique” mystery.

#### REFERENCES

- Berger, K., A. Weidlich, A. Wilkie, and M. Magnor, 2012. Modeling and Verifying the Polarizing Reflectance of Real-World Metallic Surfaces. *IEEE Computer Graphics and Applications* 32 (2), 24-33.
- Callet, P., 1998. *Couleur-Lumiere, Couleur-Matiere*. Paris: Diderot.
- Cerise, R., F. Da Graca, F. Magoules, and P. Callet, 2012. Natural Lighting and Medieval Glass – Scientific Data Acquisition, Methodology and Physically Based Rendering. In *Euromed 2012, LNCS 7616* by Springer. Limassol: 636-643.
- Palik, E.D., 1998. *Handbook of Optical Constants of Solids*, vol. 1, San Diego: Academic Press.
- Pharr, M, and G. Humphreys, 2010. *Physically Based Rendering, Second Edition: From Theory to Implementation*. Burlington: Morgan Kaufmann.

*Address: Remi Cerise, Applied Mathematics and Systems Laboratory,  
Ecole Centrale Paris, Grande Voie des Vignes, 92290 Chatenay-Malabry, France  
E-mails: remi.cerise@gmail.com, patrick.callet@ecp.fr;  
frederic.magoules@ecp.fr; grandpublic@royaumont.com,  
biblio@royaumont.com*

# Study of the Use of the Colour Blue in Byzantine and Early Post-Byzantine Church Decoration in the Context of the Presumed Contemporary Interior Lighting

Elza TANTCHEVA,<sup>1</sup> Vien CHEUNG,<sup>2</sup> Stephen WESTLAND<sup>2</sup>

<sup>1</sup> Department of History of Art, School of Humanities, University of Sussex

<sup>2</sup> School of Design, University of Leeds

## ABSTRACT

This explores the effect of interior lighting on the perception of the colour blue, produced from three different pigments (lapis lazuli, azurite, and smalt) in post-Byzantine churches where the interior illumination was low and dominated by incandescent light. Moreover, the background to the church decoration at the time was painted black. Our hypothesis is that the blue obtained from lapis lazuli would have conferred no perceptual advantages over the cheaper pigments. To test the hypothesis the closest Munsell matches were selected for the colours of azurite, smalt and lapis lazuli, using CIECAM02 and for both, illuminant D65 and the candlelight illuminant (~1800K). Each Munsell match was presented on a black background. In the case of the lighter blues, such as lapis lazuli and azurite, the closest Munsell notation found using CIECAM02 did not depend on the illuminant. This supports the notion that lapis lazuli was not used in the post-Byzantine church decoration because under the contemporary incandescent illumination the same visual result could have been achieved with the cheaper pigments. This notion challenges the view of the traditional art historical scholarship on the matter, where the reason for non-use was considered to be purely economic.

## 1. INTRODUCTION

The aim was to consider to what extent the omission of lapis lazuli from the interior decoration of the early post-Byzantine churches could be associated with the predominance of incandescent light, compared to the Byzantine churches, where the interiors were dominated by daylight. The gradual conquest of the Balkans by the Ottoman Empire led to dramatic changes in the architecture of the Eastern Orthodox Church in the region. Outward changes in the appearance of the churches included the loss of the characteristic dome and a return to the basic basilica form. Moreover, for security reasons, the external openings – both windows and doors – became restricted in number and size. Church buildings in this particular style continued to be built during the sixteenth and seventeenth centuries (Gradeva 1994).

The stylistic changes in the early post-Byzantine architecture altered not just the appearance, but also the performance of the buildings in terms of the characteristics of their interior illumination. For example, while the domed Byzantine architecture flooded the interior with daylight, the post-Byzantine architecture was dominated by artificial illumination. Consequently, the viewing conditions of the latter interiors were determined by the light from incandescent sources; candles and oil lamps.

Comparative examination of the interior wall-painting from both eras has revealed that the range of pigments used in the post-Byzantine churches was different to that used before the Ottoman conquest. The most significant difference is in the type of blue pigment used (Manova 1985). Lapis lazuli has so far been identified only in wall-painting carried out

within the Byzantine period, while azurite was used in both eras. Smalt was introduced at the end of the sixteenth century in Cyprus and in Epirus (Daniilia et al. 2008).

Traditional art historical research has so far offered only two possible explanations for the absence of lapis lazuli from post-Byzantine wall paintings: price, as lapis lazuli was as expensive if not more expensive than gold, or availability. High quality lapis lazuli was imported and therefore presumed to have been difficult to obtain. However, recent research has confirmed that lapis lazuli was readily available in the Ottoman Empire, at least to meet the needs of the Ottoman Muslim miniaturists and for the decoration of mosque and domestic interiors (Kirby, Nash and Cannon 2010). There must, therefore, have been some other reason for the limited use of this pigment.

The hypothesis in this paper is that because of the low intensity and the colour of the incandescent light, which is within the yellow part of the spectrum, and the fact that blue colours would usually have been presented within a black background, in such viewing conditions the blue obtained from lapis lazuli would have been perceptually no more effective than that obtained from the cheaper pigments. When considering the high price of the pigment it can be suggested that the omission of lapis lazuli in wall paintings from the post-Byzantine era might have been a consequence of an unfortunate combination of both economic and perceptual disadvantages in its use, compared to the considerably cheaper azurite. To test the hypothesis, using previous research on the effect of candlelight on the colour appearance in seventeenth-century church interiors, the closest Munsell matches were selected for the colours of azurite, smalt and lapis lazuli, using CIECAM02 and for both illuminant D65 and the candlelight illuminant (~1800K) (Tantcheva, Cheung and Westland 2009). Each Munsell match was presented on a black background.

## 2. METHOD

The original artists prepared the paint by mixing the pigment – usually a single one – with water and applying it directly to the plastered wall, so the painted colour was relatively close to that of the initial pigment (Prashkov 1985). The pigments which we examined were supplied by L. Cornelissen & Son, London and were marked as lapis lazuli (dark), smalt and azurite. A sample was prepared from each pigment by mixing it with water and applying it to a white card. Full coverage of an area of approximately one square centimetre was aimed for. Subsequently reflectance factors were measured for each sample, using a hand-held Minolta CM-2600d spectrophotometer fitted with a target mask CM-A146 (8mm measurement area). Before commencing the measurements, the spectrophotometer was calibrated using the white calibration plate CM-A145.

The spectral data were converted to CIECAM02 coordinates using the CIE 10° observer and, for both, illuminant D65 and an illuminant defined by a blackbody radiator at 1800K (Wyszecki and Stiles, 2000). Calculations were based upon CIECAM02 equations and the parameters are listed in Table 1. The dim surround condition was employed; the Y of achromatic background  $Y_b$  and the luminance  $L_A$  were assumed to be 50% and 10  $cd \cdot m^{-2}$  respectively.

Table 1: Parameters for CIECAM02 calculation.

<b>F</b>	<b>c</b>	<b>Nc</b>
0.9	0.59	1.1

The closest Munsell sample was obtained according to the minimal Euclidean distance between a point representing the blue colour of the pigment and a set of points representing 1269 Munsell reflectance spectra (Parkkinen, Hallikainen and Jaaskelainen 1989). The calculation was carried out using two illuminants (Table 2).

Table 2 : Definition of the six experimental conditions.

Condition	Colour difference	Illuminant
A	XYZ	CIE D65
B	XYZ	Blackbody 1800K
C	CIEDE2000	CIE D65
D	CIEDE2000	Blackbody 1800K
E	CIECAM02	CIE D65
F	CIECAM02	Blackbody 1800K

### 3. RESULTS AND DISCUSSION

Table 3 shows the closest Munsell notation found for the four pigments for each of the six conditions listed in Table 2.

Table 3: Munsell notations for the blue colours of the different pigments and the black colour of the background, using each of the two viewing conditions.

	XYZ		CIEDE2000		CIECAM02	
	A (D65)	B (1800K)	C (D65)	D (1800K)	E (D65)	F (1800K)
<b>lapis lazuli</b>	5 PB 6/8	5 PB 6/8	5 PB 6/10	5 PB 6/10	7.5 PB 5/12	7.5 PB 5/10
<b>azurite</b>	7.5 PB 4/12	5 PB 4/8	2.5 PB 4/8	5 PB 4/8	7.5 PB 4/10	5 PB 4/8
<b>smalt</b>	7.5 PB 4/12	7.5 PB 4/12	2.5 PB 5/8	7.5 PB 4/10	7.5 PB 4/12	7.5 PB 4/12
<b>black</b>	10 Y 2.5/1	10 P 3/1	5 G 3/1	5 G 3/1	5 GY 3/1	5 GY 3/1

The information in Table 3 is not easily analysed visually, especially when the Munsell notations for the blue colours need to be interpreted in the context of the black as a background colour. Hence, the information has been presented visually using sRGB representations (Figure 1) of the Munsell chips referred to in Table 3.

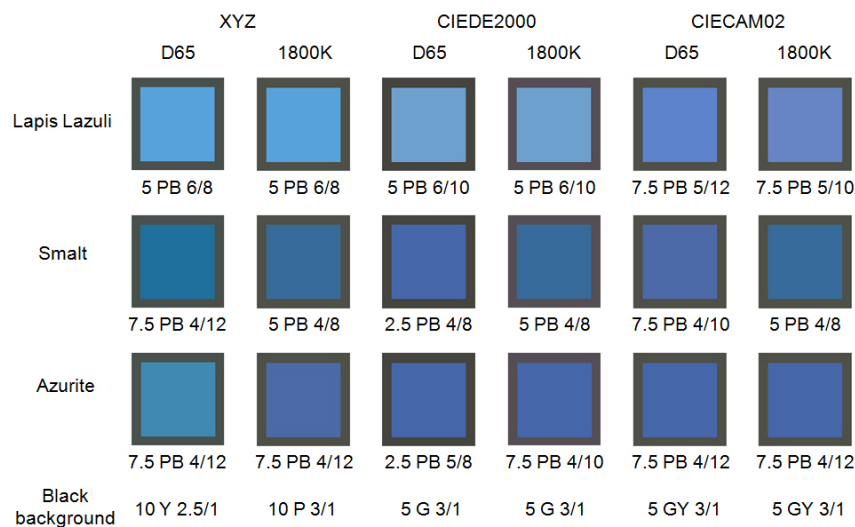

Figure 1: sRGB representations of the colours selected.

#### 4. CONCLUSIONS

Our aim was to establish to what extent the use of lapis lazuli was perceptually effective under flame illumination (the type of illuminant under which the frescoes used in the post-Byzantine era were intended to be viewed) compared to smalt and azurite, the other two blue pigments used at the time. Visualisations of the closest Munsell notation for each of the blue pigments was shown within a black border, as post-Byzantine frescoes normally used black as a background colour. We computed three colour differences (XYZ, CIEDE2000, and CIECAM02) to find the closest Munsell notation, using either D65 or candlelight as the illuminant. It can be concluded that in the case of the lighter blues, such as lapis lazuli and azurite, using CIECAM02, the closest Munsell notation did not depend on the illuminant. CIECAM02 is the most sophisticated colour-appearance model of those used in this study, and therefore this provide some evidence that the perceptual performance of the expensive lapis lazuli and azurite is rather similar. This supports the notion that lapis lazuli was not used in the post-Byzantine church decoration because under the contemporary incandescent illumination the same visual result could have been achieved with the cheaper pigments. This notion challenges the view of the traditional art historical scholarship on the matter, where the reason for non-use was considered to be purely economic.

#### REFERENCES

- Daniilia, Sr., E. Minopoulou, K.S. Andrikopoulos, A. Tsakalof and K. Biarachtari, 2008. From Byzantine to post-Byzantine Art: the painting technique of St Stephen's wall paintings at Meteora, Greece, *Journal of Archaeological Science*, 35(9) 2474-2485.
- Gradeva, R., 1994. *Ottomanskata Politika po Otnoshenie na Hristianskite Tžurkovni Sgradi*, *Etudes Balkaniques*, 2: 98-120.
- Kirby, J., S. Nash and J. Cannon, 2010. *Trade in Artists' Materials: market and commerce in Europe to 1700*. London: Archetype Publications.
- Manova, E., 1985. *Bulgarskata stenopis XVI-XVII vek*. Sofia: Izdatelstvo na Bulgarskata Akademia na Naukite.
- Parkkinen, J.P.S., J. Hallikainen and T. Jaaskelainen, 1989. Characteristic spectra of munsell colors, *Journal of the Optical Society of America A*, 6(2) 318-322.
- Prashkov, L., 1985. *Vuprosi na konservatziata i restavratziata*, 2. Sofia: Nauka i Izkustvo.
- Tantcheva, E., V. Cheung and S. Westland, 2009. Effect of candlelight on colour appearance of seventeenth-century church interiors. *Proceedings of the Eleventh Congress of AIC*, Sydney: University of New South Wales, CD.
- Wyszecki, G., and W.S. Stiles, 2000. *Color science: concepts and methods, quantitative data and formulae*, New York: Wiley.

*Address: Elza Tantcheva, The Limes, Tickenham Hill, Tickenham,  
Clevedon, Somerset, BS21 6SW  
E-mails: etan711@talktalk.net  
t.l.v.cheung@leeds.ac.uk, s.westland@leeds.ac.uk*



# Painting the Pixel: How Digital Media is Changing How Colour is Used in Art

Rachel SHARP  
School of Arts and Sciences, Northumbria University

## ABSTRACT

This paper examines the influence of digital technologies on approaches to colour in contemporary painting practices. Evidence is drawn from my Practice-led PhD research, developed through a program of collaborations and group exhibitions at venues including Baltic 39 (Newcastle upon Tyne), Gallery North (Newcastle upon Tyne) and Trestle Gallery (Brooklyn, NY).

## 1. INTRODUCTION

The traditional association of colour with the intuitive is called into question when it comes to digital media. The computer screen's sense of removal arguably downplays the personal and emotive aspects of colour. However, it should be noted that digital graphics have evolved at breakneck speed since the 1980's, an era in which personal computers, arcade games and billboards were the dominant applications for the technology (Darley 2000). Today, a vast range of handheld devices aim for a tactile and intuitive mode of interaction. These products use touch screens to manipulate images and text. As well, users are encouraged to personalize colour schemes, not only on the screen but through decorative covers and accessories.

Digital technology today encourages a high degree of interactivity. The latest software makes it relatively easy for anyone with a basic level of computer experience to adjust hues, rescale or otherwise manipulate digital images. Meanwhile, the Internet enables user involvement on a greater scale than ever before. Thus, computer graphics are constantly being shaped by human contact. In this sense, the digital realm is like a tapestry that is the work of a countless number of designers. Unsurprisingly, many contemporary painters are exploring this phenomenon and using it to develop new approaches to colour in their work.

## 2. METHOD

The following exploration of digital colour's impact on contemporary painting practices has been developed through my practice-led PhD research at Northumbria University. It entails participating in and/or organizing a program of exhibitions in the UK and USA. These include *The Figure Now* (2012) and *Painting in the Digital Age* (2012) at Trestle Gallery, Brooklyn, NY; *Digital Sensation* (2013) at Baltic 39, Newcastle upon Tyne and *Painting the Pixel* (2014) at Gallery North, Newcastle upon Tyne. The following discussion cites the work of a number of international artists, all of which have or will take part in these exhibitions.

### 2.1 Examples of digital influences on the use of colour in painting

Making sense of disparate images is a familiar experience today, whether one is searching multiple websites or using several tools at once on a desktop. The New York-based painter, Andrea Champlin, is interested in this process. She appropriates a variety of images from

the Internet to create abrupt contrasts of colour and texture. However, she also replicates the flat and depthless appearance of the computer screen, which lends cohesion. Thus, the flat, mediated appearance in her work brings to mind the capsule of the computer and a sense of order. Mediation is like a fabric that helps to harmonize otherwise clashing colours (Figures. 1 and 2).



Figure 1: Roulette (Andrea Champlin, Oil and Acrylic on Canvas, 76 ' 76 cm)

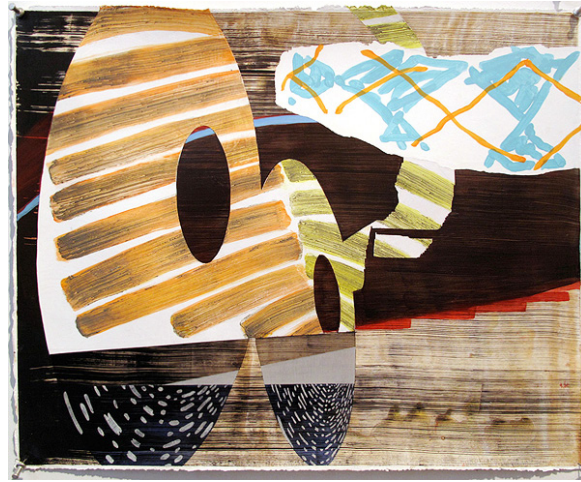

Figure 2: Untitled (Andrea Champlin, Oil and Acrylic on Paper, 46 ' 56 cm)

The level of access that the Internet provides also influences artists' approaches to colour. Joy Garnett's paintings reproduce the garish hues of military explosions from photographs sourced online. Prior to the Internet, these were unavailable for widespread access. The abandon of Garnett's painting style expresses a visual delight in the unnatural colours. It also reflects the shiny allure of the digital medium, as images of destruction are neatly packaged and consumed in the glow of the computer screen, far removed from the event. An interest in this combination of violence and vibrancy is reflected in Garnett's association of her work with the 'apocalyptic sublime' (Armitage 2011) (Figs. 3 and 4).



Figure 3: Dilatory, from Flowers of Evil Series (Joy Garnett, Oil on Canvas, 76 ' 66 cm)



Figure 4: Fracture, from Flowers of Evil Series (Joy Garnett, Oil on Canvas, 76 ' 66 cm)

(Images courtesy of the artist and Winkleman Gallery, New York, USA)

Digital media emphasizes a systemic approach to colour which carries over into painting.

Mike Nemire’s paintings call to mind digital colour gradients. The artist writes about his work, ‘Colour is an intangible construct of the brain, not a physical property of objects. The intention is to demonstrate that colour possesses a power to convey meaning that is unconstrained by image’ (Nemire, online). Nemire captures the immaterial, ethereal qualities of digital images; however, this is contrasted with a tactile, painterly touch. From a distance, the work might seem to be computer-generated, but the detail reveals the handmade, organic quality (Figs. 5 and 6).



Figure 5: *Tetrachromacy*  
(Mike Nemire, Oil on Canvas, 91 ' 91 cm)

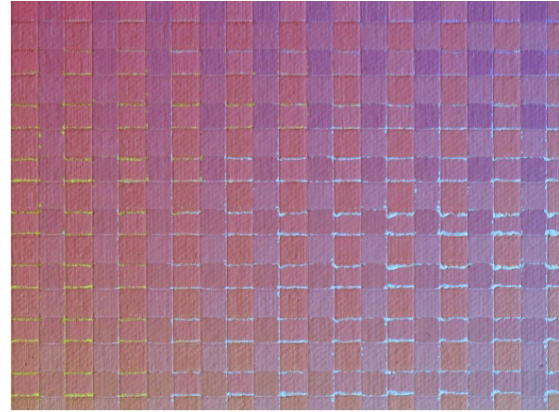

Figure 6: *Tetrachromacy (Detail)*  
(Mike Nemire, Oil on Canvas)

My own paintings, which are based on images sourced from Facebook, exploit the intensity of digital colour. At the same time, the intangibility of the virtual image is contrasted with the heavy substance of paint. The aim is to explore what happens to colour when it is translated from an immaterial form to the heavily painted canvas – the *object* of the painting. Furthermore, it is clear that the countless ‘pictures of people’ online inspire new approaches to the figure; the veils of colour and sense of ‘floating’ or disembodiment in my work reflect the experience of digital images (Figs. 7 and 8).



Figure 7: *New Yorker Series (VI)*  
(Rachel Sharp, Oil on Canvas, 18 ' 13 cm)



Figure 8: *New Yorker Series (V)*  
(Rachel Sharp, Oil on Canvas, 18 ' 13 cm)

#### 4. CONCLUSION

The previous discussion highlights a variety of approaches in painting which both embrace and react against the digital. However, the creative synergy between the material process and the virtual is abundantly clear. The potential for digital colour to inspire painting processes is aptly expressed by the German art critic Walter Seitter, who underlines the commonality between the two media. He alludes to the art form of the mosaic, which he describes as ‘the painstaking combination of small stones, the similar and dissimilar, the dull and colourful’. ‘The mosaic’, he writes, ‘has always resisted the desire for the perfect, smooth, seamless connection; and has clearly stood up for and demonstratively displayed the inevitably digital quality of painting’ (Eberling 2003).

#### REFERENCES

- Armitage, J., 2011. Apocalypse Now: An Interview with Joy Garnett, *Cultural Politics* 7(1) 59-78.
- Darley, A., 2000. *Visual Digital Culture: Surface Play and Spectacle in New Media Genres*, London and New York: Routledge.
- Eberling, K., A. Lutgens, F. Reijnders and W. Seitter, 2003. *Painting Pictures: Painting and Media in the Digital Age*, Bielefeld: Kerber Verlag.
- Nemire, M. ‘Artist Statement’, cited at <http://mikenemire.com>, accessed 20/02/13.

Website: [www.rachelsharp.com](http://www.rachelsharp.com)  
E-mail: [rachel.sharp@northumbria.ac.uk](mailto:rachel.sharp@northumbria.ac.uk)

# Colour Theory as Subject Matter for Art

Paul GREEN-ARMYTAGE  
Curtin University

## ABSTRACT

A painting may represent an object or scene, but before that, as Maurice Denis famously said, it is “a surface covered with colours arranged in a certain order.” (Weston 1996: 62). The implied argument is that the value of a painting as a work of art depends on how coloured shapes are arranged on its surface, irrespective of what, if anything, those shapes might represent. ‘Colours arranged in a certain order’ are the best way to illustrate many aspects of colour theory. In this paper I will show examples of my own work, as well as describing that of a number of artists whose paintings can be seen as illustrations or demonstrations of colour theory.

## 1. COLOUR THEORY

Colour theory is an elastic term that can be understood in a broad or narrow way. Roy Osborne introduces colour theory as “an excellent subject with which to unify many aspects of human experience.” (Osborne 1990: 14-16). Here I will focus on just three aspects of colour theory: colour order, colour mixture and perceptual colour phenomena. These aspects of colour theory can be seen to be playing a part in the work of a number of artists. They are best introduced to students with the aid of explanatory diagrams and, in some cases, the diagrams themselves can be viewed as artworks. As an educator, I have designed a number of such diagrams and I wanted them to look good. In 1995, four of my designs were included in a fund-raising art exhibition organized by students of Design at Curtin University. This led me to consider the diagrams in a new light; perhaps I could now think of them as artworks.

## 2. COLOUR ORDER

The most familiar manifestation of colour order is the hue sequence as embodied in a colour circle. Isaac Newton’s colour circle, published in 1704 (Kuehni and Schwarz 2008: 128), was clearly not thought of as anything more than an explanatory diagram, but in Ignaz Schiffermüller’s *An Attempt towards a Color System* of 1772 (Kuehni and Schwarz 2008: 59) there is a much more elaborate illustration which links the hue circle to the rainbow and the spectrum and indicates its significance to the art of painting. The Schiffermüller illustration could itself be considered an artwork.

### 2.1 Richard Paul Lohse, Aemilius Müller and Karl Gerstner

The development of non-figurative abstract painting in the twentieth century allowed colour sequences themselves to be the subject matter for art. Richard Paul Lohse based a number of his paintings on the hue sequence of the colour circle (Nemcsics 1992: 11-13). Three-dimensional colour order systems provide more scope for artworks that feature colour sequences from colour space. Aemilius Müller developed his own version of Ostwald’s system and produced a number of beautiful designs to illustrate colour gradations within that colour solid (Wettstein 2009: 148-149). Karl Gerstner’s work also features carefully graded colours, in his case based on the Optical Society of America Uniform Color Scales (OSA UCS). Of this system Gerstner writes that “it imparts a surprisingly novel experience of color and could not be more stimulating to the artist.” (Gerstner 1986: 8)

## 2.2 Colour Zones

In the late 1970s I was struck by the gap that exists between the simple colour circle and the comprehensive colour order systems. I set out to develop a model that could bridge this gap, that would include light, pale, deep and dark colours as well as the vivid colours of the basic colour circle. My first design was unsatisfactory in many respects (Green-Armytage 1980: 166-175). In 1981 I was introduced to the Natural Colour System (NCS) which struck me as a simple and clear basis for working with colour and I have included it in my teaching programmes ever since. However, the idea of a model to bridge the gap between the colour circle and colour order systems did not die. At the AIC Congress in 2001 I presented my proposal for a system of *Colour Zones* (Green-Armytage 2002: 861-4). The system has three levels of precision which are to serve as stepping stones between Hering's six fundamental colours (Urfarben) (Kuehni and Schwarz 2008: 100) at level one, and the NCS, which would be the next step beyond level three (Figure 1).

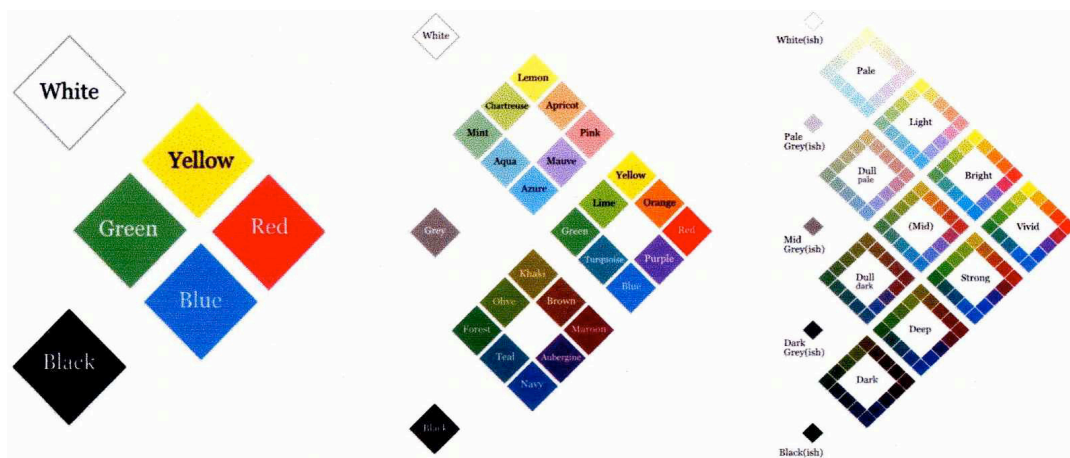

Figure 1: The three levels of the Colour Zones system.

I developed two sets of diagrams to explain the idea. I showed this set (figure 2) at the Colour Society of Australia's conference in Sydney in 1999.

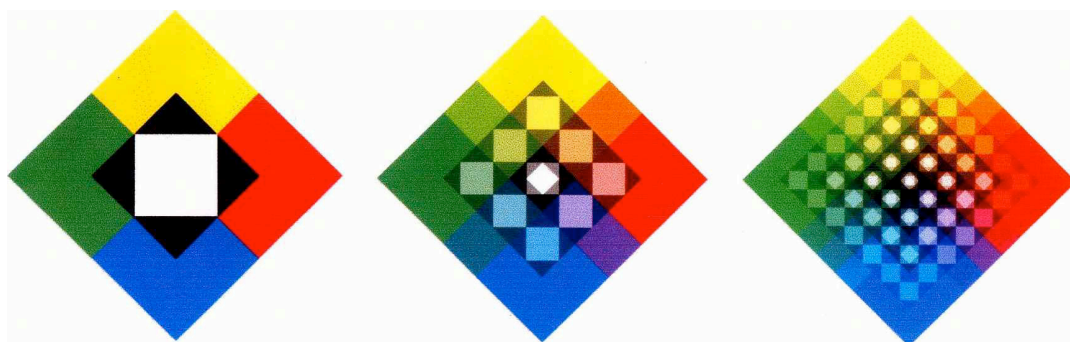

Figure 2: Alternative diagrams illustrating the three levels of the Colour Zones system.

## 3. COLOUR MIXTURE

There are different ways of mixing lights, paints, inks and dyes to produce a range of colours from a set of 'primaries'. Subtractive mixture, from the overprinting of transparent paint, has been exploited by Paul Klee and is illustrated in figure 3. A form of additive mixture, better described as partitive mixture, occurs when areas of different colour are seen in rapid succession, or when they are too small to be resolved as separate colours. The colours blend

and we see a new colour. *The Gate of Colourland*, by Antal Nemcsics, was exhibited at the Venice Biennale in 1986 (Albrecht 1993: 7-8). This is a demonstration of partitive mixture as well as being a very impressive artwork. Square panels, mounted in a grid array, are motorized to spin. Each square is painted in segments with areas of black alternating with other colours. Towards the middle of the array the black segments are larger in relation to the other segments so the colours seen, when the central squares are spun, are darker and less vivid. Partitive mixture, with small areas of colour that blend in the eye, was exploited by the pointillist and divisionist painters such as Georges Seurat and Paul Signac. My own design to illustrate partitive mixture was among the diagrams I exhibited at the students' fund-raising exhibition in 1995 (figure 4).

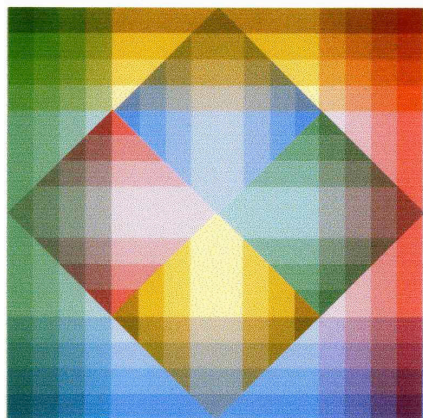

Figure 3: Subtractive mixture.

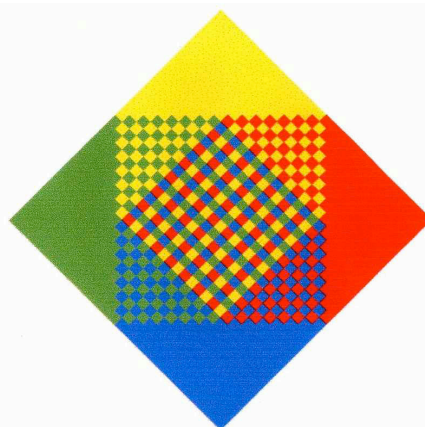

Figure 4: Additive (partitive) mixture.

#### 4. PERCEPTUAL COLOUR PHENOMENA

Josef Albers explored perceptual phenomena in the extensive series of paintings and prints that he called *Homage to the Square*. The fact that two areas, on different paintings, have been painted with the same paint does not guarantee that those areas will appear to have the same colour. Albers set tasks for his students that would lead them to discover the phenomenon of simultaneous contrast. In a particularly challenging exercise a uniformly painted linear pattern was to be superimposed on a divided background with paints mixed in such a way that the colour of the pattern on the left appears to be the same colour as the background on the right and vice versa (Albers 1971: VI-3). What makes this design particularly striking is that the pattern continues across the boundary between the background colours as 'proof' that the linear pattern is, indeed, the 'same colour' on both sides. I used this device of a continuous linear pattern in my own designs to demonstrate phenomena of simultaneous contrast (Figure 5) and in a variation on White's Illusion (figure 6). I also use these designs to clarify the distinction between colours as something physical – the inks used to print the designs – and colours as what we see.

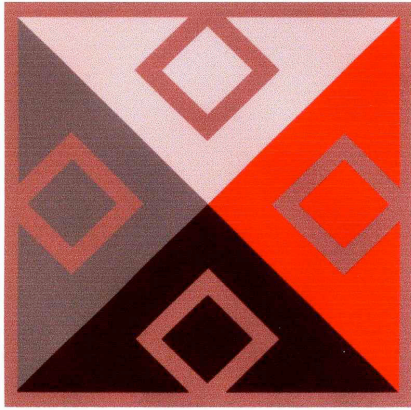

Figure 5: Simultaneous contrast.

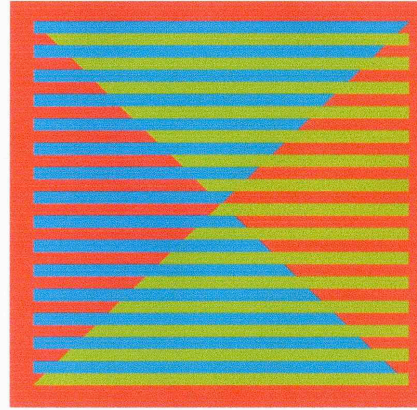

Figure 6: Variation on White's Illusion.

## 5. CONCLUSION

Colour theory, as a guide to harmonious colour relationships, the processes of painting and perceptual colour phenomena, is best presented visually. Some paintings can incorporate demonstrations of colour theory and some explanatory diagrams can be sufficiently satisfying that they themselves can be regarded as artworks.

## REFERENCES

- Albers, J., 1975. *Interaction of Color*. New Haven: Yale University Press.
- Albrecht, H., 1993. The Artist of the Colours. In *Axial and Coaxial Orders*. J. Mészáros. Budapest: International Colour and Light Foundation.
- Gerstner, K., 1986. *The Forms of Color*. Cambridge, Massachusetts: The MIT Press.
- Green-Armytage, P., 1980. Violets aren't blue: Colour sensations and colour names. In *Arts in Cultural Diversity*. J. Condous, J. Howlett and J. Skull. Sydney: Holt, Rinehart and Winston.
- Green-Armytage, P., 2001. Colour Zones - Explanatory Diagrams, Colour Names, and Modifying Adjectives. In *AIC 2001 - The Ninth Congress of the International Colour Association*. R. Chung and A. Rodrigues. Rochester, New York: SPIE - the International Society for Optical Engineering
- Kuehni, R., and A. Schwarz, 2008. *Color Ordered*. New York: Oxford University Press.
- Nemesics, A., 1992. The Colour Circle in the oeuvre of Richard Paul Lohse. In *Richard Paul Lohse*. B. Holeczek, B. James, J. Lohse James, L. von Mengeden and L. Vachtova. Budapest: International Colour and Light Foundation
- Osborne, R., 1990. Teaching Colour. *The Artist*. April 1990.
- Weston, R., 1996. *Modernism*. London: The Phaidon Press.
- Wettstein, S., 2009. Aemilius Müller – Aesthetik der Farbe in natürlichen Harmonien. In *Farb-Systeme 1611-2007, Farb-Dokumente in der Sammlung Werner Spillmann*. V. Schindler, S. Wettstein, I. Haupt, L. Sibillano and W. Spillmann. Basel: Schwabe Verlag.

*Address: Dr Paul Green-Armytage, School of Design and Art, Curtin University.*

*Home address: 55 Evans Street, Shenton Park, 6008, Western Australia*

*Email: p.green-armytage@curtin.edu.au*



# Synergies of Colour in Sculpture

Claudia H. STERN

Partners of the Americas Rio Grande do Sul – Indiana  
Associação de Artistas Plásticos Francisco Lisboa

## ABSTRACT

Synergy is defined as the work or coordinated effort of several systems in the accomplishment of a complex task or function. The lecture refers to the intellectual production of the sculptress Claudia H. Stern from Brazil. She intends to observe the relationships between Art and Science establishing a link among the use of colour and the human being evolution. Colour has a significant psychological influence over the human being and the three-dimensional aspect reinforces the idea of harmony of form and content. It is a rich and visual example of creative thought and ideas rendered in an artistic career in Brazil and exterior. The sculptress uses concepts of astronomy and principles of physics in her more recent creations. She has created works where the light falls onto the object producing shade; the light falls onto the surface and is reflected by it; the light goes from one medium to another suffering deviation or even the decomposition of the white light through the prisms formed by the folds in a transparent material. In this exhibition, the new concepts that she has been employing in the art, through her 49 constructed public works will be commented on by audio-visual means.

## 1. SYNERGIES OF COLOUR IN SCULPTURE

The works of Claudia Stern, from Brazil, have established the interactions between the Art and the colour chosen by her in polished, oxidised bronze, Corten steel, stainless steel, painted steel, wood, Carrara marble, granite and basalt.

Colours have a significant psychological influence over the human being. The three-dimensional aspect reinforces the idea of harmony of form and content.

By observing the sequence of the forty nine (49) art works in public spaces, the artist realized that she was using colours in a spontaneous way. Follow the examples:

### 1.1 The use of Colour in the representative form

“The Sun” 1976, concrete. Camboriú, Santa Catarina, Brazil, BR. The yellow colour was incorporated to the material.

### 1.2 The use of Colour contrasting the representative aspect

“Movement” 1981, bronze. Brazilian American Cultural Institute – BACI collection, Washington, USA. It represents the female figure in green colour – peace, safety, trust, shelter. Copper, sulfuric acid.

“Mother of God” 1985, bronze. Mãe de Deus Hospital, main entrance. Porto Alegre, BR. Patina with copper and sulfuric acid. The artist choose the green colour to reinforce the quietness of a hospital instead of the conventional blue for this dress.

### 1.3 The use of Colour reinforcing the implicit idea

“Humanity – complex relationship” 1981, marble. Washington, USA. The white colour suggesting sobriety and purity is the natural colour of the material selected.

“Development” 1990, Corten steel. Porto Alegre, Brazil, BR. White colour. The work talks about human development.

“The Dolphin” 1992, concrete. Imbé, Brazil BR. This work consists of three abstract elements, separated to each other. The outline of the dolphin, leaping out of the river is formed by the multi-colored landscape in the background of the image. 14 years later Walmart reproduces the work at the main entrance of the city.

“Balance” 1979, Corten steel. Museum of Art – MARGS collection, Rio Grande do Sul, BR. A single welding guarantees the stability of the work. Static balance. Red.

“Social Energy” 1993, mobile, wood. Unishoping, Lageado, BR. A work consisting of two curved profiles suspended by steel cables. The movement produces new forms and colour nuances. Red.



*Figure 1: Social Energy.*

The red colour – action, movement, pulse – reinforces the implicit idea of alert in the works above mentioned.

#### **1.4 The use of Colour by white light dispersion**

“Prophecy”, sun clock, 1996, aluminum and copper. International Garden of Sculptures, University Puerto Rico (UPR). She used the natural color of the raw materials (slide 10).

“Monument to Zumbi” black leader, 1997, stainless steel. Açorianos Park, Porto Alegre, BR. During the day time, the reflection of the sunlight on the surface of the prismatic pointer embedded in the ground, illuminates each letter of the word – Liberty – (Liberdade) on a semi-circular wall of concrete.

“Time and Space” 1997, sun light. Maurício Cardoso Square, Porto Alegre, BR. Visitors can walk over the sculpture, watching the sunshine movement on the floor pointing the four seasons, Solstice, Equinox... It also calls people attention to the ephemeral of man’s life and his transcendental condition. It can be read: the light is the way as the nature manifests itself.

“Memorial 1<sup>st</sup> of December against AIDS”, 2003, Ipiranga Ave., Porto Alegre, BR. Colour reflex of the light. Useful information against AIDS is recorded in stainless steel. The sun goes through a hole and illuminates the point: December 1<sup>st</sup>. This is another educational art work which stimulates the curiosity and the dialogue of social groups on the prevention of AIDS.

The sculptures and monuments realized in different periods of the artist career are presented as proposal for reflection about the changes in course.

## 2. TO SEE AND TO LOOK

Our extremely visual culture has been presenting progresses in the technology of seeing but not being able to really look with a deeper glance. The monuments are reflexes of each time and as an outdoors diary, they tell the history of people. They attest the cultural level of the city immediately. They mark the presence of the “genius loci”, the spirit of the place. The cities are being taken by the billboards or by vandalism.

We see and we applaud a new technique but we didn't pay attention to the content from within. It urges the reflection! In the process of generating thoughts, she looks for ideas that can be translated in sculptures.

The glance includes the invisible of the object. It is the metaphysical experience that allows us to notice the other human being. Without this attention we develop a merchandise relationship with the visible objects. We see people as objects.

“Veritas – Truth”, 2000, stainless steel, with movement. Museo de Arte Contemporáneo – MAC, San Juan, Puerto Rico. The work “Veritas” moves when someone manipulate.

## 3. CONCLUSION: ART IN EXPANSION

The current works propose the reflection: colour use appears as a result of the own nature. Synergy! The sculptress uses concepts of Astronomy and principles of Physics in her recent creations, e.g. Flech et al, 2005:127. She has created works where some light falls onto the object and produce shade; some light falls onto the surface and is reflected by this surface; the light goes from one medium to another, suffering deviation or even the decomposition of the white light through the prisms formed by the folds in a transparent material.

“Constructio” and “Water Fountain” are interesting projects on this point.

“Cristal – Painting a better world”, 2010. Research awarded by CriAçãoScotch, 3M. Brazilian Museum of Sculpture – MUBE, São Paulo, Brazil.

The project of the light onto the folds of a transparent material produces the effects of crystals decomposing the white light into beautiful colours that change of nuances through the day. The work is dynamic as the Life is.

The colour used by Claudia Stern in the representative or complementary form, sometimes reinforcing the idea of the work, sometimes contrasting with the environment, now exists in the sculpture as a result of its own nature.

Synergy!

This way leads us to reflect that the evolution of colour and its broad perception has been accompanying the human evolution.

Actually, the man is not considered the center of the universe and has become an integral part of it.



Figure 2: *Cristal – painting a better world.*

### ACKNOWLEDGMENTS

1<sup>st</sup> Cartographic Division, Brazilian Army, Porto Alegre, Brazil.

Department of Astronomy, Federal University of Rio Grande do Sul - UFRGS, Brazil.

Observatory of Astronomical Researches, Servicio of Antenna, Arrecibo, Puerto Rico.

### REFERENCES

Assman, A., 2003. Gramática da memória coletiva In: *Humboldt*, Goethe Institut Internationes.

Flech L., J. Betts and E. Viero, 2005. *Sob o véu transparente - recortes do processo criativo com Claudia Stern*. Porto Alegre: Coleção Arte & Psicanálise, Editora Território Artes.

Hecht, E., 1998. *Optics*. 3rd Edition . Massachusetts. Addison Wesley Longman.

*Claudia H. Stern,  
Av. Carlos Gomes nº1302 apt. 03, Porto Alegre, RS, Brasil CEP90480-001  
E-mail: claudiastern@terra.com.br*

# Vertical Landscapes

Melanie YONGE  
Isis Colour, Paris

## ABSTRACT

ISIS COLOUR studio practices a craft of weaving colour, texture and light in architecture. The scale of colour expressed through planes and volumes to guide people through space. Constructing careful colour conversations between applied paint, architectural material and light to allow the spaces within building forms to become part of a greater language connected to their surrounding environment with a sense of identity and culture and place.

ISIS COLOUR has developed made-to-measure colour and material palettes for a Parisian entrance hall and a private home in New Zealand. The colour palettes are constructed as architectural sections creating a vertical landscape that may be read as a colour keyboard, a harmony, or a colour chart. The resulting harmonies bring colours from an external environment inside. The paint pigment recipes and material palettes are created for specific spaces to take into account natural and artificial light. The colours and their material aspect are carefully selected so that each tone carries the right properties for its placement in the spatial context. Interior spaces have been transformed into vertical landscapes themselves: a majestic staircase rewritten as a vertical keyboard, floor planes inspired by earth textures and ceiling planes echoing light in the forest.

## 1. COLOUR STUDIES LUANG PRABUNG, LAOS

Luang Prabung is framed by two rivers and endless mountains in the north of Laos. The colours of sand found on the banks of the river, the exultant harmonies of the flora and fauna, as well as, the life of the local markets create strong images of culture and identity of place. Colours of the light and the changing perception of the mountains in the distance as well as the structure of the ground itself enrich the palettes representing local and perceived colour.

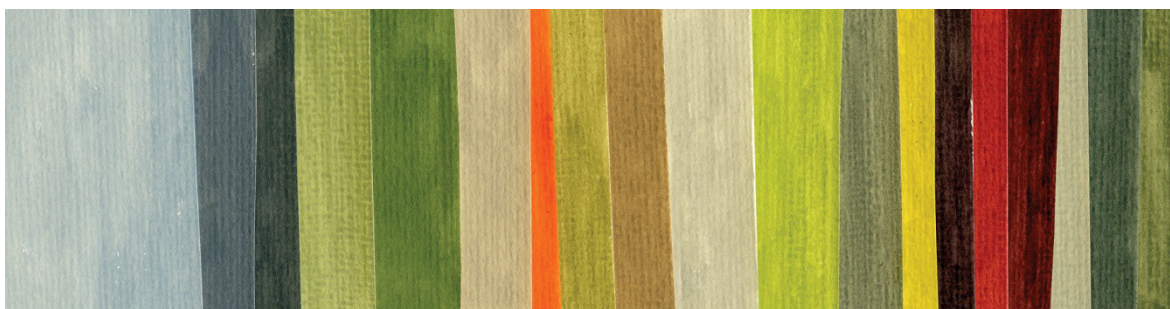

*Figure 1: Colour Studies Luang Prabung, Laos.*

The colour studies are made in the form of “colour notes” or “colour keyboards” which are captured through various mediums and techniques such as collage, photography and watercolour. Whether the subject is a flower, river pebbles, the perceived or local colour of the rainforest bathed in changing light, the studies are observations of detail, texture, form and colour. The architectural palette brings together colours from Europe into a traditional Laotian context through details of wood, stone, painted stencil motifs, painted gold detailing, tiles and metals. The architectural styles are a mix of Laotian, Vietnamese influenced

commercial buildings and French colonial residences. The palette of colours seen in spun threads, woven cloth, patchwork and embroidery animate the whole city. The tradition of creating fabrics in Laos is extremely rich both historically and today capturing a wealth of colours and techniques.

## 2. COLOUR CONCEPT FOR A PARISIAN ENTRANCE HALL

The colour concept for a Parisian entrance hall was constructed as a result of the Laotian colour studies. The concept of the “vertical landscape” brings together colours from the ground to the sky: an architectural colour section. The initial colour concept was presented in watercolours and then transposed into pigment recipes for paint applications, transparent film for glass, perforated fabric for blinds and carpet tiles for circulation areas. Colour is used to give the building a strong identity through the application of a palette anchored in colours derived from a sense of place, culture and environment.

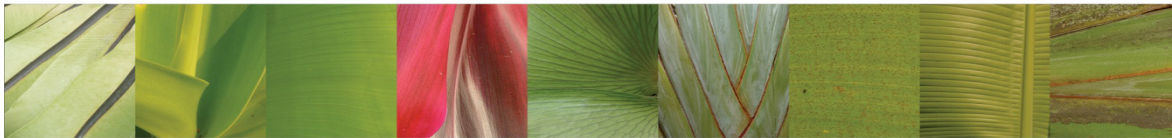

*Figure 2: Photographic Mural Entrance Hall Paris.*

Entering the lobby, the visitor is confronted with a strong band of colour and texture harmonies in the form of a large-scale photograph depicting details of the vegetation along the banks of the Mekong. Bands and blocks of applied paint colour are strategically placed to lead the eye around the spaces engendering a fluid movement through the building. The body colour linking the coloured geometric forms is a natural greyed white emanating the colour of the light in Paris. The majestic staircase in the central glass-roofed atrium led ISIS COLOUR to imagine a river of colour drawing people up to a clearly marked first and second floor. The staircase is transformed into vertical landscape. The carpet tiles are random patterns of colour and structure inspired by the texture of the earth’s floor. The colours of the translucent blinds influence the colour and the nature of the light entering the building and are positioned to take part in the geometric colour reconfiguration of the spaces.

## 3. COLOUR STUDIES HUNUA RANGES, NEW ZEALAND

The colours, textures and forms of the indigenous forest of New Zealand are both unique and diverse due to its isolation from other lands, mammals and man until the arrival of the Polynesians. Largely evergreen, the forest canopy is a complex tapestry woven with hundreds of shades of green due in part to the constant rapid changes of fluorescence in the green leaves after exposure to the intense light. Today the Hunua Ranges is home to 450 indigenous species as well as distinctive shrub-lands, grasslands, exotic forest and farmland. Basalt lava due to volcanic activity, yellow-brown earths, grey and red mudstones line the sparse forest floor and tributary stream valleys. The Hunua colour studies have been created as a response the colours of land, the vegetation and the constant changes of light in the southern hemisphere. The studies are carried out by gathering samples from the natural world, and making colour notes through photography, watercolour and gouache. The notations are then transformed into complex pigment recipes for threads hand spun in banana silk, bamboo, cotton, linen, wool or for various paint coatings for a private house.



Figure 3: Colour Concept for a Private House in New Zealand.

#### 4. COLOUR CONCEPT FOR A PRIVATE HOUSE IN NEW ZEALAND

The Hunua Ranges Colour Palette was the point of departure for the creation of a palette of colours and materials, made to measure furniture and carpets for a private house set in one of the secret valleys in Hunua Ranges. The house design is inspired by early 19<sup>th</sup> century Australian bungalow architecture with deep shady verandahs, French doors and windows protected with wide bladed shutters to retreat from the light and heat. The surrounding gardens were carefully constructed in colour, texture and form using native shrubs, groundcovers, grasses and rushes. Iconic “ti kouka” or cabbage trees, as well as, “harakeke” or flax are key structural and colour elements of the garden.



Figure 4: Colour Concept for a Private House in New Zealand.

The house is constructed with local “hinuera” stone with a tin roof painted in a silver green reflecting the light in forest. The wood paneled ceiling above the verandah is another shade of silver green. A shade, which continues onto the ceiling of the entrance hall and gallery to connect the inside and outside whilst mapping out the circumference and the spine of the ceiling planes. The entrance and gallery is the only space with white walls creating a colour measure. Each space folding off the gallery is rendered in a different colour inspired by the leaves, the earth and the light of the surrounding forest. The mysterious black silver purple of the “black rage flax” inspires the colours for all the utility rooms. The perceived colour of the native forest in the distance inspires the colour of the bathing block. The use of colour in the garden and the architecture firmly link this home to the surrounding indigenous landscape.

#### 5. VERTICAL LANDSCAPES

ISIS COLOUR creates colour and material palettes annotated through observations over time. Colours inspired by natural environments, cultures, people and place to represent vertical landscapes from the ground to the sky. Colour palettes used to manipulate space,

influencing its circulation and construction, as well as, its decoration. The use of colour is approached in a way that may be likened to a beautiful expression of words forming a language rich in communication and poetry sculpting shape and colour and texture in a play of light. Rhythm, style and format are just a few notions that change the way we read an object, a surface or a space. The complex boundaries caused by fluctuations of light, shade and hue in architectural space are often the moments of poetry and emotion that we remember.

### ACKNOWLEDGEMENTS

France Cler, Michel Cler and Jean-Philippe Lenclos, who have been such a wonderful inspiration. Prue Cook and Aalto Colour who helped me to see colour differently. Dr Leonhard Oberacher and Pierre Bonnefille who have shared so much with me.

### REFERENCES

- Yonge, M., and F. Cler,. 2011. Interactive Chromatic Tools for Architecture and Design. In *AIC Zurich 2011, Proceedings*, ed. by V.M. Schindler. Zurich.
- Yonge, M., 2010. Colour Conversations and Collaborations with Colour Tools. In *Colour & Light in Architecture, Proceedings of the first International Conference 2010 in Venice*, ed. by P. Zenaro. Venice, 540-547.

*Address: Melanie Yonge,  
Isis Colour, 10 rue de Palestine, 75019 Paris, France  
E-mail: mm2@isiscolour.com*



# The Visual Weight

Raúl PARADA, Joaquín CASADO  
E.T.S. Arquitectura, Universidad de Granada (España)

## ABSTRACT

This research presents the development of a method and software to calculate the visual weight of an image. We define the visual weight as the result of visual forces that convey an image when interacting basic sensory qualities of colour and shape due to the feeling of gravity. Also, this method calculates the position where the force stands on the visual image or the visual center of gravity. The determination of the centre of gravity becomes a useful tool in the analysis of the balance of an image because it determines their geometric relationships with the center and with the framework in which it is inserted. Since the appearance of an image varies constantly due to changes in lighting and position, the method enables the analysis of variability, studying the extent of image weights over a time or following the route taken by the center gravity along this.

## 1. INTRODUCTION

This paper stems from the aim to continue and develop the research conducted by Joaquín Casado about De Stijl's compositional theories on visual weight. This work also attempts to resolve the issue raised by Rudolph Arnheim<sup>1</sup> about the absence of exact method to determine the visual weight balance of an image.

## 2. METHOD

This method uses any representation as visual image that can be expressed by a two-dimensional digital photography. Colour-Shape interactions appear in the study of the elements of our visual image and the relationships between them. These interactions create tensions on our visual perception processes. We can represent a resultant force of these stresses on one point of application, with a magnitude and a specific direction within the framework of our visual image.

### 2.1 Interacting factors

The first factor is due to colour. Opaque objects are made visible to reflect light diffusely. The perceived colour depends on the reflectance surface of the opaque object, that is, the amount of light of a range of wavelengths which is reflected from a surface. This wavelength range can be observed in the re-emit spectrum as showed by Jorrit Torkins<sup>2</sup>.

In the course of occupying the entire spectrum of re-emit area, which would be an ideal white then the reflectance value would be 1 and in the opposite case of not occupying anything, we mean complete darkness would have a value of 0, so  $0 \leq Y \leq 1$ .

However, our calculations use the luminous reflectance factor instrumentally registered ( $Y_l$ ), and given that we can relate the lightness  $L_{N(NCS)}$  with  $Y_l$  according to CIE 1931, then we

1 Arnheim, R. 2007. *Arte y percepción visual*. Madrid. Alianza Forma.

2 Jorrit Tornquist. 2008. *Color y luz. Teoría y práctica*. Gustavo Gili.

can express the reflectance of a colour based on the lightness<sup>3</sup>, as follows:

$Y_l = 56L_N / (1.56 - L_N)$ . As  $Y_l$  will be between 0 and 100, we will divide by 100 to get values per unit;  $0 \leq Y_{l/100} \leq 1$  (Figure 1).

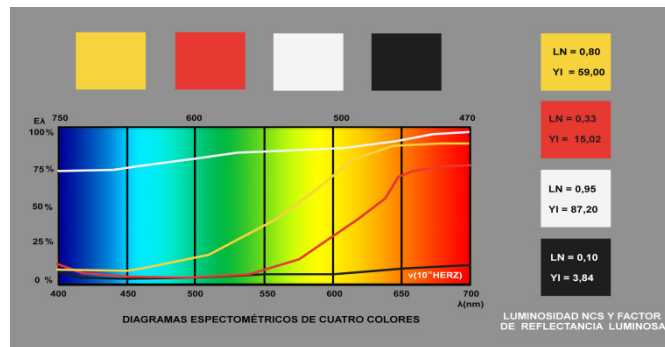

Figure 1: Re-emit spectrum of 4 colour, lightness  $L_N$  and luminous reflectance factor  $Y_l$ .

The other force factor is provided by the shape. We can determine that the larger the area occupied on a colour image is ( $S_v$ ), the greater the force on the visual image, such as J. Albert says<sup>4</sup>. Thus, if we adopt a size of 1 for the total image then the forms included in it will have values between 0 and 1;  $0 \leq S_v \leq 1$  (Figure 2).

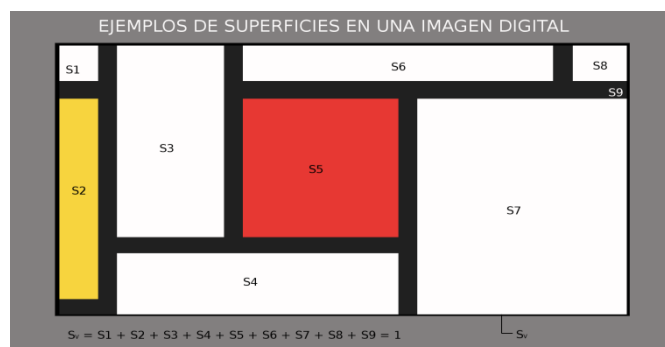

Figure 2: Example of shapes and surfaces in a image area.

## 2.2 The scene and the reflectance value

In a dark scenario, the colours that convey greater strength are those that reflect more light, ie those in which the area of its reflectance spectrum is fuller. In this case, we would have a value for the ideal white  $Y_{l/100} = 1$  and the black  $Y_{l/100} = 0$  as we have seen. However, the scene or background is not always black, it usually varies. For example, in a clear sunny day the scene is white and in this case the forces of these colours are reversed. The theoretical black colour becomes stronger with value 1 and white becomes the weakest with value 0 without contrast in the scene. In an intermediate scene, for example on a grey day due to the contrast a light color can transmit so strongly as a dark one. This possible scene variability requires us to introduce the concept of *generic scene* where generic reflectance factor of a colour is given by the contrast in absolute value between this scene and the reflectance of the particular colour for a black scene. Expressed as a decimal;

$$Y_{l/100g} = \left| Y_{l/100e} - Y_{l/100b} \right|$$

3 NCS. 1996. *Lightness Meter* Scandinavian Colour Institute. Stockholm, Sweden.

4 Albers, J. 1988. *La interacción del color*. Madrid. Alianza Forma.

Being:  $Y_{/100g}$  = Generic reflectance factor;  $Y_{/100e}$  = Generic scene = Reflectance factor average of the scene =  $P_{ve}$ ;  $Y_{/100n}$  = Reflectance factor for an ideal black scene or black background.

### 2.3 The Visual Force

Since the relationship between the reflectance factor and the size is directly proportional, this force can be expressed: As  $Y_{/100g}$  and  $S_v$  are between 0 and 1 then  $0 \leq F_v \leq 1$ .

$$F_v = Y_{/100g} \cdot S_v$$

### 2.4 Gravity and visual weight

We are constantly subjected to the action of gravity and this creates an association with visual forms giving them vertically downward action. Thus, in our terrestrial environment on a clear day, dark objects acquire more strength and these seem heavier<sup>5</sup>. In this sense, we will call *weight* to this unidirectional downward vertical force.

$$F_v = P_v \quad \rightarrow \quad P_v = Y_{/100g} \cdot S_v$$

### 2.5 Analogies

We can make analogies between physical weight and visual weight, as follows; If we call visual density or specific visual weight to the reflectance factor (J. Casado<sup>6</sup>) and visual volume to surface size, and on the other hand, if we set a constant value for visual gravity equal to one for being a constant feeling for the man in any earthly scene, then:

Table 1. Physical and visual analogies.

Physical Density	Visual Density
$D = m / V$ ; $m = D \times V$	$D_v = m_v / V_v$ ; $m_v = D_v \times V_v$
Physical Weight	Visual Weight
$P = m \times g = D \times V \times g$	$P_v = D_v \times V_v \rightarrow (g_v = 1 \text{ constant})$

### 2.6 The centre of gravity of an image

The calculation of the centre of gravity where the weight is placed on an image serves us to study the balance of it. As the sensation of gravity is constant then the centre of gravity coincides with the centre of mass, which is calculated as follows;

$$X_{cm} = \frac{m_{v1}x_{v1} + m_{v2}x_{v2} + \dots + m_{vn}x_{vn}}{m_{v1} + m_{v2} + \dots + m_{vn}} \quad Y_{cm} = \frac{m_{v1}y_{v1} + m_{v2}y_{v2} + \dots + m_{vn}y_{vn}}{m_{v1} + m_{v2} + \dots + m_{vn}}$$

Being, firstly  $m_{v1}$ ,  $m_{v2}$ , ...,  $m_{vn}$  visual masses, or what is the same  $m_{v1} = D_{v1} \cdot V_{v1}$ ,  $m_{v2} = D_{v2} \cdot V_{v2}$ , ...,  $m_{vn} = D_{vn} \cdot V_{vn}$ , and secondly  $x_{v1}$ ,  $x_{v2}$ , ...,  $x_{vn}$  and  $y_{v1}$ ,  $y_{v2}$ , ...,  $y_{vn}$  the coordinates of the centres of the masses visual reference axes  $x$  and  $y$ .

## 3. RESULTS AND DISCUSSION

We can see in the following composition introduced as digital imaging in Pv software, that is fairly balanced for a generic scene ( $P_{ve} = 0.6922$ ). On the other hand, we can also determine

5 Albers, J. 1988. *La interacción del color*. Madrid. Alianza Forma.

6 J. Casado. 2005. *J.J.J. Un reflejo del neoplasticismo en la Granada del XX*. R. EGA, Nº 10.

the centre on a white scene (Pve = 1) or on a black scene (Pve = 0), checking as the image is unbalanced to one side or the other (Figure 3).

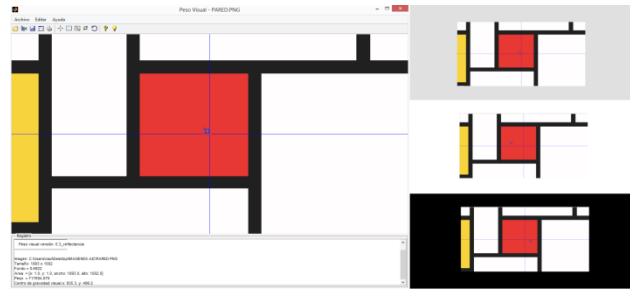

Figure 3: Example of weights and scenes.

On the actual development of the composition we can see that the weight of the image varies for three scenarios with different lights, being; P1=0.44, P2=0.40, P3=0.59. We can also determine the variability of the centre of gravity in the images 1, 2 and 3 (Figure 4).

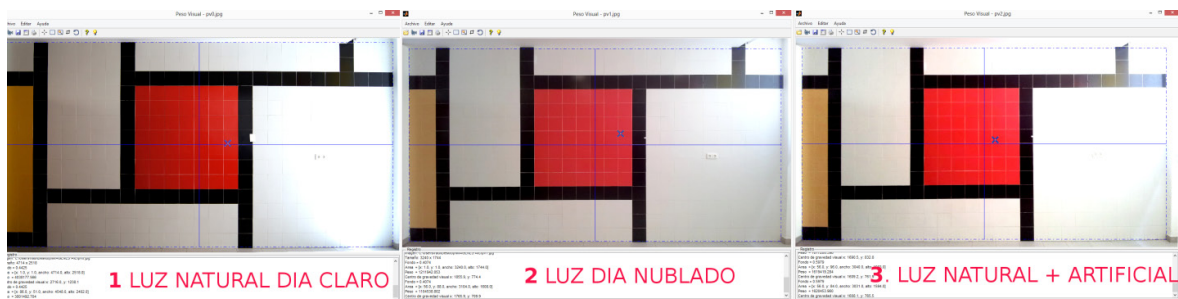

Figure 4: Example of weight variability.

#### 4. CONCLUSIONS

The method for calculating the visual weight together with the software developed are proposed as useful tools in the analysis of balance and composition of images, and they are equally helpful in the study of the appearance of images variability in the course of time.

#### REFERENCES

- J. Casado, 2005. J.J.J. *Un reflejo del neoplasticismo en la Granada del XX*. R. EGA, N° 10.
- Arnheim, R., 2007. *Arte y percepción visual*. Madrid. Alianza Forma.
- Albers, J., 1988. *La interacción del color*. Madrid. Alianza Forma.
- Jorrit Tornquist, 2008. *Color y luz. Teoría y práctica*. Gustavo Gili.
- NCS, 1996. *Lightness Meter*. Scandinavian Colour Institute. Stockholm, Sweden.

*Address: Prof. Raúl Parada, Departamento de Tecnología,  
I.E.S.Cartuja. C/Julio Moreno Davila, sn (18011) Granada, Spain  
E-mail: rparada@iescartuja.es*

# More than Nature's Colours

Kate WELLS

School of Art, Design and Technology, University of Derby

## ABSTRACT

Is it feasible that the chemicals present in the natural dyes and colours of both plants and insect, which in the past have been exploited for their colour, could exhibit other properties that in the future will be understood and exploited for the health and wellbeing of mankind?

In this paper, I will discuss this and other questions as to the possibilities that may exist within the chemical nature of certain natural dyes to help with healing and well-being and if in the future we will be wearing clothes dyed with such colours from nature that we will be able to enhance our well being as well as being fashionable?

Historically many dye plants were once regarded to possess 'magical properties' with the power to heal and to keep evil away. Today many of these plants that can be used for dye extraction are classified as medicinal and in recent studies have been shown to possess remarkable anti-microbial activity. The cosmetic industry now employs many natural dyes due to the fact they will cause fewer side effects than the employment of synthetic dye stuffs and but they also provide extra properties such as UV protection and anti-aging. Chengaiah et al (2010:1).

## 1. INTRODUCTION

In the world today, the position of natural dyes and colorants, 'nature's colours' are at a cross-road: either they will vanish and with them the ancient knowledge and skill that has evolved over centuries and across civilizations or they will evolve to a new form of colouration and with this be applied to new environmental/sustainable applications and possibly be recognised for the health/healing aspects they can provide.

Since the dawn of humankind the quest for sources of dyes and pigments went abreast with the selection for food and medicinal plants. Today a whole spectrum of colours can be obtained from a multitude of plants, insects and fungi, and these have been used across the centuries to dye textiles, colour artefacts, pattern and colour our skin, hair and even the food we eat. The discovery and use of which have contributed to the maintenance of a strong bond between human kind and nature, which with help could revive and enhance what was once integral to human society. Natural dyes and colorants are still an essential part of the world's ecological and cultural heritage and their selection and use to create permanent colours that were once common to all nationalities is now in decline. Cardon (2010: 1)

Faith in the healing power of colour is ancient but we must remember colour in the past was not an abstract concept but was often defined by its source in nature for example, Bryan (1930: 33-38) translation of the Papyrus Ebers dating from 1550 BC listed among its cures were indigo: blue; red: lead; copper: verdigris; black: knife stone; and white: oil but also mentioned were plants such as pomegranate, elderberry, henna, indigo, onion, saffron and turmeric which were used for colouration purposes as much as for healing. Today many of these plants continue to be used as 'nature's colours' in the colouration, cosmetic and food industries.

Historically many dye plants were once regarded to possess 'magical properties' with the power to heal and to keep evil away. For example Indigo (*Indigofera tinctoria*) and Woad (*Isatis tinctoria*) produced the colour blue, a scarcity in the natural world and with its production arose mystery and superstition. This was possibly enhanced by the almost magical reaction that happens during the dyeing process and as a response to the complexity involved in producing a permanent colorant blue from the plant material.

Throughout the World indigo blue was and in some areas still is considered a 'cool' and 'magical' colour and has in the past been widely used for cooling feverish conditions. The dyes are said to have a 'cooling' quality but could this be linked more to the visual colour than any physical properties held within the dyestuff. There are extensive accounts of its use throughout history, many of which list the countless ailments that indigo and its European equivalent woad have been reputed to cure, these are based mostly upon its apparent antiseptic, astringent and purgative qualities, although it is also said to prevent nervous afflictions such as hysteria, epilepsy and depression. Balfour-Paul (1998: 218-219).

The European Elder (*Sambucus nigra*) was historically regarded as a magical plant with the power to keep evil spirits away and was once thought to have a myriad of uses and health giving properties. Historically various parts of the elder tree have been used in medicine while the berries were used to make wine and pies but also employed as a natural dye. Currently, extracts of the berries are used primarily as anti-viral agents for colds, influenza but recent research shows that they have immune modulating, anti-oxidant, and insulin-stimulating properties due to their high proportions of anthocyanins present. (*Alternative Medical Review*: Anon., 2005). These chemicals are also known to possess anti-inflammatory functions.

Henna (*Lawsonia inermis*) has been used as a colorant for over three thousand years and was often mixed into a paste and used to colour skin and hair. It is still widely used in cosmetology for its dyeing properties. Today henna is used in Ayurvedic medicine for the treatments of rheumatism, insect bites, skin ailments, burns and wounds to name a few. It is also proven to have antifungal and antibacterial properties that are linked to the active component lawsone the same chemical that provides its colouring/dyeing properties. Prakash and Majeed (2008: 3)

Is it feasible that the chemicals present in these and other natural dyes and colorants of both plants and insect, which in the past have been exploited for their colour and possible magical qualities, could exhibit other properties that in the future will be understood and exploited for the health and wellbeing of Mankind?

## 2. DISSCUSSION

Many plants that are used for colouration purposes are often also classified with medicinal properties, and some have recently been shown to possess strong anti-microbial activity. Plant pigments such as anthocyanins and carotenoids have scientifically validated antioxidant and anti-inflammatory benefits. Prakash and Majeed (2008:2). The pomegranate (*Punica granatum*) along side many other common natural dyes are also reported as potent anti-microbial agents owing to the presence of large amounts of tannin in their chemical structure. While several other sources of plant dyes are reported to exhibit both anti-bacterial and anti-fungal activity and these contain the colouring pigments naphthoquinones such as lawsone from henna (*Lawsonia inermis*), juglone from walnut (*Juglans nigra*) and alkannin from alkanet (*Alkanna tinctoria*) Siva (2007:918).

According to Cannon and Cannon (2007: 17-18) the most important pigments that are used for producing colours on natural fibres can be classified as follows and these are the same chemicals that have been proven to have health giving qualities such as anti-microbial and anti-inflammatory. Anthracenes include several pigments found in the madder family. The insect dyes cochineal, kermes and lac are also included here. Naphthoquinones are related compounds and include *juglone* from Walnuts; *alkannin* from dyer's alkanet; and *lawsone* from Henna. Carotenoids are also colouring pigments and include *lutein* from Nettles, French marigolds, *Bixin* from annatto and *crocin* from Saffron. Tannins are found in small quantities throughout most plant tissues but are concentrated in the bark and in damaged tissues such as galls and wounds. They are formed from flavonoids, particularly anthocyanins: *gallotannins* are found in oak galls and young fustic and *ellagitannins* found in the sumac. There are a few unrelated pigments these include *indigotin* from indigo, woad and other blue dyeing species, the diarylmethane *curcumim* comes from turmeric, pterocarpans from sanderswood and the neoflavonoid *berberine* from barberry and mahonia.

Is it possible that the chemicals present in natural dyes, which are responsible for forming these pigments can if present in a dyed fabric move or rub-off from the fabric to the surface of the skin thus providing anti-bacterial and anti-inflammatory properties and help promote healing and well being?

With modern medicine now accepting the fact that the skin as an organ has greater absorbency properties that was once recognized. Drug manufacturers are developing new administrative procedures in which drugs such as Ibuprofen in the form of gels and nicotine or hormones as skin patches can now be delivered through the skin. Could such methods of drug administration via the skin through absorption be applied to the healing properties of natural dyes if these were applied to the skins surface?

This is not a new concept or process, the monologue Indigo Jenny Balfour-Paul, (1998:220) records that in countries in the southern Arabian Peninsula during the late 1980's Men were applying indigo healing treatments to their skin, sometimes choosing them in preference to available modern medicine. Some were convinced that wrapping an indigo cloth coated in beeswax and oil around a wound was more effective than modern antiseptic lotions.

#### 4. CONCLUSIONS

There are no set conclusions within this paper. The paper was written to promote thinking and enquiry by asking the question:

Is it feasible that the chemicals present in the natural dyes and colours of both plants and insect, which in the past man has exploited for their colour, could exhibit other properties that in the future will be understood and exploited for the health and well-being of mankind?

And as a result of my discussion, I hope I will inspire some form of collaboration across the fields of colour chemistry, natural dye practice and cultivation, anthropology along with modern and alternative medicine to take a closer look and research into the potential possibilities that the colouring pigments present in natural dyes could provide in terms of health and well being.

The mystic and magical properties that were once inferred upon natural dyes by our ancestry, recognised by other indigenous people and acknowledged for centuries by mankind, without any kind of scientific understanding as to why these properties existed could

provide today's society with more than nature's colours. Certain natural dyes and colorants have been proven to possess medicinal healing qualities, these could be exploited to provide mankind with more than just colour and initiate a return to wearing clothing dyed with natural colouration substances (dyes) and as a result produce an added health bonus that has not thought to have existed in the western civilisation since the discovery of the first synthetic aniline dyes in 1856.

#### REFERENCES

- Anon., Monograph: *Sambucus nigra*. *Alternative Medicine Review*. pdf 2005.10:(1), pp 52-55. Thorne Research Inc.
- Balfour-Paul, J., 1998. *Indigo*. London: British Museum Press.
- Bryan, C., 1930. *The Papyrus Ebers*. London: Geoffrey Bles.
- Burg, G. (Ed), 2003. *Textiles and the skin*. Basel: Karger.
- Cannon, J., and M. Cannon, 2007. *Dye Plants and Dyeing*. London: A & C Black. Publishers in association with the Royal Botanical Gardens, Kew.
- Chengaiyah, B., K. Mallikarjuna Rao, K. Mahesh Kumar, M. Alagusundaram and C. Madhusudhanachetty, 2010. Medical Importance of Natural dyes – A Review. *International Journal of PharmTech Research*. 2 (1): 144-154 Also available online, [http://sphinxesai.com/sphinxsaivol\\_2no.1/pharmtech\\_vol\\_2no.1/PharmTech\\_Vol\\_2No.1PDF/PT=24%20\(144-154\).pdf](http://sphinxesai.com/sphinxsaivol_2no.1/pharmtech_vol_2no.1/PharmTech_Vol_2No.1PDF/PT=24%20(144-154).pdf). Accessed: May 8 2013
- Prakash, L., and M Majeed. 2008. *Natural Actives Lend Color to Cosmetics and more....* Sabinsa Corporation. Also available online, [www.cosmeticsdesigneuropa.com/.../Sabinsa\\_CDE\\_wk14\\_2008.pdf](http://www.cosmeticsdesigneuropa.com/.../Sabinsa_CDE_wk14_2008.pdf) Accessed: May 8 2013
- Siva, R. 2007. Status of Natural dyes and dye-yielding plants in India. *Current Science*. 92 (7): 916-922. Also available online, [http://www.currentscience.ac.in/Downloads/article\\_id\\_092\\_07\\_0916\\_0925\\_0.pdf](http://www.currentscience.ac.in/Downloads/article_id_092_07_0916_0925_0.pdf) Accessed: May 8 2013

*Address: Dr Kate Wells,  
School of Art, Design and Technology, University of Derby, UK  
E-mails: k.wells@derby.ac.uk, drkatewells@gmail.com*



# The Role of Outline upon Design Transformation

Vojko POGACAR

University of Maribor, Faculty of Mechanical Engineering, Engineering Design Lab

## ABSTRACT

*Gestalt* psychology confirms the conclusion that our mind tends to simplify visual perception of our environment in order to be perceived and understood faster and better. All complex forms in our environment we are trying to explain by more geometrically regular shapes, such as Triangle, Square, Circle etc. The simpler the form, the easier is to perceive and understand it. A Triangle and a Circle represent a fundamental opposite shapes in design and all other shapes in between are just variable transformations of these two geometrical extremes.

But, how are the shapes described? The colours cover the entire surface, but the edges of the shape are defined by the outlines. And, if we change the outline thickness, the general appearance would slowly changing. The size of points influences on line thickness and, that way can be performed transition from one type of the shape to another. Moreover, changing colours of the outlines, we gain a lot of different variables. In art are used outlines as a dramaturgical element for psychological interpretation of pictorial subject.

We conclude that Gestalt theory has an strong influence on pictorial design, its dramaturgy of paintings composition and semantic dualism of colours and shapes.

Keywords: Gestalt theory, colour shape, outline thickness, compositional structure.

## 1. INTRODUCTION

*Gestalt* psychology confirms the conclusion that our mind tends to simplify visual perception of our environment in order to be perceived and understood faster and better. All complex forms in our environment we are trying to explain by more geometrically regular shapes, such as Triangle, Square or Circle etc. The simpler the form, the easier is to perceive and understand it. A Triangle and a Circle represent a fundamental opposites in design (Figure 1) and all shapes in between are just variable transformations of these two geometrical extremes (Ching 2007).

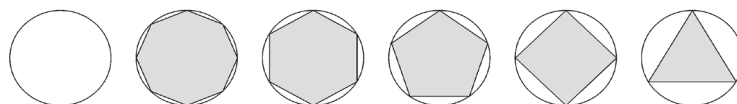

Figure 1: Drawings of two fundamental opposites: circle and triangle.

Each work of art and design necessarily contains a certain minimum number of layers as the essential basic structure. The primary structural layers are classified as follows:

1. Building blocks of first category are the colours, as a skin of anything visual.
2. Building blocks of second category are classified rows of dots which are manifested as the building blocks for all of the following categories (Figure 2).
3. Building blocks of third category are classified as genre lines (Figure 3).
4. Building blocks fourth category are classified as genre surfaces (Figure 4).

The definitions of Colours are not the subject here, but the components of colour sizes: Hue, Chroma and Lightness are obviously fundamental in practicing all of the following forms. Therefore, without their overarching vision and everything without them (and before), there is no other category of visualisation. However, for the colours themselves does not yet define absolutely nothing, except when carrying with them those basic ambivalent charges to sensory-emotional potential. These potentials are only expressed as formal formations in the form of achromatic or chromatic coloured elements: points, lines, surfaces, etc. Stacked in Fine-compositional formations and only in relation to each shape forming combinatorics of some importance.



Figure 2: dots as building blocks of second category could be different shapes, sizes, structures and shaped with hard or soft edges.

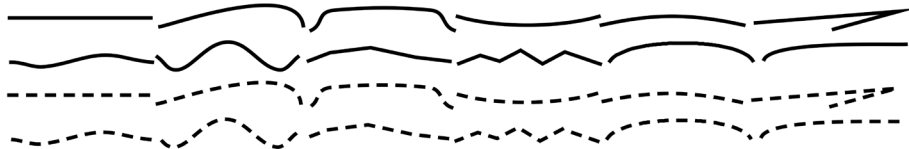

Figure 3: lines as building blocks of third category consist of different shape types, building structures with hard or soft edges, entirely dependent of the dot features.

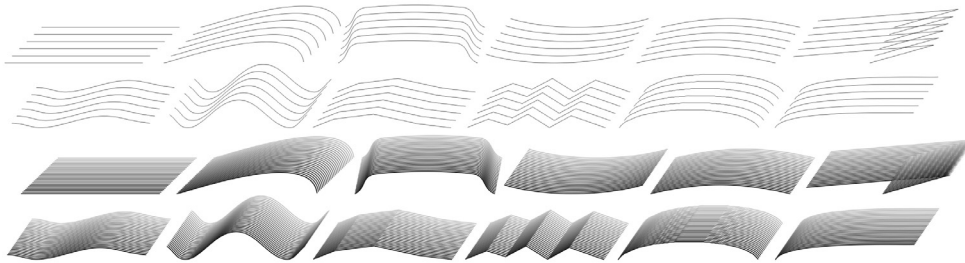

Figure 4: surfaces as building blocks of fourth category consist of different surface types, depend of the dot and line features.

The dots are crucial in defining features of the lines. The size of dots influences the outline thickness and, that way can be performed transition from one type of the shape to another: from the Triangle to the Circle (Figure 5)!



Figure 5: By changing outline thickness we can perform step by step transition from one type of the shape to an antagonistic one – from the Triangle to the Circle. In that process the dot's sizes are progressively growing, meanwhile the triangle sizes are gradually reducing.

Moreover, by changing colours of the outlines, we gain a lot of different variables, conditioned by colour features and attributes. In art the outlines are used as a dramaturgical element for psychological interpretation of pictorial subject.

But, how are the shapes described? The colours cover the entire surface of any shape, but at the same time the edges of the shape are defined by the outlines (Sivic 2008). And, if we change the outline thickness, the shape would also slowly change, and with this change the whole picture gain dramatically new visual results. Therefore, the outlines play the role of adjective in relationship to subject!

## 2. METHODS

### Abstract simplification

Impressionist Paul Cezanne simply interpreted his motifs using primary forms, such as a ball for rounded fruits, spruce as a cone, a building as block, etc. Abstraction uncovers the multitude of unimportant details, simplifying the whole design's complexities with even more simple primary form that extracts the essence of the basic forms of any subject or motif (Figure 6).

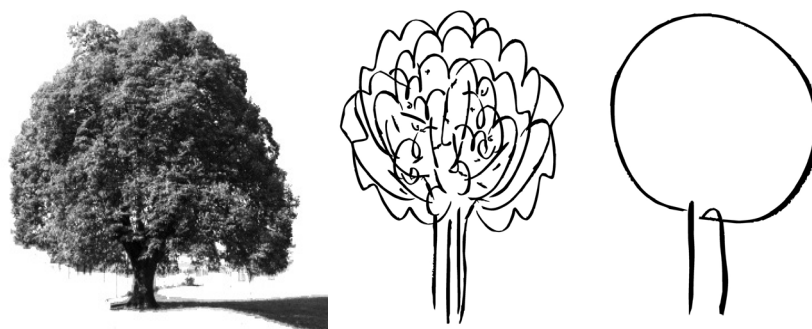

Figure 6: Tree with full details could be interpreted in geometrically simplified form.

## 3. RESULTS

### Influence of Gestalt classification on outline thickness

Gestalt logic decisively contributes to a more stringent definition of the content and brings order within the visual syntax with its evaluation of grading between types of partition lines. As dividing lines add adjectival properties to the present form (noun), it is therefore better to define it relationally.

The drawn wheels represents the true wheels metaphorically, the separating lines, on the one hand, by using thinly-structured elements, gives the 'appearance' of easy construction that could represent a lady's bicycle, whilst the use of bolder elements thus displaying a harder, more robust design, may correspond to a mountain bike (Figure 7). The graduated lines, visible due to the thicker lines separating these two cases, provide a decisive definition (distinction) between the light-hearted and bold. It is therefore a principle that is, in form and context, translatable within a number of other areas such as art, architecture, product design, etc (Figures 8 and 9).

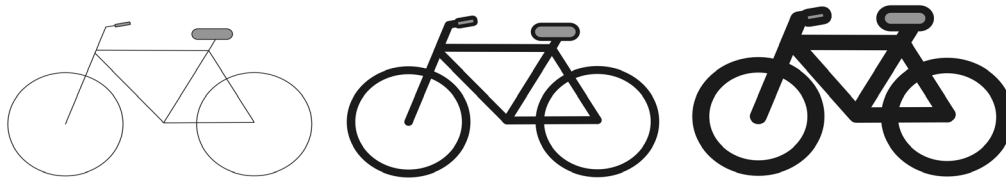

Figure 7: Drawings of exactly the same bicycle design, results with a thin line as a fine and feminine, meanwhile with the bold lines appears as robust, strong, tough, solid and manly. So, the line thickness plays the role of adjective.

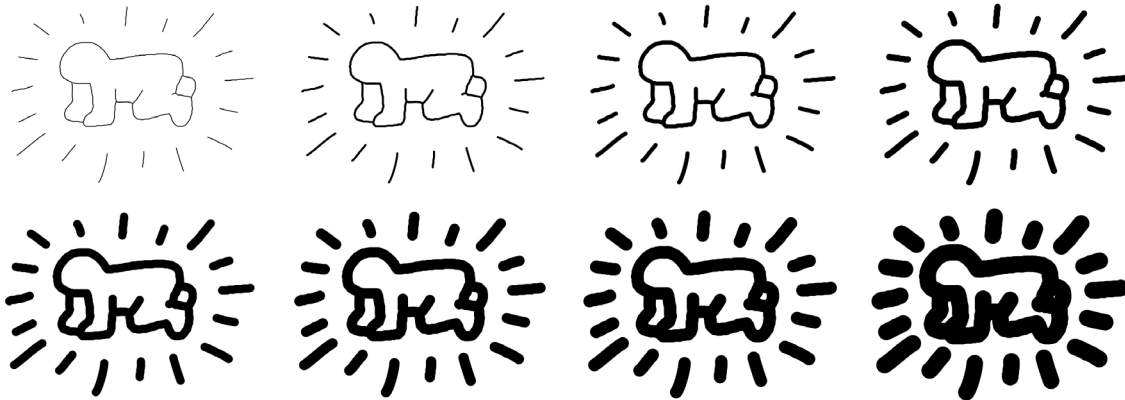

Figure 8: We were allowed to borrow an image of Keith Herrings to show a few results of outline thickness variations. The results show us the variety of different expressions from very light to very heavy. The basic drawing is the same in all examples, but the dot size which creates the drawing line.

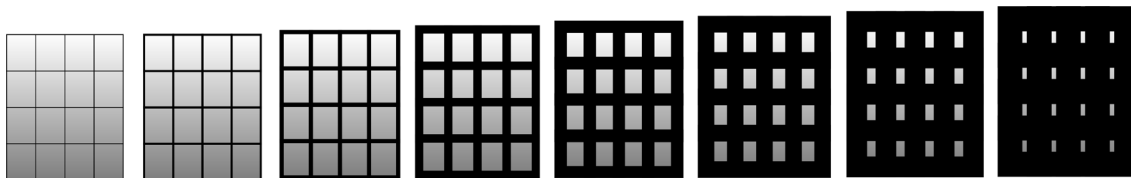

Figure 9: The illustration of simplified architectural facades presents the general principle and the effects, caused by the outlines of window frames.

## REFERENCES

- Ching, F.D., 2007. *Architecture – Form, Space, and Order*. Wiley, p. 38.
- Sivik, L., and A. Hård, 2008. *A Theory of Colors in Combination – A Descriptive Model Related to the NCS Color Order System*. Private correspondence with L. Sivik.

E-mail: vojko.pogacar@um.si

# Colour and the Lighting Application of Tomorrow

Monica SÄTER

Department of Architecture, Chalmers University of Technology

## ABSTRACT

To get more knowledge about the lighting design process a literature review was performed and common knowledge of lighting design was written down within a Thesis project and in a still unpublished post doc. project (Säter 2012). In this paper is the lighting design process (LDP) seen in relation to colours. To be able to handle colour for the indoor environment of tomorrow, it is important to picture the way the future lighting applications will be designed. As a result of the findings about melanopsin and the intrinsic photosensitive ganglion cell (ipRGC) the light of tomorrow will be designed more physiologically supportive by an increased use of daylight (Brainard et al. 2001). To be able to work in an efficient way, daylight needs to be combined with a complementary lighting application. This can be designed from a template and as a solitary technical application performed with no contact with the space or the user. But the complementary artificial lighting can also be designed in contact with the space and the user's senses, by the use of the four basic steps in the lighting design process.

**Keywords:** Colours and the lighting design process; Visual comfort.

## 1. INTRODUCTION

When investigating the lighting design process, colour is found being an important part of the process, related to visual comfort and to the four basic steps of lighting design. When staying in a paradigm shift in lighting related to an increased use of daylight and of a new type of energy efficient light sources, how to do a colour scheme for a specific space need to be re-evaluated. When the lighting application is designed in a way that emits light in a static way and the complementary lighting overrules the rhythm of daylight the work with the colour scheme can be done for a more or less static visual situation and with a spectral profile that is possible to evaluate in advance. The span of levels of light are in this situation narrow and the colours in the colour scheme need to be attractive, pleasant and visually comfortable in a very limited span of light and dominantly in the character of the light emitted from the light source in the complementary lighting. When designing a more physiologically supportive light based on daylight, the photon flow of daylight imprint the space the year around in a rhythm of light levels from high to low, in an ever changing light distribution, a constantly changing spectral composition and only with a small amount of complementary lighting used. In the more futuristic lighting might the character of the light sources used for complementary lighting be of two types that differs in light colours. Since the use of the complementary lighting is minor compared to the use of daylight the changing levels of daylight and the changing spectral profile from daylight is the complexity that the work with the colour scheme should handle at first. The design of colours should also handle the more cold and warm light-colour emitted from light sources that have a higher concentration in the short or the long wavelength area used for complementary lighting. In the work with the colours, the colours that should be chosen is the one that are attractive, pleasant and visual comfortable in both high and low levels of daylight at first and well functioning in the complementary artificial lighting as well. If the complementary lighting has two characters, the type used in the later part of the day should be in use as the type of light that the colour

should look attractive in because of the higher number of hours that lighting are needed when it is dark outside.

## 1.2 Research questions

In what way is the colour scheme related to the lighting design method?

## 2. METHODS

The way colour is related to the 4 steps of the lighting design process were evaluated within a Thesis project (Säter 2012) and in a still unpublished post doc. project. Common knowledge from lighting design was written down. Methods for lighting design developed within the education at Jonkoping University 1999-2011 were the main source of common knowledge.

## 3. RESULTS

The literature review shows that the European standard is said to give all normal sighted workers in Europe an experience of visual comfort (Säter 2012). Visual comfort is in a study performed at Jonkoping University (Säter 2011, 2012) shown being an almost unique experience. 314 of 318 subjects did unique combinations of the level of light at the worktable and for the ambient light, evaluated as the most visual comfortable. At the same time is shown that the individual preference for level of light evaluated as visual comfort is changing during the day. A reason to the differences in preferences for visual comfort is the physiological fact that the sensitivity into the central nervous system differs between subjects (Ingvar 1981). Colours are mentioned by Liljefors (1999) as changed in appearance related to the electromagnetic radiation present in the space and by transmission through, absorption into and reflection from the surfaces in the space. If the effect of transmission, absorption and reflection (TAR) is taken into accountancy in the work with the colour scheme and within the four steps of the lighting design process (LDP), the photon flows in the space will be dimensioned in a way that is suitable to give a beautiful appearance and a visual comfortable experience for the user with high sensitivity into the central nervous system. Colour is related to all four steps of the lighting design process. *In step one of the LDP* is the effect of daylight and the complementary lighting and TAR according to the colours in the space investigated in changing spectral profile of electromagnetic radiation (EMR) on the highest and lowest levels of light into the space. *In step two of the LDP* is the user's sensitivity (if known) and the levels of light that can appear during the year into the space, evaluated and related to colours on the surfaces and the view through the window. *In step three of the LDP* is the design of daylight and the choice of light sources in combination with the effect of TAR, setting the circumstances for the appearance of the colours in the space. The design of daylight and the complementary lighting need to be designed towards the colours and the sensitivity of the individual user in the channels in to the nervous system for the individual experience of looking at lit surfaces and contrasts to contribute to the experience of visual comfort. *In step four of the LDP* is the technique chosen that gives a well lit space and visually attractive colours despite the changes in spectral profile and level of light during the day.

## 4. CONCLUSIONS

The answer to the research question "In what way is the colour scheme related to the lighting design method?" can be concluded as colour is crucial for the work with lighting design

and related to the all four steps of the LDP. *In step one of the LDP*, colour is crucial since both daylight and the complementary lighting have by TAR an effect on the colours in a way that gives an visual experience of the lit surfaces related to level of light and contrasts that can be disturbing, pleasant or related to pain. *In the second step of the LDP* is colour again crucial since EMR from daylight and the complementary lighting, affect colour, by TAR, in a way that can be related to level of light and to contrasts going from disturbing, pleasant or related to pain. *In the third step of the LDP* is colour also crucial since the design of the amount of photons into the space is done towards the user's sensitivity to levels of light and to look at lit surfaces, contrasts and to the effect of colour and TAR that can give an experience of visual disturbance, pleasure or pain. *In the fourth step of the LDP* is the technical equipment for shadings of daylight and for the complementary lighting application chosen in a way that contribute to the experience of colours in the space being attractive and pleasant in both high and low levels of daylight and in the altered spectral profile of daylight during the day. Additionally is the technique chosen for the shadings of daylight and the complementary lighting and the altered spectral profile in daylight and lighting, in a way that gives visually attractive and pleasant colours into the space. When lighting is designed with only step four in the lighting design process and by the use of a template, the synchronisation of colour and light is not performed. The result from the literature study shows that the work with the colour scheme will be more complicated to handle in the future when daylight is used more as ambient light and when the complementary lighting is used with an altered spectral profile. Light sources that have a high concentration in the spectral profile within the short wavelength area differ in light colours compared to light sources that have a high concentration in the spectral profile within the long wavelength area. Visual comfort is in the same time found out in a study to be an almost unique and constantly changing experience and related to the sensitivity of the channels into the central nervous system. Colours are mentioned by Liljefors (1999) as affected by electromagnetic radiation in the space by transmission, absorption and reflection (TAR) towards the surfaces in the space. Colour is found related in a crucial way to all four steps of the LDP. If the relation of colour and daylight and colour and the complementary lighting is not analysed *in the first step of the LDP*, an important piece of information into the design process that gives visual comfort is missing. If the information about the relation of colour and daylight and colour and the complementary lighting collected in step one is not used *in the second step of the LDP* and related to the span of visual experiences going from unpleasant, pleasant and to pain for the individual user, an important piece of information that is needed to design light in a way that gives an experience of visual comfort for the individual user, is missing. If the information of colour and daylight and colour and the complementary lighting and the user's preferences collected in step one and two is not used *in the third step of the LDP* important information is missing that is needed when working with lighting design. Without this information is it hard to set the span of the highest acceptable level of light and the lowest level of light that is appropriate in the specific space and that gives visual comfort of the known or unknown users that stay or will stay in the space. If information of the relation of colour and daylight and colour and the complementary lighting, the users preferences and the design of daylight and the complementary lighting is not used *in the fourth step of the LDP* important pieces of information is missing in the work with the choice of the appropriate technique that finally set the span of levels of daylight by the use of shadings of the daylight and by the use of a complementary lighting. As shown in the study colour is crucial in the work with the LDP. Without designing a by TAR well-functioning relation between colour and light in high and low levels of daylight and in high and low levels of the complementary lighting, the lit environment risk to be unattractive and visually uncomfortable for the user. It is an important

issue for the future to develop a colour scheme that handle daylight on extreme high and low levels in a way that gives both normal sighted and visually impaired an experience of visual comfort and a visually attractive environment and in the same way a safe visual orientation.

### ACKNOWLEDGMENTS

Lena Gustafson, Head of the Bertil and Britt Svenssons foundation for lighting technique is acknowledged for a foresighted support of education and research in lighting science.

### REFERENCES

- Brainard, G.C., J.P. Hanifin, M.J. Greeson, B. Byrne, G. Glickman, E. Gerner and M.D. Rollag, 2001. Action spectrum for Melatonin Regulation in Humans: evidence for a Novel Circadian Photoreceptor. *The Journal of Neuroscience* 15 August, 2001, 21(16): 6405-6412
- Ingvar, D., 1981. *Icke visuella effekter av optisk strålning*. Miljöpsykologiska monografier Nr. 2 1982.
- Säter, M., 2011. Preferences for level of light at the work table and for the complementary ambient light. *CIE proceedings. 27th session the CIE South Africa* 10-15 July 2011.
- Säter, M., 2012. *Equilibrium, user centres lighting design. Towards the development of a lighting design that is individually psychologically, physiologically and visually supportive*. Chalmers University of Technology 2012.
- Liljefors, A., 1999. *Lighting, visual and physically. V/P Lighting theory, basic lighting knowledge*. School of Architecture. KTH. Revised 2005.

*Address: Department of Architecture, Chalmers University of Technology, Gothenburg  
E-mail: sater@chalmers.se*



# Palettes of Divine Light

Gérson JUNIOR,<sup>1</sup> Sílvia PINTO<sup>2</sup>

<sup>1</sup> Faculdade de Letras, Universidade de Lisboa

<sup>2</sup> Departamento de Ciências da Comunicação, Universidade do Minho

## ABSTRACT

Nowadays we know that light and colour are perceived optically but its meaning is fundamentally anthropological (Pastoureau 1997). Since time immemorial, art bears witness to and records the light as a metaphor of transcendence. In the beginning of semiotics of light, God is the Light. Therefore, a question is imposed on us: “What is the colour of divine light” (Reutersward, 1971) or, in other words, how has the history of representation made “visible the invisible”? (Kessler 2000).

With this study we aim to show an overview of the evolution of divine colour representation, from proto-history to Baroque – periods among which one can speak of a conception of light and colour inseparable from manifestations of the sacred or devotional practice.

We hope, at the end of this brief journey, to be able to verify if in the course of the history of sacred art there are recurrent palettes of divine light, identify them and present plausible hypotheses of explanation of these tendencies, thereby contributing to the historiography of colour representation, specific to devotional art.

## 1. INTRODUCTION

From the limits of visual field, Wittgenstein (1977) postulates a theory of colour in which any approach based on purely physical or psychological aspects are categorically rejected, thus broadening the cognitive variables of the phenomenon of vision and recovering, at the same time, the ancient metaphysical tradition of colour. Indeed, since time immemorial, art bears witness to and records the light as a metaphor of transcendence. In the beginning of semiotics of light, God is the Light. Therefore, a question is imposed on us: “What is the colour of divine light” (Reutersward, 1971) or, in other words, how has the history of representation made “visible the invisible”? (Kessler 2000).

Although painters were aware of the inherent paradox related to the problem of representation of divine light, the search for solutions proceed uninterruptedly until the end of the seventeenth century.

## 2. METHOD

The methodology combines the use of complementary references with semiotic analysis of a sample of paradigmatic pictures of the subject matter, relating different moments of the conception of divine light with different colour options.

### 2.1 Sample Preparation

Gold seems to have been the first material and colour to signify what is divine. Often, it is more difficult to determine whether gold is presented as divine light, divine fire or a halo of sanctity, whose appearance goes back to the time of Homer, according to Reutersward (1971: 112), implying both cases. However, the first colour in the historical development of

mankind seems to have been red. Early in the history of Western colour, which goes back to proto-history, any colour was built around only three poles: white, red and black (Pastoureau 1997: 13), which can be seen from cave paintings of Altamira to Greek vases of Egyptian school. Red, the first of all colours, means in several languages “colourful” and in Sanskrit means “light”.

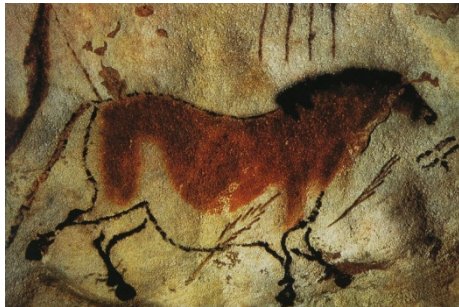

Figure 1: Bison, Altamira, 15.000-10.000 B.C.



Figure 2: Egyptian Tomb



Figure 3: Greek Vase

Thanks to Roman art innovations and its materiality, the architectural space acquires amplitude, starting to be laboured as a great light-space effect. On the other hand, changes in brightness have been, since long ago, a call to worship and praise. Enter into a cathedral on a sunny day can cause a confused feeling as if we were entering a sublime darkness, after which the desired light crosses the figurations of the multicoloured glass and colour is projected, like a shower from heaven, throughout the church. Here, colour is not an accident, but the very substance of the artwork. The Christian basilica and the Gothic cathedral are both designed according to the same biblical model of the Heavenly Jerusalem, as an *imago mundi* – in the sense attributed by Mircea Eliade<sup>1</sup>, as divine work and “holy” place, in other words, “separate” to communicate with God.



Figure 4: Panteon of Rome, 27 B.C - 125 A.C.

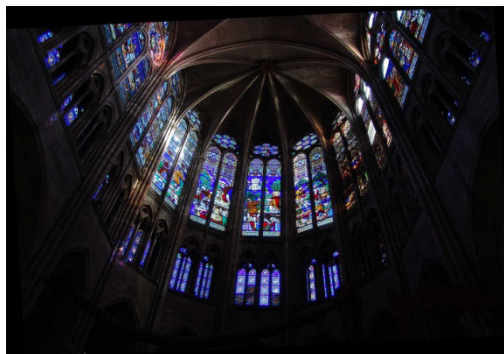

Figure 5: Basilica of Saint-Denis, XII century

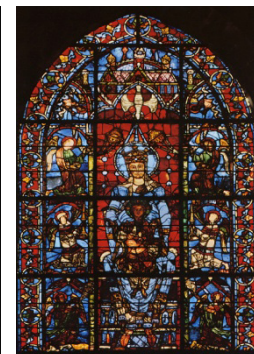

Figure 6: Chartres Cathedral, XII century

1 According to Mircea Eliade’s approval “home / body / cosmos”, an *imago mundi* can be an enclosed space, a city (Jerusalem) or a region (Palestine), since the following conditions are fulfilled: the place must be sacred / separated by a rupture in the homogeneity of space; this rupture should be symbolized by a communicating opening between two spiritual realms (heaven and earth); communication with the divine space is has to be expressed through images, such as columns, stairs, trees, mountains or light; any *imago mundi* extends around the connecting axis with the divine space (Eliade, 1999: 55-78).

In the fifteenth century, a system of triptychs was created in the Netherlands. Its exterior was kept gray scale monochrome to contrast with the brightness of gold and colour that triptychs exhibited when they were open on Sundays and feast days. This device, which made implicit that the light of the church should be secondary to the altar, seems to indicate that the church ceased to occupy that picture of the sky/heaven (the same word in Portuguese) that had been previously, and that the divine realm was now confined to the altar. There, the most *nobilitais* materials, including precious paint colours, would star that sense of extraordinary that was previously evoked throughout the building.



Figure 7: Jan van Eyck, *Triptych Madonna on the Throne*, 1437



Figure 8: Jan van Eyck, *Madonna of Chancellor Rolin*, 1441

It is with oil painting that brightness appears in painting throughout transparent colour, an extraordinary instrument of splendour and light that will transform painting into a bright object. What is improperly called the discovery of oil painting is, first of all, the transposition of the precious quality of medieval art to another matter, richer and deeper than gold, and above all, widest. The systematic use of this process is due to the Van Eyck Flemish workshops. Through transparency, Van Eyck deepens the space, opening a new era of truth that realism itself does not define (Focilon 1993: 331).



Figure 9: Giorgione, *The Three Ages of Man*, 1519.



Figure 10: Caravaggio, *The Denial of Peter*, 1610.



Figure 11: Rembrandt, *The Prophetess Anna*, 1630.

Michelangelo Merisi da Caravaggio turns into a stylistic value the naturalistic suggestions of Venetian and Lombard painters of the sixteenth century. Eliminating the perspective, he reduces all the elements to light grazing plans, reaching the bodies with a scenic violence from which emerges a new sense for painting, built by a new realism that will make vain the scale of the subjects. The simplicity of his painting is due to the renunciation of the environment but also to the courage to wear the biblical subjects with Roman costumes of the time, giving them the modern customs of everyday life, an updated view of the Gospel. Light and colour so conceived result in a much more realistic effect than universal diffuse light of the Renaissance, allowing the painter to illuminate just what understand to emphasize.

In Rembrandt, objects and subjects receive the light as the impact of an external force, becoming themselves powerful light sources. Once illuminated, the spectacle of light and shadow is once again an authentic revelation (Arnheim, 1991: 314).

### 3. RESULTS AND DISCUSSION

The trilogy of the first colours in the development of mankind - the red-black-white - was used in prehistory magical rites, in Egyptian tombs and Greek painting. Later on, the relationship with the transcendent space became an attempt to reproduce a space itself, whose light was bright, transparent and filtered by the six colours used in the middle ages (blue, green, yellow and the three previous colours), creating a sort of colourful penumbra.

According Reutersward (1971: 106-108), during the fifteenth century, the warm light of the stained glass was becoming increasingly cold, until there was no large difference in brightness between inside and outside of the buildings, and the interior of the churches become almost white. However, ending the Renaissance, the sublime obscurity achieved in Gothic cathedrals pursues its process of darkening up to the “painting of darkness” of Caravaggio.

### 4. CONCLUSIONS

We know that the brightness of the darkest objects appear when they are placed in an environment even darker, surpassing the average brightness level of the perceptual field. The brightness stands out even more when you do not realize the light as a lighting effect and when the shadows and texture of surfaces are minimized. Through these pictorial devices, Caravaggio and his followers, transferring the divine light into a dark land, visually perform the central mystery of the Gospel and light men with its presence.

### REFERENCES

- Arnheim, R., 1954/1991. *Arte e Percepção Visual. Uma Psicologia da Visão Criadora*. São Paulo: Livraria Pioneira.
- Eliade, M., 1956/1999. *O Sagrado e o Profano. A Essência das Religiões*, Lisboa: Edição Livros do Brasil.
- Focilon, H., 1938/1993. *Arte do Ocidente. A Idade Média Românica e Gótica*, Lisboa: Editorial Estampa.
- Kessler, H., 2000. *Spiritual Seeing. Picturing God's Invisibility in Medieval Art*, Philadelphia: University of Pennsylvania Press.
- Pastoreau, M., 1997. *Dicionário das cores do nosso tempo*, Lisboa: Editorial Estampa.
- Reutersward, P., 1971. “What Color is Divine Light”, Ashbery, J. – Hiess, T. B. 1971. *Light in Art*, New York: Collier Books, p. 101-124.
- Wittgenstein, L., 1977. *Bemerkungen über die Farben / Remarks on Colour*, ed. de G. E. M. Anscombe, Oxford, Basil Blackwell.

*Address: Sílvia Pinto, PhD student in Social Semiotics – Department of Communication Sciences, Universidade do Minho, Campus do Gualtar, 4710-057 Braga – Portugal*  
*E-mails: silvia.pinto.07@gmail.com; gjkoine@yahoo.com.br*

# Color in Art and Design: Painting “Eco-Friendly Hand Painted Silks”

Sandhya RAVI  
KLE Fashion Technology and Apparel Institute

## ABSTRACT

The growing concerns about environmental issues are playing an increasingly important role in the textile industry. The use of eco-friendly dyes as one of the means to create hand painted silks to protect the environment. The study aims at painting silks with eco-friendly dyes with different solvents/buffers with limitless variety of exciting designs. The techniques used here are easy, simple and can be finished at home which do not cause harm to the environment and ecology. While hand painting silks care was taken to convert the dyes into paints which were not carcinogenic. The objective was to study the effects of different solvents/buffer medium with eco friendly dyes, its visual effect on the fabric. The consumer acceptance was carried out through a survey, the tool being questionnaire. 14 samples were hand painted with different techniques and were tested for colour fastness to washing, rubbing (dry and wet), sunlight and perspiration. Under privileged women were trained and it was found that the method was easy and they could earn a living to support their family. These hand painted eco-friendly products with sustainable designs have created awareness among people to protect the environment. This led to the principle of REDUCE-REUSE-RECYCLE. Eco-Fashion is not a FAD anymore.

## 1. INTRODUCTION

It is well known and perfectly understood that the environment is the basis of life and also the economy. The threat to the environment using chemical dyes has led to stressing need for eco-friendly dyes. It is interesting to note that India is one of the few civilizations to perfect the hand crafted art on cloth. Ecofriendly dyes have a revival due to increasing interest manifested in protecting the environment from the toxic effluents resulting from the unbridled use of synthetic dyes. Designs are painted using eco friendly dyes to add beauty, interest and create eco awareness. Hand painting on silk is an extremely popular art form in India and one can find a wide range of beautiful and exciting design.

The use of ecofriendly dyes for coloration of textiles has mainly been confined to craft dyers and printers. However, recently more interest is being shown in the use of these dyes and a limited number of commercial dyers are using it for dyeing and printing of textiles. The present study focuses on empowering under privileged women by training them to develop the designs that are sustainable using ecofriendly dyes with different hand painting techniques on silk fabrics.

## 2. METHOD

The fabrics were prepared for painting by pinning the fabric to the frame and then the developed designs were transferred on the fabric to be painted through tracing technique for specific designs and free hand drawing was undertaken for water technique. Once the design was traced on the fabric the fabric was ready for painting. In Gutta technique the water based resist is used to restrict the dye from moving out of the design. In the salt and water

technique the colour is painted directly on the fabric. The painted samples were tested for various colour fastness properties.

### Gutta Technique

This is known as serti or resists technique. It involves drawing fine lines of gutta on the silk to outline the design the lines stop the dyes from spreading into each other. The liquid dyes are then painted directly onto the silk and fixed into the fabric.

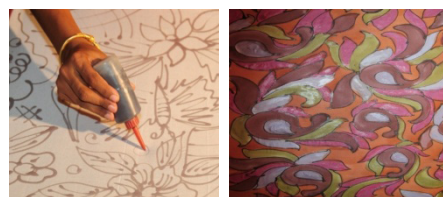

*before*

*after*

### Water Technique

Water colour is an exciting medium to use on silk as it allows a very free approach. This technique involves painting directly on the stretched silk using ordinary tap water and dyes. Water colour reacts very differently on various silk; the dyes spread across the fibers very quickly and merge into each other. The dye will still retain a soft outline, but will not spread as far, so that greater definition can be achieved in this technique.

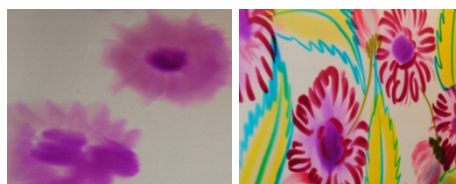

*before*

*after*

### Salt Technique

In this technique the dye colour is painted and when the surface is wet the salt crystals is sprinkled which will absorb the dye and create an effect which is beautiful. The salt will be removed after the paint is dry.

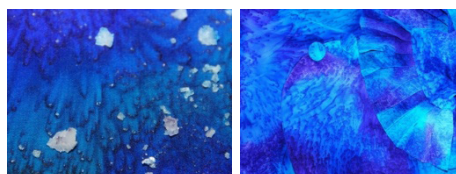

*before*

*after*

### Sugar Technique

In this technique the dye colour is painted and when the surface is wet the sugar crystals is added which will absorb the dye and create an effect which is beautiful. The sugar will be brushed out from the surface of the fabric after the paint is dry.

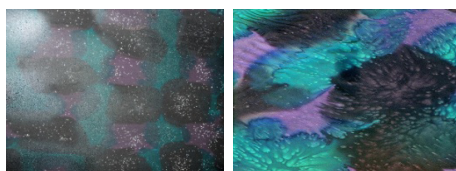

*before*

*after*

### Urea Technique

In this technique the dye colour is painted on the fabric and when the surface is wet the urea crystals is sprinkled which will absorb the dye and create a 3D effect which is beautiful. The urea crystals act on fabric by absorbing the moisture and helps in fixing of the colour on the fabric. Later the crystals are removed from the surface of the fabric after the fabric is dry.

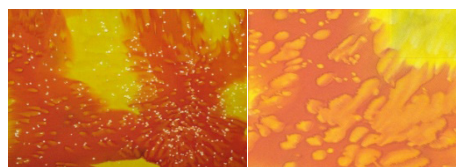

*before*

*after*

### Alcohol Technique

In this technique the samples were painted with dyes converted into paints and when the painted sample was dry ethyl alcohol was added in the form of drop-lets at regular intervals. The effect of ethyl alcohol gives a 3-D effect to the design which gives an embossed effect due to merging of colours painted.



*before*

*after*

**Innovative Technique - Batik with Painting**

In this technique the fabric is first painted with wax which is a mixture of (Paraffin wax and Bee wax) and then the fabric is cracked after which the fabric is immersed in dye solution and the wax is removed through hot water technique. The fabric is ironed to remove the wax completely. The fabric is dried and then the designs are painted which add beauty and uniqueness to the fabric and improves its aesthetic appeal.



*before*

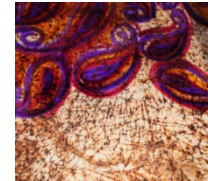

*after*

**Fixing of Colour to the Fabric**

The hand painted fabric produced from the above techniques was subjected to steaming in order to fix the painted colours to the fabrics. The hand painted fabrics with colour can be fixed in a pressure cooker or in a digitized conditioning oven.

*Table 3.1: Colour Fastness to Sunlight and Rubbing Fastness*

WOMEN TRAINED	ALCOHOL TECHNIQUE	GUTTA TECHNIQUE	SALT TECHNIQUE	SUGAR TECHNIQUE	UREA TECHNIQUE	WATER TECHNIQUE	BATIK TECHNIQUE
1	5	5	5	4	4	5	3
2	4	5	4	5	4	4	2
3	5	5	4	5	5	5	2
4	5	4	5	5	5	5	1
5	5	5	5	4	5	5	2

*Table 3.2: Ratings by Women Trainees*

PAINTING TECHNIQUES	GRADING	GRADING		VALUE SCALE MAX
		WET	DRY	
Alcohol	4/5	4	5	5
Gutta	4	4	4	5
Salt	4	4	4	5
Sugar	3/4	4	5	5
Urea	4	5	5	5
Water	4	4	5	5
Batik	4	4/5	5	5

**3. RESULTS AND DISCUSSION**

The samples were tested using an exposure rack under bright sunlight for 6 hrs per day for seven days. There was no significance change in color due to sunlight except for sugar technique. All the samples had Very good rating with value of 4 on a value scale of 5. The samples were test for colorfastness to rubbing in dry and wet conditions on a crock meter. The samples showed very good rating with a value of 4 on a rating scale of 5

The women trainees were split in 5 batches with 5 women trainees in each batch for convenience in training them. They were taught the Hand painting techniques and they were of the opinion that the innovative technique with Batik was the most difficult to understand and they could not easily adapt to that technique, where as all other techniques were easy to understand and learn and implement. They felt that the Gutta, salt, sugar, urea and water technique were the easiest and they could create samples all by themselves without any problem.

#### 4. CONCLUSIONS

This study was undertaken to find out the effects of techniques of painting silks with Eco-Friendly dyes with different buffer solutions. Samples were painted with different techniques and colours were tested for colour fastness to washing, rubbing (Dry & Wet), perspiration and sunlight. The Rating of Very Good (4) was obtained for all the samples tested. 75% of the respondents were glad to know that importance was given to protect the environment by using eco-friendly dyes which produced beautiful products through different techniques of hand painting.

Also due to the fact that they were painted with eco-friendly dyes which were harmless to the environment and ecology which made them feel one among a few thousands who care for mother nature and want to save nature and the beautiful world for future generation. The training provided to the rural women was well accepted and appreciated by them. Since women are very creative, they could understand the techniques easily and found that all the techniques were very interesting with the gutta technique being the best. At the end of the day they felt they can manage by themselves and this could be a good prospect for self-employment. This can be a prospective small scale industry with good export potential. Further it gives employment with minimum training.

**REDUCE-REUSE-RECYCLE** is the buzz word to protect and sustain the environment.

#### REFERENCES

- Tuckman, D., and J. Janas, *The complete book of Silk painting*, North light Books F and W Publication.
- Goldstein and Goldstein, *Art in Every day life*, Macmillan Company, New York.
- Kennedy, J., and J. Varrall, *Silk painting New ideas and Textures*, B.T. Bats ford Ltd, London.
- Wild goose, *Step by step Art School painting on Silk*. Hamlyn, London
- Hayes, C., *The complete guide to painting and drawing*, Phaidon press ltd, New York.
- Hahn, S., *The Complete Guide to Silk Painting*, Search Press, Kent.
- Paine, M., *Fabric Magic*, Windword Frances Lincoln, London.
- Dawson, P., *The art of painting silks*, Search press, Kent.
- Ball, K., and V. Jacinth, *Hand Painted Textiles for the Home*, A David and Charles Craft Book, London.
- Stokoe, S., *Fabric to Dye for*, Southwater, London.
- Pinnell, J., *Take Silk*, Sally Milner Publishing, Australia.
- Stokoe, S., *Silk Painting & batik*, Southwater, London.
- Das, S., Application of natural dyes on silk, *Colourage*.
- Gogor, A., et al, Natural dyes and Silk, *The Indian Textile Journal*.

*Address: Prof. Sandhya Ravi, Research Scholar  
KLE's Fashion Technology and Apparel Institute, II block, Rajajinagar, Bangalore-10*



# The Transposition from Colour to Volume by means of Digital Fabrication: Op Art Case Study

Juliana Harrison HENNO,<sup>1</sup> Monica TAVARES,<sup>1</sup> Henrique STABILE<sup>2</sup>

<sup>1</sup> School of Communication and Arts, University of São Paulo

<sup>2</sup> Architecture and Urbanism College, University of São Paulo

## ABSTRACT

This article is about the transposition of digital images by means of automated production, using the immaterial quality of colour from a light source as a parameter for recoding. In order to understand how the contemporary processes of digital fabrication can enable the conversion into a physical and three-dimensional image, some artworks by Vasarely were chosen, as their colour is a determining factor for obtaining volumetry. In Vasarely's artworks, the form-and-colour combination results from abstract compositions of serial and dynamic patterns, and it causes a multidimensional illusion in the human visual perception. The investigative approach will take into account how the concepts of colour definition can be converted into three-dimensional form. It will also identify the steps of the creative process and the heuristic methods adopted, which are seen as the creative routes for planning and accomplishing the discussed artworks. Moreover, the analysis will highlight how the dialectic between the immaterial versus the material is developed. Both of them determine new ways of creation. Thus, we start from the assumption that the artist who can use CAD / CAM technologies can also access tools that allow him to overcome limitations in his artistic and poetic propositions.

## 1. INTRODUCTION

The automated production, technique that refers to prototyping and digital fabrication, is originally applied in areas such as mechanical engineering and product design, due to its industrial purposes. However, over the past few years, this type of production has been a fertile ground explored by architects and, most notably, by artists. Although its usage is still incipient in both areas, it has been gaining followers as this technology has becoming more accessible in universities' laboratories and print bureaus.

Regarding the field of visual arts, the automated production has been outstanding due to the increase of artist's creative potential, ensuring new approaches in terms of the technical procedures to fabricate objects. By a numerical simulation of the object's geometrical structure, it becomes possible to represent it both "physically" and three-dimensionally. When using such procedure, the artist experiments a new representation technique, based on numeric models that allow the transposition of the paradigm originally conceived on a three-dimensional physical model. Nevertheless, due to automated production procedures' high complexity, it is expected the artist to be familiar with both virtual and numerical universes, as to make viable recoding and transposing of existing medias in the process. Therefore, the use of automated production in arts creates new possibilities of representation, making possible the physical execution of complex forms not before enforceable by manual methods.

## 2. OP ART CASE STUDY

In order to understand this scenario, three artistic experimentations that were made based on the use of digital fabrication<sup>1</sup>, will be analysed in this case study. By means of data transduction from an original artwork, new media approaches has been generated by the transposition occurred during the process, taking into account the variation of colour from a light source as a translation parameter.

Three artworks by Victor Vasarely were chosen: *Vonal Alto* (1969), *Cheyt Pyr* (1970-71), *Enigma 5* (1974). The above mentioned artist is one of the main references of the 60's artistic movement known as *Optical Art*, or *Op Art*. His artworks suggest movement, resulted from the optical ilusion effects. Such poetic intended to turn the artwork receptor/spectator into a active participant, thus widening possibilities of engagement with the piece. The artist conducted a serie of colour experiments when studying movement and perception.

Even though in a two-dimensional conception, Vasarely's artwork herein analysed seems to gain volume by the use of colour contrast and tone colour schemes expressed in the piece. The optical effects that suggests the three-dimensional visualization result from the way the artist were used to dealing the relations between colour and form. In the case studies to be presented, we intended to translate into volume the chromatic data from three different artworks by the artist, and such information was retrieved from the digitization of Vassarely's original drawings.

To better understand how the numerical simulation of an object's geometric structure can enable its "physical" and three-dimensional representation, we will base our research on three artistic experiments that highlight the changes caused by the introduction of the automated production methods in the context of Visual Arts. The recordings happened through the use of parametric design and interaction processes, obtained with the help of 3D and generative softwares. The foundation of re-reading is sustained in the recoding of information from the RGB channels of the digitized artworks, so as to obtain volume that can be produced through the digital fabrication subtractive process<sup>2</sup>. Although it sounds like a paradox, we can admit that this process gives materiality to the immaterial; in short, it increases the possibilities of visualization in view of the potential of digital media.

The process to re-read the digitized artworks by Vasarely was started in the Rhinoceros software, along with the Grasshopper plugin. From there, it was possible to establish parameters to reinterpret the original artwork taking into account the RGB channels of the digitized work. The steps below were common to the three recoding processes for the three images: the reparametrization of a plan; the division of this plan into points, and, consequently, the simulation of sculptural forms taking the RGB channel filter as a conversion parameter. For each of the three images, we used the image sampler<sup>3</sup> component of Grasshopper, which enables the reading of information from the image's colour channels.

After the creation of the parametric modelling pieces, we used the subtractive process

1 This work was only possible due to the cooperation with the Laboratory of Models and Assays of FAUUSP and the Fab Lab São Paulo, which provided the space, technical support and machines for execution of the works.

2 We can categorize digital fabrication based on the way objects are produced. And, in this sense, we can admit three types of processes: subtractive (thinning of material), additive (addition of material) and formative (deformation of material).

3 According to the help menu of the component, the image sampler allows for evaluation of pixel data stored in image files. By default, the image sampler is updated whenever the base image changes, so it is not necessary to retake all steps of parametrization upon loading the other two images.

to thin them through a CNC<sup>4</sup> milling machine, and as raw materials the MDF (Valchromat) plates superposed. At the end of the process, three plates were fabricated, each one representing a reinterpretation, a recoding of a painting by Vasarely. In sum, these artistic experiments were generated from the numerical simulation of the geometric structure of the *Op Art* pieces, transposed to a three-dimensional support.

By associating the numerical simulation processes to methods of prototyping and digital fabrication, we enable the representation of complex data, given the accuracy involved in the media transpositions process. Not only was it possible to model complex elements, whose manual construction would be unfeasible, but their exact physical representation also became conceivable. According to Pupo (2009:5), the complexity reached by digital models is owed to the “three-dimensional software based on Non-Uniform Rational B-Splines (NURBS), which offer parametric surfaces and curves” necessary to the development of difficult forms.

For each of the experiments conducted, the proposed poetic guideline was the recoding of Vassarely’s artworks having as parameter the intensity variations of each colour channel as the foundation to obtain the three-dimensional representation. The potentials of digital media have allied to creative intentions as a way to get to new inventions. The translations made presented a path that goes from colour to volume, from two to three dimensions, from numeric to analogue. The results generated portray ways of creating, moulded by the intention of the authors, but which at the same time are amplified by the programming logics of the computer.

This machine behaviour of analyzing the cultural world extracting “analogue models” and turning them into “operatory” is configured as “cybernetic”, and this is a heuristic creation method which, according to Plaza and Tavares (1998:93), is based on the “synergy of functions between [man and machine]”. This artistic experiments also presents characteristics of the heuristic project method, by assuming as operative direction the obtainment of pre-established steps, but which are necessarily reviewed on the basis of the materialities of the media used. Once creating based on projects “happenings are generated through structures”, the material potentialities of the new media “install qualitative and orderly structures that enable the construction of the mental insight”. Another heuristic method present in the creative path of artistic experimentation is the recoding method. In this case, the analogy reasoning led the artists to rework the poetic effects of Vassarely’s pieces, so as to extract from them new points of views, using digital fabrication to that end. This second degree creation starts from a situation and restructures it “according to other symbols, integrated in a different order, evidencing other connections”. This representation of the representation results in a “method of creation from other signs”, giving rise, according to Plaza (1987: 40), to virtual qualities, appearances that never happened before.

As refers to the material x (i)mmaterial dialectics, the interfaces used by the artists establish themselves as operators of contact and translation, allowing possibilities of articulation between the analogue and digital universes. By resulting from the translation between codes, the printed physical model stresses the expressive and synesthetic character embedded into artists’ proposals. As we know, based on Tavares (2001:129-130), it is the transformation between immaterial and material, performed by transducer devices, which ensures that the image is updated under different configurations, from the transit between softcopy and hardcopy. The objects resulting from the recoding derive from the numerical simulation of geometric structures generated from the transcoding of the RGB channels values in Vassarely’s

4 The numeric control milling machine used thins a material in the X, Y and Z axes.

artworks, and such structures gain a physical appearance with the help of digital fabrication equipment that reproduce digital into physical material.

### 3. CONCLUSIONS

The intention to use computer as a metamedium to process the data from a digital image, and then proposing parameters for the development of syntactic rules for the construction of three-dimensional forms is the poetic guideline that sustains the artists proposal. The digital image was manipulated so as to use its light source colour values as the means to create volumetry. The colour turned to be evaluated in a way detached from its original constitution and materiality. The subsequent fabrication of the pieces with the help of the numerical control milling machine enabled to physically materialize the object, bringing it to appearance through the recoding of the digital parameters of colour as a light source into volume.

From the translation of analogue into digital and vice-versa, the artistic object could be replicated, recreated and moulded. What we realized from this case study investigated was the possibility of using an automated production method as a creative enhancer in the search for new forms of expression. Methods originally conceived for industrial production purposes are now used for a new language of artistic and innovative character. The possibility of modifying the machine programming and then reaching new results that achieve customization, not only serial production, results in creative gains for the arts. The artist uses automated production technology in favour of gains in his creative potential.

### REFERENCES

- Plaza, J. and M. Tavares 1998. *Processos Criativos com os Meios Eletrônicos: Poéticas Digitais*. São Paulo: Editora Hucitec.
- Plaza, J. 1987. *Tradução Intersemiótica*. São Paulo: Perspectiva.
- Pupo, R. 2009. *Inserção da Prototipagem e Fabricação Digitais no processo de projeto: um novo desafio para o ensino da arquitetura*, Campinas: FEC. Doctoral thesis available online, <http://cutter.unicamp.br/document/?code=000442574>.
- Tavares, M.B.S. 2000. *A recepção no contexto das poéticas interativas*. São Paulo: ECA/USP. Printed version available at the ECA-USP library.
- Vasarely, V. 1973. *Victor Vasarely: Planetary Folklore*. München: Bruckmann.

*Address: Juliana Harrison Henno, Department of Visual Arts (CAP),  
School of Communication and Arts, University of São Paulo,  
Av. Prof. Lúcio Martins Rodrigues, 443, Cidade Universitária, São Paulo, Brazil  
E-mails: julianaharrison@usp.br, mbstavares@usp.br, henristabile@gmail.com*

# Fiction Book Cover Colour Analysis

Francis WILD,<sup>1,2</sup> Clyde WILD,<sup>3</sup> Charles HACKER<sup>4</sup>

<sup>1</sup> School of Information and Communication Technology, Griffith University

<sup>2</sup> Queensland College of Art, Griffith University

<sup>3</sup> Environmental Futures Centre, Griffith University

<sup>4</sup> Griffith School of Engineering, Griffith University

## ABSTRACT

This study investigated whether a particular palette of colours is used by graphic designers for fiction book covers in the Romance, Science Fiction, and Mystery/Thriller genres.

The results show that in the Romance genre the predominant cover colours were skin tone (43%), peach (20%), brown/black (18%), and mid red/brown (10%). In the Science Fiction genre there were five predominant colours: almost black (35%), light off-pink (20%), mid-off grey (15%), light grey blue (15%), and mid brown/orange (10%). The Mystery/Thriller genre covers had four predominant colours: skin tone (40%), almost black (20%), mushroom (10%), and mid grey (10%). Overall, for all genres, the statistical analysis revealed that there were numerous significant differences between the genres for these predominant colours and that the predominant colours included both the low and high lightness colours, but very few high saturation colours.

## 1. INTRODUCTION

Colour is all around us, we see it all the time. It affects us continually; we are surrounded by it every waking moment. According to Beer (1992, cited in Mahnke 1996), once you encounter colour you cannot remain neutral about it. For this reason our reaction to, or interaction with, colour seems to be immediate, instinctive and emotional. Thus, it appears that, as soon as we perceive colour, it evokes a response, of sympathy or antipathy, pleasure or disapproval. It is the catalyst for feelings, moulding moods and enhancing our lives (Pressman 2009).

People recognise and react to colour from a very early age and in many settings. We make associations with certain colours that stay with us through our whole lives. Consequently, colours can have a variety of meanings and can be linked to different emotions (Bhaskaran 2006). Colour is, therefore, one of the most important tools a graphic designer has when creating a book cover. For this reason, colours can convey a myriad of emotions and feelings, which instantly capture attention or give out a warning.

The cover of a book serves two roles: to protect the inside pages, and to indicate the content. It is like a miniature poster, a promise made by a publisher on behalf of an author to a reader (Haslam 2006). Despite the old adage “never judge a book by its cover”, Bhaskaran (2006) argues that, when it comes to publication design, first impressions last. Indeed, whether on an online bookshop or library shelf, the cover is the first thing you see. Importantly, the cover may entice you to open the book or walk away. Thus, after scanning the shelves or the screen for a few seconds, if nothing takes the reader’s fancy, they tend to move away. For designers, authors and publishers those seconds are crucial; they provide the one opportunity to sell the work to a reader.

Importantly, a well-designed cover is not just about the book being attractive; it must also communicate, clearly and succinctly, what the book is about. Therefore, designers do not just use fancy fonts and complex layouts, they also design book covers to attract, inform and win over the potential buyer or reader (Bhaskaran 2006).

In *The Digital Designer*, Pite (2003) suggested that the cover of a fiction book should be a gateway into the tone and content of the text. Thus, cover designers must become experts at metaphor and visual abstraction. Within graphic design, including cover design, various paradigms of colour usage have developed and evolved. For example, according to Bonn (1982), the primary colours of red, yellow, and blue are the most favoured by designers and, further, the covers of the Western story commonly have brown backgrounds; while horror and gothic tales tend to have black and dark blue backgrounds, with purple and green seldom used. However, since then, there appears to be little agreement about the use of colour in the design of book covers.

## 2. METHOD

With the rapid transition to web marketing and online books, more and more book covers might only be seen on a website prior to purchase. However, for the traditional reader the physical book tends to have these same covers. (Needless to say that the on-screen colours are subject to the limitations of the colour displays, or for the physical books, the printers' inks). For these reasons, the book covers selected for this study came from the online catalogue of a leading Australian publisher (Collins Booksellers). This ensured that all the covers were of Australian editions, and so, presumably, would appeal to the Australian audience. In contrast, an international store, such as Amazon, would have books published anywhere in the world, perhaps with covers designed for a local market.

One hundred book covers for each genre were retrieved from a single online book store ([www.collinsbooks.com.au](http://www.collinsbooks.com.au)) and collated with relevant descriptive details. The publisher's website had already categorised the books into the genres used in this study, namely: Romance; a combined genre of Mystery and Thriller, and Science Fiction (being separate from Fantasy).

The first 40 books listed in the catalogue for each genre were selected and retrieved as JPGs. When the same book was found in more than one genre, it was rejected from the genre(s) in which it was encountered second, etc. In such a case, the forty-first book was used, and so on.

For consistency, the images were resized from approximately 100×155 pixels to 8×12 pixels using Photoshop CS5 image size panel. A purpose-written program was used to obtain the Hue, Saturation and Lightness (HSL) value for each of the pixels. The HSL values were converted to Cartesian coordinates ( $x$ ,  $y$ ,  $z$  values) in a spherical HSL colour-space, where  $H$  ranged from 0 to 360 (etc.),  $S$  from 0 (achromatic) to 100, and  $L$  from 0 (black) to 100 (white).

The Cartesian coordinates and the HSL values for each book were analysed using a specifically written Excel file. Several graphs were produced, allowing the most concise group of coloured pixels to be found. Next, the centroid of that group was calculated to give the predominant colour of the book cover. A randomisation test (with 40,000 iterations) was utilised to assess the statistical significance of the differences between the centroids.

### 3. RESULTS AND DISCUSSION

The centroids of the predominant colours differed significantly ( $p = 0.00030$ ) in their position in the colour sphere. Within the three groups, Romance differed significantly from Mystery/Thriller ( $p = 0.0091$ ) and Science Fiction ( $p = 0.00025$ ); however, Science Fiction did not differ significantly from Mystery/Thriller ( $p = 0.10$ ). Generally, the centroid of the predominant cover colours of Romance was a medium pink ( $H = 4, S = 30, L = 71$ ), while Mystery/Thriller was a medium grey ( $H = 68, S = 23, L = 47$ ), and Science Fiction a light brown ( $H = 35, S = 23, L = 56$ ).

To determine the characteristics of these colours in more detail, the H, S and L values for the centroids were analysed separately. The three hues were significantly different ( $p = 0.042$ ). The main difference was between Romance ( $H = 4$ ) and Mystery/Thriller ( $H = 68$ ) ( $p = 0.017$ ), while differences between Science Fiction ( $H = 35$ ) and either Romance ( $p = 0.28$ ) or Mystery/Thriller ( $p = 0.18$ ) were not statistically significant.

There was no significant difference in the saturation of the centroids ( $p = 0.11$ ), but there was in lightness ( $p = 0.017$ ). Romance ( $L = 71$ ) was significantly lighter than Mystery/Thriller ( $L = 56$ ) ( $p = 0.020$ ) or Science Fiction ( $L = 47$ ) ( $p = 0.00026$ ), while Mystery/Thriller was not significantly different to Science Fiction ( $p = 0.18$ ).

A simple calculation of the centroids of the predominant colours in the spherical HSL space tended to produce a low saturation values for the centroid, even if many predominant colours had moderate or high saturation. Another analysis identified “the predominant colours of the predominant colours”, giving the most concise groups of colours for each genre. The most concise (and often largest by number of members) colour groups are listed in Table 1.

*Table 1. Close groups of predominant colours ranked from most frequent to least frequent, with all groups including at least 10% of covers reported – H,S,L values of centroids provided.*

Rank	Romance	Science Fiction	Mystery/Thriller
1	skin tone 43% (32,13,90)	almost black 35% (23,8,18)	pale skin-like tone 40% (29,14,81)
2	peach 20% (13,61,81)	off light pink 20% (6,7,76)	almost black 20% (143,12,10)
3	brown/black 18% (352,10,22)	off mid grey 15% (44,12,52)	mushroom 10% (310,11,31)
4	mid lightness red/brown 10% (14,55,57)	light grey-blue 15% (208,37,57)	mid grey 10% (131,5,57)
5		mid orange/brown 10% (31,55,72)	

### 4. CONCLUSIONS

In summary, the colours chosen by graphic designers of Romance covers tended, overall, to have moderate saturation, mid to high lightness, and hues that inclined towards shades of red. The Science Fiction covers were frequently dominated by black; nevertheless, shades of off-pink, grey and blue were also common. The colours used in Mystery/Thriller covers were often dominated by pale skin-like tones; they also included blacks, greys and mushroom colours. Significantly, high saturation and primary colours were uncommon in any of the three genres and, in accord with Bonn (1982), purples and greens were little used.

## ACKNOWLEDGEMENTS

We thank Ms Robyn Peacock-Smith for inspiring us to actually see the colours of the world and to ask how and why they are there.

## REFERENCES

- Bhaskaran, L., 2006. *What is Publication Design?* UK: Roto Vision.
- Bonn, T.L., 1982. *Under Cover: An Illustrated History of American Mass.* London: Penguin.
- Haslam, A., 2006. *Book design.* New York: Abrams.
- Mahnke, F.H., 1996. *Color, environment, and human response: an interdisciplinary understanding of color and its use as a beneficial element in the design of the architectural environment.* New York: John Wiley & Sons Inc.
- Pite, S., 2003. *The Digital Designer.* New York: Thomson Delmar Learning.
- Pressman, L., 2009. The Magical Business of Colour: The Psychology Behind Integrated Colour Into Design Strategy. In the *11th Congress of the International Colour Association Proceedings.* Sydney.

*Address: Francis Wild, School of Information and Communication Technology,  
Gold Coast campus, Griffith University, QLD 4222, Australia  
E-mails: f.wild@griffith.edu.au, clyde.wild@griffith.edu.au, c.hacker@griffith.edu.au*



# Chromatic Darkness: The Color Sequences in A.S. Byatt’s Little Black Book of Stories

Jada SCHUMACHER  
School of Art and Design, Fashion Institute of Technology

## ABSTRACT

To analyze the impact of color in A.S. Byatt’s *Little Black Book of Stories*, I note each color word in the text, choose Pantone Matching System colors to represent each color word, and line the colors into even vertical strips. The resultant works become charts depicting the colors in the exact order they arose in one short story. Study of these charts in relation to archetypal color in fairytales, literary criticism on Byatt, and color theory illustrates the crucial importance of color words to plot and universal meaning in Byatt’s storytelling.

## 1. INTRODUCTION

As a volume of fairytales, *Little Black Book of Stories* glimmers and shocks with overt, specific color words. [Think “whipped egg-white” (not straightforward white), “bruised”, “dead flesh purple”, “clay-pale”, “mole-grey”, “bleached khaki”, “gangrenous”, “very hot, peppery red of the Victorian Gothic”, and color of “flayed flesh” as opposed to “clear, ultrapure colors” of the historical fairytale] (LBB; Lüthi FA 27, EF 27). Classic fairytales showcase straightforward color to deliver a message without ambiguity: “‘Red’ or ‘small’—that is more clearly understood language than ‘G sharp’ or ‘minor key’” (Lüthi FA 27). If Byatt’s color words are clustered by hue (i.e. all of her varied reddish words are classified as red, etc.), fairytale symbolism in her work can be directly examined.

*Table 1 (left). Most common color symbolism in the fairytale typology (Lüthi EF 27-8)*

*Table 2 (right). Tallies of different color words of each hue in Little Black Book of Stories*

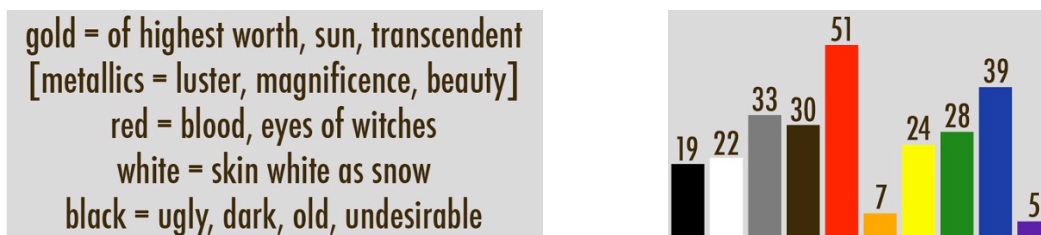

Byatt regularly uses the main colors of archetypal fairytales. But, blue and green, less common colors in the classic fairytale, also burst onto the page with frequency (Lüthi EF 27-8). Byatt’s color words often offer blatantly symbolic fairytale meaning – as seen below – but also “point to a reality in the world” (Riley 268-9). [The poignant specificity allows the color words to push farther to topically contemporary places of internal introspection.] To further underscore the reality of her color descriptors, Byatt’s reputable scholar poet, Alexander, in her novel *Still Life*, discovers that color words are an “instrument for precision” (SL 176). This color-laden novel, “engaged with postmodernism and its trial of language”, delves into more commentary on color words as language (Hadley 94). For instance, Alexander fusses over “his own struggle with color words”, and Hugh Pink complains that “Pink was an impossible name for a poet...” (SL 179, 214). Interestingly, speakers of languages

with only two basic colour terms apparently perceive and conceptualize colors in just the same way as speakers of languages with 10 or 11 basic colour terms... [Far] from being a domain well suited to the study of the effects of language on thought, the colour space would seem to be [a] prime example[s] of the influence of underlying perceptual-cognitive factors on the formation and reference of linguistic categories (Beattie and Ellis 61).

This psychological research substantiates literary criticism’s claims that Byatt color prose reads more experiential than intellectual. Alexander, in *Still Life*, realizes that “you could see things [in paintings] before saying them, indeed without saying them” (SL 176). In fact, critics attest that the author herself “experiences [paintings] “sensationally”, allowing ... [them] to move her emotionally”” (Hadley 123). Astoundingly, readers consume color as paintings in Byatt stories as Byatt pulls language into the perceptually artistic realm to “create a color element or atmosphere that envelops the viewer” (Riley 164-5). The reader experiences color words like art; hue-specific words transcend the written medium and induce a visceral reaction. Byatt notes philosopher Ludwig Wittgenstein’s assertion that a color could masquerade as “a separate being, it had a life of its own” (POM 11). And, one critic remarkably discloses that her color words operate as “passwords” to a “Platonic ‘pattern of eternal forms’” (Riley 268-9). Surely color’s highly abstract qualities help craft this animated independence and universality.

Not surprising considering her chromatically rich prose, Byatt’s writing process begins with color. She explains, “... I think visually. I see my writing as blocks of color before it forms itself” (Burns 26). She articulates that the color charts I created on her novel, *Possession*, “do, to me, recognisably represent the inside of my head” (Byatt private communications, 2007). Years later, she reflects that she does “recognise the rhythms and repetitions from your colour strips” (Byatt private communications, 2011). Her preoccupation and enchantment with color words surfaces as a seductive playfulness that reveals experiential spaces. Each color word leaves a gentle impression that builds on the next, creating a halo that shifts, transforms, and ebbs around the prose.

## 2. RESULTS AND DISCUSSION

Comparing fluctuations in emotive state and personal transformation of the main character in “A Stone Woman” to shifts in hue (the color itself), value (lightness and darkness of color), and saturation (intensity of color) provides compelling data on Byatt’s use of color.

### 2.1 Color Charts from Stories in *Little Black Book of Stories*



Figures 1 and 2: Sequences of colors from “The Thing in the Forest” and “Body Art”.



Figures 3 and 4: Sequences of colors from “Raw Material” and “The Pink Ribbon”.

### 2.2 Detailed Analysis of “A Stone Woman” from *Little Black Book of Stories*

In the figures below, hue changes show that valued fairytale gold marks positive moments in mood and transformation for Byatt (such as when the main character realizes that seemingly lifeless fossils and chalk used to be alive, when she suddenly laughs, or when glints in the landscape speak to her essence). Her early transformation leaks as red dust; her arm bursts “ruddy” with “many reds, from ochre to scarlet, from garnet to cinnabar” (LBB 117-9). She

soon spurts lava. Here, red hues symbolize change and (new) life blood while the metallic qualities of the dust inform that this atypical transformation is magnificently beautiful (as her stonecarver friend also pointedly declares). Even the dark and moody book as a whole, full of elements that “revivify our fears”, parades the word “black” in its title (Hadley 135). In all, obvious parallels in fairytale symbolism and Byatt’s color word application illustrate the value of hue change for ultimate storytelling effect.

*[Each figure below shows the story’s hue changes at top and value changes at bottom.]*



*Figure 5: Emotional State of Main Character (down = negative, up = positive).*



*Figure 6: Main Character’s Personal Emotional Transformation (up = more transformed).*

The story increasingly fills with saturated colors as the character transforms (with ~ 25% saturated in first third of the story, 35% in second third, and 64% in final third). Colors hit

high saturation at or near each of the six major peaks of emotional transformation as well. So, too, saturated colors mark shifts in character mood, although with variable consistency.

Color value changes seem less significant as mood and transformation markers than hue and saturation shifts. Dark values sometimes denote negative mood or link with peak moments, and middle values can persist at stagnant levels of transformation.

### 3. CONCLUSIONS

Journalist Geoff Dyer blasts the proliferation of color that acts “ornamental rather than animate” in Byatt’s *The Matisse Stories* (Hadley 122). Yet, the data on *Little Black Book of Stories* conflicts with his proclamation as symbolic color adds narrative; here, hue and saturation shifts augment storyline plots. Furthermore, the specificity of Byatt’s colorful prose flirts with reality and provokes the reader to intimately absorb the internal struggles of her characters. Finally, Byatt’s sequences of color extend a remarkable ambient quality, akin to mood lighting at a nightclub or Gregorian chants at a health spa. The succession of color words seems to come seamlessly through the skin, as if the reader is absorbing color in some kind of dreamlike ocean tide (or a Florentine dip-dye vat for marbleizing paper). Future research could expand to more Byatt texts and to the works of others. Future contemporary literature would benefit from equally specific color infusions as this type of chromatic language manifests a desirable spiritual ambience and pulls stories into a realm of universal experience.

### ACKNOWLEDGEMENTS

Thank you to the generous and inspiring A.S. Byatt for keeping us chromatically satiated.

### REFERENCES

- Beattie, G., and A. Ellis, 1986. *The Psychology of Language and Communication*, The Guildford Press.
- Burns, C., Ed., 2007. *Off the Page: Writers Talk About Beginnings, Endings, and Everything In Between*, W. W. Norton & Company.
- Byatt, A.S., 2003. *Little Black Book of Stories*, Vintage International. [LBB]
- Byatt, A.S., 1992. *Passions of the Mind*, Turtle Bay Books. [POM]
- Byatt, A.S., 2007-2013. Private communications with author.
- Byatt, A.S., 1985. *Still Life*, Scribner Paperback Fiction. [SL]
- Hadley, L., 2008. *The Fiction of A.S. Byatt – A reader’s guide to essential criticism*, Palgrave Macmillan.
- Lüthi, M., Trans. by J. Erickson, 1984. *The Fairytale as Art Form and Portrait of Man*, Indiana University Press. [FA]
- Lüthi, M., Trans. by J. Niles, 1982. *The European Folktale*, Indiana University Press. [EF]
- Riley, C. 1995. *Color Codes: Modern Theories of Color in Philosophy, Painting and Architecture, Literature, Music, and Psychology*, UPNE.

*Address: Assoc. Prof. Jada Schumacher, Communication Design, School of Art + Design, Fashion Institute of Technology, 227 West 27th Street D315, New York, NY 10001 USA  
E-mails: jada\_schumacher@fitnyc.edu, jada@design-orange.com*

# Colour Preference – Colour Fidelity

Janos SCHANDA,<sup>1</sup> Agnes NÉMETH-VIDOVSKY<sup>2</sup>

<sup>1</sup> University of Pannonia, Hungary

<sup>2</sup> Budapest Technical University, Hungary

## ABSTRACT

Colour rendering is a subject that has been debated since its very first conception. First test methods were based on spectral differences, later a method based on the colour difference of test samples illuminated by the test source and a reference illuminant has been accepted. Ever since its official recommendation by the CIE both within the CIE and independently the question how colour rendering should be better defined has been discussed.

Early in this debate the question of a flattery index (now colour preference index) was raised, and discussed in CIE together with the updating of the current test method. CIE has recently formed two technical committees: one for colour fidelity and one for colour preference.

Present paper recommends methods, how a combined index could be elaborated that uses – as far as possible – best up to date colorimetric techniques and is adjusted to conform to visual observations. Starting from a modern colour fidelity program it is shown how this could be adjusted to general lighting requirements, and how it could be extended to provide a secondary index of preference.

A caveat is also expressed not to overemphasize the preference, as in mixed illumination situations this might lead to unexpected large colour distortions.

## 1. INTRODUCTION

As long as only incandescent light sources were in use, mankind – although observed colour distortions using incandescent lamps compared to the object's colour illuminated by daylight – accepted these distortions. With the introduction of non-incandescent electric light sources the colour reproduction quality of the light sources had to be quantified. The first descriptions to characterize the colour rendering of light sources were based on the so-called spectral band methods (CIE, 1948).

Soon it was realized that a better description could be attained if the object's colour, illuminated by the test source, would be compared to the same object's colour seen in an environment to which one is accustomed. For low CCT environments an incandescent lamp was the logical reference source, and for higher CCT a phase of daylight. Based on this CIE agreed to select as reference illuminant a Planckian radiator of equal CCT if the CCT of the test source was at or below and 5000 K and a phase of daylight if the CCT of the test source was higher (CIE, 1974).

It was soon observed that some sources might show objects look “nicer” as under the reference illuminant. Judd coined the term flattery index already in 1967 (Judd, 1967). The flattery index was intended to describe whether a light source renders colours in a more pleasant (flattery) way than another. Jerome discussed the differences between flattery and rendition in detail (Jerome, 1972). Later the word preference was used instead of flattery, and Thornton's calculation showed that colour rendering and colour preference indices do not have their optimum value at the same spectral distribution (Thornton, 1974). One of the recent colour quality scales was developed at NIST by Davis and Ohno (Davis, 2005; Davis, 2010). It has special versions for preference (increased saturation).

During the past forty years many algorithms were developed to describe colour rendering, now often mentioned as colour fidelity (intended to describe the colour distortion compared to the colour of the objects illuminated by a reference illuminant), and colour preference. In this paper the term colour rendering will be used as the generic expression, and instead of the old CIE colour rendering expression colour fidelity will be used. For flattery colour preference, for describing the capability of discriminating small colour differences under the given light source, the term colour discrimination will be used. In a recent paper Houser and co-workers (Houser, 2013) reviewed twenty-two measures of colour rendition. They could show that the different metrics cluster into three neighbourhoods if shown in a two dimensional colour discrimination/colour preference space. (For details of the different measures readers are directed to the original paper.)

## 2. COMPONENTS OF A COLOUR RENDERING MEASURE

The work-flow of a colour rendering calculation is usually represented by flow-diagram as shown in Figure 1 (Schanda, 2007).

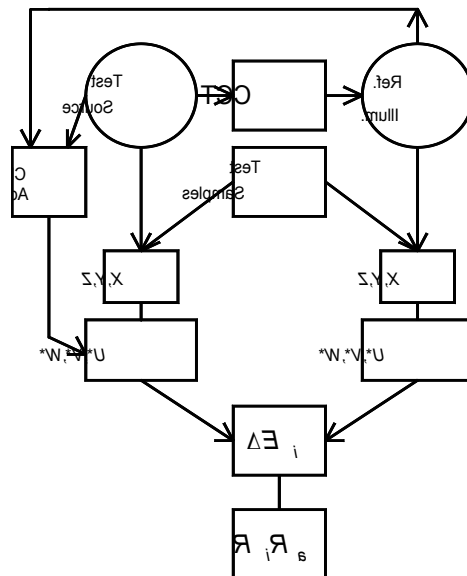

Figure 1. Flow chart of colour rendering calculation.

From this figure it is already obvious that the calculation might be updated, as many of the components of the calculation are outdated (Van Kries chromatic adaptation,  $U^*$ ,  $V^*$ ,  $W^*$  colour space and colour difference). To see possibilities for updating the system, the single components have to be inspected.

### 2.1 Reference illuminant

The CIE recommendation (CIE 1974) prescribed a Planckian or daylight phase as reference illuminant. An alternate possibility would be to have a single reference illuminant (Schanda J. 1981; van Triegt, 1999) and use modern chromatic adaptation transformation to this reference. Using computer simulations it could be shown that the obtained colour fidelity rank order of sources does not agree with visual observations (Schanda, 2006; Schanda, 2007b).

### 2.2 Test samples

The original CIE test samples are certainly not optimum, they are all unsaturated. On the other end, the CQS samples are all saturated and over-emphasize a few regions of the spectrum,

where their reflectance spectra change abruptly. Smet and Whitehead (Smet, 2011) have shown that by designing special single maximum, wide-band spectra an optimum sampling of the spectrum can be obtained. These samples are suitable to evaluate lamp colour rendering where gaming with lamp spectra is made very difficult. If this is further supplemented with the evaluation of a large number of samples, where even low and high colour constant samples are used (Chou, 2011) one can get a good feeling also on the hue area where a given lamp will perform poorly.

### 2.3 Colour engine

A colour fidelity program has been worked out, based on above test samples, the most up to date colour space and colour difference model (CIE 10°observer, CAM02-UCS), using root-mean-square averaging and a sigmoid type function to re-scale colour differences to colour fidelity (Smet, 2013). The complete colour fidelity program is known as nCRI or CRI2012, where the  $\Delta E_{rms}$  to  $R_{a,2012}$  conversion was adjusted so that for the F1 to F12 fluorescent lamps described in CIE 15 (CIE, 2004) the average  $R_{a,2012}$  should equal the CIE  $R_a$  value.

## 3. TESTING THE COLOUR FIDELITY MODEL

Testing the nCRI program it became obvious that while for the traditional tri-band compact fluorescent lamps of 4000 K CCT the  $R_{a,2012}$  was very near to  $R_a$ , for the 3000 K lamps the  $R_{a,2012}$  was considerably lower. Although this might be expected from the fact that in homes WW CFLs are not really beloved, in offices the CW fluorescent lamps are accepted. Visual experiments were conducted comparing CW and WW CFLs with incandescent lamp reference lights. Table 1 shows calculated colour rendering data (CIE Ra, CQS Qa, the official nCRI metric with the theoretical 17 test samples and the nCRI metric with specially prepared eight samples (Whitehead 2013). The table shows also the average of visually observed colour differences (20 observers) using the above eight samples (a low colour difference number means smaller colour difference to the reference) (Vidovszky, 2013).

*Table 1. Computed CRI values and observed colour differences, CW and WW CFLs versus incandescent lamps*

	CIE Ra	Qa	nCRI(17)	nCRI(8)	Vis.colourdiff.
CW CFL	84	84	78	78	0,76
WW CFL	84	82	68	71	1,02

## 4. EXTENSION FOR COLOUR PREFERENCE

Other experiments (Csuti et al, 2013) have shown that preferred lighting correlates well with the Feeling of Contrast Index up to FCI=140 (Hashimoto, 2007), thus the present study proposes that in the colour difference calculation of  $\Delta E_{rms}$  the chroma term should be set to zero if FCI<140, and between FCI 140 and 150 the chroma term should be multiplied by a factor  $k = (FCI-140) \times 0.1$ .

## 5. CONCLUSIONS

For practical colour design of interiors both colour fidelity and colour preference description of the light source is needed. The CRI2012 colour fidelity index is based on the original CIE principles, but updates the single components to the most up-to-date colorimetry. Thus it is recommended to use the CRI2012 as the starting point, and use as a second index a chroma modified colour difference, based on the value of the FCI.

## ACKNOWLEDGEMENTS

This research has been supported by the TÁMOP-4.2.2/B-10/1-2010-0025 project.

## REFERENCES

- Chou et al., 2011. Recent Developments in Colour Rendering Indices and Their Impacts in Viewing Graphic Printed Materials. *19th Color and Imaging Conf.: Color Science and Engineering Systems, Technologies, and Applications*, San Jose, Calif., Nov. 2011; p.61-; ISBN / ISSN: 978-0-89208-297-1.
- CIE, 1948. Commission Internationale d'Éclairage. *Compte Rendu 11th. Session*, Paris 1948, p.5.
- CIE, 1974. Commission Internationale d'Éclairage. *Method of measuring and specifying colour rendering properties of light sources*, CIE 13.2 (TC-3.2) 1974.
- CIE, 2004. Commission Internationale d'Éclairage. *Colorimetry* CIE 15:2004.
- Csuti, P., et al. 2013. Preferred home lighting design. *Proc. CIE Centenary Conference "Towards a New Century of Light"*. April 15/16 2013. Paris. CIE x038:2013 pp. 705-710.
- Davis, W., Y. Ohno, 2005. Towards an improved color metric. *Proc. SPIE 5941*, G59411G.1-59411G.8.
- Davis, W., Y. Ohno, 2010. Color quality scale. *Opt. Eng.* 49:033602-1 – 033602-16.
- Hashimoto, K., et al., 2007. New Method for Specifying Color-Rendering Properties of Light Sources Based on Feeling of Contrast. *Color Research and Application*, 32: 361-371.
- Houser K.W., M. Wei, A. David, M.R. Krames and X.S.Shen, 2013. Review of measures for light-source color rendition and considerations for a two-measure system for characterizing color rendition. *Optics Expr.* 21:10393-10411.
- Jerome, C.W., 1972. Flattery versus rendition. *J. of IES* 208-211.
- Judd, D.B., 1967. A flattery index for artificial illuminants. *Illum. Engng* 62:593-598.
- Met, K., W.R. Ryckaeret, M.R. Pointer, G. Deconinck, and P. Hanselaer, 2011. Optimal colour quality of LED clusters based on memory colours. *Optics Expr.* 19:6903-6912.
- Schanda, J., 2007. Colour rendering of light sources Chapter 8 in *Colorimetry – Understanding the CIE system*, ed.: J. Schanda, Wiley Interscience 2007.
- Schanda, J., 1981. Possibilities of colour rendering evaluation based on a single reference source. *IV Lux Europa*, Granada.
- Schanda J., G. Madár, 2006. Colour rendering index of LED light sources. *Lumen V4 Conf.* Balatonfüred.
- Schanda, J., G. Madár, 2007b. Light source quality assessment. *CIE 26th Session – Beijing*. D1-72 – D1-75.
- Smet, K., L. Whitehead, 2011 Meta-Standards for Color Rendering Metrics and Implications for Sample Spectral Sets. *19th Color and Imaging Conference: Color Science and Engineering Systems, Technologies, and Applications* San Jose, California; November 2011; p. 76-; ISBN / ISSN: 978-0-89208-297-1.
- Smet, K.A.G., J. Schanda, L. Whitehead, R.M. Luo, 2013. CRI2012: A proposal for updating the CIE Colour Rendering Index. *Lighting Res. & Appl.* under publication.
- Thornton, W.A., 1974. A validation of the color-preference index. *J. IES* 48-52.
- van Trigt, C., 1999. Color rendering, a reassessment. *Color Res. & Appl.* 24:197-206.
- Vidovszky-Németh, Á., P. Csuti, F. Szabó and J. Schanda, 2013. Testing the CRI2012 colour fidelity model. To be published.
- Whitehead, L., 2013. Report at the CIE TC 1-90 Colour Fidelity meeting, Paris.



# Colour Harmony: from Dualism to Living Perception

Harald ARNKIL

Department of Art, Aalto University School of Arts, Design and Architecture

## ABSTRACT

The period from about 1700 to the beginning of the 20th century saw a succession of remarkable inventions in the systematic ordering of colours, often accompanied by theories of their harmonies combinations. This development came to a climax when Albert Henry Munsell and Wilhelm Ostwald almost simultaneously published their colour order systems, later editions of which contained detailed instructions on colour harmony. Munsell and Ostwald were preceded by an impressive lineage of scientists and philosophers writing on colour harmony. Many artists, particularly at the turn of the 19th and 20th centuries, became interested in what scientists had to say about the aesthetics of colour. Interest towards concepts of harmony among artists has waned markedly since the 2nd World War, but among scientists it remains stronger than ever. However, today's colour scientists express their ideas in the form of algorithms, which has further alienated artists from the subject. This paper explores why present-day concepts of colour harmony fail to motivate artists and designers and suggests some alternative directions for research in this important subject.

## 1. INTRODUCTION

Only a few artists have ever aimed at totally harmonious art in the sense of the conventional theories of harmony (Georges Seurat being a famous exception). The function of art is to stir our emotions, intellect and imagination. To have this effect, it needs to deviate from the expected, from the 'normal'. Harmony is very much in the comfort zone of normality, whereas contemporary art and design aim at being mostly out of it. To have any useful meaning for artists and designers today, a theory of colour harmony needs to address at least the following issues: 1) Harmony has lost its status as a universal concept in art and needs to be re-examined, 2) Art and design have become alienated from the formalistic ideas of visual coherence that dominated modernism, 3) Colour should not be regarded separately, but in relation to all the sensory, cultural and conceptual factors constituting an artwork, 4) Rather than being passive reception, colour perception is a matter of involvement, interaction with the world, 5) The history and intentionality of the subject influences his/her colour experiences. This also undermines the validity of rigid universal colour theories. These are big challenges, but to leave them unanswered is to turn a blind eye to reality.

### 1.1 Colour dualism

Harmony was a central issue of aesthetic theory in the visual and other arts until the rise of Modernism from around 1860 onwards. For centuries harmony of proportion and colouration were important criteria of aesthetic judgement of both art and design objects; and aesthetic judgement was a key factor in evaluating artistic quality and worth. Other criteria included the ability of the art work to enlighten the viewer or reader and to cultivate moral and aesthetic sensibility and a sense of the sublime. Classical theories of harmony in architecture, sculpture, music and poetry had their models in the extant works of ancient art, such as Classical greek ruins, sculptures, utility objects, poetry and their Roman copies and reinterpretations. For theories of colour harmony in painting and the other plastic arts, there

was very little to lean on. It had to be construed or inferred from the other, better known or preserved arts and sciences. Two concepts – that are interwoven in many colour theories – have dominated colour harmony from Antiquity to this day: the concept of a systematic ordering of colour relationships, and the concept of an analogy between colour relationships and musical consonance. There is a third, less direct, concept and tradition that continues to influence colour harmony; the Pythagorean idea of fixed mathematical proportions determining the movements and distances of the sun, the planets and the stars orbiting the earth was linked to musical consonance to form a Harmony of the Spheres. These traditions have contributed to the continuation of a metaphysical and dualistic model of colour harmony. This model presupposes the existence of an ideal and sublime harmony that is only indirectly sensed by mortals.

### 1.2 The music analogy

The notion of a parallel between colour harmony and musical harmony can be traced as far back as Pythagoras (ca. 570-490 BC) and its history has been thoroughly discussed in Kemp (1990), Gage (2001), Gage (1999) and in von Maur (1999). The comparison of the wave theory of light with the vibration frequencies of sound became very popular in the latter part of the 19th century (von Maur 1999) and persists in recent ideas of colour harmony (Brougher et al. 2005). Some supporters of this idea have linked it with the phenomenon of synesthesia. Among the most common forms of clinical synesthesia is colour-hearing, the spontaneous firing of visual sensations by auditory stimuli or vice versa. Synesthesia is a real experience, but at the same time entirely private and subjective. No two synesthetes have been known to link colours and sounds in exactly the same way. (See Cytowic 2002). There are many and very interesting metaphorical and cultural parallels in, for example, the arts of painting and music, but so far there is no evidence, either physical or neurological, of an objective connection between auditory pitch and perceived colours.

### 1.3 The beguiling beauty of colour order

If colour harmony is regarded as a system of unity, coherence and continuity, then the rules are relatively simple. Linear samplings from any colour system that is based on a visually logical order will automatically yield smooth sequences of hue, saturation, lightness, whiteness, etc., as well as well-balanced complementaries. Harmony rules that are derived from perceptual colour systems will have strong predictive power when applied to applications of colour that are similar to the system: two-dimensional, with colour areas of uniform texture, size and shape. In this sense they are self-predictive and there is no need for mathematics to prove it. Such models are less successful when applied to colours in other modes of appearance. Reasons for this are numerous. As Josef Albers stated in *Interaction of Color* (Albers 2013: 41-42):

“Usually, illustrations of harmonious color constellations which derive from authoritative systems look pleasant, beautiful and thus convincing. When applied in practice, these harmony sets appear changed. In addition to quantity, form and recurrence, wider aspects exert still more changing influences. These are: Changed and changing light – and even worse, several simultaneous lights; reflection of lights and colors; direction and sequence of reading; presentation in varying materials; constant or altering juxtaposition of related and unrelated objects.”

Albers here makes a case against harmony as an *a priori* system of structural relations, which exists irrespective of the condition, intentions and expectations of the viewer and

independent of the above mentioned contingencies. If it is accepted that colours cannot exist as a metaphysical structure independent of a viewer, then colour relationships cannot exist in the world *a priori*, but are rather the outcome of the engagement of the human (or animal) with its environment and cultural condition. To understand the impact and meaning of colour combinations it is necessary to investigate this dynamic relationship. It may turn out that such investigation yields little or nothing in the way of universal rules of colour harmony, but rich rewards in the way of understanding the meaning and function of colour in our lives.

## 2. LIVING PERCEPTION

The rapid globalization of the art market has exposed artists to an increasing diversity of artistic ideas and influences. Also the focus and role of art and design has shifted from questions of aesthetic sensibility, beauty and the sublime to conceptualism, gender, political, environmental and societal issues. Colour harmony based on abstract and formal ordering, unity, balance or pleasantness has to a large extent ceased to motivate artists. (See e.g. Gage 1999: 55-56, Westland et al. 2007). This alienation of artist from formalistic concepts of harmony has left the field to cognitive and computer scientists, psychologists and neuropsychologists, who express their ideas in the form of algorithms. As a result, artists and designers have lost touch with present thinking in colour harmony.

The fact that harmony has lost its status as a universal concept in art and design does not mean that apt colour combination has ceased to be relevant. On the contrary, in today's world of electronic, printed and mass-produced colour the issue of its impact is more urgent than ever: a redefinition of colour harmony is needed. Albers spoke of the colour combinations of the old (or new) masters as "instrumentation" as in an exercise for studying these instrumentations Albers urged the students to give a general impression of the "...climate, temperature, aroma or sound of their work..." (Albers 2013). The instrumentation could of course be consonant or dissonant. What mattered was the particular sensual impression, the mood and character conveyed by the colours and forms. These impressions presuppose a living viewer in living perception, relating the experience to his/her history, culture and situation. These experiences are not private (like synaesthesia), but shared more or less universally due to our common experience and fate as humans. It is here that we must begin our search for colour universals.

James Gibson (Gibson 1986), Semir Zeki (Zeki 1999) and Alva Noë (Noë 2004) have all independently emphasized the active role of the human or animal in the formation of visual experiences. They stress that our sense of sight developed primarily for gaining information about our physical surroundings, and they emphasize the filtering of sensory information for the purpose of appropriate and relevant actions. "The visual system *hunts* for comprehension and clarity. It does not rest until the invariants are extracted. Exploring and optimizing seem to be function of the system." (Gibson 1986: 219). Perceiving colours and their relations, then, is not a mere matter of judging their static "qualities", but of sensing their potentiality for actions.

Colour has not only multiple layers of meaning, but is richly layered also on a perceptual level. In his principal work, *Phenomenology of Perception* Maurice Merleau-Ponty describes the multi-layered nature of visual perception:

We shall not succeed in understanding perception unless we take into account a colour function which may remain even when the qualitative appearance is modified. I say that my fountain pen is black, and I see it as black under the sun's rays. But this black-

ness is less the sensible quality of blackness than a sombre power which radiates from the object even when it is overlaid with reflected light, and it is visible only in the sense in which moral blackness is visible.” (Merleau-Ponty 2002: 355-6).

It is this richness of experience – which cannot be quantified or measured – that a theory of colour harmony must try to embrace.

#### REFERENCES

- Albers, J., 2013. *Interaction of Color*. 50th Anniversary Edition. New Haven and London: Yale University.
- Brougher, K., J. Strick, A. Wiseman and J. Zilczer, 2005. *Visual music – Synesthesia in Art and Music since 1900*. New York: Thames and Hudson Inc.
- Cytowic, R., 2002. *Synesthesia: A Union of the Senses* (Second Edition). Cambridge, MA: A Bradford Book, the MIT Press.
- Gage, J., 1993. *Colour and Culture, Practice and Meaning from Antiquity to Abstraction*. London: Thames and Hudson.
- Gage, J., 1999. *Colour and Meaning: Art, Science and Symbolism*. London: Thames and Hudson.
- Gibson, J., 1986. *The Ecological Approach to visual Perception*. New York: Psychology Press.
- Kemp, M., 1990. *The Science of Art – Optical themes in western art from Brunelleschi to Seurat*. New Haven and London: Yale University Press.
- Maur, K. von, 1999. *The Sound of Paintings*. Munich: Prestel.
- Merleau-Ponty, M., 2002. *Phenomenology of Perception*. London: Routledge.
- Noë, A., 2004. *Action in Perception*. Cambridge: The MIT Press.
- Westland, S., K. Laycock, V. Cheung, P. Henry and F. Mahyar, 2007. *Colour Harmony. Colour: Design and Creativity* (2007) 1(1): 1-15. Available on-line, <http://aic-colour-journal.org/index.php/JAIC/article/view/70>. Last accessed February 12, 2013.
- Zeki S., 1999. *Inner Vision – An Exploration of Art and the Brain*. London: Oxford University Press.

*Address: Harald Arnkil, Aalto University,  
School of Arts, Design and Architecture, Department of Art,  
P.O. Box 31000, 00076 AALTO, Finland  
E-mail: harald.arnkil@aalto.fi*

# Colour Emotion: Dimensions and Relations: A Case Study among Iranian Students

Minoo ROSTAMI,<sup>1</sup> Hossein IZADAN,<sup>1</sup> Forough MAHYAR<sup>2</sup>

<sup>1</sup> Department of Textile Engineering, Isfahan University of Technology

<sup>2</sup> Department of Color Image Processing, Institute for Color, Science and Technology

## ABSTRACT

A psychophysical experiment is being conducted to ascertain the relationship between different scales in colour emotion for single colours in CIELAB colour space. The current work, in which ten word pairs is going to be used, is a development of Ou's study among Middle East observers. The applied word pairs in this paper are "Warm-Cool", "Tense-Relaxed", "Active-Passive" and "Modern- Classical" which were translated into Persian, accordingly. Due to doing the psychophysical experiment in Isfahan, one of the metropolitan cities in Iran, all of the observations were divided into two groups of "from Isfahan (or Isfahani)" and "not from Isfahan or (other Iranian)". The effect of gender and culture were investigated. The results show that there is no significant disparity between male and female responses; and thus, there is no statistically significant effect of gender in all applied scales. In comparison between different Iranian cultures, there seems to be a good agreement between Isfahani's and other Iranian. The values of correlation coefficients of the research are equal or more than the ones in the Ou's research, which were carried out among British and Chinese observers for all applied word pairs. Further investigation on the other colour emotional scales will be required.

## 1. INTRODUCTION

Colour and its emotional responses influence human's daily life. Everybody is affected by surrounding colours and shows special moods and emotions against different colours. The study of colour emotion has been recently attracted many researchers' views in different areas of science, psychology, art and design (Ou et al. 2004; Gao. et al. 2007; Soriano. et al. 2009; Xiao-Ping et al. 2006; Sato et al. 2000).

The current study is a development of Ou's study (Ou et al. 2010) among Middle East for four emotional word pairs which are "Warm-Cool", "Tense-Relaxed", "Active-Passive" and "Modern- Classical". According to the literal meanings of words and on the basis of Osgood's study (Osgood et al. 1957), word pairs can be divided into three primary factors, namely, "Evaluative", "Potency", and "Activity". However, the applied word pairs in this paper were classified only in the "Activity" factor which was identified by Osgood. As shown in table 1, the word pairs were translated into Persian language, accordingly.

## 2. EXPERIMENTAL

A "LaCie324i" LCD computer display was used for the psychophysical experiment and a "Lacie Blue eye pro" Icc Profile Maker colorimeter and related software were applied in order to conduct characterise the display. Forty observers, seventeen males and twenty three females, who were Iranian students aged between 20 and 30 and with normal colour vision, according to the Ishihara colour vision test, took part in the experiment in order to find the

colour emotional dimensions for a single colour. The observers were asked to sit in front of the display with a viewing distance of about 50 cm and to select more appropriate word to describe the colour, which was displayed on the LCD display. Due to doing the psychophysical experiment in Isfahan which is one of the metropolitan cities in Iran, all of the observations were divided into two groups of “from Isfahan, or Isfahani” and ‘not from Isfahan, or other Iranian”.

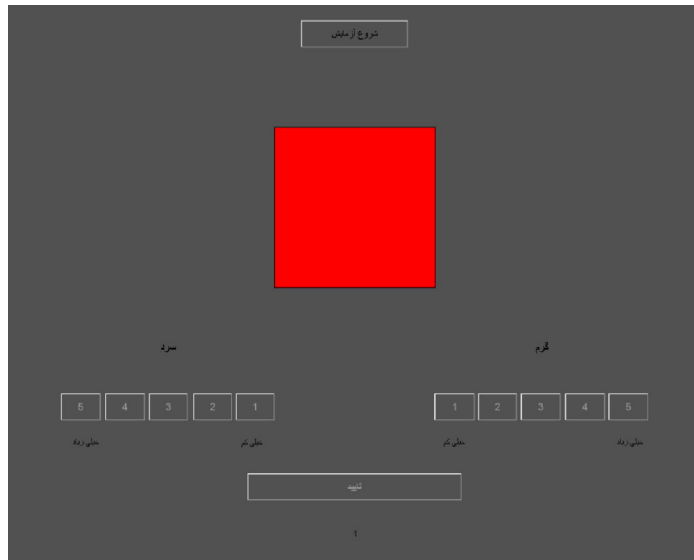

Figure 1: A screenshot of the CRT screen in the experiment.

Table 1: Emotional word pairs used in the experiments (in English and Persian languages)

English	Persian
Warm-cool	مرگ – درس
Modern-classical	یئنس -نردم
Active-passive	لاعفریغ -لاعفر
Tense-relaxed	مارآ-یبصع

A total of nineteen “Isfahani” students and twenty one “other Iranian” students took part in the experiment. Twenty colour stimuli which were selected from the NCS Color Atlas, suggested by Ou. et al. (Ou et al. 2010), with a reasonable range of hue, lightness, and chroma, were applied in the experiment. The stimuli produced a good coverage in CIELAB colour space. The stimuli were measured 3 cm × 3 cm and contained one colour, surrounded by black borders, which were randomly displayed on a mid-grey background and viewed in a darkened room. Figure 1 illustrates a screenshot of the display as it was used during the experiment. Each observer carried out the experiment in two sessions of approximately 30 minutes. As seen in the figure the observers were asked to score their responses between -5 and +5 for each colour stimulus.

### 3. RESULTS AND DISCUSSION

Categorical judgment technique was applied for all selections of the observers (raw data) and the z scores were calculated for all the four colour emotional responses of the observers and each stimulus. Correct decision which is a measure of agreement between observers decision on a set of stimuli was computed. Table 2 shows the results for this data analysis. As

seen in the table, the maximum average value of the correct decision is relevant to “Tense-relaxed” emotional response and is equal to 0.75.

*Table 2: The values of correct decision.*

	Warm-cool	Modern-classical	Active-passive	Tense-relaxed	Mean
Male	0.75	0.67	0.67	0.75	0.71
Female	0.75	0.68	0.64	0.76	0.71
Isfahani	0.74	0.65	0.60	0.73	0.68
Other	0.74	0.65	0.65	0.77	0.71
Total	0.74	0.65	0.64	0.75	0.70

The Pearson product-moment correlation coefficient ( $r$ ) was applied to measure the effect of the gender and culture on the observers’ colour emotional responses. Regarding the gender data analysis, all of the correlation coefficients were fairly high (more than 0.8). The correlation coefficients for “Warm-Cool”, “Tense-Relaxed”, “Active-Passive” and “Modern- Classical” word pairs are 0.94, 0.92, 0.83, and 0.83, respectively. As the correlation coefficient of (+1) indicates the perfect positive correlation, there is no significant disparity between male and female responses; and thus, there is no statistically significant effect of gender in all applied scales. In comparison between different cultures among Iranian, there seems to be a good agreement between Isfahani and other Iranian as all the correlation coefficients are more than 0.8. These correlation coefficients for “Warm-Cool”, “Tense-Relaxed”, “Active-Passive” and “Modern- Classical” word pairs are 0.91, 0.94, 0.80, and 0.94, respectively.

*Table 3: comparison the results in this research with the ones in the Ou’s research among male and female observers.*

	Warm-cool	Modern-classical	Active-passive	Tense-relaxed
present research	0.94	0.83	0.83	0.92
Ou’s research	0.94	0.68	0.77	0.62

Table 3 and table 4 compare the correlation coefficients obtained in the present research with the corresponding ones in the Ou’s research. As seen in the table, the values of correlation coefficients of the research are equal or more than the ones in the Ou’s research, which were carried out among British and Chinese observers for all applied word pairs.

*Table 4: comparison the results in this research among Isfahani/other Iranian observers with the ones in the Ou’s research among British/Chinese observers.*

	Warm-cool	Modern-classical	Active-passive	Tense-relaxed
present research	0.91	0.94	0.80	0.94
Ou’s research	0.79	0.72	0.73	0.27

#### 4. CONCLUSIONS

The results of this research shows consistent emotional responses for the four “Warm-Cool”, “Tense-Relaxed”, “Active-Passive” and “Modern- Classical” word pairs among Iranian students. There is no significant disparity between male and female responses; and thus, there is no statistically significant effect of gender in all applied scales. In comparison between different Iranian cultures, there seems to be a good agreement between Isfahani and other Iranian. Further investigation on the other colour emotional scales will be required.

## ACKNOWLEDGEMENTS

The authors would like to thank all observers who participated in the experiment.

## REFERENCES

- Gao, X., and J.H. Xin, et al., 2007. *Analysis of Cross-Cultural Color Emotion*, *Color Research & Application* 32. 223-229.
- Ou, L., and M.R. Luo, et al., 2010. A cross-cultural comparison of colour emotion for two-colour combinations, *Color Research & Application* 37(1) 23-43.
- Osgood, C.E., and G.J. Suci, et al., 1957. *The Measurement of Meaning*, University of Illinois Press.
- Ou, L., and M.R. Luo, et al., 2010. A Cross-Cultural Study On Colour Emotion and Colour Harmony, *International Conference Proceedings of Design Research Society (DRS)*. Melbourne, Australia.
- Soriano, C., and J. Valenzuela, 2009. Emotion and Colour Across Languages: Implicit Associations in Spanish Colour Terms, *Social Science Information* 48(3) 421-445.
- Xiao-Ping, G., and J.H. Xin, 2006. Investigation of Human's Emotional Responses on Colors, *Color Research & Application* 31(5). 411-417.
- Sato, T., and K. Kajivara, 2000. Quantitative evaluation and categorization of human emotion induced by colour, *Adv Colour Sci Technol* 3. 53-59.

*Address: Dr. Hossein Izadan, Department of Textile Engineering,  
Isfahan University of Technology, Isfahan, Iran. 84156-83111  
E-mail: izadan@cc.iut.ac.ir*



# A Study on Individual and Classroom Color Preferences of Children between the Ages of 8-10

Fazıla DUYAN, Rengin UNVER  
Faculty of Architecture, Yıldız Technical University

## ABSTRACT

The functions and locations of schools, specifically classrooms, carry extraordinary value. Classrooms are spaces that have significant impact on students' lives. Based on the "color" component of the physical environment elements, a pilot study is realized to define the individual and classroom color preferences of children between the ages of 8-10, studying in educational buildings in Istanbul/Turkey. In this context, a two-staged study has been conducted. The first stage aims to collect data on the individual color preferences of children, and the second stage to spot their predilection on their classrooms' colors.

## 1. INTRODUCTION

The physical size of the classes, the properties of the physical environment (heat, sound, light, color, smell, etc.) have effects on students. For example, the effects of surface color schemes on the students are as important as the quality and quantity of lighting conditions in classrooms. In related literature, there are different studies on the effects of the color schemes on office workers and students (Baytin et al 2005, Kaya 2004, Küller 2009 and Kwallek 2006). In these studies, the subjects are generally adults. To collect more data in this context, a research has been started to determine the color preferences and impact of the classroom colors on the performance of children between the ages of 8-10 by addressing color as one of the elements of physical environment. This paper presents the preliminary findings of a pilot study on the individual and classroom color preferences of children studying in the primary schools.

## 2. METHOD

The methodology of the study on color preferences of children is given below:

- Selection of the primary schools.
- Identification of the colors that are used in the individual and classroom color preferences.
- Determination of individual and class color preferences through surveys.
- Evaluation of survey results.

Two pilot primary schools (private and state) in Çekmeköy district of Istanbul were selected. The students in the private school have better social, cultural and economic conditions than the state school. The surveys have been conducted using Munsell Color System on 119 students in two primary schools (Luke 1996). 29 males and 30 females from the private school, 30 males and 30 females from the state school corresponding to the age group of 8-10 have been participated. The color vision defects of the students were not tested. The surveys were carried out in their classrooms, on 21-25th May, 2012 and between 10.00-16.00. Each student spent approximately 12 minutes for the surveys.

### 2.1 Determination of Individual Color Preferences

In order to identify the general color tendencies of children, 10 hues having different values and chromas, in totally 70 different colors were used. The values (3, 6, 9) and chromas (2, 6, 10) in every hue are followed each other equal steps (Table 1).

Table 1: Munsell Color System notations for colors.

HUE	VALUE/CHROMA			HUE	VALUE/CHROMA		
5R (5)	9/2	8/6	-	55 (5GB)	9/2	9/6	9/8
	6/2	6/6	6/10		6/2	6/6	-
	3/2	3/6	3/10		3/2	-	-
15 (5YR)	9/2	8/6	-	65 (5B)	9/2	9/4	8/8
	6/2	6/6	6/10		6/2	6/6	-
	3/2	3/6	-		3/2	-	-
25 (5Y)	9/2	9/6	8/10	75 (PB)	9/2	8/6	-
	6/2	6/6	-		6/2	6/6	6/10
	3/2	-	-		3/2	3/6	-
35 (5GY)	9/2	9/6	9/10	85 (5P)	9/2	8/6	-
	6/2	6/6	6/8		6/2	6/6	6/10
	3/2	3/6	-		3/2	3/6	3/10
45 (5G)	9/2	9/6	8/10	95 (RP)	9/2	8/6	-
	6/2	6/6	-		6/2	6/6	6/10
	3/2	-	-		3/2	3/6	3/10

The colored samples were prepared in two different dimensions (7'7cm and 3x3cm). The size of 7'7cm samples were separately pasted on grey cartons (N-5/0; size B5). The size of 3x3cm samples were pasted and grouped on grey cartons (N-5/0; size A4) for the same hue and 10 different hue pages were arranged. Some examples of the colors used in the surveys are given in Figure 1.

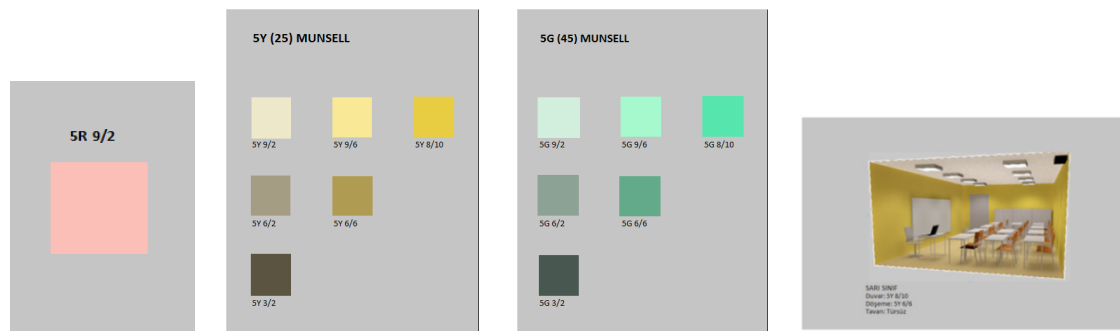

Figure 1: B5 color sample, A4 hue color samples, classroom color sample.

Initially, 10 different hue pages (sized A4) were shown to the subjects and asked to choose one color from the each pages. Following, each chosen samples were presented as big sizes (7cmx7cm, B4), and they were asked to select the most favorite color. During this process, the intention has been to determine the associations of colors in the subjects' minds with the purpose of avoiding any possible inducement; the subjects were not informed about how and where these colors were going to be used.

### 2.2 Determination of Classroom Color Preferences

In the determination process of class color preferences of children, five different colors were used in simulated photographs of a specific classroom generated by a lighting program (DI-ALux 4.10 2012). The dimensions of the classroom are 7.5'4.7x2.7 m. Luminaries have fluorescent lamps (Ra 80, 4000K) and required illuminance (500 lm/m<sup>2</sup>) has been provided on the working plane by direct lighting. Interior colors used in the classroom are shown in Table 2. Simulated photographs were pasted on the grey cartons (N-5/0; size B5). Then subjects were asked to put the simulated classroom photographs in order according to their likes (Figure 1).

Table 2: Munsell Color System notations of the classroom colors.

Class Color Hue	Ceiling	Wall	Floor	Furniture
RED	N-9/0	5R-8/6	5R-6/10	N-5/0
YELLOW	N-9/0	5Y-8/10	5Y-6/6	N-5/0
GREEN	N-9/0	5G-9/6	5G-6/2	N-5/0
BLUE	N-9/0	5B-9/4	5B 6/2	N-5/0
PURPLE	N-9/0	5P-8/6	5P-6/10	N-5/0

### 3. RESULTS OF PREFERENCE OF COLOR AND CONCLUSION

The general results of the survey for both the two genders can be summarized as below:

- Individual color preferences of state school students are focused in cool colors (hues) like blue, green; they did not prefer warm, dark and low saturated colors. As shown in Figure 2, green (5G-8/10) elicited the highest number followed by blue-green (5BG-9/8) and blue (5B-8/8). As the classroom color, similarly they like better cool colors (Figure 2).
- Color preferences as individually of the state school students are in order of blue (5B-8/8), green-yellow (5GY-9/10) and yellow (5Y-8/10). Although they mostly prefer cool colors having high value and chroma, on the contrary they have preferred like red, purple having low value and unsaturated colors. The subjects have tended warm color as the classroom color (Figure 3).

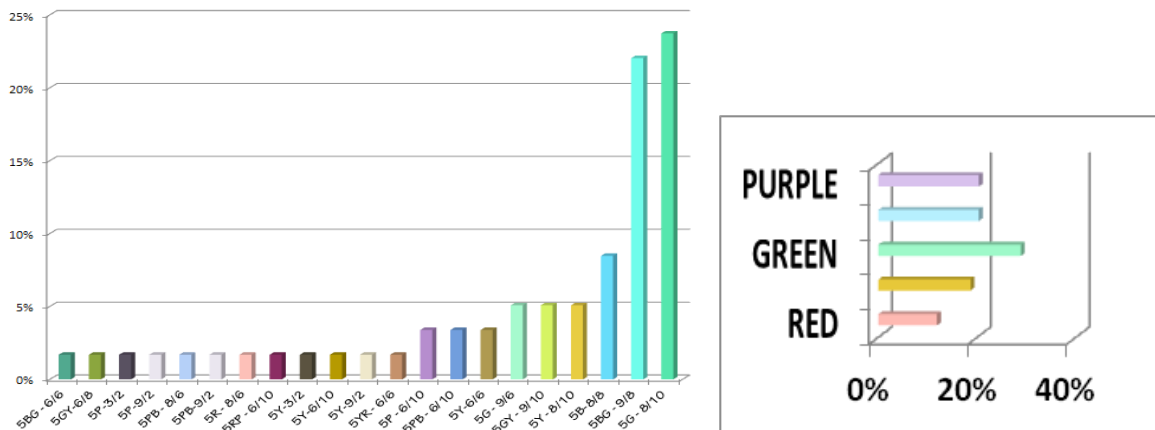

Figure 2: Private school individual and classroom color preferences (total).

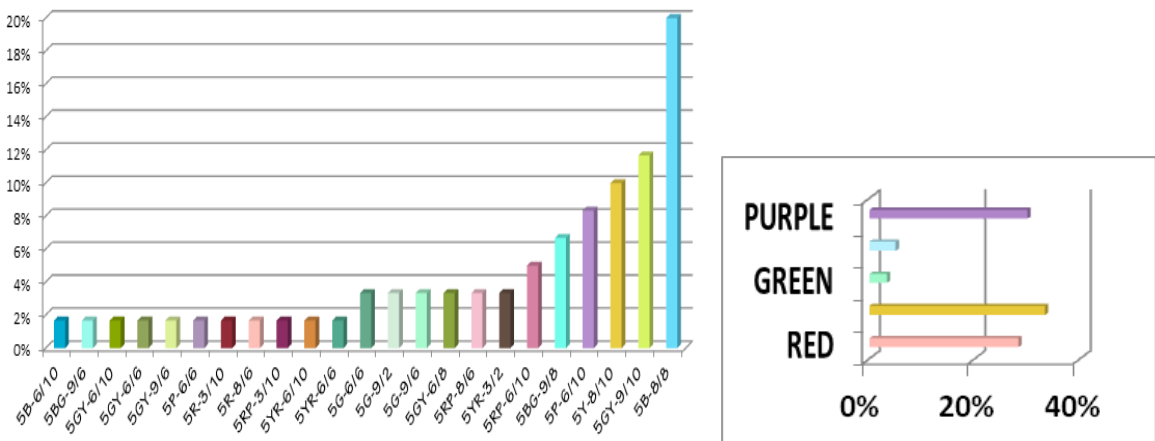













Figure 3: State school individual and classroom color preferences (total).

The first preferences on the individual and classroom color of private and state school students are given in Table 3 as female, male and total. There are different predilections for colors of the two school students. As a result, the findings of this preliminary research for children between the ages of 8-10 shows that gender, social, cultural and economic differences of children could affect to their individual and classroom color preferences.

Table 3: Distribution of the first preferences on the individual and classroom colors.

FIRST PREFERENCES (INDIVIDUAL COLORS)						FIRST PREFERENCES (CLASSROOM COLORS)					
PRIVATE SCHOOL			STATE SCHOOL			PRIVATE SCHOOL			STATE SCHOOL		
Female	Male	TOTAL	Female	Male	TOTAL	Female	Male	TOTAL	Female	Male	TOTAL
5BG-9/8	5G-8/10	5G-8/10	5P-6/10	5B-8/8	5B-8/8	Wall:5G-9/6 Floor:5G-6/2	Wall:5B-9/4 Floor:5B-6/2	Wall:5G-9/6 Floor:5G-6/2	Wall:5R-8/6, Floor:5R-6/10	Wall:5Y-8/10 Floor:5Y-6/6	Wall:5Y-8/10 Floor:5Y-6/6
Green-Blue	Green	Green	Purple	Blue	Blue	GREEN	BLUE	GREEN	RED	YELLOW	YELLOW
23%	31%	24%	13%	30%	20%	34%	30%	29%	47%	53%	33%
											

This study, as a part of a comprehensive research, which was started to examine the effects of physical environment on students and aimed to increase efficiency of education in places where the future generations are being educated, will be continued and extended to reveal the effects of classroom color on students' performance.

### REFERENCES

Baytin, C., and M. Kıran, 2005. Colour preferences in architectural design studios. *Architectural Science Review* 48(4):317-328.

DIALux 4.10.Ink, 2012. Available online, <http://www.dial.de//DIAL/en/dialux-international-download.html>. Accessed: January 18, 2012.

Kaya, N., 2004. Relationship between color and emotion: A study of college students. *College Student Journal* 38(3):396-406.

Küller, R., B. Mikellides, and J. Janssens, 2009. Color, arousal, and performance – A comparison of three experiments. *Color Research and Application* 34(2):141-152.

Kwallek, N., K. Soon, and C.M. Lewis, 2006. Work week productivity, visual complexity, and individual environmental sensitivity in three offices of different color interiors. *Color Research and Application* 32(2):130-143.

Luke, J.T., 1996. *The Munsell Color System a language for color*. New York: Fairchild Publication.

*Address: M.Sc Fazıla Duyan , Prof. Dr. Rengin Ünver,  
Unit of Building Physics, Faculty of Architecture,  
Yıldız Technical University, 34349, Beşiktaş-Istanbul, TURKEY.  
E-mails: faziladuyan@gmail.com, reenginunver@gmail.com*

# The Relation between Colorimetric Quantities of Three-Color Combinations and the Image Scales of “warm-cool” and “soft-hard”

Younjin LEE,<sup>1</sup> Mituo KOBAYASHI<sup>2</sup>

<sup>1</sup>Ewha Color Design Research Institute

<sup>2</sup>K Color Laboratory / Professor Emeritus, the University of Electro-Communications

## ABSTRACT

The purpose of this study is to find the relation between colorimetric quantities of three-color combinations and the axes of warm-cool and soft-hard on the color image scale. The colorimetric quantities were calculated from CIELAB values of three constituents of a combination. These values are the mean of lightness, the mean of chroma, and the centroid of the color quality, as well as the differences in lightness, the differences in chroma, and the differences in color qualities. A multiple regression analysis was performed to find the relation of these quantities with the image scales. As a result, the warm-cool image has the strongest relation with the centroid of the color quality. When becomes larger, the image of color combinations becomes warmer, while becomes smaller the image becomes cooler. On the other hand, the soft-hard image has the strongest relation with the mean of lightness. When becomes larger, the image becomes more soft.

## 1. INTRODUCTION

If an impression of a color combination can be described by colorimetric quantities of the combination, it will be useful both for color design and for color analysis. For two-color combinations, some studies clarified the relationship between the impression and colorimetric quantities of the combinations (Ou et al 2004, Lee et al 2010). For the combinations with three colors or more, a practical color image space, with the axes of “warm-cool” and “soft-hard,” was proposed by S. Kobayashi (1981). However, a relationship of these axes with colorimetric quantities was not defined, as the scales were obtained from a factor analysis of data. The purpose of this study is to find the relation between colorimetric quantities of three-color combinations and the axes of warm-cool and soft-hard described above.

## 2. METHOD

### 2.1 Color Stimuli

390 pieces of three-color combination samples representing various images were selected from the color image scale of the paper published by Kobayashi (1990). These samples are generated by 130 colors, which were sampled systematically from CIELAB color space. These colors are consisted of 120 chromatic colors and 10 achromatic colors. The chromatic colors were made up of 10 hues: R, YR, Y, GY, G, BG, B, PB, P, RP, as shown in Figure 1a; each hue are consisted of 12 tones, as shown in Figure 1b.

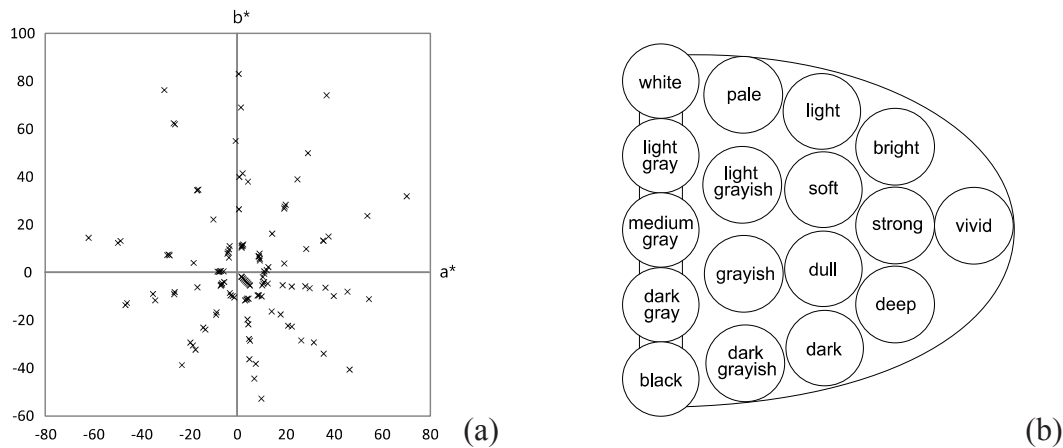

Figure 1: 130 color samples in the CIELAB color space (a) and the equal-hue plane (b).

## 2.2 Colorimetry of three-color combinations

Colorimetry was performed on the three-color combination samples, obtained according to Kobayashi (1990), in order to determine the colorimetric quantities representing three-color combination. The  $L^*a^*b^*$  values converted from the Munsell value of the 130 colors presented in Kobayashi (1990) were compared with actual measured values in order to investigate the extent of color reproduction by the printed three-color combination samples. The results indicated that the color difference  $\Delta E^*$  for the colors were in the range of 3.9 to 8.7. This range indicates that the colors can be treated as being identical for printing and is similar to the level of color difference tolerance generally dealt by color control.

In order to investigate the distribution of the 390 combination samples on the color image scale proposed by Kobayashi (1981), the samples were plotted on the coordinates at locations where they matched their respective imaging expressions, as shown in Figure 2. The distribution of the hue and tone of the 390 samples roughly matched the distribution of the combination proposed by Kobayashi (1981), primarily around the “warm-cool” and “soft-hard” axes.

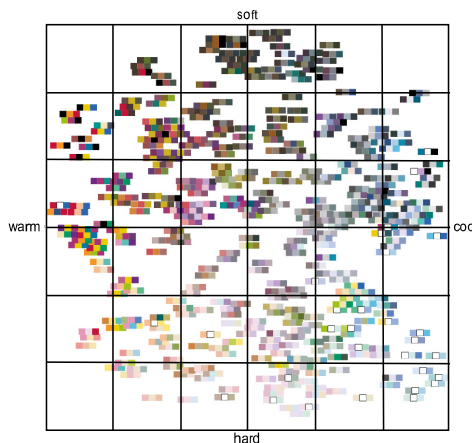

Figure 2: 390 three-color combinations in the Kobayashi's Color Image Scale.

## 2.3 Calculation of colorimetric quantities

The following quantities were calculated from the CIELAB values for each color ( $L^*a^*b^*$ ,  $i=1,2,3$ ) that constitute the three-color combination, as representative colorimetric quantities for combinations.  $\bar{L}^*$ ,  $\bar{a}^*$ ,  $\bar{b}^*$ , and  $\bar{\Delta E}^*$  was calculated as the centroid of the color for the constituent colors of combination.

$$\begin{aligned} \bar{L}^* &= (1/3)\Sigma_i L_i^* & \bar{C}^* &= (1/3)\Sigma_i C_i^* & \widehat{a}^* &= (1/3)\Sigma_i a_i^* & \widehat{b}^* &= (1/3)\Sigma_i b_i^* \\ \bar{C}^* &= \sqrt{(\widehat{a}^{*2} + \widehat{b}^{*2})} & \widehat{h} &= \tan^{-1}(\widehat{b}^*/\widehat{a}^*) \end{aligned} \quad (1)$$

where i is 1, 2, 3.  $\Delta L^*$ ,  $\Delta C^*$ ,  $\Delta T$ , along with red and green color difference  $\Delta a^*$ , yellow and blue color difference  $\Delta b^*$ , hue difference  $\Delta E_{hue}^*$ , as well as color quality difference  $\Delta H^*$  were calculated in order to determine color differences of constituent colors. The overall color difference  $\Delta E^*$  of the three-color combination was then calculated.

$$\begin{aligned} \Delta L^* &= \sqrt{\{(1/3)\Sigma_{ij} \Delta L_{ij}^{*2}\}} & \Delta C^* &= \sqrt{\{(1/3)\Sigma_{ij} \Delta C_{ij}^{*2}\}} & \Delta T &= \sqrt{(\Delta L^{*2} + \Delta C^{*2})} \\ \Delta a^* &= \sqrt{\{(1/3)\Sigma_{ij} \Delta a_{ij}^{*2}\}} & \Delta b^* &= \sqrt{\{(1/3)\Sigma_{ij} \Delta b_{ij}^{*2}\}} & \Delta E_{hue}^* &= \sqrt{(\Delta a^{*2} + \Delta b^{*2})} \\ \Delta H^* &= \sqrt{(\Delta E_{hue}^{*2} - \Delta C^{*2})} & \Delta E^* &= \sqrt{(\Delta L^{*2} + \Delta E_{hue}^{*2})} \end{aligned} \quad (2)$$

where (i, j) is (1, 2), (2, 3), (3, 1).

### 3. RESULTS AND DISCUSSION

Multiple regression analysis was performed by using the colorimetric quantities calculated in the previous section as explanatory variables, in order to investigate the relationship between the colorimetric quantities representing the three-color combination and the color image scale. The objective variables are coordinate values for “warm-cool” and “soft-hard”. The results of the analysis revealed that the relationship of the centroid of the color quality  $\widehat{a}^*$  had the closest relationship with the “warm-cool” image, in relation to the three-color combination, whereas the mean of lightness  $\bar{L}^*$  had the closest relationship with the “soft-hard” image. The multiple correlation coefficients were  $R = .87$  and  $R = .92$  for “warm-cool” and “soft-hard”, respectively, confirming the superior compatibility of the regression expression.

Although the explanatory variable described above incorporates all variables with the potential to become an explanatory variable for multiple regressions, not all of these are independent. Therefore, only eight variable quantities of the mean of lightness  $\bar{L}^*$ , the mean of chroma  $\bar{C}^*$ , the centroid of the color quality  $\widehat{a}^*$ ,  $\widehat{b}^*$ , the differences in lightness  $\Delta L^*$ , the differences in chroma  $\Delta C^*$ , and the differences in color qualities  $\Delta a^*$ ,  $\Delta b^*$  were used to perform multiple regression analysis. These quantities have dimensionality of distance in the CIELAB uniform color space. As with the above described results, these results also confirmed that  $\widehat{a}^*$  had the most impact on “warm-cool”, whereas  $\bar{L}^*$  had the most impact on “soft-hard”. Then, not only  $\widehat{a}^*$ , “warm-cool” is affected  $\widehat{b}^*$ , and like the differences in color qualities  $\Delta a^*$ . The multiple correlation coefficients were  $R = .86$  and  $R = .91$ , indicating that the multiple regression for “warm-cool” and “soft-hard” were likely to be as described below:

$$\begin{aligned} y_{wc} &= 0.239 - 0.063\widehat{a}^* - 0.049\widehat{b}^* - 0.049\Delta a^* + 0.034\bar{C}^* - 0.021\Delta b^* + 0.015\Delta L^* \\ &\quad + 0.013\Delta C^* \end{aligned} \quad R = .86 \quad (3)$$

$$y_{sh} = -6.004 + 0.095\bar{L}^* + 0.020\Delta a^* - 0.017\Delta L^* \quad R = .91 \quad (4)$$

However, the process is a slightly complicated task to perform, since there are many explanatory variables in Equations (3) and (4). An attempt was made to reduce the number of explanatory variables by referencing the degree of contribution by the standard regression coefficients to multiple regression equations. This was done based on the F-values and t-values obtained when examining the compatibility of the regression equations and the utility of regression coefficients, in order to prepare a set of multiple regression equations to predict the “warm-cool” and “soft-hard” images for the three-color combinations with minimum number of explanatory variables. Thus, new multiple regression equations (5) and (6) for “warm-cool” and “soft-hard” were obtained.

$$y_{wc} = 0.926 - 0.065\widehat{a^*} - 0.047\widehat{b^*} - 0.035\Delta a^* \quad R = .84 \quad (5)$$

$$y_{sh} = -6.393 + 0.096\overline{L^*} + 0.022\Delta a^* \quad R = .91 \quad (6)$$

The warm-cool image has the strongest relation with  $\widehat{a^*}$ . When  $\widehat{a^*}$  becomes larger, the image of color combinations becomes warmer, while  $\widehat{a^*}$  becomes smaller the image becomes cooler. On the other hand, the soft-hard image has the strongest relation with the mean of lightness. When  $\overline{L^*}$  becomes larger, the image becomes more soft.

#### 4. CONCLUSIONS

The conclusions are summarized as follows:

1. The representative colorimetric quantities for three-color combinations are the mean of lightness  $\overline{L^*}$ , the mean of chroma  $\overline{C^*}$ , and the centroid of the color quality  $\widehat{a^*}$ ,  $\widehat{b^*}$ , as well as the differences in lightness  $\Delta L^*$ , the differences in chroma  $\Delta C^*$ , and the differences in color qualities  $\Delta a^*$ ,  $\Delta b^*$ .
2. The result of the multiple regression analysis provided two regression equations. The expression (5) relates to warm-cool and the expression (6) relates to soft-hard.
3. The warm-cool image has the strongest relation with the centroid of the color quality  $\widehat{a^*}$ , on the other hand, the soft-hard image has the strongest relation with the mean of lightness  $\overline{L^*}$ .

#### REFERENCES

- Ou, L.-C., M.R. Luo, A. Woodcock, and A. Wright, 2004. A Study of Colour Emotion and Colour Preference. Part 2: Colour Emotions for Two-Colour Combinations, *Color Research and Application* 31(3) 292-298.
- Lee, Y., M. Kobayashi, and H. Sobagaki, 2010. Relation between “Beauty” and Metric Perceived Quantities of Two-Color Combinations, *Journal of the Color Science Association of Japan* 34(2) 131-142.
- Kobayashi, S., 1981. The Aim and Method of the Color Image Scale, *Color Research and Application* 6(2) 93-107.
- Kobayashi, S., 1990. *Color image scale*, Kodansha international Japan.

Address: Dr. Younjin Lee, Ewha Color Design Research Institute,  
120-750, 52, Ewhayeodae-gil, Seodaemun-gu, Seoul, Korea  
E-mails: hacomamajini@yahoo.co.jp, k-color@jupiter.ocn.ne.jp



# Complementary Colour Harmony in Different Colour Spaces

Forough MAHYAR,<sup>1</sup> Stephen WESTLAND,<sup>2</sup> Vien CHEUNG<sup>2</sup>

<sup>1</sup> Department of Color Image Processing, Institute for Color, Science and Technology

<sup>2</sup> School of Design, University of Leeds

## ABSTRACT

This research investigates hue complementarity in different colour spaces namely CIELAB, CIELUV, Kuehni LAB, OSA-UCS, and Hunter  $Rd_{ab}$  colour spaces. A psychophysical experiment has determined the hue of colours that are deemed complementary to twenty standard fixed hues. The data were then analysed in CIELAB space and the other applied ones to explore in which colour space opposite hues best describe visual complementary relationships. In each space the opposite hues were calculated as 180 degrees from the standard fixed hues and compared with the psychophysically derived complementary hues. The results show that none of the five colour spaces can exactly predict complementary relationships; however, OSA-UCS colour space performed better than the other four colour spaces. For OSA-UCS colour space, apart from a few hues, each complementary hue was within  $1.0 \pm 4.5$  degrees of the opposite hue. The computations were carried out under CIE illuminant D65 and for the 1964 standard observer. Previous investigations (Mahyar et al. 2011) was carried out in the other colour spaces, namely CIELAB, Munsell and Kuehnie LAB, under different conditions of CIE illuminant C and 1931 standard observer. Psychophysical experiment in CIELAB colour space were presented at a previous AIC meeting (Mahyar et al. 2007).

## 1. INTRODUCTION

Complementarity in different colour spaces has been already examined under CIE illuminant C and 1931 standard observer condition among three colour spaces by the authors (Mahyar et al. 2011). This research is a trail of the previous work on hue complementarity in order to introduce any possible colour space which can represent complementary hue relationship, as well as finding any possible distortion from the opposite colours in the complementary hue relationship in each colour wheel.

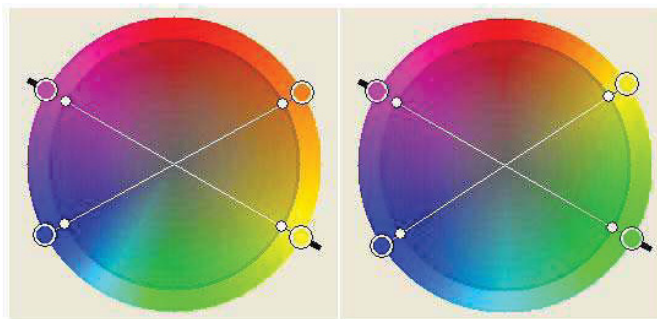

Figure 1: Colorant mixing (left) and visual (right) colour wheels show inconsistent complementary relationships (reproduced from Pacific-Business-Centre 2010).

The idea of this work originally comes from the fact that there is a lack of consistency in introducing the complementary hues if different colour wheels are considered. For example, as shown in Figure 1, in colour wheels that represent colorant mixing, yellow is placed op-

posite to purple and orange is placed opposite to blue. In colour wheels that represent visual relationships, on the other hand, yellow is placed opposite to blue and green is placed opposite to purple.

2. EXPERIMENTAL

A psychophysical experiment was performed in CIELAB colour wheel in constant lightness and chroma values. Figure 2 shows a screenshot of the display during the experiment. Observers were asked to find a maximally contrasted combinations of colours as a total of twenty colour pairs. The details of the experiment has been published in the previous work of the authors (Mahyar et al. 2007).

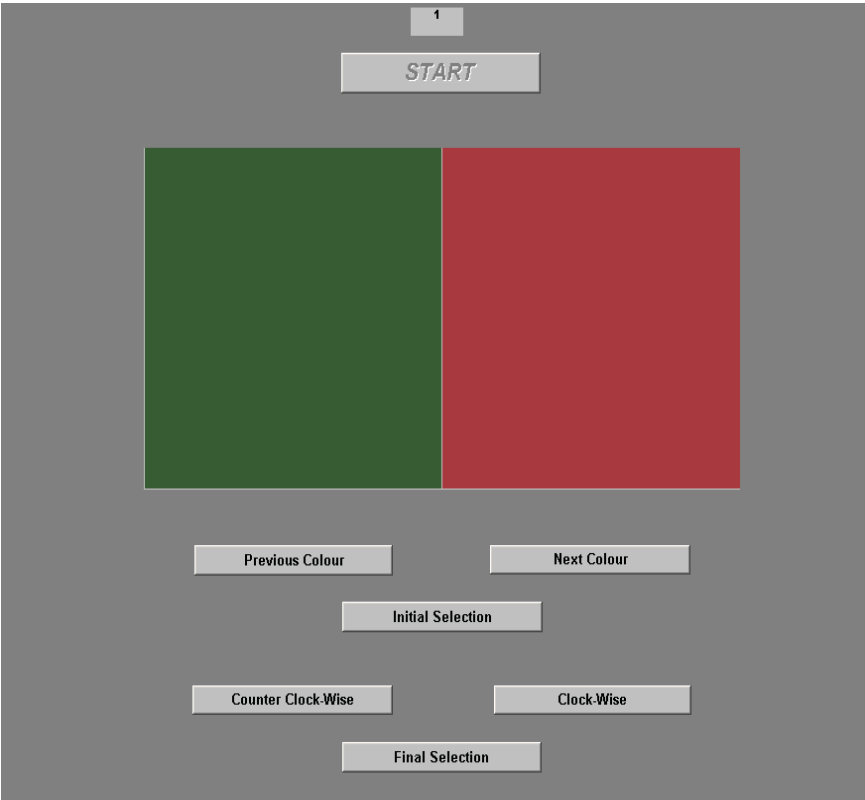

Figure 2: A screenshot of the psychophysical experiment.

3. RESULTS AND DISCUSSION

The results of the psychophysical experiment, in which complementary colour harmony in CIELAB colour space was investigated, were transformed into the corresponding values in other colour spaces. As mentioned earlier, CIELUV, Kuehni LAB, OSA-UCS, and Hunter Rdab colour spaces were considered in this research. Obviously, opposite hues are located in 180 degrees interval of each fixed hue. The angle differences between each complementary hue and the relevant opposite hue ( $\Delta h$ ) were calculated too. In each fixed hue, the average of all selected complementary hues ( $h_{ave}$ ), by the observers, and the hue angle of the opposite colour ( $h_{opp}$ ) are calculated. Equation 1 calculates the  $\Delta h$  values in each colour space.

$$\Delta h = h_{ave} - h_{opp} \tag{1}$$

Figure 3 compares the  $\Delta h$  values in different colour spaces where all the twenty fixed hues were displayed. The fixed hues alter clockwise from yellow to red, blue and green in the figure. The numbers of one to twenty in the figure show the number coding for all the fixed hues. For instance, number 1 shows the fixed hue of 90 degrees in the CIELAB colour wheel which is a yellow colour. It is notable to mention that due to the fact that each fixed hue in CIELAB colour space were converted to the appropriate values in the other colour space, each number of the fixed hues in the figure demonstrates various fixed hue angles in different colour spaces. The values of the hue angle differences (see Equation 1 for  $\Delta h$ ) between each opposite hue and the hue which was chosen as the maximally contrasted hue with the fixed hue by the observers are illustrated in the figure. The black circle shows the  $\Delta h$  equal to zero, that obtained when the observers select the opposite hues as maximally contrasted hues of each fixed hue. As seen in Figure 3, there is possibly no colour space, among investigated colour spaces, which can define a regulation between complementary relationships and the opposite hues for all hues around the colour wheel.

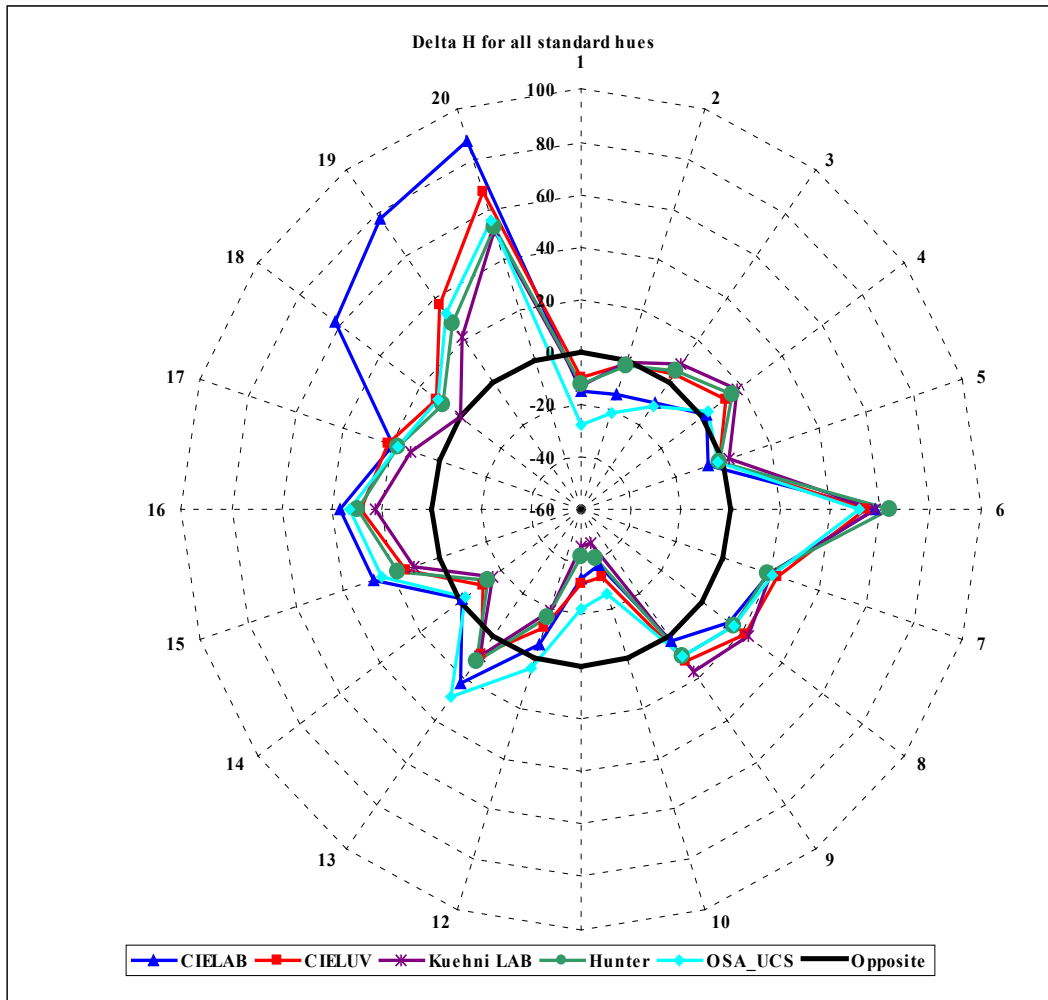

Figure 3: Hue differences between each opposite hue and maximally contrasted hue.

The intervals between the complementary and the opposite hue angles of each fixed hue indicate as ‘Interval’, which is ‘average of  $\Delta h$  values  $\pm$  standard error’. Table 1 shows the Interval values in all five applied colour spaces.

Table 1: Measured intervals between complementary and opposite hues.

Colour Space	Interval values
CIELAB	3.9±4.07
CIELUV	7.64±3.32
Kuehni LAB	6.86±3.45
OSA-UCS	7.74±3.5
Hunter Rd <sub>ab</sub>	1.04±4.54

There seems to get no good agreement between the complementary and the opposite hues in CIELAB colour space. OSA-UCS colour space shows better agreement between the complementary and the opposite hues in comparison to the other colour spaces. In fact, in OSA-UCS colour space the average of Delta H values is almost 1 degree.

#### 4. CONCLUSIONS

Five colour spaces, namely, CIELAB, CIELUV, Kuehni LAB, OSA-UCS, and Hunter Rd<sub>ab</sub>, were applied to study complementary relationships between hues. Comparison among the colour spaces show that OSA-UCS colour space is better than the other colour spaces in order to find an agreement between complementary and opposite relationships. Apart from a few colours in the colour wheel, each complementary colour looks to be in interval of 1.04±4.5 degrees under CIE Illuminant D65 and the 1964 standard observer conditions.

#### ACKNOWLEDGEMENTS

The authors would like to thank all observers who participated in the experiment.

#### REFERENCES

- Mahyar, F., V. Cheung, S. Westland and P. Henry 2007. Investigation of Complementary Colour Harmony in CIELAB Colour Space, *Proceedings of the AIC Midterm Meeting*, 82-85.
- Mahyar, F., S. Westland and V. Cheung 2011. Complementarity in Different Colour Spaces, *Proceedings of the Fourth International Color and Coating Congress*, A-10-85-1.
- Pacific-Business-Centre, 2010 Color Wheel Pro – See Color Theory in Action, Colour-Theory-Basics, QSX Software Group.

*Address: Dr Forough Mahyar, Department of Color Image Processing,  
Color Physics Centre, Institute for Color, Science and Technology,  
Tehran, Iran, 1668814811*

*E-mails: mahyar-fo@icrc.ac.ir, s.westland@leeds.ac.uk, t.l.v.cheung@leeds.ac.uk*

# Catching the Aesthetic Dimension: On Aesthetic Experience of Colour and Light

UIF KLARÉN

Colour & Light Research Group, Konstfack – University College of Arts,  
Crafts and Design, Stockholm, Sweden

## ABSTRACT

This paper springs from a project about concept formation in the field of colour and light. It is based on own reflections and on scientific and scholarly references. It is an attempt to describe a conceptual approach to aesthetic experiences of colour and light relating them to different levels of experience: categorical perception, direct experience and indirect – cultural – experience. Art and design have a special and complex relation to the different levels of experience. Artistic works can serve as "models" or "examples" – indirect experiences – for how we may attend to light and colour in our direct approach to the world. They are also, as appearances, direct experiences. The emotional content we can experience in a piece of art or a designed object is symbolic in a special way; perceptual patterns of colour, light and form, abstracted from their normal context in life, can be used as symbols for felt life in pieces of art and in designed objects. What we are used to calling *formal aesthetics* belongs primarily to the categorical – basic – perception. Adopting a reflective attitude we consciously attend to this perceptual process of understanding and open up for reflection on experiences as such.

## 1. BACKGROUND

The overall spatial impression of colour and light is an intuitive summary of current perceptions in a context of all experiences we have through living contact with the world. The American philosopher Susanne K Langer calls attention to the fact that the word intuitive is often used in a confused way; intuition is supposed to be "without reasoning" and without "benefit of logic" which ends in "mysticism, mixed with every degree of philosophical irrationalism – and sheer sentimentality and romantic fancies" (Langer 1957: 60). Just the other way round and relating to John Locke she claims that there is "no possible conflict between intuition and discursive reason" (Ibid: 66). Intuition is the fundamental intellectual activity, which produces logical or semantic understanding. It comprises all acts of insight or recognition of formal properties, of relations, of significance, and of abstraction and exemplification. "Intuitions are neither 'true' nor 'false', but simply present" (Ibid).

The basic – categorical – perception of colour and light gives spatial and temporal structure to the surrounding reality. The experience of stability and coherence of the world is fundamental; there is a tight perceptual attunement between human beings and the world around. The experienced world is in ecological balance with the human environment, and the perceptual relation between the outer world and the human inner world is without hindrance (Noë 2004: 156).

By direct experience we gradually learn through living to understand the relations of colour and light to the world around. The direct experience is dynamic and simultaneous; perceptions, feelings and emotions form a coherent whole. Making use of natural perceptual abilities (the categorical perception) and interplaying with the physical world we develop

perceptual “skills”; we acquire abilities to catch the spatial significance of colour and light in space.

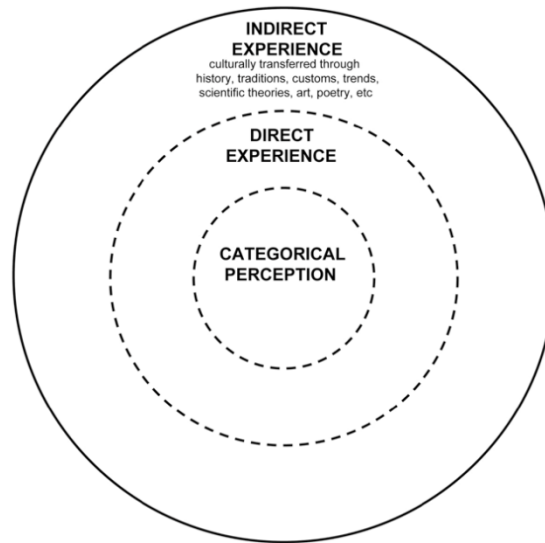

Figure 1: The graphic model shows levels of experience - from experiences based on categorical perception through direct experience of the world around to the indirect experience imbedded in cultural expressions (Klarén 2012).

Experiencing colour and light in a living context always implies an intuitive and emotional understanding: we experience spontaneously spatial relations, the atmosphere of a room or the tone of an object. And our experience of the world around is always influenced by indirect experience – cultural values and knowledge.

The three experience levels (figure 1) – The categorical – basic – perception, the direct experience and the indirect – cultural – experience are interdependent and implicitly present in all perceptions (Klarén 2012). This is how our overall perception normally works.

## 2. AESTHETIC EXPERIENCE

Art and design have a special and complex relation to direct and indirect experience. On the one hand artistic works can serve as “models” or “examples” for how we may attend to light and colour in our direct approach to the world. On the other hand they are also, as appearances, direct experiences. The aesthetic dimensions in art and design are, depending on aspect, both direct and indirect experiences. Langer says that “in one way, all good art is abstract, and in another way it is concrete” (Langer 1957: 69).

### 2.1 Aesthetic attention

Maurice Merleau-Ponty (2002: 355) discusses how we approach the surrounding world in different ways depending on situation. He makes a distinction between two modes of attention: *living perception* and *the reflective attitude*. In living perception colour and light are manifested to us in the totality of spatial relations; this is the everyday way of attending to colour and light.

Experience of the world makes it possible to think about it; we would not know what the world is like without experience. In living perception the perceptual qualities are mostly transparent; our attention is on the objects and spaces of the outer world. Adopting an re-

flective attitude, however, we consciously attend to our spontaneous perceptual process of understanding; attending to aesthetic qualities in art and design – or in the world around – means that we open up for reflection on experiences as such; what we attend to is the perceptual qualities, not the physical thing. We “abstract its appearance from its material existence” (Langer 1953: 47).

## 2.2 The expressive symbol

Gottlieb Baumgarten, originator of Aesthetics as a specific academic discipline, describes knowledge that implies coherent intuitive understanding and is given directly by sense experiences (Baumgarten 1983, p 80). Aesthetics is not concerned exclusively with art. Aesthetics is an epistemology, and aesthetic experience is an aspect of our natural approach to the world.

Langer’s aesthetic philosophy is a part of the epistemological tradition from Baumgarten. Connecting to Wittgenstein she asks, how do we give symbolic form to the tacit dimension of our direct experience? She claims that the emotional content we can experience in a piece of art or a designed object is symbolic in a special way (Langer 1957: 60); perceptual patterns of colour, light and form, abstracted from their normal context in life, can be used as symbols for felt life in pieces of art and in designed objects. Langer calls them logical expressive – or articulated – symbols (Langer 1953: 31).

Wittgenstein says that feelings follow experience of a piece of music, just as they follow courses in life (Wittgenstein 1993: 19); a piece of music consists of a sequence of tones. It has a structural resemblance to courses in life – a rhythm, pauses and breaks, pitches, etc. – and thus they can be used as examples. The auditory structure in music is not a course of life, but felt life abstracted in a logical expressive symbol. The same is true for all sensory experiences.

The direct visual experiences of the surrounding world give emotional content to logical colour and light combinations in the real world. Thus a certain colour combination, a light arrangement or an articulated space can act as a logical expressive symbol. The logical expressive symbols are what we may call the artistic or aesthetic dimension in pictures, in utility goods, in architecture – in the surrounding world (Langer 1953: 31, 51-52).

The logical expressive symbols occur in the borderland between direct and indirect experience. What we are used to calling “expression” in an articulated object or space is perceived as a direct experience, but without being separated from its symbol. Encountering articulated patterns in pictorial art, object design, in interior design or architecture, our perceptual answer is first of all intuitive recognition, not interpretation of meaning.

Expressive symbols are not about abstract signs with associated or conventional meanings. According to Langer they are objectified feelings based on visual experience that can only be communicated by significant patterns of perceived qualities.

## 2.3 Formal aesthetics

Perceiving colour distinctions and colour similarities are basic to colour perception. If, for example, in a colour combination, the colours have the same whiteness, blackness, chromaticness, hue or lightness, we can sense that these colours have something in common. We are used to saying that colours in such colour combinations fit together or harmonize or that the colours of a painting or a room hold together. This experienced unity of colours, however, has nothing to do with preferences. It follows from the visual system itself: the ability to

recognize colour distinctions and colour similarities is part of the categorical perception and is therefore predetermined. It is natural in the same sense as recognition of characteristic colour scales in perceptive colour systems. This hidden perceptual order is implicit in all transformations we experience as we move around the environment. It serves in the business of survival and allows the organism to discover deviations. Used in the context of art and design this is what usually is referred to as *formal aesthetics*.

A conscious or unconscious infraction of given perceptual rules will always be related to them and be regarded as a deviation from normality. Thus it is quite possible to deviate from them, but not to question or avoid them. In artistic tradition there is great consciousness of such perceptual prerequisites.

These basic experiences can, however, never be perceptually isolated. They are always part of the coherent experience of the world and thus always related to the dynamic direct experience and the indirect cultural context.

### 3. CONCLUSIONS

The aesthetic experiences have their origin in a reflective attitude aroused by recognition of and attention to logical expressive symbols (direct and indirect experience) and basic perceptual order (categorical perception and indirect experience). The qualities and the meanings that make up aesthetic patterns and expressive symbols cannot be examined separately without something essential being lost. The relations of aesthetic experiences to different levels of experience could, however, be described with the aesthetic coherence intact and make possible a communication and an analysis of the aesthetic dimension of colour and light.

### REFERENCES

- Baumgarten, G., 1983 [1739]. *Texte zur Grundlegung der Ästhetik* edited by H. R. Schweizer. Hamburg: Meiner.
- Langer, S.K., 1957. *Problems of Art: ten philosophical lectures*. New York: The Scribner library.
- Langer, S.K., 1953. *Feeling and Form*. London: Routledge & Keagan.
- Klarén, U., 2012. Natural Experiences and Physical Abstractions – On epistemology of colour and light. In *Colour and Light – Concepts and confusions* edited by H. Arnkil. Helsinki: Aalto University / Konstfack, SYN-TES
- Merleau-Ponty, M., 2002 [1962]. *The Phenomenology of Perception*. New York: Routledge.
- Noë, A., 2004. *Action in Perception*. Cambridge: The MIT Press.

*Address: Ulf Klarén, Colour&Light Research Group,  
Konstfack – Univ. College of Arts, Crafts and Design,  
P.O. Box 3601, S-126 27 Stockholm, Sweden  
E-mail: ulf.klaren@konstfack.se*



# Color: A Crucial Factor for Aesthetic Quality Assessment in a Subjective Dataset of Paintings

Seyed Ali AMIRSHAHI,<sup>1,2</sup> Gregor Uwe HAYN-LEICHSENRING,<sup>2</sup>  
Joachim DENZLER,<sup>1</sup> Christoph REDIES<sup>2</sup>

<sup>1</sup> Chair of Digital Image Processing, Department of Computer Science,  
Friedrich Schiller University, Jena, Germany

<sup>2</sup> Experimental Aesthetics Group, Institute of Anatomy I,  
University of Jena School of Medicine, Jena University Hospital, Jena, Germany

## ABSTRACT

Computational aesthetics is an emerging field of research which has attracted different research groups in the last few years. In this field, one of the main approaches to evaluate the aesthetic quality of paintings and photographs is a feature-based approach. Among the different features proposed to reach this goal, color plays an important role. In this paper, we introduce a novel dataset that consists of paintings of Western provenance from 36 well-known painters from the 15<sup>th</sup> to the 20<sup>th</sup> century. As a first step and to assess this dataset, using a classifier, we investigate the correlation between the subjective scores and two widely used features that are related to color perception and in different aesthetic quality assessment approaches. Results show a classification rate of up to 73% between the color features and the subjective scores.

## 1. INTRODUCTION

For centuries, philosophers and psychologists along with art critics have tried to find the bases of aesthetic judgment. In recent years, a new field of research named computational aesthetics has emerged (Amirshahi et al. 2012, Datta et al. 2006, Li and Chen 2009, Redies et al. 2012, Yanulevskaya et al. 2012). In this field, different research groups have tried to use computational techniques to identify image properties, which can be related to the aesthetic perception of a painting or a photograph. In this paper, we address two issues that are related to this field of research, i.e. subjective databases and color.

First, the availability of different photo-sharing websites allows researchers to have access to a huge number of high-quality photographs along with their subjectively rated aesthetic scores (Datta et al. 2006). Due to different copyright restrictions, no subjective database of aesthetic paintings is publically available. This prevents different metrics from being compared to one another. To the best of our knowledge, the only subjective dataset of aesthetic paintings which is intended for public use is the MART dataset (Yanulevskaya et al. 2012), which is limited to abstract paintings and, till now, has not been released to the public. In the present paper, we introduce a new subjective dataset of aesthetic paintings, which can be downloaded from the webpage dedicated to this dataset<sup>1</sup>. The paintings were originally included in the Yorck Project<sup>2</sup> or the Google Art Project<sup>3</sup> and were made available to the general public through the Wikimedia Commons website. In the present work, the paintings from the dataset were evaluated by non-expert observers to gather subjective scores on how beautiful they are.

1 [http://www.inf-cv.uni-jena.de/en/subjective\\_aesthetic\\_dataset](http://www.inf-cv.uni-jena.de/en/subjective_aesthetic_dataset)

2 [http://commons.wikimedia.org/wiki/Category:PD-Art\\_\(Yorck\\_Project\)](http://commons.wikimedia.org/wiki/Category:PD-Art_(Yorck_Project))

3 <http://www.googleartproject.com>

Second, it is a well-known fact that color plays an important role in an observer's aesthetic judgment. Different research has been carried out with regard to the role of color in aesthetic perception, based on general perceptual mechanisms as well as aesthetic quality assessment of paintings and photographs (Palmer et al. 2013). To study the relation between simple color features and subjective preferences for paintings, we focus on two color related features, color quantization and mean value for each color channel in the Lab color space. These measures have been previously associated with the aesthetic quality of paintings and photographs (Datta et al. 2006, Li and Chen 2009, Yanulevskaya et al. 2012).

In the next section, we will introduce the dataset. Section 3 is dedicated to evaluating the correlation between the color features and subjective scores. Finally, Section 4 gives a conclusion on the paper.

## 2. DESCRIPTION OF THE SUBJECTIVE DATASET

### 2.1 Collecting the Images

In the last few years, the Wikimedia Commons platform has provided users with high-quality digital reproductions of paintings, for which copyright has expired. From this database, we downloaded a dataset of 281 high-quality color paintings from 36 different artists. Careful attention was taken so that the downloaded images covered a wide variety of subject matters such as abstract, nearly abstract, landscapes, scenes with person(s), still life, flowers or vegetation, animals, seascape, port or coast, sky, portrait (one person), portrait (many person), nudes, urban scene, building, and interior scenes. The paintings are presumed to be of high aesthetic quality because they are works of well-known painters famous for their highly artistic skills. The webpage dedicated to this dataset<sup>1</sup> provides more information regarding the subject matters and art styles in this dataset as well as results of applying other aesthetic measures to this dataset.

### 2.1 Subjective Test

To collect the subjective scores, 49 participants (age: 19 to 44 years,  $M = 22.7$  years, 13 males) were recruited. Most of the subjects were students, in particular of medicine or natural sciences. All of the participants declared having normal or corrected-to-normal visual acuity and gave their written informed consent after getting an explanation of the procedures. The study follows the ethical guidelines of the Declaration of Helsinki and was passed by the ethics committee of Jena University Hospital.

The downloaded pictures were resized to 2048 pixels on the longest side and no image enhancement algorithms were applied. In the experiment, images were shown separately and in a random way on a calibrated black screen (EIZO Color Edge CG241W). The size of the images on the screen was  $165 \times 165$  mm. A chin rest assured a uniform viewing distance of 90 cm. The experiment was performed using Matlab R2008A. Prior to showing each picture, a question mark was presented (500 ms), followed by the image itself (600 ms) and a black screen (1900 ms). In that last phase, the participants were asked to respond by pressing one of four labelled keys. We asked the participants to rate the paintings on a scale from 1 (not beautiful) to 4 (very beautiful), according to how pleasant the picture appeared to them. The final score for each image was then calculated by averaging the scores collected from all observers. Figure 1 represents the 6 paintings with the highest and lowest average scores, respectively, along with a graph of the distribution of the ratings.

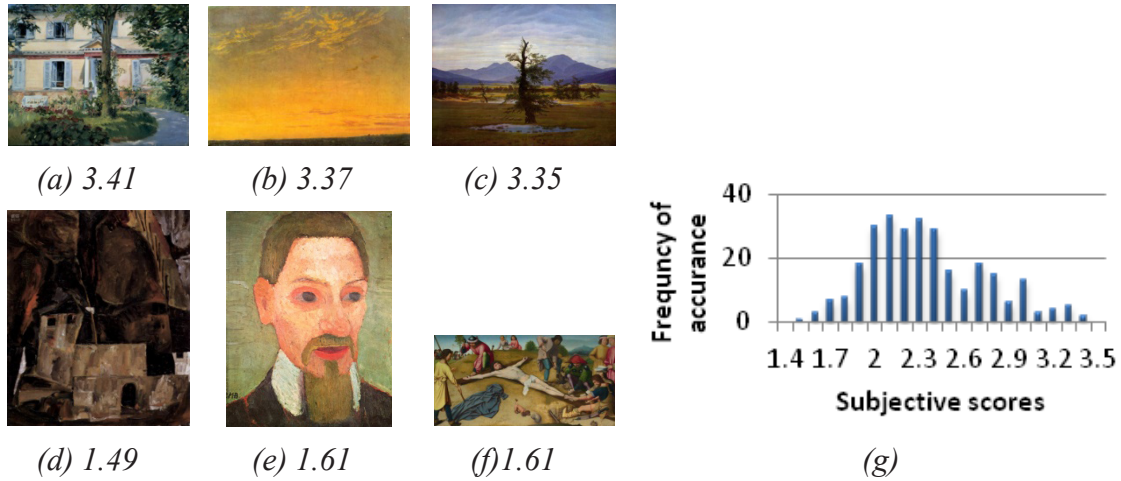

Figure 1: Images with the highest and lowest subjective scores along with the distribution of the rating scores. a) Manet, 1882, b) Friedrich, 1824, c) Friedrich, 1822, d) Schiele, 1911, e) Modersohn-Becker, 1906, f) David, 1481, g) Distribution of the rating scores.

### 3. RESULTS AND DISCUSSION

On average, observers tended to attribute lower aesthetic scores to paintings with brownish or dark colors while paintings with bluish and green colors received higher aesthetic scores. This finding is in agreement with the general color preferences described by Palmer and Schloss (2010). They showed that brownish and olive colors are more strongly disliked by Western adults, whereas blue and red colors are preferred by this group of observers.

To test whether simple color features can predict the aesthetic quality of a painting, two color features were extracted from the paintings, quantization of the color space into different colors and the overall mean values in different color channels in the Lab color space. These measures have previously been used in the work by Datta et al. (2006), Li and Chen (2009), and Yanulevskaya et al. (2012). In the present study, we quantized the Lab color space to 125 different colors (5 different levels for each color channel). This number was selected after testing different possible options. The images were then divided into two groups based on the subjective scores (paintings with high scores and low scores, respectively). To find the correlation between the subjective scores and the two mentioned color features, we trained an SVM classifier using 75% of the data and tested in on the remaining 25%. The two color features together resulted in a classification rate of 72.9% on average between five different cross-correlation image sets. Classification rates were 66.1% for the color quantization approach and 70.6% for the mean color feature alone.

### 4. CONCLUSION AND FUTURE WORKS

In this paper, we introduce a new subjective dataset of aesthetic paintings. As a first evaluation of this dataset, we find a high correlation between two previously used simple color features (color quantization and mean color value) and subjective beauty ratings of the paintings in the dataset. Results of the subjective score follow the pattern previously described by Palmer and Schloss (2010) with regard to liked and disliked colors. This result shows that, among different features used to evaluate the aesthetic quality of a painting or photograph, color plays a crucial role.

In future work, we will increase the number of images in our subjective dataset. Also, we will carry out a more in-depth analysis of the role of color in the aesthetic quality assessment of paintings by extracting other color features, for example features related to color harmony. Finally, we will combine multiple image features to extend the method of automatic aesthetic quality assessment of paintings (Li and Chen, 2009).

## REFERENCES

- Amirshahi, S.A., M. Koch, J. Denzler and C. Redies, 2012. PHOG analysis of self-similarity in aesthetic images. In *IS&T/SPIE Electronic Imaging, International Society for Optics and Photonics Proceedings*, 82911J-82911J.
- Datta, R., D. Joshi, J. Li and J. Wang, 2006. Studying aesthetics in photographic images using a computational approach. In *9th European Conference on Computer Vision—ECCV Proceedings*, 288-301.
- Li, C., and T. Chen, 2009. Aesthetic visual quality assessment of paintings. *IEEE Journal of Selected Topics in Signal Processing* 3 (2): 236-252.
- Palmer, S.E., and K.B. Schloss, 2010. An ecological valence theory of human color preference. In *National Academy of Sciences of the United States of America Proceedings*, 107 (19): 8877-8882.
- Palmer, S.E., K.B. Schloss and J. Sammartino, 2013. Visual aesthetics and human preference. *Annual Review of Psychology* 64: 77-107.
- Redies, C., S.A. Amirshahi, M. Koch and J. Denzler, 2012. PHOG-derived aesthetic measures applied to color photographs of artworks, natural scenes and objects. In *12th European Conference on Computer Vision-ECCV Proceedings*, 522-531.
- Yanulevskaya, V., J. Uijlings, E. Bruni, A. Sartori, E. Zamboni, F. Bacci, D. Melcher and N. Sebe, 2012. In the eye of the beholder: employing statistical analysis and eye tracking for analyzing abstract paintings. In *20th ACM International Conference on Multimedia Proceedings*, 349-358.

*Address: Seyed Ali Amirshahi, Computer Vision Group, Institute of Computer Vision  
University of Jena, Ernst-Abbe-Platz 2, D-07743, Jena, Germany  
E-mails: seyed-ali.amirshahi@uni-jena.de, gregorhaynleichenring@googlemail.com,  
joachim.denzler@uni-jena.de, redies@mti.uni-jena.de*

# Application of Autoassociative Artificial Neural Networks for Compression of Total Radiance Factor of Fluorescent Colorants

Marjan BARAKZEHI,<sup>1</sup> Seyed Hossein AMIRSHAHI,<sup>1</sup> Shahram PEYVANDI<sup>1,2</sup>

<sup>1</sup> Department of Textile Engineering, Amirkabir University of Technology (Tehran Polytechnic), No 424 Hafez Avenue, Tehran 15914, Iran

<sup>2</sup> Department of Psychology, Rutgers, The State University of New Jersey, Newark, New Jersey 07102, USA

## ABSTRACT

The nonlinear principal component analysis (NLPCA) technique is employed in order to reduce the spectral total radiance factor (TRF) of a set of 358 fluorescent samples. Two nonlinear versions of PCA, including the public domain version of Matlab code as well as those of autoassociative feedforward artificial neural networks (ANNs) are examined for the compression and reconstruction purposes. The classical PCA technique is also applied on the database. The TRFs spectra of samples are compressed in different dimensional spaces and the root mean square errors (RMS), the goodness-fitting coefficient (GFC) and the color difference values under D65 and A illuminants and CIE 1964 standard observer are calculated. Results show that both NLPCA Matlab code and the designed networks perform significantly better than the classical linear PCA particularly in the lower dimension of spectral space.

## 1. INTRODUCTION

The spectral data provide complete information about the visual attributes of surfaces but the large size of these data lead to some problems in data transformation and color measurements. Hence, it seems necessary to reduce the size of spectral data without serious loss of significant information of data structure. Principal Component Analysis (PCA) is a conventional technique in order to present data in lower dimensional subspaces through preserving the most important directions with the maximum variances. PCA was formulated on dimensionality reduction of the spectra and used for reconstruction of spectral data from the corresponding colorimetric tristimulus values (Fairman & Brill 2004). Recently, the spectral dimensionality of a set of fluorescent fabrics was studied in the visible spectrum by employing the classical PCA approach (Rayat *et al.*). It was proved that between 7 to 11 eigenvectors are required for satisfactory reduction and reconstruction while the number of basis vectors to reconstruct the spectra for non-fluorescent spectra was determined between 5 to 7 (Maloney 1986). The difference was explained by the fact that the total radiance factors of fluorescent samples are not as smooth as non-fluorescent ones due to the process of absorption and reemission that occurs.

Autoassociative feed-forward artificial neural networks (ANN) which reproduce network inputs at output layer in compressed type were also used for spectral reduction tasks. Usui *et al.* employed a five-layer neural network with sigmoidal transfer function in hidden layers to extract the nonlinear patterns of the Munsell chips (Usui *et al.* 1992). They compressed the spectral data of 1280 Munsell color chips into three dimensional subspace by using an autoassociative neural network which was consistent with the human visual system. Kramer interpreted the nonlinear component analysis (NLPCA) technique as an effective tool which

discovers the nonlinear features of data through the training of an autoassociative ANN (Kramer 1991). NLPCA method has been used to problems in psychology, signal processing as well as analysis of climate data (Kerschen & Golinval 2004). The technique was also employed for the compression and reconstruction of the reflectance spectra of 1269 Munsell color chips with various number of basic functions (Farajikhah *et al.* 2011). It was claimed that the NLPCA could present better results than PCA in low dimensional subspaces.

Because of the linear nature of PCA method, the performances of method decrease for dataset which lies on a nonlinear manifold. The NLPCA method benefits from training of a neural networks to find the nonlinear features in dataset. The network is forced to perform the identity mapping, where the output data approximate as closely as possible the input patterns. It should be noticed that there must be fewer neurons in the bottleneck layer than the output in order to force hidden units to compress the input data and show main features in data. The transfer function at bottleneck layer must be a nonlinear function like sigmoidal and the number of neuron at input and output layer would be equal to the dimension of data. In fact, the employed five layer ANN in spectral compression was built from two three layer ANN with a nonlinear bottleneck unit. In the NLPCA approach, the mapping is performed according to Equation 1:

$$PC = G.R, \quad (1)$$

where, R is a spectral data set, PC is the nonlinear principal components and G is a function composed of f nonlinear functions  $G = [G_1 \ G_2 \ \dots \ G_f]$ . The reflectance is recovered by another nonlinear function  $H = [H_1 \ H_2 \ \dots \ H_m]$ , as shown by Equation 2.

$$\hat{R} = H.PC. \quad (2)$$

Functions G and H are obtained by using an autoassociative neural network in a manner to minimize the  $\|R - \hat{R}\|$  (Kramer 1991, Kerschen & Golinval 2004).

In the present study, two nonlinear versions of PCA, including the public domain version of Matlab code as well as those of autoassociative feed-forward ANNs are examined for the compression and reconstruction of total radiance factor of fluorescent colorants. It is tried to optimize the efficiency of a five layers autoassociative ANN by adjusting some network parameters and the performances of designed networks are compared with those obtained with public domain Matlab code on NLPCA and classical PCA in terms of different numbers of feature vectors. The TRFs spectra of samples are compressed in different dimensional spaces and the results of reconstruction are evaluated with original TRFs in terms of the root mean square errors (RMS) and the goodness-fitting coefficient (GFC) between the reconstructed spectra and the corresponding original ones. The color difference values under D65 and A illuminants and CIE 1964 standard observer are also investigated as the colorimetric errors.

## 2. METHOD

### 2.1 Sample Preparation

The total radiance factors of 358 samples were available from the previous study by Rayat (Rayat *et al.*). The total radiance factors of samples were measured with GretagMachbeth Color- Eye 7000A spectrophotometer with d/8 geometry while the instrument light source

simulated the D65 illuminant. The measurements were fixed between 350 to 750 nm with 10 nm intervals. The desired dataset was divided into odd and even groups while the odd samples were used as training set and the evens were employed as testing set.

## 2.2 Network Architecture

A network with 40 units in its input and output layers was designed. The bottleneck layer consisted of three nodes that resembles the color attribute. Afterward, it was attempted to optimize the efficiency of a five layers autoassociative ANN by adjusting some network parameters such as the number of neurons at hidden units, transfer functions and network training function. Network with 5, 10 and 20 neurons were examined. The transfer functions were adjust to linear, log-sigmoid and tan-sigmoid in different permutations. Network training function was also test by trainlm, trainscg and trainbfg. The optimum network was obtained by the following architecture where the neural network toolbox of Matlab was used as programming software:

```
net = newff(P,T,[ 10 3 10 ],{'purelin','tansig','purelin','tansig','purelin'},'trainlm',...
    'learnngdm','mse',{'fixunknowns','removeconstantrows','mapminmax'}...
    ,{'removeconstantrows','mapminmax'},'divideblock');
net.divideParam.trainRatio = 0.90;
net.divideParam.valRatio = 0.10;
```

## 3. RESULTS AND DISCUSSION

To compare the of PCA and its nonlinear developments, the total radiance factor of fluorescent samples were compressed in reduced spaces by using the classical PCA as well as its nonlinear version. Different numbers of principle components from 1 to 10 were used for all methods. To compare the results of different methods, the RMS, GFC and CIELAB color difference ( $\Delta E$ ) values were calculated between the reconstructed and the original spectra. Figure 1 exhibits the mean of RMS values, GFC and the color difference of the reconstructed spectra. As the Figure 1 shows, both of nonlinear methods lead to better results than PCA in the low and medium dimensional subspaces, while in case of employing more principal components all methods present nearly similar results. NLPCA Matlab code and the designed networks approximately performed the same but when more than 2 principle components were used, the optimum ANN showed better performances than other. Besides, the designed network was not lead to negative reconstructed spectra that would be an important advantage over other methods.

## 4. CONCLUSIONS

Two nonlinear versions of PCA were used for spectral data reduction of total radiation factors of a set of fluorescent samples. Both nonlinear and linear PCA methodologies were used and different reduced subspaces were examined. Results of employed techniques were evaluated by RMS errors and the GFC values between the original and the reconstructed spectra as well as their color differences under certain viewing conditions. The achieved results confirmed the better performance of NLPCA than PCA in the low and medium dimensional subspaces, while methods approximately led to same results in the higher dimensional subspaces. The designed network slightly improved the efficiency of nonlinear PCA Matlab code.

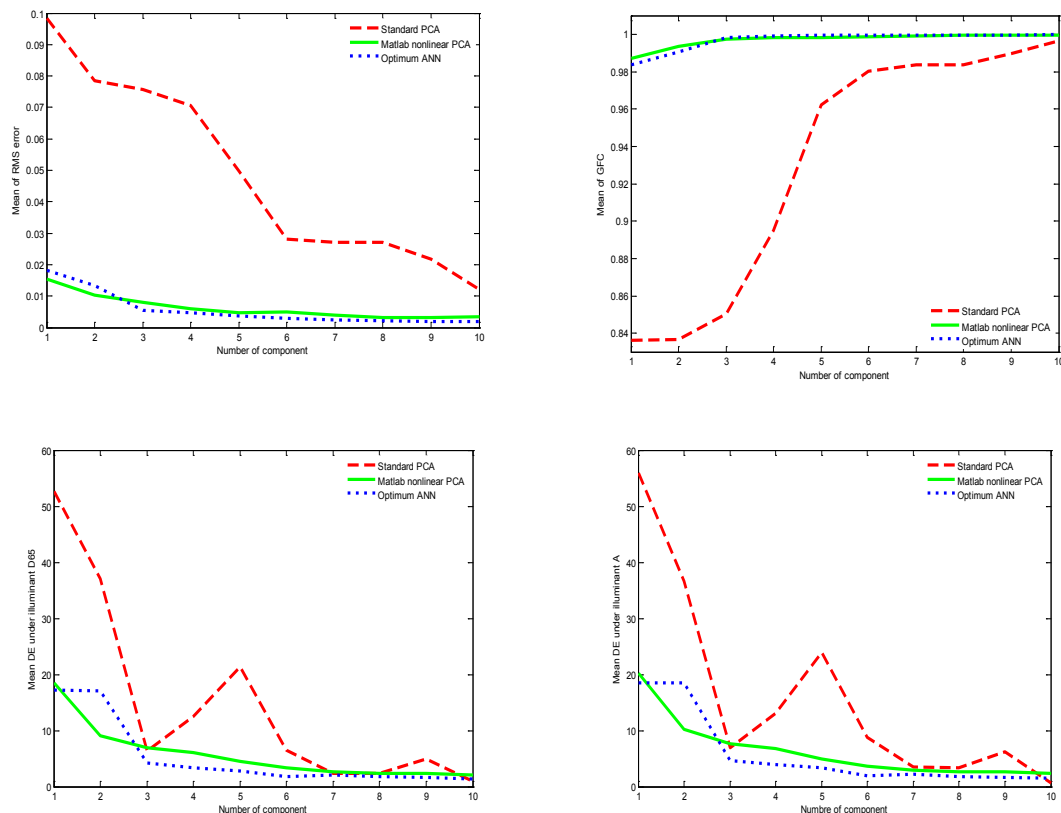

Figure 1. The mean of RMS errors, the mean of GFC and the mean of color difference values between the actual and the reconstructed spectra with PCA, NLPCA Matlab code and optimum ANN under A and D65 illuminants and 1964 standard observers using different dimensional subspaces.

## REFERENCES

- Fairman, H.S., and M.H. Brill, 2004. The principal components of reflectance, *Color Res Appl* 29(2) 104–110.
- Rayat, A., and S.H. Amirshahi, and F. Agahian. Compression of spectral data using Box-Cox transformation, *Color Res Appl* (in press).
- Maloney, L.T., 1986. Evaluation of linear models of surface spectral reflectance with small number of parameters, *J Opt Soc Am A* 3(4) 29– 33.
- Usui, S., S. Nakauchi, and M. Nakano, 1992. Reconstruction of munsell color space by a five layer neural network, *J Opt Soc Am A* 9(4) 516-520.
- Kramer, M.A., 1991. Nonlinear Principal component analysis using autoassociative neural networks, *AIChE journal* 37(2) 233-243.
- Kerschen, G., and J.C. Golinval, 2004. Feature extraction using autoassociative neural networks, *Smart Mater Struct* 13(1) 211-219.
- Farajikhah, S., F. Madanchi, and S.H. Amirshahi, 2011. Nonlinear principal component analysis for compression of spectral data, *IS2011*, Ljubljana, Slovenia.

Address: Prof. Seyed Hossein Amirshahi, Department of Textile Engineering, Amirkabir University of Technology, Hafez Ave, Tehran, Iran, 15875-4413.  
E-mails: marjan.barakzehi@gmail.com, hamirsha@aut.ac.ir, peyvandi@gmail.com



# Light Spectrum and Sensuous Design of the Fluorescent Light Applied to the Aramid Fabric

Jung Yeon CHOI, Youngin KIM  
Dept. of Human Environment and Design, Yonsei University

## ABSTRACT

In this study, the sensuous characteristics of light were examined and the combination case studies between textile and light were analyzed. Based on this characterization and analysis, a novel design applying the sensitivity of light for the aesthetic value of functional textile was proposed. The general properties of light and sensitivities were theoretically considered, and sensuous characteristics of artificial light and general characteristics of fluorescence were examined by the combination cases of textile and light through literature studies. Also, to figure out the possibility of the combination between fluorescent light and functional textile, aramid textile was selected as a potential commodity textile. The suitability between Aramid fabric and fluorescent dye was also investigated through the physical property test of Aramid textile, wave spectrum test of fluorescent dye, solvents for fluorescent dye and lighting test, dyeing affinity test of between Aramid fabric and fluorescent dye, and test of colors change of fluorescent dyes according to the source of light by experimental studies. Subsequently, sensuous words on the fluorescent colors were selected and the sensuous characteristics of light were by survey study.

This study was focused to grant aesthetic sensitivity to diverse materials oriented from the development of industries by the base of amalgamative thought. For this purpose, it was investigated that the sensuous characteristics of light affects the human sensitivity significantly. Additionally, it was investigated that industrial textiles with the functional purpose has a potential as an commodity textile applying to interior and the fluorescent light could be combined to this functional textile as the sensuous element. Conclusively, a new design was proposed by supplementing new sensitivity of light to high functions.

## 1. INTRODUCTION

The direction of industrial development depends on the materials which affects the various fields such as architecture, design and fashion. After 19th century, as development of diverse materials, originated from development of petrochemical industry, influenced strongly to whole industries, it was resulted from the development of textile industry together with materials. With the growth of textile industry, design technologies were also improved, and it caused the synergistic effect of growth for material technologies. Development of both scientific technologies and industrial system enabled the development new various functional materials, which might be substitute of existing materials, typically by steel, textile, and ceramic. Although textile is suitable for high sensitive designs for its flexible and easy to express diverse textures than metal or plastic, it is limited to apply to space due to low strength, low durability and low safety. Hence, interior design using the new materials overcomes these disadvantages of the existing fabric materials. Therefore, among the various new functional materials, aramid textile was selected as a candidate of functional textile for life design.

On the other hand, science and technologies, especially by diverse media such as TV and mobile phone, has developed the other dimensional aesthetic sensitivity for light and color. As affected from the above, the demand for development of new design, which can be satisfied the sensitivity of contemporary man, is increasing. Accordingly, we can suggest the new methods by combining new illuminating materials with textile as a model, which might satisfy such change for sensitivity against light and color and increase the aesthetic value of textile instead of function vale. Among the many ways to combine the light and textile, electric wire or power are not suitable elements with light and flexible textile materials. As the expression methods of light are developing diversely, the light expression method by using fluorescent dye is to afford new sensitivity with its diverse color change. The application of fluorescent light for textile has the advantage to escape safety hazards such as flammable possibility by spark, and the flexibility of not using other electric devices such as electric wire, and afford mysterious and fantastic feeling by indirect light effect. Accordingly, in this study, we suggest design development method, which has the new aesthetic sensitivity by applying light to functional textile. For this purpose, we additionally investigate the sensuous characteristics and type of light and develop new design, which applied fluorescent light to aramid fabric.

## 2. METHODS

### 2.1 Aramid textile and fluorescent dyes used in this study

One of the Aramid fabrics type, as the demand of meta aramid is increasing, the price thereof is decreased, which is resulted from the competitiveness. With its excellent dielectric strength, it endures temporary electric impact without the reinforcement of resins or varnishes. It is not only strong strengths against abrasion but also high elasticity function and flexible. Also, due to its high heat stability, there are little changes in physical and mechanical properties at high temperature, main properties is not changed at higher temperature. Because it is strong against acid and alkali, there is little influence by chemicals and also strong to against insects or mold erosion. It is fire-proof capacity and is free from toxic to human. In case of the direct lighting on the fabrics, it is necessary to use cables providing electricity and this causes safety problems. On the other hand, indirect lighting such as fluorescence is generally free from the safety problem and hence provides huge flexibility. Based on this, a new design for safety against fire and unique sense of light will be proposed using the benefits of Aramid fiber.

### 2.2 Preparation of fluorescent dyed aramid textiles

In this study, 6 commercially available Aramid fabrics were chosen to test the physical properties for the application to the fluorescent dyed light cover. Also, Blue, yellow and red fluorescent dyes were selected as basal colors. The main component of blue, yellow and red were Coumarin, Fluorol Yellow 088 and Rhodamine B, respectively. To test dyeing affinity of the fluorescent dye on Aramid fabrics, we examined the change of color before and after drying under the 370 nm of UV light. There was no change before and after.

### 2.3 Spectral analysis of fluorescent dyes

To examine the effect of mixing of fluorescent color dyes we using an Evolution 600 UV-Visible Spectrophotometer (Thermo Scientific Co., Waltham, MA, USA) for Absorption spectra, UV/VIS Spectroscopy for emission spectra.

## 2.4 Color sensitivity analysis of fluorescent dyed textiles

In this study, a survey was conducted to assess the sensitivity about fluorescent light. There are diverse methods to collect sensitivity words. One method is to suggest stimulation first and get the responses from the sample targets, and the other method is to get the free imaginary words without the stimulation suggestion<sup>1</sup>. In this study, primary collection of the sensitivity words was obtained by free imagination. To assess the sensitivity for fluorescent, the words were first collected as an initial, by preliminary investigation of 40 art majored students by using the samples applying fluorescent dyes with red, yellow and blue colors. By surveying the adjectives relating the samples, total 42 words were collected. Next, by professional supervision for words' refinement, 29 words were selected and transformed to standard form. Also, based on the previous classification, the characteristics of words are classified as super realism, aesthetic appreciation, amusement, and comfort ability [Table 1].

Table 1. Selection of Word for Fluorescent Light.

Sensuous Features of Light	Words for Overall Fluorescence
<b>Super Realism</b>	Abstruse, Artificial, Dreamlike, Fantastic, Mysterious
<b>Aesthetic Appreciation</b>	Attractive, Beautiful, Brilliant, Delicate & soft, Diverse, Gorgeous, Graceful, Luxurious, Passionate, Pure, Sexy, Stimulate, Strong
<b>Friendship</b>	Comfortable, Dismal, Gloomy, Horrible, Mild, Warm
<b>Amusement</b>	Cheerful, Funny
<b>Comfort Ability</b>	Cold, Cool, Fresh

## 3. RESULTS AND DISCUSSION

First, sensitivity was subjective because it belongs to personal, social and cultural backgrounds. The words, which can be represented the sensitivity of current artificial light, are super realism, aesthetic appreciation friendship, amusement and comfort ability.

Second, as the examples of sensuous materials applied to textile, optical fiber, fluorescent and phosphorescent were used. LED showed a potential to make various colors and patterns, the EL light was the gorgeous and soft, laser light had the thin and sense of lines light. Optical fiber could make various kinds of colors expression with textile for its delicate and brilliant light, and finally, fluorescence and phosphorescence expressed their light as fantastic, mysterious and unique features by various colors.

Third, by the analysis of the types and properties of current industrial textiles, it was concluded that the most suitable textile to apply commodity textile was aramid fabric because of its heat-resistant, stability, chemical-resistant, electronic insulation capacities. And the suitability to UV lighting was investigated.

Finally, it was found that there was the compatibility between Aramid fabric and fluorescent dye physically and the diverse colors expression was possible by the fluorescent dye according to the spectral studies. Also, aesthetic appreciation related words for Red and Yellow fluorescent light, super realism related words for Blue and Overall fluorescent light were selected most frequented words.

<sup>1</sup> Hong, Jongsook, Kim, Youngkap. 2009. "A Study on the Evaluation of Sensibility Vocabularies for Atmosphere on Food-Space - Centered on Family Restaurants -". *The Journal of The East Asian Society of Dietary Life*, p.312.

#### 4. CONCLUSIONS

Modern science and technology as well as industrial development promoted development of the various materials including high-performance and multi-function, and this influences progress of textile industry. Emergence of novel materials expands the material availability for product development and new emotional design by adding the factors of art to these new materials should be necessary for the value-addition and development of design industry. Furthermore, due to progress of science and technology, a variety of visual and digital media has been developed and consequently, these experiences on devices and media cause new emotion to the light in the modern society. For this reason, traditional color emotion based on the conventional materials and techniques cannot satisfy desire of modern society and therefore, novel design applied to new emotion of light should be necessary. Therefore, to meet the changing emotion of light and to use of the new fabric materials which have been focused on their functions so far, this study aims to develop a new design strategy promoting the value of art by carrying out the followings:

Characteristics of light was initially analyzed, the relationship between the light and human emotions was examined, and benefits of fluorescence was proposed through the examples of application of lights and fabric materials. In addition, by analyzing the types and characteristics of industrial fabric materials which have been emphasized by their functions thus far, aramid as the life materials was characterized. Subsequently, by applying fluorescent dye to aramid, potential of combination of both materials and emotional properties of the fluorescent light was analyzed and consequently, new design by applying unique light emotions to the functional fibers was proposed.

This study integrates the merits of aramid emphasizes its function and features of fluorescence expressed by the principle of fluorescent light reacted by UV, novel emitting fabric material stimulating human emotion was proposed. Furthermore, in the area of design, selection of materials can be broadened and by design stimulating the unique sense of light, novel design in the area of interior and fashion using fibers can be proposed.

#### REFERENCES

- Hong, J. and Y. Kim 2009. A Study on the Evaluation of Sensibility Vocabularies for Atmosphere on Food-Space - Centered on Family Restaurants. *The Journal of The East Asian Society Of Dietary Life*, 19(3): 311-315.
- Shin, S. 1996. Classification of Adjectives. *The Journal of Linguistics*. No.6.

*Address: Jung Yeon Choi, Department of Human Environment and Design,  
College of Human Ecology, Yonsei University, 50 Yonsei-ro,  
Seodaemun-gu, Seoul, 120-749, KOREA  
E-mails: jungyeon39@hotmail.com, youngin@yonsei.ac.kr*

# DISMECOR: A Device and a Methodology for Perceptual Colour Analysis

João PERNÃO

CIAUD – Research Centre for Architecture, Urban Planning and Design  
Faculty of Architecture, TU Lisbon, Portugal

## ABSTRACT

This device was conceived, developed and built by the author, as part of the research for the PhD dissertation titled: *Colour as the Perceived Form of Space Defined by Time* (2012)<sup>1</sup>. The device was also submitted to INPI (Portuguese National Institute for Industrial Property) and patented.

The creation of this device was induced from the difficulty of discussing issues related to colour application in architecture, due to the differences between the perception of colour samples as seen in the architect's offices, where the design choices are made, and the final colour perception after they were applied to a surface, in a specific environment and with a specific lighting. The aim is to make possible the recording, analysis and comparison of the perceived colours variation according to the circumstances of their observation, in order to enable better forecasting results at the design stage.

The field of application of this device, and the inherent methodology, is the research, teaching and practice concerning the use of colour in Architecture, in Design, and in the artistic areas in general. The findings will also be useful to some relevant areas in industry such as lighting, paints and coatings.

## 1. INTRODUCTION

The measurement of colour on surfaces, namely for architectural survey, is usually produced by direct comparison with color-coded samples referenced to a known system such as *NCS – Natural Colour System*. Another known process, more sophisticated, is the colour measurement with a colorimeter or spectrophotometer directly on the surfaces. In both methods we are very far from the chromatic impression registered by our optical system and interpreted by our brain, always dependent on the unique characteristics of each observation, due to the ephemeral relations between observer / surface / light. There is no possibility, for example, to identify and measure the perceptual differences between the colour we see on a surface directly under sunlight and the colour we see on the same surface in the shade, or under two different illuminants (e.g. incandescent and fluorescent lighting). When you compare the colour on one surface with colour samples, you are being affected by the overall lighting conditions, both over the surface and over the samples, and therefore the reading will be the same in sun or in shadow. If you are measuring colour with a colorimeter, the device will block the outside lighting conditions and will measure the reflection of its own calibrated light. None of these methods fulfils our aim.

The DISMECOR device allows, amongst other possibilities, to measure the variation of a surface's perceived colour in accordance with the observation conditions such as: type, location, intensity and quality of the lighting, the dimension of the colour area, the observation distance, the angle of view, texture, gloss level, and the perceptual variation resulting from

<sup>1</sup> Supervised by PhD Professor Maria João Durão

the presence of other colours in the visual field. In a succinct way, the device allows us to measure and compare colours like we perceived them.

## 2. THE DEVICE

The device (Figure 1) has a closed steel box with a viewfinder divided in half in height, allowing the simultaneous observation of the interior and the exterior: in the lower area we observe the colour samples placed inside the box through a slot, illuminated by a constant artificial light, and in the upper area we observe our subject of study, outside the device, illuminated under exterior lighting conditions (Figure 2).

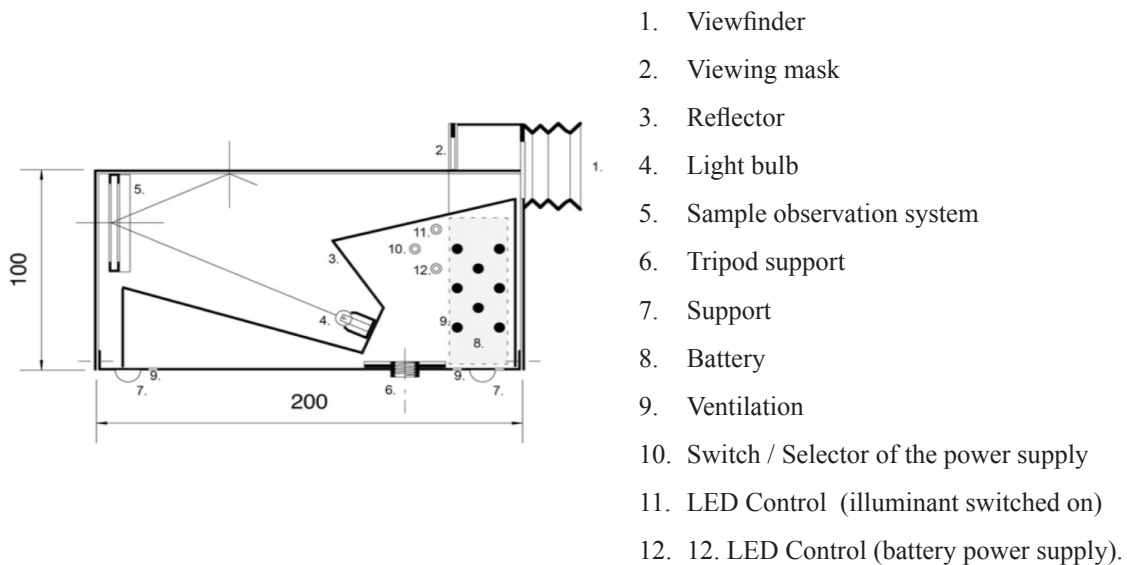

Figure 1: DISMECOR section included in the Patent Application.

With this process we can compare the colours we see on the surfaces outside, with the codified colour samples (NCS Index) that we introduce into the body of the device to determine a match between them.

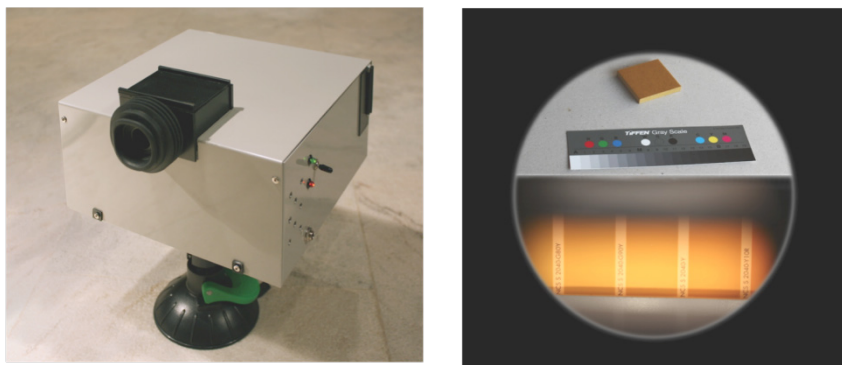

Figure 2: Device and viewfinder image comparing inside samples with outside objects.

## 3. TOOLS AND METHODOLOGY

The phenomenological approach of this research led to a profound reflection on the parameters that determine the circumstances of colour observation in the visual perceptual field, and consequently, of the space perception. This has led to the necessity of a rigorous characterization of the three fundamental elements considered for colour perception – Observer, Surface and Light – and was responsible for the development of specific tools and

procedures, like the DISMECOR, the *Colour Analysis Data Sheet*, the *Inherent/ Perceptual Colour Variation Graphic* and the use of equipments like a Colour Temperature Meter and a Luximeter.

To support the recording and crossing of the data obtained by the DISMECOR device and other data coming for other surveying methods, relevant for colour perception at the moment of the observation, we've created the *Colour Analysis Data Sheet*, a database (Figure 3) in which we've registered the values for the follow parameters:

- i. Light parameters: illuminant characterization, colour temperature, illuminance, light/ surface incidence angle, observer viewing direction/light angle, geographic direction of the illuminant, illuminant/earth angle.
- ii. Observer parameters: site characterization, date/hour, observer location (GPS), observer geographic viewing direction, viewing direction/surface angle, observer/ surface distance.
- iii. Surface parameters: texture, gloss level, spatial location, geographic direction orthogonal to the surface, and inherent colour codification.

We've included a photo from the same position and moment of the data survey and a graphic where we can visually understand the variation of inherent/perceived colour. All data is registered in a database that allows its easy handling, quick search and the crossing of results according to the objectives and conclusions to obtain.

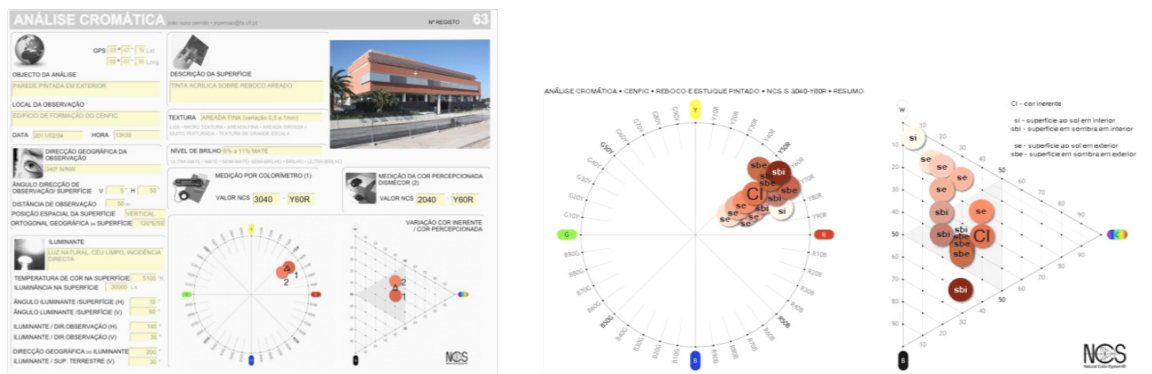
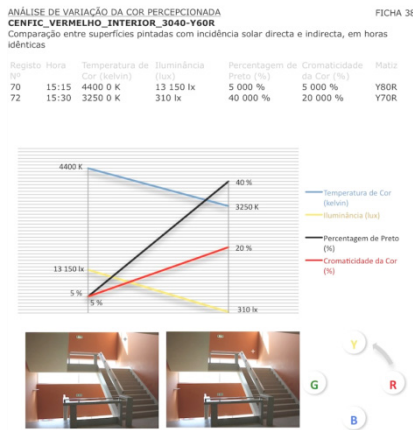

Figure 3: *Colour Analysis Data Sheet & Inherent/Perceptual Colour Variation Graphic.*

We've defined in our research the concepts of *Inherent Colour* as the physical colour, measured by a colorimeter directly on the surfaces, and *Perceived Colour* as the impression of colour we feel, ephemeral and always changing (measured with DISMECOR). For a better and faster visualization of the variation between inherent and perceived colours, in order to allow faster and clear conclusions, we've created the *Inherent / Perceptual Colour Variation Graphic* (Figure 3) using the NCS colour system model. A graphic was made for each CI (Inherent Colour) for a clear visualization of the relationship between one *Inherent Colour* and all the *Perceived Colours* measured by DISMECOR in surfaces with that same *Inherent Colour*. For obtaining clear results, we have also identified perceived colours for their location: *si*- interior sun lighted surface; *sbi*- interior shaded surface; *se*- exterior sun lighted surface; *sbe*- exterior shaded surface. This allow us to take conclusions about the type of change that colour suffered according to the circumstances of its observation. For instance, we can notice, for this specific graphic, that the variation was within a wider range in *Value* and *Chroma* dimensions than in *Hue*; that there wasn't any perceived colour more chromatic than the inherent colour; and that the wider gap was between colours perceived in

interior situations, under direct sunlight incidence and on shadowed surfaces.

For establishing specific relations of variation between the various parameters recorded in the *Colour Analysis Data Sheet* we've created a *Record for Colour Variation Analysis*. The data we want to relate and compare is entered in a computer spreadsheet table that automatically produces a graph with the respective values signalled (Figure 4). Pictures from the moment of the two observations are added to better visualize the comparison.



in blue: variation in Colour Temperature (K)

in black: variation in Blackness (%)

in yellow: variation in illuminance (lux)

in red: variation in chromaticity (%)

Figure 4: Record for Colour Variation Analysis: example.

In this example, we compared the data obtained from two surfaces with the same Inherent Colour, one under direct sunlight and the other in the shade (the spot measured is signalled with a small cross in the pictures). This tool allows a clear visualization of this variation where it becomes clear that there was an increase in the Blackness values (5% to 40%) and also in Chromaticity (5% to 20%) and a decrease of the values of Colour Temperature (4400K to 3250K) and Illuminance (from 13.000 lx to 310 lx), while the variation of Hue was counterclockwise (from Y80R to Y70R).

#### 4. CONCLUSIONS

This device proved to be effective in colour analysis, allowing psychometric observations of Perceived Colour on both lab work and fieldwork, fulfilling the function for which it was created. The methodology and the tools developed were efficient for registering and processing the data, allowing in the future other findings and conclusions by different crossing of information contained in them.

This research will allow a better understanding and dissemination of the colour phenomenon bridging perception with aesthetics, and making complex theoretical concepts verifiable through practical observation and comparison of data. This will lead to the understanding of colour as a more holistic concept, fundamental to the perception and quality of our environment. Colour is the form of space, and the capacity of understanding how we perceive it is crucial to enable better forecasting results at the design stage in Architecture, Design and all the related areas.

Address: Prof. João Nuno Pernão  
 Faculdade de Arquitectura, Universidade Técnica de Lisboa  
 Rua Sá Nogueira, Pólo Universitário do Alto da Ajuda, 1349 -055 Lisboa, Portugal  
 E-mail: jnpernao@fa.utl.pt



# Lightfastness and Kubelka-Munk Characterization of Hybrid Nanopigments

Bàrbara MICÓ,<sup>1,2</sup> Ernesto BAENA-MURILLO,<sup>1</sup> Omar GÓMEZ,<sup>1</sup> Esther PERALES,<sup>1</sup>  
Eduardo GILABERT<sup>2</sup>, Francisco M MARTÍNEZ-VERDÚ<sup>1</sup>

<sup>1</sup> Colour and Vision Group, University of Alicante-Spain

<sup>2</sup> Universitat Politècnica de València

## ABSTRACT

Hybrid nanopigments are intercalation compounds formed by cationic organic dyes adsorbed on the surface of smectite clay mineral hosts. In this study, the nanopigment properties were tested by UV-VIS spectroscopy and by Kubelka-Munk theory. Three nanopigments were synthesized using three cationic dyes and a montmorillonite clay. The nanopigments were mixed in a translucent white paint for the characterization tests. To improve the dispersion, two low-viscosity dispersing agents with different densities were added. In conclusion, the reinforcement of the dye as nanopigment was clearly confirmed, and significant displacements in  $K(\lambda)$  and  $S(\lambda)$  peaks were found between the pure dye and nanopigments due to interactions between the dye molecules and clay.

## 1. INTRODUCTION

Pigments and dyes are defined as those materials of organic or inorganic origin which have the property of absorbing and selectively scattering incident light, resulting in the reflection of complementary colors (Zollinger 2003). They have been used for the coloration of textile, polymeric and ceramic materials and have sought to optimize its performance and properties for different industrial applications (Faulkner and Schwartz 2009). Metal complex pigments have been the most common alternative to use in industrial applications and this involves an environmental problem due to the high content of heavy metals. For this reason the object of interest is finding an alternative to this kind of pigment, which becomes competitive in terms of physical-chemical, colorimetric and cost (Cristea and Vilarem 2006). This problem is the emergence and growth studies on the generation of hybrid pigments that mimic the coloring system of ancient civilizations such as the Maya (Sánchez del Río et al. 2004). The inclusion of dyes in inorganic matrices offers important advantages, such as higher temperature stability and reduced degradation by other environmental factors such as exposure to light (Yuan et al. 2008).

On the other hand, the Kubelka-Munk theory allows to study the optical properties of a material. It is based on the fact that the optical properties of a film that absorbs and diffuses light can be described by two constants: the absorption coefficient  $K(\lambda)$  and the diffusion coefficient or scattering  $S(\lambda)$  (Zhao and Berns 2009). Therefore, the aim of this work is to evaluate the properties of hybrid nanopigments, formed by cationic organic dyes adsorbed on the surface of smectite clay mineral hosts, by a UV-VIS spectroscopy test and by calculating the absorption and the diffusion coefficients.

## 2. METHOD

### 2.1 Materials

The three organic dyes used were C.I. Basic Red 46 110825 (Red Astrazon), C.I. Basic Yellow 28 (Astrazon Yellow), CI 48054, and C.I. Basic Blue 4 (Blue Astrazon) C. I. 11105. As inorganic component of the hybrid material, a montmorillonite clay was used with trade named Nanofil 116<sup>®</sup>. The montmorillonite has an ion exchange capacity of 116 meq/100 g. We used two types of dispersants: Dispex A40<sup>®</sup>, a solution of quaternary ammonium salt of an acrylic polymer in water, and Dispex N40<sup>®</sup>, a sodium salt solution of an acrylic polymer in water. Also drops of HCl (37% purity) were added to adjust the pH of the dispersion. Finally, as a binder was used a white paint transparent base.

### 2.2 Synthesis

To ensure reproducibility in the synthesis of the nanopigments, three samples were generated for different conditions (Table 1). Samples were synthesized following the same scheme (Figure 1). The condition of pH was maintained between 7-8. The dispersants were added when the exchange was performed with the dye clay.

Table 1: Samples codes according to the dispersant.

N116 + Basic Red 46				N116 + Basic Blue 41				N116 + Basic Yellow 28			
Dispersing agent				Dispersing agent				Dispersing agent			
REF	NO	A40	N40	REF	NO	A40	N40	REF	NO	A40	N40
1ER	X			1EB	X			1EA	X		
2ER	X			2EB	X			2EA	X		
3ER		X		3EB		X		3EA		X	
4ER		X		4EB		X		4EA		X	
5ER	X			5EB	X			5EA	X		
6ER		X		6EB		X		6EA		X	
7ER			X	7EB			X	7EA			X
8ER			X	8EB			X	8EA			X
9ER			X	9EB			X	9EA			X

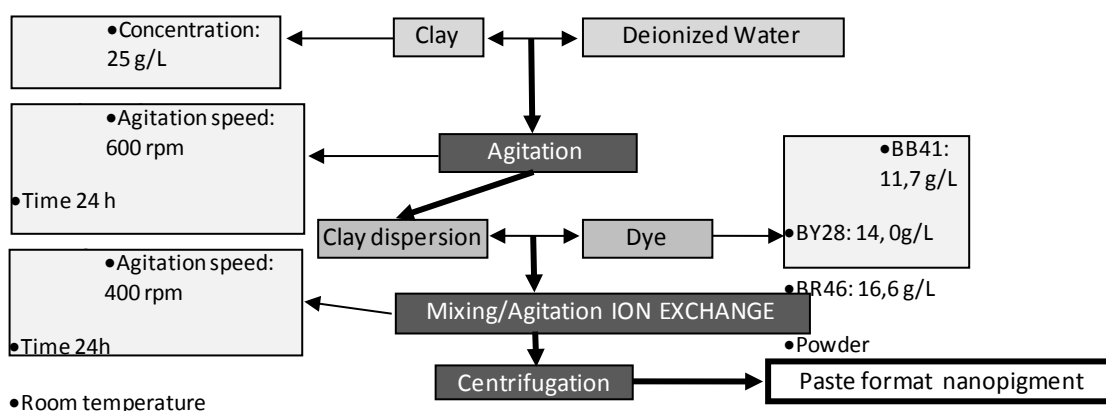

Figure 1: Synthesis scheme.

### 2.3 Preparation of samples for color analysis and the weathering test

Paint samples were prepared by adding controlled amounts of hybrid pigments extracted after centrifugation. The colored paint was applied over a sealed plain Leneta card for coating tests using a quadrangular film applicator with a 100 µm thickness. After drying during 6 h at room temperature and natural convection, two squares of 4 cm side from each colored paint

coating were mounted on a plate, one for the exposure to light, humidity and temperature, and other covered with a reflective material in order to avoid any interaction with the light. The equipment used for the weathering test is the chamber SolarBox 1.500 RH. The essay was performed during 15 h, under an irradiance of 500 W/m<sup>2</sup>, a relative humidity of 40% and a temperature of 50 °C. Measurements were made to the exposed and covered samples to calculate  $\Delta E_{ab}^*$  color differences. Color measurements were performed with the Konica-Minolta CM-2600 spectrophotometer by using the D65 illuminant and the 10° observer.

### 3. RESULTS AND DISCUSSION

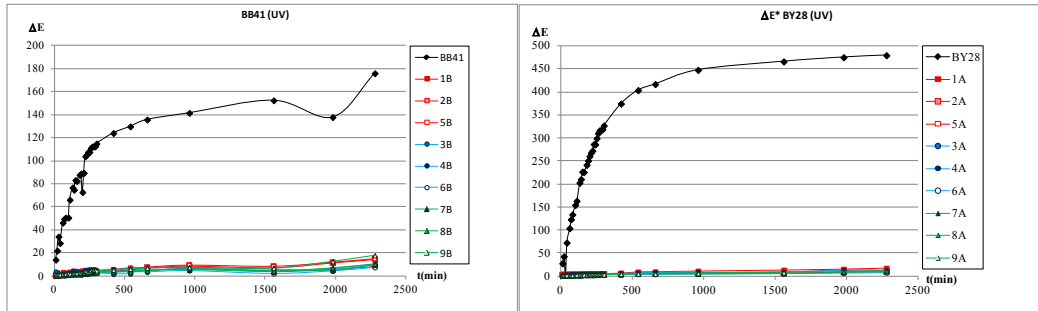

Figure 2: Left;  $\Delta E$  of the samples with dye BB41, exposed to radiation relative to start test. Right;  $\Delta E$  of the samples with dye BY28, exposed to radiation relative to start test.

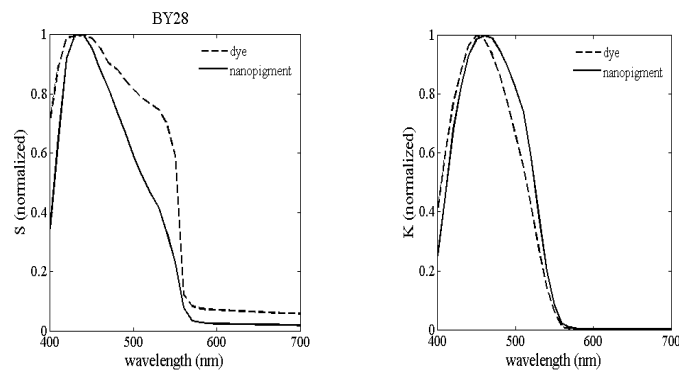

Figure 3:  $S(\lambda)$  and  $K(\lambda)$  curves of samples with dye CI. Basic Yellow 28 and nanopigment.

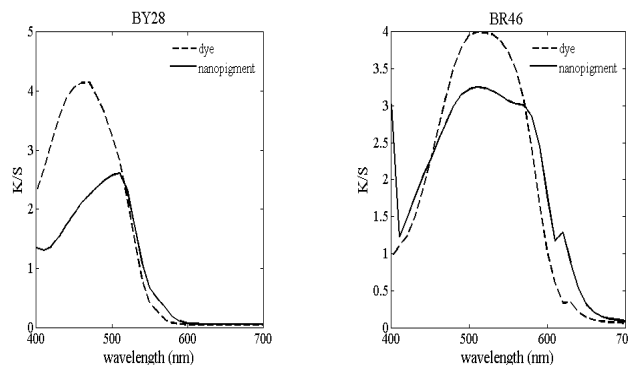

Figure 4: Left; Ratio  $K/S(\lambda)$  of samples with Basic Yellow 28. Right; Ratio  $K/S(\lambda)$  of samples with Basic Red 46.

Essays in the climatic chamber were performed to test the initial hypothesis about dyes reinforcement through interaction with the nanoclay. In Figure 2, x-axis represents the time in minutes of testing, and the y-axis the difference in color relative  $\Delta E_{ab}^*$  to the sample before it is introduced into the climate chamber. The asymptote of each curve represents the

maximum color degradation reached by each sample. C.I. Basic blue41 samples show the dye reinforcement, The sample with the pure dye has a much higher degradation kinetics and reaches  $180 \Delta E_{ab}^{*}_{jnd}$  (just-noticeable-difference), while samples with nanopigment not exceed a  $20 \Delta E_{ab}^{*}_{jnd}$ . This same phenomenon occurred with the other dyes.

On the other hand, the Kubelka-Munk theory was applied to compare their optical properties by calculating the absorption and the diffusion coefficients. In Figure 3, the absorption coefficient,  $K(\lambda)$ , and the diffusion coefficient  $S(\lambda)$  of both the dye CI Basic Yellow 28 and the nanopigment generated from. The curves are normalized to the maximum value to determine the clay influence on these parameters. In addition, Figure 4 shows the ratio  $K/S(\lambda)$  for the dye CI Basic Yellow 28 and Basic Red 46. It can be seen from Figure 3 and Figure 4 that the clay modifies the optical properties of the colorant. The absorption coefficient  $K$  suffers a slight shift but the diffusion coefficient  $S$  is modified in a higher degree what it is normal since the clay is transparent but it scatters the light.

#### 4. CONCLUSIONS

It is confirmed that the colorant is reinforced due to the adsorption and intercalation in the clay host, because the degradation kinetics of the three dyes is superior to that of the same when they are part of the hybrid clay/dye system. In particular, there is no influence of the dispersant in terms of the resistance to exposure to UV light. On the other hand,  $K(\lambda)$  and  $S(\lambda)$  bands are modified due to the effect of the clay with the dye. Nevertheless, it is necessary a deep study to evaluate the effect of the clay in the nanopigment.

#### ACKNOWLEDGEMENTS

The Ministry of Economy and Competitiveness for the project DPI2011-30090-C02-02, and the grant FPI BES-2012-053080.

#### REFERENCES

- Cristea D. and G. Vilarem 2006. Improving light fastness of natural dyes on cotton yarn, *Dyes and Pigments* 70, 238-245.
- Faulkner, E.B. and R.J. Schwartz 2009. High performance pigments. John Wiley & Sons.
- Sánchez del Río, M., P. Martinetto, A. Somogyi, C. Reyes-Valeriac, E. Dooryhe'eb, N. Peltierb, L. Alianellid, B. Moignarde, L. Pichone, T. Calligaroe and J.-C. Dran 2004. Microanalysis study of archaeological mural samples containing Maya blue pigment, *Spectrochimica Acta Part B* 59, 1619–1625.
- Yuan, J., W. Xing, G. Gu and L. Wu 2008. The properties of organic pigment encapsulated with nano-silica via layer-by-layer assembly technique, *Dyes and Pigments* 76, 463-469.
- Zhao, Y. and R.S. Berns 2009. Predicting the spectral reflectance factor of translucent paints using Kubelka-Munk turbid media theory: review and evaluation, *Color Research and Application* 34(6) 417- 430.
- Zollinger, H. 2003. *Color Chemistry*. John Wiley & Sons.

Address: Barbara Micó Vicent, Colour and Vision Group,  
University of Alicante, Carretera de San Vicente del Raspeig s/n, CP 03960, Spain  
E-mail: barbara.mico@ua.es

# Hyper-light Carbon Dioxide Colorant Physics Properties

Lev VOZCHIKOV  
Laboratory Selena, USA

## ABSTRACT

The light nature of color was discovered in an experiment with a warming semiconductor. This method told us that the absorbent warming continues in the right light spectrum part. Color of a light known color is a result of selective light absorption. Formerly absorption energy – warming – is the result of light spreading in an environment. The warming effect provides evidence of light energy transport. The aperture concentration method was developed to achieve an effective way of measuring the quantities of detected hyper-light energy. Atmospheric environment substances are gas substances that actively absorb, emit, and reflect selective spectrum energy light. The physical properties of carbon dioxide ( $\text{CO}_2$ ) were examined using a gas colorant approach. The hyper-light method describes absorption, and transmitting energy transparently given in terms of the theory of the light color-mixing surface. Industrial demand is pushing technological improvements to satisfy the requirements of fast response and the ability to measure the integral area. The hyper-light aperture method has competitive results that are comparable with results of alternate methods. Research work has achieved results, contributing to the application of color surface theory. The profiles of the  $\text{CO}_2$  colorant aperture and apertures splitting are presented for the first time.

## 1. INTRODUCTION

Turbulent exhaust emission has an additive gas composition of carbon dioxide ( $\text{CO}_2$ ) and water ( $\text{H}_2\text{O}$ ). They are complex mixed substances with different molecular masses:  $\text{CO}_2$  has twice the mass of  $\text{H}_2\text{O}$ . We have found a split exhaust components trajectory: the trajectory angle of  $\text{CO}_2$  is negative while the trajectory of  $\text{H}_2\text{O}$  is positive (see Figure 1).



Figure 1: Split emission trajectories. Left:  $\text{H}_2\text{O}$  positive angle, right:  $\text{CO}_2$  negative angle.

The turbulent gas substance is responsible for localizing and structuring the concentration in the exhaust profile. Consistency of concentration has casual values (Vozchikov, 2005). Exhaust pipe profile, gas flow speed, and atmospheric conditions are the main factors in gas atmosphere emissions. The  $\text{H}_2\text{O}$  atmosphere deviation is 20–90% humidity, and that is greater than the normal concentration of  $\text{CO}_2$  at 200–300 ppm.  $\text{CO}_2$  is transparent at 555  $\mu\text{m}$ , whereas  $\text{H}_2\text{O}$  is transparent at hyper-light. While  $\text{H}_2\text{O}$  is complementary to the  $\text{CO}_2$  additive in the studied process, it is need to proceed with the research colorants composition in a micron hyper-light. Known industrial methods include chemical color-coding gas detection and laser-micron band pointing, and these are local contact methods. Aperture emissions of the gas exhaust process have a turbulent structure 50% deviation of the substance. Specifica-

tion of the CO<sub>2</sub> concentration profile hyper-light physics property quantitative determination is a point of research radiance, absorption, transmission, and intensity in a hyper-light band. The concentric colorant profile of the exhaust aperture was examined in this research (Fig.3). This fact is proof of the efficiency of light theory. The physics property of the exhaust concentration is discussed within the application of hyper-light research.

## 2. METHODS

The emission component CO<sub>2</sub> is the hyper-light source in a hyper-micron spectrum, and the concentration in volume is the argument of the observation aperture given in its physics aperture properties profile. The geometric profile pipe end cut, gas flow speed, atmospheric pressure, temperature, and air speed are in molecular concentrations in the volume profile parameters. The CO<sub>2</sub> colorant in the atmosphere absorbing emits radiance. Figure 2 shows the concentration- radiance in a volume CO<sub>2</sub> diagram developed based on the standard spectral absorption CO<sub>2</sub> cylindrical molecular atmospheric gas cell model. Figure 2 is the chart of concentration-radiance for the standard bolometer CO<sub>2</sub> detector: X is the volume concentration as a percentage, and Y is the in-bond radiance in Wt/m<sup>2</sup>.

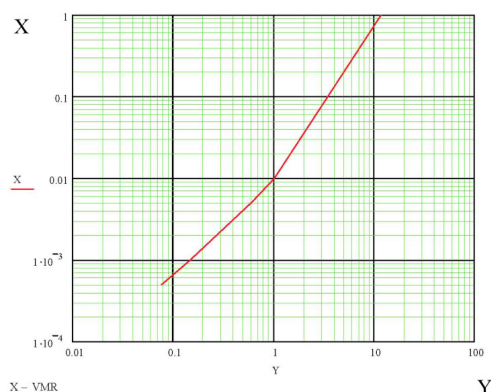

Figure 2: Concentration-radiance CO<sub>2</sub> diagram.

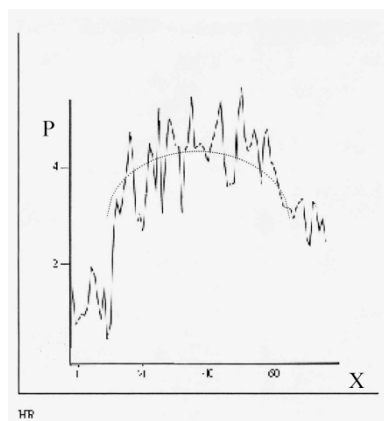

Figure 3: CO<sub>2</sub> hyper-light aperture profile.

The CO<sub>2</sub> spectral concentration-radiance diagram was devised at basic temperature, atmosphere pressure, and using the standard dimensions of the gas cell model. Physics properties of the hyper-light aperture – geometric profile, trajectory emission angle, hyper-light radiance intensity; intensity length-weakening decrement – are a basic application of the color surface equation theory constant color substance (Vozchikov, 1993). The assumed additive hyper-light radiances intensities are transparent light additive intensities (Vozchikov, 2001). Being transparent, CO<sub>2</sub> is a source of radiance, so the in-volume concentration quantities are subject to determining the additive of the molecular substances’ radiances and the background radiances (Vozchikov, 2012).

### 2.1 Experiment

Figure 4 shows the experimental method to determine the physical properties of the hyper-light colorant. Procedures included gas emission pipe, hyper-light controlled absorbent, and a hyper-light bolometric detector. The bolometric detector positioned orthogonal to the gas emission trajectory and toward the specimen of controlled absorbent. The bolometric recording aperture exhaust emission is a physical task of measuring its concentration at the pipe end cut. Figure 4 shows the geometry of the optical scheme, where 1 is the controlled

absorbent; 2 is the exhaust pipe cut end; 3 is the hyper-micron bolometric camera; Y is the direction of gas emission, and X is the direction that the bolometric camera was pointing.

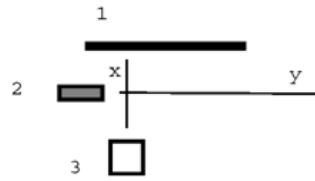

Figure 4: Geometry optical scheme measurement.

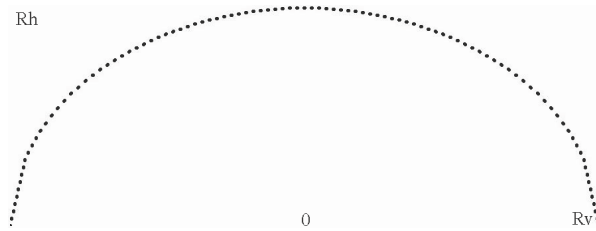

Figure 5: Pipe cut end geometric profile.

Figure 5 shows the cylindrical pipe cut to find the colorant concentration aperture from a random angle geometry (Rh is the horizontal profile of the exhaust pipe end cut; Rv is the vertical of the exhaust pipe end cut). The pointing hyper-light image recorder 3 (bolometric camera) consists of setting the trajectory toward the profile center 0. The additive equation color light components ( $E = E(x) + E(y) + E(z) - (Eqn. 1)$  (Vozchikov, 2001)) require determining the hyper-light sources at the scene of the experiment. The distance of measurement is set at a rate given by the camera's black body calibration. Equation (1) calculates the CO<sub>2</sub> concentration as an outstanding source of hyper-light radiance or absorption. The chemical concentration measurement "color-coded gas detector tube" is useful at fixed profile points, as the chemical substances do not interfere in the composite emission substances. The exhaust emission aperture has several control measurement points: high and low vertical and central aperture pipe cuts. The results of reading the color-coded gas detector tube depend on the turbulent structures' gas splitting trajectories. Discussion in Section 3 aims to prove the quality measurement in a method of hyper-light CO<sub>2</sub> aperture.

### 3. RESULTS AND DISCUSSION

Figure 2 -5 illustrates the method of the hyper-light aperture. The exhaust components concentration structure in this research is an experimental setting. Figure 2 shows the radiance carbon dioxide calculated by the atmospheric substances of the gas-cell model. Figure 4 shows the geometry of the optical scheme measurement. Figure 5 shows the pipe cut geometrical profile. Measurement of the temperatures using the micrometer bolometric camera is the primary stage of the experiment. An alternate method, "color-coded gas detector tubes", has an independent simultaneous measurement result. Local testing at the high and low pipe end cut aperture points differ but that is the turbulent, complex character-splitting gas components' trajectories. Results show that the gas detector chemical measurement and the hyper-light aperture method appear comparable in these points: identical at 10% and 20% in volume. This matches the hyper-light intensities. The dotted line in Figure 3 is the geometrical profile of the pipe end cut. The line profile was precisely positioned and centered to approximate the hyper-light experimental carbon dioxide emission aperture. Figure 3 presents an adequate mathematical algorithm (1) calculation of the hyper-light intensity

profile  $Y(X)$ . The images' additive intensities of hyper-micron light were recorded by bolometer camera then present hyper-light profile of gas colorant. The geometrical approximation of the hyper-light aperture (see Figure 3), given in a measurement interval, is an absolute outstanding colorant physics interpretation.

#### 4. CONCLUSIONS

We have discussed competitive advantages of a method of determining the colorant gas physical property. Hyper-light measurement of a gas substance is a progressive noncontact observation alternative. This method is real-time automatic technology. Equivalent results verification of the contact methods are proof, evidence reliability, of the method of hyper-light aperture. The mathematical foundation of the color surface theory provides transparent calculation concentration colorant hyper-light substances. Turbulent gas flow is responsible for local high concentration zones. Method presented here, as a potentially competitive technology, seems to be a practical way for resolving fluctuation, taking remote measurements, and gaining immediate control.

#### ACKNOWLEDGMENTS

The HITRAN database of atmospheric gases was helpful in supporting the spectral physics data set. Calculations and computer graphics were created using an effective MATCAD software interface. A Microsoft EXCEL double precision data sheet was necessary for the array pixel technology to achieve a positive result.

#### REFERENCES

- Vozchikov, L., 1993. To question about chromatic theory light record-transfer for colour picture. In *AIC Color 1993, Proceedings*, Ed. A. Nemcsics, Budapest, Technical University, P20-1.
- Vozchikov, M.L., 2001. To question about theory chromatic light paint. *Proceedings of the 9<sup>th</sup> Congress of the International Color Association* Ed. R. Chung, A., Rodriguez. Washington: SPIE, 4421, 379-383.
- Vozchikov, M.L., 2005. Image-color cluster structure superposition in air-landscape emission observation by color mix surface. *Proceedings of the 10<sup>th</sup> Congress of the International Colour Association* Ed. J.L. Nieves, J. Hernandez-Andres, Granada, 1143-1145.
- Vozchikov, L.. 2012. Color absorption equation as instrumental tool of light research, In *AIC 2012 Proceedings*. Ed. T.-R. Lee, J. Shyu, Taipei, 646-649.

*Address Engineer L. Vozchikov, Lab. Selena, Stamford, USA.  
E-mail lvselena@aol.com*



# Application of Kubelka-Munk-Theory on Carpet Colour

Tanja KLIETZING,<sup>1,2</sup> Jacqueline LEMM,<sup>1</sup> Gunnar SEIDE,<sup>1</sup> Thomas GRIES,<sup>1</sup>  
Christian GOETZ,<sup>2</sup> Jens-Christian WINKLER,<sup>2</sup> Ernst SCHRÖDER,<sup>2</sup> Uwe HEITMANN<sup>3</sup>

<sup>1</sup> Institut für Textiltechnik der RWTH Aachen University, Aachen, Germany

<sup>2</sup> TFI – Institut für Bodensysteme an der RWTH Aachen e. V., Aachen, Germany

<sup>3</sup> DITF Denkendorf Institut für Textil- und Verfahrenstechnik (ITV), Denkendorf, Germany

## ABSTRACT

This paper deals with an application of Kubelka-Munk-theory on carpet colour. In cut pile carpets the colour depends on the fibre cross sectional colour. Most of the known papers cover textiles where the textile colour depends on the fibre length sectional colour. In addition, the transfer from research to industry is considered.

## 1. INTRODUCTION

In Germany, the SMEs (Small and Medium Enterprise) in the carpet sector are specialized for high-end products for office and facilities. In the last 10 years, big windows and glass fronts are often used in new buildings so that the influence of light on carpets must now be considered. One possibility to make the carpet colour more light resistant is the use of spun-dyed yarn. The disadvantage of spun-dyed yarn is the small amount of different colours in the market because the SMEs often produce only small margins or customized carpet colours. With a tri-chromatic approach, it is possible to obtain a broad colour spectrum out of three basic colours. This work presents a colour prediction model for carpets based on the use of defined basic colours. The aim of the project is to determine the gravimetric mixture ratio of staple fibres in defined basic colours for a desired carpet colour.

The colour prediction model can only be effective as an innovation for an SME if it can be sold on the market and if it is an economically successful application. The development, implementation and marketing of technical innovation need modern SMEs, which are open to the transfer of knowledge with science, for example research institutes. Basically, any company that wants to expand his own knowledge through knowledge from external stakeholders, increase its innovation potential (Pircher 2010).

## 2. COLOUR PREDICTION MODEL EVALUATION

There are several papers on colour matching theory. The best-known theories are the Kubelka-Munk-Theory and the Stearns-Noechel-theory, which were applied in different fields like dying solution, paper and yarns. In carpet industry, there exist mainly two types of carpet: loop carpet and cut pile carpet. In loop carpets the carpet colour corresponds to the fibre length sectional colour. In cut pile carpets the carpet colour depends on the fibre cross sectional colour (see Figure 1).

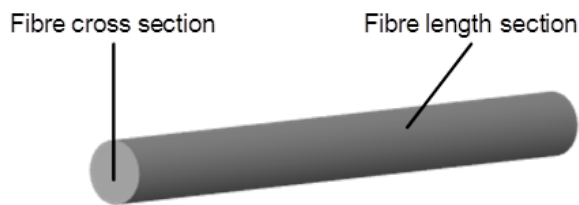

Figure 1: Difference between fibre cross section and fibre length section.

Table 1 shows an overview of colour prediction models in textile industry. The known models Kubelka-Munk and Stearns-Noechel were mainly applied on textiles with fibre length section. The analysed materials in literature were wool, rayon and acrylic fibres. In this paper, the analysed carpets were textiles with fibre cross section from polyamide PA6.

Table 1. Overview of colour prediction models in textile industry.

Model	Paper	Application	Difference to cut pile carpets
Kubelka-Munk	Burlone 1990	Loop carpet, fibre length section	Cut pile carpet, fibre cross section
Kubelka-Munk	Bernard et al. 1999	Measurements of yarn side colour and yarn cross-sectional colour, wool and acrylic fibres	Blends of polyamide fibres, measurements of carpet colour
Kubelka-Munk	Yang et al. 2010	Dyed fabrics, fibre length section	Carpets, fibre cross section
Stearns-Noechel/ Davidson-Taylor	Davidson and Taylor 1965	Blends of acrylic, rayon and wool fibres, fibre length section	Blends of polyamide fibres, fibre cross section
Stearns-Noechel	Philips-Invernizzi et al. 2002	Fibre slivers, fibre length section	Carpets, fibre cross section
Stearns-Noechel	Sabir and Yesil 2011	Fibre slivers, fibre length section	Carpets, fibre cross section

The Kubelka-Munk-Theory is based on subtractive colour mixing. The reflectance curves were measured via spectrophotometry. Afterwards, the reflectance curves of known mixtures were used to calculate the two variables, K and S, of the Kubelka-Munk-Theory for the basic colours. The reflectance curves of at least twice the quantity of basic colours are necessary to calculate these variables. To obtain the variables, K and S, mathematical optimization was applied.

### 3. RESULTS AND DISCUSSION

In a first step, 33 carpets – five basic coloured carpets, yellow, red, blue, black and white, and 28 mixed coloured carpets – were produced. The cut pile carpets were produced with PA6 yarn with 6,7 dtex. The yarn contents approx. 180 filaments and the diameter of each filament is about 28 µm.

The different influences of the input mixtures on the calculation of the two variables, K and S, were analysed. The best results were obtained by using colours at the edge of the colour spectrum (cf. Figure 2). With the calculated K and S the possible colour spectrum induced by the given basic colours was computed. In addition, the colour mixture prediction was analysed for the samples not used for the calculation of K and S.

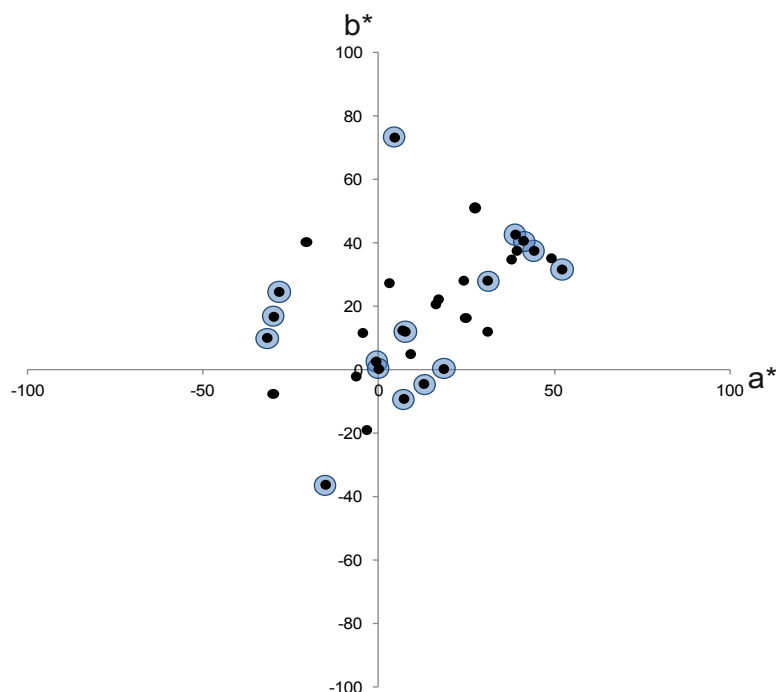

Figure 2:  $L^*a^*b^*$ -colour spectrum of 33 samples. Black: all samples.  
Blue: Samples used for colour prediction model.

The spectrophotometric measurements of the colours blue and white had a high variance. Also, the mixtures were not easy to measure since the carpet colour was mottled. In addition, the spectrophotometry only measures an average colour. Because the carpet colour was mottled, the subjective appearance of the carpet colour is brighter than the measured colour. Nevertheless, it was possible to predict the colour mixture ratio as accurate as it is needed for the yarn production process, e.g. the yarn mixing process is accurate up to 5%.

#### 4. CONCLUSIONS AND OUTLOOK

In a next step the colour model will be used to predict the mixture ratio for known colours. This predicted ratio will be used to produce new carpet samples and then compared to the original colours.

Just developments which constitute gradual, incremental changes to products, services or processes, are the basis of breakthrough innovations, which can improve the own market position. In order to achieve advanced gradual, incremental changes to products, the view in other disciplines, the interdisciplinary, is important. To get this insight into other disciplines, collaborations between industry and science, for example an interdisciplinary network, can be a great chance to exchange and share knowledge (Begole et al. 2008). Workshops could help to build networks with different industries and research institutes of various disciplines and to learn how to organize their knowledge and technology transfer.

## ACKNOWLEDGEMENTS

The project „Verfahren zur flexiblen Herstellung unifarbener Garne aus spindüsengefärbten Stapelfasern – Trichromiespinnen“, AiF-no. 416 ZN/1, initiated by the research association Textil e. V., Reinhardtstr. 12-14, 10117 Berlin, has been promoted by the Federal Ministry of Economics and Technology via the AiF as part of a programme to support the joint industrial research and development.

## REFERENCES

- Begole, B., D.W. McDonald, J.N. Cummings and S. Kiesler, 2008. Who collaborates successfully? In *Proceedings of the ACM 2008 conference on Computer supported cooperative work - CSCW '08*: ACM Press: S. 437.
- Bernard, P., K. Vanderhaeghen, and P. Kiekens, 1999. Color Measurement of Pile Fabrics. *Textile Research Journal* 69(8): 552-558.
- Burlone, D.A., 1990. Effect of Fiber Translucency on the Color of Blends of Precolored Fibers. *Textile Research Journal* 60(3): 162-167.
- Davidson, H.R., and M. Taylor, 1965. Prediction of the Color of Fiber Blends. *Journal of the Optical Society of America* 55(1): 96-100.
- Philips-Invernizzi, B., D. Dupont, A-M. Jolly-Desodt and C. Cazé, 2002. Color Formulation by Fiber Blending Using the Stearns-Noechel Model. *Color Research & Application* 27(2): 100-107.
- Pircher, R., 2010. *Wissensmanagement, Wissenstransfer, Wissensnetzwerke: Konzepte, Methoden, Erfahrungen: Konzepte, Methoden und Erfahrungen*. Publicis Publishing. 1. Auflage.
- Sabir, E.C. and Y. Yesil, 2011. Spectrophotometric Colour Matching in Melange Fibre Blends. *Fibres & Textiles in Eastern Europe* 19(5): 125-128.
- Yang, H., S. Zhu and N. Pan, 2010. On the Kubelka-Munk Single-Constant/Two-Constant Theories. *Textile Research Journal* 80(3): 263-270.

*Address: Tanja Kliezing, Institut für Textiltechnik of RWTH Aachen University  
Otto-Blumenthal-Straße 1, 52074 Aachen, Germany  
E-mail: tanja.kliezing@ita.rwth-aachen.de*

# Identification of Natural Dyes in the Historical Textiles from Dubrovnik

Durđica PARAC-OSTERMAN,<sup>1</sup> Ana SUTLOVIC,<sup>1</sup> Danijela JEMO,<sup>2</sup> Matthieu BODART<sup>3</sup>

<sup>1</sup> University of Zagreb, Faculty of Textile Technology

<sup>2</sup> University of Dubrovnik. Department for Restoration and Conservation

<sup>3</sup> Erasmus student on University of Zagreb, Faculty of Textile Technology

## ABSTRACT

This paper describes an approach to the identification of natural dyes in the historical textile from Dubrovnik: “19th century Velum sample”. Analytical methods confirmed that the fibres taken from a velum are made from a silk in red and green tone color. Two extraction methods were evaluated: the classical methanol / hydrochloric acid extraction and the gently extraction using 5% formic acid in methanol. In both cases, an additional step was an extraction with methanol / dimethylformamide. After the treatment UV-VIS, FTIR-ATR and HPCL, detection was carried out. The results showed that the larger amount of dye was removed from the red and green fibres using mixture of 5% formic acid. Extracted dyestuff analysis indicated mixture of compounds in it. In narrowest and sharpest HPLC peak at 21,627 min retention time, presence of alizarine was confirmed, while peaks at 29,183 min and 32,191 min confirmed purpurine and pseudopurpurine. Moreover, it is known that red hues were obtained using madder (*Purpura Peregrina*) or sea snails (*Murex Purpura* or *Trunculus*). Also, FTIR–ATR of dyed samples revealed a peak at 1741,41 nm, which presented >C=O group. It can be confirmed that the red coloration on “19th century Velum sample” was proved to be the result of dyeing by natural dye extracted from the madder or *Murex Purpura* or *Trunculus*, characteristic for the Dubrovnik surrounding. UV-VIS spectrophotometric analysis of green colored fibre showed two peaks in yellow and blue waveband. These results indicated mixture of natural dyestuff. Further research using describe methods will give more information about the source of the dye.

## 1. INTRODUCTION

Dubrovnik was founded in the 7th century, but the exact origin is still uncertain because two theories contradict each other. This city has a rich historical heritage due to its strategic position overlooking the Adriatic Sea. Many historic textiles from Dubrovnik are related to religion. Indeed, Dubrovnik was besieged several times during its history and various religions entered the city. They had therefore left their mark on these textiles. Moreover textile was a commodity for exchange. It was manufactured in Dubrovnik or brought from the West. In exchange, Dubrovnik received grain from Arta and Gulf of Patras, cotton from the Peloponnese and Syria, and finally spices and fine fabrics from Alexandria (according to M. Janin Raymond Krekič in “Dubrovnik et le Levant”).

The major part of these historic textiles was made from silk, sometimes from the famous silk from Lyon. It is the same with lot of historic religious textiles in Croatia.

Chasubles, dalmatics, copes, stoles or maniples can be observed. Some garments are very colourful because of the symbolism of colors in the Christian life ([www.muohr.hr](http://www.muohr.hr)). It means also manufacturers of dyestuffs were in charge of quality the good natural dyes according to colors of liturgical garments. The restoration of historic material, in addition to aesthetics, must meet rules of conservation. Knowledge of different techniques that were used is

important (from the original determination and restored areas) in order to provide effective responses to problems posed by scientists who restore historic materials. A textile sample can be used for several tests, because of the importance of non-destructive method.

This paper describes an approach to the analysis of historical textiles from Dubrovnik. Tests were conducted at the Mass of the 19th century velum. Analytical and spectrophotometric methods, fundamental of any color in order to identify the restoration of objects, were applied.

## 2. METHOD

### 2.1 Description of sample:

Name of art: Velum for Graal

Museum number: 2a

Locality: Church of the annunciation of the Blessed Virgin Mary on Lokrum

Period: 19th century

Material: Red and green fibres are from silk.

### 2.2 Extraction of dyes from textile and analysis:

Fibers (0,002g) were treated: method 1- in solution of H<sub>2</sub>O:MeOH:37% HCl (1:1:2, v/v/v) and method 2- in solution of 5% formic acid /MeOH- on 100°C on 10 minutes. After treatments, solutions were filtered with filter (Chromafil PET – 45/25, Macherey-Nagel). The solvent evaporates. Volume of 250 µl of mixture MeOH; DMF (1:1, v/v) was added to dry residue and the mixture was heated for 5 min. at 100 0C. Measured - HPLC, UV/VIS.

HPLC conditions:- Column 4,6 x 150 mm, 5 nm (Agilent Technologies 1220), Mobile phase A = 10 % of methanol / water, v/v, B = 100 % of methanol, Gradient at start 16 % B, at 15 min 90 % B, at 23 min 100 % B and 30 min 60 % B, Flow rate 0.5 mL / min, temp. 25 °C, Injection vol 10 mL, Identification wavelength = 254 nm

UV/VIS: Absorption of solution with Spectrophotometer Cary 50. Before treatment a small sample of the colored fibres FTIR-ATR (PerkinElmer Spectrum 100) were carried out.

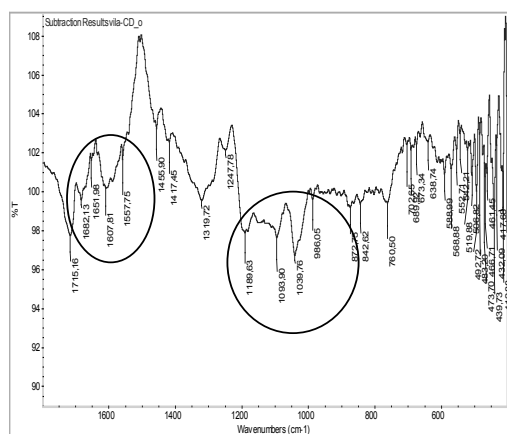

Figure 1. ATR/FTIR spectra of historical green colored silk (subtraction results).

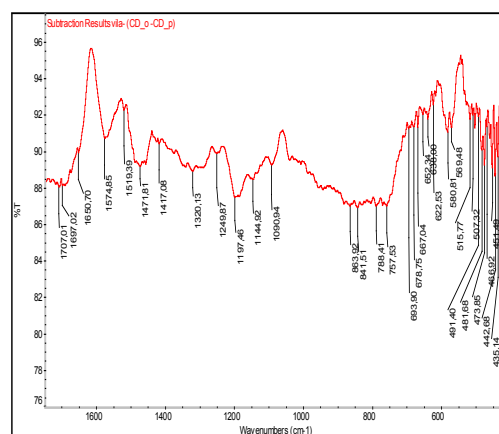

Figure 2. ATR/FTIR spectra of historical red colored silk (subtraction results).

## 3. RESULTS AND DISCUSSION

With analytical methods, it was confirmed that the Velum was made from the silk warp and weft. Tone color pattern was made of red-purple and green, which were the colors of the

priestly class for special worship. Identification of colored fibre was performed by using FTIR-ATR, UV-VIS and HPLC chromatogram.

Infrared spectroscopy is a simple, fast and effective way to characterize the molecular structure of substances. However, based on the absorption maximum (peak), characteristic for the energy vibration of individual bond in the molecule, we would get a complete knowledge about the corresponding chemical structure (Schwepe, H. Handbuch der Naturfarbstoffe, 1992.) On the Figures 1 and 2 are ATR/ FTIR spectra of historical silke textiles (green and red colored) as subtraction result (colored silk/uncolored silk; Thermo Scientific\* OMNIC Spectra Software). Obtained spectra correspond to the spectra of dyes on the fibre.

Based on the peaks (Fig.1 and 2-ATR/FTIR spectra) we can observe differences between the green and red dye. For green dye more pronounced are peaks in the area characteristic for the C = O connections (1715-1551 cm-1).

UV visible spectra of any colorant/dye showed its peaks at predominating wavelength, indicating main hue. For natural dyes, the spectra specially indicate different peaks for mixed colorants available in their extract in both UV and visible region. In Figures 3 and 4 in the extract of dyes from silk fibres (method 1 and method 2) the absorption spectrums reveal several peaks.

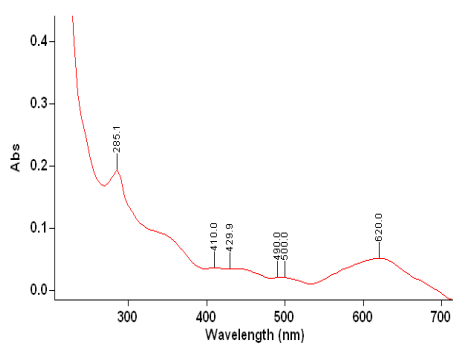

Figure 3. UV/VIS spectra of green colored silk (method 2).

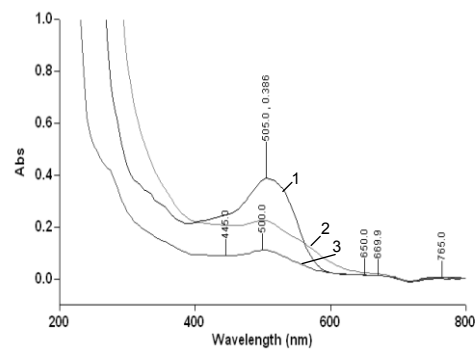

Figure 4. UV/VIS spectra of green and red colored silk: 1-red silk (method 2), 2-red silk (method 1), 3-green silk (method 1).

It is noted that an extract of green color (fig.3 and 4) has more characteristic peaks; 285.1 nm, 410-429 nm (yellow), 490-500 nm (red-orange) and 620 nm (blue), which confirms that it is a mixture of yellow, red and blue. In Figure 4 extract of red color (method 1 and 2) has one more pronounced peak at 505 nm. This peak according to the literature is characteristic of alizarin, which is one of the main components of madder natural dyes (*Purpura Peregrina*) in Dubrovnik area. Peak of 620 nm for green color, according to the literature, belongs to the purple color Murex - 6,6 'dibromoindigo, typical shells (*Murex trunculus*) in Dubrovnik area (Parac-Osterman, D et al.).

HPLC technique has been used by several researches to identify different components of synthetic, as well as natural dyes. HPLC data were recorded for the extracts of dyes contemporary fibres, which were obtained from the Conservation Department in Dubrovnik. In Figures 5 and 6 obtained peaks in retention time were compared with published values (Hofenk de Graaf J.H.). For green colored fiber (fig. 5) retention time, 32 min, confirmed the presence of dibromoindigo, however, lower retention time confirmed that in the natural dyes there was a series of indigoide components, alizarin and other flavonoides. In Figure 6.

expressive peak 21,627 min confirmed presence of alizarine, while retention times at 29,183 min and 32,191 min confirmed presence of purpurine and pseudopurpurine.



Figure 5. HPLC chromatogram of green colored silk (extraction method 2).

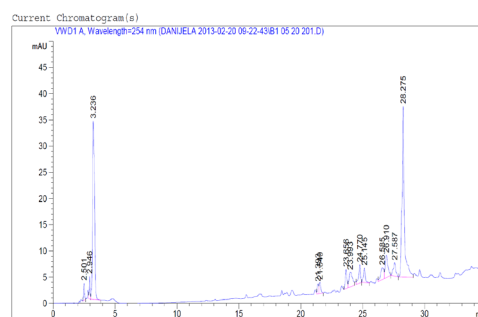

Figure 6. HPLC chromatogram of red colored silk (extraction method 2).

Considering that the historic fabric is from Dubrovnik with great certainty it can be concluded that for the coloring they used madder and shell Murex trunculus.

#### 4. CONCLUSION

Dyestuffs identified in the fragments studied in this work are in agreement with commonly reported dyestuffs used on Dubrovnik textiles. Aim of the research in this paper was to analyze red and green color on “19th century Velum sample”, historical textile from Dubrovnik. Based on the available literature, we can assume how coloration of the textile in subject was obtained, using natural dyestuff. Moreover, it is known that red hues were obtained using madder (*Purpura Peregrina*) or sea snails (*Murex Purpura* or *Trunculus*). The green sample was obtained by mixing yellow and blue (UV/VIS spectra, fig.3). FTIR – ATR analysis (Figure 1-2) of this sample revealed peaks at 1741,41 nm (>C=O group) and 1043,02 nm, which could both be assigned to dye. Comparison of chromatograms of extracts of dye from the “19th century Velum sample” with preliminary chromatograms revealed several peaks: retention time at 21,627 min confirmed presence of alizarine, while retention times at 29,183 min and 32,191 min confirmed presence of purpurine and pseudopurpurine.

#### REFERENCES

- Raymond J., B. Krekić, 1957. Dubrovnik et le Levant (1280-1460), en serbe, *Revue des études byzantines*, vol. 15, n° 1, pp. 223-224  
<http://www.muo.hr/06/05/2012>
- Schwepe, H., 1992. *Handbuch der Naturfarbstoffe: Vorkommen, Verwendung, Nachweis, Ecomed*, Landsberg am Lech.
- Parac-Osterman, Đurđica; Ficović, Antonio; Đurašević, Vedran; Sutlović, Ana.; Process of obtaining and analyses of purple dye from *Murex Trunculus*//*6th International Textile Clothing&Design Conference – Magic World of Textiles*, October 7th to 10th 2012, DUBROVNIK, CROATIA / Dubrovnik pp 262-265
- Hofenk de Graaf J.H. 2004. *The Colourful Past*, London WIT 5HJ.

*Address: Đurđica Parac-Osterman, Ph.D.Prof. University of Zagreb,  
 Faculty of Textile Technology, Prilaz baruna Filipovica 28a, 10000 Zagreb, Croatia  
 E-mail: djparac@ttf.hr*



# Effect of Background Colour on Monitor Characterisation

Marjan VAZIRIAN, Stephen WESTLAND, Vien CHEUNG  
School of Design, University of Leeds

## ABSTRACT

A common solution for transferring images from one device to another without loss of colour fidelity is to characterise each device in terms of CIE tristimulus values. For example, it would be possible with appropriate characterisation procedures to convert the LCD RGB values to CIE XYZ values and vice versa. Characterisation of devices into a standard colour space that is independent of the device reduces the number of transformations which may be required for adequate performance. The first stage in characterisation is to linearise the data termed “gamma correction” for certain devices and then transform the linearised values in CIE XYZ tristimulus values. In order to determine the non-linearity of the characterisation and the matrix for linear conversion between RGB and XYZ it is normal to make colour measurements of certain colour patches displayed on the system. However, it is known that the colour measurements of the patches may vary with the colour and luminance of the background against which they are displayed. Lack of spatial independence is one of the factors that can cause this phenomenon. This raises the question of what the nature of the background should be for an optimal characterisation of a display system. It is likely that what is optimal will depend upon the intended application of the characterised display (for example, is it being used to display simple images in a psychophysical experiment or more complex images in some other setting). This research considers characterisation with four background conditions (white, grey, black and a new Mondrian-like coloured background) and explores the effect of these background effects on the characterisation model’s parameters and on the usefulness of the characterisation in various imaging scenarios.

## 1. INTRODUCTION

Modern display technology (LCD and LED) has become increasingly popular because of their low power consumption and versatility with respect to placement. To control such displays precisely, it is essential to understand the relationship between digital input values and output colours. Hence colorimetric characterization of a colour display device is a major issue for the accurate colour rendering of a scene. The GOG model (Berns and Katoh, 2002) has been a popular choice for monitor characterization, particularly using the older CRT display technology. Some authors have advised using the GOG model for characterization of LCD displays in part because the nonlinearity of the displays may be not well suited to a gamma function but also because of lack of channel independence (Day et al., 2004). However, many LCDs effectively exhibit a gamma-like response because of manufacturers’ desire for them to behave more like a CRT display (and hence facilitate market uptake of the new technology). The work in this paper is part of a wider project to explore characterisation methods for LCD display technology and to assess the effectiveness of the GOG model despite theoretical concerns about its applicability. One particular issue that relates to both CRT and LCD technology is background colour against which samples used to estimate parameters for the nonlinear response of the display are measured. It is known that the colour of a patch displayed on a screen changes depending whether the background of the display

is grey, white or black. A grey background is often recommended and this is particularly appropriate if the calibration model is being used to display stimuli in a psychophysical experiment where colours are displayed against a grey background. Even for general use, where the background is not grey, then arguably grey is still a reasonable choice whereas white and black would represent more extreme positions. However, what if the characterization model is being used to display movies? Is a grey background still appropriate and what impact would motion in the background have on the measurements? It is this particular question that the work in this paper addresses.

## 2. EXPERIMENTS

A Minolta CS1000 spectroradiometer was used to make measurements of stimuli displayed on an LED HP DreamColor LP2480zx monitor housed in a darkened room. Measurements were made using the spectroradiometer mounted on a tripod at a measuring distance of 1 m. Stimuli were generated on the display using a MATLAB GUI so that specific colours (generated with known RGB values) in different backgrounds could be displayed. The colours were  $6 \times 6$  cm displayed on a background that otherwise filled the display screen. Measurements were made using the spectroradiometer of the centre of the colour stimulus. The spectroradiometer setting was such that the instrument automatically integrated light from the display until a sufficiently accurate reading was taken.

Fourteen colours were measured (see Table 1 for the RGB specifications) and these were chosen to include black, white, different greys, the additive primary colours (red, green and blue) and a few colours where all three primaries were moderately active. Measurements were taken for each colour displayed against three backgrounds: (a) grey, (b) Mondrian and (c) Mondrian with movement. The spectroradiometer measured CIE XYZ values (1964 standard observer) which were downloaded to a computer and subsequently analysed.

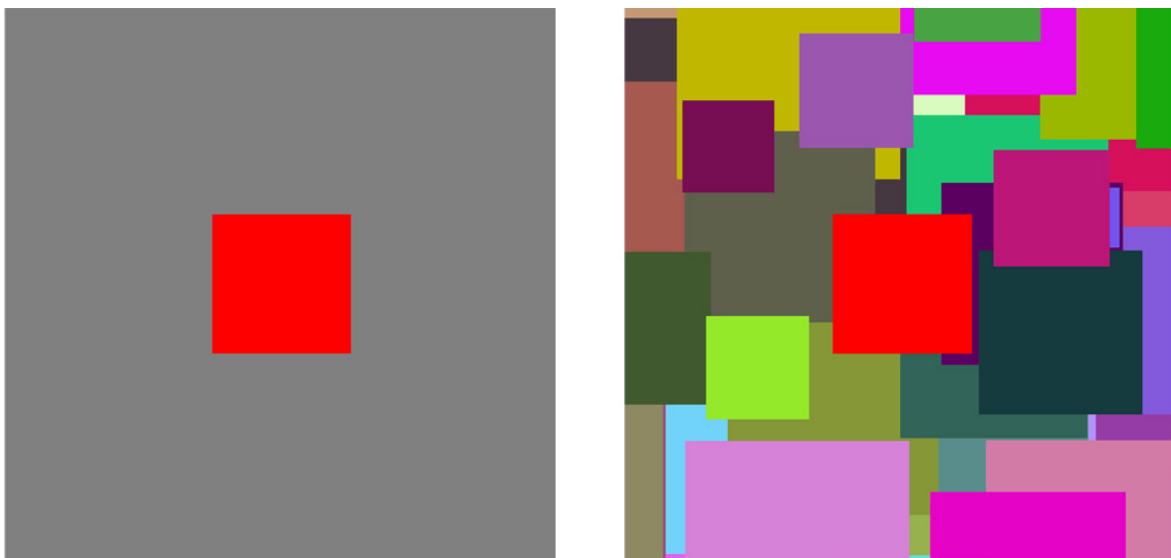

*Figure 1: Typical colour stimulus displayed against a neutral grey and Mondrian background*

Figure 1 shows an illustration of a typical colour stimulus displayed against a neutral grey and Mondrian background. The grey background RGB values were [128 128 128]. The Mondrian was generated using a specially developed algorithm and each patch of the

Mondrian pattern had a random colour. In the moving-Mondrian condition the Mondrian background moved across the display (diagonally) at a rate of about 0.01 m/s.

### 3. RESULTS AND DISCUSSION

Table 1 shows the CIE XYZ values that were measured for each of the colour stimuli in each of the three conditions (background). These values are absolute colorimetric measurements so that the luminance of the white, for example, when displayed on the grey background was 174.67 cd/m<sup>2</sup>.

Table 1: CIE XYZ measurements of the stimuli in each of the three conditions

			Grey background			Mondrian background			Movie background		
R	G	B	X	Y	Z	X	Y	Z	X	Y	Z
0	0	0	0.65	0.63	0.86	0.65	0.64	0.92	0.77	0.75	1.02
255	255	255	171.23	174.67	184.60	171.10	174.60	184.60	169.29	172.96	183.81
50	50	50	4.98	5.07	5.51	5.07	5.19	5.53	4.91	4.98	5.51
128	128	128	39.41	40.93	42.60	39.48	41.03	42.70	38.61	40.09	41.86
200	200	200	106.00	109.83	116.23	106.00	109.87	116.30	104.67	108.45	115.15
255	0	0	96.47	44.86	1.91	96.35	44.81	1.99	95.07	44.25	2.14
0	255	0	43.35	116.73	9.34	43.43	116.77	9.47	43.07	115.84	9.46
0	0	255	33.08	14.76	175.60	33.04	14.74	175.47	32.98	14.77	174.73
128	180	50	44.28	69.20	9.98	44.29	69.22	10.08	43.55	68.26	9.87
128	50	180	39.13	20.42	87.28	39.17	20.48	87.22	38.51	20.09	86.46
50	128	180	29.00	35.89	88.67	29.09	35.95	88.63	28.60	35.24	87.78
180	128	50	57.45	49.40	7.99	57.42	49.38	8.12	56.55	48.55	7.88
50	180	128	31.75	63.32	44.50	31.81	63.37	44.62	31.28	62.47	43.73
180	50	128	55.01	28.03	41.13	55.05	28.09	41.25	54.27	27.61	40.59

The data in Table 1 were converted to CIELAB L\*a\*b\* values (using the white from the grey-background condition as the white point) so that the white for the grey-background condition (only) had values of L\* = 100 and a\* = b\* = 0.

CIELAB ΔE values were computed between the colours with the Mondrian and movie backgrounds and the corresponding colours with the grey background. Table 3 shows the colour differences that resulted.

### 4. CONCLUSIONS

The colour difference between the Mondrian-background condition and the grey-background condition was, on average, 0.25 CIELAB units. However, the mean colour difference for the movie-background condition was 0.70 and this is statistically different from the Mondrian-background condition ( $p < 0.05$ ). This suggests that using a static grey background for the characterisation samples might not be the best strategy for a display-characterisation model that will be used for display of moving images.

Table 2: Colour differences between Mondrian- and movie-condition backgrounds and the grey-condition backgrounds.

			Grey v Mondrian	Grey v Movie
R	G	B	$\Delta E$	$\Delta E$
0	0	0	0.59	0.74
255	255	255	0.06	0.59
50	50	50	0.57	0.50
128	128	128	0.06	0.53
200	200	200	0.05	0.46
255	0	0	0.71	2.46
0	255	0	0.35	0.88
0	0	255	0.03	0.53
128	180	50	0.21	0.53
128	50	180	0.21	0.41
50	128	180	0.16	0.72
180	128	50	0.37	0.61
50	180	128	0.10	0.43
180	50	128	0.08	0.36
Average			0.25	0.70

### REFERENCES

- Berns, R.S., R.J. Motta and M.E. Gorzynski, 1993a. CRT colorimetry part 2. *Metrology. Color Research & Application*, 18, 315-325.
- Berns, R.S., and N. Katoh, 2002. Methods for characterising displays, in *Colour Engineering*, P. Green and L.W. MacDonald (eds) John Wiley & Sons, Ltd, Chichester.
- Day, E.A., L. Taplin and R.S. Berns, 2004. Colorimetric characterization of a computer-controlled liquid crystal display. *Color Research & Application*, 29, 365-373.

*Address: Marjan Vazirian, School of Design,  
University of Leeds, Leeds LS2 9JT, UK  
E-mails: sd09mv@leeds.ac.uk, s.westland@leeds.ac.uk, t.l.v.cheung@leeds.ac.uk*

# Cross-media Colour Reproduction in Mobile Devices

Maria GEORGOULA, M Ronnier LUO, Vien CHEUNG  
School of Design, University of Leeds

## ABSTRACT

Accurate and preferred cross-media colour reproduction is a topic of constant interest and research as technology advances and new media are introduced. In recent years, the massive production of advanced mobile devices has spread the usage of high quality mobile displays to more consumers. Therefore, the question whether these displays can be successfully colour managed arose. This study anticipates to explore both the possible methods of achieving successful colour management for mobile displays as well as the weaknesses and the constraints of this area. Potentially, the factors that affect colour appearance in mobile devices will be identified and modelled. Psychophysical experiments comparing variations of softcopies against a referential hardcopy were conducted. The observers rated the unmodified and some of the modified softcopies as accurate reproductions of the referential hardcopies. This suggests that successful cross-media reproduction is achievable with appropriate image processing and colour management.

## 1. INTRODUCTION

The usage of mobile devices has been significantly increasing over the last decade. Smartphones and tablets are daily employed for personal and professional purposes. They are widely used for advanced applications including online shopping and so-called printing on-the-go. However, it is noted that colours are often not the same between different media; like between softcopies and hardcopies. Extensive efforts have been made in the context of colour management for accurate colour reproduction amongst various media; especially for desktop displays. There is yet a need to improve the colour fidelity of mobile devices even though the technology changes rapidly.

Comparing softcopies and hardcopies is a common real life application and previous studies have provided useful information in this area. Gatt *et al.* (2004) have shown that appearance characteristics of softcopies are assignable to hardcopies under proper processing. Even though this study was based on a desktop display; it can be assumed that this attribute is also applicable to other displays with proper modifications. Another study has shown that adaptation during comparisons depends largely on the display's white point (Sueeprasan and Luo 2003). Experiments with mixed adaptation conditions revealed that adaptation was independent from alternations in illuminants and luminance levels. This can be proven useful characteristic for mobile devices as these are used under a variety of conditions.

Identifying and quantifying the parametric effects on the colour appearance of mobile devices will assist to effectively colour manage these in the future. For this purpose, CIECAM02 colour appearance model was used in this study, as this model is also recommended by CIE for colour management. So, comparative categorical judgement was employed to evaluate hardcopies and softcopies based on colour and image processing.

## 2. EXPERIMENTAL METHODS

The experimental apparatus consisted of two modi operanti; one using a desktop display and the other using a mobile device. For the former, softcopies were displayed in dark conditions while hardcopies were displayed within a viewing cabinet. For the latter, both softcopies and hardcopies were displayed within a viewing cabinet. For each modus operanti, the softcopies and hardcopies had identical size which was defined by the short edge of the display area.

### 2.1 Experimental Apparatus and Psychophysics

The viewing conditions were maintained the same for both modi operanti. Viewing conditions for practical appraisal described by the ISO 3664 were employed as these consociate with the requirements within the graphic arts and printing industries (ISO 2009). These are D50 illuminant with illuminance  $500 \pm 125$  lux (luminance approximately  $100 \text{ cd/m}^2$ ) and grey neutral matt surround surfaces. Additionally, previous research for mobile devices at diverse viewing conditions has shown that colour appearance deteriorates in very bright surround (Park *et al.* 2013). The viewing position was set vertical coplanar at 50 cm distance for both modi operanti as it was important to avoid any emitting glare.

The experimental devices were also adjusted according to the viewing conditions described. The desktop display used was an EIZO ColorEdge CG220 22.2" TFT LCD display which was calibrated for use in D50 and luminance  $100 \text{ cd/m}^2$ . LCD is known to produce stimulus by twisting through voltage the structure of liquid crystals. This type of displays requires a backlight source which means that light is emitted even in the dark areas. The mobile device used was a Samsung Galaxy S II with 4.27" AMOLED display which was only adjusted at luminance  $100 \text{ cd/m}^2$ . Due to the mobile device's infrastructure, no calibration was completed and its performance was considered as a black box device. OLED technology is relatively recent with its use being increasing. In contrast to LCD, OLED creates stimulus by applying voltage to organic molecules which emit light. This signifies that no backlight source is needed thus it has a black point whose luminance is only affected by the reflective properties of the surface's materials. The hardcopies were printed in satin photo paper by a HP Designjet Z3200PS printer with ICC profile for this material and absolute colorimetric rendering.

Categorical judgement by short-term memory comparison using the hardcopies as reference stimuli was employed for the experiments. This was chosen for satisfying both the aims of the experiments and restrictions applied by the experimental devices. On one hand, it was desired to evaluate the reproductions having complete adaptation to the current viewing conditions. On the other hand, it was desired to evaluate stimuli under different surround. Braun *et al.* (1996) had investigated the suitability of viewing techniques for colour appearance experiments. They suggested that memory viewing technique is better for such experiments as this also applies in real applications.

### 2.2 Image Processing

Given that no characterisation model could be run in the mobile device but still a colour management method was needed, softcopies were prepared in a way to embed the colour management. The characterisation models of the displays were applied directly to the image data and the processed files were displayed by appropriate image viewer software. Four original images were chosen and processed accordingly so that the colour management procedure starts with XYZ data (adapted in D50 illuminant where required). Hardcopies were directly printed from CIELAB colour space while different renderings were created for the

softcopies. Images were converted in CIECAM02 data, then lightness and colourfulness attributes were transformed both linearly and sigmoidally. Colourfulness was chosen based on the study by Choi et al. (2008) in which colourfulness was found as one of the key factors affecting colour appearance. Thereafter, data were converted back to XYZ so that the characterisation models to be applied and RGB image files to be displayed during the experiments. The image processing is summarised in Figure 1.

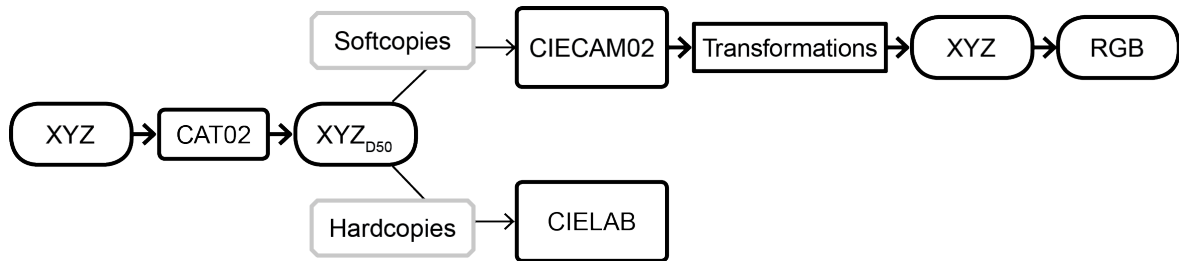

Figure 1: Flowchart illustrating the image processing of softcopies and hardcopies.

### 3. RESULTS AND DISCUSSION

The inter- and intra-observer variations, calculated by CV in percentage, for the desktop display are 19% and 12% respectively whilst for the mobile device are 21% and 11% respectively. These comply with results from similar studies (Choi *et al.* 2008).

Observers' responses were above the average for both displays and the majority laid in the high categories of the scale. This suggests that successful cross-media reproduction was achievable for each modus operandi. However, comparing the responses for the displays against each other, it is clear that these were generally higher for the desktop display (Figure 2). Nevertheless, the softcopies whose colourfulness was decreased the most were assigned in higher category in the mobile device than at the desktop display. This implies that colourfulness appeared boosted in the mobile device. Unfortunately, this trend was only observed for this transformation and there are currently insufficient data to justify it.

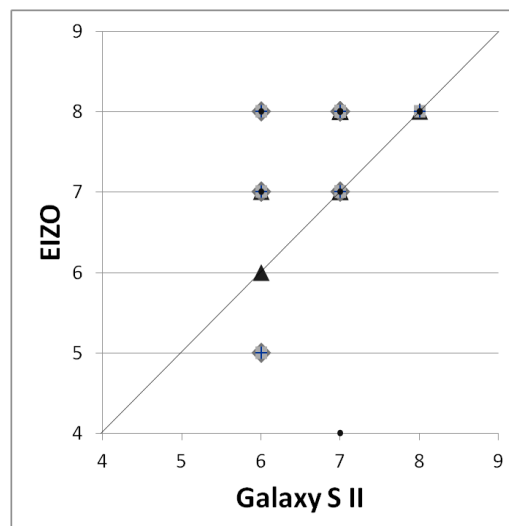

Figure 2: Scaled categories for EIZO display against Galaxy S II mobile device.

Finally, the transformations for the softcopies were compared amongst each other. It was found that the same transformations had homogeneous results for each of the four images. Based on this, it was estimated that observers were more sensitive in colourfulness changes rather than lightness; which agree with the study by Choi *et al.* (2008).

#### 4. CONCLUSIONS

The present results support that cross-media reproduction for mobile devices is achievable under the experimental conditions considered. At the same time, new concerns arise as the cause of discrepancies between the two displays may be due to the size or surround effect or even to the mobile device's proprietary image workflow. For this reason, new experiments are in progress in order to compare among different viewing conditions and to improve the experimental apparatus. Moreover, investigation under diverse surround conditions is desirable as only colour patches were examined by previous studies (Park *et al.* 2013). In conclusion, the new findings will further contribute to the development of colour management methods for mobile devices and small displays.

#### ACKNOWLEDGEMENTS

Special thanks to Dr. P. Green for his advices to the design of the experiments, to the State Scholarships Foundation of Greece for the sponsorship and to all the observers who took part in the psychophysical experiments.

#### REFERENCES

- Braun, K.M., M.D. Fairchild and P.J. Alessi, 1996. Viewing Techniques for Cross-Media Image Comparisons, *Color Research and Application* 21(1) 6-17.
- Choi, S.Y., M.R. Luo, M.R. Pointer and P.A. Rhodes, 2008. Investigation of Large Display Color Image Appearance I: Important Factors Affecting Perceived Quality, *Journal of Imaging Science and Technology* 52(4) 1-11.
- Gatt, A., S. Westland and R. Bala, 2004. Testing the Softproofing Paradigm, *12th Color Imaging Conference* at Springfield.
- ISO, 2009. *ISO 3664:2009 Graphic Technology and Photography - Viewing Conditions*.
- Park, Y., M.R. Luo, C.J. Li, Y. Kwak, D-S. Park and C. Kim, 2013. Correcting Veiling Glare of Refined CIECAM02 for Mobile Display, *Color Research and Application* 38(1) 14-21.
- Sueeprasan, S. and M.R. Luo, 2003. Applying Chromatic Adaptation Transforms To Mixed Adaptation Conditions, *Color Research and Application* 28(6) 436-444.

*Address: Maria Georgoula, School of Design,  
University of Leeds, Leeds, LS2 9JT, UK  
E-mails: cp09mg@leeds.ac.uk, m.p.georgoula@gmail.com,  
m.r.luo@leeds.ac.uk, t.l.v.cheung@leeds.ac.uk*



# Objective Evaluation of Fabric Pilling Using Digital Image Processing

Min-Ho JUNG,<sup>1</sup> Peter A RHODES,<sup>1</sup> Matthew CLARK<sup>2</sup>

<sup>1</sup> School of Design, University of Leeds

<sup>2</sup> Society of Dyers and Colourists

## ABSTRACT

This study aimed to develop and evaluate a new objective pilling assessment method. Visual grading was carried out by non-experts and two expert groups. The proposed system for image acquisition utilised three linear LED sources to obtain good pill-background contrast. Pill measurement was then computed from a statistical analysis of the image. The performance of this new objective technique was verified by comparison with subjective observer grading.

## 1. INTRODUCTION

Pilling of fibres on the surface of fabrics is undesirable and has long been considered as a big problem in the apparel industry. It not only detracts from the appearance and handle of the substrate but it also, in some instances, affects the service life of the product. The pills are formed as a result of rubbing or friction against the same fabric or another object during wear and/or washing (Cooke 1985). Various methods have been developed and testing standards proposed, but there is still need for improvement of objective assessment. Most of the objective methods can be divided into two components: the apparatus for image capture and digital image processing. In the former stage, it is generally accepted that illumination setup is the key to differentiating between the pills and their background. According to the ISO standard (BS EN ISO 2000), good pill-background contrast indicates that shadows produced by pills appear distinct and dark due to the fact that light cannot penetrate the pills and that other areas appear bright. Since it is difficult to identify pills on a highly textured fabric, a method to remove texture structure was critical to the analysis of fabric samples in the latter stage of digital image processing.

## 2. SUBJECTIVE PILLING ASSESSMENT

Subjective pilling assessment was conducted to grade the degree of a piling fabric samples. Twenty fabric specimens were judged three times in random order during the visual grading session. The five types of fabrics used in the experiment differed in both texture and colour. Each type consisted of four specimens pillled to different degrees. Adopting the conditions recommended by ISO, a pilling assessment viewer was used to maintain the specified geometry of illumination, specimen and observer. Twenty-two observers that participated in the experiment can be divided into three groups: one consisting of non-experts and the others experts. The former were fourteen postgraduate students from the University of Leeds. The latter were workers having day-to-day industrial experience of carrying out this type of assessment and were separated into two groups, five and three observers, according to the company. The non-expert and one of two expert groups used the five original reference samples of each type fabrics during the visual grading session. As an exception, the other group performed the judgment of pilling grade without reference samples.

### 3. OBJECTIVE PILLING ASSESSMENT

The overall subjective pilling grading method has a number of limitations such as being a time-consuming and subjective process. To overcome these problems, an objective pilling assessment is proposed. This method can be carried out without experts or multiple observers. Hence, it can be said that objective pilling assessment is more efficient than the previous method in terms of time and cost. The determination of objective pilling grade using digital image processing can be divided into two stages: image preparation and digital image analysis.

#### 3.1 Image Preparation

Image preparation for digital image processing was divided in three steps: image acquisition, illumination uniformity correction and normalisation. The proposed system for image acquisition is shown in Figure 1. The apparatus consists of three linear LED light sources, a digital camera and a plate for the sample. It was determined that the illumination set up is one of the most important factors for obtaining good pill- background contrast. In the new imaging system, LED lights were used as the source. Since this light has a more directional nature, it facilitates obtaining high contrast between pills and the fabric background. Three LED units were used; each unit consisted of several individual LEDs. The LED sources were designed to light the sample from three different directions in which each angle between two light sources was  $120^\circ$ . **Using these LED lights, four images were captured under four different lighting conditions: three images with a single light on and one image with all three lights on.** The locations of the shadows on the image were changed according to the angles of the lighting. This result can help identify pills through the difference in their shadows in each of the images. Also, analysing shadows can be utilised as a means of reducing fabric texture and removing noise. In the acquisition system, a digital camera was used as the detector due to its non-connect nature. This means that the delicate specimens could avoid damage or distortion. The RGB images were converted to greyscale to reduce their size and then illumination uniformity correction was applied to compensate for variations in the image resulting from the unevenness of the illumination used. Finally, a normalising process was employed to overcome the uneven surface of images caused by the flexible nature of fabric specimens. The z-score was used to standardise and hence compare data from different populations (Lewis 1999).

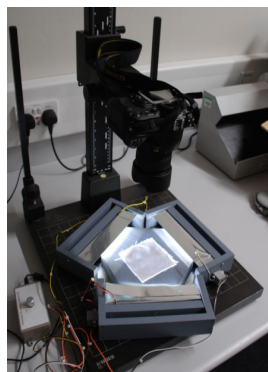

Figure 1: The image acquisition system.

#### 3.2. Digital Image Analysis

Digital image processing consists primarily of three steps: texture removal, pill enhancement and pill measurement. Texture removal is the key to eliminating the periodic pattern whilst the pills and other defects were preserved. Using the Fast Fourier Transform (FFT), the

sample image represented in the spatial domain was transformed to the frequency domain. The periodic structure of the fabric appears as distinct peaks in the power spectrum and other more random components such as pills and fuzz result in frequencies spread out over the background. When analysing whether the locations of peaks were selected exactly, the log transformation is more useful. Since the values of the Fourier spectrum were in the range  $10^6$  or higher, some visual detail is lost in 8-bit displays, while the log transform compresses the dynamic range resulting in a more useful tool to check peak points (Xu 1997). Using power thresholds, which were carried out twice for the image of higher dynamic range, the areas of peaks were found. After removing periodic pattern of fabrics, pill enhancement was applied to remove unwanted noise and shadows produced by threads. The first step of pill enhancement was pill identification using the four different images from three light sources positioned at three different angles. One image captured with all three lights on was combined with each image captured with a single light on using ‘min’ function (Gonzalez 2004). Next, a threshold was applied to remove minor noise such as fuzz and noise. Finally, the three images were combined to one image after noise reduction.

#### 4. RESULTS AND CONCLUSIONS

In comparing the results from the two expert groups shown in Figure 2, the grading by one expert group for the majority of samples was more widely spread than the other. The reason for this was identified as being the use of reference samples. It can be concluded that memory judgement is far less reliable for pilling assessment.

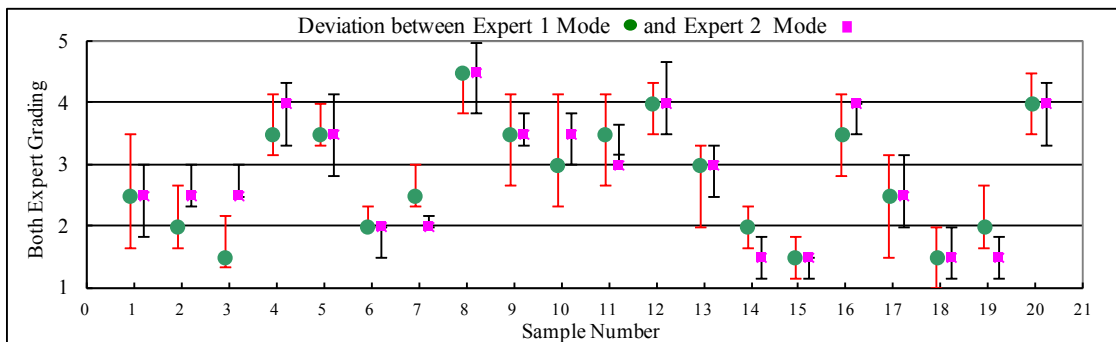

Figure 2: Comparison between expert and non-expert visual assessment.

From the results of the comparison between non-experts and the combined experts shown in Figure 3, the error bars for non-experts were obviously big. It can be said that grading between non-expert observers exhibited only a weak agreement; however the average grade of the non-experts were close to those of the experts. This means that the patterns of both modes are considerably consistent and so they can be used as a reference.

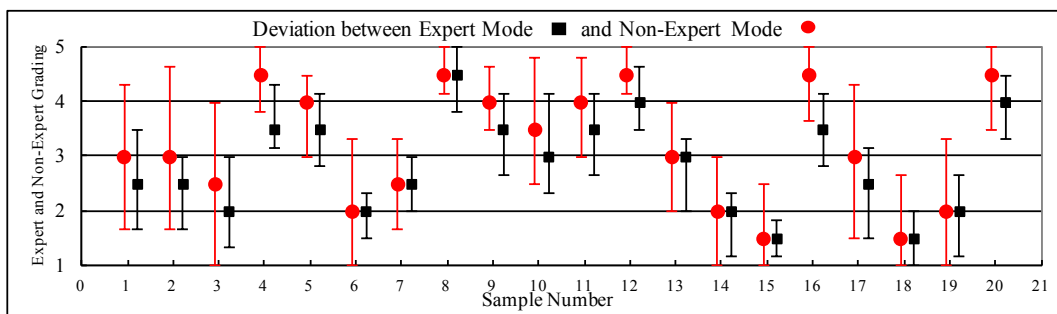

Figure 3: Comparison between expert and non-expert visual assessment.

From digital image analysis, six features were extracted: pill count (number), maximum size, average size, standard deviation, area percentage and density of pills. Figure 4 shows the comparison between the results of objective pill assessment and expert grade. The red parallel lines indicate uncertainty with the black fitted lines falling within this range of variation. In this way, it can be seen that points of features of pills were located in the range between or close to the two red lines. Therefore, considering the nature of variation of visual assessment, variation  $\pm 5$ , it can be said that the correlation of objective pill assessment is better than the result explained by statistical method, R and R-squared.

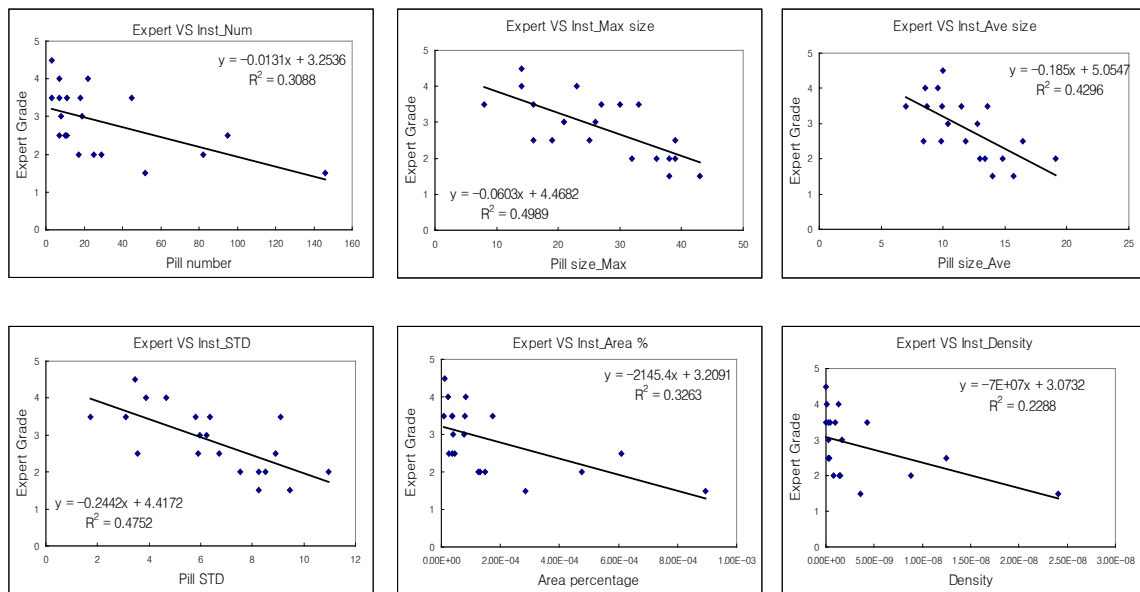

Figure 4: Objective method versus expert grade.

Using polynomial models,  $20 \times 3$  complexity, measured properties were converted into predicted grades. The coefficient of determination between predicted grade and expert grade was obtained as 1. Therefore, there is no doubt that the performance of the new objective pilling assessment is significantly reliable.

## REFERENCES

- Cooke, W.D., 1985. Pilling attribution and fatigue. *Textile Research Journal* 55(7) 409-414.
- Gonzalez, R.C., R.E. Woods and S.L. Eddings, 2004. *Digital image processing using MATLAB*. New Jersey: Pearson Education, Inc.
- ISO, 2001. *BS EN ISO 12945-1:2001:Textiles – Determination of fabric propensity to surface fuzzing and to pilling, Part 1: Pilling box method*.
- Lewis, J. P., and A. Traill, 1999. *Statistics Explained*, Addison-Wesley.
- Xu, B., 1997. Instrumental evaluation of fabric pilling. *Journal of the Textile Institute* 88(1) 488-500.

Address: Min-Ho Jung, School of Design,  
 University of Leeds, Leeds, LS2 9JT, UK  
 E-mails: [ccd6mhj@leeds.ac.uk](mailto:ccd6mhj@leeds.ac.uk), [p.a.rhodes@leeds.ac.uk](mailto:p.a.rhodes@leeds.ac.uk),  
[matthewclark2009@hotmail.co.uk](mailto:matthewclark2009@hotmail.co.uk)

# A New Image Enhancement Approach for Seamless Image Stitching

Jin-Ling LIN, Mei-Chun LO, Yui-Liang CHEN, Cheng-Yen WU  
Department of Information Management, Shih Hsin University

## ABSTRACT

The objective of this study was to propose an image-stitching system which can be used to enhance the functionality and the resolution quality of panorama in image-stitching process. Moreover, the proposed approach could speed up the image-stitching process via a parallel approach. This proposed system was modularized into four modules, including image stitching, image expansion, image cutting, and color fusion. To evaluate the performance of the proposed approach, a computer system was developed and applied into images via the parallel processing of both image expansion and color fusion. Simulation results showed that the proposed image-stitching system can produce a segmented seamless and high-resolution panorama for a satisfactory applicability in the real world.

## 1. INTRODUCTION

A Panorama provides a wide-angle view or representation of a painting (Wikipedia, Panorama 2013), gallery, photography, or three-dimensional model (Wen 2013). Panoramic paintings were very popular ways to represent landscapes and historical events in mid-10<sup>th</sup> century. Following the panoramic paintings, panoramic photography became the most common method for creating wide views. In the late twentieth century, digital photography using image stitching, which is a common inexpensive way of producing panoramic pictures (Wikipedia, Comparison of photo stitching applications 2013), create extremely high resolution (gigapixel) panoramic images.

Panoramas have been extensively applied in daily life to approach smart living. Google map is the most typical daily real world application example of panorama (Google 2013). Most researches focused on how to perform seamless image stitching (Suen et al. 2007), but neglected the color differences on the panorama after image stitching (Ward 2006) or considered only RGB-based color matching, whose color space is device dependent. The proposed method used in this paper considers color fusion based on different objects, which can create seamless image stitching; and device independent color space, which can maintain the quality of these stitching images across various imaging media.

## 2. APPROACH DESCRIPTION

Performing color fusion, using device-independent color space, on the stitching image to create seamless panorama was the focus of this research. There were four modules in the proposed system: image stitching, image expansion, image cutting, and color fusion. The corresponding process flow is shown in Figure 1. First, Accord.NET (Wen 2013) is applied to find the interesting points and stitch images. Then, image expansion is used to expand the stitching image, based on lightness, chroma, or hue (LCH) along the edge of image considered. Each vertical line of the stitching image can, thus, have the same pixels. Furthermore, image cutting is performed to keep desirable image size. Finally, color fusion is applied on the stitching image to create seamless panorama.

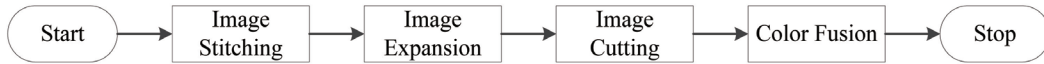

Figure 1: The process flow of the proposed seamless image stitching.

For color fusion, stitching region is first identified based on both hue and lightness of the stitching image considered. Then, the system performs k-means clustering on stitching region according to its lightness, chroma, or hue (LCH) to find possible objects within the stitching region. For simple texture, only lightness is used to improve the color difference of objects within stitching region. LCH is simultaneously applied to adjust the color difference for objects with complicated texture. The procedure is shown in Figure 2.



Figure 2: The procedure of the proposed color fusion approach.

### 3. IMPLEMENTATION

To evaluate the performance of the proposed approach, a computer system was developed and applied into different images via the parallel processing of image expansion and color fusion. Figure 3 shows the flowchart of the proposed system. For image expansion, the stitching image was divided into two parts: top and bottom. Two threads were used, one for the top part and the other for the bottom part, to perform image expansion, simultaneously. Each object within the stitching region used a thread to process color difference, respectively.

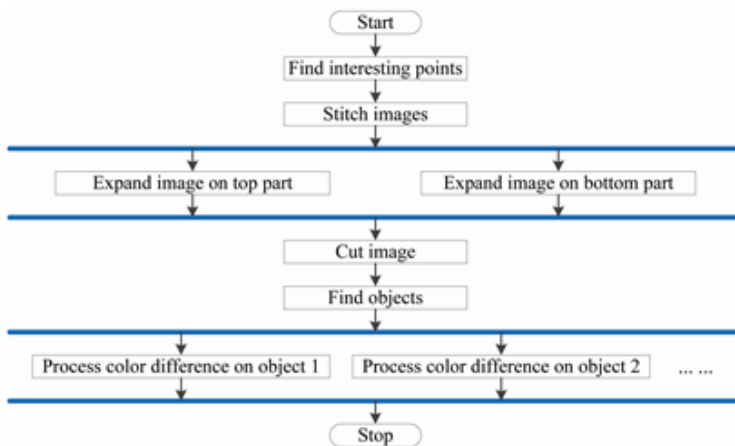

Figure 3: The flow-chart of the proposed system.

The outcome of each module is shown in Figure 4. Figure 4(a) and 4(b) are two images to be stitched. The stitching image is shown in Figure 4(c). Figure 4(d) is the outcome of image expansion based on the stitching image, shown in Figure 4(c). K-mean clustering found two objects – one is sky and the other is mountain, within the stitching region, marked out by red rectangle in Figure 4(d). The final outcome of the stitching image is shown in Figure 4(e).

### 4. SIMULATION

Performances of the proposed approach were evaluated by the rendition quality of those stitching images tested. Testing cases of different kinds of images – indoor and outdoor, were simulated and analyzed. Figure 5 is an example of indoor original images and their

stitching image. Original images, to be stitched, are shown in Figure 5(a) and (b). The stitching images created by the proposed approach and Photoshop are in Figure 5(c) and (d), respectively. An example of outdoor images and their stitching image is shown in Figure 6. Figure 6(a) and (b) are images for stitching. Figure 6(c) and (d) are the stitching images created by the proposed approach and Photoshop, respectively.

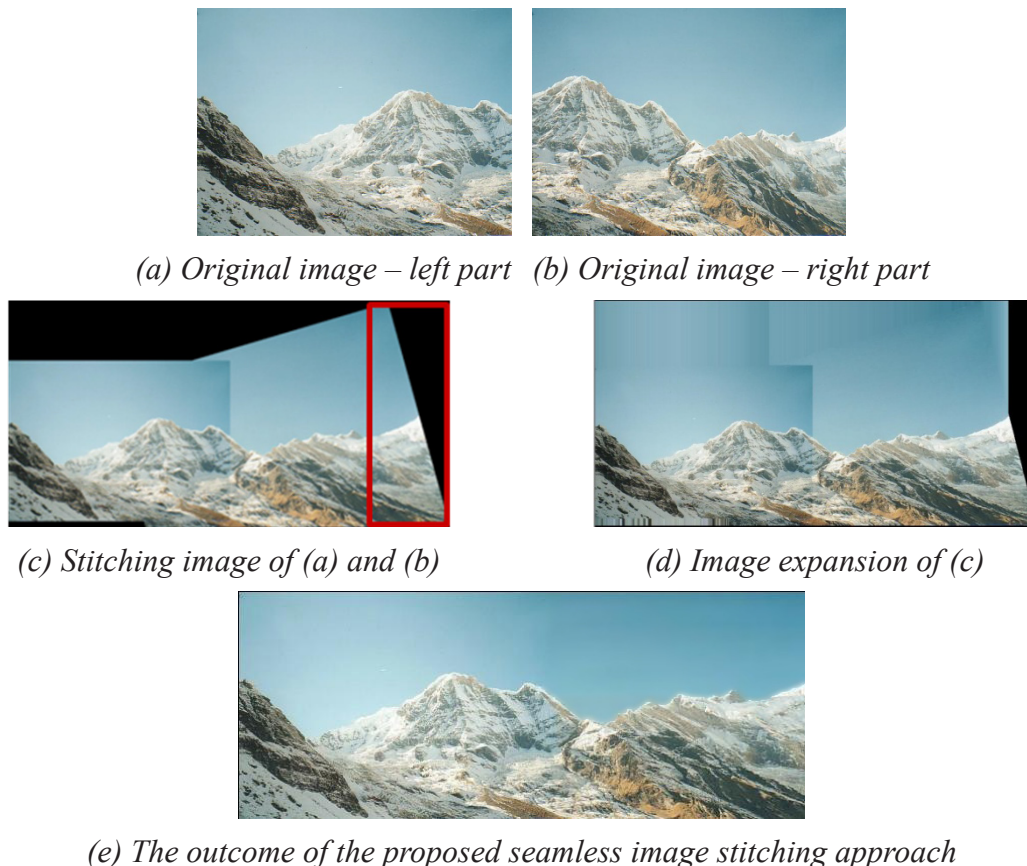

Figure 4: An example of the proposed seamless image stitching approach.

## 5. CONCLUSION

This paper presents a simple and efficient approach for stitching images and developed a computer system based on the proposed approach. The developed computer image-stitching system is not only an experimental tool for performance analysis, but also a system which can provide practical solutions for making panorama by image-stitching. Using device independent color space and object-based stitching region to perform color fusion could create high quality seamless image stitching, as shown in Figure 5(c) and 6(c).

## REFERENCES

- Google, 2013. *Google Map*. Retrieved May 14, 2013, from Google: <http://maps.google.com/>
- Souza, C.D., 2012. *Automatic Image Stitching with Accord.NET*. Retrieved May 14, 2013, from Code Project: <http://www.codeproject.com/Articles/95453/Automatic-Image-Stitching-with-Accord-NET>
- Suen, T.S., Y.E. Lam, and K.K. Wong, 2007. Photographic stitching with optimized object and color matching based on image derivatives. *The International Online Journal of Optics*, 15(12), 7689-7696.

Ward, G., 2006. Hiding seams in high dynamic range panoramas. *APGV '06 Proceedings of the 3rd symposium on Applied perception in graphics and visualization* (pp. 150-150). ACM.

Wen, M., 2013. *Mark Wen - Panorama*. Retrieved from <http://www.markwen.com/vr>

Wikipedia, 2013. *Comparison of photo stitching applications*. Retrieved from Wikipedia: [http://en.wikipedia.org/wiki/Comparison\\_of\\_photo\\_stitching\\_applications\\_\(software\)](http://en.wikipedia.org/wiki/Comparison_of_photo_stitching_applications_(software))

Wikipedia, 2013. *Panorama*. Retrieved from Wikipedia: <http://en.wikipedia.org/wiki/Panoramic>

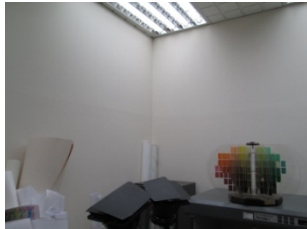

(a) Original image – left part



(b) Original image – right part

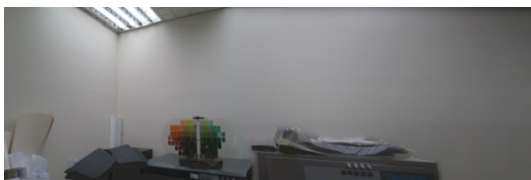

(c) Stitching by the proposed approach



(d) Stitching image by Photoshop

Figure 5: An example of indoor images for image stitching.



(a) Original image – left part

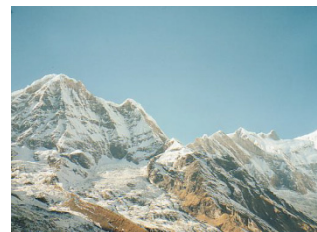

(b) Original image – right part



(c) Stitching by the proposed approach



(d) Stitching image by Photoshop

Figure 6: An example of outdoor images for image stitching.

Address: Jin-Ling Lin, Department of Information Management, Faculty of Management, Shih Hsin University., No.1, Lane17, Sec. 1, Mu-Cha Rd., Taipei, Taiwan, R.O.C.  
 E-mails: {jllin,mcl,ychen}@cc.shu.edu.tw, M100662008@mail.shu.edu.tw



# Emphasis on Gloss appearance by Combination of 2D and 3D Projection Images

Shoji YAMAMOTO,<sup>1</sup> Natsumi HOSOKAWA,<sup>2</sup> Zui KAKU,<sup>2</sup> Norimichi TSUMURA<sup>2</sup>

<sup>1</sup> Tokyo Metropolitan College of Industrial Technology

<sup>2</sup> Graduate School of Advanced Integration Science, Chiba University

## ABSTRACT

We developed a display system for realistic gloss appearance by combining 2D and 3D projection images. For the realistic reproduction of gloss appearance, it is necessary to display the gloss of the object with high radiance and depth perception. A superimposing of 2D images with several projectors is useful for enhancement of radiance range. Same superimposing of 3D projectors has possibility to enhance the radiance range with depth perception. However, it is necessary to synchronize the right and left images at all projectors in superimposing 3D projection images, which is not practical for commercial use. Therefore, in this paper, we propose the combination of 2D and 3D projector system with controlling the depth information of gloss appearance in 3D projection image. By setting the 3D position of gloss appearance to the screen, it is possible to support the superimposing for enhancement of radiance range and stereoscopic reproduction for depth perception. The subjective evaluation was performed to confirm the effect of high radiance and depth perception in our system. As the results, we found that our system is effective to emphasize the reality of gloss appearance compared with conventional display.

## 1. INTRODUCTION

A realistic reproduction of various object is very important theme for computer graphics, photographics, and display system. This reproduction may be helpful as a simulation of product such as digital mock-up or rapid proto-typing system, which can reduce the cost and time. Since these simulations have influence to judge the value of final product, we should pay attention to the realistic reproduction, such as material property and shape of object (Yamamoto 2012).

For the material property, it is important to reproduce gloss appearance caused by the specular reflection on the object (Kerr 2009). When specular reflection is strong and sharp, we perceive the surface as smooth. When specular reflection is weak and dim shape, we perceive the surface as rough. Since the change of specular reflection has very wide dynamic range with relation to the smoothness of surface, it is necessary to reproduce the gloss appearance with high radiance and wide tone level. The superimposing method with multi projectors is useful to reproduce the high radiance and wide tone level of specular reflection (Oliver 2008).

The other important feature for realistic gloss reproduction is depth perception (Wendt 2008). This gloss appearance caused by the specular reflection has depth information as the reflected image of light source. The stereoscopic display system is useful for the representation of this depth information. By using 3D projector as the stereoscopic reproduction, the superimposing method with multiple 3D projectors has possibility to enhance the radiance with depth perception. However, it is difficult to superimpose the images of 3D projectors, since the right and left image with depth information is projected at different position on the

screen. An expensive instrument for synchronizing the right and left images is necessary to superimpose the 3D projectors. Therefore, in this paper, we propose the combination of commercial 2D and 3D projector system by controlling the depth information of gloss appearance in 3D projection image. The superimposing between 2D and 3D projection image is possible by setting the 3D position of gloss appearance to the screen. Depth perception is also generated by relative difference of depth information between gloss and surface of object in this system.

## 2. METHOD

In order to realize the high radiance and stereoscopic representation, we propose the combination system with 2D and 3D projector. At first, we confirm an appropriate superimposing technique by using two 2D projections. Next, we examine the superimposing method between 2D and 3D projector by controlling the 3D position of gloss appearance.

### 2.1 Superimposing 2D images

At first, the rule for superimposing is examined by using two 2D projectors. As shown in Fig. 1(a), we used high dynamic range image as an original image. This image was separated by an arbitrary rate to the two images, and these images were compressed by tone mapping, respectively. Two projectors were set by face to face across the screen, and each image was projected on the screen from front and back projection. By changing the superimposing rate and objects (sphere, blob, and bunny), we found the best combination by using a subjective evaluation with paired comparison.

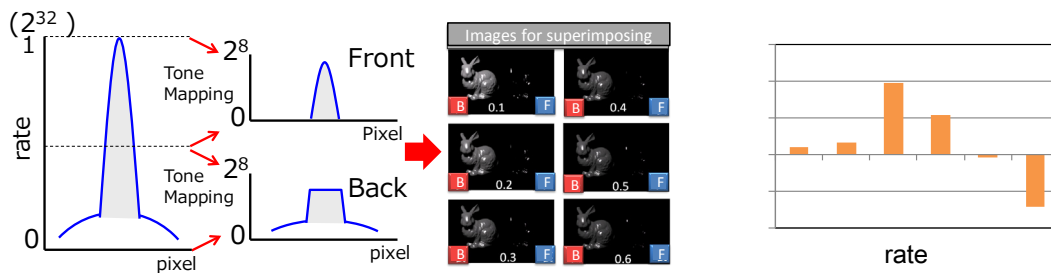

(a) Superimposing method

(b) Result of subjective evaluation

Figure 1: Results of evaluation for superimposing 2D images.

Based on an experimental result as shown in Fig. 1(b), the ratio of 3 from front projector to 7 from back projector indicates the best score in this research.

### 2.2 Superimposing 2D and 3D images

The superimposing between 2D and 3D projection image is possible by setting the 3D position of gloss appearance to the screen. In order to calculate the 3D position of gloss appearance, the specular stereo model become helpful (Blake 1990). According to this model, 3D position of gloss appearance is decided by distance of light source and curvature of surface on the object. However, it is difficult to decide the curvature of surface on the object uniquely, since the curvature indicates various values in various parts of an actual object. Therefore, in this research, spherical approximation is applied to obtain the unique curvature of surface on the object, which is calculated as an average of the distance between each points of surface and centroid of object.

For the experiment, we constructed the projection display with 2D and 3D projection images as shown in Fig.2(a). Two projection images were generated according to the procedure of section 2.1. Here, it is noted that the front projection image has only the specular reflection as 2D, and the back projection image has the diffuse and specular reflection as 3D stereoscopic image.

The experiment which explores the best depth position of 3D projection was executed in order to confirm our idea. In this experiment, the observers can change the depth of 3D projection by using arrow buttons on keyboard, and the most realistic appearance of gloss is decided by them as shown in Fig.2(b). Figure 2(c) shows the results of this experiment. Here, the expected depth position can be calculated by using observer's position, light position, and curvature of surface on the object with spherical approximation. As the result, we found that the best position of specular reflection in 3D projector matches up to the expected depth position.

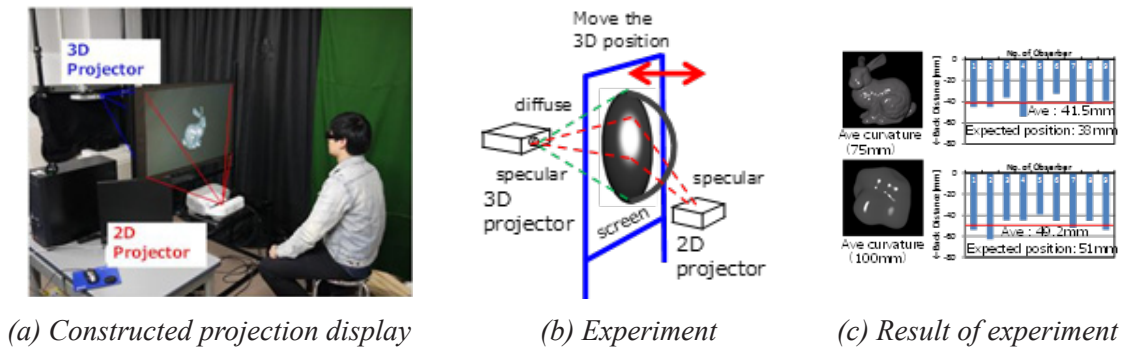

Figure 2: The consideration for the position of specular reflection in 3D images.

### 3. EVALUATION AND DISCUSSION

Finally, we confirmed the effect of our proposed reproduction, which was possible to support the superimposing for enhancement of radiance range and stereoscopic reproduction for depth perception. The subjective evaluation was performed by using paired comparison with ten observers. Three type of reproduction with two objects was randomly displayed in this evaluation, which is 2D & 2D superimposing display, only 3D display, and 2D & 3D superimposing display. Here, it is noted that the advantage of 2D & 2D superimposing display compared with only 2D display has already confirmed.

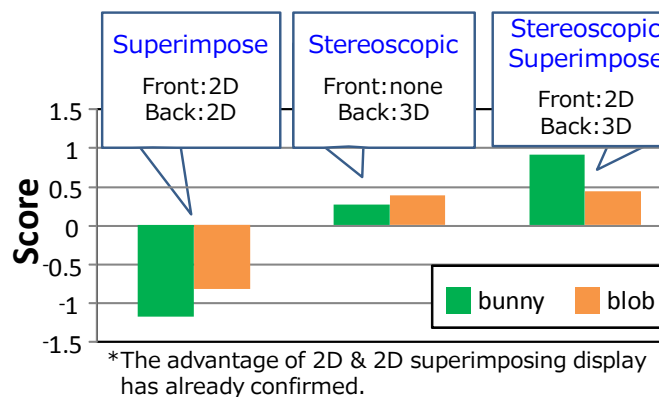

Figure 3: The result of subjective evaluation for superimposing 2D and 3D images.

#### 4. CONCLUSIONS

In this paper, we proposed realistic reproduction of gloss appearance by superimposing 2D and 3D projection images. This display system equipped with both high radiance and 3D reproduction required for realistic appearance. In order to match the of 2D and 3D, we set only 3D specular position on the screen. The subjective evaluation for two CG images indicate that our proposed method obtains the best score in comparison to the other methods.

The limitation of proposed system is originated by an assumption that the curvature of object is calculated as an average. There are misalignments of 2D and 3D if the surface curvature of object is extremely difference from average of curvature. In order to solve this problem, a detail adjustment should be considered that only the matched area between 2D and 3D is displayed.

#### ACKNOWLEDGEMENTS

This research was partially supported by the Ministry of Education, Science, Sports and Culture, Japan Grant-in-Aid for Scientific Research (C), 24500267, and Brain and Information Science on SHITSUKAN, 25135707, 2013.

#### REFERENCES

- Yamamoto, S., M. Sawabe, Y. Yamauchi and N. Tsumura, 2012. Ascertainment of perceptual classification for material appearance, *The 20th Color Imaging Conference (CIC20)* 94-99.
- Oliver, B., and D. Iwai, 2008. Superimposing dynamic range, *ACM Trans. Graph. Proceedings of ACM SIGGRAPH Asia*, 27(5): 150.
- Kerr, W.B., and F. Pellacini, 2009. Toward evaluating material design interface paradigms for novice users, *ACM Transactions on Graphics (Proc. SIGGRAPH)* 28(3), 26:1-9.
- Wendt, G., F. Faul and R. Mausfeld, 2008. Highlight disparity contributes to the authenticity and strength of perceived glossiness, *Journal of Vision* (8) 1-10.
- Blake, A., and H. Bülthoff, 1990. Does the brain know the physics of specular reflection? *Nature*, 343(6254) 165-168.

*Address: Assoc. Prof. Shoji Yamamoto, Information course, Faculty of Monozukuri  
Tokyo Metropolitan College of Industrial Technology,  
8-17-1, Minamisenjyu, Arakawa, Tokyo, JP  
E-mail: yamasho@acp.metro-cit.ac.jp*

# Constructing the Predict Model for Perceptual Image Quality using Non-Linear Models

Cheng-Min TSAI,<sup>1</sup> Shing-Sheng GUAN,<sup>1</sup> Wang-Chin TSAI<sup>2</sup>

<sup>1</sup> Graduate School of Design, National Yunlin University of Sci. and Tech., Taiwan

<sup>2</sup> Department and Graduate School of Product and Media Design, Fo Guang University, Taiwan

## ABSTRACT

This study established the predict model for perceptual image quality, and compared the non-linear and linear analysis method to assess perceptual image quality. This study focused on constructing a predict model of perceptual image quality. Ninety participants joined the visual assessment experiment. Four images were carefully selected from the ISO standard image by the focus group in the colour and image lab of NYUST. Each image was modulated by four physical attributes including lightness, chroma, hue angle, and contrast. All images were processed according to colour conversion and physical adjustment based on CIECAM02 function.

The results showed that lightness and chroma directly influenced the subjective feelings of the test subjects toward brightness and Colorfulness, respectively. The three criteria of image quality, preference, and naturalness are not easily directly influenced by the single variables of the four physical image attributes but rather by the interactive effect of the combination of these attributes.

## 1. INTRODUCTION

Recent colour science studies have used mathematical algorithms to predict perceptual image quality and subjective preference (Choi *et al.*, 2009; Sheikh & Bovik, 2006; Ginesu *et al.*, 2006), not only to focus on image appearance issues, but also to study the relationships between physical attributes of images and psychophysical attributes scales. Due to the model should be easy to apply to image industries and practical issues, most studies use the simple linear regression (LR) analysis method to construct the model. However, many assessment items used to evaluate an image are complex items such as preference, naturalness, or total image quality. Thus, this study questioned the linear analysis method is sufficiently accurate to construct the predict model based on simple assessment items, or whether other mathematical algorithms could also be used to construct the predict model based on complex assessment items, such as the Non-Linear regression analysis. Based on preliminary study which confirming the parameters of physical attributes for assessing image quality and checking the image stimuli (Tsai *et al.*, 2009), this study focuses on constructing the predict model of perceptual image quality. The results could to clarify relationship between physical and psychophysical attributes, and to provide the image and display industries a better understanding of how physical attributes relate to human perceptual image quality.

## 2. EXPERIMENT

### 2.1 Experimental Design and Environment

Each observer was seated facing a calibrated 30 inch Sharp LCD-TV with fixed luminance and color temperature control on 120cd/m<sup>2</sup> and about 6500K. The laboratory light was fixed luminance and color temperature was controlled by 233lux and about 6500K. The resolution of screen was multiply 1360×768 pixels. Each trial randomly showed an image, and the background color was set by a mid-grey colour having  $L^*$  about 60. The serial order in which the images were projected was randomized by the computer so that the image order changed every trial. Totally, that about 40 minutes for finish the experiment. The experimental environment has set as the same as to the environment of pervious study (Tsai *et al.*, 2009).

### 2.2 Image Stimuli

In order to reduce the number of assessment trials in main experiment, there are four images used in the main experiment (Figure 3). Each image was modulated by four physical attributes including lightness, chroma, hue angle, and contrast. All images were also processed according to colour conversion and physical adjustment based on CIECAM02 function by the Boland + program. To show the image and set the experiment interface for visual assessment tasks, the modulated images were represented to the screen by Visual Basic 6.0 software. The ‘linear regression (LR)’ analysis, ‘non-linear regression (NLR)’ analysis were be used in this study.

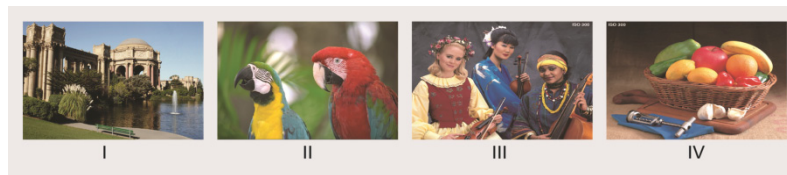

Figure 1: Image stimuli set for main experiment.

### 2.3 Participants of Experiment

Ninety observers participated in the visual assessment experiment. 64 observers were undergraduate and postgraduate students from the school of design at National Yunlin University of Science and Technology. 26 observers were image and display researchers of the TTLA. All observers possessed normal colour vision according to the Ishihara colour vision test.

## 3. RESULTS AND DISCUSSION

This study implemented the stepwise regression method to establish a regression prediction model with the statistical analysis system SPSS 17. The data adopted to establish the regression model in this stage was obtained by randomly selecting two-thirds of the 90% participants (81 people) from the original 90 participants. The remaining one-third of the 10% participants (9 people) were reserved for model verification. The total number of observation from experiments were 26,244 (four images × 81 scale adjustment variations × 81 participants). Finally, 81 averaged samples were set for linear and non-linear regression analysis. In terms of Multi-Collinearity testing based on the Person correlation coefficient analysis (see Table 1).

Ninety observers participated in The results show that there were high correlation coefficient between naturalness, preference, and image quality. In the other words, that may have

non-linear relationship between those three variables. The results of LR show in the Table 5, five models has constructed by using LR method which shows on Eq. (1) to Eq. (5). In order to compare the performance of linear analysis, the non-linear regression analysis has also analyzed in Table 3.

Table 1: The results of Person correlation coefficient analysis.

Psychophysical attributes	Brightness	Colorfulness	Naturalness	Preference	Image Quality
Brightness		.154	.368**	.352**	.360**
Colorfulness			.699**	.732**	.722**
Naturalness				.979**	.992**
Preference					.997**
Image Quality					

Table 2: Explanatory power and Cross-Validation of different prediction models with linear regression by stepwise method.

Linear Model	Brightness	Colorfulness	Preference	Naturalness	Image Quality
Including	<i>Li</i>	<i>Ch</i>	<i>Ch</i>	<i>Ch</i>	<i>Ch</i>
Independent	<i>Ch</i>	<i>Ha</i>			
Variables	<i>Co</i>	<i>Ha</i>			
<i>Adjust R<sup>2</sup></i>	.933	.810	.200	.150	.184
<i>F</i>	281.019	171.616	21.013	15.679	19.017
<i>Sig.</i>	.000	.000	.000	.000	.000

*Li*: Lightness, *Ch*: Chroma, *Ha*: Hue angle, *Co*: Contrast

Table 3: Explanatory power and Cross-Validation of different prediction models with non-linear regression by stepwise method.

Non-Linear Model	Brightness	Colorfulness	Preference	Naturalness	Image Quality
Including	<i>Li</i>	<i>Ch</i>	<i>Ch</i>	<i>LiCh</i>	<i>Ch</i>
Independent	<i>ChHaCo</i>	<i>Ch<sup>2</sup></i>	<i>Ch<sup>2</sup></i>	<i>Li<sup>2</sup></i>	<i>Ch<sup>2</sup></i>
Variables	<i>Li<sup>2</sup></i>	<i>LiCh<sup>2</sup>HaCo</i>	<i>LiCh</i>	<i>Li</i>	<i>LiCh</i>
	<i>Li<sup>2</sup>Ch<sup>2</sup>Ha<sup>2</sup>Co</i>	<i>LiCh<sup>2</sup>Ha<sup>2</sup>Co<sup>2</sup></i>	<i>Li<sup>2</sup></i>	<i>Ch<sup>2</sup></i>	<i>Li<sup>2</sup></i>
	<i>LiChHaCo</i>	<i>Li<sup>2</sup>ChHaCo</i>	<i>Li</i>	<i>Ch</i>	<i>Li</i>
	<i>Li<sup>2</sup>ChHaCo</i>	<i>LiChHaCo</i>	<i>Li<sup>2</sup>ChHa<sup>2</sup>Co<sup>2</sup></i>		<i>Li<sup>2</sup>ChHa<sup>2</sup>Co<sup>2</sup></i>
		<i>ChCo</i>	<i>LiChHaCo</i>		<i>LiChHaCo</i>
<i>Adjust R<sup>2</sup></i>	.968	.948	.767	.651	.764
<i>F</i>	402.972	207.606	38.679	30.823	37.951
<i>Sig.</i>	.000	.000	.000	.000	.000

$$\begin{aligned} \text{Brightness} = & 5.736 \times \text{Lightness} + 1.067 \times \text{Chroma} + 2.210 \\ & \times \text{Contrast} + 0.919 \times \text{HueAngle} - 1.005 \end{aligned} \quad (1)$$

$$\text{Colorfulness} = 4.060 \times \text{Chroma} + 1.175 \times \text{HueAngle} + 0.706 \quad (2)$$

$$\text{Preference} = 1.689 \times \text{Chroma} + 2.201 \quad (3)$$

$$\text{Naturalness} = 1.541 \times \text{Chroma} + 2.291 \quad (4)$$

$$\text{Image Quality} = 1.543 \times \text{Chroma} + 2.114 \quad (5)$$

#### 4. CONCLUSIONS

The results of those two analysis methods showed that lightness and chroma directly influenced the subjective feelings of the test subjects toward brightness and colorfulness, respectively. The results of correlation analysis showed that the assessment results for image quality, preference, and naturalness demonstrated significant, positive correlation between the three. This study recommends that preference and naturalness be first assessed and then linear function used to constitute image quality, to effectively increase the execution efficiency of human factor experimental evaluation. The three criteria of image quality, preference, and naturalness are not easily directly influenced by the single variables of the four physical image attributes but rather by the interactive effect of the combination of these attributes. Therefore, the data type for these criteria shows non-linear structure.

#### ACKNOWLEDGEMENTS

The authors would like to thank TFLA (Taiwan TFT LCD Association) for supporting this research and providing insightful comments. The authors would also like to thank many observers too part in the experiments.

#### REFERENCES

- Choi, S.Y., M.R. Luo, M.R. Pointer and P.A. Rhodes, 2009. Investigation of large display colour image appearance. III: Modelling image naturalness. *Journal of Imaging Sci. Technol.* 53 031104-1-12.
- Ginesu, G., F. Massidda and D.D. Giusto, 2006. A multi-factors approach for image quality assessment based on a human visual system model. *Signal Processing: Image Communication* 21 316-333.
- Sheikh, H.R., and A.C. Bovik, 2006. Image information and visual quality, *Image Processing, IEEE Transactions* 15(2) 430- 444.
- Tsai, C.M., S.S. Guan, L.Y.G. Juan, and Y.Y. Lai, 2009. The Scale on Different Physical Attributes of Images, in *Proceedings of the 11th Congress of the International Colour Association*.

*Address: Cheng-Min Tsai, Graduate School of Design,  
National Yunlin University of Science and Technology,  
Taiwan, No. 123 University Road, Section 3, Douliou, Yunlin 64002, Taiwan, R.O.C.  
E-mails: ansel.tsai@gmail.com*



# Colour Pattern Detection: Evaluation from the Mitosis Detection Contest in Histological Images

A. LEDOUX, N. RICHARD, A.S. CAPELLE-LAIZÉ, C. FERNANDEZ-MALOIGNE  
 XLIM-SIC laboratory, University of Poitiers

## ABSTRACT

Recently, a contest was posted to compare pattern detection system for mitotic cells detection in breast tumor tissues. The hit-or-miss transform is a mathematical morphological process designed to find objects in images. From existing approaches, only one method allows to extract objects with some variations in shape and contrast: the MOMP requiring non-flat structuring elements use. Actually only the color morphological approaches based on distances function and convergence coordinates allows this possibility. Due to this original construction, the “Color MOMP” allows to extract specified objects through a spatio-colorimetric templates.

## INTRODUCTION

The pattern detection is one of the major domains of the image processing science. In this context, the hit-or-miss transform was one of the first approaches. Originally defined in binary domain, some of its grayscale extensions allow finding objects upon their shape and contrasting relating to the image background. However, only one method allows extracting objects with variations in shape and simultaneously in contrast. This method is called MOMP and was developed by Barat. It requires non-flat structuring element, so the MOMP extension to color, called “Color MOMP”, needs a dedicated morphological framework. Actually only the color morphological approaches based on distances function and convergence coordinates allows this possibility.

In this article the numerical validation is based on the detection of mitotic cells in areas of breast tumor. These images are from the ICPR2012 contest entitled “Mitosis Detection in Breast Cancer Histological Images (MITOS 2012)”. We show the ability to construct spatio-colorimetric templates and to tune them with cell model.

## “COLOR MOMP”

From the Hit-or-Miss binary writing (Serra 1982), various methods are developed in grayscale (Odone 2001, Soille 2002). Some authors differ from others in their method using a non-flat structuring element (Khosravi 1996, Banon 1997). This type of structuring elements gives the ability to detect objects with a variation in shape or in contrast (relative to the image background). The Barat method (Barat 2003) appears to be the most suitable in the search for objects and is called MOMP (Multiple Objects Matching using Probing). The method uses a probing of the image with two non-flat structuring elements (see figure 2). The used template is composed with two structuring elements, the inferior  $g'$  and the superior  $g''$ . All objects fully included in this template are considered to correspond to the desired object. In other words, an object is detected when the distance between both structuring elements is inferior to the  $\delta$  value which is the difference between both structuring elements at centering point placed in their reference position. With  $g = \{g', g''\}$  the set of used structuring elements, the MOMP transformed is written as:

$$\text{MOMP}(f,g)(x) = \delta_g (f, (-g'')^r)(x) - \epsilon_g (f, g')(x) \quad (1)$$

where  $\delta_g$  and  $\varepsilon_g$  are respectively the dilation and erosion for grayscale images, and  $g^r$  is the reflectivity function of  $g$  ( $g^r = g(-y)$ ).

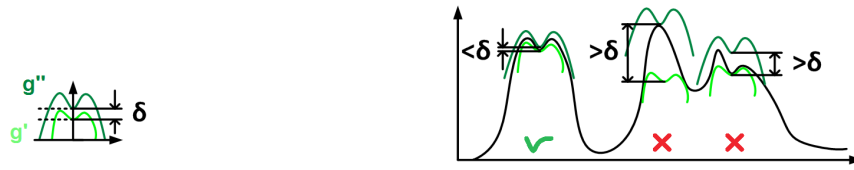

(a) Template constructed with two structuring elements

(b) Probing of the function with the template

Figure 2: Principle of the MOMP transformed.

The MOMP allows variation in shape and simultaneously in contrast. In (Ledoux 2012), we shown that the structuring elements magnitudes allow to select the desired contrast range. We also defined the parameter  $\delta$  as the selectivity parameter; it is the contrasts range size. With a new color mathematical morphology writing which is based on the “convergence” concept and which allows non-flat structuring elements writing, we extended the MOMP algorithm to color images. This new algorithm is named “Color MOMP”.

$$\text{Color MOMP}(f, g)(x) = \delta_c(f, (-g'')^r)(x) \bar{\_c} \varepsilon_c(f, g')(x) \quad (2)$$

$$= \bigvee_{x \in D_f, y \in D_g} \{f(x-y) \bar{\_c} g''(y)\} \bar{\_c} \bigwedge_{x \in D_f, y \in D_g} \{f(x-y) \bar{\_c} g'(y)\}$$

where  $\bar{\_c}$  is the subtraction for color coordinates.

### SPATIO-COLORIMETRIC TEMPLATE SPECIFICATION

With this writing form, “Color MOMP” allows to detect complex objects in a natural way. The structuring elements form a template which determines the desired shape. The convergence coordinates for the morphological operators are defined from the objects and background colors. Finally, the selectivity parameter called  $\delta$  determines the distance between the hyper-surfaces of the two structuring elements. The selectivity parameter value adjusts the desired variability in the color contrast.

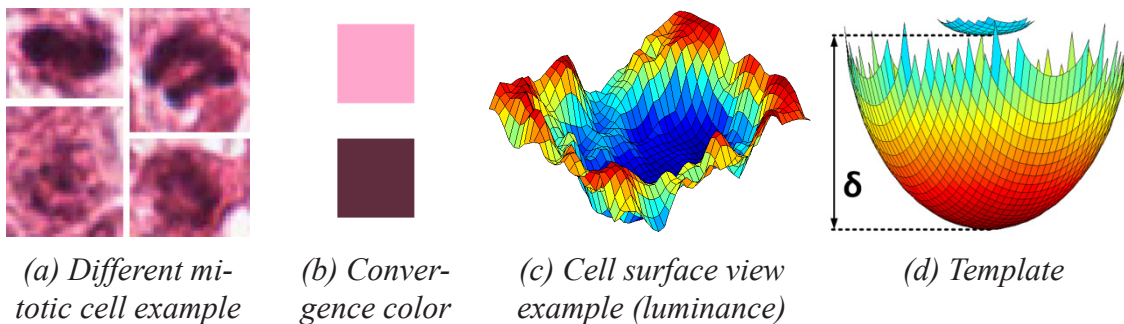

(a) Different mitotic cell example

(b) Convergence color

(c) Cell surface view example (luminance)

(d) Template

Figure 4: Example of mitotic cells extraction to the “MITOS dataset”.

The “Color MOMP” interest lies in the ability to specify the search template from spatio-color models. The next step is an example of a user’s reasoning to define the parameters. With analyze of some mitotic cells extracted from several images of the database (Figure 4-(a)), we define all the parameters. In first, to define both color convergence, we manually select a median color from colors in the mitotic cells and a median color among those present

in the neighborhood of the cells (Figure 4-(b)). As the mitotic cells can take many shapes, we chose a spherical template with a different diameter for the two structuring elements. The lower structuring element diameter is selected according to the minimum width found and equal to 9 pixels. The diameter of the upper structuring element is chosen depending on the maximum size of the cells found in the images and is equal to 41 pixels. Figure 4-(d) shows the used template. Finally the selectivity parameter is fixed to tolerate the differences between strongly or slightly textured cells and light or dark cells, and is equal to 25.

## RESULTS

The MITOS database is composed of 50 images from 5 breast cancer biopsy slides that contain around 300 mitotic cells. In this part, to detect mitosis, we use the parameters described in the section 4. Figure 5-(b) is a “Color MOMP” result.

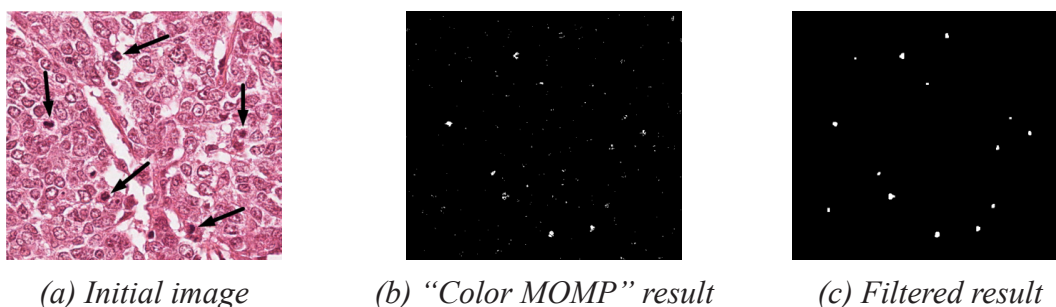

Figure 5: Example of Mitosis detection result.

Due to the complex cell shape and texture several detection are found inside the same cell. The first post-processing to reduce the number of false detection is a binary. We show the gain obtained by this simple post-processing step in the table 1. But the false alarm number keeps high. The problem is induced by the coloring product. To highlight mitotic cells Hematoxylin and Eosin stain (H&E) are used, but such color contrast product gives a particular color for the mitotic cells but also for young cells, that compose the false.

Table 1 shows also the results obtained with the grayscale images (MOMP) and with the color images (“Color MOMP”). But the color information is only link to the used color contrast product. Then the results obtained with or without color information are similar. However, this image database is the only one in the biomedical domain with a ground truth for the object detection.

Table 1. Mitotic cells detection with greyscale and color MOMP.

		MOMP	MOMP + filtering	“Color MOMP”	“Color MOMP” + filtering
Object count	False positive	3374	2641	3941	2918
	True positive	114	114	116	116
	False negative	6	6	4	4

A future solution to reduce the number of non-detected cells is to define different parameter set. The first parameter set is constructed to detect the most regular mitotic cells and then others parameter sets are constructed to refine the results. However this solution requires a more extensive learning work to store the knowledge on the differences between mitotic and non-mitotic cells.

#### 4. CONCLUSIONS

Thanks to a new color mathematical morphology based on the concept of convergence, that allows the non-flat structuring element writing, we extend the MOMP transform from Barat (Barat 2003). This morphological process called the “Color MOMP” is dedicated to object extraction specified through a spatio-colorimetric templates. The major interest of this framework is to define an easy construction of templates from images examples or theoretical models. The second interest is to embed directly the notion of spatial and colorimetric selectivity by the distance between the two non-flat structuring elements specifying the template.

Recently, a contest was posted to compare pattern detection system for mitotic cells detection. Due to the medical domain, we chose to focus the severity parameter on the detection of all mitotic cells. However some of cells have particular shape/texture or are too large and to be detected need the definition of another parameter set.

Last element of interest is lies in the fact that our approach is directly extensible to multispectral images using the right multispectral distance. Our first results give some nice perspectives generalizing the “Color MOMP” approach that will be applied to the multispectral images from the MITOS contest.

#### ACKNOWLEDGEMENTS

Thanks to Region Poitou-Charentes and to Europe for FEDER support that help in the development of these research works.

#### REFERENCES

- Banon, G.J.F., and S.D. Faria, 1997. Morphological approach for template matching, *Proceedings of X Symposium on Computer Graphics and Image Processing* 171-178.
- Barat, C., C. Ducottet, et al, 2003. Pattern matching using morphological probing, *International Conference on Image Processing* 369-372.
- Khosravi, M., and R.W. Schafer, 1996. Template matching based on a grayscale hit-or-miss transform, *Transactions on Image Processing* 5(6):1060-1066.
- Ledoux, A., N. Richard, A.S. Capelle-Laizé and C. Fernandez-Maloigne, 2012. Color hit-or-miss transform on dermatological images, *Twentieth Color and Imaging Conference* 164-169.
- MITOS dataset, 2012. <http://ipal.cnrs.fr/ICPR2012/>. “Mitosis detection in breast cancer histological images”.
- Odone, F., E. Trucco, and A. Verri, 2001. General purpose matching of grey level arbitrary images, *Visual Form* 573-582.
- Serra, J., 1982. *Image Analysis and Mathematical Morphology*, volume I. Academic Press.
- Soille, P., 2002. Advances in the analysis of topographic features on discrete images, *Discrete Geometry for Computer Imagery* 271-296.

*Address: Ms Audrey Ledoux, University of Poitiers,  
SP2MI, XLIM-SIC, Bd Marie et Pierre Curie,  
Téléport 2, 86962 Futuroscope Cedex, France.  
E-mail: audrey.ledoux@univ-poitiers.fr*

# Visual Perception of Fluorescent and Neon Colors on an LCD Monitor

Midori TANAKA, Takahiko HORIUCHI, Shoji TOMINAGA  
Graduate School of Advanced Integration Science, Chiba University

## ABSTRACT

The terms “fluorescent color” and “neon color” (hereafter, F-N colors) are widely used to describe vivid colors. F-N colors are produced by a luminous phenomenon and are unlike the object colors produced by reflection; however, human color perception of such light has not been fully investigated. In this study, we investigate the color perception of F-N colors through psychophysical experiments using color patches displayed on an LCD monitor. In our experiments, 135 color patches from the Pantone Color Chart with different luminance levels  $L^*$  are displayed on an LCD monitor. We ask 10 Japanese subjects to name each color and describe its appearance mode. Each subject respond with an appropriate color name for each patch from among a set of 15 color names that were found to be common among modern Japanese people. The subjects also respond as to whether each patch is of a fluorescent/neon color. Subsequently, an appropriate color appearance mode for each patch is also selected from the aperture or object color modes. On the basis of responses, it becomes clear that the visual perception of F-N colors essentially differs from that of the aperture and object colors.

## 1. INTRODUCTION

The terms “F-N colors” are widely used to describe vivid colors. Both fluorescent substances and neon gas have been used for illumination applications, but they have different chemical characteristics. In a fluorescent lamp, the phosphors absorb the energy of ultraviolet photons and emit visible light in the longer wavelengths. In a neon tube, the neon atoms emit photons directly. Therefore, fluorescent lamps produce light in two steps, while neon lamps need only a single step. Because of this two-step characteristic, fluorescent substances are often used in paints and coatings as an invisible fluorescent pigment. Thus, F-N colors are produced by a luminous phenomenon and are unlike the object colors produced by light reflection; however, human color perception of such light has not been fully investigated. In this study, we investigate the color perception of F-N colors through psychophysical experiments using color patches displayed on an LCD monitor.

## 2. EXPERIMENTAL METHOD

### 2.1 Experimental System

We constructed an experimental system on an LCD monitor for analyzing F-N colors. The display device used in the experiment is an ASUS PA246Q with the sRGB color gamut. The maximum brightness was  $295 \text{ cd/m}^2$ . We used color stimuli of the Pantone Color Chart with 14 neon colors (801C – 814C), as listed in Table 1. Our system generated 94 test colors from the 14 neon colors within the monitor’s color gamut by changing the  $L^*$  values sampled at five intervals. For verifying the reliability of the responses of each subject, duplicated patches were partially included in the color stimuli. Therefore, 135 color stimuli were displayed

in all with a black background as shown in Fig. 1. Each subject responded on the following three items for each color stimulus by using a computer mouse: (1) visual perception of F-N colors, (2) color appearance mode, and (3) color name.

Table 1: RGB values of neon color samples in the color chart.















Code	801	802	803	804	805	806	807	808	809	810	811	812	813	814
R	0	96	255	255	249	255	214	0	221	255	255	252	229	140
G	170	221	237	147	89	0	0	181	224	204	114	35	0	96
B	204	73	56	56	81	147	158	155	15	30	71	102	153	193
Color														



Figure 1: A screen-shot of the displayed color patches on our system.

## 2.2 Survey Items

### (1) Visual perception of F-N colors

It is interesting to investigate whether the human vision system can perceive F-N colors displayed on an LCD monitor. Each subject selected color stimuli that could be individually perceived as fluorescent or neon colors.

### (2) Color appearance mode

Two types of color appearance modes are known as the aperture and surface color modes (Shinoda et al. 1993). Both fluorescent substances and neon gas have been used for illumination applications, but fluorescent substances are often used as an invisible fluorescent pigment. Therefore, the investigation of the color appearance mode of F-N colors is of interest.

### (3) Color name

The color names that can be used to describe F-N colors are also of interest in this investigation. In our previous work (Tominaga et al. 2010), we found that a set of 15 color terms, comprising gold, silver, turquoise, and yellow-green in addition to Berlin and Kay's 11 basic color terms (Berlin et al. 1969), could be considered as consistently important color terms in the daily lives of Japanese people. We then designated these 15 color names as a set of Japanese basic color terms, from which the subjects selected proper color names in the experiment.

## 2.3 Experimental Setup

Ten Japanese subjects with normal color perception participated in this experiments. Before performing the psychophysical experiments, the experimental method was explained to each subject. Experiments were conducted in a dark room. The distance between the monitor and

a subject was about 700 mm. After dark adaptation for three minutes, each subject categorized 135 patches through the following four sessions:-

1. The subject responded with an appropriate color name from among 15 color names for each color patch.
2. The subject responded with an appropriate color appearance mode by selecting between the aperture or surface color modes for each color patch.
3. The subject selected color patches that could be perceived as fluorescent colors.
4. Each subject selected color patches that could be perceived as neon colors.

### 3. RESULTS AND DISCUSSION

#### 3.1 Visual Perception of F-N Colors

Of all the color stimuli, 20.4% were identified as fluorescent and 24.3% were identified as neon. This result shows that the human vision system can perceive F-N colors displayed on an LCD monitor. From among the color stimuli that were identified as F-N colors, 52.7% were perceived as both fluorescent and neon. This result shows that there is no significant difference between the perception of fluorescent and neon colors.

#### 3.2 Color Appearance Mode

All patches perceived to have a fluorescent color in Session 3 were identified by subjects to be in the aperture mode in Session 2. 98.5% of neon color patches identified in Session 4 were identified to be the aperture mode in Session 2. This result shows that F-N colors were perceived as aperture colors and not object colors. In addition, the perception of F-N colors depended on the brightness level. In particular, F-N colors were perceived in pixels with high brightness levels of  $L^* > 45$  ( $L^* = 100$  corresponds to  $295 \text{ cd/m}^2$  under D65), and the brightness range of F-N colors was stable among subjects, as compared to the brightness range of object and aperture color perceptions. Figure 2 shows the range of luminance for the identified color modes and F-N colors. As shown in the figure, F-N colors are included in aperture color mode, but they only form a subset of all existing F-N colors. This result suggests the existence of color appearance modes that are different from the aperture mode.

#### 3.3 Color Name

For each subject, the selected color names were relatively consistent over all sessions. The same color patch was identified as the same color name regardless of the color appearance mode. The responses were very limited and included only six F-N color names: —“pink,” “yellow,” “turquoise,” “yellow-green,” “orange,” and “purple.” As compared to the responses for names of aperture and object colors, the rates for “pink,” “turquoise,” “yellow-green,” and “yellow” were high, and the rates for “brown,” “green,” “red,” and “blue” were low. In particular, “brown” formed 15.4% of all the responses for color names, although it formed 0% of the responses for F-N color names. From the explanation above, it becomes clear that the visual perception of F-N colors is essentially different from that of aperture and object colors in terms of the color names given as responses.

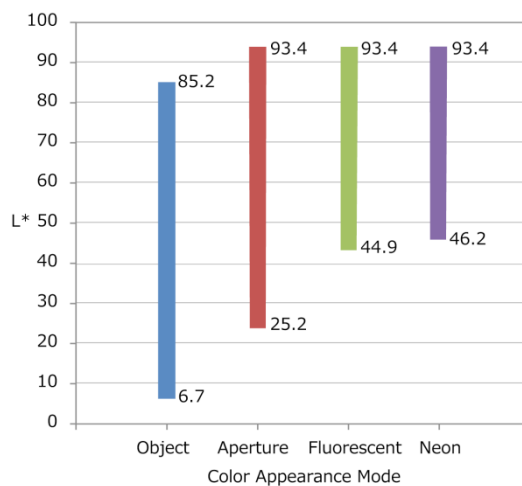

Figure 2: Experimental results for color appearance mode and F-N colors for  $L^*$ .  $L^*$  values of color stimuli are limited within [6.7, 93.4] due to the color gamut.

#### 4. CONCLUSIONS

In this study, we investigated fluorescent color and neon color perceptions. From the results, we could clarify that the human vision system is capable of perceiving F-N colors displayed on an LCD monitor. In addition, we showed that F-N colors were perceived as aperture color mode and their color names were strictly limited. From our investigation, it could be confirmed that the visual perception of F-N colors is essentially different from that of aperture and object colors.

#### ACKNOWLEDGEMENTS

This work was supported by Grant-in-Aid for Scientific Research on Innovative Areas “Shitsukan” (No. 25135706) from MEXT, Japan.

#### REFERENCES

- Berlin, B., and P. Kay, 1969. *Basic Color Terms Their Universality and Evolution*. University of California Press.
- Tominaga, S., A. Ono, and T. Horiuchi, 2010. Investigation and Analysis of Color Terms in Modern Japanese. In *SPIE Electronic Imaging, Proceedings*, 7528, 752804-1-8.
- Shinoda, H., K. Uchikawa and M. Ikeda, 1993. Categorized Color Space on CRT in the Aperture and the Surface Color Mode, *Color Research and Application* 18, 326-333.

*Address: Ms. Midori Tanaka, Graduate School of Advanced Integration Science, Chiba University, Yayoi-cho 1-33, Inage-ku, Chiba, 263-8522 JAPAN*  
*E-mails: midori\_t@graduate.chiba-u.jp, {horiuchi, shoji}@faculty.chiba-u.jp*



# Interrelationships of Different Image Quality Attributes for Smart-phone Displays

Rui GONG, Haisong XU

State Key Laboratory of Modern Optical Instrumentation, Zhejiang University, China

## ABSTRACT

Revealing the critical factors that affect the image quality (IQ) is of great importance for the widely used smart-phone displays. In this study, psychophysical evaluation was carried out on two smart-phone displays with the technologies of In-Plane Switching (IPS) and Active Matrix Organic Light Emitting Diode (AMOLED), respectively. Twenty test images were selected from several application categories for smart-phones, and they were rendered using different manipulation methods, involving changes in lightness, chroma, hue, and spacial frequency. Eight perceptual attributes, i.e. naturalness, colourfulness, brightness, contrast, sharpness, clearness, preference and overall IQ, were evaluated via categorical judgment technique using a 9-point numerical category scale. The correlation analysis on the experimental data indicates that overall IQ presents the strongest dependency on the preference attribute, and clearness is the most important factor to influence the overall IQ, followed by naturalness, sharpness, colourfulness, contrast, and brightness. Herefrom, the relevant perceptual attributes which are proved to impact overall IQ evidently could be chosen for modeling the overall IQ. Furthermore, there are also strong correlations between brightness and contrast, and sharpness and clearness. Hence, some of these attributes may be screened or combined in the next-stage IQ modelling for smart-phone displays.

## 1. INTRODUCTION

The wide use of smart-phones brings about huge impacts on many aspects of our daily life, and high image quality (IQ) has become extremely desirable for viewing static and moving images on smart-phone displays (Kim 2008). However, the perception of images shown on these small-sized displays is quite different from those on desktop displays and TVs. Thus, the study on the IQ evaluation for smart-phone displays is of technological importance, which is helpful for researchers of display technologies and display manufactories to achieve excellent image display effects.

In this study, eight perceptual attributes were evaluated via psychophysical experiments of categorical judgment in order to reveal the critical factors that affect the overall IQ obviously. Various application types of test images were involved to simulate the general use of smart-phones, such as natural scenes, games, maps, internet, and so on. Based on the calculation of Pearson correlation coefficients, the interrelationships between individual IQ attributes were deeply analysed, and the key attributes contributing towards the overall IQ of smart-phone displays could be determined for different application types of images, which established an important foundation for selecting crucial attributes for a comprehensive and effective IQ modelling in the future work.

## 2. METHOD

The experiments were carried out on two smart-phone displays with different prevailing technologies, i.e. the In-Plane Switching (IPS) and the Active Matrix Organic Light Emitting Diode (AMOLED). The two displays have similar physical size, and the IPS panel has

higher peak luminance and pixel resolution, whereas the AMOLED one has higher colour correlated temperature (CCT) and larger colour gamut.

## 2.1 Image Preparation

To cover a considerable scope of common image contents, 20 test images were selected from several specific application types for smart-phone displays, which not only included some familiar memory colours such as skin, green grass, and blue sky, but also considered other application types like internet, games, and maps as well (Gong 2012). Figure 1 illustrates some typical examples of test images from different application types.

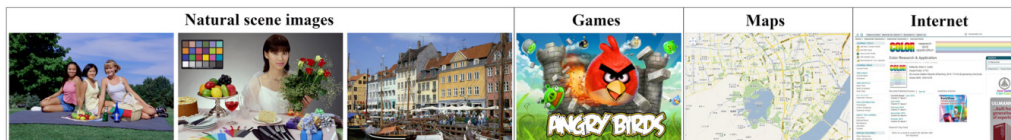

Figure 1: Some typical samples of the 20 original test images in the IQ evaluation.

To provide a wide but realistic range of variations for IQ assessment, the CIE tristimulus values XYZ of each pixel for every test image were calculated and then transformed to CIELAB colour space, in which various manipulation methods were performed in terms of lightness  $L^*$ , chroma  $C$ , and hue  $h$  (Choi 2008). There were 5 functions (3 linear, 1 sigmoid, and 1 inverse sigmoid) to change lightness, 3 linear functions for chroma manipulation, 4 shifts of hue, and 2 methods for spatial frequency manipulation (4 kinds of Gaussian function and 3 resolution changes). Then, the modulated  $L^*$ ,  $C$ ,  $h$  values were rendered by being converted to digital inputs for each pixel, producing 20 derivative manipulated versions for each original image.

## 2.2 Psychophysical Procedure

The psychophysical experiments were conducted by a panel of 10 observers (5 male and 5 female) with normal colour vision in a dark room. The viewing angle was  $14.25^\circ \times 9.53^\circ$  at a distance of 30 cm, and the observers focused their attentions on the panels perpendicularly. Eight perceptual attributes, i.e. naturalness (Yoo 2009; Yendrikhovskij 1999), colourfulness (Fedorovskaya 1997), brightness (Fairchild, 2005), contrast, sharpness (Hunt 2004), clearness, preference (Guan 2010), and overall IQ, were visually assessed (only natural scene images could be evaluated for naturalness) via categorical judgment method of a 9-point numerical category scale, ranging from 1 to 9 to describe the perceptual feelings in grades. The definitions of these attributes were presented to the observers both in English and in Chinese.

## 3. RESULTS AND DISCUSSION

The raw data of categorical judgment method is in term of category grades. Then for each evaluated image, its categorical grades judged by the 10 observers were converted to an interval scale value by adopting Case V of Thurstone's law on comparative judgment (Thurstone 1927). To determine the attributes that significantly influence the overall IQ, and to find the important interactions between them, the Pearson correlation coefficients were calculated for each pair of IQ attributes with all their possible combinations, as shown in the bar graphs of Figure 2, in which the correlation coefficient of 1.0 for individual attribute with itself is also drawn as a reference.

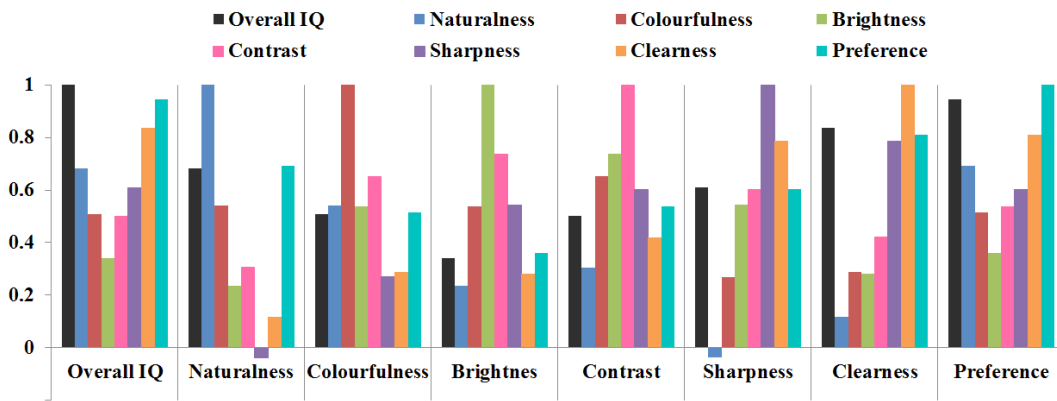

Figure 2: The Pearson correlation coefficients for each pair of all the 8 IQ attributes.

As clearly seen from Figure 2, the overall IQ shows the strongest dependency on preference with a very high correlation coefficient of 0.945, indicating that being preferred is very likely to having high degree of excellence in observers' judgments. Clearness is the most important factor to influence the overall IQ with a high Pearson correlation coefficient of 0.836, therefore it could be regarded as an indispensable attribute, implying that recognizing the details of characters and lines is extremely important for smart-phone displays. Moreover, naturalness becomes the second important factor for overall IQ, since it is based on a memory of the real world for human observers. In addition, sharpness, colourfulness, and contrast also exhibit impact on the overall IQ as well, which should be considered as complementary elements. Therefore, these above perceptual attributes could be taken into account for the further analysis of modelling overall IQ.

Besides, there are also some intimate relationships of high correlation existed in other pairs of IQ attributes, which strongly corroborates they are not independent but influenced by other factors. As obviously depicted in Figure 2, contrast shows high dependencies on the attributes of colourfulness, brightness, and sharpness, implying that it is a complex action of various aspects in an image rather than an independent variable. Moreover, the correlation coefficient between sharpness and clearness is relatively high (0.786), which may be due to their similarity that they both emphasize identifying the details and edges in an image. In addition, there is also relatively high correlation between colourfulness and naturalness, since they both deal much with the colour information aspect of an image, and it is well known that an image of good naturalness usually signifies proper colourfulness. Also, the high correlation between colourfulness and brightness may be due to the Hunt effect and the Helmholtz-Kohlrausch effect. Hereby, these evaluated IQ attributes do not exist in an isolated manner, so some of those need to be screened or combined accordingly in further IQ modelling.

Based on the interrelationships of the IQ attributes, further factor analysis will deeply study the principal factors impacting the overall IQ for natural scene images and other application types of images separately, and the future research will be focused on developing models of overall IQ for smart-phone displays by combining its constituent key attributes.

#### 4. CONCLUSIONS

Eight image quality attributes were visually evaluated for two smart-phone displays by employing test images from different application types. The calculation of Pearson correlation coefficients indicates that clearness and naturalness are principal attributes to influence

the overall IQ, sharpness, colourfulness, and contrast also show some moderate correlations with the overall IQ. Additionally, contrast presents high dependencies on the attributes of colourfulness, brightness, and sharpness. And there are significant interactions between sharpness and clearness, colourfulness and brightness, and colourfulness and naturalness. The achievements of this study will be helpful for developing effective models to accurately predict the perceived overall IQ for smart-phone displays.

## REFERENCES

- Choi, S.Y., M.R. Luo, M.R. Pointer, and P.A. Rhodes, 2008. Investigation of large display color image appearance I: Important factors affecting perceived quality. *Journal of Imaging Science and Technology* 52: 040904-1-11.
- Fairchild, M.D., 2005. *Color Appearance Models*, 2nd Edition. Chichester: John Wiley and Sons.
- Fedorovskaya, E.A., H. de Ridder, and F.J.J. Blommaert, 1997. Chroma variations and perceived quality of color images of natural scenes. *Color Research and Application* 22 (2): 96-110.
- Gong, R., H. Xu, B. Wang, and M.R. Luo, 2012. Image quality evaluation for smartphone displays at lighting levels of indoor and outdoor conditions. *Optical Engineering* 51: 084001-1-6.
- Guan, S.S., and P.S. Hung, 2010. Influences of psychological factors on image color preferences evaluation. *Color Research and Application* 35 (3): 213-232.
- Hunt, R.W.G., 2004. *The Reproduction of Colour*, 6th Edition. Chichester: John Wiley and Sons.
- Kim, Y.J., M.R. Luo, W. Choe, H.S. Kim, S. O. Park, Y. Beak, P. Rhodes, S. Lee, and C.Y. Kim, 2008. Factors affecting the psychophysical image quality evaluation of mobile phone displays: the case of transmissive liquid-crystal displays. *Journal of the Optical Society of America A* 25: 2215-2222.
- Thurstone, L.L., 1927. A Law of Comparative Judgment. *Psychology Review* 34: 273-286.
- Yendrikhovskij, S.N., F.J.J. Blommaert, and H. de Ridder, 1999. Color reproduction and the naturalness constraint. *Color Research and Application* 24 (1): 52-67.
- Yoo, J.J., G. Cui, and M.R. Luo, 2009. Color naturalness metric for evaluating image quality of mobile displays. In *SPIE, Proceedings*, ed. by R. Eschbach, G.G. Marcu, S. Tomimaga, and A. Rizzi. Vol 7421, 742101-1-9.

*Address: Prof. Haisong Xu, State Key Laboratory of Modern Optical Instrumentation  
Zhejiang University, Hangzhou 310027, China  
E-mail: chsxu@zju.edu.cn*

# Extension of Dynamic Range of Camera System based on Multi-band image Capturing

Masaru TSUCHIDA, Takahito KAWANISHI,  
Ryo MUKAI, Kunio KASHINO, Junji YAMATO  
Communication Science Laboratories, NTT Corporation

## ABSTRACT

This paper proposes a novel method for extending the dynamic range of a camera system based on multi-band image capturing. In the color reproduction process, saturated pixel values cause pseudo color in resultant color images. The proposed method focuses on the fact that spectral reflectance of target objects can be estimated by using only unsaturated pixel values even when the pixel values of several band images are saturated. In order to recover the saturated pixel values, image capturing simulation is conducted. The estimated spectral reflectance is multiplied by the illumination spectrum and the spectral sensitivity of the multi-band camera, which enables us to obtain unsaturated pixel values of saturated image-bands. In experiments, the proposed method was applied to a two-shot six-band camera system consisting of a commercially available digital single-lens reflex camera and a custom interference filter whose spectral transmittance was comb shaped and A woven fabric was used as a target object. These results indicate that the proposed method can extend the dynamic range of a camera system.

## 1. INTRODUCTION

Natural and high-fidelity color reproduction, high-resolution imaging, and dynamic-range enhancement are key technologies in visual telecommunications applications, such as electronic commerce, telemedicine, and electronic art museums, realistic color reproduction, as if the object is being directly observed. Also important for achieving realism in archiving (e.g., cultural heritage and medical applications) are the reproduction and display of the high-fidelity colors and gloss of objects, as well as the reproduction of their texture, three-dimensional (3-D) shape, micro-structure, and movement. However, it is difficult to accurately reproduce the color of an object under arbitrary illumination conditions using current imaging systems based on three-band image capturing, especially when the illumination at the image observation site is different from the illumination of the image capturing. Although multi-band imaging is well known as an effective technology for accurate color reproduction of a target object and several multi-band camera systems have been developed [1-7], there have been no discussions about the possibilities for extending the dynamic range of camera systems. In capturing a digital image of a high-dynamic range scene or object, all or a part of multi-band pixel values corresponding to high-brightness areas, such as specular reflections, are often saturated because of the limitation of the dynamic range of the image sensor. In the color reproduction process, saturated pixel values cause pseudo color in resultant color images.

This paper proposes a novel method for extending the dynamic range of a camera system based on multi-band image capturing. The proposed method focuses on the fact that spectral reflectance of target objects can be estimated by using only unsaturated pixel values even when the pixel values of several band images are saturated.

## 2. METHOD

In order to recover the saturated pixel values, image capturing simulation is conducted. The estimated spectral reflectance is multiplied by the illumination spectrum and the spectral sensitivity of the multi-band camera, which enables us to obtain unsaturated pixel values of saturated image-bands. When the number of bands whose pixel value is unsaturated is less than three, let us assume that the specular reflection is recorded on the pixel. Under assumption of the dichromatic reflection model, the illumination spectrum is used as the spectral power distribution of the light reflected from the object surface in the image capturing simulation. Each process is described bellows, respectively.

### 2.1 Estimation of Spectral reflectance from multiband data

Let the illumination spectrum and spectral reflectance be  $W(\lambda)$  and  $f(\lambda)$ , respectively. The observed spectrum,  $I(\lambda)$ , can be represented as

$$I(\lambda) = W(\lambda)f(\lambda) \tag{1}$$

where  $\lambda$  is wavelength. Let us consider a situation where the reflected light is captured by an  $N$ -band sensor and assume that signals of  $K$ -band are not saturated. Let the spectral sensitivity of the sensor be  $\mathbf{S}' = [S'_1(\lambda), S'_2(\lambda), \dots, S'_K(\lambda)]^T$ . Let the matrix whose diagonal elements represent the spectral power distribution of illumination be  $\mathbf{W}$ . Equation (1) can then be rewritten in vector representation as

$$\mathbf{I} = \mathbf{W}\mathbf{f} \tag{2}$$

By using the Wiener estimation method<sup>8</sup>, the spectral reflectance is estimated from the camera signal,  $\mathbf{c}' = \mathbf{S}'\mathbf{W}\mathbf{f} = \mathbf{H}\mathbf{f}$ , as

$$\hat{\mathbf{f}} = \mathbf{M}\mathbf{c}', \quad \mathbf{M} = \mathbf{R}\mathbf{H}'\{\mathbf{H}\mathbf{R}\mathbf{H}'\}^{-1} \tag{3}$$

where  $\hat{\mathbf{f}}$  is the estimated spectral reflectance,  $\mathbf{M}$  is the Wiener estimation matrix obtained from  $\mathbf{H}$ , and  $\mathbf{R}$  is a priori knowledge about the spectral reflectance of the object, respectively. In the Wiener estimation method, we used a correlation matrix  $\mathbf{R}$ , which is modeled on a first-order Markov process covariance matrix, in the form

$$\mathbf{R} = \begin{pmatrix} 1 & \rho & \rho^2 & \dots & \rho^{K-1} \\ \rho & 1 & \rho & \dots & \rho^{K-2} \\ \rho^2 & \rho & 1 & \dots & \dots \\ \dots & \dots & \dots & \dots & \dots \\ \rho^{K-1} & \rho^{K-2} & \dots & \dots & 1 \end{pmatrix}, \tag{4}$$

where  $0 \leq \rho \leq 1$  is the adjacent element correlation factor; we set  $\rho = 0.999$  in our experiments. The observed spectral power distribution of the light reflected from the object surface,  $\hat{\mathbf{I}}$ , is calculated by multiplying  $\hat{\mathbf{f}}$  and  $\mathbf{W}$ .

### 2.2 Image Capturing Simulation

Let us consider image capturing simulation using  $\hat{\mathbf{f}}$ , the illumination spectrum  $\mathbf{W}$ , and the spectral sensitivity of the sensor be  $\mathbf{S} = [S_1(\lambda), S_2(\lambda), \dots, S_N(\lambda)]^T$ . The calculated  $N$ -band

camera signal is represented as

$$\hat{c} = SW\hat{f} = SWGc', \tag{5}$$

Equation (5) shows that  $K$ -band data  $c'$  can be converted into  $N$ -band data whose pixel values are not saturated. Hence, a dynamic range of  $N$ -band image capturing system is extended and spectral reflectance of object's surface can be well reproduced even when the part of an original multiband data were saturated. The spectral reflectance is estimated using the Wiener estimation using the obtained  $N$ -band data,  $\hat{c}$ .

### 3. EXPERIMENTAL RESULTS AND CONCLUSION

In experiments, the proposed method was applied to a two-shot six-band camera system consisting of a commercially available digital single-lens reflex camera (three-band camera; Red, Green and Blue) and a custom interference filter whose spectral transmittance was comb shaped<sup>[5]</sup>. Figure 1 shows the spectral sensitivity of the camera system. A woven fabric was used as a target object. The bit depth of the input image is 16. First, pixel values of the captured image and the image obtained with the proposed method were compared with the pixel values calculated by using the spectral reflectance measured by a spectroradiance meter, and it was confirmed that the resultant pixel values were almost the same as the calculated ones (Figure 2). In addition, the dynamic range of the camera system was extended at least doubled.

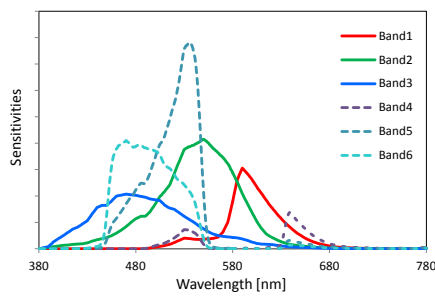

Figure 1: Spectral sensitivity of the six-band camera system.

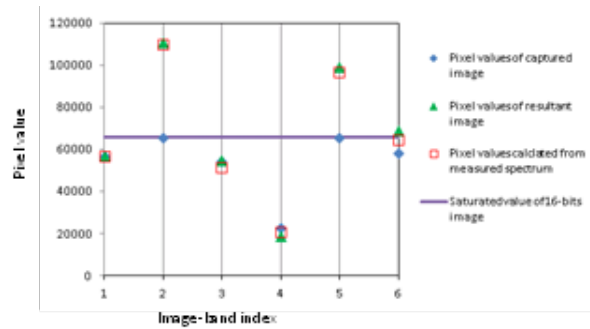

Figure 2: Pixel value of resultant image.

Next, the spectral reflectance measured by a spectroradiance meter and that estimated by using the proposed method were compared, and the result shows the spectral reflectance is well estimated (Fig.3). And finally, the resultant images before and after applying the proposed method were compared (Fig.4). The appearance of the resultant image after the proposed method was applied looked much more natural. These experimental results indicate that the proposed method can extend the dynamic range of a camera system.

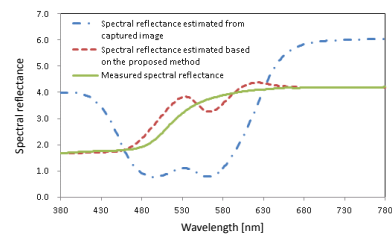
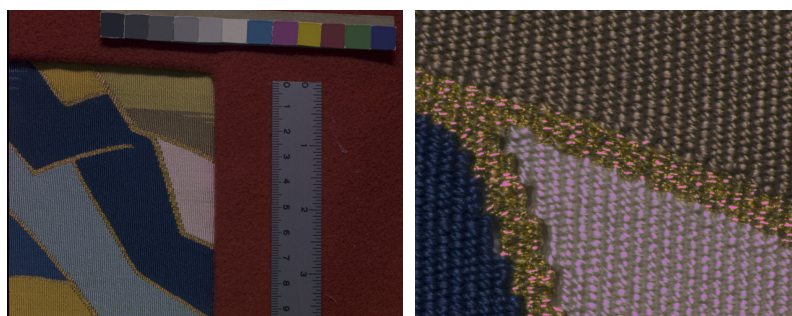
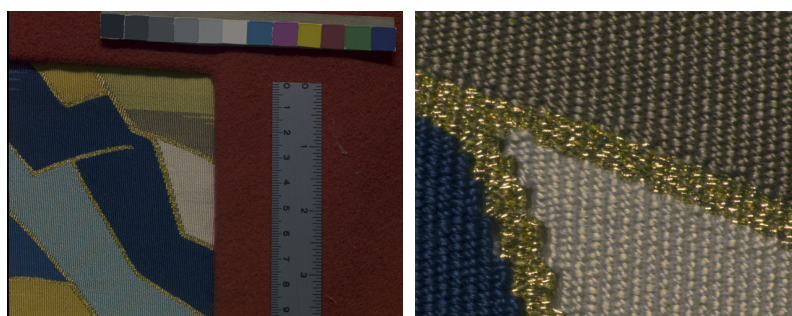

Figure 3: Estimated spectral reflectance.



(a) Resultant color image before applying the proposed method



(b) Resultant color image after applying the proposed method

Figure 4: Results of color reproduction.

## REFERENCES

1. Tominaga, S., 1996. Multichannel vision system for estimating surface and illuminant functions, *J. Opt. Soc. Am. A*, 13(11), 2163-2173.
2. Tominaga, S., et al., 2000. Object Recognition by Multi-Spectral Imaging with a Liquid Crystal Filter, *Proc. Conference on Pattern Recognition*, vol.1, 708-71.
3. Helling, S., et al., 2004. Algorithms for spectral color stimulus reconstruction with a seven-channel multispectral camera, P Proc. *Second European Conference on Colour in Graphics, Imaging, and Vision (CGIV2004)*, 254-258.
4. Ohsawa, K., et al., 2004. Six-band HDTV camera system for spectrum-based color reproduction, *J. of Imaging Science and Technology*, 48(2), 85-92.
5. Hashimoto, M., 2008. A stereo one-shot multi-band camera system for accurate color reproduction, *Proc. Fourth European Conference on Colour in Graphics, Imaging, and Vision (CGIV2008)*, 538- 541.
6. Tsuchida, M., et al., 2010. Two-Shot type 6-band still image capturing system using Commercial Digital Camera and Custom Color Filter, *Proc. ACM Siggraph*, Poster, article No. 66.
7. Shrestha, R., et al., 2011. One-shot multispectral color imaging with a stereo camera, *Proc. SPIE-IS&T Electronic Imaging*, 7876, 797609-1 - 797609-11.
8. Pratt, W. K., and C.E. Mancill, 1976. Spectral estimation techniques for the spectral calibration of a color image scanner, *Applied Optics*, OSA, 15, 73-75.

*Address: Masaru Tsuchida, Communication Science Laboratories, NTT Corporation,  
3-1 Morinosato-Wakamiya, Atsugi-shi, Kanagawa, 2430198, JAPAN  
E-mails:tsuchida.masaru@lab.ntt.co.jp*



# Study on Perceptible and Acceptable Colour Ranges of Blue Primary Colour of Displays

Yoojin KANG, SeungHyun KIM, Sungjin BANG, Jungsub HWANG,  
Yu Hoon KIM, Jang-Un KWON, Jang Jin YOO, Moojong LIM  
Image Quality Development Department, LG Display Co., Ltd.

## ABSTRACT

This paper aims to analyze the blue primary's perceptible and acceptable ranges since the blue material of a three-primary display generally affects its lifetime mainly. Test images were emulated depending on coordinates of blue primaries. On the other hand, red and green primaries' colour coordinates remain the same as those of Rec. 709. To find perceptible and acceptable range, the test images and a Rec. 709 image as a reference were compared. As a result, visually perceptible and acceptable blue primaries were found so that the blue primary of Rec. 709 can be replaced.

## 1. INTRODUCTION

The diode lifetime of the display is one of the important components to maintain the display performance. The diode's lifetime is closely related to the total lifetime of the display in the LED/OLED field using red, green and blue emitting diodes. Generally, the selection of the blue diode has been a hot issue because the lifetime of the blue diode is shorter than the red and green diode's in LED/OLED field (Michael 2009). For instance, in the case of using the materials for the blue diode to reproduce Rec.709 colour gamut, the total lifetime of the display could be reduced and vice versa. In order to enhance the lifetime of the display, it needs to select the blue materials which can reproduce the colour gamut below Rec.709's. However, in the case of selecting the blue materials which can reproduce the colour gamut below Rec.709 colour gamut, it can cause the degradation of the image quality. Thus, the study for selecting the proper blue materials which does not perceptually affect the image quality and enhancing the lifetime of the display at the same time is needed. In this paper, in order to select the blue materials, we suggest the visually perceptible and acceptable blue colour range.

Kim et al. have researched the effect of blue primary colour on preference and colourfulness of display using 8 blue sample primaries on blue boundary (S.H. Kim 2013). Then, we have extended Kim et al.'s study by using more blue sample primaries.

The perceptible and acceptable blue colour range compared to the blue of Rec.709 was following 2 steps. First, the blue primary colour samples were retained and images using blue primary colour samples were emulated. Second, the experiments for emulated images were done.

## 2. METHOD

### 2.1 Sample Preparation

Wide colour gamut LCD monitor – HP LP2480zx 24 inches – which has 2.2 gamma and 230 luminance, were used for image-quality assessment. Fig.1 shows 98 numbers of colour coor-

ordinates of test blue primaries and Rec. 709's blue primary were used in image-quality assessment. In order to select blue primary colour samples, the blue  $u, v$  coordinate (0.18, 0.16) of Rec.709 were divided into  $\Delta u'v' = 0.01$  intervals. We chose 0.01 intervals because  $\Delta u'v'=0.038$  is by the result of the previous assessments using Macbeth's blue patch which is different from our experiments' blue colour. In addition, people can perceptible between blue samples' difference in case of using  $\Delta u'v'=0.038$ . (Advanced PDP development 2009).

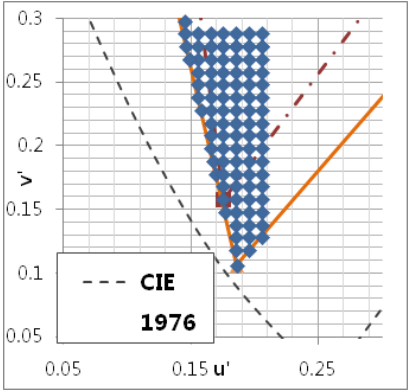

Figure 1: Blue samples.

Original images with Rec.709 gamut were carefully selected when 90% of accumulated pixels at 180~300 hue angle have over 70% of saturation. Fig.2 shows the original images-blue patch and general images. Total 5 original images were manipulated to produce test images sets emulating each colour gamut for psychophysical experiments. The original image and emulated images' luminance are all same as 230 nit. On the other hand, red and green primaries' colour coordinates remain the same as those of Rec. 709.



Figure 2: Original test images (5 contents).

2.2 Psychophysical Experiment

Paired comparison method was used to judge perceptible and acceptable range under ambient illumination condition of 250 lx which is the recommended illumination value by ISO 9241-307 standard for general building area and office condition. Ten observers, seven males and three females, with experience for image-quality evaluation of display participated in the experiments. Two images were displayed side by side on the wide colour gamut LDC monitor. A reference image with Rec. 709 colour gamut were displayed on the left

side of the LCD monitor and the test images which had been manipulated by blue primary colour was displayed on the right side of the LCD monitor (T.Y Park 2011). Observers were asked two questions. One is ‘Is the test image(right) perceptible compared to the reference image(left)?’ and the another is ‘Is the test image(right) acceptable compared to the reference image(left)?’. In both questions, observers were asked to select left or right button. Psychophysical experimental data were computed as ‘yes’ or ‘no’ (including ‘same’ and ‘same’ is calculated as ‘yes’).

### 3. RESULTS AND DISCUSSION

Fig.3 (a) shows perceptible range of blue colours compared to the blue primary of Rec.709. The diamond marks show ranges which people can percept as Rec.709’s blue colour and triangle marks show opposite of that. The perceptible range of blue covers from (0, -0.01) to (0, +0.02) in v’ axis compared to Rec.709’s blue u’v’ (0.18, 0.16). The v’ axis of the perceptible range is longer than the u’ axis of that.

Fig.3 (b) shows acceptable range of blue colours compared to the blue primary of Rec.709. The diamond marks show ranges which people can accept as Rec.709’s blue colour and triangle marks show opposite of that. The acceptable range of blue covers from (-0.015, +0.06) to (+0.01, -0.05) in u’ axis and from (-0.01,+0.07) to (+0.01,-0.05) in v’ axis compared to Rec.709’s blue u’v’ (0.18, 0.16). The v’ axis of the acceptable range is longer than the u’ axis of that alike the perceptible range of blue colour.

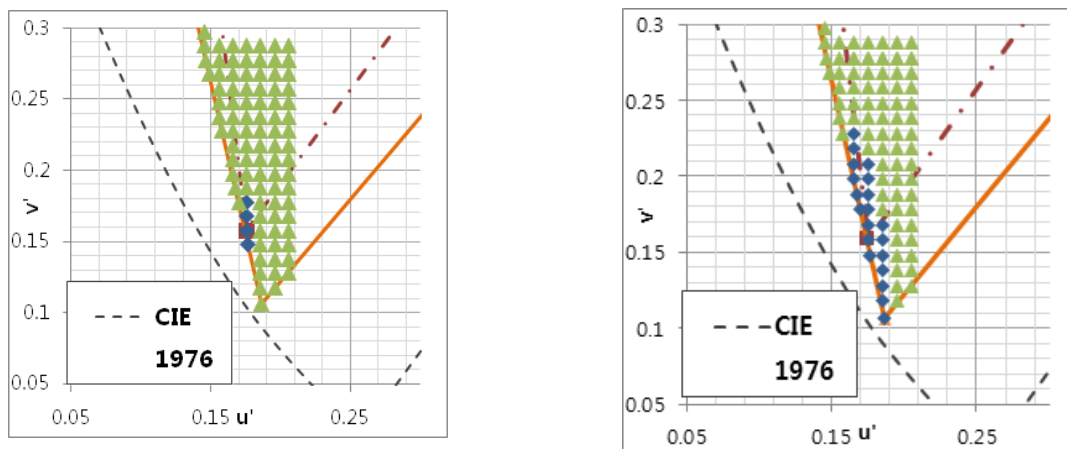

(a) Perceptible ranges of the blue colour. (b) Acceptable ranges of blue colour.

Figure 3: Perceptible and acceptable ranges of the blue colour.

Table 1. shows the summary of the results through psychophysical image-quality assessment. As a result, the perceptible range of the blue colour is (0.18+0/-0, 0.16-0.01/+0.02) and the acceptable range of the blue colour is (0.18-0.01/+0.01, 0.16-0.05/+0.07). We confirmed that the variation of u’ axis of blue primary colour is more perceptually affected the image quality than that of the variation of v’ axis on the image quality. This result can be used to select the blue materials to enhance the lifetime of the display.

Table 1: Summary of the results from the experiment.

	Range	Remarks
Perceptible range (compared to BT.709)	✓ u' axis: non exist ✓ v' axis: -0.01, +0.02	@ CIE 1976 's blue primary coordinate
Acceptable range (compared to BT.709)	✓ u' axis: -0.01, +0.01 ✓ u' axis: -0.05, +0.07	

#### 4. CONCLUSIONS

This paper focused on finding blue colour range which can be used instead of blue colour of Rec. 709. To acquire more reliability on this result, the effect on image quality by changing blue colour range was considered. With respect to perceptible range of blue colour, (0.18+0/-0, 0.16-0.01/+0.02) can be replaced blue colour coordinate of Rec. 709. Considering acceptable range of blue colour, (0.18-0.01/+0.01, 0.16-0.05/+0.07) can be used instead of blue colour coordinate of Rec. 709. As a result, the variation of u' axis of blue primary colour is more perceptually affected the image quality than that of the variation of v' axis about the image quality. It is possible to develop the narrower colour gamut display than Rec.709 having similar image quality of that of Rec.709 perceptually if selects the blue materials having the variation of v' axis rather than the variation of u' axis compared to the blue of Rec.709.

#### REFERENCES

- Michael, E., et al., 2009. Perceptual Effects of Reducing Blue Power, *SID '09*.
- Kim, S.H., et al., 2013. The Effect of Blue Primary Color on Preference and Colorfulness of Display, *SID '13* (in press).
- Advanced PDP Development Center, 2009. *The human technology Symposium about the color viewing angle*.
- Park, T.Y., et al., 2011. The Effect of Gamut Range on Image Quality Preference and Naturalness Acceptability for Wide Gamut Display, *IDRC'11*.

*Address: Yoojin Kang, Image Quality Development Department, LG Display  
1007, Deogeun-ri, Wollong-myeon, Paju-si, Gyeonggi-do, 413-779, Korea  
E-mail: yoojin@lghdisplay.com*

# Preserving Scene Texture Perception in Colour Image Enhancement: Luminance-based Monotonic Normalisation

Stuart O J CRICHTON,<sup>1,2</sup> Anya HURLBERT,<sup>2</sup> Gui Yun TIAN<sup>1</sup>

<sup>1</sup> School of Electrical and Electronic Engineering, Newcastle University

<sup>2</sup> Institute of Neuroscience, Newcastle University

## ABSTRACT

Incorrectly exposed images and those taken under strong colour casts have reduced visible information. Many histogram equalisation approaches have been proposed to combat this problem by enhancing contrast using both local and global areas of an image. Most of these methods ignore the contents of an image whilst assuming specific scene statistics to guide alterations in the characteristic shape of an image histogram. This paper proposes a new method of enhancement for under- and over- exposed images, which preserves important features of histogram shape and monotonicity across the channel(s) by using its luminance skew, a perceptual indicator of surface quality. This approach thereby also preserves perceived texture properties.

## 1. INTRODUCTION

Images may require either enhancement or equalisation in order to increase their contrast as a precursor to further processing. Several causes can result in an image requiring enhancement, ranging from an inappropriate exposure at capture to the numerous sub-effects of illumination. Previous histogram equalisation (HE) methods have aimed to maximise contrast across the entire image, whilst assuming certain scene characteristics, with no targeting or use of specific image contents. Most histogram equalisation methods follow the lead of the original HE (global) algorithm (Gonzalez and Woods 2002), where the shape of a histogram is altered solely in accordance with a set statistical rule. This redistribution introduces a number of perceptible artefacts, with contrast enhancement occurring sporadically across an image. These problems are caused by ignoring histogram contents and have been noted (Wang and Ward 2007).

Historically, histogram equalisation methods were solely proposed for grayscale images, but the need for colour image equalisation methods has become increasingly apparent. The simple application of single channel grayscale algorithms to each channel of an RGB image independently is a potential solution, but typically results in artefacts because of interactions between the three colour channels. For example, algorithms such as those in Morel et al. (2012) may introduce simple salt and pepper noise artefacts, which with three channel RGB images become more apparent as they give rise to abnormal colours. Therefore, colour image equalisation techniques (Limare et al. 2011) have had to be developed separately resulting in a number of new approaches, most of which still follow the same general outline. A drawback of some approaches is the use of the perceptually non-uniform sRGB space for image capture. Image processing in this space may lead to contrast enhancement but at the same time alter the perception (Sharan et al. 2008) of that scene by a human observer, either by changing the luminance skew or histogram shape. Therefore if the perception of the scene is of the utmost importance, as it should be, any equalisation method should attempt to minimise the perceptual change in the scene. Morel et al. (2012) and Palma-Amestory et al.

(2009) have attempted to do this, but they still introduce certain artefacts.

The work presented within this paper has its foundations in previous work (Finlayson et al. 2005), which showed the performance of the monotonic transform when dealing with images under strong colour casts. The work here will tackle under- and over-exposed images by introducing a new variant of the transform to deal with images exhibiting highly skewed luminance histograms, which are also linked to texture perception (Lavanya et al. 2008). We will show that the luma skew monotonic transform produces contrast enhanced and roughly colour invariant results that are also perceptually texture invariant.

## 2. METHOD

Heavily skewed histograms can be caused by a combination of either under- or over-exposure in specific scenes. Material textures and lighting geometries may also contribute, in conjunction with an incorrect exposure level or highly chromatic illumination. Ciurea and Funt (1998) illustrate images exhibiting skewed histograms caused by combinations of intentional underexposure related to scene properties.

### 2.1 The statistical basis

We first investigated the relationships between different luma statistics across a large range of images, to use these for threshold settings. In order to do this the luma statistics for each image within the SFU dataset (Ciurea and Funt 1998) were retrieved. These statistics included the luminance skew (*lumaSkew*) and mean (*meanLum*) and total pixel count (*maxLumCount*) for the most common intensity.

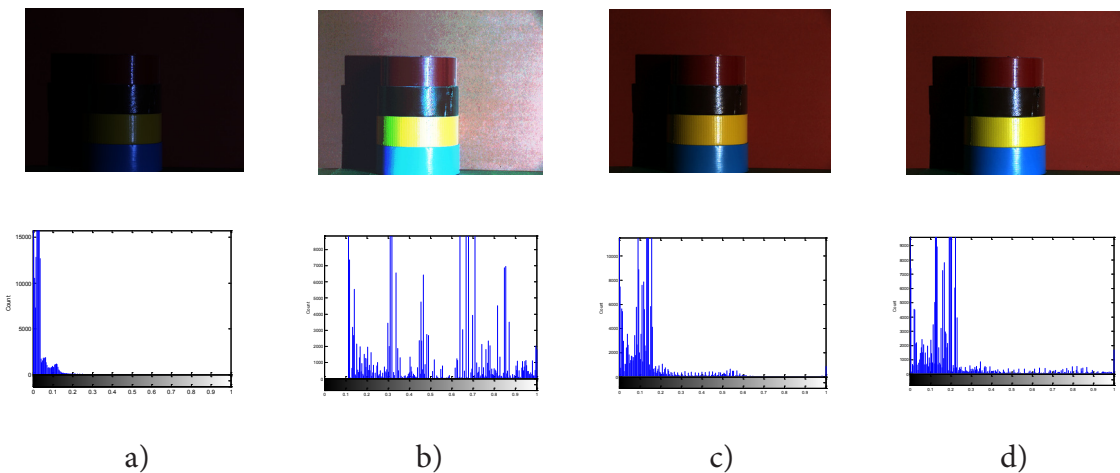

Figure 1: An example of an image (a) whose luminance skew sign has been preserved, but histogram shape changed by b) histogram equalisation, c) simplest colour balance algorithm. The result of the proposed luma skew MT is shown in d).

### 2.2 The algorithm

The luma image is calculated using the Rec.709 standard, where  $x$  and  $y$  are pixel locations, and R, G and B are the three colour channels:

$$luma(x, y) = (0.2126 \times (I_R(x, y))) + (0.7152 \times (I_G(x, y))) + (0.0722 \times (I_B(x, y))) \quad (1)$$

*lumaSkew* is then calculated, where  $m$  and  $n$  are the dimensions of the image,  $N$  is the total number of pixels, *meanLum* is the mean luminance of the image and *sdLum* is the standard deviation:

$$\text{meanLum} = \left( \frac{\sum_{m=1}^{x-1} \sum_{n=1}^{y-1} \text{lumaI}(x,y)}{N} \right) \quad (2),$$

$$\text{sdLum} = \sqrt{\frac{\sum_{m=1}^{x-1} \sum_{n=1}^{y-1} (\text{lumaI}(x,y) - \text{meanLum})^2}{N}} \quad (3)$$

$$\text{lumaSkew} = \left( \frac{\sum_{m=1}^{x-1} \sum_{n=1}^{y-1} (\text{lumaI}(x,y) - \text{sdLum})^3}{(N \times \text{sdLum})^3} \right) \quad (4)$$

The pixel count threshold (*pixelThreshold*) is then calculated for each channel, depending upon the direction of luma skew. These thresholds were derived from the analysis of the luminance statistics of the image datasets.

For a positive *lumaSkew*;

$$\text{Threshold} = \frac{\max \text{LumaCount}}{\left( \frac{|\text{lumaSkew}|}{\text{lumaSTD}} \right)} \quad (5)$$

For a negative *lumaSkew*;

$$\text{Threshold} = \frac{\left( \frac{\max \text{LumaCount}}{100} \right)}{\left( \frac{|\text{lumaSkew}|}{\text{lumaSTD}} \right)} \quad (6)$$

If *lumaSkew* is equal to 0, and more than 244 unique intensities ( $u_{R,G,B}$ ) exist in each channel:

$$\text{Threshold} = \frac{\max \text{LumaCount}}{\left( \frac{1}{\text{lumaSTD}} \right)} \quad (7)$$

We then define  $g_{R,G,B}$ , the scale factor, by assuming 8-bit colour depth,

$$g_{R,G,B} = \frac{255}{(u_{R,G,B} - 1)} \quad (8)$$

rank and transform the intensities that are below the calculated thresholds,

$$mI_{R,G,B}(x,y) = n_{R,G,B} \times g_{R,G,B} \quad (9)$$

and leave all non-qualifying intensities at their original values.

### 3. RESULTS AND DISCUSSION

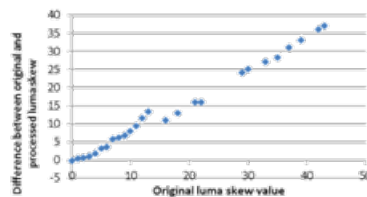

Figure 2: Average pre and post processing luma skew values across images in Ciurea and Funt 1998.



Figure 3: An example of processing a) an overexposed image, and the results of b) histogram equalisation, c) SCB, d) intensity preserving SCB, e) the MT and f) the luma skew MT.

This algorithm was then used to process the entire SFU dataset (Ciurea and Funt 1998). Figure 3 shows the luma skew preserving nature of the algorithm by comparing the average pre- and post-processing luma skew values.

#### 4. CONCLUSIONS

Experimental results show that the proposed transform produces good results when dealing with under- and over-exposed images, as well as with strong colour casts. While SCB also shows this level of performance it also requires the use of defined variables, whereas the transform presented here is completely automatic. It also preserves the contents of the image by retaining the characteristic histogram shape across each channel. The nature of the basic monotonic transform also means that it does not introduce new or amplify existing noise in the image. This is especially useful when aiming to equalise images that have been severely underexposed or taken with lower quality sensors, or in certain situations. The weakness of the algorithm is its reliance upon a natural continuous histogram. Its greater strengths however, mean that it is quite powerful when dealing with badly exposed and low SNR images. In particular, this enhancement method outperforms other state of the art algorithms with respect to the required balance between the degree of image enhancement and the subsequent effects on human texture perception, across both under- and over-exposed images.

#### REFERENCES

- Gonzalez, R.C., and R.E Woods 2002. *Digital Image Processing 2<sup>nd</sup> Edition*, Prentice Hall.
- Wang, Q., and R.K. Ward 2007. Fast image/video contrast enhancement based on weighted thresholded histogram equalization, *IEEE Transactions on Consumer Electronics*, 53(2) 757-764.
- Morel, J.M., A.B. Petro and C. Sbert 2012. Toward a Natural Local Color Balance, *Proceedings of the 6<sup>th</sup> European Conference on Colour in Graphics, Imaging, and Vision*, 211-216.
- Limare, N., J.L. Lisani, J.M. Morel, A. Belén Petro and C. Sbert 2011. Simplest color balance, *Image Processing On Line*, doi: <http://dx.doi.org/10.5201/ipol.2011.llmps-scb>.
- Sharan, L., Y. Li, I. Motoyoshi, S. Nishida and E.H. Adelson 2008. Image statistics for surface reflectance perception, *Journal of the Optical Society of America A* 25(4) 846-865.
- Palma-Amestoy, R., E. Provenzi, M. Bertalmío and V. Caselles 2009. A perceptually inspired variational framework for color enhancement, *IEEE Transactions on Pattern Analysis and Machine Intelligence* 31(3) 458-474.
- Finlayson, G.D., S. Hordley, G. Schaefer and G.Y. Tian 2005. Illuminant and device invariant colour using histogram equalisation, *Pattern Recognition* 38(2) 179-190.
- Ciurea, F. and B. Funt 2003. A large image database for color constancy research, *Proceedings of the IS&T/SID's Eleventh Color Imaging Conference* 160-164.

*Address: Stuart O.J. Crichton, School of Electrical and Electronic Engineering,  
Institute of Neuroscience, Newcastle University,  
Newcastle upon Tyne, Tyne and Wear, NE1 7RU, UK  
E-mails: s.o.j.crichton@ncl.ac.uk, anya.hurlbert@ncl.ac.uk, g.y.tian@ncl.ac.uk*



# The Influence of High Luminance Levels on Perceived Colour and Texture Differences

Eric KIRCHNER,<sup>1</sup> Pina MÜLLER,<sup>2,3</sup> Lan NJO<sup>1</sup>

<sup>1</sup> AkzoNobel Automotive & Aerospace Coatings, Sassenheim

<sup>2</sup> Hochschule Esslingen, Esslingen

<sup>3</sup> AkzoNobel Decorative Coatings, Sassenheim

## ABSTRACT

Perceived colour and texture differences are expected to change depending on illuminance level. For illumination darker than reference conditions (1000 lux), earlier studies have indeed reported such changes. However, there are hardly any studies for illuminance levels higher than 1000 lux, although color difference equations are often used for those conditions as well. We studied perceived colour and texture differences between pairs of metallic coatings, at two illumination levels: 1500 and 14.000 lux. Our results show in that range, there is no noticeable effect from illuminance level. This result is compared to results obtained in previous studies, and explanations for the new results are presented.

## 1. INTRODUCTION

Colour difference equations are expected to perform best under the so-called reference conditions. Under conditions that deviate from the reference conditions, correlation between visual and calculated colour differences is expected to decrease. The CIE recommends to study those non-reference conditions. One of the reference conditions is that illuminance should be 1000 lux. If illuminance decreases to much lower values, changes in color vision are expected. Under daylight conditions color vision is provided by the cones (photopic vision), while under darker conditions this gradually changes to the rods (mesopic and scotopic vision). The absolute color perceived for objects is known to change for different luminance levels (cf. e.g. Hunt effect and Bezold-Brücke effect). But it also affects perceived color differences. For example, the Stevens effect describes how (perceived) brightness contrast increases when the luminance level increases.

Several past papers investigated the effect of changing illuminance levels on perceived color differences for levels well below the reference value of 1000 lux. Pridmore and Melgosa (2005) performed a meta-analysis of data from four earlier studies, reporting improvement in colour discrimination for higher luminance levels. However, the highest luminance value in the data was 401.5 cd/m<sup>2</sup> (not stopping the authors to extrapolate to values of 10,000 cd/m<sup>2</sup>). Georgoula, Luo and Cui (2011) studied the effect of luminance values up to 1257.5 cd/m<sup>2</sup> on perceived color differences. A small reduction of perceived color difference of 3% was reported when luminance decreased to 444.8 cd/m<sup>2</sup>. Similarly, Guan and Luo (1999) found no effect for luminance values between 429 and 1261 cd/m<sup>2</sup>. Finally, Baah, Green and Pointer (2012) changed illumination levels from 25 to 3000 lux. Compared to the reference value of 1000 lux, both colour discrimination thresholds and acceptance thresholds were found to decrease significantly if illumination increased to 2000 and 3000 lux. Surprisingly, these thresholds were found to also decrease significantly if illumination decreased to 250 and 50 lux.

We conclude that only few systematic studies have been done on illuminance levels above (rather than below) the reference value of 1000 lux. In this paper, we will examine this topic, using samples of metallic coatings. A related issue is to assess the effect of changing illuminance levels on the perceived texture of effect coatings. It is well known that visual acuity decreases for decreasing levels of luminance, lower than 1 cd/m<sup>2</sup> (Hecht, 1928). Since the resolving power of the human visual system is an important parameter that determines the texture observed, we may expect that texture perception changes with luminance.

## 2. EXPERIMENTAL

In the working area of bodyshops, illuminances range from typically 500 to 15.000 lux. High illuminance levels are realized by spotlights, that are often used in the car repair process to assess color and texture differences. In the tests, we used the SunGun™ Color Matching Light of 3M that is also used by many bodyshops. Two illuminance levels were chosen: 1500 lux and 14,000 lux, the latter being the value used in bodyshops when using this device. We selected 40 pairs of samples with metallic coatings, and 12 pairs were added into later sessions for determining observer repeatability. Color differences within pairs ranged from  $dE_{CMC}(1.5:1)=0.30$  to 6.30 (average: 2.03). Six observers of normal color vision participated in the tests. Each observation resulted in a visual score for Color difference and for Texture difference. A five point category scale was used to judge the perceived difference, similar to the procedure of Baah, Green and Pointer (2012). A score of 5 means “No or hardly any perceptible color difference”, whereas a score of 1 means an “Extremely large color difference”.

In trial sessions, we found that reproducibility in visual scores was relatively bad, up to 0.71 units. In order to avoid outliers in the visual scores, we decided to let the observers do the visual tests in observer pairs. Immediately after independently giving a visual score, the results of both observers were compared with each other. If the difference was larger than 1 unit, each observer tried to justify the visual score to the other. One or both observers would need to change the score until both scores were in agreement with each other (again, within 1 unit of visual scores). In this way, several outliers were detected, and agreement between observers improved. Each observer was teamed up with each other observer, forming different observer pairs. In order to avoid judgment bias, observer pairs changed with each session. Each set of sample pairs was assessed by six different observer pairs.

## 3. RESULTS AND DISCUSSION

The results from the visual test show that repeatability (intra-observer) and reproducibility (inter-observer) errors have a maximum value of 0.27 units, comparable to unpublished results obtained in similar tests we have done before. More importantly, repeatability and reproducibility errors are found to be independent of illuminance level. In Figure 1, we show the average scores for color differences, where the average is taken from all sample pairs but not from observers. A change in illuminance level from 1500 to 14.000 lux is shown to have no noticeable effect on the average color difference. When we investigate the visual score for each sample pair, after averaging over all observers, we find the results shown in Figure 2. These graphs show that there is no consistent change in observed color or texture differences, when illuminance levels increase from 1500 to 14.000 lux.

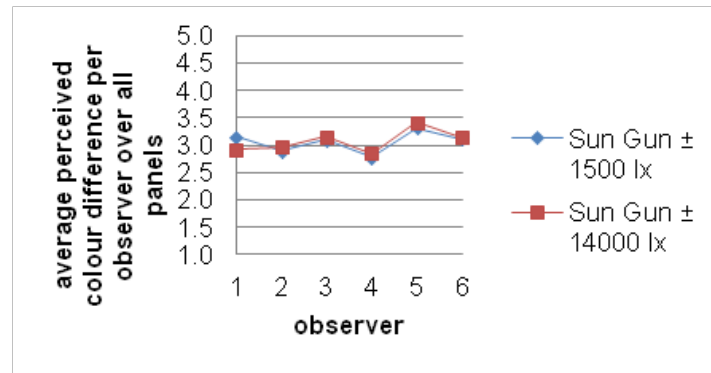

Figure 1: Perceived color difference per observer, averaged over all panel pairs.

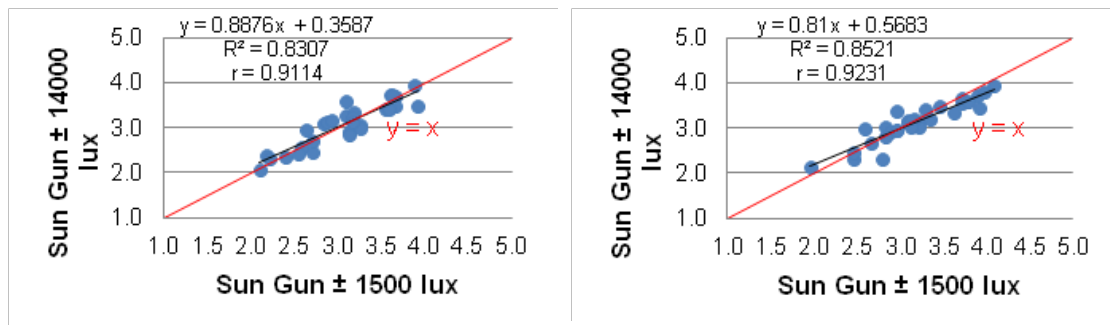

Figure 2: Perceived color (left) and texture (right) difference for 1500 and 14,000 lux.

Our results show no effect of changes in illuminance level on perceived color and texture differences. This is surprising since the studies mentioned in the introduction show that color perception does change with illumination level, and since texture perception depends on the ability to see minute details, which is known to be strongly dependent on illuminance level. A first explanation for these results is that it is important to distinguish between changes in absolute (color and texture) parameter values and changes in relative parameter values, i.e. differences. Although absolute color and texture change depending on illuminance level, both samples in a sample pair may experience a similar change, leaving the difference unchanged.

Another explanation is that in studies that did report effects from influence of illuminance on perceived color differences, often illuminance levels were used much smaller than those studied here, as argued below. For those studies, a significant effect of changes in illuminance on perceived color differences was found only for relatively dark conditions, where photopic vision is gradually replaced by mesopic and scotopic vision. Such a change in the cellular mechanism for color vision does not occur for illuminance levels above the reference conditions (1000 lux).

To estimate the illuminance levels used in these past studies we will assume all samples in those studies to be grey, perfectly Lambertian reflectors with reflectance factor  $\beta$ . Then illuminance  $E_v$  (unit: lux) and luminance  $L_v$  (unit:  $cd/m^2$ ) relate as  $L_v = \beta E_v / \pi$ . This assumption is crude but acceptable, since many of the samples used in the previous studies are solid colors, providing mainly diffuse reflection. They were often not grey, of course, making the approximation indicative only. With this approximation, the study of Georgoula, Luo and Cui (2011) predict only a 3% reduction in perceived color differences when illuminance levels decrease from 7900 to 2800 lux (and a 31% reduction only when further decreasing to 21 lux). Similarly, Guan and Luo (1999) predict no reduction in perceived color differences when reducing illuminance from 7900 to 2700 lux (and an 8% reduction when further

reducing to 75 lux). Therefore our finding that no influence on perceived color differences can be found when comparing illuminance levels of 1500 and 14,000 lux is consistent with the results from previous studies.

Regarding the effect of changing illuminance levels above reference conditions (1000 lux) on perceived *texture*, our results show no significant effect on perceived texture differences. This is consistent with earlier publications showing that visual acuity remains approximately constant for luminance levels above 10 cd/m<sup>2</sup> (Hecht, 1928).

Our results suggest that in some cases when color differences seem to change with changes in illuminance level, this is in fact caused by simultaneous changes in light spectrum (metamerism). Although we used the same spotlight for both illuminance levels, the light spectrum does not remain completely constant. Color temperature changed from 3600 K at 1500 lux to 4800 K at 14,000 lux. A different method to change the illuminance level of the light spot would be to use optical filters, but tests showed that these filters change the directionality of the light, in turn causing changes in perceived texture.

We expect that in many studies on the effect of changes in illuminance on perceived color differences, metamerism occurs as well. Thus Baah, Green and Pointer (2012) mention that they expect the spectrum of their fluorescent lamps to change with illuminance level, but the authors did not attempt to measure it. Interestingly, in practical situations a change in illuminance level is almost always accompanied by a change in light spectrum as well. In order to avoid effects from metamerism, we organized a final visual test. Lighting was now realized in a diffuse room, with a ceiling with fluorescent daylight tubes, covered by diffusing cloth. In this room, the illuminance level was put on 650 lux and 12.320 lux. The corresponding color temperature was found to be fairly constant at 5300 and 5600 K, respectively. Also under these conditions, we found no effect from illuminance level on perceived color (and texture) differences.

## REFERENCES

- Baah, K.F., P. Green and M. Pointer, 2012. Colour perception with changes in levels of illumination. In *Proc. SPIE 8292, Color Imaging XVII: Displaying, Processing, Hard-copy, and Applications* ed. By R. Eschbach, G.G. Marcu and A. Rizzi. Burlingame, 829207-01 to 7.
- Georgoula, M., M.R. Luo and G.Cui, 2011. The impact of luminance level on the assessments of colour appearance and difference. In *AIC Conference Proceedings, Zürich*. p.134-137.
- Guan, S., and M.R. Luo, 1999. Investigation of parametric effects using small colour differences, *Color Research Application* 24:331-343 and 356-368.
- Hecht, S., 1928. The relation between visual acuity and illumination, *Journal of General Physiology* 11:255-281.
- Pridmore, R.W., and M. Melgosa, 2005. Effect of luminance of samples on colour discrimination ellipses: Analysis and prediction of data, *Colour Research and Application* 30:186-197.

*Address: Dr. Eric Kirchner, Digital Development Center,  
AkzoNobel Automotive & Aerospace Coatings,  
Rijksstraatweg 31, 2171 AJ Sassenheim, the Netherlands  
E-mail: eric.kirchner@akzonobel.com*

# Perception-based Accurate Colour Calibration of Electronic Displays

Eric KIRCHNER, Ivo VAN DER LANS, Lan NJO  
AkzoNobel Automotive & Aerospace Coatings, Sassenheim, the Netherlands

## ABSTRACT

The use of electronic displays is increasingly popular. Many applications would benefit from increased color fidelity, with colors shown as images on a digital display better matching the perceived colors of physical objects. Our results show that current low-cost methods for improving color fidelity do not provide electronic displays with sufficient color accuracy for highly critical tasks such as color matching. We introduce a new method for color calibration of electronic displays. In contrast to the vast majority of current methods, the new method is completely based on appearance rather than on physical measurements. Results from visual tests show that the new color calibration method results in more accurate color representation on digital displays than with current methods, and achieve almost the maximum achievable calibration.

## 1. INTRODUCTION

The use of electronic displays in business processes and in customer purchasing is increasing rapidly. In many of these cases, color plays an important role. For online retailers, for example, potential customers are lost because displayed images do not accurately represent the true colors of the products being sold. Several methods are commercially available that claim to solve such problems with color fidelity, based on software or on hardware solutions.

Examples of software solutions are known under the (brand) names Calibrize, TruColor and ColorSync. These methods typically display a number of images. Their colors are modified by the user until for example the brightness of two images is matched, or until the image is purely non-chromatic. Modifications inputted by the user are used by the software to derive colorimetric characteristics of the display, such as optimum gamma value, contrast and white point. The colorimetric characteristics are then used to control colors displayed on the device, e.g. through an ICC profile. Hardware based calibration is offered in e.g. the Datacolor Spyder, Monaco Optix and X-Rite EyeOne: a colorimeter measures the emission spectrum of the display for a series of calibration colors. The measured data then determine the colorimetric characteristics of the display. While software calibration methods are cheaper, hardware methods are generally more accurate.

We test the color accuracy obtained with some software and hardware calibration methods. Being unsatisfied with the results, we propose a new method for color calibration of electronic displays, and test its accuracy as well.

## 2. CURRENT METHODS FOR COLOR CALIBRATION

We investigated several current methods for display color calibration: Calibrize as software method and Monaco Optix as hardware method. We use an older type of LCD display (Samsung Syncmaster 710v), expecting color accuracy to benefit from color calibration. With viewers we fixed viewing angles of observers, because displayed colors may vary considerably

with viewing angle. Images were displayed within the same area of the screen, thus avoiding problems related to spatial uniformity and viewing angles.

We investigated how well color differences between physical paint samples are represented by digital images. Three observers of normal color vision watched 66 panel pairs as displayed on a screen. For each panel pair, separate images were generated for three measurement geometries. All physical samples used in this test were car paints (effect coatings). Therefore not only the color, but also the texture was displayed, using a method described in (Van der Lans, Kirchner and Half, 2012). The observers gave a score for the color difference between this digital pair on a scale from 1 (extremely large color difference) to 5 (no or hardly any color difference). Color differences between the pairs ranged from  $\Delta E_{CMC}(1.5;1)=0.4$  to 15 (average value: 3.1), leading to visual scores over the full range from 1 to 5.

Color calibration is valuable if color scores for displayed sample pairs are similar to color scores obtained for corresponding physical sample pairs. For physical samples, we used median values of color scores from 6 observers viewing the pairs with a spotlight. We calculated differences between scores for the calibrated display and for the physical samples. The average absolute difference is 0.56 for Calibrize and 0.59 for Monaco Optix. Scores for displayed images differed by more than 2 units from scores for physical sample pairs in 17 percent of cases for Monaco Optix and 21 percent for Calibrize. Thus performance of these calibration methods is very similar, and both have a substantial number of cases where the color accuracy is still unsatisfactory after calibration.

We also checked the absolute color accuracy of displayed samples, when visually compared to the physical paint samples. An average score was found of 2.6 for Calibrize, and 3.3 for Monaco Optix, indicating a “clear, easy to describe difference” between image and object. In more than 30% of the cases the visual score was smaller than 4, i.e. a clear color difference remained visible between physical sample and its digital representation. Based on these results, it was decided that the improvement in color accuracy obtained by hardware calibration methods such as Monaco Optix did not outbalance the costs of introducing them worldwide for our 10,000s of customers. We concluded that we need a more accurate color calibration method (while keeping implementation costs low).

### 3. A NEW METHOD FOR COLOR CALIBRATION

Our tests of currently available color calibration software hints why color accuracy achieved with those methods is unsatisfactory. Software calibration methods aim at maximizing the color gamut of a display, and making displayed colors as reproducible as possible, but in the calibration process no input is used from visually observed colors in the physical world. Therefore, local illumination conditions are hardly accounted for. With hardware calibration methods, the subjective human factor is eliminated by utilizing measured spectra only. However, in this way local observation and illumination conditions are almost completely ignored. In publications on matching the color appearance of physical objects on electronic displays, visually perceived color differences are usually replaced by measurements with tele-spectroradiometers (see e.g. Kitsara *et al.* 2012).

By basing our study on visual test results rather than on physical measurements of color differences, such as using tele-spectroradiometers, we hope to achieve better color fidelity for a specific display device and specific lighting/observation conditions at reasonable costs. Therefore we decided to develop a new method for color calibration of displays (cf. Kirchner *et al.*, 2010). It is based on matching the perceived color of physical objects with the

colors displayed on the device. Thus it is possible to account for many factors that influence perceived colors, such as spectrum and luminance of the light source(s), distance between display and observer, lateral resolution of the display.

In current applications of Berns' well-known GOG(O)-model (Berns, 1996), model parameters are freely optimized. But mathematical physics analysis shows (Kirchner *et al.*, 2010) that the elements of matrix  $M$  that converts luminances  $Y$  of the red, green and blue channel into tristimulus values  $X, Y, Z$  are:

$$M = \begin{pmatrix} \frac{x_R}{y_R} Y_{R,\max} & \frac{x_G}{y_G} Y_{G,\max} & \frac{x_B}{y_B} Y_{B,\max} \\ y_R & y_G & y_B \\ Y_{R,\max} & Y_{G,\max} & Y_{B,\max} \\ \frac{z_R}{y_R} Y_{R,\max} & \frac{z_G}{y_G} Y_{G,\max} & \frac{z_B}{y_B} Y_{B,\max} \\ y_R & y_G & y_B \end{pmatrix} \quad (1)$$

Thus the nine matrix elements, which only have a purely mathematical significance, are linked to nine parameters that have a clear colorimetric interpretation. They are the chromaticity coordinates  $(x, y)$  of the red, green and blue channel, and the luminance  $Y$  value of each of these channels for the reference white (i.e., maximum intensity).

If the nine elements of matrix  $M$  are simply freely optimized, then according to equation (1) the resulting optimized parameters may imply that the underlying chromaticity coordinates are completely unrealistic (for example, purely achromatic) or even unphysical. For example, the related chromaticity values may lie outside the horse-shoe diagram. Therefore we base our method on using the nine colorimetric parameters mentioned before as fit parameters, instead of using the purely mathematical elements of matrix  $M$ .

## 4. RESULTS AND DISCUSSION

### 4.1 Setting parameter values for the new calibration method

In order to maximize the color match between displayed images of samples and the corresponding physical samples, the nine colorimetric parameters in the new calibration method first need to be optimized for the illumination and viewing conditions under which the physical samples are examined. A great advantage of the new calibration method is that the colorimetric meaning of the parameters allows us to investigate which parameters are most important for getting a good calibration of the display device.

Therefore we investigated how to best use equation (1) to design a practical method for color calibration. Using the same LCD display mentioned before, we directly compared physical samples with displayed images. We took a set of 20 calibration samples covering a wide range of solid colors. Our result show that already a good color accuracy could be obtained by optimizing only the three  $Y_{\max}$  values. This suggested that model parameters can be well estimated using only three instead of all 20 calibration samples. Surprisingly it also suggested that for three calibration samples may all be grey. Indeed, when this was tested we found that with this short calibration procedure using three grey samples we obtained an average RGB difference of 8 units, almost as good as when all 20 calibration panels were used. These results are very similar to the maximum achievable accuracy, being the repeatability numbers for manual matching. This agrees with earlier studies where cross-media color matching led to standard deviations in the range of 4 to 12 RGB units (e.g. Pointer, Attridge and Jacobsen, 2002).

## 4.2 Testing the performance of the new calibration method

In another visual test five observers matched 15 different solid colors, including three grey samples, by manually adjusting a displayed color patch. When comparing the final RGB values from different observers, we find that the median difference of an observer and the average observer is 5.5 in RGB units (reproducibility). We optimized model parameters on the RGB values of the average observer for the three grey samples only. With the optimized model parameters, we find that the median difference of an observer and the average observer is 6 RGB units. Thus, for any solid color the color calibration model is apparently able to produce RGB values that are almost as accurate as any observer would be able to produce. As an indication of the color accuracy of the model, we use the inverse of the calibration model to convert RGB-values into XYZ-values, and hence into CIE-Lab color coordinate values. In this way, we calculate that the color calibration model results in an average color accuracy of  $\Delta E_{\text{CMC}}(1.5:1)=7.0$  for the full set of 15 different solid colors, with the calibration parameters being based only on three (grey) samples.

Our result may be explained as follows. With grey samples for calibration it is most straightforward to account both for the white point and for the luminance level of the light falling on physical samples. After calibration with three grey samples the white point of the display is made more similar to the white point of the illumination scene in which objects are placed. The calibration also provides a more accurate lightness to the digital image of any physical test sample whose color needs to be displayed on the display device.

## REFERENCES

- Berns, R.S., 1996. Methods for characterizing CRT displays, *Displays* 16, 173-182.
- Kirchner, E., I. Van der Lans, S.L. Njo, A. Half and R. Gottenbos, 2010. *Colour calibration of electronic display screens*, Patent WO 2011098502A1. Priority date 12.02.2010.
- Kitsara, C., M.R. Luo, P.A. Rhodes and V. Cheung, 2012. Colour appearance modelling between physical samples and their representation on large liquid crystal display, *Proc. CGIV (Colour in Graphics, Imaging and Vision)*, Amsterdam, 126-130.
- Pointer, M.R., G.G. Attridge and R.E. Jacobson, 2002. Perceived colour differences in displayed colours Part 1: hard copy to soft copy matching, *Imaging Science Journal* 50, 1-9.
- Van der Lans, I., E. Kirchner and A. Half, 2012. Accurate appearance-based visualization of car paints, *Proc. CGIV (Colour in Graphics, Imaging and Vision)*, Amsterdam, 17-23.

*Address: Dr. Eric Kirchner, Digital Development Center,  
AkzoNobel Automotive & Aerospace Coatings,  
Rijksstraatweg 31, 2171 AJ Sassenheim, the Netherlands  
E-mails: eric.kirchner@akzonobel.com*



# Colour Correction Calculus (CCC): From Digital Intermediates towards New Paradigms

Walter ARRIGHETTI  
TECHNICOLOR Creative Services

## ABSTRACT

To date, the digital world of still and moving pictures for video is almost essentially based on the RGB colour model. When it comes to creative or technical colour manipulations done digitally (be it either as part of a on-location workflow, during a post-production pipeline in a Digital Intermediate (DI) theatre, or in the finishing phase for a home/TV master) controls available to artists and engineers range from very intuitive up to completely disorienting. At the same time, fidelity in colour reproduction is mandatory, especially as content is moved from one capturing/viewing device to another (each often implemented in different colour spaces). The DI colour correction phase is also an interesting blend of artistry and photoscenic abilities, as well as deep technical mastery of digital colour, in order to get at what is often referred to as the film's "look" (Arrighetti 2012). Technical features (like the so-called "log" colour spaces) will be explained, envisioning everything under a new and unified mathematical formalism (ibid. 2007), which starts from the basic Colour Science formulæ (Westland 2012).

## 1. DIFFERENTIAL-GEOMETRIC MODELLING OF COLOUR TRANSFORMS

A gamut mapping between (usually different-channels) colour spaces is a vector field  $\mathbf{L}(\mathbf{c})$ , where  $\mathbf{c} \in G$  is the input colour in the source gamut  $G \subset \mathbb{R}^m$  (which is, to every practical aspects, a connected, linearly- and superficially-connected  $m$ -dimensional domain — often even a *convex* one), with  $\dim G = n$ . Let the input and output spaces be both RGB model and their canonical basis be the left-handed vectors' triple  $\{\mathbf{r}, \mathbf{g}, \mathbf{b}\}$ , so  $\mathbf{c} = r\mathbf{r} + g\mathbf{g} + b\mathbf{b}$  and for the input regular sRGB cube,  $(r, g, b) \in [0, 1]^3$ . By the Hodge-Helmholtz' theorem in 3 dimensions, below *orthogonal* decomposition holds (Arrighetti 2007):

$$\begin{aligned} \mathbf{L}(\mathbf{c}) &= R(r, g, b)\mathbf{r} + G(r, g, b)\mathbf{g} + B(r, g, b)\mathbf{b} \\ &= \mathbf{T}(\mathbf{c}) + \mathbf{H}(\mathbf{c}) = \nabla\chi(\mathbf{c}) + \nabla \times \boldsymbol{\eta}(\mathbf{c}) + \mathbf{I} \end{aligned}$$

where  $\mathbf{T}(\mathbf{c})$  and  $\mathbf{H}(\mathbf{c})$  are the conservative (curl-free) and the solenoidal (divergence-free) parts of the colour map, each derived from a *potential* field — a scalar one  $\chi(\mathbf{s})$  for the former and a vector one  $\boldsymbol{\eta}(\mathbf{c})$  for the latter. Due to simple connectedness of  $G$ , no *harmonic* component is present in the above: the third constant term  $\mathbf{I}$  (the 'lift') represents, in chromatically-additive colour models (like the RGB ones, as well as CIE XYZ), an overall colour bias (and is either neglected or incorporated into  $\mathbf{T}$ ).

Furthermore the gradient of the gamut mapping can also be considered, which is indeed a more complete (and complex) mathematical object, called a  $(n, m)$ -tensor field (letting  $\dim G = m$  and  $\dim \mathbf{L}(G) = n$ ), depending on both the  $m$ -channels source- and the  $n$ -channels target-space coordinates.  $\mathbf{T}$  is the tonal mapping, or transfer characteristics which, in RGB spaces, models overall colour correction (incl. lightness and saturation changes).  $\mathbf{H}$  is the field describing local colour-component cross-talks and global hue shifts. Notably,  $\mathbf{T}$  field too may incorporate hue shifts, especially for those colours  $\mathbf{c}$ , where the inter-channel ratios are not preserved, i.e.  $R(\mathbf{c}) : G(\mathbf{c}) : B(\mathbf{c}) \neq r : g : b$ .

As an example, the colour correction information can be transported, from clip to clip, as a series of simple nonlinear transformations controlled by 3 parameters per channel, each representing one degree of freedom of the creative colourist: ‘slope’, ‘offset’, ‘power’. A set of such quantities, transported clip by clip for a whole video asset, is called the Colour Decision List (CDL) and is a well-known example of mathematical equations at the creative service of motion picture colourists (Benitez 2007). Governing equations are:

$$\mathbf{L}(\mathbf{c}) = (o_r + s_r r)^{p_r} \mathbf{r} + (o_g + s_g g)^{p_g} \mathbf{g} + (o_b + s_b b)^{p_b} \mathbf{b},$$

$$\nabla \cdot \mathbf{L} = \frac{\partial R}{\partial r} + \frac{\partial G}{\partial g} + \frac{\partial B}{\partial b}$$

$$= p_r s_r (o_r + s_r r)^{p_r-1} + p_g s_g (o_g + s_g g)^{p_g-1} + p_b s_b (o_b + s_b b)^{p_b-1}$$

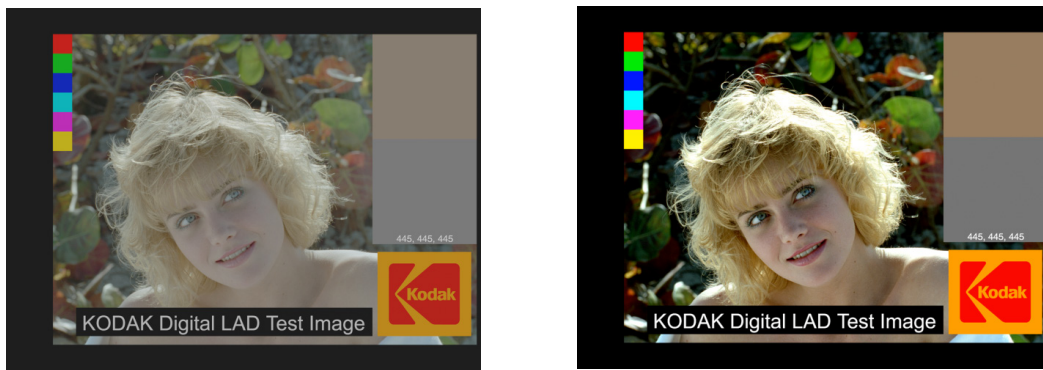

Figure 1: Kodak’s test LAD (Laboratory Aim Density) of a full-aperture 35mm frame (notice the optical soundtrack reserved blank space on the left band). LEFT: Status-M densitometry of a film negative. RIGHT: Linear conversion plus monitor gamma, all in the “Rec.709” HDTV RGB colour space (notice the crushed shadows and highlights).

In the case of 1D LUTs, the associated 3D LUT is totally curl-free and is thus:

$$\mathbf{L}(\mathbf{c}) = R(r)\mathbf{r} + G(g)\mathbf{g} + B(b)\mathbf{b} = \mathbf{T}(r, g, b) = \nabla \chi(r, b, g) + \mathbf{I},$$

where  $R(r)$ ,  $G(g)$  and  $B(b)$  are the colour-curve scalar functions of the 1D LUT. When a specific gamut mapping needs to satisfy creative or technical requirements (Poynton 2012), each of those can be turned into a mathematical (either static, integral or differential constrain, Petrou 2012). Common requirements might be:

1. Tone-scale like-curve condition, which translates in quasi-orthogonal decomposition like the one above, i.e.  $\mathbf{L}(r, 0, 0) \cong R(r)\mathbf{r}$ ,  $\mathbf{L}(r, 0, 0) \cong R(r)\mathbf{g}$  and  $\mathbf{L}(0, 0, b) \cong B(b)\mathbf{b}$ .
2. Colour-neutrality behaviour, like mapping greys to greys:  $\mathbf{L}(g, g, g) = Y(g)(\mathbf{r} + \mathbf{g} + \mathbf{b})$ .
3. Invertibility of the transform, in order for source colours always guaranteed to be recoverable; this often translates by the transform’s Jacobian matrix constrained to be nowhere singular, i.e.  $\det \frac{\partial \mathbf{T}}{\partial (r, g, b)} \equiv \left| \frac{\partial (R, G, B)}{\partial (r, g, b)} \right| \neq 0$ .
4. Invariance with respect to some colorimetric quantities. Common ones are saturation (which means  $R(\mathbf{c}) : G(\mathbf{c}) : B(\mathbf{c}) = r : g : b$ ), hue rotations (which means  $\nabla \times \boldsymbol{\eta} = \mathbf{0}$ ) or en-

ergy difference between couples of colour, tones or colour ranges. In this case adequate metric  $DE$  needs to be chosen, as there are several definitions.

5. Logarithmic transfer characteristics, especially useful for modelling video reproduction capabilities of monitors (Poynton 2012) or the nonlinearities of negative film's densitometry and their digital representation (OpenEXR 2007), cfr. Figure 1.

Despite the RGB colour model is the customary one, some other may be used. For example colourists often deals with corrections on specific colour tones or ranges, therefore a cylindrical (YUV) colour model is often used, possibly uniformly perceptual like the CIE LAB (Commission Internationale de L'Éclairage. 1986) with its  $(L, a^*, b^*)$  coordinates. In such models any variant of lightness  $Y$ , together with hue  $h \in [0, 1]$  and saturation  $\sigma$  (in degrees) are used, defined in the usual ways (Petrou 2012). A "complexified" (Arrighetti 2007) quantity incorporating the latter two, can be defined and termed to as *complex chroma* as  $\zeta := he^{2\pi i \sigma}$ . With this in mind the chrominance information is represented on the complex plane (much like it happens on a colourist's vectorscope video analysis tool, which is used to precisely measure dominant colours in specific parts on an image or video).

## 2. COLOUR LOOK UP TABLES

When the transformation becomes too complex to handle symbolically, or more often it derives from operations that are not 'atomically' represented by defined operators (e.g. matching a particular nonlinear device, or "baking" several colour mappings into one), a discrete analogue to a colour transform is used: *ColorLUT* (colour look-up table), or *CLUT*. It consists in discretizing the source colour space with a (usually regular) grid of samples and explicitly defining the corresponding output colours. Other input colours will be mapping according to some sort of interpolation among neighbouring colours. Please see Figures 2 and 3 for some examples of CLUTs as visually represented using author's code: those representation are commonly known in post-production terminology as "RGB cubes".

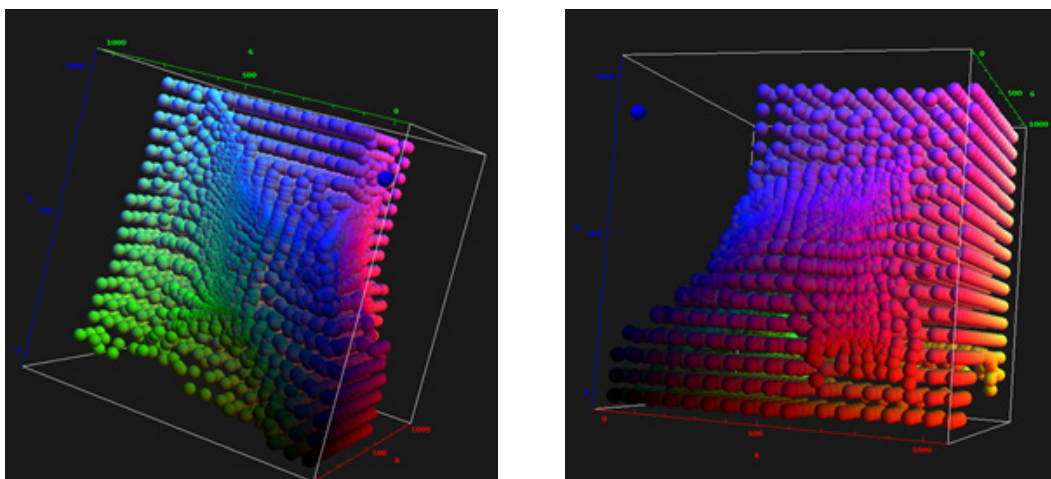

Figure 2: Two views of the same CLUT representing nonlinear gamut expansion from a "linear" RGB colour space (represented by the regular, cubic grid of back colours).

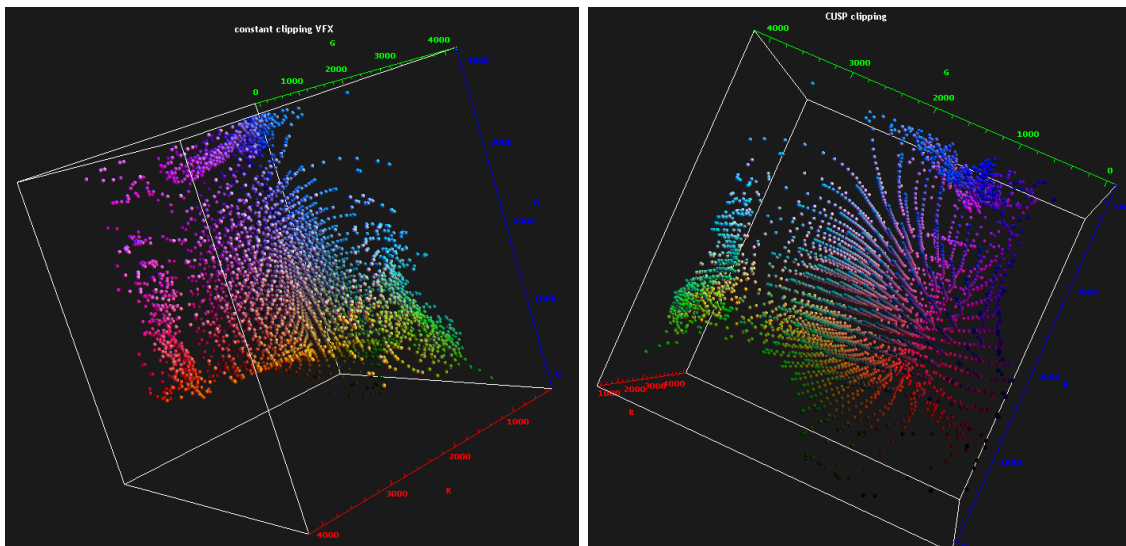

Figure 3: Creative CLUTs representing some colour adjustments for special effects (notice the huge increase in colours near some boundary colours, as well as the over-all hue shift).

### 3. CONCLUSIONS

Mathematical tools provide the basis for complex colour (and, more generally, imaging) operations in video and cinema post-production. Artistic intents can be synthesised too, or later analyzed using such tool, which would help better scientifically measure colorimetric quantities and reproducibility. That is why more and more colour scientists are joining forces in providing core complex solutions and more analytical tools to the imaging engineer/technician.

### REFERENCES

- Arrighetti, W. 2012. Moving Picture Colour Science: the maths behind Colour LUTs, ACES and film ‘Looks’. *Color and Colorimetry*, VIII(B): 27–34.
- . 2011. Colour Management in motion picture and television industries. *Color and Colorimetry*, VII(B): 63–70.
- . 2007. *Mathematical models and methods for Electromagnetism in Fractal Geometries*. Ph.D dissertation. Università degli Studi di Roma “La Sapienza”.
- Benitez, A.B., L. Blondé, B. Lee, J. Stauder, H. Gu. 2007. ASC CDL: a step towards Look Management. In *Proceedings of IBC 2007*.
- Commission Internationale de L’Éclairage. 1986. *Colorimetry, Second Edition*. CIE Publication 15.2, Vienna.
- OpenEXR working group. 2007. *OpenEXR File Layout*. Available at [www.openexr.com](http://www.openexr.com).
- Petrou, M., C. Petrou. 2012. *Image Processing: the fundamentals*. Wiley.
- Poynton, C. 2012. *Digital Video and HD: algorithms and interfaces*, Morgan-Kaufman.
- Westland S., C. Ripamonti. 2012. *Computational Colour Science using MATLAB*. Wiley.

Address: Walter Arrighetti, Ph.D., Creative Services,  
 TECHNICAL, via Tiburtina 1138, 00156, Rome, Italy.  
 E-mails: [walter.arrighetti@gmail.com](mailto:walter.arrighetti@gmail.com),  
[walter.arrighetti@technicolor.com](mailto:walter.arrighetti@technicolor.com)

# 3D Image Quality Improvement Technique Based on the Contrast Characteristic of the Input Image

Ji Young HONG,<sup>1</sup> Yang Ho CHO,<sup>2</sup> Ho Young LEE,<sup>3</sup> Du Sik PARK,<sup>2</sup> Chang Yeong KIM<sup>3</sup>

<sup>1</sup>Department of Visual Communication Design, Kyung Min College

<sup>2</sup>Advanced Media Lab., Samsung Advanced Institute of Technology

<sup>3</sup>Digital Media & Communications R&D Center, Samsung Electronics

## ABSTRACT

To maintain the perceived depth of three-dimensional (3D) images, minimize their degradation, and limit the visual fatigue associated with 3D viewing, we propose a new method for 3D image depth adjustment. Based on just noticeable difference in depth (JNDD – Just Noticeable Depth Difference) testing of the contrast of the input 3D image and the depth of the pictured object relative to its background, we found that the perceived 3D effect can be achieved by controlling the depth according to the contrast characteristic of the input image. We formulate an algorithm for depth adjustment based on this finding, and describe its integration with image display systems.

## 1. INTRODUCTION

The technology of 3D perception aims to reproduce a sense of presence by combining the perception principles of binocular disparity with empirical factors. These principles utilize physiological characteristics of human vision. Unlike in 2D displays, the effect of human visual perception is essential for conveying depth information in 3D displays. The technology for reproducing a three-dimensional feel and sense of presence can be realized through an understanding of human visual characteristics, providing the three-dimensional effect in terms of visual perception. To experience the three-dimensional effect, it is most important to reproduce virtual objects as if they really existed. Therefore, the technology of collecting and perceiving the image as with the human eye is essential for 3D display development, and a technical approach is required to simulate human visual perception in the expression of a 3D image.

The just noticeable difference (JND) has played an important role in broadening the understanding of the human visual perception. The JND represents the visibility threshold at which a human can perceive changes in pixel values, and this threshold has been proven to be dependent on the luminance, the contrast, etc. Based in the JND, the JNDD indicates that a human cannot perceive the change if the depth difference is smaller than the threshold.

In this paper, we introduce a new method for adjusting 3D display depth that maintains perceived depth and minimizes image degradation and visual fatigue. This method is based on the assumption that a just noticeable difference in depth (JNDD) can be largely achieved using contrast, a feature to which the human visual system is particularly sensitive.

The next section of this paper, Section 2, presents a JNDD test and results with respect to the contrast between the background and an object. Section 3 describes the algorithm we developed based on the results of these tests. Finally, section 4 provides concluding remarks.

## 2. JUST NOTICEABLE DEPTH DIFFERENCE TEST ACCORDING TO THE CONTRAST BETWEEN THE BACKGROUND AND OBJECT

In the human eye, regions with more rods than cones are more sensitive to brightness and contrast (Hunt 1995). Of the contrast characteristics, contrast masking refers to the capability of humans to distinguish mixed signals without processing each signal independently. This means that two signals (background and object) interfere with each other, causing the human vision system to perceive yet another signal. This test examines the minimum depth difference that allows images with different depths to be perceived as having the same depth. Also, this experiment was conducted specifically to verify whether contrast information could affect the minimum stimulation depth.

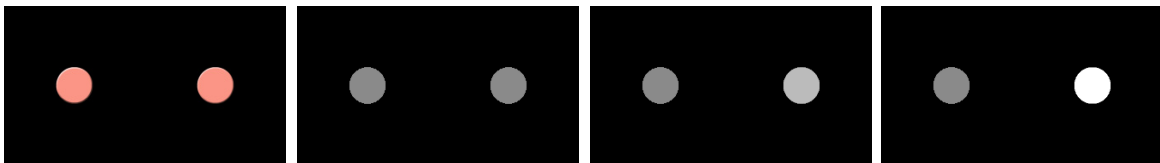

Figure 1. Color image and depth map for the test. (a) A color image; (b) Depth map of objects with the same depth(128); (c) Left object depth = 128, right object depth = 180; (d) Left object depth = 128, right object depth = 255.

The brightness condition was divided into two steps (0 and 100) for the background, and three steps (30, 50, and 70) for the object, based on the J (lightness) of CIECAM02. The depth between object and background was divided over 13 steps through a range of +30 to -30. The brightness of the background and object and the depth of the target object were changed over 13 intervals.

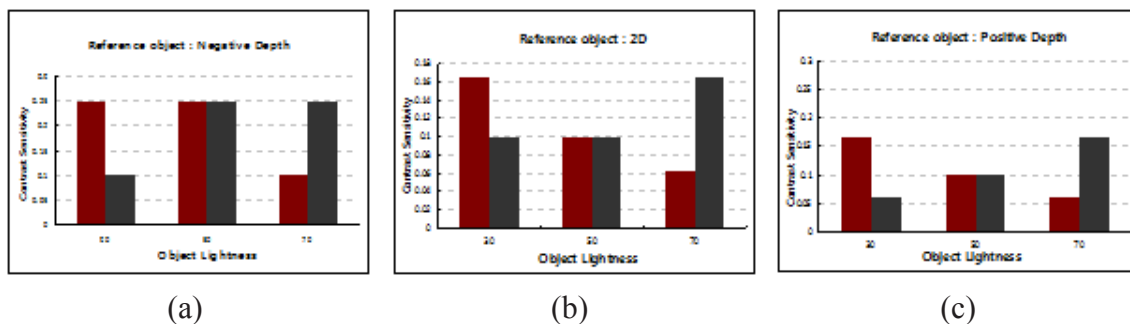

Figure 2. Test results for JNDD according to contrast. Object lightness along the x-axis represents brightness values of 30, 50, and 70. Red bars denote background brightness of 100, and black bars denote background brightness of 0.

Our test results showed that a higher brightness contrast between the background and object led to higher contrast sensitivity, and that when the brightness contrast between the background and object was similar, there was no significant change in contrast sensitivity (Fig. 2). High contrast sensitivity means a sensitive response to the depth difference between the reference object and the target object. For our purposes, contrast sensitivity can be seen as the reciprocal of the difference between the depth of the reference object and the depth of the target object when a difference between the two objects is perceived.

The brightness contrast between the background and object was calculated using the Michelson contrast. For example, when the background brightness was 100 and the object brightness was 30, the contrast calculated using the measured brightness of the display was approximately 0.85. When the background brightness was 100 and the object brightness

was 50, the calculated contrast was 0.61. When the background brightness was 100 and the object brightness was 70, the calculated contrast was 0.33.

### 3. PROPOSED ALGORITHM BASED ON JNDD ACCORDING TO THE CONTRAST

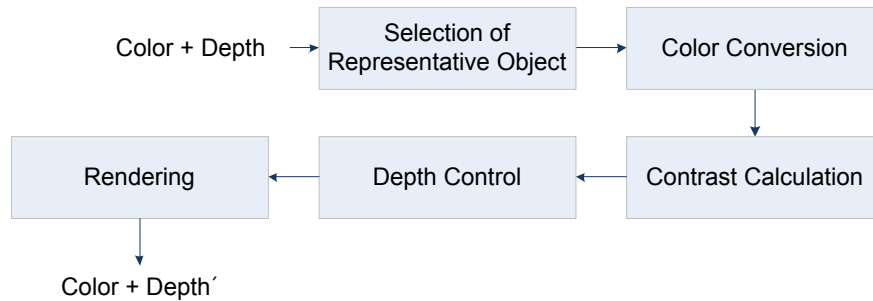

Figure 3. Flowchart of the proposed algorithm.

From the experiments above, we found that the minimum depth recognition characteristic varies with the contrast between the background and (foreground) object of the input image. Accordingly, we conclude that image depth (i.e., depth or disparity) can be controlled using the contrast characteristic of the 3D input image and the depth of the object, suggesting an algorithm that can minimize image degradation and reduce visual fatigue. Our proposed JNDD-based depth control algorithm has five main steps: 1) representative object selection, 2) color-value conversion, 3) calculation of contrast in the input image, 4) contrast and JNDD model, and 5) 3D image creation. When color and depth (disparity) information in the 3D image is input, the image is divided into a background and a (foreground) object. Several methods can be used to separate the background from the object, such as visual attention maps, region of interest, or simple depth information.

The pixels determined to constitute the background are marked 0 and those of the object are marked 1. These are stored in the buffer, while the depth values of the background and object are stored separately. The depth value of the representative object is determined using only the separately stored object depth information. This can be done in many ways; the frequency was used in this study. The depth of the object can be divided into projection, retraction, and 2D. Projection refers to the depth projected from the display plane (negative depth); retraction refers to the depth retracted from the display plane (positive depth); finally, 2D refers to the depth of the display plane. Representative object depth is determined after identifying in which area most of the object depth values exist. The RGB input values of the background and object are stored separately and used to calculate corresponding XYZ values. At this time, the PLCC conversion model infers the RGB inputs using the values pre-measured with the display characteristics:

$$y = y1 + (y2 - y1) \times (x - x1) / (x2 - x1) \quad (1)$$

After measuring the display characteristics, XYZ values and RGB black values must be measured and used at intervals of 15 over the range 0–255. Of the XYZ values, Y values corresponding to the brightness are used to determine the representative brightness of the background and object according to, for example, the average and frequency.

The representative brightness values for the background and object are used to calculate the contrast between the two. This contrast is a conventional Michelson measurement (E.

Peli 1990), which is calculated by comparing the minimum and maximum Y values of the representative background and object, as derived from the color value conversion:

$$C_{michelson} = \frac{Y_{\max} - Y_{\min}}{Y_{\max} + Y_{\min}} \quad (2)$$

The depth of the input image is then readjusted using the contrast value from the brightness characteristic of the background and object. The depth readjustment is based on the results of the psychophysical experiments described in Section 2.

As indicated in Fig. 7, the depth value is normalized according to the maximum depth (depth or disparity) of the input image display. Each display has different maximum depths that can be expressed, so readjustment is essential. After depth normalization, the threshold value for the depth adjustment is determined by the contrast and depth of the object. The contrast of the object (from the background) in the input image can be set to low, middle, high, or no contrast, or it can be indicated using values, whereas the depth threshold can be expressed in a number of different ways. When readjusting the depth based on the determined threshold, a mapping is conducted such that the maximum depth of the input image coincides with the depth readjustment threshold. After readjusting the depth of the input image, a new 3D image is rendered using a depth-image-based rendering (DIBR) technique (C. Fehn 2004).

#### 4. CONCLUSION

This paper proposed an image processing method that adaptively readjusts the depth according to the contrast characteristics and object depths of the input image. The results of psychophysical experimentation showed that the JNDD varies according to the contrast between background and object. These findings were used to formulate an algorithm that divides a 3D input image into its background and object before readjusting the object depth according to the contrast between the two. Finally, the image is rendered to minimize the holes that can be generated in 3D images or 2D–3D conversions, thereby reduce image degradation. In a future work, the performance of the proposed algorithm will be verified through a psychophysical experiment focused on visual fatigue reduction and image quality improvement.

#### REFERENCES

- Hunt, R.W.G., 1995. *Measuring Color*, 2nd Ed., Ellis Horwood Ltd, Chichester.
- Peli, E., 1990. Contrast in complex images. *Journal of the Optical Society of America A*, 7(10), pp. 2032-2040.
- Fehn, C., 2004. Depth-image-based rendering (DIBR), compression and transmission for a new approach on 3D-TV. *Proc. SPIE*, Vol. 5291, p. 93.

*Address: Prof. Ji Young HONG, Department of Visual Communication Design, Kyung Min College, 545, Seobu-ro, Uijeongbu-si, Gyeonggi-do, 480-702, KOREA*  
*E-mails: placebo.joan@gmail.com, yho.cho@samsung.com, hyounglee@samsung.com, dusikpark@samsung.com, cykim@samsung.com*



# New HDR-type Imaging Methods Based on $LCH_{(CIELAB)}$ and $JCH_{(CIECAM02)}$ Color Spaces

Mei-Chun LO, Jin-Ling LIN and Wen-Bin LI  
Dept. of Information Management, School of Management, Shih Hsin University

## ABSTRACT

The objective of this research was to develop effective HDR-type imaging methods which can be applied to get satisfactorily pleasing appearance- rendition results, close to HDR but without the need to take multiple images (or carry a tripod) as done in a normal HDR imaging software. Three methods were implemented with the incorporation of different color space transformers, mainly including RGB,  $LCH_{CIELAB}$  and  $JCH_{CIECAM02}$ . These modules were variants of the CLAHE (Contrast Limited Adaptive Histogram Equation) algorithm, including a standard (uniform), a hyperbolic with cube root, and a modified hyperbolic. Parameters had to be optimally modulated and refined in each of CLAHE methods to achieve good quality of desirable results. Additionally, two pre-processing forms of an auto gamma (histogram modification/equation) and a smoothing filter were also optimally derived and performed on the channels of RGB of test images. With the optimal choice of parameters used, it was found that the CLAHEs derived based on the mode of  $JCH_{CIECAM02}$  or  $LCH_{CIELAB}$  increased more contrast and gave better satisfactory results than those based on RGB color space. Overall, the modified hyperbolic type of CLAHE based on  $JCH_{CIECAM02}$ , rendered much pleasing and convincing enhancement/detail results than the one based on the  $LCH_{CIELAB}$  space.

## 1. INTRODUCTION

In general, HDR-type imaging methods developed in the field of image processing can be discriminated into two classes of contrast enhancement: global and local. Global contrast enhancement can sometimes produce disappointing results when both shadow and highlight details have to be adjusted simultaneously. On the other hand, a method with the local contrast adjustment can provide the advantage to map one input value to many different output values, depending on the values of the neighboring pixels. Therefore it allows for simultaneous adjustments of both shadow and highlight areas. Based on the image's original gray level distribution, the image's histogram can be redistributed or reshaped into reasonably uniform distribution property in order to increase renditions of both contrast and details.

## 2. METHOD

The HDR-like imaging models, with the incorporation of various color space transformers, mainly including RGB,  $LCH_{CIELAB}$  and  $JCH_{CIECAM02}$ , were the main focus of this research. Three types of HDR-like moduls, known as adaptive contrast-limited histogram equalization techniques (CLAHE) were developed. Each applied a variation of the contrast limited technique, called adaptive histogram clip (AHC). These three AHCs implemented a standard (originally proposed by Stephan Saalfeld in 2010)<sup>1</sup>, a hyperbolic with cube root, and a modified hyperbolic operators respectively. Every AHC operator automatically adjusted clipping level and moderated over enhancement of background regions of images. Figure 1 provides a flow chart of each major step in computation framework of the proposed modules.

1 A tutorial on CLAHE: [http://fiji.sc/Enhance\\_Local\\_Contrast\\_\(CLAHE\)](http://fiji.sc/Enhance_Local_Contrast_(CLAHE))

Depending content of image considered, if needed, noise can be reduced while maintaining the high spatial frequency content of the image by applying a combination of CLAHE, smooth filtration and/or edge sharpening. Different color spaces are useful for a number of application domains, such as image processing and filtering. Therefore, each test image in this study was Firstly transformed via a color space converter with three choices of color space transformers to gamma-modified RGB,  $LCH_{CIELAB}$  and  $JCH_{CIECAM02}$  stacks respectively (here, sRGB was used).

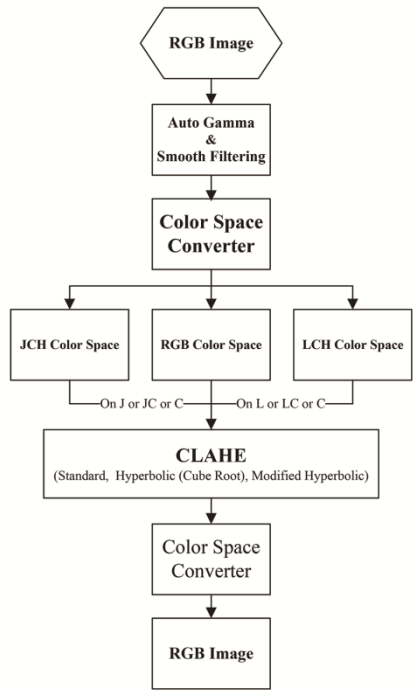

Figure 1: Flowchart illustrating the computation framework of the proposed modules.

### 2.1 CLAHE

Contrast Limited Adaptive Histogram Equalization (CLAHE) was originally developed for medical imaging and has proven to be successful for enhancement of low-contrast images (Zuiderveld 1994; Frei 1977; Hummel 1977). It was carried out to prevent the over amplification of noise in relatively homogeneous regions of an image, produced by conventional Adaptive Histogram Equalization (AHE) (Pizer *et al.* 1987). The CLAHE algorithm partitions images of interest into contextual regions and applies the histogram equalization to each one. This evens out the distribution of used grey values and thus makes hidden features of the image more visible.

Table 1. AHC used in the CLAHE algorithms.

Type	Name of Method	Equation
AHC <sub>StandardU</sub>	Standard ( <i>U</i> niform)	$g = [v - g_{\min}]P(f) + g_{\min}$
AHC <sub>HyperbolicCR</sub>	Hyperbolic ( <i>C</i> ube <i>R</i> oot)	$g = [v^{1/3} - g_{\min}^{1/3}]P(f) + g_{\min}^{1/3}]^3$
AHC <sub>HyperbolicMD</sub>	<i>MoD</i> ified Hyperbolic	$g = g_{\min} [v / g_{\min}]^{P(f)^\alpha}$

As an improved version of AHE, it differs from ordinary AHE in its contrast limiting. Three types of the contrast limited methods (i.e. AHC) adopted<sup>2</sup> are listed in Table 1. Here,  $g_{min}$  is minimum pixel value (1 in this study);  $v$ , original pixel value considered;  $g$ , computed pixel value;  $a$ , parameter (mostly  $< 1$ );  $P(f)$ , CDF (cumulative distribution function).

Every CLAHE method used in this study at least has three parameters to modulate the quality of desirable results. These three parameters are: (1) **block size**: the size of the local region around a pixel for which the histogram is equalized; (2) histogram **bins**: the number of histogram bins used for histogram equalization (a fixed value of 255 was used in this study); (3) max **slope** of the neighborhood cumulative distribution function (CDF): limits the contrast amplification in the intensity transfer function.

## 2.2 Auto Gamma-Correction Algorithm and Smooth Filtering

Previously preliminary studies showed that some dark images with relatively large homogeneous regions of dark shadow area, although were CLAHE processed using each clip-limit method considered, still presented unavoidable image noise and gave visual unpleasantness. To avoid the over ramplication on this kind of noise, a dynamic auto gamma-correction scheme (by following Formula<sup>3</sup>) without/with a smooth filtering method was adopted in the image pre-processing stage. The mean filter was carried out the noise removal if needed.

$$g = range * (v/range)^{gamma} \quad \& \quad gamma = \log(y/range)/\log(x/range)$$

Here, **range** is image pixels range (example: 65535 for 16-bit images);  $v$ , the pixel value of the image before gamma transformation; and  $g$ , the pixel value of the image after gamma transformation (the image result). The gamma value, by default, is determined according to both the mean value of pixels of the image tested (denoted as  $x$ ) and the half value of the range (denoted as  $y$ , e.g. 32767 for 16-bit image).

## 2.3 Experiments



Figure 2: (a)Original image; (b) $AHC_{StandardU}$  output (RGB space); (c) $AHC_{HyperbolicMD}$  output (LCH space). (d) $AHC_{HyperbolicMD}$  output (JCH space) (all modules applied auto gamma, but without mean filtering, using block size 15); (e) and (f) are output results of  $AHC_{HyperbolicMD}$  in LCH and JCH spaces respectively, with repeatedly fine-tuning  $a$  (0.3~0.05) for both  $L$  &  $C$  and  $J$  &  $C$  respectively (all applied auto gamma, but without mean filtering).

Figure 2 illustrates some implementation results of proposed algorithms. After a set of preliminarily experimental implementations and evaluations, the optimal bin block size of 15 was set as default to decrease the halo effect (e.g. when block size of 127 was used).

2 A tutorial on CLAHE: [http://radonc.ucsf.edu/research\\_group/jpouliot/tutorial/HU/Lesson7.htm](http://radonc.ucsf.edu/research_group/jpouliot/tutorial/HU/Lesson7.htm)

### 3. RESULTS AND DISCUSSION

In this study, the image quality concept within this context was mainly implicitly associated with the naturalness of processed HDR-like image. The results in Figure 2 show that all algorithms, implemented based on different color space, could be performed reasonably satisfactory and pleasing via an optimally careful choice or setup of parameters of interest. The  $AHC_{HyperbolicMD}$  was further used to perform transformation based on each of  $LCH_{CIELAB}$  and  $JCH_{CIECAM02}$  color spaces. The final elaborated images are shown in Figures 2(e) and 2(f). Through refining the combination of lightness/brightness plus chroma and slope/ $a$ , a good strength of detail enhancement in two dimensions of lightness/brightness and chroma could be obtained. Apparently, the  $AHC_{HyperbolicMD}$  module in corporation with  $JCH_{CIECAM02}$  color space gave the most convincing impact on HDR-like appearance rendition among all modules.

### 4. CONCLUSIONS

Three HDR-like imaging models, with the incorporation of color space transformers of RGB,  $LCH_{CIELAB}$  and  $JCH_{CIECAM02}$ , were presented in this work. In order to prevent the introduction of halo artifacts and noises, the mean filter was also adopted. The proposed modules all properly enhanced the dynamic range in both highlight and shadow regions. Moreover, every module based on either of  $LCH_{CIELAB}$  and  $JCH_{CIECAM02}$  could achieve a good contrast enhancement (at both local and global levels), while affecting colors through fine tuning of chroma in a more effective and pleasing way.

### ACKNOWLEDGEMENTS

This research has mainly supported by both of the Shih Hsin University and the National Science Council of Taiwan for financial assistance.

### REFERENCES

- Frei, W., 1977. Image Enhancement by Histogram Hyperbolization, *Computer Graphics and Image Processing* 6, 286-294.
- Hummel, R.A., 1977. Image Enhancement by Histogram Transformation. *Computer Graphics and Image Processing* 6, 184-195.
- Pizer, S.M., E.P. Amburn, J.D. Austin, et al., 1987. Adaptive Histogram Equalization and Its Variations. *Computer Vision, Graphics, and Image Processing* 39, 355-368
- Zuiderveld, K., 1994. Contrast Limited Adaptive Histogram Equalization. In: P. Heckbert: *Graphics Gems IV*, Academic Press, 474-485

*Address: Prof. Mei-Chun Lo, Dept. of Information Management, School of Management  
Shih Hsin University, No.1, Lane17, Sec. 1, Mucha Road, Taipei, 116, Taiwan  
E-mails: mcl@cc.shu.edu.tw, jllin@cc.shu.edu.tw, m100662011@mail.shu.edu.tw*

# Determination of Background Color on Color Appearance on Monitor

Lidija MANDIĆ, Maja Strgar KUREČIĆ, Ante POLJIČAK  
University of Zagreb Faculty of Graphic Arts

## ABSTRACT

The aim of this study was to determine the influence of simultaneous color contrast on color appearance in real world. Forty students took part in experiment. The task was to adjust color appearance on different backgrounds to be equal. Three conditions were predefined: experiment was conducted in dark room, the white point of monitor was set to D65 and the workspace was sRGB. Blue and green color were chosen because human perceived this colors different. The results show large discrepancies in visual judgment caused by different display characteristics. The difference in lightness appearance is visible, but it could be easily adjust. The problem was to achieve saturation, specially for blue.

## 1. INTRODUCTION

There are three things that affect the color of an object: spectral power distribution of light sources, properties of an object and eye/brain system of human observer. Object colors are often accompanied by the simultaneous perception of illumination, texture, shape and size. One of the tasks of the human visual system is to detect objects in its environment. The color appearance of a stimulus depends on many factors. There are two types of judgment in our color perception, absolute and relative and there are two models of color perception: unrelated and related (Hunt 1991b). Related colors are perceived to belong to an area seen in relation to other colors. Unrelated colors are perceived to belong to an area seen in isolations from other colors. Colors such as brown, gray olive can only exist as related colors.

The color appearance depends on viewing conditions. For accurate color imaging applications it is necessary to specify the stimuli in terms of color appearance. Hunt classified the observing field into four areas: the stimulus, the proximal field, the background and the surround. The size of the stimulus is assumed to be roughly  $2^\circ$  visual angle. Proximal field is considered to be the immediate environment extending from the stimulus for about  $2^\circ$  in all directions. The background is defined to be environment extending from the proximal field for approximately  $10^\circ$  in all directions. The surround is considered anything outside of the background. Any changes in the viewing field may quickly result in a change in the color appearance of a stimulus.

To describe the color appearance of a stimulus following color terminology is used:

- Hue (absolute): red, green, blue, yellow, etc
- Brightness (absolute): how much light
- Lightness (relative): brightness relative to white
- Colorfulness (absolute): how much hue
- Chroma (relative): colorfulness relative to the brightness of a white object similarly illuminated
- Saturation (relative): colorfulness relative to its own brightness

According to CIE Technical Committee 1-34 (TC1-34), a color appearance model is any model that includes predictors of at least the relative color appearance attributes of lightness, chroma and hue. Color appearance models minimally require some form of a chromatic adaptation transform, as well as some form of a uniform color space. Color appearance research has been ongoing for many years and has led to the creation of the CIECAM02 color appearance model (Fairchild 2005). CIECAM02 is capable of predicting all six appearance attributes, to predict changes in color appearance as a function of luminance (Hunt and Stevens effect) and surround (Moroney 2002). An sophisticated color appearance model for imaging applications is being developed to account for spatial frequency and simultaneous contrast effects (Fairchild 2003).

The human visual system enhances the difference between the size of object and its surround. Similarly, two gray squares of equal luminance appear to be quite different brightness. Gray stimulus appears darker if its surround is lighter, and lighter if its surround is darker (Albers 1963). This effect is known as simultaneous lightness contrast. Simultaneous color contrast is known as induced color. If the color is surrounded by another color, color appears to have a color shift in the direction complementary to surrounded color.

## 2. METHOD

The aim of this study was to determine the influence of the background color on the color appearance on monitor in real world. The task was to adjust color appearance of sample placed on colored background with the color appearance placed on black background. The experiment was carried out first with six observers in laboratory on professional display EIZO ColorEdge CG243W. To determine the influence of different displays forty students did adjustment on their displays. Three conditions were predefined: experiment was conducted in dark room, the white point of monitor was set to D65 and the workspace was sRGB. The size of background was 1000×1000 pixels, and the size of color sample was 500×500 pixels (see Figure 1) and  $L^*a^*b$  values of color sample and backgrounds were defined (Table 1). The green patch was placed on green and red background, and blue patch was placed on blue and yellow background.

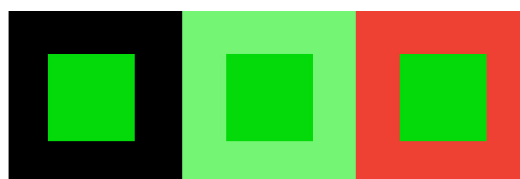

Figure 1: color sample on different backgrounds.

Table 1. The colors of samples and backgrounds.

	$L^*$	$a^*$	$b^*$
Black background	0	0	0
Green background	87	-56	50
Red background	55	66	49
Green sample	76	-70	71
Blue background	71	-13	-36
Yellow background	98	-15	87
Blue sample	32	15	-60

### 3. RESULTS AND DISCUSSION

Results are presented in Figure 2: green placed on lighter green (a), green placed on red background (b), blue placed on lighter blue background (c) and blue placed on yellow (d). Green and blue colors were chosen because the eye sensitivity varies in the green and blue spectral range. Due to simultaneous color contrast the color appears darker and less saturated. It was difficult to adjust the appearance of green placed on red background (Figure 1b), resulted in more disagreement in visual judgment. The changes in saturation were bigger compared to changes in lightness. The color appearance on display showed minor deviations between observers. The results for adjusting blue appearance point to decrease in saturation when the blue is placed on yellow background. Blue appears less saturated than green. The changes in color coordinates are presented in Figure 3.

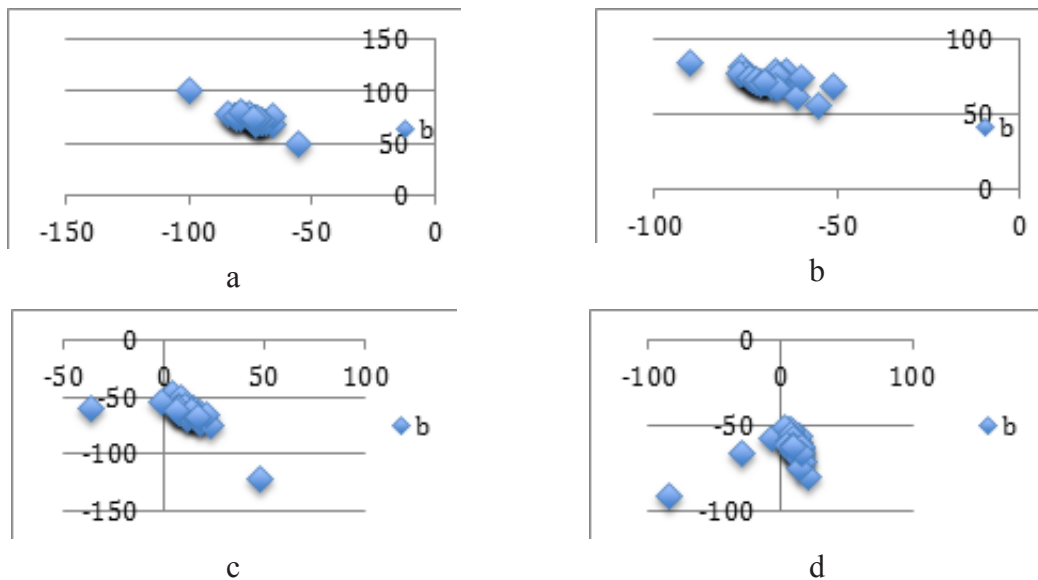

Figure 2: Results of visual judgements for green (a,b) and blue (c,d).

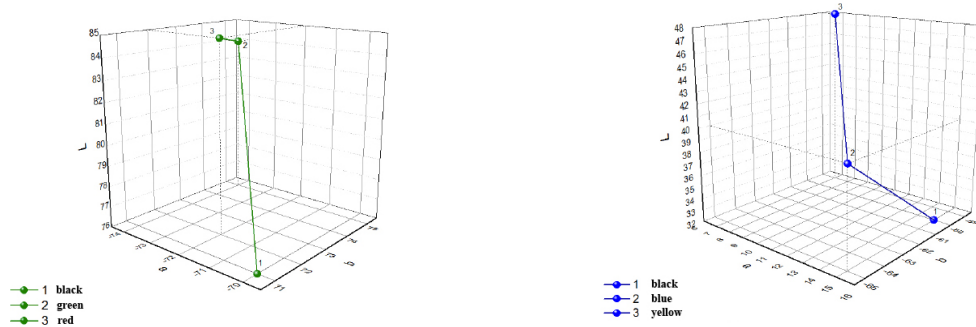

Figure 3: Display coordinates for color appearance on different backgrounds.

### 4. CONCLUSIONS

An object's background can strongly influence an object's perceived hue, saturation and/or brightness. Hue and saturation effects on a computer screen are relatively weak because it is impossible to create highly saturated backgrounds. The aim of research was to determine the influence of display characteristics on color appearance. Although three conditions were pre-defined: dark room, white point of monitor and working space, there was large divergence in visual judgments. There was the problem to achieve saturation for blue color.

## ACKNOWLEDGEMENTS

This research was conducted under the scientific project (128-1281957-1958), supported by the Ministry of Science, Education and Sports of the Republic of Croatia.

## REFERENCES

- Albers, J., 1963. *Interaction of color*, Yale University.
- Fairchild, M.D., and G.M. Johnson, 2003. Image appearance modelling, *Proceedings of SPIE*, 149-160.
- Fairchild, M.D., 2005. *Color appearance models*, Second edition.
- Hunt, R.W.G., 1991b. Revised colour-appearance model for related and unrelated colors, *Color Res. Appl.* 16 146-165.
- Moroney, J., M.D. Fairchild, R.W.G. Hunt, C.J. Li, M.R. Luo and T. Newman, 2002, The CIECAM02 color appearance model, *Proc. of the IS&T/SID 10th Color Imaging Conference* 23-27.

*Address: Prof. Lidija Mandić,  
University of Zagreb Faculty of Graphic Arts, Getaldiceva 2, Zagreb, HR  
E-mails: lidija.mandic@grf.hr, mstrgar@grf.hr,  
ante.poljicak@grf.hr*



# Study on Image Filtering using Visual CSF Model of LCH Color Space

Yang JIN,<sup>1</sup> Yujie OUYANG,<sup>1</sup> Zhen LIU<sup>2</sup>

<sup>1</sup> Beijing Institute of Graphic Communication, Beijing, 102600, China

<sup>2</sup> Nanjing Forestry University, Nanjing, 210037, China

## ABSTRACT

As description of visual frequency response, CSF (Contrast Sensitivity Function) shows the relationship between spatial frequency of image and its visual sensitivity.

Under LCH (Lightness/Chroma/Hue) color space, which stems from CIE 1976 L\*a\*b\* color system with uniformed scale, LCH-CSF are tested under a by OSA Modelfest recommended conditions. 24 groups of LCH-CSF data are obtained. Based on the test data, LCH-CSF model is constructed.

An image filtering and data-reduction processing flow is founded and realized, wherein the generation of the filters is based on the LCH-CSF model. Images in LAB model are transformed to LCH color space and then into spectral domain. The spectral data are filtered with the LCH-CSF filter. After a threshold processing, many filtered spectral data can be set to zero and can be reduced. The filtered data are then reverse transformed back to spatial LCH and finally to LAB image. The color error between the original and CSF filtered images are computed and evaluated.

## 1. INTRODUCTION

CSF gives a relationship between Contrast Sensitivity (CS) and spatial frequency. The definition of CS is the reciprocal of visual just-noticeable contrast  $C_{JN}$ :

$$\mathcal{C} = 1/C_{JN} \quad (1)$$

The contrast  $C$  is defined as ratio of two items as follows (Eq.2):

$$C = (V_{Max} - V_{Min}) / (V_{Max} + V_{Min}) \quad (2)$$

Since 1950's, monochromatic and chromatic CSF were tested and the models were constructed. The most applied color CSF model are based on  $Y C_b C_r$  color space, which is transformed from device dependent color space RGB mostly. In the tendence of cross-media color image communication, it's necessary to obtain the CSF in a device independent color space, e.g. CIE1976L\*a\*b\*(CIELAB).

In our CSF research, the color space LCH, which based on CIELAB, is selected. As Eq.2, contrast of lightness ( $C_L$ ) and of chroma ( $C_{CH}$ ) are defined accordingly. For the contrast of hue angle ( $C_H$ ), the definition is slightly different (Eq.3), in order to prevent the same difference of hue leads to different  $C_H$ :

$$C_H = (H_E - H_S) / (H_E + H_S) \quad (3)$$

wherein  $H_S$  and  $H_E$  are the starting and the end hue angle, two limitation hue angles  $H_{LE}$  and  $H_{LS}$  determine a range of hue angle.

## 2. METHOD

To obtain the CSF in LCH space, visual tests were carried out. The CSF data were analysed and the LCH-CSF model is constructed and applied to generation of color image filters.

### 2.1 Visual test for LCH-CSF

For the tests, some image series, each of which with a group of color image (48bits TIFF-LAB), are generated by a C program. Every image in a series is embedded with color wave. One of the 3 components L/C/H is sinusoidal, the other are fixed. In one image series, the spatial frequency of the wave is fixed, but the contrast of the color wave are different.

Under the viewing condition, which accords with OSA Modelfest/SSO (NASA Vision Group 1999), color images are orderly displayed on a calibrated and characterized 19 inch CRT monitor. Every observer views the displayed image and gives a judgment, whether the color nuance of waves can be distinguished or not. The images in a series are observed both in contrast increasing and contrast decreasing order.

The basic level of lightness and chroma are set to  $L=50$  ( $32.1 \text{ cd/m}^2$ ) and  $CH=50$ . Under view angle of 2.1 degree and the spatial frequency range of 0.4~20 CPD (Circle Per Degree), 24 groups of CSF are tested, i.e.:  $CSF_L$  and  $CSF_{CH}$  are both under 6 hue angle centers ( $30/90/150/210/270/330^\circ$ ),  $CSF_H$  under 12 hue angle centers ( $15/45/75/105/135/165/195/225/255/285/315/345^\circ$ ). 15 visual observers participated in the test.

### 2.2 Test results of LCH-CSFw

The obtained test result of  $CSF_L/CSF_{CH}/CSF_H$  are showed in Figure 1.

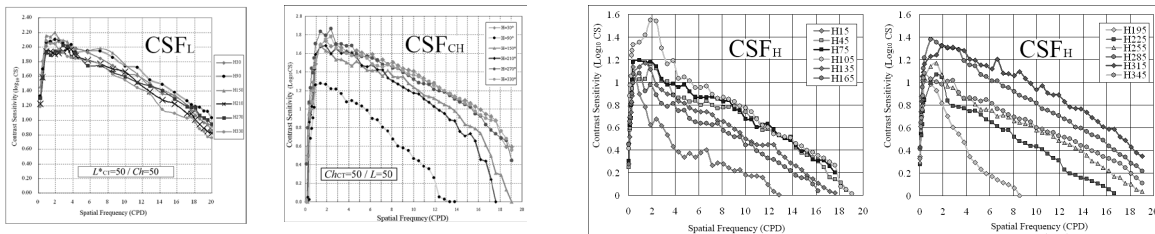

*Figure 1: CSF of Lightness/Chroma/Hue.*

The test results show following characteristics:

The levels of  $CSF_L$  are higher than  $CSF_{CH}$  and  $CSF_H$ . The difference among  $CSF_L$  under different hue centers is not obvious, but the difference among  $CSF_{CH}$  and the difference among  $CSF_H$  under different hue centers are evident.  $CSF_{CH}$  under  $90^\circ$  hue center (Yellow) and  $CSF_H$  under  $195^\circ/15^\circ$  hue center (Cyan/Red) are with much lower levels. CSF with higher levels have generally wider range of frequency. These differences are close associated with the visual color distinguishing tolerances (Lü W.G. 2011/Wang Z.H.2009).

Based on the test data, a normalized mathematical CSF model is constructed as Eq.4:

$$\sigma_{\text{NORM}} = (\sigma_{\text{MAX}}^{-1}) \times \{k_1 \times [\exp(a \cdot f) - \exp(b \cdot f)] + k_2 [1 - \exp(c \cdot f)]\} \quad (4)$$

wherein  $f$  is spatial frequency,  $CS_{\text{NORM}}$  is normalized contrast sensitivity and  $CS_{\text{MAX}}$  is the maximum value of CS. Using curve-fitting method, 19 functional curves of LCH-CSF are obtained, wherein average value of 6 groups of CSFL data is applied.

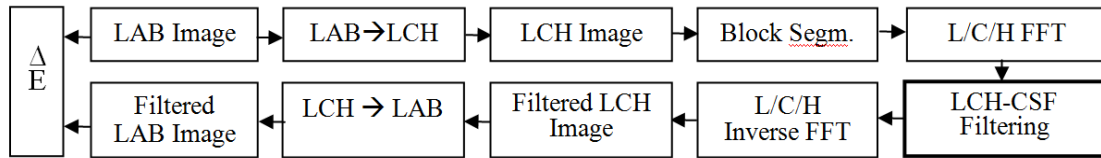

Figure 2: Flow of LCH visual filtering.

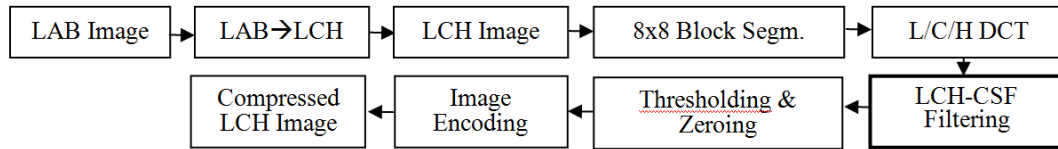

Figure 3: Flow of LCH image data reduction.

### 2.3 Flow of LCH visual filtering for color image processing

A processing flow for the visual filtering of color image is as Figure 2. Beginning with LAB image, after color transformation, the L/C/H component images are obtained. According to view distance, image size and resolution, the component images are segmented into blocks and transformed into spectral domain. Then the L/C/H blocks can be filtered with LCH-CSF filter, inverse transformed into spatial domain, finally back into LAB space.

The LCH-CSF model can also be applied in a flow of image data reduction as Figure 3. Similar to JPEG processing, LCH image can be segmented into 8x8 blocks and are transformed through DCT into spectral domain. The L/C/H blocks are filtered with LCH-CSF filter. The filtered data can be set to zero, if they are smaller than a threshold. Then the data can be encoded and saved.

## 3. RESULTS AND DISCUSSION

Six color images with different dominant hue are filtered with LCH-CSF filters under MATLAB platform. The color errors are listed in Table 1. The image resolution is 300 dpi, their size are  $6.77 \times 5.08$  cm and every segmented block is with  $100 \times 100$  pixels.

Table 1. Color error between orianal and CSF filtered images.

Dominant Hue of image→	Yellow	Blue	Green	Magenta	Red	Orange
Average color error ( $\Delta E$ )	27.50	4.07	11.66	11.78	10.53	6.91

The visual LCH-CSF-filteing leads to stronger or weaker loss of color details in image. The DE of “yellow-toned” image is stronger, because the  $CSF_{CH}$  of yellow is much lower.

Under differnt view distance, image size and resolutions, the block pixels and filters must be adapted, and the visual appearance of filtered image is also different: the color details are sharpen or blur accordingly.

The six images are also processed according the flow of Figure 3 (Without encoding). With different threshold values (0.0/0.5/1.0/5.0/10.0/50.0), the rate of zeroed spectral data increases, but the color error increases very slow, if the zeo-rate is less than 90% (for “yellow-toned” image less than 70%). Under similiar zero-rate, the color error of LCH-CSF filtering images are a little stronger than JPEG images or similiar (S. Table 2), but the visual appearance are closed.

Table 2. Compare of color error between LCH-CSF and JPEG processed images.

Method	Domin. Hue→	Yellow	Blue	Green	Magenta	Red	Orange
LCH-CSF	Zero rate (%)	78.39	95.9	92.84	89.74	92.65	93.41
	<b>Average DE</b>	<u>16.46</u>	<u>2.49</u>	<u>11.86</u>	<u>10.12</u>	<u>5.71</u>	<u>3.59</u>
JPEG	Zero rate (%)	82.68	96.54	89.93	89.65	92.05	95.02
	<b>Average DE</b>	<u>9.95</u>	<u>2.47</u>	<u>4.66</u>	<u>4.57</u>	<u>4.02</u>	<u>2.87</u>

#### 4. CONCLUSIONS

Based on LCH color space, visual tests are performed and LCH-CSF are obtained under middle level of lightness/chroma and multiple hue centers. The mathematical models of LCH-CSF are constructed. LCH-CSF filtering flows for image processing and compression are also constructed. According to the flows, color images are processed. The results shows, that the LCH-CSF filtering can simulate the visual appearance of image under different view distance, image size and resolution. For the image data reduction, under similar zero-rate of data, the image quality of LCH-CSF filtering can be similar to JPEG method.

#### REFERENCES

- NASA Vision Group 1999. Modelfest Methods. Available online, <http://vision.arc.nasa.gov/Modelfest/methods.html>.
- Lü, W.G., H.S. Xu and Z.H. Wang, 2011. Investigation of chromatic contrast sensitivity based on different color directions and spatial frequencies. *Acta Optica Sinica* 31(1) 0133002-1~0133002-6.
- Wang, Z.H., H.S. Xu, 2009. Evaluation of color difference formulae based on the correlation between visual tolerances and hue angles. *Acta Optica Sinica* 29(7) 1838~ 1841.

*Address: Prof. Yang JIN, School of Printing and Packaging Engineering,  
Beijing Institute of Graphic Communication, Beijing 102600, China,  
E-mail: jinyang@bigc.edu.cn.*

# ICC Color Management from Digital Still Cameras to Displays based on Self-made Color Chart

Xiandou ZHANG,<sup>1</sup> Qiang WANG,<sup>1</sup> Xiongzong ZHENG,<sup>1</sup>  
Tingting ZHANG,<sup>1</sup> Haisong XU<sup>2</sup>

<sup>1</sup> School of media & design, Hangzhou Dianzi University, Hangzhou 310018, China

<sup>2</sup> State Key Laboratory of Modern Optical Instrumentation,  
Zhejiang University, Hangzhou 310027, China

## ABSTRACT

In order to improve the color consistency between the object captured by digital cameras and the corresponding image displayed on computer screens, the ECI color chart was designed and printed based on the ECI data set, and the corresponding colorimetric data file was designed according to the ISO 12640 standard. Then two ICC profiles were generated based on the self-made and Color Checker SG color chart. An experiment was designed to implement the color management from camera to display based on the generated ICC profiles. The visual experiment results indicated that the displayed images were most similar to the original object with the ICC profile generated by the self-made color chart comparing to the ICC generated by Color Checker SG color chart and the default sRGB ICC.

## 1. INTRODUCTION

Various digital color image devices have been extensively used in daily life and work. However, when people enjoy the conveniences brought by digital image devices, they are also troubled by the different color appearances between the reproduction and original images (Morovič 2008). The ICC (International Color Consortium) color management system have been developed to relieve the color disagree problems in the image reproduction (Zeng and Nielson 2002). The ICC profile, which represents the mapping relationship between the device color space and CIE colorimetric space, is the key element for the high fidelity color image reproduction. For the application of objects firstly captured by digital still camera then displayed on the computer screen, the ICC profile of display could be accurately generated with a little color patches through the simple Matrix/TRC model (Chen et al. 2008) as most of the displays are stable and satisfy the channel independence and additivity (Roy et al. 1993). While for cameras, the accuracy of generated ICC profile is influenced by many factors (Guo et al. 2001), such as the illuminating and capturing environment, various parameter settings of the camera and the media of color chart adopted to generate the ICC profile. In this study, the environment and parameter settings of the camera were strictly controlled, and then a color chart was made for the printed image reproduction. Two ICC profiles of the camera were generated based on the self-made and CCSG color chart. Finally the image reproduction from camera to display was implemented and evaluated based on different camera ICC profiles.

## 2. CAPTURING ENVIRONMENT AND PARAMETER SETTINGS

External light sources are usually needed to capture images, so the stability and illuminating evenness of the light source would greatly affect the color appearance of the captured image. Furthermore, the appearance of the captured image is also affected by various parameter

settings of the camera. So before the color management of the camera, a stable and evenly illuminating environment and reasonable parameter settings of the camera should be firstly set up.

The light box might be an ideal capturing environment as it usually provides stable and different light sources. A pre-flight experiment was implemented to verify the suitability of the light box used for the image capturing. Firstly, the 45°/0° **illuminating and capturing** environment was set up in the light box, where the GretagMacbeth Color Checker SG (CCSG) color chart was put in the center of the light box with 45° to the bottom of the light box, and the images were captured in the normal direction of the color chart. The results of the captured images showed that the RGB values of the white, gray and black patches at the top of the color chart were about 20 higher than that of the corresponding patches at the bottom, which indicated that the illumination in the light box was uneven and might be not good illuminating environment for image capturing. The daylight of the north window at two o'clock in the afternoon was selected as the illuminating environment eventually as the illumination is very even, and the 45°/0° illuminating and capturing environment was set up in this condition.

The objective of the camera parameter setting is to get no color cast, clear and high dynamic images. So firstly the focal length of the camera and the distance between the camera and capturing object were adjusted to get clear images. Secondly, the white balance was manually set by capturing the GretagMacbeth white color chart to get no color cast images. Thirdly, the aperture size, shutter speed and ISO values were simultaneously adjusted to get moderate exposure image with high dynamic range. The RGB values of the black and white patch in the captured CCSG image are about 20 and 240 respectively under the previous environment and parameter settings.

### 3. ICC PRIFILES GENERATION

The accuracy of ICC profiles is the key element for the color management. The ProfileMaker pro 5.0.2 software (Zhu et al. 2011) was adopted to generate the ICC profiles of display and camera in this study. Firstly, the EIZO CG211 display was calibrated with the X-rite eye-one pro spectrophotometer according to the software workflow, and the ICC profile of the display was simultaneously generated and applied to the display. Secondly, the capturing environment and parameter settings of the camera were set up according to the previous procedure, then the CCSG color chart was captured and the captured image was imported to ProfileMaker, followed by the generation of the ICC profile based on the CCSG color chart.

The number of patches in CCSG color chart is small, so the accuracy of the generated ICC profile based on CCSG color chart might be not high. In addition, the ICC profile based on CCSG color chart might be not suit for the reproduction of other object as the accuracy of the ICC profile is usually media dependent. To investigate these considerations, another color chart based on ECI CMYK data set was designed and generated. Firstly the digital image was generated based on the data set, then printed through the widely used EPSON 7910 printer. Secondly, the images of the printed ECI color chart were captured under the same environment and parameter setting as that of the CCSG color chart. As the ProfileMaker software could not generate ICC profiles based on color charts without contained in its image database, the captured ECI image was loaded into the database and the corresponding colorimetric data were measured and saved according to the ISO 12640 guidelines (ISO 12640:3. 2007). In this way, the software could recognize the ECI image, after that the ICC profile could be easily generated based on the ECI color chart.

#### 4. COLOR MANAGEMENT AND EVALUATION

Four typical printed images (Figure 1) were adopted to verify the image reproduction accuracy from camera to display. The four images were firstly printed by the EPSON 7910 printer, and then captured by the camera under the same illuminating environment and parameter setting as CCSG and ECI color chart. As the sRGB ICC profile (IEC 61966:2-1. 1998) was widely used in practice, the sRGB and the two generated ICC profiles based on CCSG and ECI color chart were adopted to evaluate the image reproduction accuracy.



Figure. 1 Four printed images for evaluation.

The three ICC profiles were embedded into the four captured images respectively, then there would be three digital images embedded with ICC profile for each printed image. Each printed image was put in the original illuminating environment, and the captured image embedded with different ICC profiles was subsequently displayed on the profiled LCD. Seven observers were asked to evaluate the color consistency between the printed and displayed images. The following is the scoring criteria (Table 1).

Table 1. Scoring criteria of color consistency between printed and displayed image.

Scoring criteria	Score
No color cast, clear tone, identical	4
Small color cast, clear tone, almost identical, acceptable	3
Color cast, less clear tone, barely acceptable	2
Large Color cast, less vague tone, unacceptable	1
Completely color cast, vague tone, totally unacceptable	0

The statistical score results are shown in Table 2. Firstly, it illustrates that the reproduction accuracy of image 1 and 3 with ICC profile based on CCSG color chart is higher than that of the sRGB ICC profile, while for image 2 and 4, the results were reversed. The results indicated that the ICC profile based on CCSG didn't have much advantage comparing to the sRGB ICC profile, while it is more complex and time-consuming. The main reason might be that the capturing environment and the parameter setting of the camera in this study maybe close to the sRGB standard, then the advantage of the color management based on CCSG color chart was not work out.

Table.2 the reproduction accuracy of the four images based on the three ICC profiles.

	Image 1		Image 2		Image 3		Image 4	
	Average	Max.	Average	Max.	Average	Max.	Average	Max.
sRGB	2.36	2.80	2.63	3.00	2.39	3.20	2.79	3.50
CCSG	2.69	3.00	2.54	3.00	2.84	3.10	2.43	2.80
ECI	3.27	3.50	3.26	3.50	3.30	3.60	3.11	3.50

Secondly, the reproduction accuracy based on ECI color chart is highest among the three ICC profiles for all the images. In the evaluating process, observers generally reflect that the color consistency, contrast and clarity of the image embedded with ICC profile based on

ECI color chart were significantly higher than that embedded with the other two ICC files, especially in the green-blue color regions. The main reason is that the media of the ECI color chart is same as the four printed images, then there would be no media metamerism problems (Guo et al. 2001) in the color management based on ECI color chart. In addition, the number of patches in ECI color chart is larger than that of the CCSG color chart, which may improve the interpolation accuracy from RGB to colorimetric values. The reason for the color cast in the green-blue color region of the images embedded with sRGB and CCSG ICC profile is that the hue angle of the green-blue region in CIELAB color space is uneven, which easily incur color cast in this color region, while for the image reproduction based on the ECI color chart, there are more color patches distributed in the green-blue color region, which may make up the unevenness in the green-blue color region.

## 5. CONCLUSIONS

Stable and evenly illuminating environment construction, reasonable parameter settings and high accuracy ICC profile generation are the key elements for the camera color management. It would be better to design and generate color charts with the same media as the objects to reproduction for the ICC profile generation. In this way, it could obtain high image reproduction accuracy even for ordinary cameras.

## ACKNOWLEDGEMENTS

The authors acknowledge the support of the National Science and Technology Support Program (grant 2012BAH91F03) and National Natural Science Foundation of China (grant 61205168).

## REFERENCES

- Morovič, J., 2008. *Color gamut mapping*. Chichester, England: John Wiley & Sons: 1-5.
- Zeng, H.Z., M. Nielson, 2002. Color transformation accuracy and efficiency in ICC color management. In *IS&T/SID Ninth Color Imaging Conference*, 224-232.
- Chen, L.Y., H.S. Xu, and X.D. Zhang, 2008. Study on color management of color displays based on ICC specification. *Journal of Optoelectronics·Laser* 19 (3):322-325.
- Berns, R.S., R.J. Motta, and M.E. Gorzynski, 1993. CRT colorimetry: Part I: Theory and practice. *Color Research and Application* 18(5): 299-314.
- Hong, G., M.R. Luo, and P. Rhodes, 2001. A study of digital camera colorimetric characterization based on polynomial modeling. *Color Research and Application* 26 (1): 76-84.
- Zhu, M., Z. Liu, and G.X. Chen, 2011. Research on Six-Color Separation Model Based on Subarea Neugebauer Equations. *ACTA OPTICA SINICA* 31 (7): 0733001-1-0733001-10.
- ISO 12640-3, 2007. *Graphic technology. Prepress digital data exchange. CIELAB standard colour image data (CIELAB/SCID)*.
- IEC 61966-2-1, 1998. *Colour measurement and management in multimedia systems and equipment, Part2.1: Default RGB colour space-sRGB*.

Address: Dr. Xiandouzhang, School of media & design,  
Hangzhou Dianzi University, Xiasha, Hangzhou, China 310018  
E-mails:xiandouzhang@126.com, profwq@263.net,  
tjytingting@hotmail.com,hellozxz@126.com, chsxu@zju.edu.cn



# Creating Colour Compositions that Allow Calculating the CIELAB Values of Each Component Colour from Pictures Taken with a Digital Camera

Teesit VARAPASKUL,<sup>1</sup> Pichayada KATEMAKE,<sup>1</sup> Razvan Ion PREDA<sup>2</sup>

<sup>1</sup> Faculty of Science, Chulalongkorn University

<sup>2</sup> National Research Council of Thailand

## ABSTRACT

Most digital cameras use Charge-Coupled Device or Complementary Metal Oxide Semiconductor sensors and a red-green-blue colour filter array. The colour signal that enters the sensor is controlled through the aperture, exposure time and International Organization for Standardization sensitivity value, then is handled by colour processing algorithms and stored as a colour number in the camera's memory. Obtaining colorimetric data from this colour number means to reverse the camera's process of producing it from the colour signal that entered initially the sensor. There are several factors that make this difficult: 1) factors related to camera settings, 2) environmental factors including, but not limited to, the angle of incident light on a colour object, type of light source, distance and angle of the camera towards the colour object 3) factors related to the camera processing algorithms which are usually proprietary and 4) factors related to brightness fall on the image frame. In this paper we show that CIELAB values of colours can be calculated from digital pictures with a colour difference less than  $5 \Delta E_{00}$  units towards the spectrophotometric measurements of the corresponding colours in the real scene, if the scene contains specific colours and the picture is taken under determined conditions.

## 1. INTRODUCTION

The experiments described in this paper are part of the research conducted within a Ph.D. thesis that aims to demonstrate the possibility of replacing the spectroradiometer with a cost effective digital camera in the process of light quality assessments. Herewithin we refer to digital cameras generically as to commercially available, non-colorimetric, unaltered digital cameras used in our study for taking pictures in controlled environment without supplemental filters or any external enhancements. Comparisons of our results with other published results should be restricted only to those that were obtained with digital cameras that comply with the generic term we are referring to. Literature shows that digital cameras can be used as tristimulus colorimeter to some extent (Hong, Luo and Rhode 2001; Attridge, Pointer and Jacobson 2001) and camera response is better for some colours than for others (Cheung and Westland 2006).

In this paper we show an experimental setup and an algorithm for selecting colours that can be included in colour scenes under different light sources so that CIELAB values, close to spectrophotometric measured values of the selected colours, can be extracted from their pictures taken with digital cameras. The target for the maximum colour difference between calculated and measured CIELAB values is of  $5 \Delta E_{00}$  units and for the average colour difference is of  $3 \Delta E_{00}$  units, for all values considering D65/2° throughout the article.

## 2. METHOD

We built 2 boxes from light materials painted matte black, with light source holders. The ceilings have an adjustable mechanism for fixing the height so that light intensity at the bottom of the box can have a value in the range of 600-650 lx on a determined surface. The selected light sources are 2 commercially available light sources: 1.Philips Ambience fluorescent D65 Tornado, 13 watts, E27/ES 650 lumen; 2.Osram Parathom classic LED A40 cool white, 8 watts, E27/ES 450 lumen. Each light source is placed in a box. Light sources are not connected directly to a plug but through a stabilizer, in order to avoid intensity variations during the experiment.

For this experiment we chose the following digital cameras: 1.Canon EOS X4, with CMOS sensor; 2.Nikon D40x, with CCD sensor. The 2 digital cameras have different type of architecture with different type of sensors and are produced by different manufactures. We selected the cameras to be very different from each other in order to test if our experiment can be reproduced on wider range of cameras, not just on one particular type. In theory, CMOS and CCD technologies should confer system linearity to the considered digital cameras. In practice, this linearity is limited. In our experiment we use an algorithm built on the assumption that the causes which produce the system's non linearity generate acceptably small errors for some digitized colours when particular constrained conditions are applied for taking pictures, so that the system's behavior can be considered linear for a variable but determined number of colours. We also assume that the RGB data of the obtained digital image are the result of an encoding process that fits best an inverse power function. Another assumption is that by cropping part of the digital image close to its center, brightness fall in the picture frame can be neglected. Pictures are taken with 135 mm lens, minimum aperture and flashlight off, leaving all other settings in automatic mode due to the multitude of onboard image processings that are based on proprietary algorithms which are difficult to study.

For creating the colour composition we used matte Munsell sheets from the 1300 Munsell color sheets, which we fixed in form of a wheel at the bottom of each box. Boxes and cameras were placed in a totally dark room.

Step 1: Verifying the fall of light intensity across the colour scene. We assembled a colour wheel with 6 neutral matte Munsell sheets (N2, N3.5, N5, N6.5, N8, N9.5) and with 15 test colours used by the Colour Quality Scale that was developed by the National Institute of Standards and Technology (NIST): 7.5P4/10, 10PB4/10, 5PB4/12, 7.5B5/10, 10BG6/8, 2.5BG6/10, 2.5G6/12, 7.5GY7/10, 2.5GY8/10, 5Y8.5/12, 10YR7/12, 5YR7/12, 10R6/12, 5R4/14, 7.5RP4/12. We placed N9.5 Munsell sheet in the center of the wheel exactly under the light source at the bottom of the 1<sup>st</sup> box. The ceiling was moved through the adjustable mechanism till the intensity of light over the N9.5 patch reached 630 lx, measured with a luxmeter. By slightly moving the luxmeter in each direction away from the center, we observed a drop of 20 lx at the distance of 12 cm from the center. We determined an area around the center of the wheel in the shape of a circle with a 12 cm radius from which the device dependent RGB data had to be collected once the pictures were taken. Light intensity on this area was between 600-650 lx according to the preliminary condition.

Step 2: Positioning the digital camera for taking the pictures. For this step we reduced the wheel to the 6 neutral Munsell matte sheets mentioned in step 1. The spectrophotometric curves measured for these neutral sheets have similar shape and all of them flatten above 430 nm. For each curve, we calculated an average value of the reflections measured above 430 nm. Assuming system linearity, the calculated average value for each neutral Munsell sheet is directly proportional to the output signal of the camera before the encoding process

takes place. Considering the encoding process as best fitting an inverse power function, our assumptions lead to the conclusion that each of the RGB triplet of the digital images, plotted separately against the averaged reflections for all 6 greys, should be closely distributed around an inverse power function. We took several pictures of the wheel from different distances and under various angles and read the RGB values, close to the picture's center. The 8 bit RGB triplets extracted from each grey in a picture were normalized from [0,255] interval to [0,1] then were grouped accordingly to their corresponding colour channel and plotted against the averaged values of the reflections measured above 430 nm. Based on the lowest standard deviation of error estimation and on the highest correlation coefficient obtained for the calculated best fit functions, we selected one picture from the set and used the same distance for positioning the camera throughout the experiment. The distance was fixed at 1 meter with a shooting angle of 45 degrees.

Step 3: Taking the pictures and optimizing the colour composition. The pictures were taken with the Canon digital camera and after that with the Nikon D40x as follows. We started with the first box in which we placed the Philips Ambience fluorescent light source and the colour wheel as described in step 1. In case of the Canon camera, we connected the device to computer using the Digital Photo Professional software specially developed by the manufacturer for this series of cameras. Using this software we are able to read the RGB values of the RAW file from the computer screen immediately after taking the picture. In case of the Nikon D40x, we connected the camera to computer through Camera Control Pro2 software. We wrote our own software, considering the mentioned premises, for calculating CIELAB values from the RGB values. The algorithm is based on the linearity assumption that some researchers suggested to be more appropriate in obtaining CIELAB data from device dependent RGB data (Berns 2000). The program recalculates the CIELAB values of all colours in a new scene using the variable RGB data of the neutrals that are constantly present in all colour scenes. The algorithm for obtaining the CIELAB values from the device dependent RGB values can be accessed at: <http://www.trichromaticity.com/digicam.html>. After taking the first picture and calculating the CIELAB values, we compared these values with the spectrophotometric measurements of the colours used in the wheel. Wherever the colour differences were greater than 5 DE00 units, we replaced the colours, keeping in mind that the colours of this wheel must cover all hue angles in order to offer meaningful colorimetric data for the light quality assessment methods. After each replacement, we took a new picture, read the RGB data of each colour in close proximity to the wheel's center (see step 1), recalculated the CIELAB values and the colour differences towards the spectrophotometric measurements. Colour compositions were changed this way till the colour differences dropped under 5 DE00 units for all colours extracted from the scene. Overall improvement of CIELAB accuracy following colour composition changes is shown in Table 1. Some scenes were skipped and improvement is shown only over 15 scenes out of 21 due to space limitation.

Step 4. Optimizing colour compositions across light sources. The colour wheel that resulted in step 3 was used for taking pictures in the second box under the Osram LED light source. We followed the same procedure as in step 3. However, after changing the colour composition of a scene, if the data was improving compared to the previous scene, we were also checking if the colour differences were staying under 5  $\Delta E_{00}$  units in the conditions described at step 3 by taking a picture in box 1 under the fluorescent light source.

The method was repeated for 2 other light sources: 1) Osram Classic A Incandescent, 60 watts, E27/ES 710 lumen and 2) Osram Parathom Pro LED warm white, 12 watts, E27 810 lumen, 2700 K, that replaced the previous pair in the two designed boxes.

### 3. RESULTS AND DISCUSSION

Due to space limitation we show only how overall colorimetric results improved for pictures taken with the Canon camera under the D65 fluorescent light source when optimizing the colour composition under this light source. We observed that, by replacing a Munsell sheet, which gives high colour difference between measured and calculated CIELAB values, with a sheet of the same hue but lower chroma and/or higher brightness, the colour difference is decreasing in the new scene. However, we did not seek the best results by selecting indiscriminatory only very bright low-chroma colours because the purpose of the assembled colour wheel is to serve in light source quality assessments, in which more saturated colours are needed for LED light source types. Full data tables of all colours contained in scenes shown in Table 1 can be downloaded from the same internet location that was mentioned before (see step 3). After scene 6 we increased the number of colours in the wheel.

Table 1. Overall improvement of CIELAB accuracy following colour composition changes.

	Wheel	scene 1	scene 3	scene 4	scene 6	Wheel	scene 15
Mean $\Delta E_{00}$	6 neutrals + 15 Munsell colours	4.82	4.18	3.71	3.19	6 neutrals + 24 Munsell colours	3.18
Max		11.01	8.83	6.87	4.79		4.51
Min		1.03	1.25	1.23	1.16		0.70
STD		2.81	2.37	1.75	1.09		0.91

### 4. CONCLUSIONS

We described in this paper a way to obtain CIELAB data from digital pictures at a difference lower than 5  $\Delta E_{00}$  units toward the spectrophotometric measured data. Better results were obtained with the Nikon D40x camera, equipped with CCD sensor than with the Canon camera. Once optimized for the fluorescent and LED cool white, same colour wheel could be used with good results under incandescent and LED warm white light. The optimization process across the last 2 light sources improved results under the first two when re-measuring.

### REFERENCES

- Hong, G., M.R. Luo and P.A. Rhodes. 2001. *A study of digital camera colorimetric characterization based on polynomial modelling*. Color Res. Appl. 26(1): 76-84.
- Attridge, G.G., M.R. Pointer and R.E. Jacobson. 2001. *Practical camera characterization for colour measurement*. Imaging Sci. J. 49(2): 63-80.
- Cheung, V. and S. Westland. 2006. *Methods for optimal color selection*. J Imaging Science and Technology. 50(5): 481-488.
- Berns, R.S. 2000. *Billmeyer and Saltzman's Principles of Color Technology*, Wiley, NY.

*Address: Teesit Varapaskul  
E-mails: teesit@hotmail.com, pichayada.k@chula.ac.th*

# Evaluation of Unique Hue Predictions in CIECAM02 using NCS Unique Hue Data

Kaida XIAO,<sup>1</sup> Michael POINTER,<sup>2</sup> Guihua CUI,<sup>3</sup>  
Tushar CHAUHAN,<sup>1</sup> Sophie WUERGER<sup>1</sup>

<sup>1</sup> Department of Psychological Sciences, University of Liverpool

<sup>2</sup> School of Design, University of Leeds

<sup>3</sup> School of Physics & Electronic Information Engineering, Wenzhou University

## ABSTRACT

In this study, unique hue predictions in CIECAM02 were evaluated using NCS unique hue data. The colour appearance of 108 NCS unique hue stimuli was predicted using CIECAM02. All four unique hue loci were represented by a linear function and fitted using two-way least squares analysis in the CIECAM02 uniform colour appearance space. Comparison of these predicted unique hue loci with the default unique hue loci in CIECAM02 revealed large discrepancies in both unique yellow and unique blue. The same tendency was found in hue uniformity evaluation, where the performance for unique yellow and unique blue was not as good as that for unique red and unique green.

## 1. INTRODUCTION

Interest in colour appearance models has recently grown, driven by the increased need for cross-media colour reproduction. The CIE Technical Committee TC8-01 recommended the use of the CIECAM02 colour appearance model for colour management (CIE 2004).

Unique hues were originally defined by Hering as the hues of four fundamental chromatic percepts regardless of saturation and lightness (Hering 1964) and have been adopted in modern colour appearance models since the Hunt 1982 Appearance Model (Hunt 1982). Their location in a uniform colour appearance space was predicted from human cone responses and adopted as the reference for chroma and hue predictions. The position of the unique hues in the Hunt 1982 Model was based on the data provided by the Swedish Natural Color System (Hård 1996) which is itself based on a large body of visual appearance data assessed using physical colour samples.

While the assumptions relating to the cone responses have been recently updated, the prediction of the unique hues from human cone responses and subsequent hue values, based on the position of unique hues has not been changed for more than 30 years. Furthermore, CAM02UCS (Luo *et al.* 2006), modification from CIECAM02, has been widely used as a uniform colour space, in which a good hue uniformity is always assumed.

The aim of this study is to revisit the original NCS unique hue data and to evaluate the performance of the unique hue predictions in CIECAM02. Unique hue loci were identified in a CIECAM02 uniform colour space. Based on this, the unique hue predictions and hue uniformity were evaluated.

## 2. MATERIAL AND METHODS

### 2.1 NCS Unique Hue Data

The Swedish Natural Color System (NCS) was developed based on the opponent colours theory of Hering. Unique hue settings were obtained with painted colour samples in a viewing cabinet fitted with lamps that simulated a phase of daylight. Based on these experimental results, the NCS colour atlas was developed and 27 unique hue stimuli were defined with different lightness-chroma levels for each unique hue. CIE XYZ tristimulus values of all these stimuli were also included in the Swedish Standard SS 01 91 03 (SS1979). Figure 1 illustrates the position of four of the NCS unique hue stimuli in the CIE 1976 Uniform Chromaticity Scale (UCS) diagram.

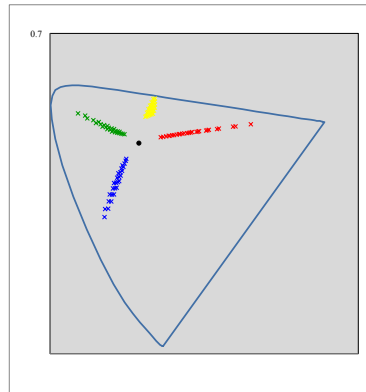

Figure 1: Four NCS unique hue stimuli in CIE  $u'v'$  chromaticity diagram.

### 2.2 CIECAM02 Prediction

Here we used the CIECAM02 to predict colour appearance attributes for each of the NCS unique hue stimuli. To predict the appearance of NCS unique hue stimuli under the original viewing condition, input parameters for the CIECAM02 model were defined as in Table 1, where the CIE Illuminant C was used as the adapting white and the luminance of adapting field was set at 200 cd/m<sup>2</sup> equivalent to the highest luminance in the NCS system, relative luminance of background ( $Y_b$ ) was set to 74.

Table 1. Inputting parameters of CIECAM02 for unique hue prediction.

Parameters	$X_w$	$Y_w$	$Z_w$	$L_w$	$Y_b$	Surround
CIECAM02	98.1	100.0	118.2	200.0	74.0	Average

### 2.3 Unique Hue Loci Modelling

In order to represent unique hue loci in CIECAM02, linear unique hue lines were defined in Eq. (1) and their coefficients  $K$  and  $C$  were derived by a two-way linear least-squares analysis for 27 unique hue stimuli for each unique hue, respectively.

$$b_c = Ka_c + C \quad (1)$$

### 2.4 Evaluation of the Unique Hue Predictions

In CIECAM02, four default hue angles are given that represent unique red, yellow, green and blue respectively and there is an assumption that the position of these unique hue lines is independent of both lightness and chroma. In order to test this assumption, the unique hue loci predicted using Eqn. 1 above were compared with the corresponding default unique hue.

### 2.5 Evaluation of Hue Uniformity

Hue uniformity is the extent to which the perceived hue is independent of the two perceptual attributes, lightness and chroma. In this study, the average absolute perceptual hue difference ( $|\overline{\Delta H}|$ ) between each individual hue stimulus and the mean of all unique hue stimuli was calculated to represent the performance of hue uniformity in CIECAM02. The perceptual hue difference between each unique hue stimulus and the average unique hue stimulus ( $\Delta H$ ) was calculated using Eqn. (2).

$$\Delta H = 2C_i \sin\left(\frac{h_i - \bar{h}}{2}\right) \quad (2)$$

where  $C_i$  and  $h_i$  represent the chroma and hue angle of  $i^{th}$  unique hue stimulus respectively, and  $\bar{h}$  represents the mean hue angle of a group of unique hue stimuli.

## 3. RESULTS AND DISCUSSIONS

Colour appearance attributes for 108 NCS unique hue stimuli were predicted using CIECAM02. Figure 2 illustrates the distribution of unique hue stimuli in CIECAM02  $a_c$ - $b_c$  diagram. Each point in the diagram represents a particular unique hue stimulus assessed in the original NCS experiment. The best linear fit was determined for each unique hue. It can be seen that predicted unique hue lines fit the corresponding unique hue stimuli very well. It can be also seen that the four unique hue lines do not cross at the origin: Unique yellow, UY, and unique blue, UB, cross at the point (7.9, 1.6). This suggests that there might be a problem with the hue uniformity for UY and UB.

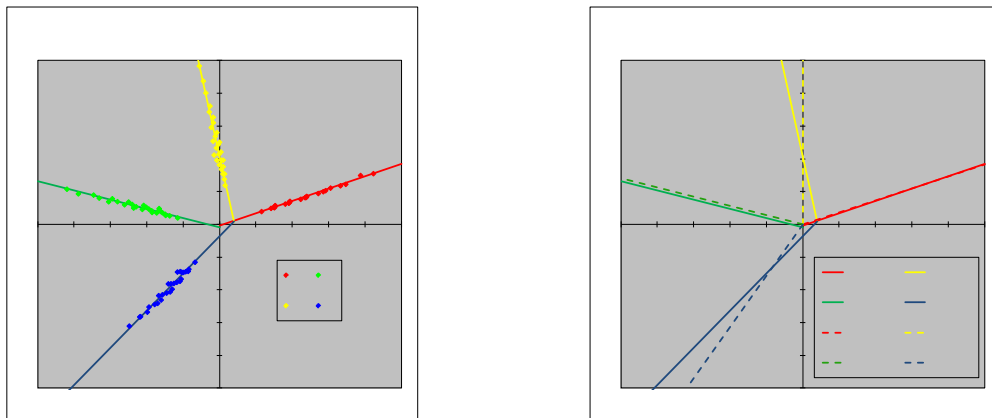

Figure 2: Unique hue stimuli in CIECAM02. Figure 3: Unique hue loci in CIECAM02.

Figure 3 compares the predicted NCS unique hue loci with the defined unique hue loci in the CIECAM02  $a_c$ - $b_c$  chromatic diagram, where the solid lines represent the NCS unique hue lines and the broken lines represent the default unique hue loci in CIECAM02. It can be

clearly seen that, although they agree well for unique red and unique green, there are clear discrepancies for both unique yellow, UY, and unique blue, UB, between the NCS unique hue line and CIECAM02 default unique hue loci.

To evaluate hue uniformity, the absolute mean value and the standard deviation of the perceptual hue differences were calculated for each unique hue and the results are shown in Table 2. The average perceptual hue difference was less than unity for both unique red, UR (0.36) and unique green, UG (0.95). The hue uniformity is worse for both unique yellow, UY and unique blue, UB with mean perceptual hue differences of 2.7 and 1.6, respectively.

Table 2: Perceptual hue differences between individual unique hues and the mean.

$ \Delta H $	UR	UY	UG	UB
Mean	0.36	2.70	0.95	1.63
STDEV	0.41	2.22	0.67	1.08

#### 4. CONCLUSIONS

NCS unique hue stimuli were employed to evaluate the loci of the unique hue lines and hue uniformity in CIECAM02. Colour appearance attributes were predicted with the original viewing parameters used for data collection. The loci of unique hue data in the CIECAM02 uniform colour space were plotted and compared with the default unique hues. A clear discrepancy between these two sets of hue lines in both unique yellow and unique blue was found. Hue uniformity for CIECAM02 was evaluated by comparing perceptual hue difference at different lightness and chroma levels. It was found that there was a significant hue shift for unique yellow and unique blue when lightness or chroma was changed.

#### REFERENCES

- CIE Publication 159 2004, *A Color Appearance Model for Color Management Systems*. Vienna, Austria: Commission Internationale de L'éclairage.
- Hård, A., L. Sivik and G. Tonnquist, 1996. NCS, Natural color system-from concept to research and application, Part I. *Color Res. Appl.*, 21:180-205.
- Hering, E., 1964. *Outlines of a Theory of the light sense*, translated by L. M. Hurvich and D. Jameson, Harvard University Press, Cambridge.
- Hunt, R.W.G., 1982. A model of colour vision for predicting colour appearance. *Color Res. Appl.*, 7: 95-112.
- Luo, M.R., G. Cui and C.J. Li, 2006. *Uniform colour space based on CIECAM02 colour appearance model*. *Col. Res. Appl.*, 31:320-330.
- Swedish Standard SS 01 91 03 1982, *Tristimulus Values and Chromatic Co-ordinates for the Color Samples in SS 01 91 02*, Swedish Stan Standards Institute, Stockholm.

*Address: Dr Kaida Xiao, University of Liverpool,  
Eleanor Rathbone Building, Bedford Street South, Liverpool L69 7ZA, UK  
E-mails: kaidaxiao@yahoo.co.uk, mrpointer@btinternet.com, guihua.cui@gmail.com,  
Tushar.Chauhan@liverpool.ac.uk, s.m.wuerger@liverpool.ac.uk*



# Colorimetric Characterization of Camera for Colour Measurement of Printed Images

Xinyi LI,<sup>1</sup> \*Qingmei HUANG,<sup>1</sup> Nanbo LIU,<sup>2</sup> Aimin LU,<sup>2</sup> Ningfang LIAO,<sup>1</sup> Weigui HU<sup>1</sup>  
<sup>1</sup>National Laboratory of Colour Science and Engineering, Beijing Institute of Technology  
<sup>2</sup>SINOMV Technology Co. Ltd

## ABSTRACT

In this paper, an IT8.7/3 colour checker was used as printed sample sets, and colour characterization based on digital camera responses for measuring colour values of printed image was studied. Three methods, polynomial, look-up-table and neural networks model, were compared. A quantitative evaluation of their performance was performed for a typical camera system. The result showed that the two models, look-up-table and BP neural networks, were approximately comparable and performed better amongst three models. In order to ensure the reliability for application, look-up-table model and inverse distance weighting was chosen. Further, to improve the accuracy of colour measurement of the system more samples in the particular gamut were added into the look-up-table. The result indicated that the colour difference between the estimated XYZ data from the proposed model and the measured XYZ data using a colorimeter was less than  $3\Delta E_{ab}^*$  by using this detection system. Experimental result and test result in the printing application are reported and discussed.

## 1. INTRODUCTION

In general, the spectral radiometer and colorimeter are used to measure and control colours for colour patches in the printing industry. To meet the needs of real-time requirement, digital cameras are applied to measure colour for images. It is necessary in this technique to do digital cameras' colorimetric characterization which is transforming the digital data RGB into tristimulus values CIEXYZ under a set of particular viewing conditions. Then through this transformation, the colour values are estimated.

Three methods for colorimetric characterization of camera, polynomial regression, neural networks and look-up-table methods, were discussed in this paper. More details were described in previous works of J. Pujol et al. (2003), Wu Jing et al. (2004), Peter Nussbaum et al. (2011) and Liang Yuxiang (2004). To build a digital camera into a colour measurement device which is specially used for printed images in the production line, we hope to find a more suitable characterization method with the IT8.7/3 colour checker.

## 2. METHOD

### 2.1 Experimental procedure

The purpose of the experiment is to obtain some colour data which are needed by digital camera's characterization. A digital camera with a 1K linear CCD image sensor was needed. The CIEXYZ and LAB of an IT8.7/3 colour checker which is laser printing measured by a colorimeter named "Data colour(ACS)". After the digital camera had been done the basic correction (flattening field and white balance correction), the IT8.7/3 colour checker was

scanned to the digital image in device RGB space. The RGB value of every patch was the average of the 12×12 pixels' RGB values. We dealt with these data through following characterization methods and built a model transformed the RGB into XYZ.

## 2.2 The methods of characterization

IT8.7/3 colour checker was used to establish the model as training samples. And 80 random colour patches in the gamut of IT8.7/3 were chosen to test the accuracy of the model. Test samples should evenly distributed in the RGB space of training samples as much as possible. The colour differences in CIE1976LAB space between the estimated and measured colour values were calculated and analyzed. The colour differences of three methods were shown in Figure 3.

### 2.2.1 Polynomial regression

In this work we applied polynomial for a 3 x 11 matrix. We fitted a transformed matrix. Through the matrix, the XYZ values were estimated.

$$\begin{bmatrix} X \\ Y \\ Z \end{bmatrix}_{(3 \times 1100)} = P_{(3 \times 11)} \times \begin{bmatrix} 1 & 1 & 1 & \dots & 1 \\ R_1 & R_2 & R_3 & \dots & R_{1100} \\ G_1 & G_2 & \vdots & \dots & \vdots \\ B_1 & B_2 & \vdots & \dots & \vdots \\ R_1 G_1 & R_2 G_2 & \vdots & \dots & \vdots \\ G_1 B_1 & G_2 B_2 & \vdots & \dots & \vdots \\ R_1 B_1 & R_2 B_2 & \vdots & \dots & \vdots \\ R_1^2 & R_2^2 & \vdots & \dots & \vdots \\ G_1^2 & G_2^2 & \vdots & \dots & \vdots \\ B_1^2 & B_2^2 & \vdots & \dots & \vdots \\ R_1 G_1 B_1 & R_2 G_2 B_2 & R_3 G_3 B_3 & \dots & R_{1100} G_{1100} B_{1100} \end{bmatrix}_{(11 \times 1100)} \quad (1)$$

### 2.2.2 BP Neural network

Established a 3-20-20-20-3 neural network by using Matlab. The digital RGB values were chosen as BP neural network input data  $P_k (a_{1k}, a_{2k}, \dots, a_{1100k})$  and the standard XYZ were chosen as target output data  $T_k = (S_{1k}, S_{2k}, \dots, S_{1100k})$ . The max epoch of the net was 20000. The goal was 0.0001.

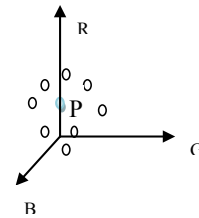

Figure1: Point distribution

### 2.2.3 Look up table

The inverse distance weighted interpolation was chosen because the gamut of IT8.7/3 colour checker was difficult to divide evenly. Finding eight points which nearest to the point P, and giving eight points, number  $Q_i (i = 1, 2, 3, 4, 5, 6, 7, 8)$ , the distance between P and  $Q_i$  is  $r_i (i = 1, 2, 3, 4, 5, 6, 7, 8)$ , shown in Figure 1.

$$P = \sum_{i=1}^8 \frac{1/r_i^2}{\sum_{i=1}^8 1/r_i^2} Q_i \quad (2)$$

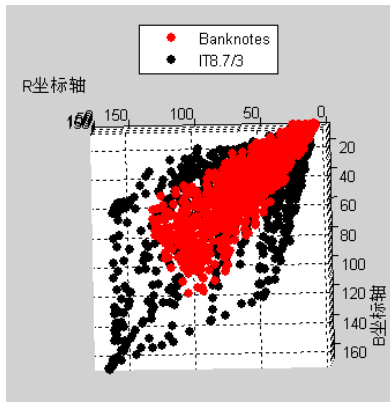

Figure 2: Gamut of samples.

For some printed images which are limited within a gamut, we attempted to improve the accuracy, so more images' colour samples were added into the look-up-table and established an improved look-up-table. 1097 colour patches in the gamut (Figure 2) of the banknotes were chosen to add into training samples, and 60 patches were chosen as test samples. The results for the two look-up-tables were done in Figure 4.

### 3. RESULTS AND DISCUSSIONS

#### 3.1 Comparison of three characterization methods

In the 80 test samples, the samples whose colour differences are less than 3 possess 40 percent by using the polynomial regression, 60 percent by using the BP neural network method and 80 percent by using the look-up-table method. The polynomial regression is not require to select evenly spitted colour samples, but the algorithm cannot be guaranteed to convert accurately in the entire gamut, the conversion error is often less than ideal. Compared the results above, the look-up-table performed best among three methods of the characterization. But all these results are not ideal, we need improve the accuracy.

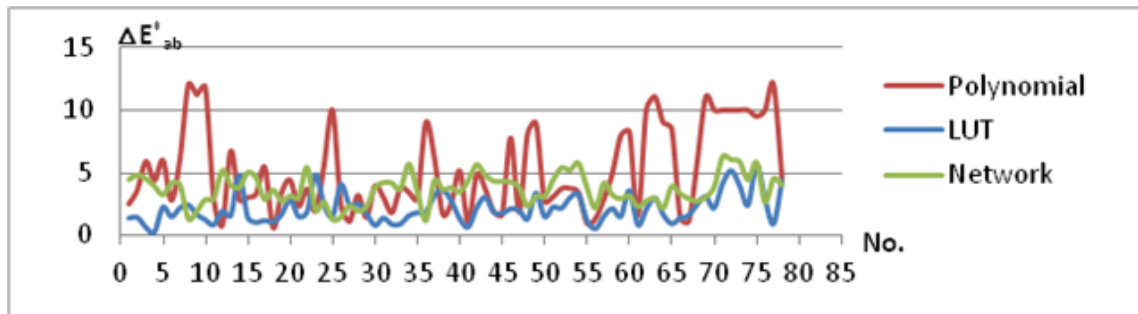

Figure 3: Comparison of the colour differences.

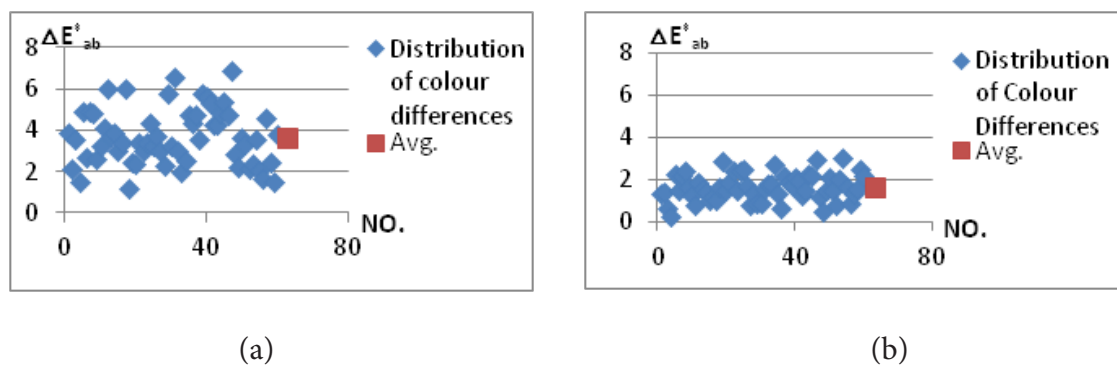

Figure 4: The distribution of colour differences.

### 3.2 Comparison of results in the look-up-tables

According to the banknotes' samples, Figure 4 shows the distribution of colour differences, (a) is just choosing IT8.7/3 to set up look-up-table, (b) is adding some particular colour patches into the look-up-table.

Compared these results in (a) and (b), we can see the average of  $\Delta E_{ab}^*$  is obvious decreased, the accuracy of the colour measurement system is improved. Figure 4(b) shows the average of  $\Delta E_{ab}^*$  is 1.62, the colour differences of all patches are less than  $3\Delta E_{ab}^*$ .

## 4. CONCLUSION

In this paper, colour characterization based on digital camera responses for measuring colour difference of printed image was studied with an IT8.7/3 colour checker. The comparison of three characterization methods showed that the look-up-table models performed best. And inverse distance weighted interpolation algorithm was chosen for the look-up-table model. Further, more samples of printed images which are limited within a gamut were added into the look-up-table to improve the accuracy of colour measurement system. With the optimized look-up-table, the colour differences between the estimated XYZ data by using this detection system and the measured XYZ data by using a colorimeter were all less than  $3\Delta E_{ab}^*$ . The accuracy of the digital camera which is used as a colour measurement device can be accepted.

## REFERENCES

- Pujol, J., and P. Capilla, 2003. Characterization of a Digital Camera as an Absolute Tristimulus Colorimeter, *Journal of Imaging Science and Technology* 47(4)
- Jing, W., Y. Weiping, O. Jiaming, J. Shaoquan, H. Jianming, 2004. Characterization of still camera BP neural net works-based, *Optical Technique* 30(5).
- Nussbaum, P., J.Y. Hardeberg and F. Albrechtsen.2011. Regression based characterization of colour measurement instruments in printing applications I: Proceedings of SPIE, *the International Society for Optical Engineering, Colour Imaging XVI: displaying, processing, hardcopy, and applications*24-27, San Francisco, California, United States, SPIE – International Society for Optical Engineering.
- Yuxiang, L., 2004. *Lut-Based Characterization Method Study of CCD Digital Camera [D]*. Yunnan Normal University. Yun Nan.
- The design examples of BP neural network (MATLAB), 2012. [http://blog.sciencenet.cn / blog- 111625-557605.html](http://blog.sciencenet.cn/blog-111625-557605.html)

*Address: \*Qingmei Huang, National Laboratory of Colour Science and Engineering, Beijing Institute of Technology, Beijing, 100081, CHN*  
*E-mails: xylee91@163.com, \*huangqm@bit.edu.cn, nathonliu@sinomvtech.com*  
*aiminlu@sinomvtech.com, liaonf@bit.edu.cn, hwh19880312@163.com*

# Analysis of the Features of Color Correction in the Movie Industry Based on the Pattern of Viewing Pictures

Alexander A. AMBALOV,<sup>1</sup> Anna A. KHOLINA,<sup>2</sup> Paul A. ORLOV<sup>3</sup>

<sup>1</sup> Saint-Petersburg State Polytechnical University

<sup>2</sup> Aalto University, School of Art, Design and Architecture

<sup>3</sup> East Finland Graduate School in Computer Science and Engineering,  
University of Eastern Finland

## ABSTRACT

This paper looks at the phenomenon of presence of colour in a motion picture. The research was based on the theory of trichromatic colour vision which regards colour as a subjective feature, perceived individually by people. We clarify the process of artistic colour correction or color-grading based on different colour wheels (RYB and HSB). An eye-tracking study is made to prove the idea that using complementary colors in cinema can catch the attention of a viewer and highlight main subject of a scene.

## 1. INTRODUCTION

Colour is used not only to create a certain mood or atmosphere, but also to attract attention to a work and affect its perception. According to J. Itten both colour and achromatic contrasts attract attention. Being one of the most profitable business areas, cinema has been implying this technique for a long time, though for most people application of colour in film seem to have a purely artistic nature. In this paper we search for the features that are used in mass-produced movies to manipulate viewer's attention. Basing on Itten's theories we define the most effective colour combinations in cinema and check the hypothesis that the occurrence of these common colour combinations in movies can attract viewer's attention or change the pattern of how we perceive the image in motion picture.



Figure 1: Hue location on the RGB wheel in the HSB colour model.

## 2. STATISTICAL AND HISTORICAL RESEARCH

The material for our statistical study of colour combinations in cinema includes 177 most distinctive shots from 84 popular movies released during the past decade. We assure that all visual materials presented in the movies was color-corrected and therefore we rely on the final output rather than on original shots. We were searching for the difference in hue variation in the still frames of the sequences. The hue contrast was measured by software written with Processing programming language. Information about colour combinations was displayed

in the HSB colour model, where hue was defined by grades (0°-360°). The result showed that 78% of pictures were built on contrast – with 120°-240° of hue difference (Fig. 1). It has been suggested that these colour combinations are complementary, i.e., colours must be located at opposite sides of the colour wheel, according to the studies of Itten, Munsell and Ostwald. A similar study based on random pictures showed that only 48% of images are built on contrasts.

A detailed analysis based on the 59 most distinct pictures showed that the difference in hue values in contrasting combinations is not constant and depends on the source colour. And in the most cases, on the RGB color wheel these colours are not placed at an angle of 180°. Thus, two assumptions have been made:

- contrasting colour combinations are chosen subjectively, or
- different colour model and wheel are used for making such combinations.

For comparison we examined the dependence of the location of complementary colours on the RYB wheel. When transferring data to a HSB colour model, it became clear that the delta between opposite colours in the RYB model dynamically changes depending on the source colour. The comparison of data on contrasting combinations in movies and complementary colours on the RYB wheel showed a certain degree of similarity between them (Fig. 2).

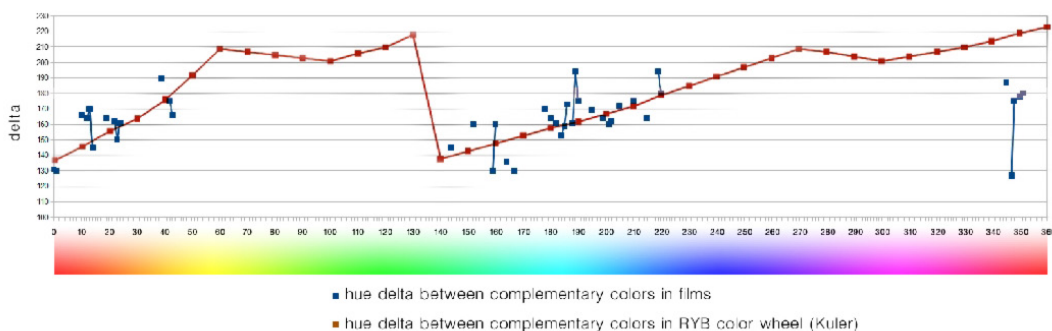

Figure 2: Comparison of hue deviations in pictures from movies and in Adobe Kuler.

The RYB colour model and its colour wheel in particular, have a certain degree of resemblance to twelve-hue color wheel proposed by J. Itten.

### 3. EXPERIMENT

In order to determine the validity of the findings we have carried out an experiment with a purpose to identify the pattern of viewing pictures with colour correction. Eye-tracking method is used in the research as eye-movements are tightly coupled with visual attention which makes them eminent indicators of the covert visual attention process (Wedel and Pieters, 2008: 3).

**The hypothesis:** an individual has a predisposition to a particular pattern of viewing pictures. **The counter-hypothesis:** there is no pattern of examining images, i.e. each person has an individual way of viewing pictures.

We have created seven stimuli for the experiment. In our paper we define a stimulus as a set of images, each consisting of one photo in four variations of processing: the original, the black-and-white version, the technical processing and the processing based on the identified colour combinations. By technical processed image we mean primary color correc-

tion: adjustment of brightness and contrast, removing of accidental shades or improving the drawbacks of the camera. By processing based on the identified colour combinations we imply secondary color correction: more precise handling of the specific areas of the frame or sequence to correspond to a chosen color scheme which is selected on the basis of Itten's color research and RYB color wheel.

We used static images because we need to exclude the several aspects of perception of dynamic scenes like form factors and movement to focus on color effects, look at Velichkovsky for more details (Velichkovsky, 2006). There are several kinds of eye movements, in general there are 1) fixations, 2) saccades, 3) nystagmus and 4) drifts (Yarbus, 1965; Gippenreiter, 1978). The participants were invited to look at each of the sets for seven seconds and choose the option that, in their opinion, was good enough to be displayed in the imaginary art gallery. The experiment was conducted with the help of Eye tracking system Red 250, manufactured by German company SensoMotoric Instruments (SMI). Gaze fixations were chosen as a measurable parameter.

The analysis was performed using R programming language for graphics and statistical data processing. The fixation data, obtained in the course of the experiment, was grouped by areas of interest that correspond to various processing options for each stimulus. Two samples were prepared for the study:

- number and duration of fixations on the whole stimulus, i.e. the cumulative data for all areas of interest;
- number and duration of fixations on specific areas of interest.

Initial analysis showed that for a statistical comparison of samples by the zones of interest it is necessary to take all fixations related to a typical zone for each individual. This is due to the fact that a few of participants have small number of fixations. The selections of all zones of interest for each participant were verified with Shapiro-Wilk test in relation to the distribution law, at a significance level of 0,05. The experiment showed that only 9 out of 13 samples were not distributed normally. A comparison of the statistical indistinguishability was performed by Kruskal-Wallis nonparametric test. Pairwise comparison showed that only 37/77 pairs (48%) were statistically indistinguishable. Samples selected by the area of interest in the fourth type of image in a set were also tested for the distribution law using the Shapiro-Wilke test at a significance level of 0,05. The p-value for all samples was much less than 0.05. A comparison of the statistical indistinguishability was also performed by nonparametric Kruskal-Wallis test. Pairwise comparison showed that 52/77 pairs (67%) are statistically indistinguishable (Fig. 3).

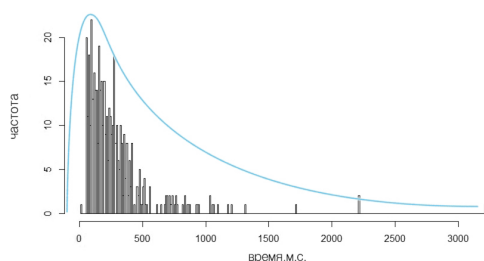

*Figure 3: Distribution of data on the time of fixations in the area with colour correction.*

Taking into consideration the observed tendency for identical examining images in which identified colour combinations are present we can suggest existence of specific pattern of viewing pictures. The presence of the pattern can probably indicate the non-random selection of frames for statistical analysis and non-randomness of colour combinations themselves.

#### 4. CONCLUSION

The process of working with colour is divided into two parts: colour correction and colour grading. At present, all work with colour is based on the classic RGB wheel on both stages. This circle is present in most modern software: Da Vinci, Red Giant, After Effects, Premier, Final Cut. This is quite justified in terms of technical correction of the image: if you want to get rid of yellow shade in the picture, you need to add the blue colour. This scheme is ideal for primary colour correction and colour matching process in different takes. However, on the basis of the above mentioned data, we can assume that the process of artistic colour correction or grading may differ not only semantically, and could be technically based on different colour wheels. This way the process of colour grading can be based on the RYB wheel or on a modified HSB wheel offered by Adobe, and this will simplify the process of selecting the required colour combinations for colourists.

The second important finding is a confirmation that a pattern of gaze fixations in viewing pictures exists. It can be suggested that viewing images with identified colour combination is a common process. This increases the efficiency of mass cinema.

#### REFERENCES

- Anter, K.F., 2000. *What colour is the red house? Perceived colour of painted facades*. Doctoral thesis, Department of Architectural Forms, Institution of Architecture, Royal Institute of Technology, Sweden.
- Bellantoni, P., 2000. *If It's Purple, Someone's Gonna Die: The Power of Color in Visual Storytelling*. Taylor & Francis.
- Birren, F., 1970. *The Elements of Color*. John Wiley & Sons.
- Brinkman, R., 1999. *The art and science of digital compositing*. Morgan Kaufmann.
- Committee on Colorimetry, 1953 *The Science of Color*. Optical Society of America. Crowell.
- Gippenreiter, Y. B., 1978. *Движения человеческого глаза [Movements of the human eye]* (p. 256). Moscow: Изд-во Московского государственного университета.
- Itten, J., 1974. *The Art of Color: The Subjective Experience and Objective Rationale of Color*. Wiley.
- James, J., 2012. *Digital Intermediates for Film and Video*. CRC Press.
- Kuehni, R.G., 2003. *Color Space and Its Divisions*. John Wiley & Sons.
- Ohanian, T.A., M.E. Phillips, 2000 *Digital filmmaking: the changing art and craft of making motion pictures*. Focal Press.
- Okazaki, S., 2011. *Advances in Advertising Research (Vol. 2)*. Springer.
- Sawicki, M., 2012. *Filming the Fantastic: A Guide to Visual Effects Cinematography*. CRC Press.
- Velho, L., F.C. Alejandro and J. Gomes. 2008. *Image Processing for Computer Graphics and Vision*. Springer.
- Velichkovsky, V.M., 2006. *Когнитивная наука: Основы психологии познания [Cognitive Science: Foundations of epistemic psychology.]* (v.1 p. 448, v.2 p. 432). Moscow: Смысл-Издательский центр «Академия».
- Wedel, M., R. Pieters, 2008. *Eye tracking for visual marketing*. Now Publishers Inc.
- Yarbus, A.L., 1965. *Роль движений глаз в процессе зрения [Eye movements and vision]*. (p. 173). Moscow: Изд-во "Наука."

E-mails: [lamb-aleksandr@ya.ru](mailto:lamb-aleksandr@ya.ru), [2anna.kholina@gmail.com](mailto:2anna.kholina@gmail.com), [3paul.a.orlov@gmail.com](mailto:3paul.a.orlov@gmail.com)



# Gender Influences on Subjective Evaluations in Images

Syntyche GBEHOUNOU, François LECÉLLIER, Christine FERNANDEZ-MALOIGNE  
Department SIC of XLIM Laboratory, UMR CNRS 7252; Poitiers, France

## ABSTRACT

This paper proposes to study gender influences on subjective evaluations in images. Our goal is to verify if some common conclusions in psychology experiences are confirmed during the subjective evaluations we organized.

Our database and our test strategy are the main originalities of this work. We built a new low semantic images database, composed of 350 natural images. The tests were accessible via the Internet and each participant rated 24 randomly selected images. 1741 participants, including 848 men (48.71%) and 893 women (51.29%) assessed our 350 images according to the nature and the power of the emotion. We also ask them to quick evaluate each image (under 10 seconds) to have really their “primary” emotions.

During the analysis of the results of the tests, we observed that women tend to associate more often positive or negative emotions to images than men who consider those images as neutral. The additional neutral ones scored by men are generally classified positive or negative by women. In fact, women scored positive with the low power some images men scored neutral. These results confirm potential differences in gender emotion evaluations and also the common conclusion that women express more emotions than men.

## 1. INTRODUCTION

Gender differences in emotional impact evaluation can be defined as a part of studies focused on sex differences, which are, according to many aspects of daily life, a large research subject. Research on sex and psychology investigates cognitive and behavioural differences between men and women. The common question of these studies is to find why women and men have different behaviours in the same situations and to model these divergences.

The majority of the researches about sex differences can be resumed in two theories:

- Social theories: the differences between men and women are socially constructed and influenced by factors such as stereotypical gender roles.
- Biological theories: sex differences are caused by their biological differences.

However some authors, for example Halpern (Halpern 2011) argues that psychological sex differences can be based on a combination of social and biological factors.

In biological theories, Hofer et al. (Hofer, et al. 2006) focused on the cerebral activity during emotions perception. For them, emotional differences between genders also reflect genotypic differences in sexual dimorphism of the nervous system. Their studies were also based on the fact that many functional imaging works show differences between genders about emotional memory encoding.

In social theories they are a lot of gender-specific patterns. Fischer et al. (Fischer, et al. 2004) tested some hypothesis. The first one they verified is “Women report less intense powerful emotions (anger and contempt) and more intense powerless emotions (fear, sadness, shame, and guilt) than men” and this did not vary across countries.

Sex differences are also analysed during evaluations of a database. For example, men and women did not react identically to pleasant, neutral, and unpleasant pictures, in Bradley et al.'s experiences (Bradley, et al. 2001). Women were more reactive to unpleasant materials, rating these pictures as more arousing and more unpleasant. Compared with men, they also rated neutral pictures as slightly less pleasant.

In the rest of this paper, we present our database and describe the experimentations in Section 2. The Section 3 is focused on the results and their analysis and we conclude this work and also present some future works in Section 4.

## 2. IMAGES DATABASE AND EXPERIMENTATIONS

### 2.1 Image database

For this study, the database used in (Gbèhounou, Lecellier et Fernandez-Maloigne 2012) has been expanded for new evaluations. This set of images is free to use and composed of 350 low semantic, natural and diversified images. In this paper, "low-semantic" means, that the images do not shock and do not force a strong emotional response. We also chose low semantic images to minimize the potential interactions between emotions on following images during subjective evaluations. This aspect is important to ensure that the emotions indicated for an image is really related to its content and not to the emotional impact of the previous one.

### 2.2 Experimentations

The tests were accessible via the Internet and offers to the participants to assess nature and power of emotions in 24 images. For the nature, they can choose "Negative", "Neutral" or "Positive". The power varies from "Weak" to "Strong". We chose this information to define emotions because according to us, it is the best way to evaluate globally a "primary" emotion on low semantic database.

Our database was assessed by people of all ages. Most of them were aged 15 to 30 years and they represent 81.1% of the panel. 1741 participants, including 848 men (48.71%) and 893 women (51.29%), around the world, scored the database. Each observer evaluated 24 randomly selected images if he makes the full test. The average time of observation is 6.6 seconds. It seems really short but it allows us to limit semantic interpretation of an image after a long duration. Each image was assessed by an average of 104.81 observers.

## 3. RESULTS AND ANALYSIS

Table 1 shows the classification of our database by sex. The nature "Uncategorised" used is for images which cannot be classified because they have two classes (same classification percentage in two natures of emotion) based of the participant scoring.

*Table 1: Number of images in each categories of emotion according to gender.*

Nature of emotion	Women	Men
Negative	20%	14.57%
Neutral	34.43%	43.43%
Positive	43.43%	39.71%
Uncategorised	1.14%	2.29%

The first conclusion regarding Table 1 is that globally, women found our database positive and the men neutral. So, we can say that women seem more emotive (more positive and negative emotional impacts) than men during evaluation of the same images. These results seem coherent regarding the common conclusion in sex differences in emotions, for example in (Fischer et al. 2004).

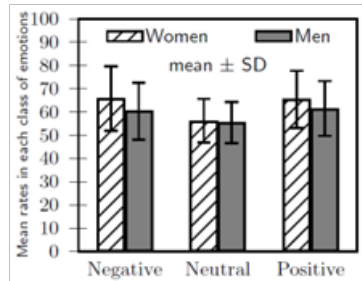

Figure 1: Mean rates in each class of emotions according to gender for the same nature of emotions.

Figure 1 represents, for each sex, the average percentage of people who give the same nature of emotion of an image. This graphic confirms our previous conclusion about the highly emotionality of women.

Except for neutral images, women are more unanimous than men. They are more to feel the same emotion on an image compare to men. For neutral emotions the two sexes have approximately the same percentage. However, for each sex the mean rate of observers who gives the emotional impact of an image is high. This means that, despite the fact that it is a low semantic database, the opinions are consistent.

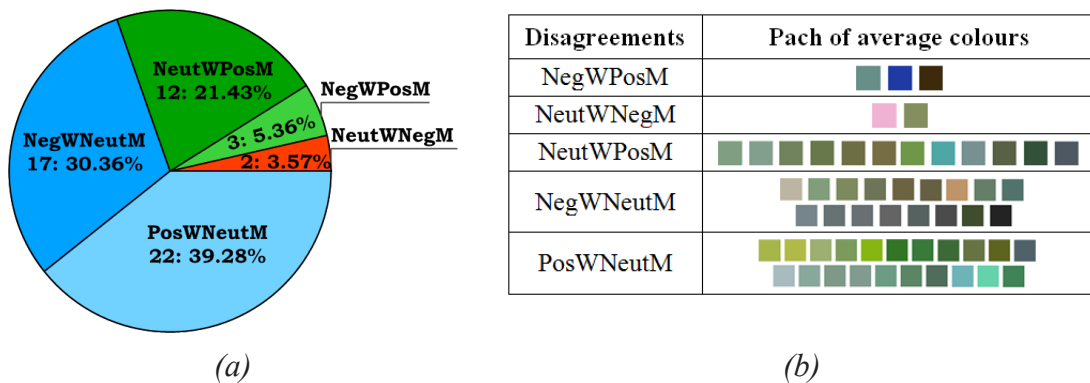

Figure 2: Disagreements between women and men during the evaluation of emotional impact.

On Figure 2, we represent the distribution of the disagreements between genders (a) and the average colours of the images in each kind of disagreements (b). PosWNeutM is for images judged Positive by women and Neutral by men, NegWNeutM is Negative for women and Neutral for Men. Based on the same principle as previously, NegWPosM is Negative for women and Positive for men, NegWPosM is Negative for women and Positive for Men and NeutWNegM is Neutral for women and Negative for Men. It clearly confirms that the majority of the additional neutral images for men is either positive or negative for women.

The large part of differences in judgement is made by images judged Positive by women and Neutral by men. This case can be explained with the difference of sensibility. For example, in the experiences organized by Bradley et al. (Bradley, et al. 2001) women also

rated neutral pictures as slightly less pleasant. Even if their database is more semantic than ours, our results are consistent especially because the power associated with the emotions of concerned images is weak.

Images concerned by the cases NegWPosM and NegWNeutM show the sensibility of men to cold and dark colours.

The results NegWNeutM are particular. In fact, women have more semantically interpreted the images concerned with the previous observations about dark and cold colours. But these images are specific, since they are composed of metal grids, reptiles, bad weather. Semantic added to these specific images plus the presence of dark and cold colours could be the reasons of this difference of emotional impact perception.

#### 4. CONCLUSIONS AND FUTURE WORK

Social aspects (Fischer, et al. 2004) or biological ones (Hofer, et al. 2006) or a combination of the twice (Halpern 2011) can contribute to the differences observed about gender evaluations of emotional impact of images. Emotions are complex reactions and their evaluations seem difficult if the strategy is not adapted. Our strategy was to ask participants to score the nature and the power of the emotions they filled with very general terms. According to us it is the best way to evaluate on a low semantic database.

In our experimentations we did not take care about social or cultural differences between our participants but we compare the results just according to their gender. We did not also measure some biological parameters during experiences. Our objectives were to analyse the behaviours of genders for our tests. We noticed some differences specially for negative and positive emotional impact. For neutral evaluations we cannot compare correctly the ratings because the definition of neutral emotion depends on each one. It can be because an image is neither really positive nor negative or because it does not inspire something. Women seem to be more sensitive to light colours and men judge less negative images with dark colours than women.

The first perspectives of this work are to assess and improve our system (Gbèhounou, Lecellier et Fernandez-Maloigne 2012) to extract emotional impact in image with indexation features on the all database. These ratings will be used to refine indexation results on images database by specifying the request according to gender. The image database and the results will soon be posted with the necessary permits.

#### REFERENCES

- Bradley, Margaret M., Maurizio Codispoti, Dean Sabatinelli, et Peter J. Lang. «Emotion and Motivation II: Sex Differences in Picture Processing.» *Emotion*, 2001: 300-319.
- Fischer, Agneta H., Patricia M. Rodriguez Mosquera, Annelies E. M. Van Vianen, et Antony S. R. Manstead. «Gender and culture differences in emotion.» *Emotion* 4 (2004): 87-94.
- Gbèhounou, Syntyche, François Lecellier, et Christine Fernandez-Maloigne. «Extraction of emotional impact in colour images.» *CGIV2012*. Society for Imaging Science and Technology, 2012. 314-319.
- Halpern, Diane F. «Sex Differences in Cognitive Abilities.» *Psychology Press*, 2011.
- Hofer, Alex, et al. «Gender differences in regional cerebral activity during the perception.» *NeuroImage* 32, n° 2 (2006): 854-862.

# Research on Color Vision Object Tracking

Wei YE, Chao WANG, Tianrong YOU  
 Department of Control Science and Engineering, Zhejiang University

## ABSTRACT

Image information is the most intuitive pattern that reflects the objective world. The color images with more vision information than gray ones are becoming increasingly concerned. With the development of computer and signal processing technologies, vision object tracking based on image processing attracts more and more attention. Image segmentation is an essential and critical process of object tracking. This article describes the background of the color object segmentation and tracking firstly. Then we provide a summary of color image segmentation techniques. Finally, the summary of this paper was made and the future research trends were prospected.

## 1. INTRODUCTION

Visual target tracking is a fundamental problem in computer vision. As the color cameras have been widely used in many vision applications such as automatic video surveillance, robotics and human machine interfaces, reliable color target tracking results are becoming increasingly indispensable. However, the task of color target tracking in real-time is very challenging under various environment conditions. Color image segmentation is an essential step of visual target tracking. It is one of the most difficult tasks in image processing and determines the quality of the result of image analysis. Many segmentation algorithms for color image have been proposed, such as color clustering, region-based method, etc. There is no universal theory on color image segmentation yet. The segmentation methods for gray images can be extended to segment color images by using R, G and B or their transformations (see Figure 1).

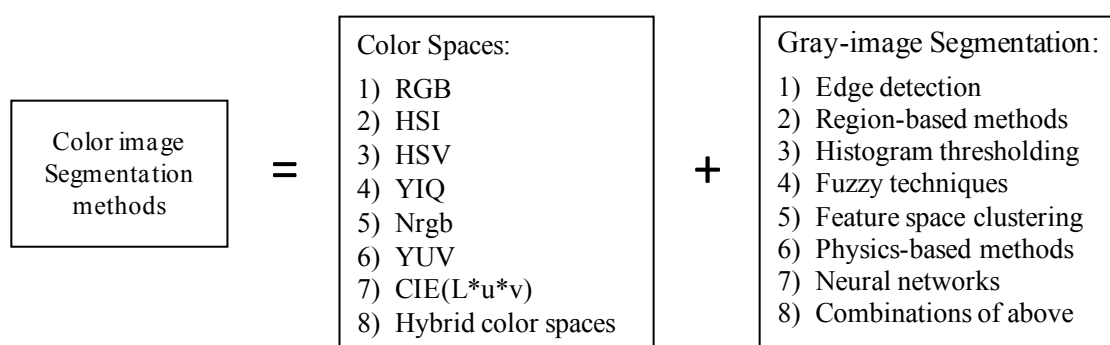

Figure 1: Commonly used color image segmentation methods.

This paper describes the background of the color object segmentation and tracking and provides a summary of color image segmentation techniques available at present. Section 2 reviews some major color spaces and their advantages/disadvantages. Section 3 introduces the major segmentation approaches for processing color images and classifies the approaches into five classes, and the summary is given in Section 4.

## 2. COLOUR SPACE

The selection of color space is the basis of color image processing and understanding, which will directly affect the color image processing method and result. Several color spaces such as RGB, HSI, HSV, and CIE are utilized in color image segmentation, but none of them can dominate the others for all kinds of color images. Selecting the best color space is still one of the difficulties in color image segmentation.

RGB color space is the most commonly used model for the television system. It is suitable for color display but not good for color segmentation and analysis because of the high correlation among the R, G and B components (Littmann 1997). Commonly used linear transformations spaces of RGB including: YUV, YIQ,  $I_1I_2I_3$ , etc. In YUV and YIQ color spaces, the Y component is often used for edge detection. These spaces can partly get rid of the correlation of the R, G and B components.

Some nonlinear transformations spaces of RGB including: HSI, Nrgb (Normalized RGB), CIE, etc. The HSI (hue-saturation-intensity) model is another commonly used color space in image processing, which is more intuitive to human vision. The HSI color space separates color information from its intensity information. Color information is represented by H and S values, while I component, which describes the brightness of an image, is determined by the amount of the light. The HSI color system has a good capability of representing the colors of human perception.

## 3. COLOUR IMAGE SEGMENTATION METHODS

### 3.1 Feature Space Clustering

Feature space clustering algorithm is an unsupervised statistical method, which does not need training samples. It can extract the characteristics by performing the classification algorithms iteratively. The commonly used classification algorithms including: K-means (Isa 2009), Fuzzy C-mean (FCM) (Chen 2007), etc.

For color images, a color space is a natural feature space, and applying the clustering approach to color image segmentation is simple and intuitive. Moreover, clustering approach can also take advantage of the three-component color information to improve the accuracy of the segmentation results. However, the biggest problem that it suffers from is how to determine the number of clusters in an unsupervised clustering scheme, which is known as cluster validity, and how to select the feature to obtain satisfactory segmentation results is not clear.

### 3.2 Histogram Thresholding

Histogram thresholding is one of the widely used techniques for monochrome image segmentation. As for color images, the situation is different from monochrome images because of multi-features. There is some limitation when dividing multiple dimensions. Since the color information is represented by tristimulus R, G and B or their linear/non-linear transformations, representing the histogram of a color image in a 3-dimensional array and selecting threshold in this histogram is not an easy job and detecting the clusters of points within this space will be computationally expensive.

Histogram thresholding method maps the homogeneous region of the feature space to the image space area, which usually costs a small calculation and does not require a prior knowledge. However, the method may drawback in the following aspects: 1) the solely color-based segmentation result may be incomplete; 2) it is difficult to acquire good segmentation results of complex images; 3) When the pixel color is mapped to different locations of the three histograms, the color information easily dissipate; 4) it does not take advantage of the local spatial information of the color pixels.

### 3.3 Edge Detection

Edge detection methods are usually classified into two categories: sequential and parallel (Cheng 2001). There are many types of parallel differential operators such as Roberts, Sobel, Prewitt and the Laplacian operators. Sequential edge detection means that the result at a point is dependent on the result of the previously examined points. There are a number of sequential techniques utilizing heuristic search and dynamic programming. The performance of a sequential edge detection algorithm will depend on the choice of a good initial point and it is not easy to define a termination criterion.

Overall, edge detection techniques can obtain accurate edge location with high computing speed. However, since the computation is based on a small window, it is sensitive to noise and cannot segment an image by itself. It is difficult to guarantee that the color of the split within the region, and cannot produce a continuous region contour. It can only provide useful information about the region boundaries for the higher level systems.

### 3.4 Region-based Approaches

Region-based approaches, including region growing, region splitting, region merging and their combination, attempt to group pixels into homogeneous regions. In the region growing approach, a seed region is first selected, and then expanded to include all homogeneous neighbors. In the region splitting approach, the initial seed region is simply the whole image. If the seed region is not homogeneous, it is usually divided into four squared sub-regions, which become new seed regions. The region merging approach is often combined with region growing or region splitting to merge the similar regions for making a homogeneous region as large as possible.

Region-based approaches work best on images with an obvious homogeneity criterion and tend to be less sensitive to noise because homogeneity is typically determined statistically. Both feature space and the spatial relation between pixels are taken into account. However, all region-based approaches are by nature sequential and another problem with these techniques is their inherent dependence on the selection of seed region and the order in which pixels and regions are examined and used.

### 3.5 Approaches combined with specific theories

In recent years, a large number of scholars are dedicated to using the new concepts or new methods to improve the results of color image segmentation, such as fuzzy theory, physics based approaches, neural networks approaches, genetic algorithms, etc.

Fuzzy theory provides a mechanism to represent and manipulate uncertainty and ambiguity. In fuzzy subsets, each pixel in an image has a degree to which it belongs to a region or a boundary, characterized by a membership value. So we can avoid making a crisp deci-

sion earlier and keep the information through the higher processing levels. Physics-based approaches aim at solving the problem that eliminating the spurious edges of shadow or highlights in a color image by employing physical models to locate the boundaries. Among the physics models, dichromatic reflection model and approximate color-reflectance model are the most common ones. Artificial Neural Networks (ANN) is widely applied for pattern recognition. Their extended parallel processing capability and nonlinear characteristics are used for classification and clustering. ANN explore many competing hypotheses simultaneously through parallel nets instead of performing a program of instructions sequentially, hence ANN can be feasible for parallel processing.

#### 4. SUMMARY

This article describes the background of the color object tracking and segmentation and focus on the color image segmentation techniques. The main color image segmentation methods are reviewed, including characteristics clustering, histogram thresholding, edge detection, region-based methods, etc. More and more new techniques are applying to color image segmentation. People are striving to find a general algorithm, which can be combined with various algorithms and be robust for the environment changing. While due to the complexity of color image segmentation, more studies and efforts by scholars are needed to solve the classic problem.

#### REFERENCES

- Littmann, E., and H. Ritter, 1997. Adaptive Color Segmentation – A Comparison of Neural and Statistical Methods. *IEEE Transactions on Neural Network* (8), 175-185.
- Isa, N.A.M., S.A. Salamah., and U.K. Ngah, 2009. Adaptive fuzzy moving K-means clustering algorithm for image segmentation. *IEEE Transactions on Consumer Electronics* (55), 2145-2153.
- Cai, W., S. Chen., and D. Zhang, 2007. Fast and robust fuzzy c-means clustering algorithms incorporating local information for image segmentation. *Pattern Recognition*.
- Cheng. H., X.H. Jiang. et al., 2001. Color Image Segmentation Advances & Prospects. *Pattern recognition*. 2259-2281.

*Address: Prof. Wei YE, Department of Control Science and Engineering,  
Zhejiang University, Zheda Road, Hangzhou 310027, China  
E-mail: wye@zju.edu.cn*



# Resolving the Ambiguity of Colour Fidelity Indices

Artūras ŽUKAUSKAS,<sup>1</sup> Rimantas VAICEKAUSKAS,<sup>2</sup>  
Pranciškus VITTA,<sup>1,2</sup> Michael SHUR<sup>3</sup>

<sup>1</sup> Institute of Applied Research, Vilnius University

<sup>2</sup> Department of Computer Science, Vilnius University

<sup>3</sup> Department of Electrical, Computer and System Engineering and Department of Physics, Applied Physics, and Astronomy, Rensselaer Polytechnic Institute

## ABSTRACT

An ambiguity of the general colour rendering index and other colour-fidelity indices is revealed using a tuneable red-amber-green-blue LED cluster, which allows for continuously traversing all possible metameric tetrachromatic blends. Our research shows that a set of light sources can be unambiguously ranked in colour rendition quality using a single index, which is a colour-fidelity index supplemented by a symbol indicating the dominant type of chroma distortion (saturating or dulling).

## 1. INTRODUCTION

The Colour Rendering Index (CRI; CIE 1995), which served for the quantification of the colour quality of light sources for decades, has become inadequate with the appearance of solid-state lamps with the spectral power distributions (SPDs) containing distinct narrow bands. In particular, discrepancy in visual ranking of some red-green-blue (RGB) LED clusters and yellow-blue (YB) phosphor conversion LEDs have been revealed (Narendran and Deng 2002). Eventually, the CIE (2007) stated that “visual experience has shown that the current CRI based ranking of a set of light sources containing LED light sources contradicts the visual ranking.” On the other hand, the subjective rating of colour quality of lighting is known to be based not only on colour fidelity, but also on colourfulness due to increased chroma of rendered colours (Rea and Freyssinier-Nova 2008).

In this work, we reveal an ambiguity of the general CRI ( $R_a$ ) and other colour-fidelity indices using a tetrachromatic red-amber-green-blue (RAGB) source, which is tuned over all possible metameric blends. We simulate pairs of the blends that have similar colour fidelity characteristics but are opposite in the ability to alter the chroma of rendered colours. Our results suggest a simple improvement of any colour fidelity metric by indicating the predominant type of chroma distortion resolves the ambiguity.

## 2. METHOD

The tuneable RAGB source used in this work is a colour rendition engine described and psychophysically assessed by Žukauskas et al. (2012). It comprises a cluster of red (624 nm peak wavelength), green (523 nm), and blue (450 nm) direct-emission LEDs and phosphor-conversion amber (591 nm) LEDs. The colour rendition properties of the engine are continuously tuned by varying the SPD as a weighted sum of the trichromatic RGB and AGB blends:

$$S_{RAGB}(\lambda) = \sigma S_{AGB}(\lambda) + (1 - \sigma) S_{RGB}(\lambda). \quad (1)$$

Provided that the two trichromatic lights have the same correlated colour temperature (CCT) and luminous output, tuning the weight parameter  $\sigma$  within the interval of (0,1) allows for continuously traversing all possible metameric RAGB blends, including those with the highest colour fidelity. The endpoints,  $\sigma = 0$  and  $\sigma = 1$ , correspond to the most colour saturating (RGB) and most colour dulling (AGB) light, respectively.

While moving from the RGB end-point to the AGB end-point, the resulting blends were examined using various colour rendition metrics, such as CRI, NIST Colour Quality Scale (CQS, Davis and Ohno 2010), and our Statistical Method (Žukauskas et al. 2009; Lebedenko and Vaicekauskas 2013). The latter metric is based on sorting 1269 Munsell test colour samples by colour shifts within a colour space scaled by 3-step MacAdam ellipses, when the light source under test is replaced by a reference light source. This approach allows for the introduction of different colour rendition indices, which are the percentage of colours that are rendered with high fidelity, or with increased or reduced saturation, and/or with distorted hue. The most important statistical indices are the Colour Fidelity Index (CFI), Colour Saturation Index (CSI), Colour Dulling Index (CDI), and Hue Distortion Index (HDI).

### 3. RESULTS AND DISCUSSION

Figure 1 displays the variation of the parameters of the colour rendition engine with AGB vs. RGB weight,  $\sigma$ . While tuning the engine, the peaks of  $R_a$ , CQS colour fidelity scale ( $Q_f$ ), and statistical CFI attain peak magnitudes at almost the same weight of about 0.75 (the general CQS scale  $Q_a$  also has a peak). However many values of colour fidelity indices that are different from the peak value, correspond to two RAGB blends having different RGB vs. AGB weight.

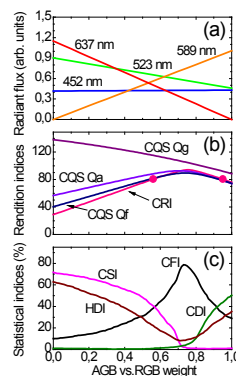

Figure 1: Variation of the parameters of the RAGB engine with AGB vs. RGB weight at a CCT of 4500 K. (a) Radiant fluxes of the four LED groups; (b) common colour rendition indices: the general CRI (pink line) and CQS scales  $Q_a$  (violet line),  $Q_f$  (navy line), and  $Q_g$  (purple line); (c) statistical indices: CFI (black line), CSI (magenta line), CDI (olive line), and HDI (wine line). The pink points in Fig. 1(b) mark two RAGB blends with a CRI of 80.

As an example, the pink points in Fig. 1(b) mark two RAGB blends with  $R_a = 80$  at weights of 0.55 and 0.95. Figures 2(a) and (b) show the SPDs of the two blends and Figs. 2(c) and (d) display the corresponding distributions of the vectors showing colour shifts in respect of a reference blackbody illuminant for 218 Munsell samples of value  $/6$  in the  $a^*-b^*$  chromaticity plane of the CIELAB colour space. For the SPD with a lower AGB content ( $\sigma = 0.55$ ), a large number of the colour shift vectors are directed outward indicating the colour-saturating effect. In contrast, for a higher AGB content ( $\sigma = 0.95$ ), a large number of the vectors are directed inward indicating the colour-dulling effect.

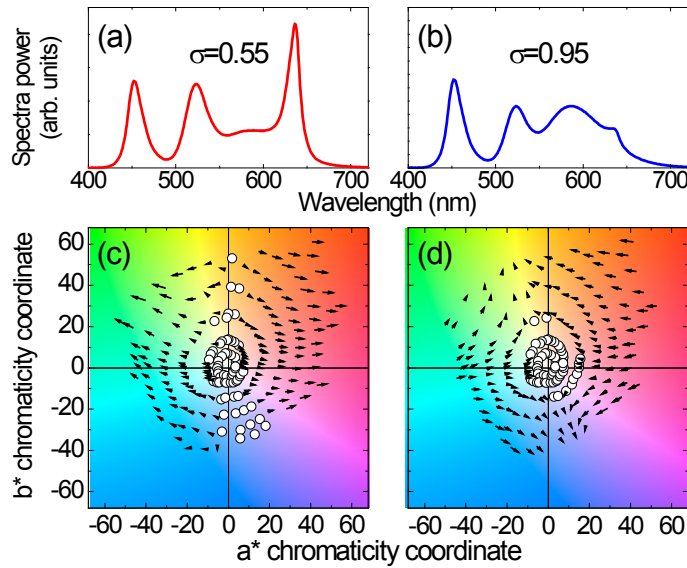

Figure 2: (a) and (b) SPDs of two RAGB blends (CCT = 4500 K) with  $R_a = 80$  and at  $\sigma = 0.55$  and  $\sigma = 0.95$ , respectively; (c) and (d) corresponding distributions of the colour-shift vectors for 218 Munsell samples of value /6 in the  $a^*-b^*$  chromaticity plane of the CIELAB colour space. Open points, samples that have colours rendered with high fidelity; arrows, schematic chromaticity shifts of samples that have increased or decreased chroma or distorted hue according to Žukauskas et al. (2009).

Table 1 summarises the colour rendition properties of the two blends. For equal values of  $R_a$ , the two blends are seen to have very similar values of CQS  $Q_f$  and of statistical CFI. The colour-saturating blend has higher values of the CQS general ( $Q_a$ ) and gamut ( $Q_g$ ) scales and a lower value of HDI. However, the two blends are distinctly distinguished by statistical CSI and CDI with values of 43% vs. 1% and 1% vs. 42%, respectively.

Table 1. Colour rendition indices of the two RAGB blends with equal  $R_a$ .

Index	$R_a$	Color Quality Scale			Statistical Metric			
		$Q_a$	$Q_f$	$Q_g$	CFI	CSI	CDI	HDI
Saturating blend	80	88	81	116	37%	43%	1%	23%
Dulling blend	80	79	79	92	36%	1%	42%	29%

#### 4. CONCLUSIONS

Our results clearly show that a set of light sources cannot be unambiguously ranked using a single colour-fidelity index. To resolve the ambiguity that we established, we suggest grouping light sources into two subsets depending on the ability to increase and reduce the chroma of rendered colours, respectively. Any colour-fidelity index, even the outdated general CRI, can be modified by adding a single symbol, which designates the dominant direction of colour shifts. For instance, the distinction between a colour saturating RGB cluster and a colour dulling phosphor conversion yellow-blue (YB) LED, both having the general CRI of 70, can be made by just using a “modified”  $R_a$  of 70S and 70D with “S” and “D” standing for “saturating” and “dulling,” respectively.

## ACKNOWLEDGEMENTS

P.V. acknowledges a postdoctoral fellowship funded by the European Union Structural Funds project "Postdoctoral Fellowship Implementation in Lithuania."

## REFERENCES

- Commission Internationale de l'Éclairage, 1995. Method of measuring and specifying colour rendering properties of light sources. *Publication of the CIE* 13.3-1995.
- Commission Internationale de l'Éclairage, 2007. Colour rendering of white LED sources. *Publication of the CIE* 177-2007.
- Davis, W., and Y. Ohno, 2010. Color quality scale. *Optical Engineering* 49(3): 033602.
- Lebedenko, D. and R. Vaicekauskas. 2013. Light source assessment. Available online, demo. [lrg.projektas.vu.lt/lcq/en/](http://lrg.projektas.vu.lt/lcq/en/). Accessed: April 19, 2013.
- Narendran, N. and L. Deng, 2002. Color rendering properties of LED sources. *Proceedings of the SPIE* 4776: 61–67.
- Rea, M.S., and J. P. Freyssinier-Nova, 2008. Color rendering: A tale of two metrics. *Color Research and Application* 33(3): 192-202.
- Žukauskas, A., R. Vaicekauskas, F. Ivanauskas, H. Vaitkevičius, P. Vitta and M.S. Shur, 2009. Statistical approach to color quality of solid-state lamps. *IEEE Journal of Selected Topics in Quantum Electronics* 15(6): 1753-1762.
- Žukauskas, A., R. Vaicekauskas, P. Vitta, A. Tuzikas, A. Petrulis and M. Shur, 2012. Color rendition engine. *Optics Express* 20(5): 5356-5367.

*Address: Prof. Artūras Žukauskas, Department of Semiconductor Optoelectronics  
Institute of Applied Research, Vilnius University,  
Saulėtekio al. 9, bldg. III, Vilnius, LT-10222, Lithuania  
E-mails: arturas.zukauskas@ff.vu.lt, rimantas.vaicekauskas@mif.vu.lt,  
pranciskus.vitta@ff.vu.lt, shurm13@gmail.com*

# Hue Correlate Stability using a Gaussian versus Rectangular Object-Colour Atlas

Hamidreza MIRZAEI, Brian FUNT  
School of Computing Science, Simon Fraser University

## ABSTRACT

The perceptual correlate to hue and the stability of its representation in the coordinates of Logvinenko's illumination-invariant object-colour atlas (Logvinenko, 2009) are investigated. Logvinenko's object-colour atlas represents the colours of objects in terms of special rectangular reflectance functions defined by 3-parameters,  $\alpha$  (chromatic purity),  $\delta$  (spectral bandwidth) and  $\lambda$  (central wavelength) describing the rectangular reflectance to which it is metameric. These parameters were shown to be approximate perceptual correlates in terms of chroma, whiteness/blackness, and hue, respectively. When the illumination changes, the mapping of object colours to the rectangular atlas coordinates is subject to a phenomenon referred to as colour stimulus shift. The perceptual correlates shift as well. The problem of colour stimulus shift is exacerbated by the fact that the atlas is based on rectangular functions. This paper explores the benefits of using the Gaussian parameterization of the object-colour atlas (Logvinenko, 2012) in terms of its robustness to colour stimulus shift and in terms of how well it maps to the perceptual correlate of hue.

## 1. INTRODUCTION

This paper compares the Gaussian parameterization (Logvinenko, 2012) of Logvinenko's object-colour atlas (Logvinenko, 2009) to its underlying 'rectangular' form in terms of the effects of colour stimulus shift and how well its central/peak wavelength parameter correlates with hue. In terms of background, it is important first to consider the relevant aspects of traditional colour atlases, Logvinenko's rectangular atlas, and his Gaussian parameterization of the rectangular atlas.

Commonly used colour spaces in the Colour Science literature, such as CIE 1931 and its derivatives, are more appropriate for representing self-luminous than reflecting objects. In the case of reflecting objects, such spaces may work well for a fixed, standard illuminant, but can lead to unsatisfactory results under different illuminants. CIELAB and related spaces include an adjustment for the illumination based on the colour stimulus (XYZ) of the perfect reflector via a von Kries scaling, but von Kries scaling can be subject to very large errors (Logvinenko, Funt, Mirzaei, & Tokunaga, 2013). The Munsell and NCS colour atlases have the advantage that they are based on sets of reflecting papers, but they also are not illuminant invariant because the perceptual distance between the papers is likely to change with a change in the illumination. For some strictly positive illuminants, in fact, it is possible that two papers will become metameric.

To address these problems, Logvinenko introduced an illumination-invariant colour atlas to represent the colour of objects (Logvinenko, 2009). He defines an object-colour atlas in terms of a special set of non-metameric, optimal spectral reflectance functions. For any sensor set and strictly positive illuminant spectral power distribution, any colour stimulus maps to a unique member of the object-colour atlas, in particular, to its metameric member under the given illuminant. The elements of Logvinenko's rectangular object-colour atlas are rect-

angular reflectance functions that are defined as a mixture of flat grey (constant reflectance of 0.5) and a rectangular optimal reflectance component taking only values 0 or 1, with at most 2 transitions between 0 and 1. Given  $\lambda_1$  and  $\lambda_2$  as transition wavelengths, it is also possible to express the optimal reflectance functions by their central wavelength  $\lambda$  and a spectral bandwidth  $\delta$ .

The 3-parameters of the atlas,  $\alpha$  (chromatic purity),  $\delta$  (spectral bandwidth) and  $\lambda$  (central wavelength) were shown (Logvinenko, 2009) to be rough perceptual correlates of chroma, whiteness/blackness, and hue, respectively. When the illumination changes, the mapping of object colours to the rectangular atlas coordinates—and hence of the perceptual correlates too—is subject to a phenomenon referred to as colour stimulus shift. Although the object-colour atlas itself is illumination invariant, this does not mean that an object’s coordinate specification within the atlas will not change with the illumination. This is simply a consequence of the fact that two objects that are metameric under one illuminant may no longer be metameric under a different illuminant. In the case of the rectangular object colour atlas, this means that the coordinates of the object may change as the object becomes metameric to a different one of the atlas’s rectangular functions.

The effect of colour stimulus shift is exacerbated by the fact that, by their very nature, the rectangular functions include two very sudden jumps, one up and the other down. In a subsequent paper, Logvinenko (Logvinenko, 2013) suggests a “wraparound” Gaussian parameterization ( $k$  scaling,  $\sigma$  standard deviation,  $\mu$  central wavelength) of the rectangular colour atlas. Since Gaussians are smooth they may mitigate the effects of colour stimulus shift.

The Gaussian parameterization uses a three-parameter wraparound Gaussian function for representing reflectance spectra. The wraparound Gaussians are defined as follows.

Let  $\Lambda = \lambda_{\max} - \lambda_{\min}$  and  $\theta = 1/\sigma^2$ . When  $\mu \leq (\lambda_{\max} + \mu_{\min})/2$  then: (1) for  $\lambda_{\min} \leq \lambda \leq \mu + \Lambda/2$ ,  $g(\lambda; k, \theta, \mu) = k \exp[-\theta(\lambda - \mu)^2]$ ; and (2) for  $\mu + \Lambda/2 \leq \lambda \leq \lambda_{\max}$ ,  $g(\lambda; k, \theta, \mu) = k \exp[-\theta(\lambda - \mu - \Lambda)^2]$ . When  $\mu \geq (\lambda_{\max} + \mu_{\min})/2$  then: (1) for  $\lambda_{\min} \leq \lambda \leq \mu - \Lambda/2$ ,  $g(\lambda; k, \theta, \mu) = k \exp[-\theta(\lambda - \mu + \Lambda)^2]$ ; and (2) for  $\mu - \Lambda/2 \leq \lambda \leq \lambda_{\max}$ ,  $g(\lambda; k, \theta, \mu) = k \exp[-\theta(\lambda - \mu)^2]$ .

Then, for  $0 \leq k \leq 1$ ,  $\lambda_{\min} \leq \mu \leq \lambda_{\max}$  and positive  $\theta$ , we have a wraparound Gaussian reflectance function. In this representation, the roles of  $\mu$  and  $\sigma$  are analogous to those of central wavelength  $\lambda$  and spectral bandwidth  $\delta$  defined in the Logvinenko’s original  $\alpha\delta\lambda$  coordinate system. We will refer to the triple  $k\sigma\mu$  as the  $k\sigma\mu$  coordinates, where  $\sigma$  stands for standard deviation, and  $\mu$  stands for the peak wavelength, and  $k$  for the scaling.

In what follows, we explore the benefits of using the Gaussian parameterization of the object-colour atlas in comparison to the original rectangular atlas in terms of its robustness to colour stimulus shift and in terms of how well it maps to the perceptual correlate of hue.

## 2. HUE CORRELATE

As shown in Figure 1, Munsell hue correlates better with the Gaussian atlas coordinate  $\mu$  than with the rectangular atlas coordinate  $\lambda$ . The combination of greater resistance to colour stimulus shift combined with better correlation with Munsell hue argues in favour of using the Gaussian parameterization of the colour atlas for a hue correlate.

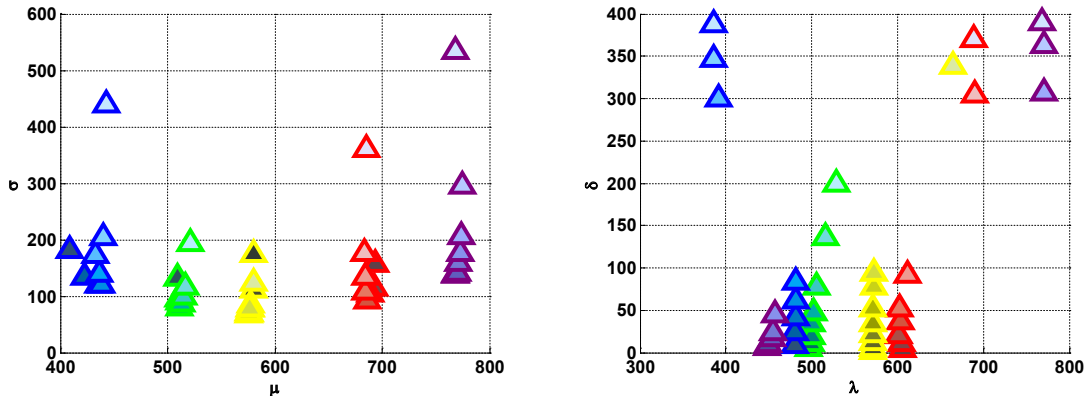

Figure 1: Colour descriptors of the Munsell papers of maximal chroma from five pages (10B, 10G, 10Y, 10R, and 10PB) of the Munsell Book of Color. Each paper is plotted as a point with Cartesian coordinates:  $\mu$  and  $\sigma$  (Gaussian) in the left panel;  $\lambda$  and  $\delta$  (rectangular) in the right panel. The boundary of each triangle is coloured based on its Munsell hue. The vertical alignment of the papers of the same Munsell hue in the left panel indicates a strong correlation between hue and the peak wavelength parameter  $\mu$ . The right panel shows some correlation between  $\lambda$  and hue, but to a much lesser extent than for  $\mu$  and hue.

### 3. COLOUR STIMULUS SHIFT IN A GAUSSIAN VERSUS RECTANGULAR OBJECT-COLOUR ATLAS

Metamer mismatching means that an object colour can move from one class of metamorphism to another when the illumination changes. Since an object's coordinates in the object-colour atlas are based on the atlas's reflectance to which it is metameric, its atlas coordinates may alter when the illumination changes. Such a shift is called the illuminant-induced color stimulus shift (Logvinenko, 2009). The apparent magnitude of the colour stimulus shift may depend on whether it is described in terms of the coordinates of the rectangular object-colour atlas versus its Gaussian parameterization.

To determine the relative stability of  $\mu$  versus  $\lambda$  coordinates under a change in illuminant, we synthesize the XYZ tristimulus values of 1600 Munsell chips under two illuminants (e.g., D65 and F11) using the colour matching functions and then determine the corresponding  $\mu$  and  $\lambda$  coordinates. Figure 2 plots the corresponding  $\mu$  and  $\lambda$  parameters superimposed. The figure shows that the  $\mu$  hue descriptor stays relatively the same regardless of whether the illuminant is F11 or D65. In the figure, the  $\lambda$  coordinates deviate from the diagonal more than their  $\mu$  counterparts. To the extent that  $\mu$  is more stable than  $\lambda$  it could potentially be a superior hue correlate. Based on circular statistics, differences of the central/peak wavelengths in nanometers for  $\mu$  are 4.7 (mean), 2.8 (median), and 114 (maximum) versus for  $\lambda$  for which they are 9.2 (mean), 4.9 (median), and 120 (maximum). The relative stability of  $\mu$  in comparison to  $\lambda$  has been found to hold for other illuminant pairs as well. For 20 Munsell papers illuminated by 15 different illumination combinations (see Fig. 3 of Logvinenko & Tokunaga (2011)) the wavelength difference in nanometers is significantly less: mean 18 versus 35, and median 25 versus 45.

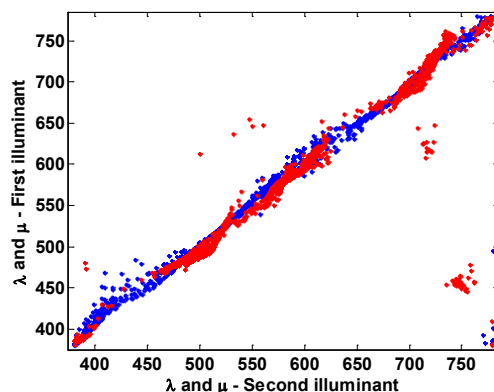

Figure 2. Comparison of  $\mu$  (blue) and  $\lambda$  (red) coordinates calculated under D65 and F11. The ordinate are values for D65 and the abscissa are values for F11. Note that due to the wraparound property of the Gaussians and the rectangular reflectances, the  $\lambda$  and  $\mu$  values near 380nm are in fact close to those at 780nm, so some of the apparent outliers are in fact not outliers.

#### 4. CONCLUSIONS

In the Gaussian parameterization of Logvinenko's object-colour atlas, the peak wavelength  $\mu$  of the wraparound Gaussian is shown to correlate well with Munsell hue. It correlates better than the central wavelength  $\lambda$  of the rectangular functions from the original colour atlas. Both  $\mu$  and  $\lambda$  have the advantage over other hue descriptors in that they are components of the coordinates in an illumination-invariant object-colour atlas. Even so, they are subject to the limits imposed by metamer mismatching, which mean that there can still be colour-stimulus shift. Tests show that the degree of colour-stimulus shift is smaller, in practice, for the Gaussian-based hue descriptor than its rectangular counterpart. Combined with the fact that it correlates better with Munsell hue, the Gaussian-based descriptor is likely to be the better choice as a perceptual correlate of hue.

#### REFERENCES

- Logvinenko, A., 2009. An object-color space. *JOV*, 9(11, Article 5), 1-23.
- Logvinenko, A., 2013. Object-colour manifold. *IJCV*, 101(1), 143-160.
- Logvinenko, A., and R. Tokunaga, 2011. Colour constancy as measured by least dissimilar matching. *Seeing and Perceiving*, 24(5), 407-452.
- Logvinenko, A., B. Funt, H. Mirzaei and R. Tokunaga, 2013. Metamer Mismatching's Impact on Colour Constancy. Under review.

*Address: Professor Brian Funt, School of Computing Science, Simon Fraser University, 8888 University Drive, Burnaby, British Columbia, Canada V5A 1S6.  
E-mails: funt@sfu.ca, hmirzaei@sfu.ca.*



# Temporal Stability of Ranks for Image Preference

Michael HARRIS, Graham FINLAYSON  
School of Computing Sciences, University of East Anglia

## ABSTRACT

When evaluating preference of image processing algorithms, we are often interested in assigning a rank order to a collection of competing algorithms. Given the administrative overhead of performing preference experiments, it is desirable to have a metric of the stability of the ranking obtained from those observers that have completed the experiment to date, in order to satisfy the question of sufficient sample size.

In this work, we use the data from existing preference experiments to show that a metric of the stability of a ranking can be determined solely from its current state. To derive this metric we use a novel perturbation analysis of the score matrix constructed during paired comparison experiments. We determine the minimum number of anomalous observers (i.e. those who are, for each comparison, voting contrary to the current consensus) which would be required to change the current ranking to a significant degree.

## 1. INTRODUCTION

Psychophysical experiments are a key part of the evaluation process of many image processing developments and yet, despite their prevalence, we still see many differing approaches to their execution; observer numbers can vary greatly, from the handful seen in (Connah *et al.* 2007), to hundreds as in (Sprow *et al.* 2009). What is desirable is some measure of the robustness of the current results of an experiment, at which point the quantity of observers attained can be deemed sufficient to draw reliable conclusions.

Over time, as data is gathered from more observers, the analyses of psychophysical experiments generally stabilise (although not always). In order to test the stability of a set of results at a given point in time, we seek to test the resilience to change by re-posing the question of “is the current quantity of observers sufficient to draw reliable conclusions?” as “assuming all new observers are in ubiquitous disagreement with the current results, how many new observers are the current data resilient to?”

The method we introduce builds upon Thurstonian (Thurstone 1927) analyses of paired comparison experiments, but it could feasibly be modified for use with other methods of analysis, or with different experimental paradigms.

## 2. METHOD

The proposed method centers on the notion of simulated *anomalous observers*. We define an anomalous observer to be an observer that votes contrarily to the current consensus. At a given point in time (after some number of real observers have completed the experiment), we seek to determine how many anomalous observers the current ranking is resilient to, or equivalently, how many anomalous observers would be required to affect significant change in the current results.

Our simple approach is to compile a preference matrix after each real-world observer completes the experiment, and then simulate the addition of anomalous observers to the

experimental results. The effect of the simulated observers on the preference matrix is calculated after each simulation and, given some significance measure, the output of our stability metric is reduced to the number of anomalous observers required to cause that significance measure to report significant change.

## 2.1 Choice of Appropriate Significance Measure

The choice of significance measure is important, and it is infeasible to suggest a measure that works in all circumstances. Given a rank ordering of the treatments under scrutiny, a simple approach would be to call any change in that ordering significant. Alternatively, a tool such as Kendall's rank correlation coefficient (Kendall 1938) could be used, with some prescriptive significance level as a threshold. In many pieces of research only rank ordering is discussed, while ignoring actual scores, and so this approach may suffice.

A problem with only considering ordinal rank correlation is that rank position swaps between treatments with only small intervals between them would be considered as equivalent to rank position swaps between treatments separated by large intervals, which in many cases would be undesirable. To address this situation a measure such as that defined by (Sprow *et al.* 2009), which is based on a chi-square test, could be employed. For these purposes, the real results can be used as the 'expected' distribution, while the results after the addition of the anomalous observers are treated as the 'observed' distribution.

In many cases, there may be certain treatments which the experimenter is more concerned with than others. If the psychophysical experiment is being carried out in order to evaluate the effectiveness of a new image processing algorithm, it may be that the experimenter only considers rank position changes concerning that particular algorithm important, and effectively ignores any changes amongst the 'also-ran' treatments. In such cases a suitable approach might be to mask the ordinal rank data to exclude the unimportant treatments before applying one of the above methods.

Any of these approaches, and many others, could be viable, depending on the task at hand. In Section 3 it is shown that the measures discussed above reveal similar trends when applied to our resilience test, although they may produce differing absolute values.

## 2.2 Creating Anomalous Observers

Once an appropriate significance measure has been chosen, the implementation of our approach is simple. First, a 'ground truth' preference matrix  $F$  is compiled from the data provided by real-world observers (this preference data may then be transformed into some other representation as required by the chosen significance measure or, if the experimenter is only concerned with a subset of the treatments, a submatrix of  $F$  may be used). If  $n$  treatments are being compared, then  $F$  is an  $n \times n$  matrix, and  $F_{ij}$  denotes the number of times algorithm  $i$  is preferred over algorithm  $j$ .

To simulate the data for one anomalous observer a new matrix  $P$  is created of the same size as  $F$  where  $P_{ij} = 1$  iff  $F_{ij} < F_{ji}$ ,  $P_{ij} = 0.5$  iff  $F_{ij} = F_{ji}$ ,  $P_{ij} = 0$  otherwise.  $P$  is then multiplied by the number of repetitions in the particular experiment - a common paradigm is to display every image pair twice. To arrive at our final quantity of anomalous observers required to affect significant change, a counter  $i = 1$  is initialised, then  $P$  is multiplied by  $i$ . The chosen significance measure is then applied to  $F$  and  $F + iP$  - if the difference is significant then exit and return  $i$ , otherwise increment  $i$  and loop until the change is significant.

### 3. RESULTS AND DISCUSSION

Figure 1 shows examples of the resilience of several rankings to anomalous observers as functions of the number of real observers. It is perhaps intuitive that, given more observations, the ranking will become more resilient, but with this new statistical tool it is now possible to quantify this observation.

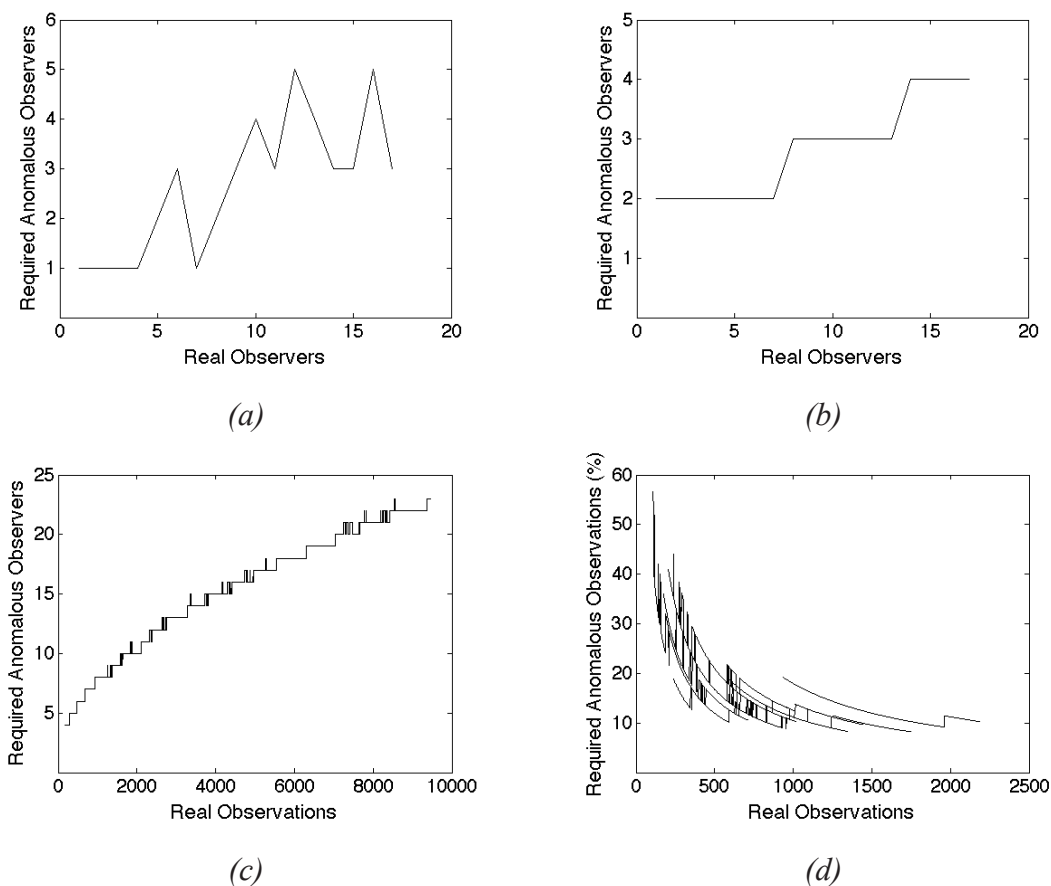

Figure 1: Resilience of rankings to anomalous observers.

Figure 1 (a-b) shows the resilience of the rankings produced by an evaluation of colour-to-greyscale operators, published in (Connah *et al.* 2007), using rank order change and the Sprow chi-squared test respectively as the significance measure. The sensitivity of the rank-ordinal approach is evident from the spikes in subfigure (a), while the benefit of the score-based approach of the Sprow measure is clear to see in (b).

Figure 1 (c) shows data taken from a large scale web-based experiment published in (Harris and Finlayson 2011). As the web-based data is unbalanced (not every observer necessarily completes every preference judgement), the x-axis in this plot shows the number of *observations* made - it is still assumed, however, that one simulated anomalous observer completes every preference choice, and so the results represent a worst-case scenario. The inclusion of these data is to show that our approach can be similarly applied to large-scale data as well as experiments with smaller observer numbers.

Figure 1 (d) depicts the required anomalous observations for a collection (differing scenes for the same collection of treatments) of web-based experiments as percentages of the current numbers of real observations. It may be unintuitive that this shows a downward trend to start with, but this is due to the initial small numbers of real observers being similar in scale to the required anomalous observers - the base case being results after one real observer

require only one anomalous observer to affect change, but in percentage terms this is 100%. Stability is achieved at approximately 10%, and so we may prescribe for future experiments that 10% is a target amount for reliable results. We repeated this analysis for another collection of web-based experiments and found similar convergence at 7%. Other experimenters may employ this metric by calculating the percentage required at some time  $t$ ; if the percentage has not changed at time  $2t$  then it may be possible to assert that sufficient observations have been made.

#### 4. CONCLUSIONS

We have presented a new technique for quantifying the resilience of a ranking from a psychophysical experiment to anomalous data, and showed how it can be used to estimate whether sufficient observers have completed a given experiment to provide reliable results and conclusions. Given an appropriate significance measure, this technique can be used to provide a worst-case estimate of the quantity of new observers required to change the results to a significant degree.

#### ACKNOWLEDGEMENTS

The support of EPSRC grant number EP/H022236/1 is gratefully acknowledged.

#### REFERENCES

- Connah, D., G.D. Finlayson, and M. Bloj, 2007. Seeing beyond luminance: A psychophysical comparison of techniques for converting colour images to greyscale. In *15th Color Imaging Conference: Color, Science, Systems and Applications, Proceedings*, Albuquerque: IS&T, 336-341.
- Harris, M.D., and G.D. Finlayson, 2011. Comparing a pair of paired comparison experiments: Examining the validity of web-based psychophysics. In *19th Color and Imaging Conference: Color Science and Engineering Systems, Technologies, and Applications, Proceedings*, San Jose: IS&T, 29-34.
- Kendall, M.G., 1938. A new measure of rank correlation. *Biometrika* 30(1): 81-93.
- Sprow, I., Z. Baranczuk, T. Stamm, and P. Zolliker. 2009. Web-based psychometric evaluation of image quality. In *SPIE 7242, Proceedings*, ed. by Susan P. Farnand and Frans Gaykema. San Jose: IS&T, 72420A1-12.
- Thurstone, L.L., 1927. A law of comparative judgment. *Psychological Review* 34(4): 273-286.

*Address: Michael Harris, School of Computing Sciences,  
University of East Anglia, Norwich Research Park, Norwich, NR4 7TJ, UK  
E-mails: michael.harris@uea.ac.uk, g.finlayson@uea.ac.uk*

# Importance and Possibilities of Objective Colour Values Usage in Colour Contrast and Colour Harmony Setting

Martinia Ira GLOGAR, Đurđica PARAC - OSTERMAN, Iva Hrvatina PRESEČAN  
University of Zagreb Faculty of Textile Technology

## ABSTRACT

In this paper, examination has been performed in order to give some answers on question could the objective colour evaluation be used as a guideline in positive colour contrast and harmonious relations setting in a process of designing coloured patterned textiles. The experimental work was based on theoretical thesis that says how knowing and understanding of scientific besides artistic nature of colour, is essential in artistic creation of a designer. The aim was to show that considering the colour in its precise, objective parameters, could assure achieving the exact wanted contrasts and relations among colours, which would be much more complicated and non precise if it would be performed based on pure subjective experience and intuitive reaction. So, the possibility of numerical (computer) colour evaluation in aim of colour placement in harmonious relations was analysed. Analysis was based on two of seven basic Johannes Itten's methodologies for colour coordination: complementary contrast and contrast of saturation. The computer base was used that contains objective numerical information of colour parameters based on CIELAB system of precise, numerical colour evaluation and position of chosen colour hues in CIELAB space ( $L^*a^*b^*$  diagram) obtained by instrumental measurement.

## 1. INTRODUCTION

The choice of colours which will assure the positive contrast and harmony of composition elements, which will influence the positive reaction and acceptance of an observer, is the key element in design (Crozier 1996, Seuntiens 2009; Pressman 2009). The unique theory of basic rules of harmony and contrasts was created by the Swiss Johannes Itten (Itten 1987; Parac-Osterman 2011). Itten defined the strategy for successful colour combining, and through his research he established seven methodologies for colour coordination based on their contrast characteristics: contrast of saturation, contrast of hue, light – dark contrast, warm – cold contrast, complementary contrast, simultaneous contrast and contrast of extension (Itten 1987; Parac-Osterman 2011). In this paper, two out of seven Itten's methodologies for successful colour contrasting were applied in a process of patterned textile designing - complementary contrast and contrast of saturation. Also, the possibility of objective colour evaluation in aim of assuring positive colour contrasts, was analysed. Using the objective evaluation of colour parameters according to CIELAB system and analyzing the position of colour in  $a^*/b^*$  space, detailed study of each parameter of colours used in designing process was performed and the possibility of objective colour consistence was investigated.

## 2. METHOD

In a process of setting the colour schemes used in designing the samples showed in this paper, the computer data base that contains the objective CIELAB numerical information of colour parameter was used. The base of colour samples, used in this paper, is showed in CIELAB colour space regarding their lightness, chroma and hue, on Figure 1.

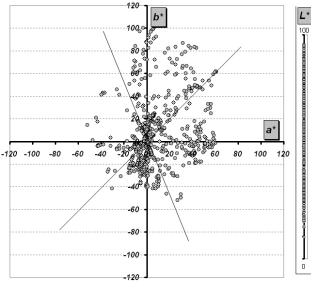

Figure 1:  $L^*a^*b^*$  colour space.

From the showed colour samples base, colour hues which are, according to their  $L^*a^*b^*$  values, in contrasted relations, were chosen and used in patterned textile designs. Designs were made in technique of computer patterning in a program that enables the input of  $L^*$ ,  $a^*$ ,  $b^*$  coordinate values according to CIELAB system, which assures precise reproduction of exact colours of defined characteristics. Results obtained in this paper are showed in tables and graphically in  $a^*/b^*$  colour space.

### 3. RESULTS AND DISCUSSION

As it was said, analysis presented in this work, was based on two methodologies for colour coordination created by Johannes Itten: a methodology of placing colours in proper complementary relations (contrast) and contrast of saturation (chroma). On Figure 2 the example of design with complementary related hues is shown. Complementary colours when they are contrasted excite each other and create the greatest contrast. According to Itten, complementary colours are located adjacent to each other on the colour wheel, so in a scope of objective evaluation it can be said that in  $a^*/b^*$  space complementary hues are placed diametrically opposite to each other considering the diagonal axis through the centre of the colour space (Figure 1). This is the approach that enables precise definition of complementary pairs for each colour hue in colour space. The exact position of hues used in sample 1 (Figure 2), in  $a^*/b^*$  colour space, is shown on Figure 3.

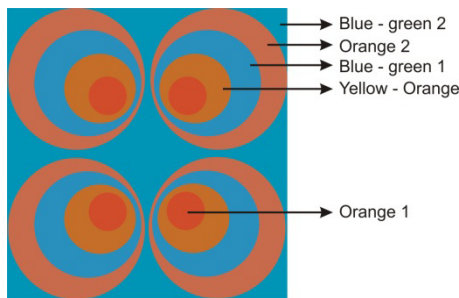

Figure 2: Sample 1 - Complementary contrast in textile patterning

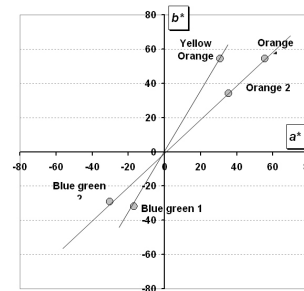

Figure 3: Position of hues from samples 1 in  $a^*/b^*$  colour space

The objective values of colour parameters according to CIELAB, are shown in Table 1.

Table 1. Objective colour parameter values for Sample 1.

Sample 1	$L^*$	$a^*$	$b^*$	$C^*$	$h^*$
Orange 1	54,64	55,70	54,27	77,76	44,25
Yellow - orange	54,93	30,90	54,48	62,63	60,43
Blue - green 1	54,73	-17,00	-32,05	36,27	242,05
Orange 2	55,00	35,41	34,08	49,14	44,24
Blue - green 2 (background)	54,88	-30,16	-29,16	41,95	224,03

It can be seen (Figure 3) that chosen hues are exactly diametrical to each other, so it can be said that they are complementary to each other. To assure greater preciseness of hues that would be exactly in opposite – complementary relations, the principle of determination was performed as follows: first the orange (Orange 1 and orange 2) ( $h^* = 44,02^\circ$ ) and yellow – orange ( $h^* = 60,62^\circ$ ) hue was chosen (Table 1). It was determined that the orange

hue is for  $45,98^\circ$  moved away from the main yellow axis  $+b^*=90^\circ$  into upper left quadrant of  $a^*/b^*$  diagram and that the yellow – orange hue is moved from the same axis for  $29,38^\circ$  (Figure 3). So the blue – green hues complementary to orange and yellow – orange were defined as hues that are exactly for the same degree values moved away from the main blue axis  $-b^*=270^\circ$  towards lower right quadrant of  $a^*/b^*$  diagram (the  $h^*$  value for blue – green 1 is  $240,62^\circ$  which is for the  $29,38^\circ$  moved from the main blue axis  $-b^*=270^\circ$ ; the  $h^*$  value fro the blue – green 2 is  $224,02^\circ$  which is for the  $45,98^\circ$  moved from the main blue axis  $-b^*=270^\circ$ ). In that way the exact, precisely defined blue – green hues, opposite to chosen yellow – orange and orange hues were defined. Based on the hue values obtained the matching colour sample was found in a data base, so the samples of blue – green colour of colour parameters values shown in Table 1 was chosen.

On Figure 4 the example of patterning with colours in contrast of saturation (chroma) is shown (Sample 2). According to Itten the positive contrast of saturation is obtained between intense and dull instances of the same hue. In a scope of objective terminology it can be seen that with precise determination of the different chroma values for the same hue and lightness, the positive contrast of chroma will be obtained. The objective values of colour parameters for Sample 2 are shown in Table 2.

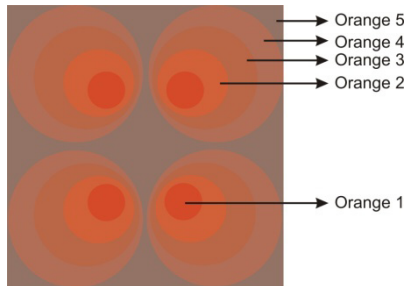

Figure 4: Sample 2 – Chroma contrast in textile patterning

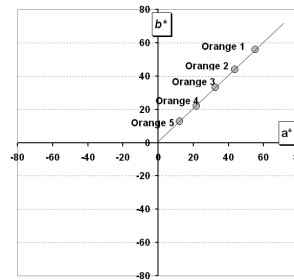

Figure 5: Position of hues from samples 2 in  $a^*/b^*$  colour space

Table 2. Objective colour parameter values for Sample 2.

Sample 2	L*	a*	b*	C*	h*
Orange 1	52,02	55,23	55,98	78,63	45,18
Orange 2	54,85	43,67	44,02	62	45,22
Orange 3	52,32	32,62	33,03	46,42	45,32
Orange 4	53,65	21,74	22,02	30,94	45,36
Orange 5	52,31	12,36	12,65	17,68	45,66

Using different chroma values for the same hue and maintaining the similar levels of lightness, the smooth transition between shades and their mutual interference were provided achieving the effect of depth and three – dimensionality. Objective difference values (Table 3) show certain lightness differences, but in a scope of visual experience these differences are not significant. It can be said that criteria of maintaining the constant level of lightness was satisfied.

Table 3. Objective  $dL^*$  and  $dC^*$  values between shades of orange in Sample 2.

	$dL^*$	$dC^*$
Orange 2/Orange 1	2,83	-16,63
Orange 3/Orange 2	-2,53	-15,58
Orange 4/Orange 3	1,33	-15,48
Orange 5/Orange 4	-1,34	-13,26

Chroma differences between shades of orange show that minimal gradation of chroma interval scale must be set on 10 difference units in order to assure the visual experience of harmonious shade gradation from pure chromatic to achromatic. Such approach of using the objective colour parameter values and parameters differences assure the exact relations of colours and shades in designing process, as well as obtaining the change of exact wanted colour parameter.

#### 4. CONCLUSIONS

It has been showed that the CIELAB objective system for precise, numerical evaluation of colour parameters and positioning of colours in  $a^*/b^*$  coordinate space, can be used as a guideline in positive colour contrast and harmonious relations setting in a process of designing coloured patterned textiles. It has been confirmed that, the matching relations of hues and their setting in harmonious and contrast relations following the principles of Johannes Itten strategy, can be performed with greater preciseness if it is based on objective colour values. Finally it can be said that the knowledge of objective colour parameter and their differences evaluation, recognition of scientific besides artistic nature of colour, is essential in artistic creation of a designer. Based on such knowledge and analyses, designer is able to properly decide would it be in the aim of successful realisation of his/hers fashion design to follow the objective criteria or not.

#### ACKNOWLEDGEMENT

This paper is presented as a smaller part of the analyses and research performed in graduate thesis of undergraduate student Iva Hrvatina Presečan, University of Zagreb Faculty of Textile – Technology, Zagreb, Croatia.

#### REFERENCES

- Crozier, W.R. 1996. The Psychology of Colour Preferences, *Rev. Prog. Coloration*, 26 63-71.
- Seuntiens, J.H.P. 2009. Vogels, M.L.C.I.: How to Create Appealing Spatial Color Gradients, *Proceedings of the 11<sup>th</sup> Congress of the International Colour Association*, Smith, D.; Green-Armytage, P.; Pope, M.; Harkness, N. (Ed.), Sydney: Colour Society of Australia, Sydney, Australia, ISBN: 1-877040-76-2
- Pressman, L. 2009. The Magical Business of Colour: The Psychology Behind Integrating Colour into Design Strategy, *Proceedings of the 11<sup>th</sup> Congress of the International Colour Association*, Smith, D.; Green-Armytage, P.; Pope, M.; Harkness, N. (Ed.), Sydney: Colour Society of Australia, Sydney, Australia, ISBN: 1-877040-76-2
- Itten, J. 1987. *The Elements of Color*, John Wiley & Sons Inc., Germany
- Parac-Osterman, Đ.; Glogar, M.I. 2011. Colour and Design: Between Art and Science, *Proceedings of The 4<sup>th</sup> International Symposium Textile Science and Economy*, Željko, P.; Ujević, D. (Eds.), Zagreb, University of Zagreb Faculty of Textile – Technology, 67-72, ISBN: 978-953-7105-39-6

*Address: Martinia Ira Glogar, Ph.D., Assit. Prof. University of Zagreb  
Faculty of Textile Technology, Prilaz baruna Filipovica 28a, 10000 Zagreb, Croatia  
E-mail: martinia.glogar@tff.hr*



# TAPOS: A Tactile Pattern Order System for Blind People

Shuo-Ting WEI  
School of Design, TransWorld University, Taiwan

## ABSTRACT

This paper describes the results of a pilot study to test the learnability of the TAPOS, i.e. the Tactile Pattern Order System. The TAPOS used bulged patterns to systematically label hues and tones, which can be used to convey graphic information through touching. A training session, two post-training sessions and a generalisation session were designed to test the learnability of the TAPOS. As a result, subjects required about 15 minutes to learn the structure of the system. 45 minutes were required to associate bulged patterns with colours. The accuracy of the two post-training sessions was 100%. However, both subjects spent more time to complete the second post-training session (8.5 mins) than the first one (7 mins). The generalisation session is still in progress. According to the experimenter's observation, the required time to detect graphic information varies across samples of different shapes and bulged patterns. Samples with more complicated patterns required more time to detect the graphic information.

## 1. INTRODUCTION

Braille is a tactile reading/writing system which transforms letters into bulged dots. This system provides a channel for blind people to obtain information through touching. Braille only works for verbal information and cannot be used to transform graphic information. A recently developed tactile order system, TAPOS, used bulged patterns to systematically label hues and tones. For blind people, it can be used to perceive graphic information through touching (Wei, 2013).

The TAPOS is developed on the basis of the structure of the PCCS (Japan Color Research Institute, 1964). The system is composed of two parts: a hue circle and a plane of tones that represents lightness and chroma. Unlike the PCCS which specifies hundreds of colours in the system, the TAPOS only specifies eight hues across four tones and three achromatic colours: white (W), gray (Gy) and black (Bk). The eight hues are red (R), orange (O), yellow (Y), yellowish green (yG), green (G), greenish blue (gB), blue (B) and purple (P). For each hue, the four tones are vivid (V), light (L), soft (S) and deep (D). Hues and tones are specified systematically using lines and lines with dots. Their widths are of 3 levels: 1mm, 3mm and 5mm. The width of gaps between lines is specified by 4mm, which is slightly larger than the tactile spatial resolutions of hands (Weinstein, 1968; Boven *et al.*, 2000).

As shown in Figure 1, red (R) is represented by horizontal straight lines, whereas the complementary colour, green (G), is represented by horizontal lines with dots (same orientation, different patterns). When a colour changes from red (R) to yellow (Y) and yellowish green (yG), the orientation of the straight lines tilts counter-clockwise. The same is true when a colour changes from green (G) to blue (B) and purple (P): the patterns tilt gradually as the colour changes. Figure 2 shows the plane of tones and the patterns used. The four tones are defined by the thickness of the lines. The lines became thicker when the colours became darker. The soft colors (S) are specified by the dashed lines. Dots of different sizes

represent achromatic colours white (W), gray (Gy) and black (Bk).

The current study aims to test learnability of the TAPOS. Learnability refers to how easy it is for people to learn the system, which is measured by times of required learning sessions. Note that this paper describes the results of a piloting, where only two sighted subjects were recruited to test the learnability of the system. The main test for blind people is still in progress. As Boven *et al.* (2000) reported that the tactile sensitivity of blind people was higher than that of sighted people, it is expected that the TAPOS would be easier for blind people to learn.

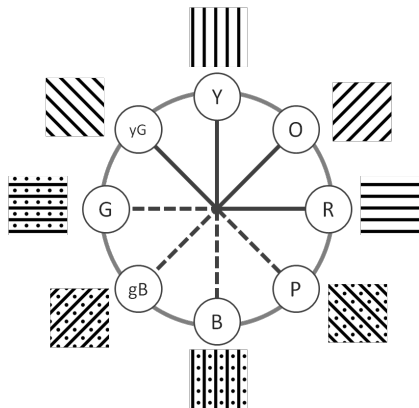

Figure 1: The eight hues and their tactile patterns.

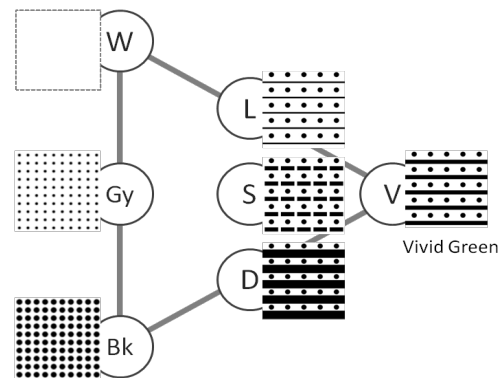

Figure 2: White, gray, black and the four tones and their tactile patterns (green).

## 2. PROCEDURE OF TESTING TAPOS

Two 18-year-old students with normal vision were trained with the TAPOS. By the end of training, two post-training sessions and a generalisation session were provided. Figure 3 shows the procedure of TAPOS training and testing.

During the training session, the subjects used body movement to learn the structure of the TAPOS. A step-by-step approach is given below:

Step 1: Learning the achromatic axis of the TAPOS – The subjects were asked to imagine their own body as the achromatic axis, in which the colour white locates on the top of their heads and black locates on the bottom of their feet, see Figure 4(a). Subsequently, they were asked to use their hands to point out the locations of the colours W, Gy and Bk.

Step 2: Learning the hue circle – The subjects were asked to imagine a colour circle surrounding their body about the height of chest, see Figure 4(b). They were then asked to use hands again to point out the locations of vivid colours R, O, Y, yG, G, gB, B and P.

Step 3: Learning the colour tones – The subjects were asked to imagine another three circles surrounding their body. One circle on the top of their head is for light colours (Figure 4(c)), one circle about the height of thigh is for deep colours (Figure 4(d)) and the other circle is for soft colours (Figure 4(d)). The circle for soft colours is about the height of the chest, and its radius is smaller than that of the circle for vivid colours. The subjects were then asked to use their hands to point out locations of colours of different tones.

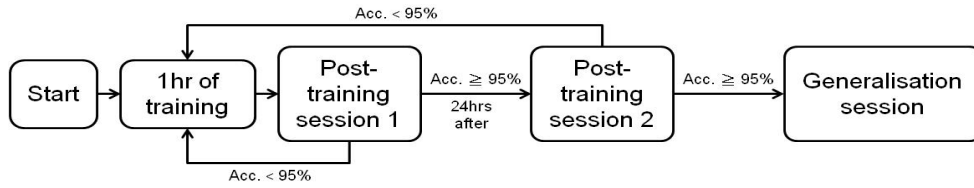

Figure 3: The procedure of TAPOS training and testing.

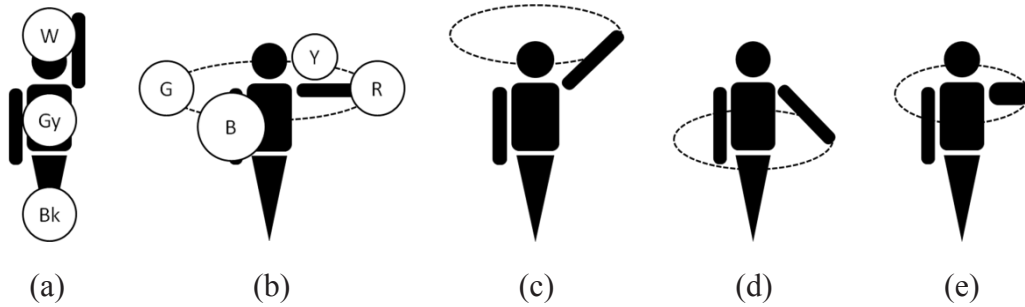

Figure 4: The concept figures of learning TAPOS using body movement.

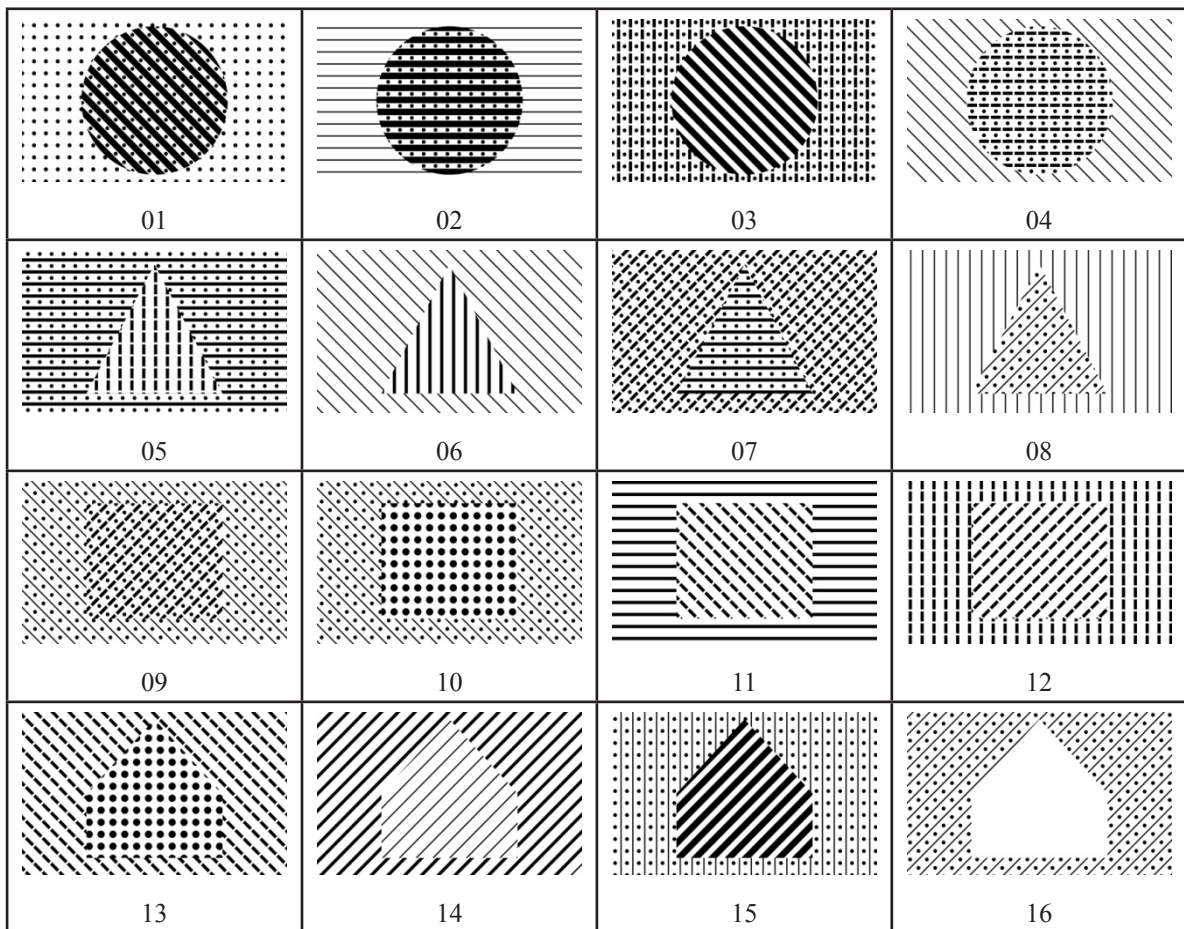

Figure 5: The 16 cards with bulged patterns used in the generalisation session.

Subsequently, the subjects with their eyes masked were asked to associate the bulged patterns with colours. During this session, experimenter frequently reminded them to associate orientation and thickness of the patterns with hue angle and lightness, respectively. The

subjects were also reminded the continuity of the patterns, so as to distinguish vivid colours from soft colours.

The training session lasted for an hour. After training, the subjects were asked to identify colours of the 35 bulged patterns, i.e. 8 hues across 4 tones plus 3 achromatic colours. They were considered proficient in the TAPOS if they reached 95% of accuracy in the initial post-training session and a second post-training session taking place 24 hours later. Subjects who are proficient in the TAPOS proceeded to the generalisation test, in which they described the graphic information of 16 samples with different shapes and bulged patterns (see Figure 5). For example, the graphic information of the card no.6 is “A yellow triangle on a light yellowish green background”. Before the generalisation session began, the subjects were asked to detect graphic information using 10 different samples as a practice.

### 3. RESULTS

Both subjects were successfully trained with the TAPOS. In average, they spent 15 minutes learning the structure of the system and 45 minutes to associate bulged patterns with the corresponding colours. They reported that the orientation of the patterns is easier to be perceived compared with the thickness and the continuity of the patterns. The results of the first post-training session show that both subjects’ accuracy to associate patterns with colours was 100%. The accuracy of the second post-training session was also 100%. However, both subjects spent more time to complete the second post-training session (8.5 mins) than the first one (7 mins). This means that both subjects required more time to remind themselves the structure of the TAPOS in the second post-training session.

The generalisation session is still in progress. According to the experimenter’s observation, the required time for subjects to detect graphic information varies across samples. Samples with complicated patterns required more time to detect their graphic information.

### REFERENCES

- Boven, R.W., R.H. Hamilton, T. Kauffman, J.P. Keenan, and A. Pascual–Leone, 2000. Tactile spatial resolution in blind Braille readers. *Neurology*, 54, 2230-2236.
- Japan Color Research Institute, 1964. *Practical Color Co-ordinate System*.
- Wei, S.T., 2013. Developing a Tactile Pattern Order System, *Proceedings of the 2013 International Conference on Cultural Creativity & Innovative Design*, Taiwan.
- Weinstein, S., 1968. Intensive and Extensive Aspects of Tactile Sensitivity as a Function of Body Part, Sex and Laterality, the *First International Symposium on the Skin Senses*, 195-218.

*Address: Assistant Prof. Shuo-Ting Wei, School of Design, TransWorld University,  
No. 1221, Zhennan Rd., Douliu City, Yunlin County, 640, Taiwan  
E-mail: tim.stw@gmail.com*

# A Method for Picture Colour Content Description

Nijoo DUBEY,<sup>1</sup> Romain BACHY,<sup>2</sup> Naina JAIN,<sup>1</sup> Valérie BONNARDEL<sup>1,3</sup>

<sup>1</sup>AP-NID Colour Research Lab, National Institute of Design, Ahmedabad, India

<sup>2</sup>Graduate Center for Vision Research, SUNY College of Optometry, New York, USA

<sup>3</sup>University of Winchester, Winchester, United Kingdom

## ABSTRACT

This paper describes two methods used to determine colour identity of a categorically homogeneous set of pictures (e. g. Indian's markets). From a picture set, the 3S method involves visual selection while the computational method consists in the digital processing of pictures' colour content. Both methods extract dominant colour categories with their representativity and derive a colour palette. The speed of processing of the computational method, while providing similar results to the 3S method, will be useful to professionals who seek an easy and rapid way to determine the picture set colour identity.

## 1. INTRODUCTION

In order to study the regional diversity in usage of colour in traditional markets, a method for visual documentation of colour was developed to provide quantitative and qualitative description of the site. The 3S technique consisted in three steps; Snapshot, Snippet and Stamp (Figure 1). From multiple discrete snapshots (see Method section), snippets exhibiting representative colours were selected and grouped into distinct colour categories. In each colour category the number of snippets was recorded (quantitative description). Then from each snippet, a stamp was generated using the sRGB values available in Adobe Illustrator CS2 and a mini-palette representing the prevalent range of colour in a given site was derived (qualitative description).



*Figure 1: The 3S technique provides a quantitative and qualitative description of the prevalent colours of a site.*

Based on the 3S method objectives, we have developed a computational method to extract dominant colours and colour palette from a picture set.

## 2. METHOD

The raw material collection phase consisted in taking photographs from specific environments that, for our purpose, were Indian markets in Bengaluru and New Delhi. On each site, more than 400 pictures were taken with a Nikon D60 Camera during April-June 2009 between 10:00 am and 2:00 pm. Pictures were sorted in different semantic categories such as 'fruits', 'vegetables', 'objects', 'shops and buildings' and 'people'. The present study is limited to 'people' category.

In the computational phase, a ‘super-image’ was synthesized from categorized stack of 193 people\_Bangalore and 150 people\_New Delhi pictures. Each picture was reduced to a 50×50 pixels image format so their chromaticities defined in sRGB were spatially averaged. The super-image colour description was extracted according to a MPEG-7 Dominant Color Descriptor (DCD) procedure (Manjunath et al. 2001; Sikora 2001). Pixel chromaticities were partitioned into 10 clusters (i.e. colour categories) that corresponded to 8 basic chromatic and 2 neutral categories. Clusters’ size was determined using a k-means clustering algorithm (Matlab), which minimizes within each cluster the sum of the point-to-cluster-centroid distance using an Euclidean metric in the u’ v’ diagram (MacDonald, 2012). Luminance for each category was kept at a constant mean level (Figure 2).

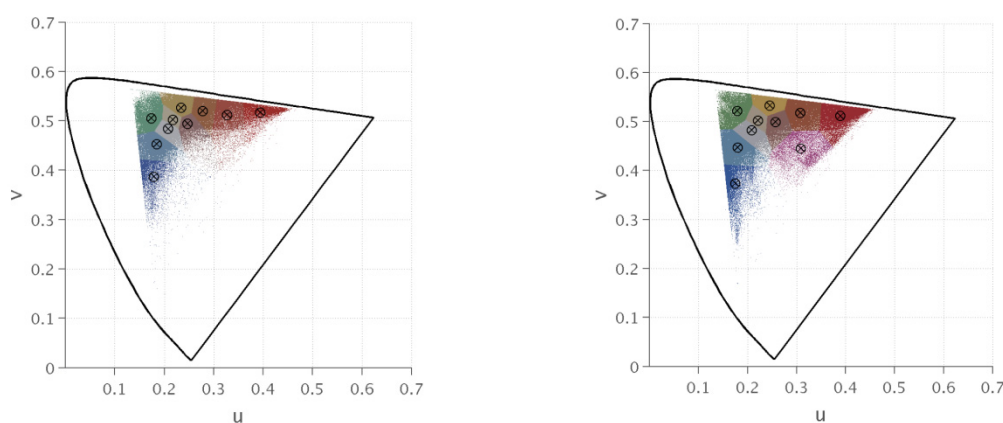

Figure 2: Overall pixel chromaticities ( $N=375,000$ ) for people-New Delhi (right) and people\_Bangalore ( $N=482,500$ ) categories plotted in 1976 UCS CIELUV. The mean position of all chromaticities for each category (centroid) is indicated by the circle’s center.

### 3. RESULTS AND DISCUSSION

Pixel density for each colour category is plotted in Figure 3. For the two markets, more than 50% of pixel densities belong to neutral colour categories. The eight remaining categories can be described from the highest to the lowest pixel density as Brown (9.2%), Blue-Green (8.1%), Yellow (7.8%), Orange (6%), Red (5.1%), Green (3.4%), Blue (2.2%) and Purple (1.7%) for Bangalore and Chartreuse (10%), Brown (8.5%), Yellow (7.2%), Blue-Green (7%), Green (5.8%), Orange (4%), Red (2.2%) and Blue (1.8%) in New Delhi. It is worth noting that the Berlin and Kay (1969) four primary basic categories (Red, Green, Yellow, Blue) were extracted in the two set of pictures. Additionally, two secondary basic (Brown and Orange) and one non-basic colour category (Blue-green) were common to the two market places. Purple, a secondary-basic colour category, is specific to Bangalor, while Chartreuse, a non-basic colour category, is specific to New Delhi.

Comparison in the relative representativity of each colour categories between 3S and computational methods is provided in Table 1. Comparison was limited to colour categories common to the two methods, that is, the 4 primary basic colour categories plus Brown. Furthermore, two categories from the computational method were aggregated to make one category derived from snippets perceptual categorization.

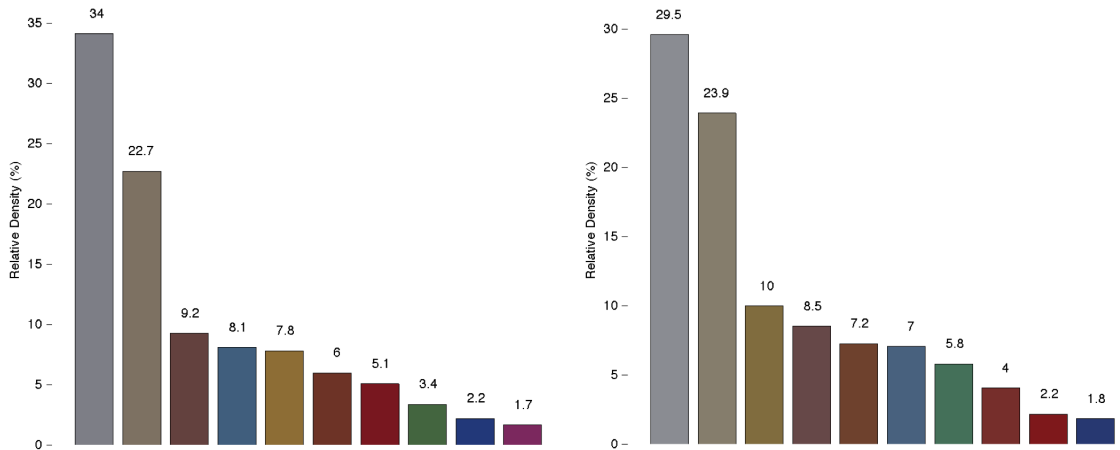

Figure 3: The relative pixel density is plotted for each cluster for people New Delhi (right) and people\_Bangalore.

The two methods agreed on Blue (or Blue + Blue-Green) to be the dominant category for Bangalore, and Yellow (or Yellow + Chartreuse) for New Delhi. There was also an agreement for Red to be the second dominant category for Bangalore. However, the computational method extracted Green + Blue-Green as the second category in New Delhi instead of Red obtained in the 3S method. The two methods also disagreed on the Brown rank order, which is the last the 3S method but the third in the computational method.

Table 1: 3S and computational methods colour category rank order.

Bangalore		New Delhi	
Snippets (140)	Super-image (482500 pixels)	Snippets (70)	Super-image (375000 pixels)
Blue	1-[Blue+Blue-Green]	Yellow	1- [Chartreuse+Yellow]
Red	2-[Red+Orange]	Red	4- [Red+Orange]
Yellow	4-[Yellow]	Green	2-[Green+Blue-Green]
Green	5-[Green]	Blue	5- [Blue+Blue-Green]
Brown	3-[Brown]	Brown	3-[Brown]

A colour palette was derived for each colour category at a mean and high luminance levels. Colours are respectively located at  $\pm 25\%$  the mean luminance and between the mean luminance and 87.5% of the highest luminance. Each palette is a 3x3 colour matrix. Columns represent three hue-azimuths, with left and rightmost corresponding to near border colour category and the middle to the category centroid. Rows from top to bottom correspond to minimum, medium and maximum chroma. Palettes derived by the two methods bear similarities; across the two luminance levels, half of the samples extracted by the computational method are close matches of those obtained with the 3S method. It is the highest luminance samples that, in our example, were not retrieved by the computational method (Figure 4).

	Yellow			Red		
	3S method	Computational method		3S method	Computational method	
		High Luminance	Mean Luminance		High Luminance	Mean Luminance
Bangalore						
New Delhi						

Figure 4: Palette derived from 3S (leftmost columns) and the computational method (middle and right columns).

#### 4. CONCLUSIONS

The 3S method provides a methodological outline to the operator who needs both a quantitative (snippet numbers) and qualitative (colour palette) colour description from a given set of picture. The same outline was used in the proposed computational approach using an automatic process. Compared to the 3S method, a large number of pictures is rapidly processed with the statistical description of dominant colour categories directly based on their pixel number. Besides, colour palettes similar to those obtained by visual selection can also be derived by the computational method. Hence this method provides a fast and powerful way to extract a colour dictionary from the digital analysis of picture colour properties.

#### REFERENCES

- Berlin, B., and P. Kay, 1969. *Basic color terms: their universality and evolution*. Berkeley: University of California Press.
- Harrar, M., and F. Viénot, 2006. Regulation of chromatic induction by neighboring images. *J. Opt. Soc. Am. A.* (22), 2197-2206.
- MacDonald, L., 2012. The influence of background on colour harmony. *AIC2012. Colour and Environment, mid-term meeting of the International Colour Association, Conference Proceedings*. 144-147.
- Manjunath, B.S., J-R. Ohm, V.V. Vasudevan and A. Yamada, 2001. Color and texture descriptors. *IEEE Trans. Circ. & Syst. For Video Tech.* (6). 703-715.
- Sikora, T., 2001. The MPEG-7 Visual Standard for content description – An overview. *IEEE Trans. Circ. & Syst. For Video Tech.* (6). 696-702.

Address: Nijoo Dubey, National Institute of Design, Ahmedabad, India  
 E-mails: nijoo@nid.edu, rbachy@sunyopt.edu,  
 naina@nid.edu, valerie.bonnardel@winchester.ac.uk



# Colouring of the Surfaces of Three-dimensional Polytopes (The Four-Colour Theorem)

Kholoud BARTAFI, Stephen WESTLAND, Vien CHEUNG  
School of Design, University of Leeds

## ABSTRACT

The four-colour map theorem states that, given any separation of a plane into contiguous regions, producing a figure called a map, no more than four colours are required to colour the regions of the map so that no two adjacent regions have the same colour. Two regions are considered to be adjacent if they share a common boundary that is not a corner (a point shared by three or more regions). The theorem was proposed in the 1850s and became the first theorem to be proved by computational methods in the 1970s. Despite the theorem being true, some geopolitical maps require more than four colours (if, for example, some regions are not contiguous) and the theorem has never been of great interest to mapmakers. This paper describes the theorem and explores how it could be extended to three dimensions. We restrict our study to the colouring of the surfaces of three-dimensional polytopes or polyhedra, specifically those that are convex. An analysis of the relationship between two-dimensional maps and three-dimensional surfaces is presented with regard to the minimum number of colours required. Visual examples are provided for regular polyhedral of increasing number of polygonal faces.

## 1. INTRODUCTION

For centuries the discussion on the idea of the four-colour theorem (4CT) caused controversy between scientists and mathematicians. The aim of this study is to investigate colouring of three-dimensional surfaces. Firstly, the concept and history of the 4CT is introduced. Differentiations and analysis between two-dimensional maps and three-dimensional surfaces are then presented. Finally, illustrative material will help to address the minimum number of colours needed to colour different polytopic surfaces and the implications of this to the field of the design will be discussed.

The famous 4CT is that a given map can be coloured with no more than four colours on its regions given the constraint that no two adjacent regions can be coloured by the same colour. The idea was first stated as far back as 1852 by Guthrie who realised that it is enough for most maps to be four-colourable and tried to find if that would be true for all maps; he later coined the term *four-colour conjecture* (4CC). He also discovered that there is a relation between vertices and edges such that each edge in map is incident with two vertices called a loop. Although he was the first to discover the theorem, he could not prove its existence; the 4CT was not accepted for another 100 years.

The first proof was attempted manually but the conjecture remained open and was not successfully proven until 1976 when Appel and Haken broke new ground by using computer programs to analyse more than 10,000 cases which took around 1200 hours to be analysed (Claude 2000). Unfortunately it was not fully accepted largely because the program they used was difficult to relate precisely to the formal statement of the mathematical theorem; the computer proof has not been corroborated by a more traditional approach.

## 2. METHOD

In order to analyse 2-D and 3-D patterns it is important to define all the concepts involved in this paper. Firstly,  $M$  for map,  $V$  for vertices,  $E$  means edges and  $F$  considering faces, and  $G$  means graph. Any plane with contiguous regions presents a map and the 4CT states that no more than four colours are required to colour each region under the condition that no two adjacent regions have the same colour. Like-coloured regions can share a point vertex but not an edge. The conjecture  $c$  made by Guthrie can be stated that  $c: v(G) \rightarrow \{0, 1, 2, 3\}$  which means that for every edge of  $G$  with ends of  $u$  and  $v$ ,  $c(u) \neq c(v)$  (Bleecker 1996).

Regular polyhedra or polytopes can be generated in any number of dimensions. A polygon is an example of a 2-D polytope whereas a polyhedron polytope is 3-D type. In this paper a proof of the 4CT in the 3-D case is considered from a design perspective with more complete independent hand-checking, which could be easier and clear to understand all readers. As our focuses is on the artistic, imaginative and creative aspect rather than mathematical, we deformed the regular convex polyhedron with more  $E$  and  $V$  than the original, but have the same geometry and same angle. The portions of  $F$  increased lead also to a net increase. Therefore, for a surface  $a$  it required  $n$  different colours at the condition that no two adjacent  $E$  has the same colour. For example, the dodecahedron in Figure 1 we added one diagonal  $E$  across each  $F$ , connecting existing  $V$  and, particularly, it has the same faces and has twenty vertices. Whereas, for the tetrahedron we add  $V$  along some  $E$  in some  $F$ . Figures 1 and 2 illustrate a 3-D model of the dodecahedron and the tetrahedron and the unfolded net with different subdivisions.

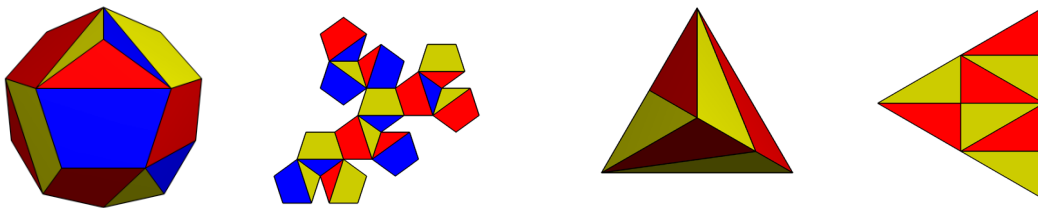

Figure 1: Three-colourable dodecahedron. Figure 2: Two-colourable tetrahedron.

Next, Figures 3, 4 and 5 present the cube, icosahedron and the octahedron as 3-D models with each unfolded net. All the three shapes have no changes in its  $F$ ,  $V$  or  $E$  number, and can be coloured with three or less colours.

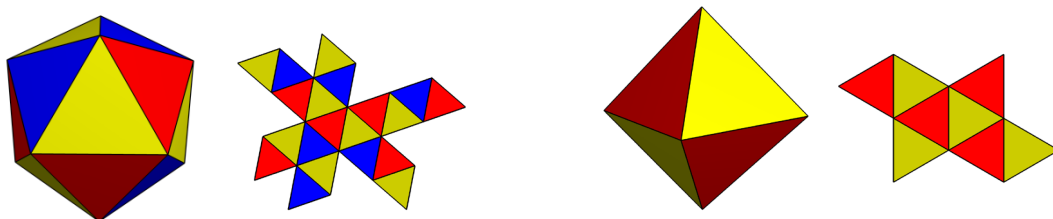

Figure 3: Three-colourable icosahedrons. Figure 4: Two-colourable octahedron.

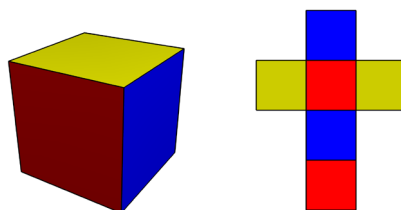

Figure 5: Three-colourable cube.

### 3. RESULTS AND DISCUSSION

Most work that has addressed extending 4CT to 3-D has considered solids (rather than surfaces) and the question of whether they share an  $F$  (rather than an  $E$ ). Of course, for the 2-D or 3-D surface, it can be always subdivide such that each  $N$ -sided face becomes  $N+1$  faces by connecting midpoints of subsequent  $E$ , creating  $N$  triangles around the  $E$ , plus one new  $N$ -gon in the middle (in this case  $N$  is the new vertices); then, we can colour all the triangles the same as the original face, and give the inner face any other colour thus maintaining the same number of colours as we aimed. Also, if the face is not a triangle, it divides the  $N$ -gon into  $N$  triangles with an extra vertex at the face's centre. Then each edge is divided into  $L$  segments, where  $L$  is the subdivision level chosen and the new  $V$  connected with new  $E$ . From view point of this study, It seems that the possibilities of colouring regular polyhedral with increasing number of polygonal  $F$ ,  $E$  or  $V$  seems to be easier when having symmetries background, especially that the same manner could be extended from the 2-D planned (regular repeating) design in to 3-D surfaces.

Finally, Figure 6 illustrates an example of how such an extension could apply to the field of design. The example considered the developments beyond the 2-D plane to a 3-D surface by wrapping net to create the complete design of the dodecahedron. Mostly, just two colours are required within the whole shape, but a 3rd one is needed to counterchange between colours. Figure 6 has a dodecahedron with three subdivisions along each  $E$  coloured with no more than three colours under the condition that no two adjacent  $E$  have the same colour.

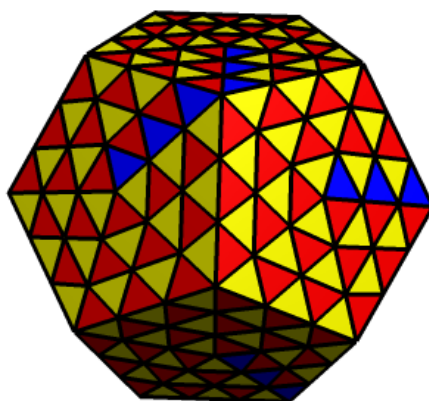

Figure 6: Three-colourable dodecahedron.

### 4. CONCLUSIONS

Undoubtedly, the significant help of computers lead Appel and Haken to prove the four-colour theorem. Nevertheless, computer programmes are known to be error-prone, and it is not easy to check the theorem using formal mathematics. Commencing this point, it might said that maybe because of the complex strategy and mathematical approached which has been used so far trying to solve and understand this theorem, it might be the case that needs a simple strategy and creative sense with artistic intuition involving artist or designers. Further, the systematic colouring of 2-D repeating design resulted in limited number of colour combinations, and the application of two colours in conjunction with one or two fundamental symmetry, which appeared on the polyhedron faces. Also, considering the 3-D surface is

a similar manner as observed in 2-D. The problem appears of a solid shapes rather than applying colour to the shapes faces which seems to works on certain 3-D shapes. Moreover the extension proved that it is possible for the regular polyhedral shapes to be three colourable surfaces with consideration of the basic of the 4CT.

#### REFERENCES

- Claude, A.S., 2000. The Journey of the Four Colour Theorem Through Time, New Zealand *Mathematics Magazine* 38(3) 27-35.
- Bleecker, D.B., 1996. Volume Increasing Isometric Deformations of Convex Polyhedra. *J. Differential Geometry* 43 505-526.

*Address: Kholoud Batarfi, School of Design,  
University of Leeds, Leeds LS2 9JT, UK  
E-mails: ml08kamb@leeds.ac.uk,  
s.westland@leeds.ac.uk, t.l.v.cheung@leeds.ac.uk*

# Colour Selection Strategies in Colour Design

Philip HENRY, Stephen WESTLAND, Vien CHEUNG  
School of Design, University of Leeds

## ABSTRACT

Our evolving hypothesis is that a colour-picker interface designed to challenge the novice user will better connect with their creative abilities and help develop their understanding of the interrelated digital colour challenges. An interface approach underpinned by a philosophy of *engaging-in-use* rather than *ease-of-use* may help to better rationalize a new user's colour-selection process, thus improving their initial productivity and creativity within the digital design environment. This study challenges the established HCI (Human Computer Interaction) convention that consistently prescribes to a user-interface-strategy embracing *ease-of-use*. It considers if this ideal is necessarily the right approach for creative software application, assessing colour-pickers as the primary example. Interesting results are emerging from experimental work with an early prototype colour-picker tool that exploits our ongoing research into intuitive understanding of colour. The focus of this work is the creative colour selection process and not colour management *per se*, however it is recognised that the relationship between these two design and technical processes is not always mutually exclusive.

## 1. INTRODUCTION

The use of digital design can lead to increased creative productivity and improved communication. Software products are invariably introduced as intuitive and easy-to-use, highlighting the opportunities for experimentation, refinement and the overall increased creative productivity. These claims lend themselves particularly well to the example of colour development (what could be easier than simply picking a colour from the monitor screen?). While a software package overall may have a relatively steep learning-curve, the colour functionality offered can be easily accessed; familiar point-and-click interfaces facilitate a wide range of colour choice from the full monitor gamut and, in principle, the opportunity to enhance creativity. Yet new users often experience frustration and disappointment when their colour expectations are not delivered. Whilst the offered coloration processes are certainly accessible at an accelerated rate, when compared to the traditional craft-based colour techniques, it is readily observed that inexperienced users seldom demonstrate a similar level of aesthetic judgment as when engaging with the more familiar physical colorants, inks and paints etc., nor do they understand the mismatch between electronic display and hardcopy.

## 2. REVIEW

The concept that intuitive understanding is a primary qualifier for an *ease-of-use* experience is a well-established principle. In the field of digital colour interaction and colour-picker interface design Hue-based arrangements configured with Chroma and Lightness scales (or the comparable Saturation and Value etc.) are thought to best fulfil this usability requirement. These colour attributes are considered more perceptive/natural as they relate to the concepts of human vision and perception; Young and Helmholtz Trichromatic theory (Fairchild 2005), Opponent-based models are deemed intuitive on the same basis. Interestingly however, an early investigation into user performance with different colour-picker models

was conducted by Schwarz and colleagues (Schwarz & Beatty 1987). Their objective was to certify the hypothesis that the hardware-oriented RGB system is not as user friendly for inexperienced users as the more intuitive HSV colour-picker model based on perceptual colour order systems, namely the Munsell and NCS systems. With regards to this general question the results were inconclusive. However, Schwarz identified a two-phase learning strategy, the convergence stage and the refinement stage; RGB would appear to be more intuitive at the earlier stage of targeting colour areas while the Hue model was more accurate, and therefore intuitive, while fine tuning colour selection whilst learning the systems. The Schwarz work also demonstrated that there was little statistical difference in the convergence learning analysis between several colour models, including HSV and an Opponent structure, strongly suggesting that the inexperienced subjects had no existing schemas or indeed intuitive understanding for any of the colour models.

Although recognized for its rigour and uniqueness the lack of visual feedback in the Schwarz & Beatty study was noted by Douglas and Kirkpatrick (1996). Their hypothesis is that visual feedback from the user interface is the most important aspect in relation to the usability of a colour model. Their experiment was also designed to compare the performance of RGB and Hue-based colour models with the objective of determining which is the most natural and intuitive to an inexperienced user. Again, outcomes were assessed by comparing colour-matching performance in terms of speed and accuracy. One of the suggested conclusions of this study was that generally the users have little understanding of either the RGB or HSV colour model. In other words, neither of them is intuitive. The improvements in accuracy that are attributed to increased feedback in the interface are explained by the user adoption of simple learning strategies such as hill climbing. Thus a simple process of trial and error in which the addition of visual feedback helped the user better predict the next move as opposed to intuitively coordinate and manipulate the three axes in the colour model to achieve the desired goal.

This brief review of relevantly scarce assessments of standard colour-picker arrangements suggests that although some colour models may exhibit qualifiers synonymous with an *ease-of-use* approach it does not necessarily make them intuitive. Thus, although Hue configurations may be preferable to RGB, Smith draws attention to awkwardness in the interacting relationships between colour attributes of his own widely implemented HSV model (Smith & Lyon 1996). Lawson (2006) strongly advocates that interface designers must break away from being led by the technology, and avoid solutions that are only truly comprehensible by other experts.

### 3. EXPERIMENTAL

An experiment was carried out to investigate whether students' creative colour choices would be influenced if they were exposed to a colour-matching task that demonstrated the relationship between on-screen colour and hard copy colour. Figure 1 (left) shows an Adobe Photoshop environment where students selected colours using the conventional Photoshop GUI for six shades for a range of Womens Wear (Spring 2012). Prior to the task half of the students were first asked to match colours on a print (viewed in a light booth) using a bespoke colour-matching environment on screen (Figure 1; right).

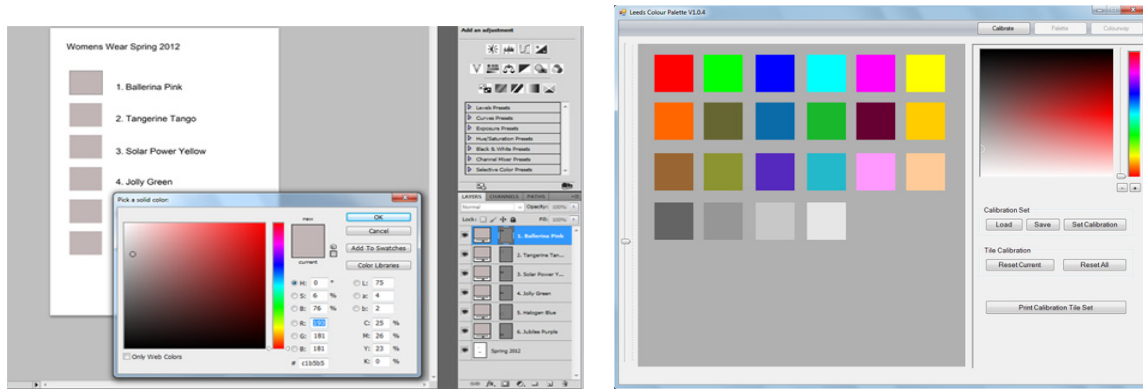

Figure 1: The standard Photoshop colour GUI (left) and the bespoke colour-matching environment that half of the students were asked to use prior to completing the Photoshop task.

A total of 12 students participated; 6 undertook the matching experiment first and a further 6 (the control group) just did the Photoshop task without participating in the matching experiment. The Photoshop was to produce a seasonal colour palette based on their individual interpretation of six seasonal Pantone colour names (1. Ballerina Pink 2. Tangerine Tango 3. Solar Power Yellow 4. Jolly Green 5. Halogen Blue 6. Jubilee Purple). Although actual Pantone shade forecasts for 2012 the colours were selected for their evocative naming and not for any purpose relating to colour accuracy. An integral part of the task instructions include the requirement that the colour palettes produced would be printed on a specific printer. All participants were textiles design students from the University of Leeds (School of Design) and were familiar with the selected device through regular use.

Each of the two groups used PhotoShop CS5 to produce their colour interpretations. The first group completed the task as a standalone exercise, the computer monitor screen first been calibrated and set up in laboratory conditions to negate the affect on ambient light. Before creating their palettes the second group where required to first complete an accurate colour match exercise.

#### 4. RESULTS AND DISCUSSION

Figure 2 shows the main results from the study. The CIELAB values of the colours selected are shown. The left figures show the results for the control group that undertook the standalone Photoshop task and the right figures show similar results for the test group that first undertook the colour-matching exercise. There is some evidence that the test group chose less saturated colours for the fashion palette than did the control group which supports the hypothesis that the students' creative process has been influenced by exposure to the colour-matching task.

#### 4. CONCLUSIONS

This work is part of an on-going study to develop a new intuitive colour-picker tool. There is some evidence in this work that engagement with the colour-matching task (and hence the relationship between on-screen and print colour) helped the students to make more rational colour selections in their creative task that were within the gamut of the printer being used.

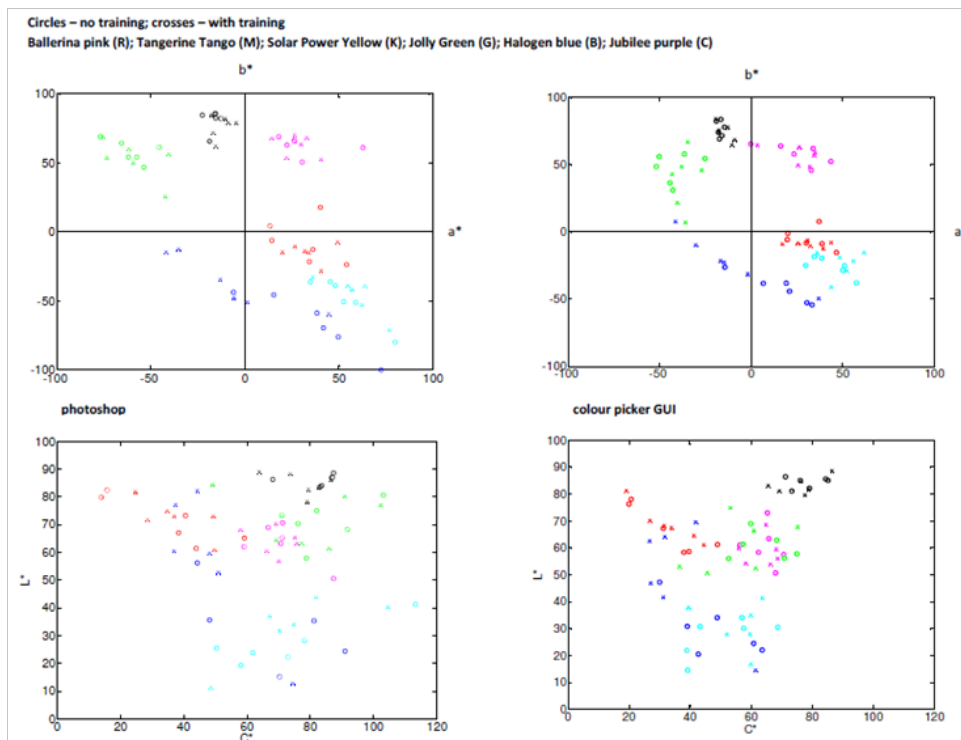

Figure 2: CIELAB results for the colours chosen by the control group (left) and the test group (right) for each of the six colour name.

## REFERENCES

- Fairchild, M.D., 2005. *Color Appearance Models*, 2nd edition. Chichester, UK. John Wiley & Sons Ltd.
- Schwarz, M.W., and J.C. Beatty, 1987. An Experimental Comparison of RGB, YIQ, LAB, HSV and Opponent Models, *Proceedings of ACM Transactions on Graphics*, 6(2): 123-158.
- Douglas, S.A., and A.E. Kirkpatrick, 1996. Do Color Models Really Make a Difference? *SIGCHI conference on Human factors in computing systems*, Vancouver, British Columbia, Canada, 399-ff.
- Smith, A.R., E. Lyons, 1996. HWB-A More intuitive Hue-Based color Model. *Journal of Graphic Tools*, 1(1): 3-7.
- Lawson B., 2006. *How Designers Think, 4th Edition*, The design process demystified. Oxford, Architectural Press.

Address: Philip Henry, School of Design,  
University of Leeds, Leeds LS2 9JT, UK  
E-mails: p.m.henry@leeds.ac.uk,  
s.westland@leeds.ac.uk, t.l.v.cheung@leeds.ac.uk



# Feasibility of Developing a Universal Imagery Model in Predicting Color Imagery for Color-Apparel Images

Wen-Guey KUO,<sup>1</sup> Jeng-Jong LIN,<sup>2</sup> Yuh-Chang WEI,<sup>3</sup> Chung-Kan LEE<sup>3</sup>

<sup>1</sup> Department of Textile Engineering, Chinese Culture University, Taipei, Taiwan

<sup>2</sup> Department of Information Management, Vanung University, Taipei, Taiwan

<sup>3</sup> Institute of Information Communications, Chinese Culture University, Taipei, Taiwan

## ABSTRACT

Color imagery has been investigated using specific pattern samples but not textile specimens for about six decades since the semantics differential theory proposed by Torgerson. And, so far, there have existed three celebrated color imagery models, two proposed by Ou et al. (abbreviated as the Ou1 and Ou2 for single color and two color-combinations respectively), and the third considered as a universal one and developed by Kuo (as the Kuo). A color psychophysical experiment with 186 fashion-apparel images containing 141 ones in which the fashion apparels are with two-color combinations was conducted in this study, and the experimental visual results were used to examine the performance of these three models in predicting visual color imagery with the value in the unit of performance factor PF. The results indicates that all three color-imagery models tested have better performance in predicting the visual color imagery in the unit of Heavy-Light imagery scale than those in another two units of Beautiful-Ugly and Various-Steady imagery scales respectively. Meanwhile, the Kuo model has the best performance in predicting the visual color imagery among the three ones tested having the mean values of 164 in the unit of PF. It is obvious that the Kuo model can be a universal color-imagery model in predicting color imagery for all the color-apparel specimens with single color or multicolor-combination. Finally, more field trials may be needed to verify this finding.

## 1. INTRODUCTION

Colorimetry has long had the purpose of measuring color or estimating or predicting color difference for more than eight decades since 1931. It is also able to be employed in specifying a color by color coordinate or color appearance, but not in indicating one by harmony or color imagery. The latter had been further studied since 1981 by Kobayashi (1981), and there was an advanced theory of the relationship between color imagery and color space based on colorimetric theories also subsequently proposed by Kuo et al. (W.G. Kuo and Y.C. Kuo 2000). Furthermore, based on those theories, several researches were carried out and published during the past ten years, such as the two celebrated color imagery models proposed by Ou et al. (2004a and 2004b) (abbreviated as the Ou1 and Ou2 for single color and two color-combinations respectively), and one as a universal color-imagery model by Kuo et al. (2011) and Kuo (2007), abbreviated as the Kuo.

The term of color imagery is still employed throughout this article because this term has its own scientific and historical base from Kobayashi. In addition, any emotion scale in one of the color emotion models derived by Sato et al. (2000), Xin and Cheng (2000), and Ou et al. (2004a) separately cannot have a good and simple relationship with the hue scale of the CIE  $L^*a^*b^*$  color space due to not only the uncertainty and undefinability or complexity and incomprehensibility of these new emotion scales, but also so far still no scientific data

published by the CIE to prove what pair of semantic differential words belonging to imagery or emotional one. It is believed that the CIE won't rashly determine all pairs of semantic differential words as emotional ones. Furthermore, there were not enough color samples or bipolar or pairs of semantic differential words used in the visual experiments conducted by the previous researchers described above, and it is the one of the most important factors making the models derived by them having inaccuracy in prediction and no representative as a new model. Therefore, the term of emotion is extremely inadequate to be used instead of the imagery one. Meanwhile, the emotion scales will be presented in a new specific formation being included in the author's researches in the near future. Finally, a color psychophysical experiment was conducted in this study to examine the performance of these three models in predicting visual color imagery using experimental data by means of performance factor (Kuo and Luo 1996), with 186 fashion-apparel images as experimental specimens containing 141 ones with two-color combinations.

## 2. METHOD

Most previous studies on color imagery were typically concerned with whether the color imagery scale can be expressed with a small number of categories, or factors, by using the psychological method of category judgement proposed by Torgerson (1958). In this study, the psychophysical method of magnitude estimation was used instead of the psychological method of category judgement.

In the visual assessment experiments of scaling color imagery, 186 color specimens of apparel images have a large size that subtends  $10^\circ$  at the observer's eye, having 141 ones with two-color combinations. Each color-image sample shown on a flat display was assessed twice by a panel of eleven observers in a dark room, including six female and five male ones, and all of them being within the ages of 20 and 35 using the psychophysical method combining both magnitude estimation method (Kuo 2007 and 2009) and semantic differential method (Osgood 1957).

## 3. RESULTS AND DISCUSSION

### 3.1 Stability of Visual Assessment

A series of color-imagery assessing experiments under a dark room were carried out respectively by a panel of eleven observers using the magnitude estimation method. The coefficient of variation (CV %) proposed by Coates et al. (1981) was used to indicate the observer variation, and can be calculated used the following equation:

$$CV (\%) = 100[\hat{\sigma}(x_i - y_i)^2 / n]^{1/2} / \tilde{y},$$

where  $n$  is the number of samples in  $x_i$  and  $y_i$  sets of data, and  $\tilde{y}$  is the mean value of the  $y_i$  set data. The larger the value of CV is, the worse the agreement between the two sets of data compared. For perfect agreement, CV should be zero. The results show that a general stability can be found for the visual results, i.e. the total mean value of 49 and 0.83 in CV and  $r$  (correlation coefficient) units respectively. And, the result of assessing stability for the observers in this study is similar to that for those experiments of color appearance or color difference assessment by Luo et al. (1996) and Kuo and Luo (1996).

### 3.2 The Performance Factor PF

The performance factor (PF) developed by Luo and Rigg (1987) was used to indicate the agreement between two sets of data, and defined as the following equation:

$$PF = 100 (\gamma + V_{AB} + CV/100 - r),$$

where CV and  $\gamma$  were proposed by Coates et al. (1981),  $V_{AB}$  derived by Schultze and Gall (1971), and  $r$  is the correlation coefficient between the two sets of data compared. The PF combines four statistical measures (suitable weighted) into one value, which eases the comparison. For perfect agreement between two sets of data, the PF should be zero. All estimations of the performance of the color difference formulae on predicting visual color differences in the following data analysis are in terms of PF/4 unit being able to indicate the percentage error between two sets of data. Meanwhile, the higher the value of PF/4, the worse the agreement between data sets is.

### 3.3 Comparison of the Performances of Various Imagery Models

Nowadays, there are three celebrated color-imagery models respectively proposed by Ou et al. and Kuo as described previously, i.e. the Ou1 and Ou2 for single color and two color-combinations separately, and one as a universal color-imagery model the Kuo. These models were examined using the experimental visual-imagery data obtained from this study by means of the performance factor (PF/4). The results indicate that all three color-imagery models (the Ou1, Ou2 and Kuo) tested have better performance with the PF/4 values 141, 202 and 151 respectively in predicting the visual color-imagery values of Various-Steady than those of the other two Beautiful-Ugly and Heavy-Light with the worst 248 and the best 151 as shown on Table 1. However, on the whole the three models tested still cannot have good agreement between their predictions and visual results of color imagery. Meanwhile, this finding may obviously shows that a more accurate color-imagery predicting model would be still expected for the fashion apparels with multiple-color combinations and it is one of the most important works of the authors in the near future.

Items	Models		
	The Ou <sub>1</sub>	The Ou <sub>2</sub>	The Kuo
B <sub>v</sub>	185	238	191
H <sub>v</sub>	187	248	151
V <sub>v</sub>	141	202	151
Mean	171	229	164

*Table 1: Estimation on the performances of the color-imagery models derived by Ou et al. abbreviated as the Ou1 and Ou2 for single color and two color-combinations separately, and one as a universal color-imagery model proposed by Kuo as the Kuo in predicting visual color-imagery values, B<sub>v</sub>, H<sub>v</sub> and V<sub>v</sub> standing for the visual assessing values of three color-imagery scales of models Beautiful-Ugly, Heavy-Light and Various-Steady respectively, by means of the performance factor (PF/4).*

## 4. CONCLUSIONS

In this study, 186 color specimens of apparel images having a large size that subtends 100 at the observer's eye, and 141 ones with two-color combinations were accumulated. Subsequently, a series of color psychophysical experiments were carried out using those experimental specimens. The results show that three known color-imagery models tested have better performance with the PF/4 values 141, 202 and 151 respectively in predicting the visual color-imagery values of Various-Steady than those of the other two Beautiful-Ugly and Heavy-Light with the worst 248 and the best 151. But, on the whole the three models tested still cannot have good agreement between their predictions and visual results of color

imagery of the fashion apparel samples employed in this study. Meanwhile, there exists a finding that it may obviously show that a more precise color-imagery estimating model is still expected for the fashion apparels with multiple-color combinations.

#### ACKNOWLEDGEMENT

Special thanks are due to the financial assistance from the National Science Council in Taiwan. And, particular thanks are also due to all observers taking part in the visual assessment experiments.

#### REFERENCES

- Kobayashi, S., 1981. The aim and method of the color image scale, *Color Res. Appl.* (6) 93-106.
- Kuo, W.G., and Y.C. Kuo, 2000, The Investigation on the Relationship between DRP Color Image Scale and CIEL\*a\*b\* Color Space, *Proceedings of the Conference on the Color Application and Color Science in 2000*, 137-144.
- Ou, L.C., M.R. Luo, A. Woodcock, and A. Wright, 2004a. A study of colour emotion and colour preference. Part I: color emotions for single colors, *Color Res. Appl.* 29 232-240.
- Ou, L.C., M.R. Luo, A. Woodcock, and A. Wright, 2004b. A study of color emotion and color preference. Part II: color emotions for two-color combinations, *Color Res. Appl.* 29 292-298.
- Kuo, W.G., C.K. Lee, Y.C. Wei, and Y.Y. Huang, 2011, Effect of different sample patterns on color harmony, *Proceedings of 12th International Conference on Color Design, Application and Science in 2011*, 187-194.
- Kuo, W.G., 2007. The feasibility of establishing new color image scales using the magnitude estimation method, *Color Res. Appl.* 32 463-468.
- Kuo, W.G., and M.R. Luo, 1996. Methods for quantifying metamerism. Part I – visual assessment, *J. Soc. Dyers Color.* 112 312-320.
- Sato, T., K. Kajiwara, H. Hoshino, and T. Nakamura, 2000. Quantitative evaluation and categorizing of human emotion induced by color, *Adv Colour Sci. Technol.* (3) 53-59.
- Xin, J.H., and K. Cheng, 2000. *Quantitative evaluation of color emotion*, JSPS Fund Meeting 71-86.
- Torgerson, W.S., 1958. *Theory and Methods of Scaling*, John Wiley & Sons, New York, USA, 205~246.
- Kuo, W.G., 2009. A New Color Image Space HRU Related to the CIEL\*a\*b\* Color Space, *Color Res. Appl.* 34 (6) 452-457.
- Osgood, C.E., G.J. Suci, and P.H. Tannenbaum, 1957. *The measurement of meaning*, University of Illinois Press, Urbana, 31-75.
- Coates, E., K.Y. Fong, and B. Rigg, 1981, Uniform Lightness Scales, *J. Soc. Dyers Color.* 97 179-183.
- Luo, M.R., M.C. Lo, and W.G. Kuo, 1996. The LLAB (l:c) Color model, *Color Res. Appl.* 21 412-429.
- Schultze, W., and L. Gall, 1971. Application of Color Difference Formulae to Highly Saturated Colors Differing Only in Lightness and Saturation, *J. Color Appear.* 1(1) 17-24.
- Luo, M.R., and B. Rigg, 1987. BFD (l:c) color-difference Formula Part I – Development of the Formula, *J. Soc. Dyers Colour.* 103 86-94.

*Address: Prof. Wen-Guey Kuo, Department of Textile Engineering,  
Chinese Culture University, No. 55 Hua Kang Road, Yang Ming Shan, Taipei 111, Taiwan  
E-mails: kuow@staff.pccu.edu.tw, jjlin@vnu.edu.tw,  
ycwei@faculty.pccu.edu.tw, zenoah82000@gmail.com*

# Function-oriented Color Selection Technique using Subjective Estimation (paired comparison of images) and Psychophysical Evaluation (reaction time measurement)

Keizo SHINOMORI,<sup>1</sup> Taka-aki SUZUKI,<sup>2</sup> Naoki MURAI,<sup>3</sup>  
Yuji OZAKI,<sup>3</sup> Shigeki NAKAUCHI<sup>4</sup>

<sup>1</sup> School of information, Kochi University of Technology

<sup>2</sup> Industrial Research Institute of Shizuoka Prefecture

<sup>3</sup> Aronkasei Co. Ltd.

<sup>4</sup> Department of Computer Science and Engineering, Toyohashi University of Technology

## ABSTRACT

We propose one technique to help selecting a product color, which was used practically for a bathroom handrail. Its color should be highly noticeable for easy detection and immediate gripping, meaning shorter reaction time to find it in a bathroom. In addition, the color should be in categorical red as the company's brand color. This function-oriented color selection technique consists of two measurements; subjective estimation (paired comparison of product images) and psychophysical evaluation (reaction time measurement). We used the computergraphics image of the handrail in popular bathroom environments; all colors were controlled using spectral surface reflectance and illumination's radiance. On twenty-one elderly subjects, the subjective estimation stably indicated the order of noticeable colors. 'Blue' had the worst score, even on elderly observers. 'Orange' and 'Pink' had almost the same score. The score of 'Green' was better than these colors. All 'Red' colors indicated the best score in all colors, although showing some variant for different illuminants. These tendencies correspond well with our reaction time measurement (Suzuki et al., 2013). Our proposed technique provides the rational method in function-oriented color selection, at least for the noticeable color. It is effectively and quantitatively adopted on various illuminant and material conditions.

## 1. INTRODUCTION

It is difficult to find a suitable color for a product in terms of design, especially in establishing a company's brand. If the color of it has to have a certain role for the function of the object, the selection of color would be much more difficult. In many cases, a designer of the product does not have a free hand in color selection because he or she should find the suitable color at least in the same color category to maintain the impression of the company's brand. Nevertheless, the selection of color should also be justified in terms of the good performance by the product's color.

In the present study, we propose one technique to help the selection of the product color, especially helpful to select one certain color in the same color category. Our technique has been improved for actually use to modify the color of a bathroom handrail made by one Japanese company. We firstly defined 'good' performance for such bathroom handrails; the grip of the handrails should be nonslip and have tolerable intensity, restricting its material and surface architecture. The color of the handrail should be highly noticeable for easy detection and immediate gripping, making the reaction time to find the handrail short in a bathroom environment. Additionally, in this case, the modified color of the handrail should categorically be 'Red', that is the company's brand color.

## 2. METHOD

We have developed the function-oriented color selection technique, consisting of two measurements; subjective estimation (paired comparison of product images) and the psychophysical evaluation (reaction time measurement), using special images. Both measurements consisted of two stages; the first stage to confirm the advantage of the company's 'Red' and 'Blue' against other companies' brand colors ('Orange', 'Pink' and 'Green') and the second stage to find the best color in possible new red colors for the handrail. Twenty-one elderly subjects (Mean 72.3 years old, 65-84 years old) with normal color vision participated in all measurements in both stages.

### 2.1 Stimulus

In all measurements, we used computergraphics (CG) images of the handrail in popular bathroom environments (Figure 1L). In the CG software, all colors were controlled under the natural way, using the spectral reflectance of each material in visible wavelength range, which was photometrically measured and used as the bidirectional reflectance distribution function (BRDF) and illuminants of the bathroom in the spectral radiance base. We used three kinds of illuminants; a fluorescent lamp (color temperature 5,000 K, FLD condition) and two LED lamps (3,200 K, LED A condition and 5,000 K, LED D condition). Tri-stimulus values for each pixel of the designated scene CG images were calculated from sum of products of each pixel value of the monochromatic light intensity and CIE 1931 2° Color Matching Functions; the RGB values were converted from the tri-stimulus values for each pixel of the stimulus images using the ICC color profile of the display.

### 2.2 Subjective Estimation (Paired Comparison of Product Images)

In subjective estimation, we used the principle of Thurstone's paired comparison method. Two images were presented side by side on a monitor screen in those the handrails were painted in different colors (Figure 1L). The subject selected the one image which was more noticeable by pressing a button. All combinations were tested and the score of each image, that is the score of the painted color, was obtained as selection rates (Figure 1M). Z-scores were calculated from rates (Figure 1R).

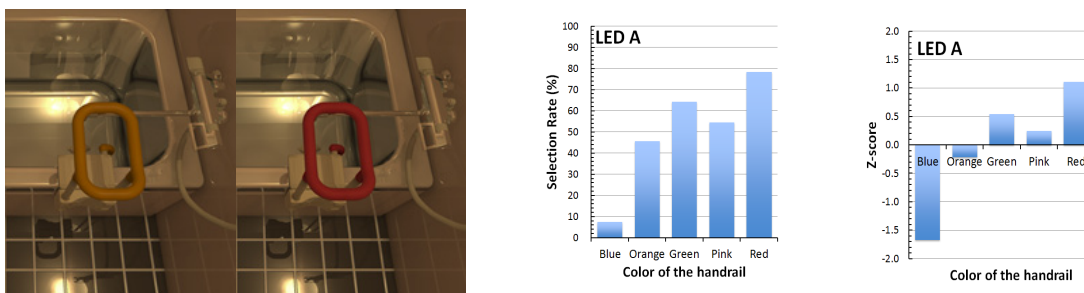

Figure 1: Example of the Stimulus for the Subjective Estimation Experiment (Left) and Typical Results; Selection Rate (Middle) and Z-score (Right).

### 2.3 Psychophysical Evaluation (Reaction Time Measurement)

In psychophysical evaluation by measuring reaction time (RT), four images were presented as four-part split screen on the display; the subject responded to one target image of the colored handrail as soon as possible with the other three non-target images in which the handrail was painted in neutral colors. Details of the RT measurement are shown in the other presentation by our group (Suzuki et al., AIC 2013).

### 3. RESULTS AND DISCUSSION

The subjective estimation by the paired comparison method stably indicated the order of noticeable colors by zero-normalized Z scores (Figure 2). In the companies' brand colors, 'Blue' had the worst score (statistically significant in 0.1% confidential level), even on elderly observers; caused at least partially, by the lower luminance of this blue color. 'Orange' and 'Pink' had almost the same score. However, this pink indicated large variation by changing the illuminant, showing lower scores under the daylight LED (LED D) and higher scores under the A-light source LED (LED A); caused by the difference of the radiance of longer wavelength region in illuminants. The score of 'Green' was better than these three colors (5% level), showing little variation in different illuminants. Initial 'Red' and one new 'Red' colors, measured in separated sessions, indicated the best score in all above colors (0.1-5% level), although showing the variation by illuminants like 'Pink'. These tendencies correspond well with results by the psychophysical evaluation, by the reaction time (RT) (Suzuki et al., AIC2013), although the variation by different illuminants was relatively large on 'Orange' in RT.

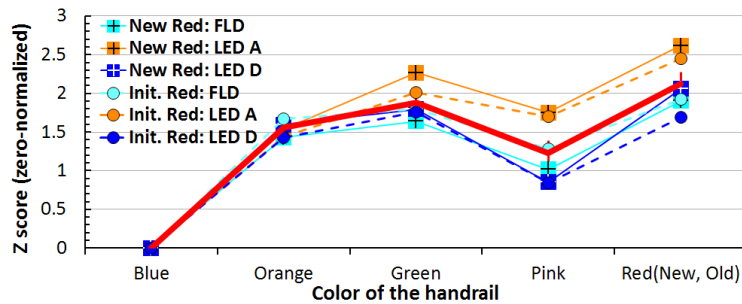

Figure 2: Z-scores of different handrail's colors (1st stage).

To make a total evaluation of colors by both measurements more precisely, we plotted the second stage data in two-dimensional coordinates (Figure 3). The abscissa is RT normalized as the average is one for each observer. Symbols' colors denote the data of 'Orange,' 'Pink' and 'Red'. Red squares with X and cross denote the 'Initial Red' and the best 'New Red,' respectively. Other red symbols denote candidates of 'New Red'. For different illuminant conditions, the correlations ( $r$ ) are 0.774 (5% significance), 0.839 (1% significance) and 0.546 (no significance), respectively.

This high correlation may bring the impression that both of the subjective estimation and the RT measurement would be simply determined by the color difference or color contrast of the handrail to background colors. Although it is roughly true, once regression lines (solid lines) and 95 % confidential intervals to Y axis value (dotted lines) are drawn, the difference of Z scores is too small compared to the confidential interval and it is not possible to predict the subjective estimation by the RT data for the purpose. Furthermore, even we have some knowledges about age-related differences in color discrimination (Shinomori et al., 2001), it is not possible to predict the RT and subjective estimation from photometric information of the handrail because of complexity of the background.

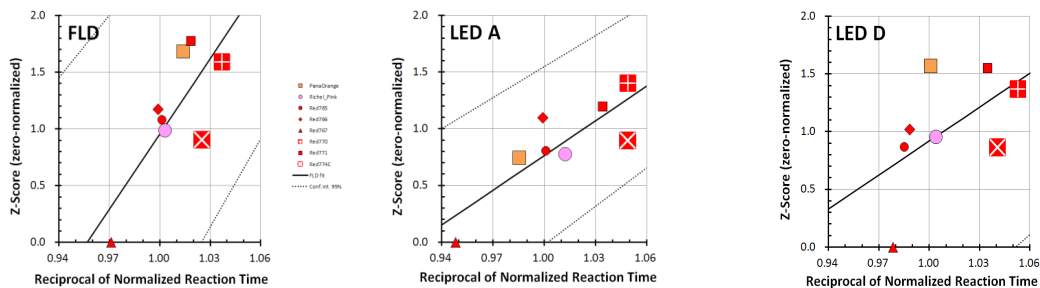

Figure 3: Total evaluation by both measurements' data in 2-D coordinates (2nd stage).

Additionally, we have to think about a high-speed (impulse) response, relating to the RT performance. Although the response of luminance channel is stable in a life span (Shinomori and Werner, 2003), the threshold of positive- and negative-contrasts are different (Shi and Shinomori, 2013) and age-related changes of chromatic impulse responses to blue and yellow are much more complicated (Shinomori and Werner, 2012). Currently, it is too difficult to select the best color of the product by photometric measurement and model calculation if candidate colors are close as is in practical designing. Thus, this proposed technique is useful for real designing process.

#### 4. CONCLUSIONS

Our proposed technique provides the rational method in function-oriented color selection at least in terms of finding the noticeable color; it can be effectively and quantitatively adopted on various illuminant and material conditions without any concern to initial assumptions and color models, those must be required in calculation-base techniques.

#### REFERENCES

- Shi, L., and K. Shinomori, 2013. Amplitude difference and similar time course of impulse responses in positive- and negative- contrast detection, *Vision Research* 77, 21-31.
- Shinomori, K., B.E. Scheffrin and J.S. Werner, 2001. Age-related changes in wavelength discrimination, *Journal of the Optical Society of America*, A 18(2) 310-318.
- Shinomori, K., and J.S. Werner, 2003. Senescent of the temporal impulse response to a luminous pulse, *Vision Research* 43(6) 617-627.
- Shinomori, K., and J.S. Werner, 2012. Aging of human short-wave cone pathways, *Proceedings of the National Academy of Science of the United States of America* (PNAS) 109(33) 13422-13427.
- Suzuki, T., K. Shinomori, N. Murai, Y Ozaki, and S. Nakauchi, 2013. Evaluation of visibility of color under a range of spectral illumination using physically based spectral rendering images: Comparison of reaction times for colored handrail in the bathroom. In *AIC Color 2013, Proceedings*, Newcastle, in press.

Address: Prof. Keizo Shinomori, School of Information, Kochi University of Technology,  
 185 Tosayamada-Miyanokuchi, Kami-city, Kochi 782-8502, JAPAN  
 E-mails: shinomori.keizo@kochi-tech.ac.jp, suzukita@iri.pref.shizuoka.jp,  
 n-murai@aronkasei.co.jp, y-ozaki@aronkasei.co.jp, nakauchi@tut.jp



# MOBIL'COLOR'ART // the PSI'COLOR

Jacqueline CARRON  
Atelier Recherche Couleur

## ABSTRACT

This research is based on interplay between the rational and the intuitive. A desire that yields to the subtle and ephemeral games of this mobile world, which is unstable, in a constant state of change and renewal, open to multiple and infinite combinations and what I call **MOBIL'COLOR'ART**. It's incarnation is the **PSI'COLOR**, both a playful chromatic artwork and a tool for painting.

poster session one

### From virtual to reality

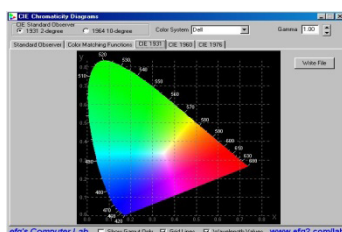
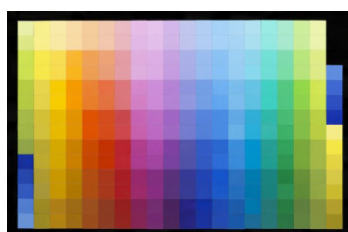

Concept: Psi'Color is based on current scientific knowledge: structured and punctuated by color alone. There are no shapes, no lines, but vibratory fields of color, ranging from dark to light which interact with the light and the viewer.

### From single to multiple

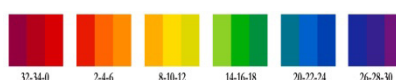
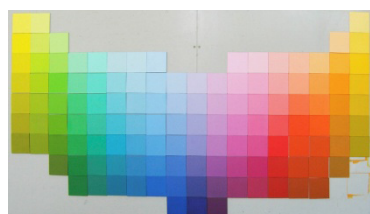

LES TONALITÉS MÈRES			
° T			T °
29°	34	→ ROUGE	32 29°
		+ violet orangé + magenta	
		→ orangé + orangé orangé	0 38,5°
62°	4	→ ORANGÉ	2 50°
		+ orangé + orangé orangé	
		→ jaune + orangé jaune	6 68°
90°	10	→ JAUNE	8 82°
		+ orangé jaune + jaune orangé	
		+ vert + jaune vert	12 90°
44°	16	→ VERT	14 68°
		+ vert jaune + vert cit	
		+ bleu + vert bleu	18 38,5°
18,5°	22	→ BLEU	20 25°
		+ vert bleu + bleu vert	
		+ bleu violet + bleu violet	24 18,5°
12,5°	28	→ VIOLET	26 12,5°
		+ bleu violet + violet bleu	
		+ orangé + violet orangé	30 34°

It is constructed from three colors, the material primaries: cyan, yellow, magenta. The mixture of these three colors produces a range of eighteen tones which are punctuated at equal intervals. The lightness is selected between 0-100° from the Judd, Newall, Nickerson psychometric brightness scale. These 18 tones have their own initial properties: hue, lightness, saturation: they are the mother tones. They will each have six children. Between the mothers and children, 216 colors are produced in total, forming the Psi'Color. Once in place, this polychrome interface creates a sense of raw yet structured color, reminiscent of the rainbow.

### Mobility of the components



The mother tones and their children which make up the Psi'Color are 9x9cm square plastified elements. They are covered with two undercoats which are sanded smooth and over which five successive paint washes are applied.

In such a way as the light penetrates the colored surface perfectly, obtaining the maximum visual color impact possible according to their respective tones, saturated or desaturated. In fact each of the 216 tones is a small monochrome painting. They are mobile, and are made to fit in the palm of your hand.

The interaction between the mother colors and their children and the cross pollination between the families will give rise to the diversity of transformation. It is a discovery of the reaction between colors when their order is disrupted. It is thus possible to move all the colored elements, from order to disorder, creating and renewing the overall appearance.

### Freedom within the structure

As it is built upon basic logic, the Psi'Color can be configured into various aspects spanning from order to disorder. Methodically, by maintaining the logic or more freely through pure intuition. Whatever the combinations, the overall result remains consistent throughout. Contrasts that are more or less strong will arise, but the whole is accepted by the eye and brain. These 216 flat and smooth colors, with their rigorous vertical and horizontal contours each occupy the same space within the frame in which they evolve. They are each pure and perfectly uniform. Once arranged next to each other, border against border, there is little room for interference and pure and simple **color interaction** comes strongly into play. The various tonalities co-exist intimately and settle in medium light or dark colored areas. The mother colors are fully saturated tones, their children are progressively desaturated either using white or trichrome black. On the brightness scale, these will span from 12° for dark tones to 82° for lighter ones.



### Variable structures

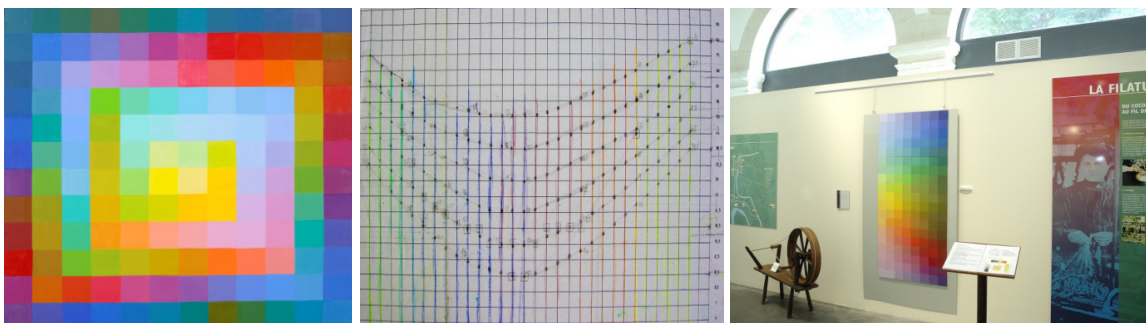

Psi'Color is a concept which can produce different basic structures through the number of colors. The small Psi'Color has 36-90 tonalities. The larger Psi'Color which we are looking at here, has 18 mother colors and 216 tones in total. Or there is the largest Psi'Color which

has 36 initial mother colors. The Psi'Color can not only vary its structure through the number of components, but also by the choice of the initial mother colors and through the choices of clarity.

The Psi'Color for hanging on large surfaces consists of panels that can hang with picture rails and whose dimensions are  $2 \times 1$  m in succession: 2-3-4, dimensions which may vary according to requests.

A new relationship between color and the viewer, developing and underlining the human senses of sight and touch. A new relationship between art and the public: participation, interaction and play. It is a database that allows you to refine a color project, to give it an appropriate structure and give it body without wasting time. Directly to the essentials. In short, a straightforward and effective tool that takes into account the constraints of a profession or those set by a designer.

### Behavioural and contextual study of subjects in front of the Psi Color

#### Playful art



Here are few observations noted during exhibitions:

Paris, Centre des Collectionneurs, rue Quincampoix near Pompidou centre: a large Psi'Color installed in the center of the gallery was not touched, whilst four smaller Psi'Color in an adjoining room were transformed by visitors into tools of free expression.

Poet-Laval, exhibition on color, installations of colored lights and paintings: one could observe a large Psi'Color shaped into a mandala alongside two free panels for visitors to apply the squares at their disposal themselves. Adults tended to head directly to the mandala motif and alter it in some way.

“Magicien de la Couleur” exhibition in Clermont-ferrand: a large Psi'Color of 216 colors ended up being protected from the public. Intensive playing and experimentation.

Invited by the city of Lyon to exhibit in the park of the Tête d'or: I have a picture of a person awaiting the departure of a class of teenagers, before rushing to use the Psi'color

Invited by the town of Poet-Laval to exhibit in the Château des Hospitaliers: a large Psi Color alongside a sign inviting visitors to manipulate the colors within the panel. The next day, the panel was completely transformed. During the three month exhibition period, 4000 people passed through and left traces of their visit via the Psi'Color, even a rugby club used it as a form of advertising.

#### Color: forces

We are in a world of energies and forces, color is part of these forces as colors are vibratory electromagnetic wavelengths. Each has its particular strengths; these energy transmitting colors unite and blend or oppose one and other. This is easy to understand when one

uses “color-light” because one immediately sees the result when two rays of colored light are crossed. A third color is produced, brighter than the two that comprise it. A yellow ray of light which is the result of mixing red and green light, is brighter than the red and green lights that were used to make it. Similarly, a cyan light is brighter than the green and blue lights that compose it.

In painting or “material-color” things evolve differently and it is more difficult to understand. The same energy forces are at play, but in a more subtle way. One can organize these forces that are the various energies of color and structure them to make a composition with color alone. This becomes a pure force field of color energy. This is what I aim to achieve with the **Psi’Color**.

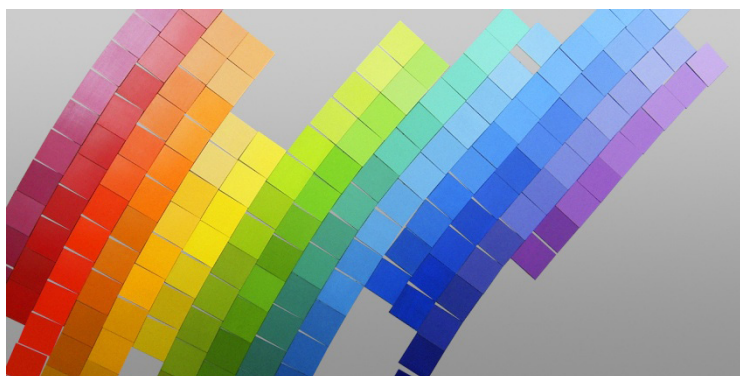

In these force fields, color hue, brightness and saturation will create areas of dominant color, rhythms, slow or fast, equal or progressive. The notion of time is also a key element for the eye and mind to acclimatize and follow these rhythms in order to find points of attraction: points of interest, pleasure or even discomfort when faced with certain colored sensations, each with their own mobile & changing resonances (as if they were individuals). Added to all these aspects is the virtual interference from phenomena induced images, which occur during simultaneous contrasts. Thus so many possibilities are open to us through the field of color and one can explore it endlessly...

Within these spaces of assembled material color, the surface is exposed to the light rays that hit it. They penetrate deep into this matter, which reflects back a portion of its energy into a wavelength captured by the viewer. Through eye-brain vision, the viewer is an active participant, capturing a virtual wave of color vibration and sensing a third color born of the contrast between two others. Man sees and experiences this exchange between light and material color and is penetrated by these forces. One can transform the PSI’COLOR as one wishes, from order to disorder, opposing developing forces with each other, horizontal, vertical, kinetic forces. One can develop a chromatic sequence, or a mandala, play with opposites or create a spectral osmosis. In short, play and experiment according to ones mood.

Finally, this concept can be developed into many dimensions. As it stands today, I have manufactured ten large Psi’Color, not counting the various smaller ones. Through its changeable & mobile aspect, the Psi’Color strikes me as being the basis for another art, linking science and art by way of new technology. **I call this MOBIL’COLOR’ART intuitive/methodical/ manual/tool**

*Jacqueline Carron 23/02/2013, rue des Canettes, Paris  
E-mail: jacqueline.carron@wanadoo.fr*

# Metagrass or a Tail of a Green Future Environment

Joaquim SANTOS

Faculty of Architecture and Arts, Lusíada University, Lisbon, Portugal

Architect, Docent in History of Art and Theory of Architecture.

Researcher at the Research Centre in Territory, Architecture and Design,

Colour Laboratory (CITAD) at the same university.

Doctor of Philosophy, Tampere University of Technology, Faculty of Architecture, Finland

## ABSTRACT

In 2005, in an interview published in the book *The Top Architects of the World*, Dominique Perrault put forward an impressive argument that characterizes the way how we experience architecture and environment at the present day and that seems to trace our future. According to him, there is no relation between natural and artificial. Nature is a material because is, indeed, a material. We can manipulate it and, therefore, it becomes an artificial element. And the same is valid to the way we live in the world. We live in cities and there is no countryside any longer. We live in an urban society. Consequently, the eighteenth century romantic reference to nature is no longer valid. The only things we cannot control are phenomena like cyclones, earthquakes, forest fires. For him, nature is a material such as concrete, glass or metal.

Within a world searching for its sustainability new materials are not discovered but invented by combining atomic and molecular structures that determine their outstanding properties – perfect alloys of a near future that combine *atom-on-atom*. Natural *versus* artificial is under inquiry. What would the *natural* colour of *artificialness* be?

## NATURAL, ARTIFICIAL AND BEYOND

Samurai sword is one of the most perfect inventions in which atomic structures were molded layer after layer according to bring together the sharpness of glass and the hardness of steel (Bronowsky 1979: 130-133) and Damasco steels proceed along the same creative lines (Sherby, Wadsworth 1985: 94-106) and they have their ancestor, probably, when blacksmiths in Cyprus made the first steel knives 3100 years ago (Calder, 2003: 102). Yet, colour and physicochemical stability of gold has sent it to another path. Creativity arose *colour & power*. From early first tools humans paid special attention to materials and could isolate their properties, or combine them such as those of mud and straw. Nanotechnology has the history of civilization behind it, strong and fertile.

Large *versus* small seems to be a *body-mind-world* working strategy (Penrose 2003). Actually, the ancient act of dwelling means regarding whole natural environment as hostile to human survival and therefore one creates a micro controlled environment that is not so far from a scientific highly controlled micro environment in which scientist aim to extract *ceteris paribus* laws, that should be able to be generalised beyond such controlled environment. Sedentarization gave way to a first impressive form of generalised environmental control. If Man remained in the hands of Gods because only they controlled the working forces of nature, the sowing and the harvest made the relation between the *single seed* and the *cosmos of seeds* visual. And we may add that colour was an exceptional *technological device* to control the growing process of trees, plants and vegetables.

Colour was the great *event* that launch contemporary embracing understanding of environment. *Natura naturata* built on dynamic processes was the modern scientific understanding that took us to talk about eco-systems and complex evolution of nature, but science and the world needed powerful *rational-emotive* images.

Snapshots of our beautiful blue, cloud-flecked planet, taken by astronauts during NASA'S Apollo missions to the Moon in the late 1960s and early 1970s, had an impact on the public consciousness. Emotionally speaking they completed the Copernican revolution, 400 years later. Abstract knowledge that the Earth is just one small planet among others gave way to compelling visual proof. The pictures became icons for environmentalists, who otherwise tended to complain about the extravagance of the space race (Calder 2003: 211).

From this moment on, awareness of Earth colours as colours of life became a cosmologic signature. Earth colours are, indeed, odd in the cosmologic environment, but they are the natural colours of life, our colours. But, cosmologic beauty goes beyond life. Yet, the technology that has open the way to this great event works together the atom scale and the universe size scale and, curiously, the impressive emotive beautiful blue of Earth may link a single petal of the garden where I sit and the huge universe I can only see when I enlarge my senses through technology. I have to think *artificially*!

### THE ORANGE CRISTALS OF C<sub>60</sub>

Artificial is an odd concept. All elements of Mendeleev's Periodic Table are natural! But Earth environment experience tells us that they do not occur alone and that, at the best, some impure alien atoms have fatally penetrated the natural carbon structure of the natural diamond and we need perfect high technology to build it up *pure*, that is *artificial*. Earth environment experience have taken us to crossing roads. Suddenly, we have to realise that natural beauty may arise either from perfect basic isolated elements or from ordinary natural mixtures that create homogenous and heterogenous appearances through nature. In this sense, natural and artificial might be understood as opposite sides of the same environmental coin.

Ilan Pivko Architects' Ethiopian Cultural Center in Yavneh, Israel, displays mud and concrete walls, the former represents the ultimate perfect *artificial* concrete technology and the latter the validity of an ancient technology whose environmental visual approach is visually intuitive that, consequently, we may classify as *natural*. But, regarding materials themselves, we have to say that both have *natural* colours, their *own* colours. Last but not least, a profound humanistic symbolism is developed:

I interpreted the growing harmony between the Ethiopian and Israeli cultures by combining two building traditions – mud walls and modernist concrete ones, with textured mud warming the cold, grey concrete on surfaces shaped by the human hand (Domus 927: 24).

Somewhere, hidden between concrete and mud, might be a new way of approaching matter and colours of materials. Even the notion of cladding itself might be renewed if we take mechanics of surfaces and we realise that coating mean active constructive materials to be built on materials surfaces like a glue that binds two different materials. Notion of construction has to change by observing graphite single flat sheets of atoms in a honey comb pattern with interlocking hexagons of six carbon atoms (Calder 2003: 97).

Material-colour as a constructive *thing* may not be disclosed from the fact that we see matter no longer as 19<sup>th</sup> century did; vision that started to change by the intimate link that

James Clerk Maxwell made between electromagnetism and light (Calder 2003: 238-239).

In the 19<sup>th</sup> century, matter was one thing, whilst the forces acting on it – gravity, electricity, magnetism – were as different from matter as the wind is from the waves of the sea (Calder 2003: 238).

In fact, wholeness of matter seems environmental intuitive and this is the reason why Earth candid blue seems so deep and tangible. Yet this intuition is complex because is product from that western intellectual culture that enabled Picasso to recognise on the African mask the lost of objective ontological purity of western art. Then, it seems we have been provided with proper built in tools that enable us to find similarities between the *scheme of the density of electrons in a part of myosin crystals* and Jackson Pollock's *Enchanted Forest*, 1947 (La Biennale 1986: 142-143) that may take us through *matter-colour* construction, from atom-cell environment to world environment.

Sumio Iijima found the first known nanotubes in 1991. The natural-artificial issue arose. He believed that C60 carbon structure could be found in the outer space and it was actually found far from everyday experience of environment. The crystals he could isolate by displaying an orange colours were somewhere there! (Calder 2003: 96-99) Are those materials that come ready from outer space, such as cyanopolyynes, artificial?

Constructiveness seemed a wide ranging environmental issue that could not be avoidable and, under control, could provide a large variety of shapes that deconstructivism could not because the linkage to language/text always needed a metaphor to be built in matter. Thus, construction itself needed to be the centre of architecture and every metaphor could then arise from construction itself. It seemed that micro-macro cosmos could imposed such a variety of shapes that deconstruction was suffocating instead of releasing; in which colour constructiveness could weaken, too. Atom and cell based mimesis seemed strong enough to provide future architectural digital modeling (Spiller 2008).

Although the effect [of Deconstructivist architecture] was persuasive in academia, a few of the architectural theoreticians were unsatisfied, believing that architecture still possessed a material presence that was not accommodated by the language/textually orientated philosophy of Derrida. They therefore moved towards the thinking of Gilles Deleuze and Félix Guattari, to improve a radical theory that addressed architecture in its materiality (Perrella 2001: 139).

The 2002 Toyo Ito's Serpentine Gallery Pavilion already belongs to a new era. There is no distinction through *pilar-beam-bracing* but a full language/text free geometric-physical construction is clear. And *matter-built-in-mathematics* works as a cultural unifying metaphor such as Ilan Pivko's mud-concrete symbolic walls embody.

## CONCLUSIONS

Artificial creations are, more than ever, the symbol of our civilization. But contemporary environment ethics may take us back to 50.000-10.000 BC, to the first globalization, the diffusion of Homo Sapiens long before first empires were settle down (Le Monde: 14).

Today, *natura naturans* has shown itself more creative than ever by revealing few other secrets and by manipulating the inner structure of matter we can give materials new colours, perfect atomic signatures, a colour paradise.

Bruno Taut's *Die Kugeln! Die Kreise! Die Räder!* (*The Spheres! The Circles! The Wheels!* from *Alpine Architektur*, 1919) tied up the inner micro structure of matter to the sensible

fashionable world of experiences (Fiz 2008: 90) and Jakob Hronek's mathematical Tekno Logical colours may take us to a metamathematical world where, probably, one day, we will find proper tools to build up paradisiac *metagrass*!

### ACKNOWLEDGEMENTS

Professor Isabel Braz de Oliveira, Head of the Colour Laboratory, Research Centre in Territory, Architecture and Design Lusíada University, Lisbon.

Lusíada University, Faculty of Architecture and Arts, Lisbon, and Minerva Foundation.

Portuguese Foundation for Science and Technology (FCT).

Gareth Griffiths, Architect, Helsinki.

### REFERENCES

XLII Esposizione Internazionale d'Arte La Biennale di Venezia, 1986. *Arte e Scienza. General Catalogue*. Edizioni La Biennale. Realizzazione Electa Editrice. Venice.

Experimental Green Strategies, 2011. *AD, Architectural Design*. No. 214. John Wiley & Sons. London.

Bronowsky, J., 1979. *The Ascent of Man*. British Broadcasting Corporation. London

Calder, N., 2003. *Magic Universe*. The Oxford Guide to Modern Science. Oxford University Press, Oxford.

Cambert, May 2004. *Les Plus Grands Architectes du Monde*. Atrium, Paris

Domus 927 2009. Editoriale S.p.A. Milan.

Fiz, S.M., 2008. *La Metáfora del Cristal en las Artes y en la Arquitectura*. Ediciones Siruela, S.A. Madrid.

Hardison, O.B. Jr., 1989. *Disappearing through the Skylight. Culture and Technology in the Twentieth Century*. Viking Penguin. New York.

Hronek, J., P. van Roojen, 2004. *Tekno Logical*. The Pepin Press BV. Amsterdam.

Iwamoto, L., 2009. *Digital Fabrications. Architectural and Material Techniques*. Princeton Architectural Press. New York

L'Atlas des Mondialisations, 2011. *5000 ans d'Histoire. 200 Cartes. Le Monde. La Vie. Hors-Série.* France Inter. Paris.

Penrose, R., A. Shimony, N. Cartwright, and S. Hawking, 1997. *The Large, the Small and the Human Mind*. Cambridge University Press. Cambridge, England. 2003. *O Grande o Pequeno e a Mente Humana*. Gradiva. Lisbon.

Perrella, S., 2001. *Hypersurface Theory: Architecture <> Culture*. In *AD. Architecture and Science*. Edited by Giuseppa Di Cristina. Wiley-Academy. Chichester. 138-147.

Spiller, N., 2008. *Digital Architecture Now*. Thames & Hudson. London.

Sherby, O.D., 1985. *Wadsworth, Jeffrey: Damascus Steels*. Scientific American. New York

*Address: Joaquim Marcelino Santos  
Rua Maria Lamas, 4 – 6º Esq. 1500-438 Lisboa. Portugal.  
Address: marcelino.c.santos@gmail.com*



# Graphics and Colour: Tradition and Modernity

Ana SILVA<sup>1,2</sup>

<sup>1</sup> Faculty of Architecture, Technical University of Lisbon

<sup>2</sup> Portuguese Colour Association (APCor)

## ABSTRACT

Actually, the innovation of certain crafts expressions and place them in other contexts as a way of preserving an endangered art is one of the biggest challenges in the world. Through industrialization and the gradual disappearance of the artisans, the future may involve the adaptation of traditional crafts for the textile industry and as innovators in fashion collections. A work that is already visible in some brands and designers of Portugal.

In this context, we intend to explore and analyze how *Lenços dos Namorados* (Valentine Handkerchiefs) originated from a craft tradition integrates meanings that are shared and recognized as a symbol of identity and creative force. In this process graphics and colour adopt new meanings to reach the consumer, perpetuating time, memories and traditions in modernity.

**Keywords:** craftwork, colour, graphics, tradition, modernity

## 1. INTRODUCTION

The tradition of the portuguese crafts *Lenços dos Namorados* (Valentine Handkerchiefs) dates from the seventeenth century, and is a valuable witness of art and popular culture from Portugal. Present in many locations has its most beautiful expression and splendor in Vila Verde, Minho.

The symbology is beyond the beauty and is enhanced by the materials, the techniques or by the supports where is used. It is precious all the information that is passed at a time where there wasn't the same technologies as today. Fantasy and taste characterize the desires, aspirations and sometimes the frustrations of the artisan.

Embroidered by young marriageable, have a particular simbology related with graphics and colour acting as an instrument of communication. Once executed, the Lenço dos Namorados (Valentine Handkerchief) was given to the intended boyfriend and, in accordance with his attitude of using it in public or not, outlined the beginning of a love affair and unveiled to the community their status.<sup>1</sup>

Occasionally, they serve as a reason for a joke or an exchange of words between the boy and the girl. During the holidays or festivals, the "boy" took it off from the "girl" in order to simulate a love affair. But they also could represent some history facts, such as, the emigration to Brazil, agricultural work (harvest) or social criticism (Silva, 2006; Neves and Gomes, 2008).

Actually, the motifs of this portuguese crafts are being adapted by national fashion designers in clothing, accessories, textiles and porcelain. Motives and colours are re-interpreted from the traditional but the technic of embroidery is the same. In this context, we intend

<sup>1</sup>

In case the boy accepted, he used it over his Sunday's jacket, around his neck with the knot towards the front, in his hat brim or even in the tip of a stick that he usual bring. In case the girl was not corresponded the Lenço dos Namorados (Valentine Handkerchief) was returned or if the boy change his girlfriend, he would return it to their embroiderer together with all objects, such as photographs, letters, etc..

to demonstrate how are being referenced the customs and traditions and discover our identity in this global world.

## 2. METHOD

Considering the statement of Cabral et al. (1998), we noticed a layout pattern common to all tissues collected. The form is always a square of linen or cotton with the proportion square between 50cm and 60cm. Inside this area is organized different decorative elements distributed from the center to the sides, the angles and the edge. The symmetry of the composition is sacrificed by an excess of motives and exuberant colours.

It is interesting to consider that the application of colour passed through the years from black and red (associated to nobility and with a decorative function) to a polychrom (associated to folk and popularity with a communication function). The eternal love is represented in all the compositions with several symbols, such as, hearts, swans, lovers, keys, doves, the word Love and a message written in verse. This crafts could also be trimmed with inset and trim lace, depending on the creativity of its author.



Figure 1: The process of sample preparation.

The knowledge of our own culture and tradition is, certainly, an interesting starting point in the development of new products. Allying the traditional materials and technologies with the contemporary requirements of the market. In other words, combining tradition and modernity. As mentioned Cunha (2005), “In a moment contrary to its origins, it is now a popular source that sees appreciated by the intellectual elite, who absorb and transform, returning it back to the people properly valued.



Figure 2: Beija-me Depressa (Kiss me Quickly).

In this context, Ana Salazar has pioneered and, recently, Storytailors adopted the *Lenços dos Namorados* (Valentine Handkerchiefs) as a new accessory collection. “we want to prove that the products have a traditional place in the present and may evolve in the future” (Branco, 2010). This collection named *Beija-me Depressa* (Kiss me Quickly) was developed with a strong inspiration in Love.

*Nuno Gama*, adapted the exclusive stamp of the artisans through graphics, colour and simbologie creating a hallmark of the Portuguese tradition and an accessory for those who follow the new trends. This simple concept recover the original expression of the relations between man and woman in a act of fidelity, love affair and marriage.



Figure 3: *Amar Portugal (Loving Portugal)*.

*Vista Alegre*, celebrated a partnership with fashion to create a line of table pieces of various sizes. In addition to the drawings, some standardized, with motives associated with the workcraft. Flowers, hearts, birds and words, are some of the elements that decorate the colorful pieces in this collection.



Figure 4: *Vila Verde - Vista Alegre*.

### 3. RESULTS AND DISCUSSION

Through the analysis of the application of *Lenços dos Namorados* (Valentine Handkerchiefs) that can appeal to different social, cultural and economic contexts, namely the songbook, the loving relationship and its direct connection with the religious institution of marriage, symbolism, artistic expression and naturally, the costume of other times.

The customer and user create a dialogue with the product, creating emotional and identitarian relationships and, therefore, an increasingly important role in defining the essence of the product, giving it own story. In this context, the ornamentation and symbols with the popular poetry that has characterized and is characterized lines their production of several feelings often associated, not only, to graphics but also to colour. For example, the pink plus female, refers to something loving and tender; red illustrates the passion; blue idealizing the dream, loyalty and fidelity; green, the freshness and hope; yellow associated with deity and white with purity.

The result will be the creation and retrieval of a culture keeping alive the tradition, the concept and social relations.

#### 4. CONCLUSIONS

Designers can take the cultural richness of a country as inspiration or reference for the creation of their work and innovating new products.

We observed that it is essential the intervention of the design in crafts benefiting from its unique expression and in order to make it proper for the market. However, the intervention strategy should not mischaracterize but enhance and strengthen the regional traditions.

Nevertheless, a craftwork as a product of social, economic and cultural circumstances, suffer, necessarily changes as replaced by market relations, incorporating values of the society. Necessarily have to be transformed, that is, acquire new codes, new functions to reach the consumer.

#### REFERENCES

- Cabral et al, 1998. “*O Ponto de Cruz – a grande encruzilhada do imaginário*”, Lisboa: Museu de Arte Popular. p.42
- Cerqueira, M., 2010. *Minho. E da tradição se faz moda em Portugal*. i [online]. Available: <<http://www1.ionline.pt/interior/index.php?p=news-print&idNota=54007>> [Accessed 5 January 2013]
- Fernandes, M., 2000. *Lenços de Namorados*. Ceramicarte [online]. Available: <<http://www.ceramicarte.com/exposicoes/sala3/mariasameiro/historia.html>> [Accessed 1 May 2013];
- Galeria Vieira Portuense, 2011. *Bordados Tradicionais Portugueses*. Blog. [online]. Available: <<http://bordadostradicionaisportugueses.blogspot.pt/2011/08/dominio-da-mulher-minhota-na-conducao.html>> [Accessed 1 May 2013];
- Neves, M., and C. Gomes, 2008. “Design e Artesanato: Aplicação aos “Lenços de Namorados”, in: *8º Congresso Brasileiro de Pesquisa e Desenvolvimento em Design*. São Paulo: AEND | Brasil pp.2369-2381.
- Silva, P., 2006. *Bordados Tradicionais Portugueses*. Unpublished Master Thesis, Universidade do Minho, Braga, Portugal.
- Vieira, Y., 2011. *Bordar o Futuro*. Revistayvi. [online]. Available: <[http://www.revistayvi.com/index.php?option=com\\_content&view=article&id=370%3Abordar-o-futuro&catid=6%3Amoda&Itemid=8&lang=pt](http://www.revistayvi.com/index.php?option=com_content&view=article&id=370%3Abordar-o-futuro&catid=6%3Amoda&Itemid=8&lang=pt)> [Accessed 5 January 2013];

*Address: Ana Silva, Faculty of Architecture, Technical University of Lisbon,  
Av. de Roma N.º 56, 1º Esq., 1700 – 345 Lisboa, PT  
E-mail: ana\_ccd@live.com.pt*

# Application of the Planetary Colour System

Michel ALBERT-VANEL

## ABSTRACT

A vast study, that has been entitled “Collection Privée”, was undertaken for Keria Peintures, a company which is manufacturing industrial pigments. The study was aimed to the obtaining of colour palettes and nuanciers (colour charts) based onto Impressionist paintings. We were hoping, while doing that, to relate the aesthetic and cultural aspect to the industrial field, considering the reputation enjoyed currently by Impressionist paintings amongst the vast public worldwide.

However we have faced multiple challenges:

- To determine the most representative works of these painters;
- To find a method allowing to extract palettes of colours from these works;
- To gather these palettes in order to create an overall nuancier of almost 1000 tones;
- To be able to transmit this information by Internet, and to print it accurately;
- To show to the user what he/she can do with.

## 1. CHOICE OF PAINTINGS

In the Planetary Colour System, we have catalogued the 22 colour groups that are the most different possible. Therefore, we may use these 22 groups as models, in order to determine which would be the most representative paintings.

It is necessary, indeed, to cover the whole of the colour space so that the user can discover the broadest choice there. The study was not solely based on the Impressionists, but on the Impressionist period. Impressionist paintings are generally clear, and the dark hues they comprise are rather scarce. We thus needed to incorporate the paintings of other authors of the same period, as Forain or Klimt, that are not regarded as belonging to the Impressionist movement. That is why we evoked the “time of the Impressionists”.

But on the contrary, it was also necessary to avoid redundancies, and to draw aside paintings whose coloured ranges were too close. This problem was solved in a two-dimensional table, combining the paintings and the 22 colour groups. Our choice:



## 2. EXTRACTION OF PALETTES

Once the corpus of the study was gathered, it was necessary to carry out a chromatic analysis of these paintings. We used, for this purpose, the method of the squaring, which is allowing to reduce the forms to the minimum, while preserving the essence of the composition (Figure 2).

After multiple tests, it appeared that the most convenient approach was to transform the painting into a squaring of 6 cases out of 7, that is to say 42 nuances of colours.

It is amazing to see how, at distance, this weak definition is high enough to represent the whole of the painting. That may require to punctually report the saturations, since during fusion, the hues may become greyish.

We can check the approach by applying the method of the blur onto this squaring. And the result is satisfactory, if the impression caused by the painting is the same as the impression we may obtain by looking at it with eyes half-closed (Figure 3).

Another method consists in gathering these nuances in a linear development, according to the spectrum of colours, starting in the bluish purple, and finishing in the purplish red.

We may then compare the linear ones obtained, with the 22 idealized colour groups, on the same linear mode. We will see, with interest, that the differences are then very tiny. So we may be sure that we have obtained the 22 palettes that are the most different possible, and the best characterized (Figure 4).



Figure 2: Analyse of a painting from E. Manet.

## 3. OBTAINING AN OVERALL NUANCIER

This information will be then gathered in charts of colours. We shall choose the hue dominant hue, on each table, then we shall organize each one of these tables as it follows: we

shall represent the clearness on the vertical, and the nuances of hues on the horizontal, together with their variations in saturation. Therefore, the colours are defined according to the traditional criteria of hue, clearness and saturation. The method is allowing to associate the combinations of colours to the colorimetric charts of isolated colours. As we have 22 palettes of 42 tones, we thus obtain an overall nuancier of 924 tones, which is rich enough. (Pl.5)

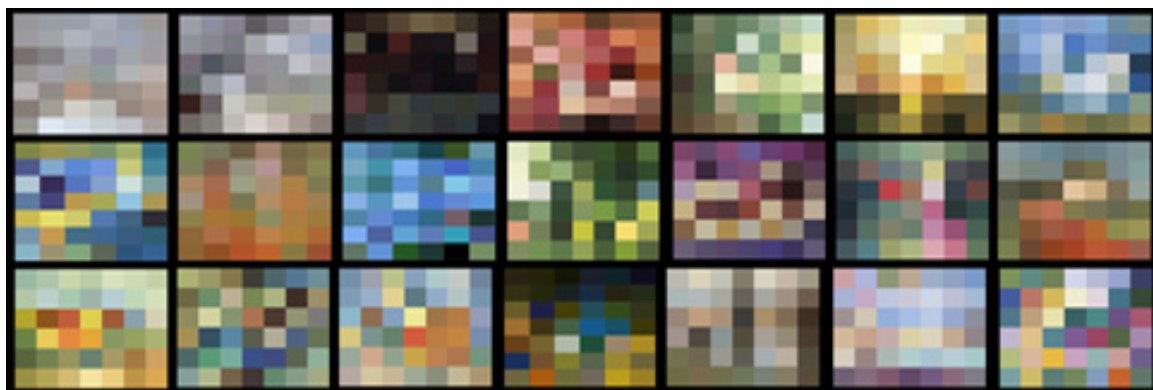

Figure 3: Squaring of the paintings.

#### 4. COMMUNICATION

The last challenge consisted in communicating information to the manufacturing companies by the means of Internet. However it is known that if Internet is widely diffused, the quality of printing is raising a lot of problems, and significant divergences may occur.

We succeeded to solve this problem by standardizing the material: rigorous calibration of computers and displays, use of the same professional type of printer with 7 colour inks, of the same type of photographic paper...

And in spite of that, other factors, such as the ambient temperature, the moisture... can still play a role, and they require the provision of a test chart for calibration, before printing.

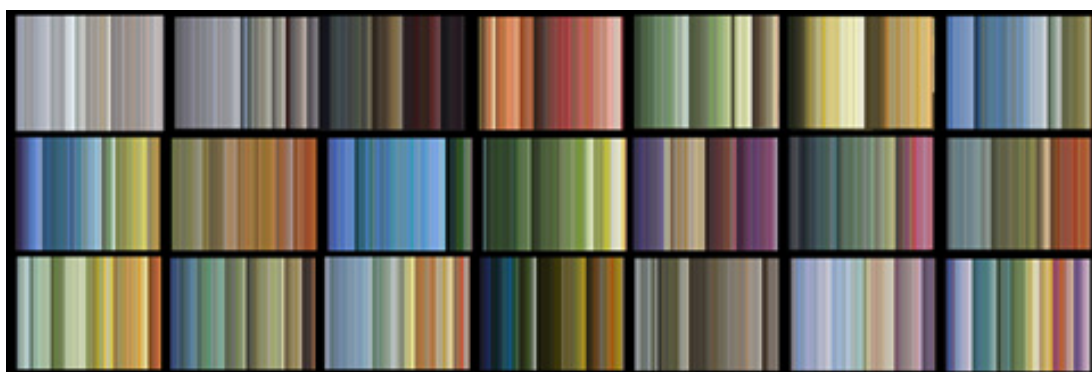

Figure 4: Transformation in linear colour groups.

#### 5. USE

The study and the method we have employed give multiple satisfactions, but they are still awaiting an outlet for trade.

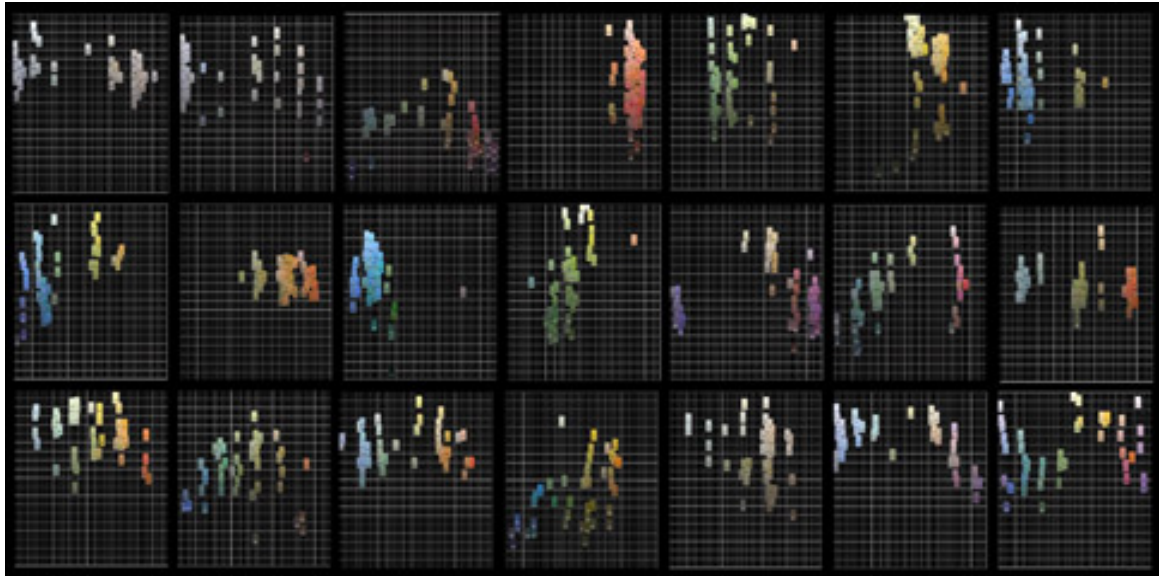
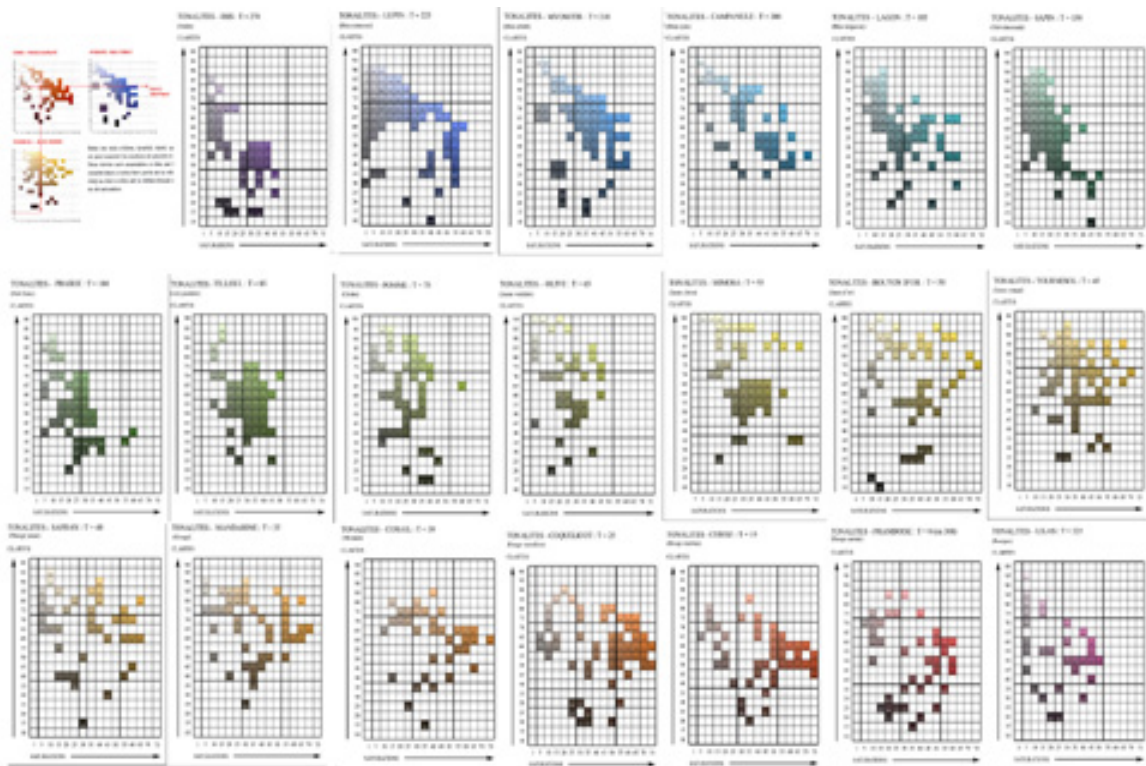

Figure 5: Colour charts of the palettes and nuancier.



## REFERENCES

Egron Eric 2008. *Collection Privée* Paris: Keria Peintures

*Contact: Albert-Vanel@wanadoo.fr, <http://www.albert-vanel.com/joomla/>*



# Natural Colours and its Connection to Human

Ibrahim ELHADY,<sup>1</sup> Reham MOHSEN<sup>2</sup>

<sup>1</sup> Consultant Architect Saudi Arabia, Madinah

<sup>2</sup> College of Applied Arts, Helwan University, Egypt

## ABSTRACT

This paper investigates the relation between what we call harmony in natural colors and human beings. From our point of view this is an important study as it will have number of practical implications in the fields of architecture, printing, textile and other industrial applications. To do that the researchers made a number of technical assumptions in relation to colors organizations and pooling as well as relation to numbers. To test the research hypothesis we carried out an empirical study. The results of this study pointed to certain conclusions regarding the basic relation we are exploring which will help us understand better color preferences of human beings. This paper is composed of four parts; the first is the introduction which is concerned with the context of this research as well as the main assumptions. The second part outlines the methodology and procedure of the research. Third part points to the most important results and finally the conclusion.

## 1. INTRODUCTION

In the numerology we can turn things into numbers and express everything, too brief number can be reduced to a number of (1-9), while the concept of time our sessions every seven days, months or years, this is expressed in colours of the spectrum seven, courses every nine days, months or years, and this is expressed in nine colours (the colours of the rainbow + white and black). We believe that the universe is a single unit and has one creator. We also believe that people are different and that their differences like, but corresponds to different colours.

## 2. METHOD

The most important characteristic of research is the assumed order of natural colours scale (the seven colors of the spectrum + black and white) ranging from white, Red, Orange, Yellow, Green, Blue, Indigo to Violet, and Black giving each colours of the number (1-9) to reflect the degree of colours figure (Figure 1).

1 WHITE	2 RED	3 ORANGE	4 YELLOW	5 GREEN	6 BLUE	7 INDIGO	8 VIOLET	9 BLACK
------------	----------	-------------	-------------	------------	-----------	-------------	-------------	------------

*Figure 1: Natural colour scale.*

The colours of rainbow has been figured through a natural crystal prism (Figure 2) , made by the most expert crystal factory in the region.



Figure 2 (left): a natural crystal prism.

Figure 3 (right): Sample of natural colours of rainbow on the right and equal pigment colours tested on the left.

And then the colours have been all mixed by an academic professional teaching art of colours (Figure 3) , all mixtures were made in art pigments (Figure 4). Then all result colours have been scanned by a professional device to measure colour called “gretag macbeth spectro” that accurately gives the “l a b” of a colour in reality by digital numeric that is applied in the photoshop software (Figure 5).

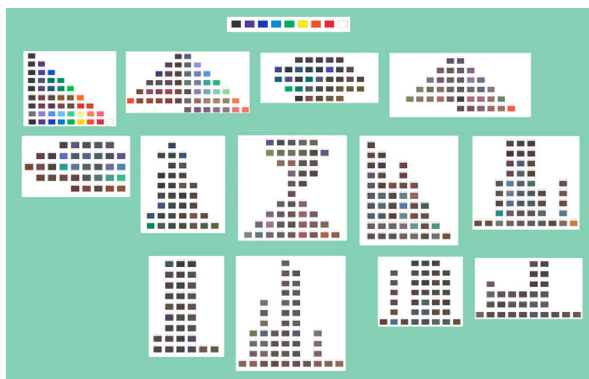
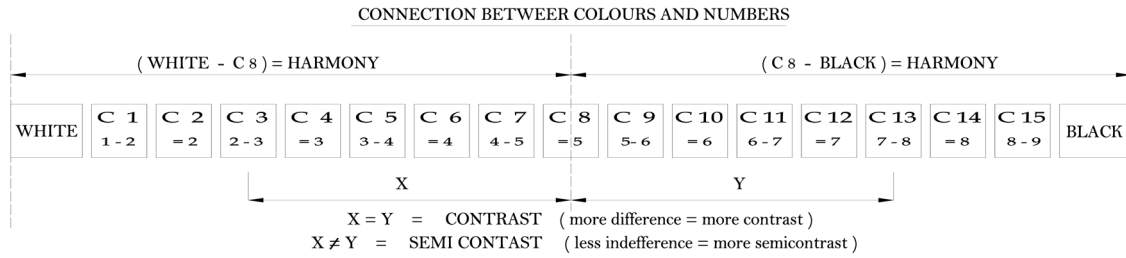

Figure 4 (left): Art pigments.

Figure 5 (right): A professional device to measure colour.

By mixing colours in different proportions we get a No. Per mixture (new colour) expresses the degree of mixture. By pooling mixtures in groups (15 groups) other than white and black have a 17 digit represents 17 major degree by which we can identify favorite and not favorite colours to humans (Figure 6). Search is based on the assumption of equal impact in terms of the degree of equal colours digitally. As a result Suppose harmony between colors digitally converged in one hand and of the scale. Also assume the contrast between two colours (opposite on the color scale). Colours groups we built showed significant which Onconha coupling in class despite the different colour effect just as we expected.



*Figure 6: Colour groups and their connections with numbers.*

So that their sum is ten, and increase unit contrast to increase the difference between digital colours. Also assume semi contrast between every two colours closer to the contrast so as to increase the degree semi contrast proximity to increase the contrast without achieve. And therefore we can make statistical applications to know favorite colour (s) and not favorite.

What drew the most attention in this study is the preference of many to black which we did not expect In contrast, lack of preference for white. Results will have applications in the printing process, monitoring, industrial and professional applications such as acts of architecture, decoration and fabric and maybe in the physical treatment. Although we acknowledge that the accuracy of our work does not reach perfection, we expect that more precision will reach us to more convergence between the class colours bearing the same number. And we can through these groups divided into sub-groups converged influence chromatography achieve more harmony, is also the possibility of contrast and semi contrast account more accurately, thus providing a great service for those working in the areas of colours applications. Also greater understanding of the link humans with colours and that we think they are born with a great deal of bias to each at the expense of the other, then they acquire from the environment and personal experiences more biases may enhance the biases of origin or change, we can deal with the environment colours surrounding the greater the positive which is reflected on the performance of humans. It will be useful for both producers and marketing experts a greater understanding of the relationship of colours in human beings. The discovery of human favorite colours may not be difficult, but we have shown greater interest and at the same time greater accuracy in understanding not favorite colours, which are in both cases (preferred and non-preferred), including all colours with little exception. Job search on the Internet found that this unprecedented research.

### 3. RESULTS AND DISCUSSION

Statistical study has been made by the researchers about the most favorite and not favorite colours among both; the colour ruler of nine colours (7 rainbow + black and white) (Table 1). and the 15 group of colors (in between mixed) (Table 2). The statistical study showed that th relationship between the favorite colours and non favorite to human as we supposed with the correct rate of deviation (0.185 for nine colours and 0.183 for groups).

Table 1: Survey results (for main scale).

colour	white	red	orange	yellow	green	blue	indigo	violet	black	-	total
colour number	1	2	3	4	5	6	7	8	9	-	
favorite colour	42	65	38	17	24	104	74	74	53	0	491
not favorite colour	18	38	46	130	38	14	26	23	30	1	364

**Notes :** Highest favorite colour is 104  
 highest not favorite colour is yellow 130  
 least favorite colour is yellow 17  
 least not favorite colour is blue 14  
 favorite colour descending: blue-(indigo-purple) - red- black- white- orange- green - yellow  
 not favorite colour descending: yellow - orange- (red-green) -black-indigo- purple - white- blue:  
 only one case does not have a "not favorite" colour  
 total survey number of cases 275  
 favorite colour over average: blue-indiago- purple- red-black :  
 not favorite colours over average: yellow- orange- red -green :  
 the one colour over average in both cases is red

Table 2 : Survey results (for groups).

group	semi red		semi orange			semi yellow			semi green		semi blue		semi indigo		semi vilote		total
group number	1	2	3	4	5	6	7	8	9	10	11	12	13	14	15	-	
favorite group	32	32	37	42	41	48	78	74	79	26	43	19	27	9	9	3	599
not favorite group	64	28	39	21	23	19	16	13	16	17	19	35	33	67	119	3	532

**Notes :** highest favorite group : 9 (green-blue) 79 times  
 highest not favorite group : 15 (green-blue) 119 times  
 least favorite group : 15 (green-blue) 17 times  
 least not favorite : 8 (green) 13 times  
 best group dsceinifng : 9 - 7 - 6 - 11 - 4 - 5 - 3 - 8 - ( 1 . 2 ) -13 - 10 - 12 - ( 14 . 17 )  
 not best group dsceinifng : 15 - 14 - 1 - 3 - 12 - 13 - 2 - 4 - 5 - ( 11 . 6 ) - 10 - ( 9 . 7 ) - 8  
 three cases have no fsvorit group, three cases have no not favorite group  
 total 275  
 groups over average : 4 - 5 6 - 7 - 8 - 9 :  
 groups : 1 - 3 - 14 - 15

#### 4. CONCLUSIONS

Order of the colours on the digital scale (1-9) gives us a broader understanding of the relationship between colours in terms of harmony, contrast, semi contrast and estimation of the degree of colour, also gives us a broader understanding of their relationship to human beings by knowing favorite colour and thus direct knowledge of colour is not preferred, by colour test for natural persons, and also the great benefits in practical applications in all aspects of life and reflection benefit rights.

#### REFERENCES

Coehni, R.G. and A. Schwarz 2008. A survey of colour system from antiquity to the present.  
 Coehni R.G. and M.H. Brill 2003. Color order from antiquity to the present.

*Addresses: Ibrahim Elhady, Consultant Architect Saudi Arabia, Madinah, P.O box 3842  
 Dr Reham Mohsen, Associate Prof., College of Applied Arts, Helwan University, Egypt  
 Emails: ib\_elhady@yahoo.com, dr.reham.mohsen@gmail.com*

# Chromatic Differences Introduced by Microscope Optics

Juan MARTINEZ-GARCIA,<sup>1,3</sup> Roshanak ZAKIZADEH,<sup>2,3</sup>

Kiran B. RAJA,<sup>1,3</sup> Christos SIAKIDES<sup>1,3</sup>

<sup>1</sup> Gjøvik University College, The Norwegian Colour Research Laboratory, Gjøvik, Norway

<sup>2</sup> University of Eastern Finland, School of Computing, Joensuu, Finland

<sup>3</sup> Erasmus Mundus Master “Color in Informatics and Media Technology” (CIMET)

## ABSTRACT

In this study we determined the chromatic difference introduced by the optics of two different microscopes: Olympus SZX10® and Nikon ECLIPSE MA200®, by carefully measuring the 24 different colours of the GretagMacbeth ColorChecker® with a spectroradiometer through the observation eyepiece of the microscopes and computing the chromatic and colour differences with the measured values of the patches without the microscope.

The results obtained for the Olympus SZX10® microscope show a mean chromatic difference of 6.52, 4.45, 5.56, 3.52, 3.85, 4.22, and 4.48 units; and a mean colour difference of 7.56, 5.60, 9.55, 4.99, 4.98, 5.48, and 5.69 units for CIELAB, CMC, BFD, CIE94, CIEDE2000, DIN99d and DIN99b, respectively.

On the other hand the results obtained for the Nikon ECLIPSE MA200® microscope show a mean chromatic difference of 10.34, 6.48, 8.30, 5.28, 6.15, 3.72, and 6.86 units; and a mean colour difference of 13.31, 9.45, 17.19, 9.22, 9.04, 7.87, and 10.24 units for CIELAB, CMC, BFD, CIE94, CIEDE2000, DIN99d and DIN99b, respectively.

## 1. INTRODUCTION

Reliable colour appearance in microscopy systems is very important for a wide array of fields, such as microbiology and medicine, since an inaccurate appearance in sample assessment can lead to wrong conclusions in decisive situations. Furthermore, the chromatic difference introduced by the optics in modern microscopes is commonly regarded by the retailers as negligible.

The relationship between the perceived and the instrumentally measured colour difference is an on-going research field of research in colour science and several formulas have been developed to estimate the perceived colour difference between two measured samples based on numerous psychophysical experiments. In this study several of these classical and advanced colour difference formulas, namely, CIELAB (CIE,2004); CMC (Clarke et al., 1984); BFD (Luo and Rigg, 1987); CIE94 (CIE, 1995); CIEDE2000 (CIE, 2001); DIN99d and DIN99b, have been used to determine the chromatic and colour differences introduced by the optics of two different microscopes by measuring the commonly used set of 24 different colours denominated GretagMacbeth ColorChecker®.

## 2. METHOD

The two microscopes used for the experiment (see Figure 1) were: Olympus SZX10® (Olympus, 2013) and Nikon ECLIPSE MA200® (Nikon, 2013).



Figure 1: Left: Olympus SZX10®. Right: Nikon ECLIPSE MA200®

To measure the samples and determining the chromatic and colour difference introduced by the optics of the microscopes, a spectroradiometer was fixed in a position in direct contact with the observation eyepiece of the microscope and the spectral intensity was measured. The same measurements were also made without the microscope optics to assess the difference introduced.

Due to geographical and availability constraints, the microscopes were studied in different laboratories following the same experimental methodology, nevertheless the objective of the study is not to directly compare the microscopes but to highlight the magnitude of the chromatic differences introduced.

The spectroradiometers used were: Konica Minolta CS 1000A® (Konica Minolta, 2013) with the Olympus SZX10® microscope, and Konica Minolta CS-2000® (Konica Minolta, 2013) with the Nikon ECLIPSE MA200® microscope.

The samples measured are the ones present in the GretagMacbeth ColorChecker®, which is a colour calibration target consisting of a cardboard-framed arrangement of 24 squares of painted samples (see Figure 2).

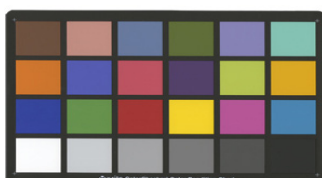

Figure 2: GretagMacbeth ColorChecker®

### 3. RESULTS AND DISCUSSION

From the measurements obtained, the CIELAB coordinates were calculated and plotted in the  $L^*a^*b^*$  diagram for a visual perception of the chromatic shift (Figure 3), where it can be seen that there is a clear influence of the optics in the colour measured with and without the optics.

Furthermore, chromatic and colour differences were determined by using a wide set of colour-difference formulas, namely: CIELAB, CMC, BFD, CIE94, CIEDE2000, DIN99d and DIN99b. The mean results from the 24 samples are shown in Table 1 and Table 2.

The chromatic differences introduced by the microscope optics for each of the 24 samples can be seen in Figure 4.

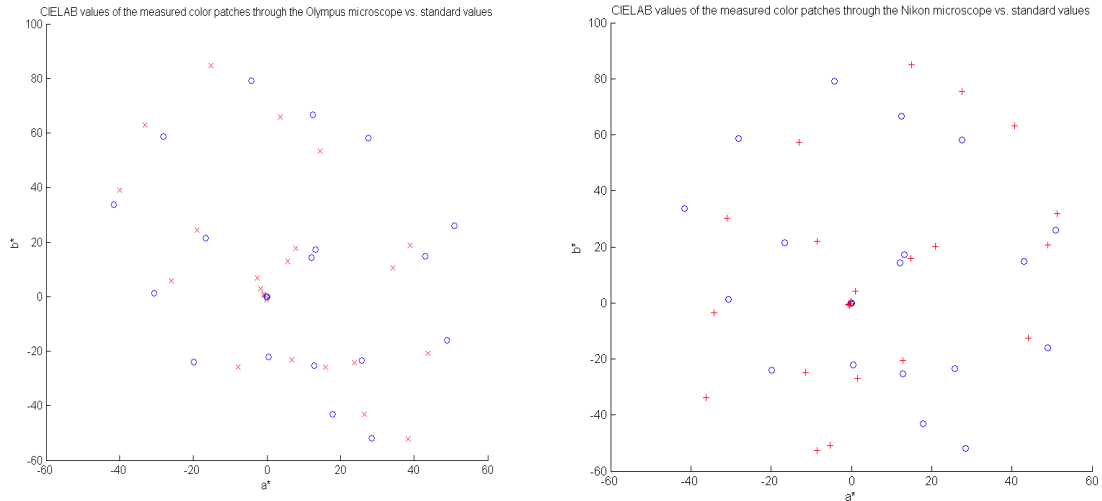

Figure 3: Chromatic shift introduced by the optics.  
The circled blue value represents the values measured without the optics.

The results show that in most of the cases the chromatic difference introduced by the microscope optics surpasses the just noticeable visual differences thresholds previously reported in the literature (Melgosa et al., 1992) which are between 0.5 and 1 CIELAB units for different experimental datasets.

Table 1: Mean chromatic differences introduced by the microscope optics

	CIELAB	CMC	BFD	CIE94	CIEDE2000	DIN99d	DIN99o
Olympus SZX10®	6.52	4.45	5.56	3.52	3.85	4.22	4.48
Nikon ECLIPSE MA200®	10.34	6.48	8.30	5.28	6.15	3.72	6.86

Table 2: Mean colour differences introduced by the microscope optics

	CIELAB	CMC	BFD	CIE94	CIEDE2000	DIN99d	DIN99o
Olympus SZX10®	7.56	5.60	9.55	4.99	4.98	5.48	5.69
Nikon ECLIPSE MA200®	13.31	9.45	17.19	9.22	9.04	7.87	10.24

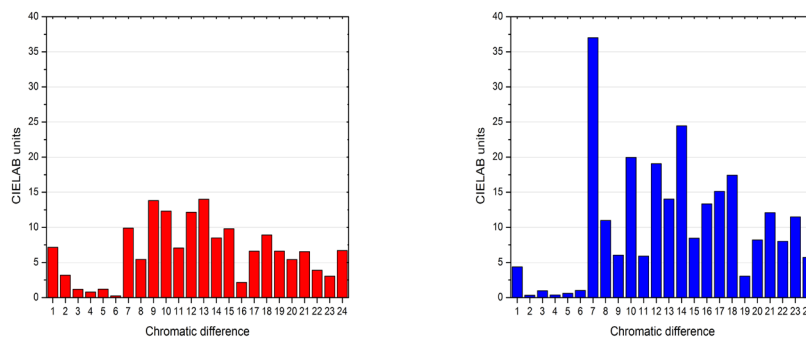

Figure 4: Chromatic differences introduced by the microscope optics for each sample.  
 Left: Olympus SZX10®. Right: Nikon ECLIPSE MA200®

#### 4. CONCLUSIONS

A study was carried out to determine the influence of the microscope optics in the colour appearance of the samples observed by them. The results show that the chromatic differences introduced by the optics of the microscope tested was significant, surpassing the just noticeable visual difference thresholds previously reported in the literature.

According to these results, chromatic influence should not be considered negligible and should be determined, especially in the cases where colour discriminations is of high importance.

#### REFERENCES

- CIE, 1995. *Industrial Colour-Difference Evaluation*. Vienna: CIE, 1995.
- CIE, 2001. *Improvement to Industrial Colour-Difference Evaluation*. CIE, 2001.
- CIE, 2004. *Colorimetry, Publication CIE 15:2004*. Vienna: CIE, 2004.
- Clarke, F.J.J., R. McDonald and B. Rigg, 1984. Modification to the JPC79 colour-difference formula. *J. Soc. Dyers Colour* 100, 128-132.
- Konica, 2013. Konica Minolta: <http://sensing.konicaminolta.asia/products>
- Luo, M.R., and B. Rigg, 1987. BFD(l:c) colour-difference formula. Part 1. Development of the formula. *J. Soc. Dyers Colour* 103, 86-94.
- Melgosa, M., E. Hita, J. Romero and L. Jimenez del Barco, 1992. Some classical color differences calculated with new formulas. *J. Opt. Soc. Am. A* 9, 1247-1254.
- Nikon, 2013. ECLIPSE MA200 microscope: <http://www.nikon.com/products/instruments/lineup/industrial/industrial-microscopes/inverted/ma200/index.htm>
- Olympus, 2013. SZX10 microscope: [http://www.olympusamerica.com/seg\\_section/product.asp?product=1018](http://www.olympusamerica.com/seg_section/product.asp?product=1018)

*Address: Gjøvik University College,  
 The Norwegian Colour Research Laboratory, Gjøvik, Norway  
 E-mails: martiezgjuan@gmail.com, rzakizadeh@gmail.com,  
 kiran.bylapparaju@gmail.com, chris.siakidis@gmail.com*



# Effects of Rhizosphere Microorganisms Drench on Growth Development and Flower Color of Cyclamen Neon Rose

Yoosun KIM,<sup>1</sup> Chaeyun MOON<sup>2</sup>

<sup>1</sup>Professor, Dept. of Environmental Green Design, Sahmyook University

<sup>2</sup>Adjunct Professor, Dept. of Environmental Green Design, Sahmyook University  
The doctor's course, Dept. of Space Design, Hongik University

## ABSTRACT

In recent times, the use of microorganisms is on the rise in the pharmaceutical industry, genetic engineering industry as well as in the home for the prevention of disease and pests, treatment of livestock excretion, and odor removal. With regard to agriculture, the utilization of microorganisms is already being established as an indispensable technology. However, there are still almost no reports of the examples of its use in the floricultural area, and there are only a few research cases except for several cases. Hence, this study was conducted to perform drenching on *Cyclamen persicum* Mill 'Salmon with Eye' with *Photosynthetic bacterium*, *Bacillus subtilis*, *Lactobacillus plantarum*, which are known as effective microorganisms 7 times in 2 week intervals, and examine its effects on the growth development and flower color, and provide a baseline data for the production of high quality potted cyclamen. The summary of the results are as follows. In growth and development, the microorganism treated plot received less high temperature damage or quickly recovered. Even the flower color of cyclamen was clearer in the untreated plot compared to that of the microorganism treated plot. However, there was somewhat of a difference by the type of microorganisms, and since there were differing effects for each area of the plant body depending on the concentration treated plot, the researchers judged that experiments for seeking the appropriate microorganism type and concentration should continue. Furthermore, it is expected to be able to be grafted to various flowering plants in a number of ways.

## 1. INTRODUCTION

*Cyclamen persicum* is a representative potted plant that is highly popular and has a great demand in not only Europe but also Korea (Park, Kim, 2011). *Cyclamen* is a bulb belonging to the *primula* family. Its place of origin is widely distributed in Europe, Asia, and Africa, and is known to have 15-20 species. It originated from a Greek term, 'Kyloos' meaning circle because the flower stalk rolls up into a spiral as the seed is formed (Park, 2010). The flower color is diverse as proportionate to the number of various breeds, but in Korea, it mainly consists of red, pink, purple, and white.

In recent times, the use of microorganisms is on the rise in the pharmaceutical industry genetic engineering industry as well as in the home for the prevention of disease and pests, treatment of livestock excretion, and odor removal. With regard to agriculture, the utilization of microorganisms is already being established as an indispensable technology. However, there are still almost no reports of the examples of its use in the floricultural area, and there are only a few research cases except for several cases (Park, 2010; Kim, Lee, 2012). The microorganism applications currently circulated in farms has a lot of problems in maintaining the vitality of the included strain and its reaction, and farms lack knowledge regarding this. Therefore, there is a need to develop a strain that has a high beneficial effect such as growth

promotion of plants and disease tolerance, and excellent biological activity (Schippers et al., 1997).

For this reason, this study was conducted to examine the effects of the type of rhizosphere microorganism and treatment concentration on the growth development and flower color of cyclamen, and provide a baseline data for the production of high quality potted cyclamen.

## 2. METHOD

### 2.1 Testing Materials & Microorganism Treatment

For the cyclamen used in this experiment, *Cyclamen persicum* Mill 'Neon Rose' was selected as it is a medium breed which has a convenient culturing method and excellent marketability (Figure 1).



Figure 1: The cyclamen used in this experiment, *Cyclamen persicum* Mill 'Neon Rose'.

Seed was sown on the nursery, and uniform seedlings with 4-5 normal leaves were temporarily planted in a 40-hole plug after 30 days. 30 days after the temporary planting, it was planted on a plastic pot with a diameter of 13cm. The culture medium used in the temporary planting and planting used a mixture of peat moss (Teracult, Germany) and 0.3mm particle (Miseong Industry, Korea) with a ratio of 5:1 (v/v, peat moss: perlite).

For cyclamen cultivation, temperatures were maintained at 15-24°C with bed cropping method using a ventilator depending on the weather. A layer of shading net was installed on the vinyl greenhouse before blossoming, and cyclamen was cultivated without any shade once it started flowering. For irrigation, water was supplied by bottom watering every 5 days, and diluted liquid fertilizers were supplied every 2 weeks. In addition, foliar application of fertilizer was performed if necessary. Furthermore, chemicals were frequently sprayed for pest control against gray mold, frankliniella occidentalis pergande, and mites.

Microorganisms were treated 7 times in two week intervals after planting, and treatment concentration was 0, 1, 2, 3, 10, and 20mL·L<sup>-1</sup>, and 50mL drenching was performed on every pot.

### 2.2 Preparation of Rhizosphere Microorganism and Treated Quantity

For the screening of effective microorganism, readily available and widely used *Photosynthetic bacterium*, *Bacillus subtilis*, and *Lactobacillus plantarum* were selected (Kobayashi, Nakaniishi: 1981, Kyoungkido: 2009).

### Microbial Count Measurement

For the microbial count measurement, the number of microorganisms were measured by observing each number of colonies which has appeared on the plane table with a phase difference microscope by culturing it for 48 hours at 30°C after performing agar smear plate method and moderately diluting them on TSA (tryptic soy agar) and PDA (potato dextrose agar) (Figure 2).

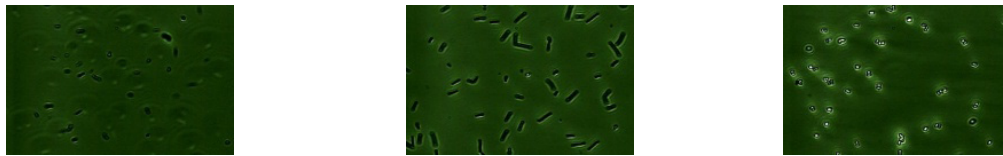

(P. bacteria) (B. subtilis) (L. plantarum)

Figure 2. Phototrophic bacterium, *Bacillus subtilis*, *Lactobacillus plantarum* with X-ray microscope ( $\times 2800$ ).

**Flower Color Analysis**

Color measurement was performed by using a color meter (X-rite Eye-One Xtreme iO bundle) with a standard light source (Philips TL-D 90 Graphica Pro 36W/950). By measuring chromaticity, the flower color was expressed with CIE  $L^*a^*b^*$  color system.

**Statistical Analysis**

ANOVA (analysis of variance) analysis was conducted using SAS package (statistical analysis system, version 9.1, SAS Institute Inc.), which is a statistical analysis program. The statistical analysis of the significance between each treatment was performed at a 5% level of DMRT (Duncan’s multiple range test).

Table 1. Effect of Effective Microorganism on Color of Potted Cyclamen ( $L^*a^*b^*$ ) after 120 days.

Treatment Concentration (mL·L <sup>-1</sup> )	Photosynthetic bacterium			Color chip	Bacillus subtilis			Color chip	Lactobacillus plantarum			Color chip
	Color				Color				Color			
	L*	a*	b*		L*	a*	b*		L*	a*	b*	
0	45.0b <sup>x</sup>	62.1a	7.8a		45.9a	58.1b	0.9a		45.9ab	58.1c	0.9bc	
1	39.1c	55.1a	5.3a		45.8a	68.0a	6.0a		44.6a-c	67.0ab	6.9ab	
2	50.9a	63.2a	2.8a		44.7a	67.2a	5.9a		41.8bc	65.8ab	4.9ab	
3	46.6ab	62.9a	5.3a		46.3a	68.5a	7.8a		41.1c	59.4c	4.9c	
10	47.8ab	55.8a	2.7a		47.0a	66.5a	2.8a		46.7a	69.2a	8.8a	
20	45.9ab	58.1a	0.9a		45.2a	66.7a	8.8a		42.8a-c	64.1b	1.7a-c	

<sup>x</sup>Mean separation within columns by Duncan’s multiple range test,  $p=0.05$ .

**3. RESULT AND DISCUSSION**

**Effect of Effective Microorganism on Color of Potted Cyclamen**

Regarding the changes of flower color, the phototrophic bacteria have low brightness in untreated plot and the low concentration treatment of 1mL·L<sup>-1</sup>. With respect to bacillus bacteria, the flower color of microorganism treatment was clear-cut and distinct than untreated plot. In lactic acid bacteria, a clear-cut flower color can’t be seen in untreated plot and 20mL·L<sup>-1</sup> treatment. It has low brightness in 2,3mL·L<sup>-1</sup> and has the most clear-cut flower

color in 1, 10mL·L<sup>-1</sup>. Although the selection criteria of beautiful color varies according to the preferred color, when viewing it from the standard of potted plant quality evaluation (Lee Yeong-han, Yun Han-dae, Ha Ho-seong, 1996), photosynthetic bacteria have high definition in mid-brightness, bacillus bacteria was clear in microorganism treated compared to that untreated plot. Lactic acid bacteria were clear in particular concentration compared to untreated plot (Table 1).

It is assessed that the plant growth and flower color has accelerated (Nah, 1997) as various photosynthetic substances and physiological active substances synthesized by the fungus body are supplied to the plant.

#### 4. CONCLUSION

In general, microorganisms that has had an effect on the growth upon microorganism treatment also had an effect on the flower color, and when potted plants significantly affected by the environment is treated with microorganism, a tolerance forms which is less affected by the environment.

Although it was unable to be shown in numbers, the disease outbreak that appeared in untreated plot did not appear in microorganism treatment. In addition, since the flower color can raise the clearness in low concentration, there is effectiveness with a less amount of microorganism treatment, and it is expected to be helpful in use at farms. However, because the effectiveness were different according to the type or concentration of the microorganism, depending on different breeds even if they were of the same species, or depending on each different types of plants, the researchers believed that there should be continued research on the microorganisms which take effect and the concentration of these microorganisms, and this study should be applied to various plants.

#### REFERENCES

- Kim, Y.S, and Y.L. Lee, 2012. Effects of Rhizosphere Microorganisms Drench on Growth Development and Flower Color of Potted Cyclamen. *Korean Society for People, Plants and Environment* 15(4): 273-280.
- Park, K.Y., 2010. *Effects of Soil Microorganisms on Growth and Quality of Cyclamen Pot Plants*. University of Seoul. Master's thesis.
- Park, K.Y., and Y.S. Kim, 2011. Effect of Microbial on Flower Color and Pot Quality of Pot Cyclamen. *Korea Society of Color Studies* 24(3): 27-34.
- Lee Y.H., H.D. Yoon and H.S. Ha, 1996. Isolation and Identification of Plant-Growth-Promoting Bacteria and Their Effect on Growth of Red Pepper (*Capsicum annum* L.). *Korean Society of Soil Science and Fertilizer* 129(4): 271-277.
- Nah, K.C., J.Y. Cho and S.J. Chung, 1997. Effects of compost supplemented with cultured solution of photosynthetic bacteria on the daily growth of plug seeding of tomato. *Kor. J. Organic Agriculture* 5(2): 105-115.
- Schippers, B., A.W. Bakker and H.M. Bakker, 1987. Interactions of deleterious and beneficial rhizosphere microorganisms and the effect of cropping practices. *Annu. Rev. Phytopathol.* 25: 339-358

*Address: Professor, Yoosun Kim, Department. of Environmental Green Design,  
Sahmyook University, Hwarangro-815, Nowon-gu, Seoul, KOREA  
E-mail: kyscolor@syu.ac.kr*

# Origin and spreading of Ṭūsī's ideas on color ordering

Eric KIRCHNER  
Leiden, the Netherlands

## ABSTRACT

In a previous publication, we discussed the color ordering proposed by Nasīr al-Dīn al-Ṭūsī (Maragha, d. 1274). Here, we investigate some of the origins of the color terms used in this ordering. We also show how the new color ordering spread in the Islamic world during the next four centuries by including them in the most well-known book on optics of the period, the *Tanqīḥ al Manāẓir* of Kamāl al-Dīn al-Farīsī (d.1319).

## 1. INTRODUCTION

According to Aristotle, all colors can be ordered in a linear series from white to black. This ordering may have been mainly according to their lightness. The first description of color space beyond this ancient one dimensional representation was given by Ibn Sīnā (Avicenna, d. 1037), who states that there are three paths by which white gradually changes to black. These paths lead over yellow, red and green, respectively (Kuehni and Schwarz, 2008). In Latin Europe, this new color ordering system became well known because of its inclusion in Vincent de Beauvais' *Speculum majus* in 1244. The essentially two-dimensional color ordering proposed by Ibn Sīnā was elaborated upon by the famous scholar Nasīr al-Dīn al-Ṭūsī (Maragha, d. 1274). Instead of assuming three paths from white to black, Ṭūsī proposed there were not less than five paths, leading over yellow, red, green, blue and grey, respectively. And instead of the six colors specifically mentioned by Ibn Sīnā as being positioned between white and black, Ṭūsī gave the names of 25 different colors. The text in which this color ordering is proposed is translated as follows (more terms appear in Figure 1):

Regarding the production of colors from black and white there are numerous paths, from which one gradually walks from white to black. The path through yellow belongs there: First by the mixing of dense and fire, both in small amount, the straw-yellow is produced, then the lemon-yellow, then the saffron-yellow, then the orange-yellow, then the pomegranate-yellow, then [...] until it becomes black. Another path goes through red. First it becomes rosy, then like evening-red, then blood-colored, then purple, then violet, violet-colored. One path goes through green [...] One path goes through blue [...]. One path goes through turbidity/dirt. It becomes grey, then darkish/dirt-colored, then dark *etc.* (full translation: Kirchner and Bagheri, 2013).

We note that this translation slightly differs from earlier translations (all based on Wiedemann, 1908), because of an error that we found in the work of early copyists of the manuscript text. The text with the new color ordering appears in a letter from Ṭūsī to al-Kātibī. Unlike Ibn Sīnā's text, the contents of Ṭūsī's letter never seems to have found its way to Latin Europe. The only spreading of Ṭūsī's color ordering that is known is that five different manuscript copies of the letter have been identified (Kirchner and Bagheri, 2013).

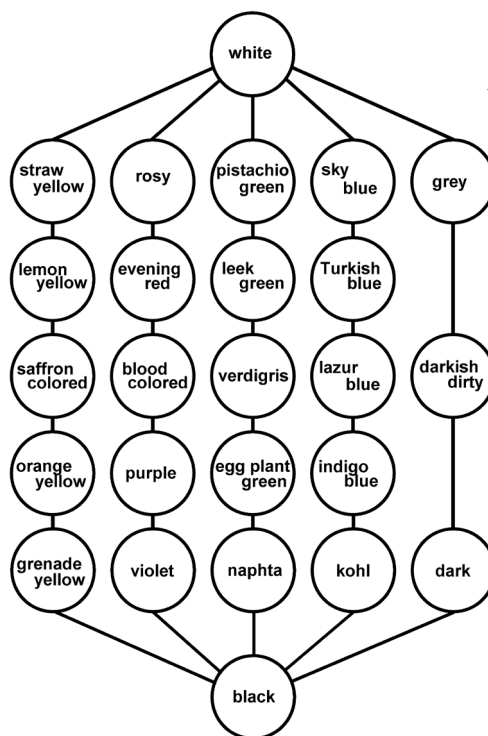

Figure 1: Color ordering according to Ṭūsī (reconstruction).

We will discuss origins of color terms used by Ṭūsī. We show that there was a major transmission channel, hitherto unknown, by which Ṭūsī’s color ordering widely spread in the Islamic world during the next four centuries. We note that Ṭūsī also published new ideas on color mixing, also finding wide distribution in the Islamic world, possibly even influencing pre-modern color science in Latin Europe (Kirchner and Bagheri, 2013).

## 2. ORIGINS OF TERMS IN ṬŪSĪ’S COLOR ORDERING

How problematic are the translations of these Persian color terms? The translation of color terms in e.g. Homeric Greek has been controversial in academic circles since more than a century. But in contrast to the Homeric color terms almost all color words used by Ṭūsī are well known from earlier and/or contemporary sources (we note that the same conclusion was drawn by Sabra (1989) when discussing several of the same color terms in the work of Ibn al-Haytham). Thus, the words used for black (*aswād*), white (*abyaḍ*) and grey (*ūghbar*), but also purple (*arjawānī*), violet (*banafṣajī*), rosy red (*wardī*), kohl (*kuhlī*) and indigo-blue (*nīlī*) were common words in old Arabic. Many words from Ṭūsī’s color ordering are known to have been common in contemporary Persian. For example, the famous Persian poet Hafiz (d. 1389) used the same color terms as Ṭūsī when describing the purple (*arjawānī*) color of flowers, the verdigris (*zangārī*) color of the vault or the indigo-blue (*nīlī*) dome of a fortress (Yousofi, 1977). Also the Turkish-blue (*fīrūzaj*) and lapis-lazuli (*lāzwardī*) colors common words, whose coloristic meanings are well established.

Although not known as color terms, the meaning of some other terms are equally straightforward. Poets compared the color of eyes with lapis lazuli already in the ninth century, the color of violet flowers with the violet-*banafṣajī* color, the color of skin with straw-*tibnī* and the color of iron ore with pomegranate-*nārī* (Schimmel, 1992). Ṭūsī’s color terms often refer to clearly identifiable objects, making the coloristic meaning relatively straightforward. Most of the remaining color terms are of this category, and their meanings can be found in

Steingass' (1892) authoritative dictionary. Interestingly, six of Ṭūsī's color terms would later become a root of current English words: saffron-*za'frānī*, orange-*nāranjī*, naphta-*naftī*, kohl-*kuhlī*, azure-blue/lapis-lazuli-*lāzwardī* and pistachio-*fustuqī*.

We also note that many color terms appearing in Ṭūsī's ordering already appear in the Book of Optics of Ibn al-Haytham (d. ca. 1040, Cairo), the *Kitāb al-Manāẓir* Book I (Sabra, 1989). Even more terms can be found from the Persian polymath al-Bīrūnī (d. 1048, Ghazni), who uses color as one of the characteristic properties of gem-stones in his famous lapidary *Kitāb al-jamāhir*. When describing different types of rubies al-Bīrūnī writes about colors ranging from sky-blue-*asmānjūnī*, via lapis-lazuli-*lāzwardī* and indigo-blue-*nīlī* to kohl-*kuhlī*. Comparing this sequence with Ṭūsī's arrangement, we only miss the white and black end-points and the intervening Turkish-blue-*fīrūzaj* (Krenkov, 1936). Al-Bīrūnī gives a similar path for yellow-red as Ṭūsī (but adding apricot-colored-*mishmishī*), and also for green (now adding olvine-colored-*zāītī*), while leaving out some other terms. Thus, not only do many color words in Ṭūsī's color ordering already occur in al-Bīrūnī's work, but the latter also provided several partial orderings of these colors. It seems that Ṭūsī's role was to extend the list of color names, and to combine all the color orderings into one consistent grand scheme.

### 3. LATER PRESENTATIONS OF ṬŪSĪ'S COLOR ORDERING

One would think that the text of Ṭūsī's letter to al-Kātibī was unknown to almost all later scholars, because until modern times none of these manuscript copies seems to have traveled outside the Persian region. Being published as a letter rather than as part of a book, its audience remained small.

But despite the small distribution of Ṭūsī's letter among later scholars, we recently found that its text on color ordering did find a wide audience both geographically and over the centuries. Probably just before 1304, Kamāl al-Dīn al-Fārisī published a new work on optics, the *Tanqīḥ al-Manāẓir* ("Revision of the Optics"). It is a critical commentary on Ibn al-Haytham's *Kitāb al-Manāẓir*, including al-Fārisī's own treatment of the material. As an appendix to the discussion of *Kitāb al-Manāẓir*, al-Fārisī included text that he states to have copied from another work, a then still unpublished and now no longer extant commentary on Ibn Sīnā's *Canon*. That commentary was being written by al-Fārisī's master Quṭb al-Dīn al-Shīrāzī (d.1311), himself a former student of Ṭūsī. In this appendix we find almost literally the same text with color ordering as in Ṭūsī's letter, which had been written some 25 years earlier (al-Fārisī, 1928, p.334). Taking the modern Nourānī (2005) edition of Ṭūsī's letter as a reference, the text from the modern 1928 edition of the *Tanqīḥ* shows only a few deviations: (i) the word for rosy is correctly spelt as *wardī* in the *Tanqīḥ*. This confirms our previous reconstruction for this word (Kirchner and Bagheri, 2013), and shows that readings like *zwardī* and *lāzwardī* in earlier manuscript copies of Ṭūsī's were indeed copying errors. (ii) the word for blood-colored (*damawī*) is not included in the color ordering in the *Tanqīḥ*. (iii) The words pomegranate (*nārī*) and walnut-colored (*jaūzī*) are included in the text of the *Tanqīḥ*, but only in some copies of Ṭūsī's letter.

The 1928 edition of the *Tanqīḥ* contains many printing errors (Sabra, 1989). Therefore we examined photocopies of the recently discovered autograph manuscript of the *Tanqīḥ* (Adilnor collection). In the text related to color ordering we found no differences between the autograph manuscript and the 1928 edition. From the *Tanqīḥ*, fifteen manuscript copies are known still to exist in libraries all over the world, nine of them dating from the seventeenth century (Sabra, 1989). Therefore through the *Tanqīḥ* also Ṭūsī's text on color order-

ing became widely spread geographically, and well transmitted through the ages. This may have led later scholars to further develop the color ordering proposed by Ṭūsī. Indeed, works on optics and/or vision that contain commentaries to the *Tanqih* are known from Islamic scholars ranging from the fourteenth to the nineteenth century (Kheirandesh, 1998 and 2001; Sabra, 2007). Probably the most well-known later Islamic scholar of optics was Taqī al-Dīn ibn Ma'rūf (d. 1585, Istanbul). His optical work the *Kitāb Nūr* dates from 1574, and contains a summary and commentary of the works of Ibn al-Haytham and al-Fārisī. Topdemir (1999) showed that in that work the theories of light and color vision as developed in *Kitāb al-Manāẓir* and in the *Tanqih* are compared with each other. Therefore the *Kitāb Nūr* does not discuss the appendices in the *Tanqih*, explaining why the *Kitāb Nūr* does not contain Ṭūsī's color ordering.

### ACKNOWLEDGEMENTS

I thank Basil Adilnor for providing photocopies of al-Fārisī's autograph manuscript of *Tanqih al-Manāẓir* (Adilnor collection), Hüseyin Topdemir for his Ph.D. thesis on *Kitāb Nūr*, and Karim Skakni and Tarek Hannoudi for help with some of the translations.

### REFERENCES

- Kamāl al-Dīn al-Fārisī, 1928. *Tanqih al-Manāẓir*, 2 vols. Hyderabad: Deccan.
- Kheirandish, E., 1998. The 'Manāẓir' tradition through Persian sources. In *La science dans le monde Iranien*, ed. by Z. Vesel, H. Beikbaghban and B. Thierry de Crussol des Epeesse. Téhéran: Institut Français de recherche en Iran, 125-145.
- Kheirandish, E., 2001. Optics: Highlights from Islamic Lands. In *The Different Aspects of Islamic Culture Vol. Four Part I*, ed. by A.Y. al-Hassan. UNESCO, 337-357.
- Kirchner, E., and M. Bagheri, 2013. *Color theory in Medieval lapidaries: Nīshābūrī, Ṭūsī and Kāshānī*, Centaurus 55:1-19.
- Krenkov, F., 1936. *Al-jamaher fi ma'refat al-javaher*. Hyderabad: Deccan.
- Kuehni, R.G. and A. Schwarz, 2008. *Color ordered – A Survey of Color Order Systems from Antiquity to the Present*. Oxford: Oxford University Press, 28 and 31.
- Nourānī, A., 2005. *Nasir al-Din al-Tusi - Ajvebat al-Masā'el al-Nasīrīyah – Responses to 20 questions*. Tehran: Institute for Humanities and Cultural Studies. p.168-172.
- Sabra, A.I., 1989. *The Optics of Ibn al-Haytham*, 2 vols. London: Warburg Institute.
- Sabra, A.I., 2007. *The "Commentary" that saved the text. The hazardous journey of Ibn al-Haytham's Arabic Optics*, Early Science and Medicine 12:117-133.
- Schimmel, A., 1992. *A two-colored brocade – the imagery of Persian poetry*. Chapel Hill: University of North Carolina Press.
- Steingass, F.J., 1892. *A Comprehensive Persian-English dictionary, including the Arabic words and phrases to be met with in Persian literature*. London: Routledge & Paul.
- Topdemir, H.G., 1999. *Takiyüddin'in Optik Kitabı*. Ankara: T.C. Kültür Bakanlığı.
- Wiedemann, E., 1908. Über die Entstehung der Farben nach Nasir al Din al Tusi, *Jahrbuch der Photographie* 22:86-91, esp. p.90.
- Yousofi, G.H., 1977. *Colors in the poetry of Hafez*, Edebiyat 2:15-28.

*Address: Kirchner Publications, Wollegras 14, Leiden, the Netherlands*  
*E-mail: ekirchnr@xs4all.nl*



# An Effective Method for Analyzing the Human's Region of Interest

Cheng-Min TSAI,<sup>1</sup> Shing-Sheng GUAN,<sup>2</sup> M Ronnier LUO,<sup>3</sup> Stephen WESTLAND<sup>3</sup>

<sup>1</sup> Department of Creative Product Design and Management, Far East University, Taiwan

<sup>2</sup> Graduate School of Design, National Yunlin University of Sci. and Tech., Taiwan

<sup>3</sup> School of Design, University of Leeds, United Kingdom.

## ABSTRACT

The aim of this study is to develop an effective method to analyze Regions of interest (ROI). A psychophysical experiment was conducted in this study. The observer's eye movement data were accumulated. The fixation map was established in terms of CIELAB  $L^*$  values. The delta  $L^*$  values between two maps were used to express the difference of visual fields, counting methods. Thirty observers participated in visual experiment (19 females and 11 males whose average age was 23). The experimental images were categorized into three groups, portraits, landscapes with architectural images, indoor multiple objects images. The results showed that the fixation map can be effectively used to analyze the distribution of eye movements between images. The delta  $L^*$  value calculated between two fixation maps is easy to understand and is more effective by computing the difference only based on ROIs than that based on entire image. The results also showed that eye-tracking data is robust for evaluating image quality study.

## 1. INTRODUCTION

More recent studies were to identify the Region(s) of Interest (ROI) in an image, which is defined as the area of an image that attracts more visual attention than the others (Fedorovskaya *et al.*, 1996; Privitera & Stark, 2000; Privitera *et al.*, 2005). Privitera and Stark indicated that the ROIs are defined as the loci of the human's eye fixations and they can be analyzed by their spatial distribution over the visual stimulus and their temporal ordering (Privitera & Stark, 2000). They developed an image quality model based on the focus of visual attention of an image rather than the entire image (Santella & DeCarlo, 2004). Privitera *et al.* conducted a series of experiments to predict the scan-paths of eye movements using an eye-tracking system (Privitera *et al.*, 2005). They then used geometrical spatial kernels and linear filter models to locate the ROIs in an image. Nguyen *et al.* grouped ROIs, based on the analysis of scan-paths and sequences of fixation for viewing grayscale images, and subsequently performed compression on the areas based on ROIs of an image (Nguyen *et al.*, 2006). The algorithm only addresses grayscale images and therefore may not work well for colour images.

Henderson and Hollingworth indicated that eye movements are critical for the efficient and timely acquisition of visual information during complex visual-cognitive tasks (Henderson & Hollingworth, 1998). The eye tracking technique has widely applied in various research areas, such as human factor and interface design, advertising and marketing, psychology and neuroscience, attention span and visual text. In the image assessment research field, fixation map analysis provides an opportunity to objectively define the principal areas of ROI for viewing images (Wooding, 2002). This study was designed to be different from the previous studies by employing eye-tracking technique. The aim of this study is to develop an effective method to analyze ROI.

## 2. EXPERIMENT

### 2.1 Sample Preparation

The experimental images were selected from ISO standards and some were collected from the Kodak Lossless True Color Image Suite (Kodak, 2007). All of these images were first categorized into three groups, portraits, landscapes with architectural images, indoor multiple objects images. The experimental images were then selected from each category for the current experiment as shown in Fig. 1. The size of an image was 1280 by 768 (pixels). The images were randomly displayed during each observation session where the background was a mid-grey colour having  $L^*$  about 60.

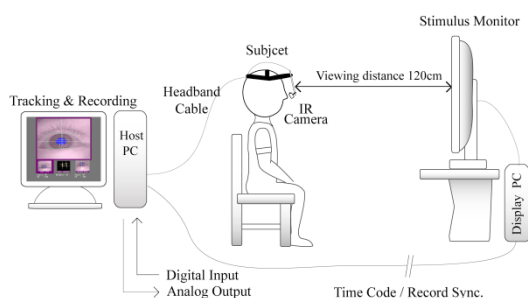

Figure 1 *The images used in Experiment.* Figure 2: *The eye tracking apparatus set for experimental condition.*

### 2.2 Psychophysical Experiment

A EyeLink II was used using an infra-red head-mounted, video-based, pupil and corneal reflection eye tracking apparatus. It had a high resolution (noise-limited at  $<0.01^\circ$ ) and a fast data rate (more than 250 samples per second). It was easy to operate and required less than a minute to conduct the calibration process before commencing the experiment. Fig. 2 shows the experimental condition. Observers sat in front of the LCD-TV and wore a headset containing a camera to record their eye movements and fixation locations. The time fixated on each pixel and the eye position of the image was stored on the Host PC. The observers judged image quality on the stimulus monitor controlled by the Display PC. The eye-movement data were processed instantly in terms of fixations and saccades, the count of the fixation point, in a form ready to be used for the data analysis. A 30-inch LCD-TV was adopted to display images. The study was conducted in a laboratory with an ambient illuminance at about 230 lux, and a correlated colour temperature (CCT) close to 6,500K.

### 2.3 Observers

Thirty observers participated in Experiment I (19 females and 11 males whose average age was 23). All were staff members and postgraduate students from the School of Design, at the National Yunlin University of Science and Technology. All had normal color vision, according to the Ishihara color vision test.

### 2.4 Data Analysis

All results were reported in terms of CIELAB color differences (CIE, 2004). Fig. 3 shows the workflow to obtain the final outcome to describe ROI (filtered mask and fixation map) from the original image and eye movement data. Each pixel of an image was started as sRGB data

(note the earlier monitor was characterized to be a sRGB monitor). It was then transformed to XYZ, and then CIELAB  $L^*$ ,  $a^*$  and  $b^*$  values. Only, the  $L^*$  data were used to construct the filtered mask and then fixation map with the visual data from the eye-tracking system. The eye movement data were first analyzed in a square for each fixation point corresponding to a particular visual field size in unit of angle. Many fixation points were then collected from each observer's eye positions, which were used to produce a fixation map for each image.

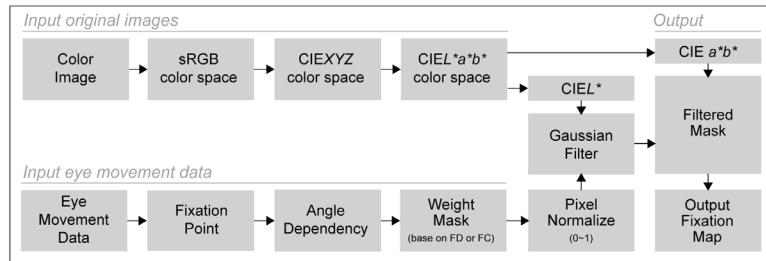

Figure 3: The workflow to calculate Fixation Map.

### 2.5 Construction of the Fixation Map

The weight ( $w$ ) of fixation map was constructed by each pixel's fixation area relative to their maximum value of the image considered. Finally, the  $L^*$  value of pixel ( $_{ij}$ ) was calculated using Eq. (1) by multiplying the  $L^*$  value of original image by the weight for the pixel in question.

$$L^*_{ij} = L'_{ij} \times w_{ij} \tag{1}$$

where  $L'_{ij}$  is the  $L^*$  value for pixel ( $_{ij}$ ) and  $w_{ij}$  is defined by Eq. (2)

$$w_{ij} = \frac{I_{ij}}{Imax_{ij}} \tag{2}$$

where  $I_{ij}$  is the frequency of fixation area for pixel ( $_{ij}$ ), and  $Imax$  is the peak value of the frequency of the pixel in question.

### 3. RESULTS AND DISCUSSION

The lightness-difference value calculated between two fixation maps is easy to understand and is more effective by computing the difference only based on ROIs which received more attention. The present results showed that observers tend to ignore the blue sky, grass and foliage in the landscape images; they almost always pay attention to the main objects of the image, such as a building, a fountain. As mentioned earlier, Privitera, and Henderson and Hollingworth, paved a new wave of ROI research (Privitera *et al.*, 2005; Henderson & Hollingworth, 1998). The present study continued their studies by focusing more detailed examination of ROI. It can be concluded that the eye movement measurements provide a valuable research means in imaging science in terms of ROI. The method of fixation map established here corresponding to ROIs of an image is effective.

#### 4. CONCLUSIONS

The results showed that the fixation map which made from fixation area base on  $L^*$  value can be effectively used to analyze the distribution of eye movements between images. The delta  $L^*$  value calculated between two fixation maps is easy to understand and is more effective by computing the difference only based on ROIs than that based on entire image. The results and trend from two experiments were quite consistent, which implies that eye-tracking data is robust for evaluating image quality study.

#### ACKNOWLEDGEMENTS

The authors would like to thank NSC scholarship from Taiwan (R.O.C.) for the main author of this paper to study at the Colour, Imaging and Design Centre, at the University of Leeds. The authors would also like to thank many observers too part in the experiments.

#### REFERENCES

- CIE, Colorimetry. Vienna: CIE 15:2004.
- Duchowski, A.T., 2003. *Eye Tracking Methodology: Theory and Practice*, London: Springer-Verlag.
- Fedorovskaya, E.A., H. Ridder and F.J. Blommaert, 1996. Chroma variants and perceived quality of color images of natural scenes, *Color Research and Application* 22(2) 96-110.
- Henderson, J.M., and A. Hollingworth, 1998. Eye movements during scene viewing: An overview. In G. Underwood (Ed.), *Eye guidance in Reading and Scene Perception* 269-294. Oxford: Elsevier.
- Kodak, 2007. Kodak *Lossless True Color Image Suite*, Retrieved from <http://r0k.us/graphics/kodak/>, August 2007.
- Nguyen, A., V. Chandran and S. Sridharan, 2006. Gaze tracking for region of interest coding in JPEG 2000, *Signal Processing: Image Communication* 21(5) 356-377.
- Privitera, C.M., and L.W. Stark, 2000. Algorithms for defining visual regions-of-interest: Comparison with eye fixations, *IEEE Transactions on Pattern Analysis and Machine Intelligence* 22(9) 970-982.
- Privitera, C.M., T. Fujita, D. Chernyak and L.W. Stark, 2005. On the discriminability of hROIs, human visually selected regions of interest, *Biological Cybernetics* 93(2) 141-152.
- Wooding, D.S., 2002. Fixation maps: Quantifying eye-movement traces, *Proceeding of Eye Tracking Research & Applications Symposium (ETRA 2002)* 31-33.

*Address: Cheng-Min Tsai, Department of Creative Product Design and Management,  
Far East University, No.49, Zhonghua Rd., Xinshi Dist., Tainan 74448, Taiwan (R.O.C.)  
E-mails: ansel.tsai@gmail.com*

# Colour Lighting Influence on the Efficiency of Emotional Recognition Tasks

Vincent C. SUN,<sup>1</sup> Tien-Rein LEE,<sup>2</sup> Jun-Hung CHEN<sup>2</sup>

<sup>1</sup> Department of Mass Communication, Chinese Culture University

<sup>2</sup> Department of Information Communications, Chinese Culture University

## ABSTRACT

This research explores if environmental color lighting affects the efficacy of task performance by examining emotional recognition response under different color lighting conditions. Recent developments of LED lighting technology give rise to creative environmental illuminations of different color choices, but also to concerns about their possible positive or negative emotional effects. The present research focuses on the effects of environmental color lighting on emotional recognition response.

## 1. INTRODUCTION

The effects of color lighting on human response have been examined from a range of perspectives, such as color lighting effects on mood, performance, and human well-being (Hoonhout, Knoop and Vanpol 2009), psychological and physiological response (Lee and Sun 2011), the relaxing effect of computer screen background colors (Gorn, Chattopadhyay, Sengupta and Tripathi 2004), and human emotions affecting the perception of time (Droit-Volet and Meck 2007). However, the ability and tendency about people's judgments for their emotions under different color lighting conditions have not yet been investigated. Previous studies have shown that people have good ability on judging emotions based on facial expressions; even if the faces are merely shown as simple line drawings (Bombari et al. 2013, Bouhuys, Geerts and Mersch 1997). Many emotional recognition research projects are concerning features and configural face information (e.g., Bombari et al. 2013). The present study aims to explore if environmental color lighting affects the efficacy of task performance by examining emotional recognition response under different color lighting conditions. Line drawing faces used in Bouhuys (1997) were applied as stimuli for testing face emotion recognition performance under different lighting colors. Sun, Chao and Lee (2012) had studied title text legibility with different color combinations before. Findings of these researches suggest that lighting colors affect physiological responses, with text colors affecting reading performance. In the present research, an emotion recognition task was applied in an improved color lighting setting based on the one used in Lee and Sun (2011), to explore the possible effects of lighting color on human emotional response.

## 2. METHOD

### 2.1 Subjects

Twenty-four subjects have participated in the experiments, all college and graduate students of the Chinese Culture University, among them 17 males and 7 females aged between 20 to 24 years, eight of them from Indonesia. All subjects were screened with the Ishihara test for normal color vision.

## 2.2 Apparatus

Experiments were carried out in a lighting chamber equipped with a laboratory-built, 4-color-channel LED lighting system, providing a soft, even illumination. The LED lantern was driven by a Pulse-Width-Modulation device, controlled through DMX512 protocol programming, with all channels linearized and calibrated with a PR655 spectro-radiometer. The lighting chamber was located in a dark lab room to prevent unwanted stray light and was equipped with a small table and a comfortable chair. On the table a 15" Eizo ColorEdge monitor connected to a Dell notebook computer was used to display the stimuli.

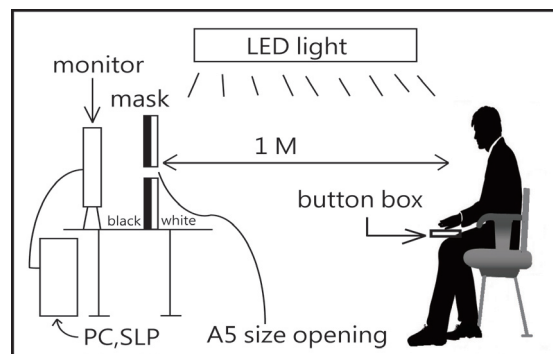

Figure 1: Diagram of the experimental environment.

An A2 size matt-white board was placed in front of the monitor to serve as a masking and provide a light-reflecting surrounding to the experimental stimuli (Figure 1). An opening of  $250 \times 150$  mm was on the center of the mask board where all stimuli were viewed. This aperture subtended a horizontally 14-degree visual angle with a 1 meter viewing distance.

## 2.3 Materials

The experiment used twelve schematic faces which were composed of 4 eyebrow types, 3 mouth types, 1 eye and 1 nose type. The faces were simple line drawings replicated from Bouhuys, Geerts and Mersch (1997, Figure 2), when subjects (depressed patients) judged these faces with respect to six basic emotions and two relational ones. Since Bouhuys et al. (1997) suggested that the face emotion judgment scores converged to positive and negative emotions by factor analysis, subjects in the present study were only asked to judge these faces as “pleasant” (positive) or “unpleasant” (negative). During the experiment, the twelve faces were displayed with a random order in a given block. The block repeated twice for an experiment session, so each face was presented for three times in one session.

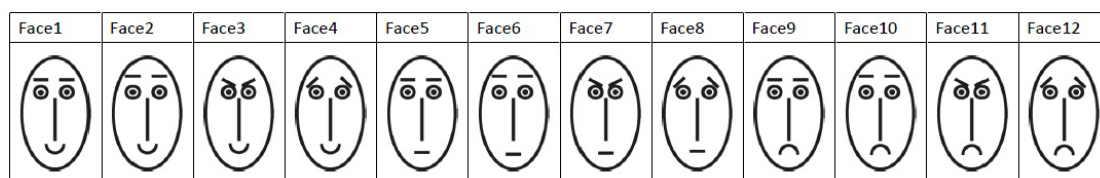

Figure 2: Faces used in the present study (Bouhuys et al. 1997).

## 2.4 Procedure

Subjects were asked to put on a long black gown in order to make their cloth and shoe colors unseen and reduce possible light reflections from their clothes during the experiment. After a subject had entered the lighting chamber, an instruction was displayed on the monitor, explaining the experimental task, procedure, and test phase: First, a picture would appear on

the screen. When hearing a beep, the subject was asked to judge based on his or her cognition if the picture showed good mood (Pleasant, Positive) or bad mood (Unpleasant, Negative), and press a button accordingly. This experiment included a practice phase, and the real experiment would start only afterwards. All trials in a given block were presented in a randomly determined order. The practice session was carried out in a cool-white fluorescent illumination, while the eight experiment sessions were performed in eight illumination colors (Table 1). There was a one-minute adaptation period for each illumination color session before each test began. The reaction time and the rate of positive vs. negative emotional judgment were collected for each illumination color.

Table 1. Colorimetric data of chamber illuminations

Color List	Red	Green	Blue	Cyan	Magenta	Yellow	Black	White
Y(Lux)	230	470	115	585	345	700	0	1362
x	0.693	0.168	0.137	0.144	0.277	0.449	0	0.271
y	0.307	0.753	0.052	0.204	0.116	0.501	0	0.249

### 3. RESULTS AND DISCUSSION

Generally, the reaction time obtained under different illumination colors doesn't show significant differences with colors, and there are no significant differences regarding gender or between Taiwanese and Indonesian subjects for the reaction time (Figure 3). However, there is a significant interaction effect between gender and nationality ( $p = 0.025$ ). For Taiwanese subjects, male tend to have longer reaction time than female, but this tendency is reversed for Indonesian subjects.

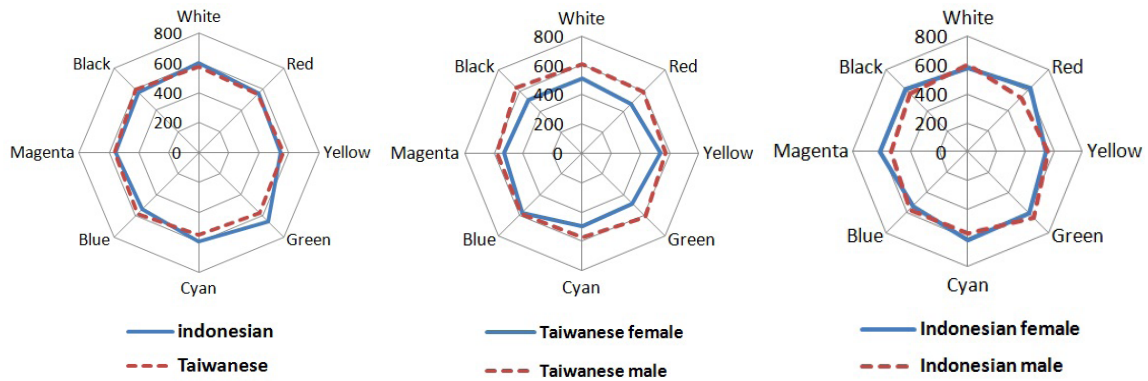

Figure 3: Reaction time for emotional recognition (ms).

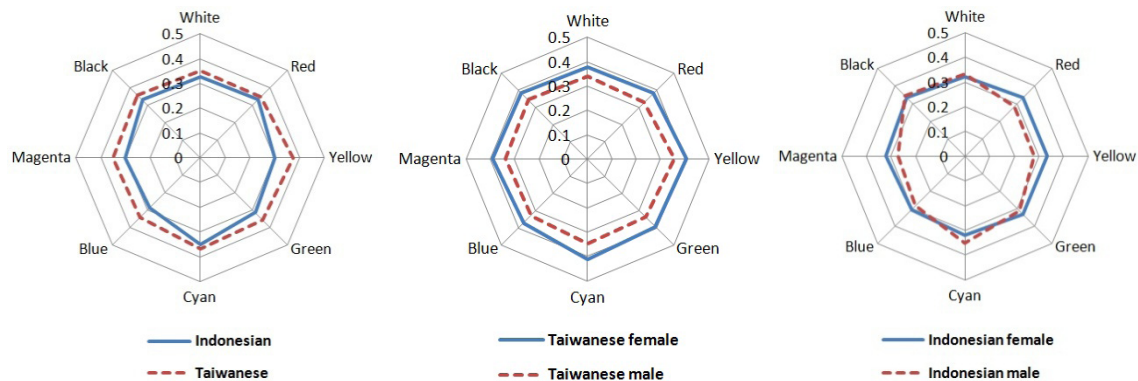

Figure 3: Rate of positive emotion judgments.

The overall proportion of positive judgment (pleasant) is about 0.34, but the rate is significantly higher for Taiwanese subjects than for Indonesian (0.36 vs. 0.31,  $p = 0.001$ ), and the tendency is observed for all illumination colors (Figure 4). This means that Taiwanese students have a small but constant proneness to judge those schematic faces as more pleasant. However, the higher positive judgment rates for Taiwanese subjects are not uniform among different illumination colors. They are especially higher for Magenta, Blue, Green, and Yellow, and reach a statistically significant difference on Yellow ( $p = 0.027$ ).

There is also a gender difference for the rate of positive judgment ( $p = 0.027$ ). Female subjects tend to have higher rate of positive judgment than male subjects (0.37 vs. 0.33). This tendency is similar for both Taiwanese and Indonesian subjects.

The present research failed to find a strong overall effect of illumination colors on emotional responses, but found a culture difference for emotion judgment, and the magnitude of differences varied with lighting colors in a certain degree. Environmental lighting color may affect our mood, reflected on tasks related to emotional responses, but these effects may be rooted in culture specific perception. Further researches are still needed to take a deeper look at this issue.

#### ACKNOWLEDGEMENTS

This study is supported by the government grant: NSC100-2410-H-034-036-MY2.

#### REFERENCES

- Bombari, D., P.C. Schmid, M.S. Mast, S. Birri, F.W. Mast and J.S. Lobmaier 2013. Emotion Recognition: The Role of Featural and Configural Face Information, *The Quarterly Journal of Experimental Psychology* (accepted), 1-39.
- Bouhuys, A., E. Geerts and P. Mersch 1997. Relationship between perception of facial emotions and anxiety in clinical depression: does anxiety-related perception predict persistence of depression? *Journal of Affective Disorders* 43(3) 213-223.
- Droit-Volet, S. and W.H. Meck 2007. How emotions colour our perception of time, *Trends in Cognitive Sciences* 11(12), 504-513.
- Gorn, G.J., A. Chattopadhyay, J. Sengupta and S. Tripathi 2004. Waiting for the web: how screen color affects time perception, *Journal of Marketing Research*, 215-225.
- Hoonhout, H., M. Knoop and R. Vanpol 2009. Colored lighting in offices the new caffeine? Looking into performance effects of colored lightin, *Proceedings of the Human Factors and Ergonomics Society Annual Meeting*.
- Lee, T-R. and V.C. Sun 2011. Investigating the psychological and physiological effects of human exposure to color light, *Proceedings of the AIC 2011 Midterm Meeting of the International Colour Association, Zürich*.
- Sun, V.C., I.T. Chao and T-R. Lee 2012. Legibility study of the layouts and color combinations of e-book titles, *Proceedings of the AIC 2012 Interim Meeting of the International Colour Association, Taipei*.

Address: Dr. Vincent Sun, Department of Mass Communication,  
Chinese Culture University, No. 55, Hwa-Kang Rd., Taipei 11114, Taiwan  
E-mail: csun@faculty.pccu.edu.tw



# Red Colour Does Not Have a Negative Effect on Intellectual Performance of Japanese Students

Shin'ya TAKAHASHI

Graduate School of Environmental Studies, Nagoya University

## ABSTRACT

A negative effect of red colour in an achievement context, which was reported by Elliot et al. (2007) and Maier et al. (2008), was retested by four experiments using Japanese participants. In each experiment, participants took numeric subtest of the Intelligence Structure Test (Beauducel et al., 2010), the same test as used in the previous studies. Before starting the test, participants briefly looked at red or grey colour without an awareness of being manipulated; by this procedure, participants were divided into red and grey conditions. In experiments 1, 2, and 3, in which a total of a hundred and forty high school or university students were tested, the results showed no effects of colour condition on the test performance. Finally, in experiment 4, in which thirty university students were tested with an additional procedure adopted for elevating their avoidance motivation, the results showed an inverse effect of those of the previous studies; red had a positive effect on the test performance. These contradictory results were discussed from the viewpoint of various associations red colour can have; it may trigger positive approaching motivation in some condition or for some people, as well as negative avoidance motivation as the previous authors argued.

## 1. INTRODUCTION

Elliot et al. (2007) and Maier et al. (2008) reported a negative effect of red in an achievement context. They showed that to glance at red impaired performance in the various intellectual tasks conducted soon after; for example, an anagram task, a words-analogy task, and a numerical inference task. The authors argued that this effect may be mediated by the association of the red colour with negative meanings such as 'failure,' 'danger,' and 'anxiety.' Participants who looked at red may be unconsciously motivated to avoid such negative outcomes, inclined to process given information locally rather than globally, thereby resulting in poorer performance. However, as the authors pointed out, this finding is limited to a certain culture at present (they tested U.S. or German undergraduates and high school students only), and the question of generalization to other cultures, particularly those other than Western cultures, remains open. Therefore, this study tried to replicate the finding in Japanese participants through four experiments.

## 2. EXPERIMENT 1

### 2.1 Methods

In experiment 1, basic experimental methods followed those used by Maier et al. (2008). Fifty-two Japanese high school students were divided into two groups (the red group and the grey group) at random. They took a 20-item numeric subtest of the Intelligence Structure Test (IST), a German IQ test (Beauducel et al., 2010). For each item, a sequence of seven numbers was given with the final number unspecified (e.g., 18, 16, 19, 15, 20, 14, 21, ?); the task is to find the final number. The mathematical rule in the sample item above is  $-2, +3, -4, +5, -6, +7$ , and the solution is 13.

After a general instruction of the test, participants completed two, relatively easy, sample items which were shown on the first page of the test booklet. Then, the experimenter informed participants that the test includes 20 items of similar (but generally more difficult) problems and they must try their best to solve as much items as they can within 5 minutes.

Next, the experimenter instructed participants to turn the booklet to the second page. On that page, a Japanese word (Kanji letters) corresponding to an English word 'problem' was printed on a red or grey rectangle background. The size and the colours of the rectangle were set approximately equivalent to those used in Maier et al. (2008):  $5 \times 7^{1/4}$  inch, red; LCh=(48.9, 52.2, 27.9), grey; LCh=(48.8, -, 106.5). Participants were asked to estimate the number of items they would be able to solve, and wrote the number (0-20) in a box below the rectangle. After this procedure, which took approximately ten seconds, participants were instructed to turn another page and begin the test. This procedure on the second page could make participants unintentionally look at red or grey colour just before the test, and functioned as a manipulation of the experimental condition (red or grey).

Major alteration from Maier et al.'s methods was that participants were not informed to receive a feedback of individual score later, in addition to the time allowed for the test: 5 min. in the present experiment and 7 min in Maier et al.

## 2.2 Results

Mean number of correct answers was 8.48 (SD 3.87) in the red condition and 8.60 (SD 3.76) in the grey condition; the difference was not statistically significant ( $t=.112$ ,  $df=50$ , n.s.). As for the number of 'possibly-solvable' items estimated beforehand by participants, the mean was 12.26 (SD 2.44) in the red condition and 13.08 (SD 3.15) in the grey condition; the difference was not statistically significant ( $t=1.055$ ,  $df=50$ , n.s.).

## 3. EXPERIMENT 2

### 3.1 Methods

The almost same procedure as in experiment 1 was applied to Japanese university students. Fifty-two participants were assigned to either the red condition or the grey condition, and took the same numeric test. However, performance estimation was not asked to the participants in this experiment.

### 3.2 Results

Mean number of correct answers was 13.43 (SD 5.00) in the red condition and 12.96 (SD 3.62) in the grey condition; the difference was not significant ( $t=-.383$ ,  $df=50$ , n.s.).

## 4. EXPERIMENT 3

### 4.1 Methods

In this experiment, participants were tested individually in an experimental room, not as a group simultaneously in a classroom. (Previous experiments of this study and Maier et al.'s (2008) study were all conducted as a group test.) Thirty-six Japanese university students were tested in either the red condition or the grey condition. Test items, composition of the booklet, and general procedure were same as in experiment 1. Performance estimation was

also conducted. In addition, at the beginning of the experiment, participant was informed that he/she will receive a feedback of individual result later. This information was given for the purpose of boosting participant's avoidance motivation and evaluation anxiety.

## 4.2 Results

Mean number of correct answers was 12.67 (SD 5.43) in the red condition and 12.06 (SD 4.15) in the grey condition; the difference was not significant ( $t=-.379$ ,  $df=34$ , n.s.). As for performance estimation, the mean of numbers estimated by participants in the red condition was 13.33 (SD 3.14), whereas that in the grey condition was 12.78 (SD 2.24); the difference was not significant ( $t=-.611$ ,  $df=34$ , n.s.).

## 5. EXPERIMENT 4

### 5.1 Methods

In the final experiment, additional procedure was adopted before the test in order to elicit participants' task-related anxiety and avoidance motivation more than the previous experiments. Thirty Japanese university students were tested individually as in experiment 3. On arrival for the experiment, participants were told that they will take two different intelligence tests. First, they took a 20-item figural subtest of the IST without having any colour manipulation beforehand. When the test period of 5 min. was expired, the experimenter received an answer sheet, quickly marked answers, and gave a feedback of his/her score to the participant. The feedback said 'your score rate was 86.3 % compared with the average' irrespective of the participant's actual performance. This untrue information of poorer attainment was employed in order to shock participants, spoil their confidence, and elevate anxiety at taking the next test.

Then the participants took the second test; the numeral subtest of the IST. Colour manipulation was conducted in the same way as in the previous experiments; participants were randomly assigned to either the red condition or the grey condition. After finishing the test, they were given some questions asking about self-assessment of their concentration, task-motivation, etc.

### 5.2 Results

Mean number of correct answers in the second test was 13.33 (SD 3.87) in the red condition and 10.00 (SD 4.71) in the grey condition; the difference was statistically significant ( $t=-2.120$ ,  $df=28$ ,  $p<.05$ ). In contrast with Maier et al. (2008), the red colour had a positive effect on the test performance. Self-assessment scores were compared between colour conditions, but no significant difference was obtained. However, when these scores were analyzed in terms of the correlation with the test performance, it was revealed that concentration score ( $r=.43$ ,  $p<.05$ ) and task-motivation score ( $r=.66$ ,  $p<.001$ ) correlated positively with the number of correct answers in the red condition. No such correlations were found in the grey condition.

## 6. DISCUSSION

Results of the present four experiments did not support the findings of Elliot et al. (2007) and Maier et al. (2008). Red colour did not have a negative effect on intellectual performance of Japanese high school or university students. On the contrary, in experiment 4, red was shown

to have a positive effect when participants' attainment in the prior test was poorly evaluated through untrue feedback.

Now we have inconsistent evidences about the red-effect in the same achievement context; positive effect in Japan and negative effect in Germany and U.S. Though it is not easy to solve this discrepancy, one possible explanation would be different associative outcomes of the red colour. Maier et al. (2008) demonstrated that the negative effect of red is mediated by participants' avoidance motivation that is triggered by red colour's negative association such as 'failure' and 'anxiety.' However, red colour can be also associated with quite different, rather positive, meanings such as 'enthusiasm' and 'fight.' In fact, supplementary result of experiment 4 showed that red colour's associative ratings for negative words such as 'failure' (mean: 3.17, on a 7-point scale) and 'inferiority' (2.4) were lower than those for positive words such as 'enthusiasm' (5.8) and 'motivation' (5.13). Thus, these participants might have (probably unconsciously) raised their positive approaching motivation, rather than negative avoidance motivation, by looking at red colour. Aforementioned positive correlation between self-assessment scores for concentration and motivation with the test performance would support this argument.

In conclusion, it would be safe to say that the negative effect of red colour in an achievement context is not universal across conditions, individuals, and probably cultures. Further investigation employing various tasks, participants, and ways of colour presentation, is necessary to reach a more reliable knowledge.

#### REFERENCES

- Beauducel, A., D. Liepmann, S. Horn and B. Brocke, 2010. *IST Intelligence Structure Test: English Version of the Intelligenz-Struktur-Test 2000 R*. Göttingen: Hogrefe.
- Elliot, A.J., M.A. Maier, A.C. Moller, R. Friedman and J. Meinhardt, 2007. Color and psychological functioning: The effect of red on performance attainment. *Journal of Experimental Psychology: General* 136(1): 154-168.
- Maier, M.A., A.J. Elliot and S. Lichtenfeld, 2008. Mediation of the negative effect of red on intellectual performance. *Personality and Social Psychology Bulletin* 34(11): 1530-1540.

*Address: Dr. Shin'ya Takahashi, Department of Psychology,  
Graduate School of Environmental Studies, Nagoya University,  
Furo-cho, Chikusa, Nagoya 464-8601, Japan  
E-mail:shinya@lit.nagoya-u.ac.jp*

# The Notion of Colour in Human-computer Interaction Studies

Johanna SILVENNOINEN,<sup>1</sup> Hannakaisa ISOMÄKI<sup>2</sup>

<sup>1</sup> Department of Information Systems and Computer Science, University of Jyväskylä

<sup>2</sup> Department of Mathematical Information Technology, University of Jyväskylä

## ABSTRACT

The majority of current human-computer interaction studies dealing with visual elements in user interfaces have focused on colour, but the definitions of colours have not gained much attention. In order to enhance the inner validity of the research area it is necessary to clarify the definitions in relation to colour theories. In our study we analyse in relation to main colour theories how colour has been defined in current human-computer interaction studies. Results of this study will provide new insights to research of colour in human-computer interaction and help in further construction of analysis frameworks.

## 1. INTRODUCTION

Due to the effectiveness of colour it is often seen as a primary visual element that can add interest in any visual compositions (e.g. Poulin, 2011). In current user interface (UI) design it is essential to understand the overall behavior of colour in UI composition (Truckenbrod, 1981). Despite the increasing research in the field, (e.g. Tractinsky, 1997; Udsen, and Jørgensen, 2005; Moshagen and Thielsch, 2010), visual aesthetics in human-computer interaction (HCI) has been criticised of poor identification of some of the main concepts (Lindgaard, 2012). A particular deficit in studies on colour in UI design is that colours have not been defined by referring to the main colour theories. Thus, the foundations of colour research in HCI lay on insecure grounds. More profound knowledge of how colours behave would enhance possibilities to design aesthetically pleasing UIs. Therefore, the goal of this study is to enhance the research of colour in HCI by taking a closer look on how colour is defined, and to provide a framework by which colour research in HCI is compared to the main colour theories.

The results of this paper will contribute to a deeper understanding of the definitions and role of colour in HCI studies. The rest of the paper is organised as follows. First, method for literature review is described. Second, results from the literature review are presented and further analysed in comparison to the main colour theories. A framework of colour in HCI studies is presented. Finally, conclusions of the study are presented.

## 2. METHOD

To clarify the definitions of colour and the role of colour theories in recent HCI studies, a stand-alone literature review (Okoli and Schabram, 2010) was conducted. The search terms used were: color/colour and human computer interaction, color/colour and HCI. These terms had to occur in the title, as keywords, and/or in the abstract of the articles in the databases (Science Direct, ACM Digital Library, EbscoHost, and Inderscience) and in further searches with Google Scholar. The papers were published after year 2000. From the resulting papers, some were left out because they did not focus on visual aesthetics in HCI but, for example, programming of colour. The analysis was conducted through a case comparison method

(Cunningham 1977) by a framework derived from colour theories by Josef Albers (1975), Rudolf Arnheim (1974) and Johannes Itten (1973). The comparison between articles was data driven in that the colour definitions were taken from the the papers and then analysed against the key factors of the framework (Table 1).

Table 1. Framework for analysis.

Colour theory	Theory’s key factors	Author	Year
Interaction of colour	Colour in relation to the surrounding colours	Albers	1975
Colour theory	Chromatic color circle with primaries, secondaries, tertiaries, complementaries, size/shape of colour	Arnheim	1974
Colour contrasts	Value, Saturation, Hue, Extension, Warm /cool, Complements, Simultaneous contrasts	Itten	1973

### 3. RESULTS AND DISCUSSION

The articles found in the literature searches can be classified into five different content categories: text and background colour in UIs, the impact of colour on cognitive processes, the role of colour in usability, culture related colour in UI design, and colour evoking feelings. The notable examples and definitions of these are presented in Table 2 below.

Table 2. Summary of results: Colour definitions in HCI studies.

Category	Notable examples	Colour definitions
Text and background colour in UIs	Song 2011; Ling & van Schaik 2002; Hall & Hanna 2004	light, dark, contrast, background colours, 'fruit salad look', green-blue, blue-red
Impact of colour on cognitive processes	Keller et al. 2006; Ojanpää & Näsänen 2003; Bonnardel et al. 2010	color coding, monochromatic, moderate (green/grey) or high colour contrast (green/red), hue, value and chroma
Role of colour in usability	Coursaris et al. 2008; Brady & Phillips 2003	triadic color scheme, warm & cool hues, primary, secondary, complementary colors
Culture related colour in UI design	Cyr et al.2010; Noiwan & Norcio 2005; Kondratova & Goldfarb 2007	tones, grey-blue-yellow colour schemes, universal colors, country- specific color palette, complementary colors, yellow-white
Colour evoking feelings/emotions	Kim et al. 2003; Moshagen & Thielsch 2010	saturation, brightness, aesthetics i.e. colour, selection and combination of colors

#### Definitions in General

The definitions describe colour mainly with general level descriptions, such as a primary colour, cool colour or refer to the name of the colour (e.g. green, red or blue) without a more detailed understanding whether these colours are primary or secondary colours. These statements do not guarantee that the characteristics of colours (e.g. colour contrast, interaction of colour) are taken into account in the study. Moreover, these definitions do not take into account the amount of colours in colour combinations which influence the interaction of colours (Arnheim 1974). Also, colour was defined with subjective descriptions such as “middle blue”, which can be misleading.

#### Colour Interaction

Colour is constantly changing and is always seen in relation to the surrounding colours. It is almost impossible to perceive a colour without the colour interacting with its surrounding

colours (Albers, 1975). However, in the resulting categories the interaction of colour was not in focus. References to the changing nature of colour and to the challenges in designing UIs with multiple colours in the same context were briefly stated (e.g. “fruit-salad look”) but not further included to the studies.

### **Colour Contrasts**

Some definitions touched on colour contrasts, mainly comparing high and low contrasts, but not with a detailed reference to Itten’s (1973) seven colour contrasts. For instance, in studying contrast between yellow and white the results would have been known in advance if Itten’s colour contrasts would have been acknowledged in the beginning of the experiment in question.

### **Colour Combinations in Research and the Relation to Current UIs**

Stimulus material of colour in HCI studies (e.g. web pages) is often based on one or two colours, which thus lack relation to the current UIs in terms of number and richness of colours. Often in studies based on artificial colour schemes (e.g. web pages with only one or two colours), new design guidelines are presented, such as recommendations to use one cool primary colour and one warm secondary colour. These guidelines provide over simplified viewpoints to colour in visual UI design. The interaction of colours can be understood by comparison and contrast of different colours (Albers, 1975; Itten, 1973).

## **4. CONCLUSIONS**

Understanding the interaction of colours is essential HCI. According to our results the interaction of colours is seen problematic in colour studies in HCI. Future research would benefit from the main colour theories to gain deeper understanding of the research topic. If research is conducted based on artificially restricted colour schemes in UIs with no real-world resemblance, the results may not be valid for current HCI and lead to reductionist design guidelines. The main colour theories are needed in the research of colour in HCI to define and understand colour’s properties more profoundly and, thus, study colour in it’s full powerful potential as a primary visual element in HCI.

## **REFERENCES**

- Albers, J., 1975. *Interaction of Color*. Yale University Press, New Haven.
- Arnheim, R., 1974. *Art and Visual Perception: A Psychology of the Creative Eye*. University of California Press, Berkeley and Los Angeles.
- Bonnardel, N., A. Piolat, and L. Le Bigot, 2011. The impact of colour on Website appeal and users’ cognitive processes, *Displays* 32 (2) 69-80.
- Brady, L., and C. Phillips, 2003. Aesthetics and Usability: A Look at Color and Balance, *Usability News* 5 (1).
- Coursaris, C.K., S.J. Swierenga, and E. Watrall, 2008. An Empirical Investigation of Color Temperature and Gender Effects on Web Aesthetics, *Journal of Usability Studies* 3 103-117.
- Cunningham, B., 1997. Case study principles for different types of cases, *Quality and Quantity* 31 401-423.
- Cyr, D., M. Head, and H. Larios, 2010. Colour appeal in website design within and across

- cultures: a multi-method evaluation, *Int. J. of Human-Computer Studies* 68 1-21.
- Hall, R.H., and P. Hanna, 2004. The impact of web page text-background colour combinations on readability, retention, aesthetics and behavioural intention, *Behaviour & Information Technology* 23 183-195.
- Itten, J., 1973. *The Art of Color: the subjective experience and objective rationale of color*. New York: Van Nostrand Reinhold.
- Keller, T., P. Gerjets, K. Scheiter, and B. Garsoffky, 2006. Information visualizations for knowledge acquisition: The impact of dimensionality and color coding, *Computers in Human Behavior* 22 43-65.
- Kim, J., J. Lee, and D. Choi, 2003. Designing emotionally evocative homepages: an empirical study of the quantitative relations between design factors and emotional dimensions, *Int. J. of Human-Computer Studies* 59 899-940.
- Kondratova, I., and I. Goldfarb, 2007. Color your Website: Use Colors on the Web. In Aykin, N. (Ed.). *Usability and Internationalization*, Part II, LNCS 4560 123–132. Springer-Verlag Berlin Heidelberg.
- Lindgaard, G., 2012. Commentary on: Tractinsky, N. 2013: Visual Aesthetics. In Soegaard, M. and Dam, R. F. (Eds.). *The Encyclopedia of Human-Computer Interaction*, 2nd Ed. Aarhus, Denmark: The Interaction Design Foundation.
- Ling, J., and P. van Schaik, 2002. The effect of text and background colour on visual search of Web pages, *Displays* 23 223-230.
- Moshagen, M., and M.T. Thielsch, 2010. Facets of visual aesthetics, *Int. J. of Human-Computer Studies* 68 (10) 689-709.
- Noiwan, J., and A.F. Norcio, 2006. Cultural differences on attention and perceived usability: Investigating color combinations of animated graphics. *Int. J. of Human-Computer Studies* 64 103-122.
- Truckenbrod, J.R., 1981. Effective use of color in computer graphics, *Computer Graphics* 15 (3) 83-89.
- Ojanpää, H., and R. Näsänen, 2003. Effects of luminance and colour contrasts on the search of information on display devices, *Displays* 24 167-178.
- Okoli, C., and K. Schabram, 2010. A Guide to Conducting a Systematic Literature Review of Information Systems Research, *Sprouts: Working papers on Inf. Systems*, 10 (26).
- Poulin, R., 2011. *The language of graphic design: an illustrated handbook for understanding fundamental design principles*. Rockport Publishers, Beverly, MA.
- Song, G., 2011. The Role of Structure and Content in Perception of Visual Similarity Between Web Pages, *Int. J. of Human-Computer Interaction* 27 (8) 793-816.
- Tractinsky, N., 1997. Aesthetics and the apparent usability: empirically assessing cultural and methodological issues, *Proc. of the CHI*. ACM Press, NY, USA 115-122.
- Udsen, L.E., and A.H. Jørgensen, 2005. The aesthetic turn: unravelling recent aesthetic approaches to human-computer interaction, *Digital Creativity* 16 (4) 205-216.

*Address: PhD Student, Johanna Silvennoinen, Department of Computer Science and Information Systems, University of Jyväskylä, P.O.Box 35, FIN-40014 FINLAND*  
*E-mails: johanna.silvennoinen@jyu.fi, hannakaisa.isomaki@jyu.fi*



# Colour Influence on User's Motivation to Press an Input Button

Daisuke NISHIYAMA,<sup>1</sup> Hyojin JUNG,<sup>2</sup> Saori KITAGUCHI,<sup>3</sup> Tetsuya SATO<sup>1</sup>

<sup>1</sup> Department of Design Engineering and Management, Kyoto Institute of Technology

<sup>2</sup> Venture Laboratory, Kyoto Institute of Technology

<sup>3</sup> Center for Fiber and Textile Science, Kyoto Institute of Technology

## ABSTRACT

The aim of this study is to understand the colour influence on user's motivation to press an input button on touch screen equipment. An experiment was conducted using mobile equipment which is operated through touch screen by forty-nine Japanese university students. Sixty input button colours consisted of twelve hues by five colour tones on the screen. White and black are used as background colours for the colour buttons, accordingly all of 120 buttons were arranged on the screen. The subjects were asked to press colour buttons freely by their finger doing to scroll the screen by themselves. There were no time and number restrictions to the subjects. The motivation level to press of each colour button is calculated based on the frequency of pressing a button. The obtained results indicated that there was tendency for selection of input button within the subjects. There was not strong direct correlation between button's colour properties and the motivation level. However, there was a slight tendency to press a button by hue of button colour.

## 1. INTRODUCTION

Since users of touch screen type of information appliances are growing, the graphic design of displayed page is important as visual communication. Pressing an input button by user is an executive command to the device, thus design of input button could affect user visual attraction.

Colour is well known as an element of design which can stimulate human emotion and perception, thus, there are many studies about the colour effects on human emotional responses using evaluation forms (eg., Gao and Xin 2006, Hsiao, et al. 2008, Jung, et al. 2012). The obtained results tend to be psychological response depending on the evaluation intentions or words. Therefore the results may not account for physical response by colour stimulus.

The aim of this study is to understand the colour influence on user's motivation to press. As a preliminary investigation, this study investigated personal preference to an input button colour by pressing performance by an experiment.

## 2. METHOD

An experiment was conducted to forty-nine Japanese university students in indoor using mobile equipment, iPad mini of Apple Inc. which is operated through touch screen. The screen size was 7.9 inch, DPI was 1,024×768 px, colour temperature was 6834 K. An accessible online webpage <http://npym.herokuapp.com/> was designed for the experiment as shown in Figure 1 (left).

Subjects were asked to access the webpage and following instruction as; Press colour buttons which ever you want scrolling the screen by your finger. In order to get rid of limitation for subject's behavior, instruction for the experiment was written on the webpage, and there were no time, posture and press number restrictions during the experiment. However, duplicative pressing to the same button was counted as only one pressing.

Sixty button colours consisted of twelve hues: Red (R), Orange (O), Yellow orange (YO), Yellow (Y), Yellow green (YG), Green (G), Blue green (BG), Green blue (GB), Blue (B), Violet (V), Purple (P), Red purple (RP) by five colour tones based on the PCCS (Practical Colour Co-ordinate System): pale (p), light (lt), vivid (v), dark (dk), dark-grayish (dkg). The CIELAB colorimetric values of sixty button colours were calculated by The Lab colour mode of Adobe Photoshop CS5 as shown in Figure 1 (right).

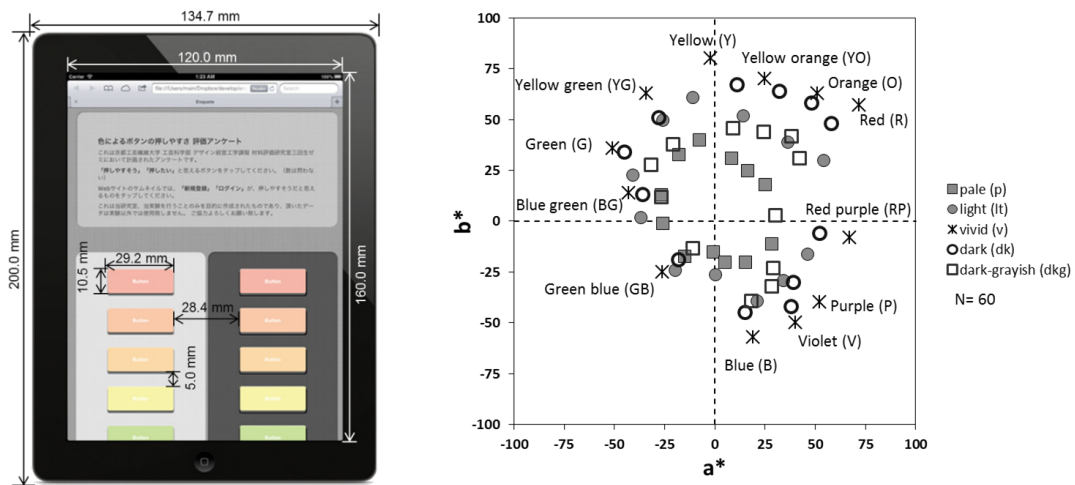

Figure 1: Display layout on the mobile equipment (left), the distributions of 60 button colours in CIELAB a\*-b\* diagram (right).

### 3. RESULTS AND DISCUSSION

Experimental results were automatically recorded in the spreadsheet of online storage by an online server. Frequency of pressing of each colour button was defined as the level of pressing motivation. The colours of frequently pressed buttons were considered as the colours which have high motivation to press. One subject who pressed eighty colour buttons was excluded from the results because the number of pressed button is higher than a mean value of all subjects (14.3 times) plus 3SD.

As a result, 304 times on white background and 383 times on black back ground as a total 687 times were pressed colour buttons as shown in Table 1.

The background colour effect was analyzed by paired samples T-Test using frequency of pressing of 60 colour buttons. The result of T-Test indicated that colour buttons on black background were significantly pressed more than white background ( $p < 0.01$ ,  $df.: 59$ ). In addition, paired samples correlation coefficient  $r$  of white/black background was 0.68. Consequently, the buttons on the black background had higher pressing motivations in general.

However, the level of pressing motivation was depended on the button colour as well. The highest pressed colour buttons were vivid red (v-R) on black background which was pressed 19 times (39.6%), and light red (lt-R) on white background which was pressed 16 times (33.3%).

In terms of hue effect, red (R) buttons were the highest frequency in both white and black backgrounds. On the other hand, purple (P) of white background, blue green (BG) of black background buttons were the lowest frequencies as shown in Figure 2.

In terms of colour tone effect, light (lt) and vivid (v) buttons were pressed more, and dark-grayish (dkg) buttons were pressed less as shown in Figure 3. However, the distribution of the standard scores was not significantly wide in tone differences.

Table 1. Frequency of pressing of each colour button.

	White background (WB)												Black background (BB)												WB Total	BB Total
	R	O	YO	Y	YG	G	BG	GB	B	V	P	RP	R	O	YO	Y	YG	G	BG	GB	B	V	P	RP		
P	9	5	3	8	5	6	9	8	2	1	1	2	12	4	3	5	9	11	2	8	6	3	7	8	59	78
lt	16	7	6	7	5	9	5	9	5	13	3	5	18	9	7	9	6	8	8	11	6	11	5	2	90	100
v	13	9	4	4	6	6	2	8	9	6	1	3	19	7	8	14	9	6	7	11	9	8	3	7	71	108
dk	9	7	3	1	1	3	4	7	12	3	2	3	13	6	5	5	5	6	2	2	8	2	2	3	55	59
dkg	5	2	1	2	2	2	2	2	7	2	1	1	4	3	0	1	4	3	1	3	5	5	5	4	29	38
Total	52	30	17	22	19	26	22	34	35	25	8	14	66	29	23	34	33	34	20	35	34	29	22	24	687	

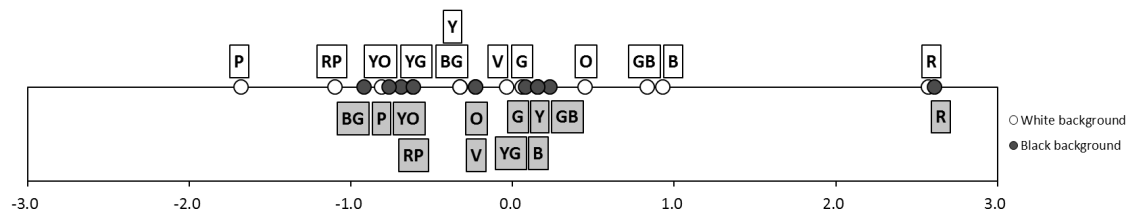

Figure 2: The standard scores (z values) of twelve hues.

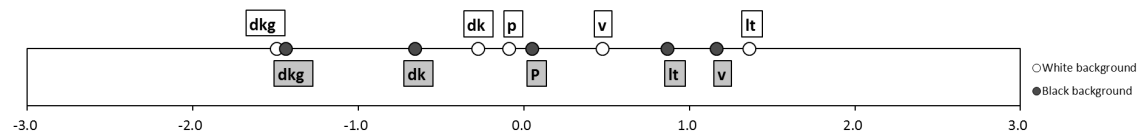

Figure 3: The standard scores (z values) of five colour tones.

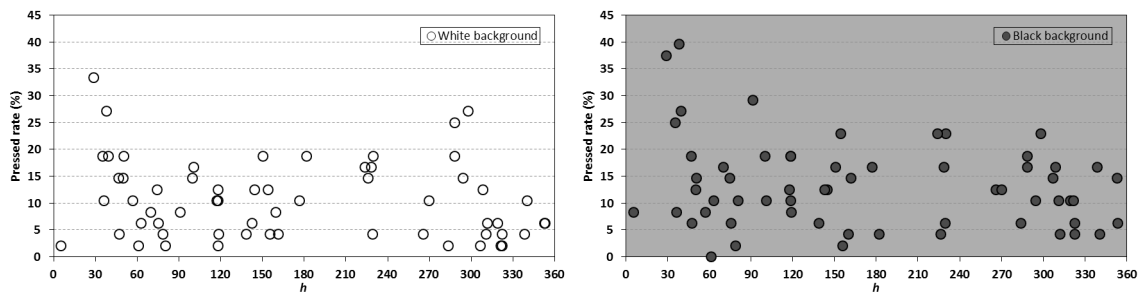

Figure 4: Pressed rate of each button on white background (left) and black background (right).

Correlations between the CIELAB colorimetric values and the pressed rate of each button were analysed to know the relationship between colour properties and the level of pressing motivation. There were not strong direct correlations between  $L^*$ ,  $C^*$ ,  $a^*$ ,  $b^*$  and the pressed rate. However slight common tendency was appeared to press buttons by hue of button colour. Where button's hue angle ( $h = \arctan b^*/a^*$ ) was approximately 30 which is belonging to red, pressed rate was higher. However where  $h$  was approximately 320-360 (violet or

purple), pressed rate was lower in both white and black backgrounds (See Figure 4). Where  $h$  was approximately 290 (blue), a buttons on white background were slightly pressed more.

#### 4. CONCLUSIONS

This study tried to understand the colour effects on human practical response through pressing colour buttons on touch screen equipment.

The obtained results indicated that the colour buttons were pressed more on black background in general. There were not strong direct correlations between colour properties and the level of pressing motivation. However slight common tendency was appeared to press buttons by hue of button colour. Red buttons were pressed with the largest number of times in twelve hues. There was limitation to understand obtained results because the subjects' performance and attributes (e.g., gender, age) were not controlled in the experiment.

#### REFERENCES

- Gao, X.-P., and J.H. Xin, 2006. Investigation of human's emotional responses on colors, *Color Res. Appl.*, 31: 411-417.
- Hsiao, S.-W., F.-Y. Chiu, and H.-Y. Hsu, 2008. A computer-assisted colour selection system based on aesthetic measure for colour harmony and fuzzy logic theory, *Color Res. Appl.*, 33: 411-423.
- Jung, H., H.-J. Suk, S. Kitaguchi, T. Sato, and K. Kajiwara, 2012. Color tolerance prediction for recycled paper based on consumers' awareness. *Color Res. Appl.*, 37: 272-280.

*Address: Dr. Hyojin Jung, Venture Laboratory, Kyoto Institute of Technology  
Goshokaido-cho, Matsugasaki, Sakyo-ku, Kyoto, Japan  
E-mail: jhyojin@kit.ac.jp*

# A Quantitative Analysis on the Effect on the Understanding of the Contents of the Article by Character, Subjected to Color Schemes, Used Sports Papers' Headline

Hiroshi IZAWA, Tatsunori MATSUI, Kazuaki KOJIMA, Keiichi MURAMATSU  
Faculty of Human Sciences, Waseda University

## ABSTRACT

Japanese sports-papers often express headlines using unique color schemes to unique characters called “Toppan”. Sports papers’ creators choose color schemes in case that they want to express contents. The color schemes are known as “know-how” and it is frequently said that it is able to convey to the reader the contents efficiently by this color scheme. So, we carried out 3 experiments to check whether the impression of readers really match the impression of editors. Experiment1, we investigated the difference of impression between character and figure subjected to color by Semantic Differential Method. Experiment2, we researched the impressions of how the color scheme is affected by the context. Experiment3, we checked whether the color scheme list is really suitable in case that like sports papers. As a result of this study, it is clarified that editors have been able to give readers accurate impression which editors want to give and that know-how which editors have learned is accurate.

## 1. INTRODUCTION

Japanese sports-papers often express headlines using unique color schemes. Sports papers’ creators choose color schemes in case that they want to express contents. We picked up the color scheme subjecting to character called Letterpress which is used at headlines. So far, there is research and study about the layout of the newspaper on the color scheme, studies focusing on Toppan isn’t present. The primary objective of this study was to investigate the difference in the impression between readers and creators by the influence of color schemes and check whether intention of the authors of the article accurately is transmitted.

## 2. METHOD

We have evaluated the impression by the Semantic differential Method (SD Method) used letterpress of sports papers as a stimulation. Experiment 1, we investigated the difference of impression between character and figure subjected to color by Semantic Differential Method. We used the one Kanji ”日” to eliminate influence of contexts and subject to 21 color schemes picked up from sample sports papers. The subjects evaluated using the SD method impression using 20 adjective pairs. Analytical method was used factor analysis (varimax rotation).



Figure 1: Stimulus in Experiment1 (mono, two colors, three colors).

Experiment 2, we researched the impressions of how the color scheme is affected by the context. By collecting this data, we can research whether the impression creators want to tell

transmits to readers in the case of newspapers. The contexts are “positive context”, “negative context”, “positive-negative context”, and “non-context”. The subjects evaluated using the SD method impression using 20 adjective pairs. Analytical method was used factor analysis (varimax rotation).



Figure 2: Stimulus in Experiment 2 (+, -, ±, non-context).

Experiment 3, we checked whether the color scheme list is really suitable in case that like sports papers. I presented 3 contexts stimulus (positive, negative and positive-negative). Analytical method was used Thurston paired comparison method.



Figure 3: Stimulus in Experiment 3 (+, -, ±).

### 3 RESULTS

In Experiment 1, as a result of factor analysis, we divided into 3 factors “evaluation”, “Pomp” and “movement”. Based on the factor scores, we analyzed the data of monochromatic color scheme, two color combinations and three color combinations. According to the results of factor analysis, it is found that it is no difference of impression between character and figure.

Table 1: Interpretation of the factor in Experiment 1.

Factor 1	sophisticated, clean, clear, comfortable, elegant, pure, beautiful, balanced, love, calm	evaluation
Factor 2	remarkable, strong, heavy, deep, sultry, warm, dynamic	movement
Factor 3	bright, colorful, unusual	pomp

In Experiment 2, as a result of factor analysis, we divided 3 factors “evaluation”, “pomp” and “balance”.

Table 2: Interpretation of the factor in Experiment 2.

Factor 1	sophisticated, clear, beautiful, love	evaluation
Factor 2	bright, colorful, dynamic	Pomp
Factor 3	deep, balanced	balanced

In order to reduce the burden on the subject, we cut the stimulus adjective pairs using Cronbach’s  $\alpha$ . According to the results of factor analysis, it is found that “positive context” and “negative context” strengthen the impression that is consistent in the context of each and otherwise contexts don’t have strong influence. Based on these results, we constructed a list of the color scheme.

Table 3: Color scheme list (part).

Color scheme	Using the on paper	General impression
Blue-white-red	○name,	○sporty
Black-yellow	○surprise	○serious
Gold-black	×victory	-
Gold-red	○victory, determination	-
White-light blue	○date, data	○clean
Yellow-purple	○dead	○Sinister

In experiment 3, we were able to collect 25(+ context), 21(- context), 18(±context-+) and 17(±context- -) subjects. We use 3 context “victory”, “lose” and “light and darkness”. I show the result of experiment 3.

Table 4: Measure distance “Victory”.

Rank	No.1	No.2	No.3	No.4	No.5	No.6
Color	G-R	B-W-R	G-B	Y-P	B-Y	W-LB
Scale	0.82	0.47	0.16	-0.17	-0.48	-0.80

“Lose”

Rank	No.1	No.2	No.3	No.4	No.5	No.6
Color	B-Y	G-B	B-W-R	Y-P	G-R	W-LB
Scale	0	0.19	0.47	0.59	0.96	1.18

“Light and Dark(+)”

Rank	No.1	No.2	No.3	No.4	No.5	No.6
Color	B-W R	W-LB	G-R	Y-P	G-B	B-Y
Scale	0.79	0.63	0.40	-0.21	-0.80	-0.81

“Light and Dark(-)”

Rank	No.1	No.2	No.3	No.4	No.5	No.6
Color	B-Y	G-B	Y-P	B-W-R	W-LB	G-R
Scale	0	0.52	1.27	1.69	2.40	2.75

According to the ranking results obtained in experiments 1 and 2 such as lightness or darkness regard was obtained. The result is that gold and red color scheme is not suitable in the positive context but other color schemes are almost suitable. Using the list, we can accurately convey the impression you want to give to the reader. Before experiment 3, Gold-based color schemes are not accurate in current using. But in experiment 3, Gold-red is most suitable in 6 color-schemes as using “victory”. In the same way, Gold-black is suitable as using “lose”. From this fact, the greater the impact on the character giving the impression of a single color scheme, it was found that the impression is that some significant impact on its surroundings further information.

#### 4. DISCUSSIONS

We have found that from the experimental results, color scheme has been used in the field of paper manufacturing expertise far as was transmitted by the reader to actually correct impression.

#### 4.1 Attention Value

When approaching the environment by sports paper, we experiment placed the characters on the picture, there was an error with respect to the color scheme, which is based on money. I can think of this, not limited to the character color and have either not affected by the other. If you have more than one, the object is referred to as “Attention Value,” that the degree of ease been attracted to the eyes of each subject. According to the results of the experiments of the Kamisaku(1972), the attractiveness of the color of the criteria for safe color is higher in the order of yellow, red, white, red, yellow, purple red, black, he found that the yellow stand out very particularly. Looking against each other as a result of this study, we find that this result is true. Therefore, it can be said right from the point of view of “Attention Value”.

#### 4.2 Relationship between content and color scheme

The results of Experiment 2, it became clear that the context has a significant impact in addition to the color scheme in the newspaper headlines. We think if we can actually use the color scheme and what context, what we want to convey the author’s article accurately whether accurately transmitted to the reader. As a matter of fact not only convey the results and the activities of players, sports headlines, to convey a sense of realism as if it really was there. We can be said that will be able to communicate better by using a color scheme that has been shown by the results of this study, the contents of the heading you want to convey.

### 5. SUMMARY

We found out the fact that could prove as data rather than the know-how to be creators and readers share the impression of common, by a combination of new colors, it will be able to be guidelines for creating the impression. Deepening the research under such practical factors such as the type of relationship between the colors and photos and photos around it would be a challenge of future works.

### ACKNOWLEDGEMENTS

This work was supported by JSPS KAKENHI Grant-in-Aid for Scientific Research B (23300083).

### REFERENCES

- Kamisaku, H., and J. Fukumoto, 1972. Attractiveness of Safety Colors. *Journal of the Color Science Association of Japan*, Vol.1, pp.4-14.
- Kitada, A., 1996. Sports and Linguistic Expression: Linguistic Expression in Sports Newspapers *Proceedings of the Congress of the Japanese Society of Physical Education*, Vol.47, pp.129.

*Address: Tatsunori Matsui, Department of Human Informatics and Cognitive Sciences,  
Faculty of Human Sciences, Waseda University,  
2-579-15 Mikajima Tokorozawa, Saitama, 359-1192, JAPAN  
E-mails: hiroshi-izawa.44@ruri.waseda.jp, matsui-t@waseda.jp,  
koj@aoni.waseda.jp, kei-mura@ruri.waseda.jp*



# Colour, Typography and Aged Vision: An Inclusive Design approach

Maria Cristina PINHEIRO,<sup>1,2</sup> Fernando MOREIRA DA SILVA<sup>1</sup>

<sup>1</sup> CIAUD - Research Centre in Architecture, Urban Planning and Design,  
Faculty of Architecture, Technical University of Lisbon

<sup>2</sup> UNIDCOM/IADE- Design and Communication Research Centre, Lisbon

## ABSTRACT

This paper presents a PhD Research Project - *Visual Communication and Inclusive Design- Colour, Legibility and Aged Vision*, developed at FAUTL, Lisbon. The research aimed to determine specific design principles to be applied to visual communication design (printed) objects, in order they could be easily read and perceived *by all*. We overlapped different areas of study such as colour, vision, typography and legibility in an inclusive design perspective, bringing the knowledge to the design community, in an accessible and simple language. When designers apply colour to visual communication design projects, they must assume that the anatomic changes occurred in the normal aging process, vision loss, and deficient colour perception of older people must be taken into account. This study target group consisted on a selection of socially active individuals aged between 67 and 77 years. We developed a qualitative mixed methodology, using Focus Groups and direct observation. In the end, it was produced a manual with guidelines and recommendations to be applied to visual communication design printed objects, in order to improve the design process and to contribute for a conscious, informed, inclusive and efficient design projectual practice.

## 1. INTRODUCTION

In this study we have overlapped the knowledge about colour, aged vision, typography and legibility in an inclusive design perspective. We defend a less intuitive approach to colour application, and design projects based on scientific knowledge in all these selected areas of study.

Colour is a tool that communicates in a different way from typography or images; has the function to focus attention, creates contrasts, and helps objects to become understood and memorable. Colour conveys messages, has symbolic content, causes emotional reactions and enlivens our perception of surrounding environments. Colour communicates, attracts attention, informs, highlights, signals, identifies and symbolizes. Colour belongs to the structure of the visual message, taking part in their language and communication process. The language of colour derives from the physical process of light energy, which is transformed into a visual perceptual process in order to have communication.

In this study we've focused only on the perceptual aspects of colour and readability of texts. When designers apply colour on design projects, they must assume that knowledge about vision, colour vision, perception, interaction and harmony of colours, chromatic contrasts, psycho physiological reactions, symbolism, psychology, and semiotics of colour should always be present on the design process. But knowledge about vision, vision loss and deficient colour perception of older people must be introduced in the design projectual practice. So, Inclusive Design, should help people and communities to prepare themselves for future, as well as should improve quality of life in the present. Designers need to create envi-

ronments and objects that are easier on everyone's eyes with or without visual impairments.

### 1.1 Colour and Aged Vision

The aging process is characterized by progressive and multiple acquisitions of minor deficiencies, predominantly related to vision, hearing, dexterity, mobility and cognition, which can lead to high levels of disability and dependency. The aging process includes physical degeneration, with a reduction of the overall physical condition, of agility, impaired vision and loss of hearing, memory faculties, and sense of direction. Deficits lead to changes in sensory perception and decreased sense of well-being, which often involves strong feelings of insecurity (Meerwein, Rodeck, Mahnke, 2007).

The aging lens and cornea causes glare by light scattering, especially for shorter wavelengths; the yellowing of the lens causes a selective absorption of short wavelength light (blues and greens), and becomes increasingly dense. Blue colour may appear dark and hard to distinguish from green, because the yellowish elderly lens absorbs blue light selectively; the colour perception improves after cataract surgery, "and most patients notice a brightening of colours at the blue end of the spectrum" (Marmor, 2007). Most people (70%), aged between 65 and 69 years, sooner or later will develop a cataract; the percentage rises to 100% at 90 years, which means that studying the vision of the elderly is to study vision with cataracts (Ikeda, 2009).

The fog or blurring of the lens, besides affecting colour perception of objects also decreases its saturation; this aspect has been neglected in the research of colour perception of the elderly, by the tendency to consider only the colour of yellowed lens (Ikeda, 2009).

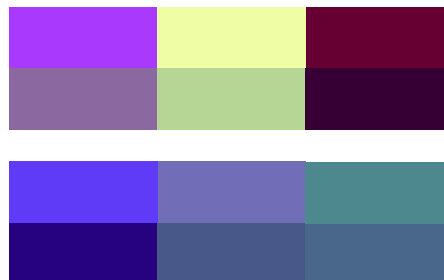

*Figure 1: The superior range of colours in these examples shows the difference between colour perception of normal and aged vision. ©Jill Morton.*

Although retinal stimulus and neural signals are strongly affected by age related changes (such as the reduction of pupil size, density of the lens, reduction of photon absorption efficiency of cones and losses of retinal ganglion cells), colour appearance is stable throughout the life-span. There is, however, a loss of sensitivity in colour discrimination; although colour appearance changes little with age, the ability to discriminate colours is significantly reduced with age under certain conditions Shinomori (2005).

As colour vision, the contrast sensitivity is affected in the aging process. "Two colours that contrast sharply to someone with normal vision may be far less distinguishable to someone with a visual disorder. It is important to appreciate that it is the contrast of colours one against another that makes them more or less discernible rather than the individual colours themselves" (Arditi 1999).

As Grenn Armytage points out (2009), further studies will be needed to establish more precise legibility scores for different colour combinations; his article called "*Hues that dis-*

*appear*”, describes the influence of the phenomenon on legibility, which has implications for designers, that should be wary of acting on assumptions, take note of the phenomenon of and consider the different ways in which colours can be manipulated to improve legibility.

In the same way, type design can improve legibility. Many studies have defined letter groups as more or less legible; although the structure and shape of the letters are important in the recognition, there are details in the design that can minimize confusion among them, especially if they are read under poor visibility conditions.



Figure 2: Comparison between Helvetica (orange) and Wayfinding Sans Pro (blue) (Pinheiro 2012).

We can summarize the main changes in vision with the aging process: loss of focusing ability (presbyopia), senile miosis, decreased visual field, decreased visual acuity, loss of central vision, difficulties with the light-dark adaptation, increased sensitivity to glare and dazzle with the brilliance, decrease in contrast sensitivity, depth perception and reduced ability to discriminate colors. Other problems may interfere with vision and the ability to perceive colors: these are Cataracts, Ageing Related Macular Degeneration, Glaucoma, Diabetic retinopathy and Retinitis pigmentosa, as the most frequent situations among older adults.

## 2. METHOD

This project was developed using a qualitative mixed methodology. After the literature review, we started an active research using posters of different sizes, from cultural events, as a pretext for the study and as observation objects. The information was summarized in identification forms, previously designed by the author, with colour coding of text and background colours in CMYK, RGB and Pantone System; we used the Colour Munki Design colorimeter by Pantone to colours codification.

The second step of the research methodology was supported by the use of Focus Groups. The target group of this study consisted on a selection of socially active individuals aged between 67 and 77 years. To support the process of viewing and analyzing posters at different distances of observation, a tool in the form of worksheet was created for each observed poster. All the results were synthesized in charts and tables.

## 3. RESULTS AND DISCUSSION

As a result of this work, we produce a manual with guidelines to be applied in the design projectual practice, in the visual communication design area. Among all the visual design elements, graphics and texts are inseparable from colour performance. We can't separate the chromatic relations from other aspects that contribute to effective communication, such as the typographic composition, texts, shapes, proportions and scale of all the elements that constitute the graphic design object. If one of the issues fails the readability and legibility gets compromised.

#### 4. CONCLUSIONS

The effective communication, legibility, readability and visibility of prints, will depend not only of colour combinations, but on the interaction of many other factors such as: shape and design of typefaces, size type, the x-height, spaces between letters, (kerning), words (tracking), lines (leading), colours and contrasts between text and background, page layout, form and weight of text, avoiding confusions between letters and numbers, reading distance, lighting conditions, surface of printing paper.

As we were studying legibility and readability concepts and colour contrasts, we always had the aim and intent to bring inclusiveness to projectual practice. These areas of knowledge will improve the design process and contribute for an inclusive and efficient design practice. When principles of universal graphic design are applied, including people who might normally be ignored in the design process, printed design objects, (or interior spaces, urban environments, products, signage and all kinds of visually information) will be effective and easier to read, not only for visually impaired people but also *for all of us*.

#### ACKNOWLEDGEMENTS

FCT – Foundation for Science and Technology and CIAUD – Research Centre in Architecture, Urbanism and Design, FAUTL, Lisbon.

#### REFERENCES

- Arditi, A., 1999. *Effective color contrast: Designing for people with partial sight and congenital color deficiencies*. New York: Lighthouse International.
- Green-Armytage, P., 2009. Hues that disappear. *Proceedings of AIC 2009*, Sydney.
- Ikeda, M., 2009. A neglected but an important color perception of elderly people. *Proceedings of AIC 2009*, Sydney.
- Marmor, M. *Normal age-related vision changes and their effects on vision*. *Lighthouse International*. Available online, [www.lighthouse.org/education-services/professional-education/patient-management/managing-the-patient-with-low-vision/normal/](http://www.lighthouse.org/education-services/professional-education/patient-management/managing-the-patient-with-low-vision/normal/). Accessed June 6, 2007.
- Meerwein, G., B. Rodeck and F. Mahnke, 2007. *Color Communication in Architectural Space*. Basel: Birkhäuser.
- Pinheiro, C., 2012. *Visual Communication and Inclusive Design-Colour, Legibility and Aged Vision*. Unpublished PhD Thesis. Technical University of Lisbon.
- Shinomori, K., 2005. Ageing effects on colour vision. Changed and unchanged perceptions. *Proceedings of AIC Colour 05*, Granada.

*Address: Maria Cristina Pinheiro, CIAUD - Faculty of Architecture, Technical University of Lisbon, Rua Sá Nogueira | Pólo Universitário | Alto da Ajuda | 1349-055 Lisboa, E-mails: pinheiro.mcristina@gmail.com, fms.fautl@gmail.com*

# The Iris of Fashion: “A Method of Colour to Create an Identity in Fashion”

Nallely RANGEL  
MOSEUA, Chief Designer

## ABSTRACT

The fashion artist propels the colour to inhabit its creations freely. It is necessary to create a method, to increase the capacity of the artist to make colours his own. Until now, we do not have a systematic investigation of the best way for the fashion artist to achieve this goal. The creative process in fashion consists of two missions: the first corresponds to the textiles and the second to the intervention of the material. From these it is configured the typology of the clothes. I add a third and essential mission: **the mission of colours**. Some fashion artists have achieved a personal appropriation of the colours they used, so we associated those colours to them. I propose a method based on the reverse process of colour and optics. The mind of the artist must nourish itself to the point of create a personal chromatic universe. Combining instinct and the systematic, the artist can manipulate colour as a material in itself, exteriorizing from his or her imagination and creative invention.

## 1. INTRODUCTION

The Fashion artist is aware that before we dress clothes, we dress colours. The Fashion artist is aware that colour must not adapt to the cut and patterns of the clothes, but colour must reign the shape. Colour, well used and merged with the Identity of the Artist, constitutes the Metageometric of clothing<sup>1</sup>. These concepts can differ of our assumptions, that may be because in fashion we often see colour as a given. *The Iris of Fashion* is a method to achieve this Identity through colour. As scientists have proved, a particular optic creates a particular personality. We can take advantage of the reverse process of colour and optic, and consciously educate the eye of the artist according to his cosmovision.

### 1.1 The Missions of Fashion

The creative process in fashion consists in two missions: the **Mission of Textile** and the **Mission of Intervention** of the materials. Know as the Typology of Fashion, it responds to the dimension of the design process. I add a third and essential mission that encompasses and expands the other two: the **Mission of Colour Identity**.

### 1.2 Identity

Identity responds directly to a time, a place, a person and his materials. It is more similar to the idea of an author than that of a designer thus it is closer to the world of art. An Identity is born in the relationship between the artist and the public; as this relationship is through a visual media, the best and more direct way to communicate this Identity is through colour. As the designer matures, summons the world into his works, and by the way, in which he or she responds to this new element, a character created. At the same time that the designer

<sup>1</sup> DEEP Palette: belongs to the Metageometric of cloths. It is the notion of colour that ordains all the elements of design: cut, tailoring, pattern, etc. Colours can dictate shape and form, texture and density of the materials.

keeps an eye to the trends of the season, a personal palette of colour it is preferred. Then, the artist begins to question: *how the world sees him and how he sees himself*. He puts himself in the world and the result is the first hint of an identity. It is the breaking point to become a *fashion artist*. The fashion artist must develop new tools like those that the *Deep palette* to be no longer subordinated to the market and trends (Figure 1).

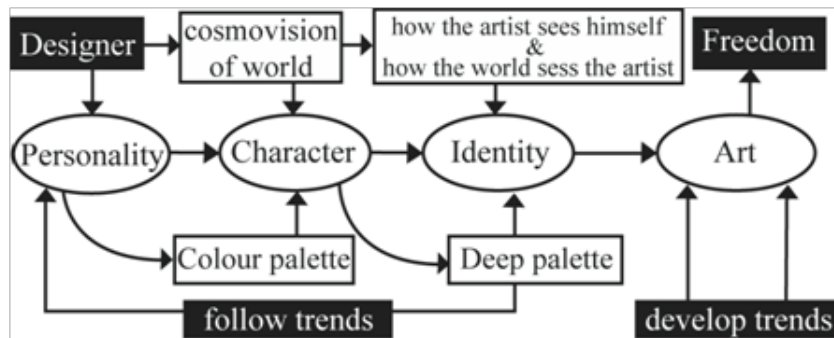

Figure 1: The way of Identity.

## 2. COLOUR CONTEXT IN ART & DESIGN

Each artist applies colour to his work following an instinctive rhythm. In Rimbaud's Vocals, a colour assigned to each letter: A-black, E-white, I-pink, O-blue, U-green. It is because colour to the artist takes part in the creative process before the materials, be it words, paint or fabrics. Alexander McQueen had an extreme appeal to green evaded by the use of red, so it shows an acute predisposition of his temper to fight with what was natural to him. That conflict helps him to create one of the best works in Fashion to this day. He mixed his Identity to the world with new values of beauty. John Berger stated that what it is of value in a work of art is the propriety that possesses as it is the expression of the author, and this expression of the author is a spiritual object: *the art plays with the process of his own visual perception*. Colour explodes in contact with the world, captivates minds that contemplate it, collectively takes control and returns to the individuality of the mind, like a vicious and productive circle. The group of *Nabis* in 1891, wanted to excite colour to create a chromatic syntax. In 1904, group of *Fauves* employed colour as a provocateur freedom to the art. Cézanne put aside the relationship between figure and the surface of art with the visible reality: A painting does not represent anything but colours (Marmor 1941).

### 2.1 Fashion, Fashion Designer & Fashion Artist

Fashion is performance, more ephemeral than life, as intense as is nature. Fashion transforms the human body and helps us to construct ourselves into the world. The fashion designer takes an idea, responds to necessities beyond dressing, and creates within the capacities of his endeavour and market, a collection that ideally stands out of all the options. The fashion artist work a little different, not because he or she is superior but because the goal is different, thinks in future: fashion forward. Without putting aside the past he tries to reinvent the Fashion and propel it to the future. He looks at the past and the present to transform them and the way he does it is through him, throughout his Identity.

### 2.2 The Fashion Artist in the World

Identity is not a state of mind or an awareness of one's own, much less the idea of what someone believes to be. The identity is a communion between the artist and the public; the vehicle is the work of art. Its medium is mainly visual, so colour is the principal element as it

is the language of light. We can expand our understanding of the world through the visions of the artist. “Art is a lie that enables us to realize the truth” (Zayas 1923). This is the truth, we realize after the encounter with the work of art: with this new vision of the world the fashion artist develops recognition in the public, to a level that creates the new trends.

### 3. TRENDS & PALETTES

We can define **trends** as the *identity of time*, in which the “specialists”, designers and consumers agree. Trends try to adapt to the season and the fashion designer employed them, and as he develops a colour palette first, then a Deep palette, the trends are replaced by identity and the idea of the collection and the artist. I divided the palettes in two: **Colour Palette**, a combination or set of preferred colours; here the designer shows his elections of colour, temperament and combinations. The **Deep Palette** shows the preferences and identity. It reveals a dominion of colour and the application and effects of colours in fabric, cuts and patterns. It is the colour intervened. It is the colour through the hands of the artist, the deep palette involves not only colour but colour applied, manipulated and modifies the shape.

#### 3.1 Proposed Fields of Work in Colour for the Fashion Artist

Here are the principal points in which the artist may drift from one to another. The focus should be in one or two but never forgetting the others as they complement each other.

##### 3.1.1 Identity & Composition

The artist or designer can create and combine in the collection one chief colour. This is the simplest way to exteriorize ones identity, but as it is simple, also superficial and only the artist with great mastery of colour can achieve real identity by this Field of Work. The danger is too be absorbed by colour so the identity is lost (Figure 2).



Figure 2. Here the artist plays with solids, combination, accents and absent.

##### 3.1.2 Identity & Experimentation of Effect

The artist experiments with the effect produced by colour, their combinations, the form of colours, contrast, and combines it with psychological and cultural perception of the works. I divided in two: **Op-art Fashion** (optical); and **Cultural Aesthetic of Colour** (effect).

##### 3.1.3 Colour as Material

Other way of treat the colour is as a material, the same way as fabrics. So it can be exploited the element of weight in colour and experiment with density and smoothness, gravity and ethereal, heaviness and lightness. Or how the colour bends and mix; this modifies the cut patterns, the embroidery, the print, and dyes.

### 3.1.4 Colour & Dynamics

The colour is treated as lineal, as a succession in time, simultaneous or narrative. There is a narrative in degradation and accumulation, as something constructed by logic or chaos as in the geometric patterns, the symmetric, or the rhythm in the motifs. It looks like a complexity held in the textile design but an intelligent artist can use the colour to give new dimensions to an outfit. It has a feeling of abstract art.

## 4. POSTULATES

**1.** The Fashion artist must be aware that before we dress cloths we dress colours. **2.** The Fashion artist is aware that colour must not adapt to the cut and patterns of cloths, but that colour must reign the shape. **3.** A good use of colour merged with the Identity of the fashion artist constitutes the metageometric of fashion design. **4.** All fashion art consists of a geometric and a metageometric of design. The geometric, in a linguistic metaphor, it is the morphologic aspect. The metageometric is colour: it is the syntax. **5.** There are three **Missions of Fashion**: Fabrics, Intervention and Identity. **6.** The only material that the fashion designer truly controls from beginning to end is the colour and dictates all other elements of the designs. **7.** It is necessary to the fashion artist to appropriate colour as a material and use it as Metageometric. Thus colour rendered with Identity will permit the artist to create with freedom not subordinated to trends, season or the market.

## ACKNOWLEDGEMENTS

Thanks so much to *Emiliano*, who helps in my investigation, and listen my ideas to improve them. Thanks to AIC2013 to give me this opportunity to share my findings of experience in colour & fashion.

## REFERENCES

- Berger, J., 2001. *Selected Essay: Art and Property Now*. Vintage International, New York, 103-107.
- Bolton, A., 2011. *Alexander McQueen: Savage Beauty*. The Metropolitan Museum of Art, New York, 103-145.
- Gerstner, K., 1988. *Forms of Color: The Interaction of Visual Elements*. Blume, 181.
- Marmor, M.F., and J.G. James, 1941. *The eye of the artist*, Morby, 60-99.
- Zayas, M., 1923. "Picasso Speaks." *The Arts*.

*Address: Nallely Rangel, Chief Designer,  
MOSEUA, Sadi Carnot., Col. San Rafael, 06470, Mexico City.*

*E-mail: maecume@hotmail.com;  
<http://cargocollective.com/nallelyrangel>; <http://cargocollective.com/MOSEUA>*



# Comparative Colorimetric Study of Scotdic Colour Specifiers

Asim Kumar ROY CHOUDHURY, Biswajit NASKAR  
Govt College of Engineering and Textile Technology, Serampore – 712201 (W.B.) India

## ABSTRACT

The object of the present extended study was to study and compare CIELAB and Munsell system colorimetrically for SCOTDIC cotton and Polyester sets. For SCOTDIC cotton, the correlation coefficients for respective CIELAB and Munsell parameters for lightness, hue and chroma are 0.9921, 0.8217 and 0.8754 respectively. The respective coefficients for polyester set are 0.9889, 0.7433 and 0.8295. Hence, the polyester samples, in general, have poorer correlation as compared to cotton set. Constant hue and constant chroma loci in CIELAB diagram deviated from radial lines and circles respectively especially at higher chroma and higher lightness.

## 1. INTRODUCTION

SCOTDIC (Scotdic Colour Book, Kensaikan Ltd., Higashi-ku, Osaka 541 Japan) a textile version of Munsell created by fusion of two quite different systems – Standard Color of Textile (Japan) and Dictionnaire Internationale de la Couleur (France), is adopted by over 8,000 companies worldwide. SCOTDIC system uses a 6-digit code for each standard colour – the first two digits for hue, the second two digits for value and the third two digits for chroma. The object of this study is to compare and correlate visual (Munsell) and instrumental (CIELAB) colour spaces. SCOTDIC cotton and polyester physical samples, which are the physical exemplification of Munsell colour order system having 2020 cotton and 2450 polyester standard samples of varying hue, value, and chroma are considered for this study. In a previous study by the author (Roy Choudhury, 2008) the uniformity of Munsell (SCOTDIC) hue, value and chroma values in CIELAB diagram were studied extensively using SCOTDIC cotton standard colours.

## 2. METHOD

The colorimetric parameters of all SCOTDIC cotton and polyester samples (2020 and 2450 chromatic samples respectively) were measured. The SCOTDIC cotton swatches are about five years old, but preserved very carefully. Instrument: Colour-Eye 2180 UV spectrophotometer of GretagMacbeth, USA; Geometry: D/8 (diffuse); Mode: large area of viewing and in specular exclude mode

## 3. RESULTS AND DISCUSSION

In the present study, colorimetric parameters namely CIELAB lightness ( $L^*$ ), redness-greenness ( $a^*$ ), yellowness-blueness ( $b^*$ ), metric chroma ( $C^*$ ) and hue angle ( $h$ ) of SCOTDIC colour standards (both 2020 cotton and 2450 polyester samples) were measured. The following studied were made thereafter.

### *SCOTDIC value and CIELAB Lightness ( $L^*$ )*

Figure 1 (a) and 1 (b) show the correlation between the above parameters for both cotton and polyester sets. For samples of a particular SCOTDIC value (but of varying hue and chroma), lightness  $L^*$  vary within a narrow range for more or less all SCOTDIC value levels. This variation is due to the fact that SCOTDIC values are discrete numbers, while  $L^*$  is in con-

tinuous scale. At two extreme ends, the ranges are narrower because of lesser number of samples. For cotton, the ranges for variation of  $L^*$  for each SCOTDIC value are 5-7 lightness units, while for polyester the ranges were broader (8-10 lightness units). The samples are almost equally distributed on both the side of the linear trend line. The correlations are best in linear regression and the correlation coefficients ( $R^2$ ) are quite high – 0.9921 and 0.9889 respectively for cotton and polyester respectively when linear trend lines is considered.

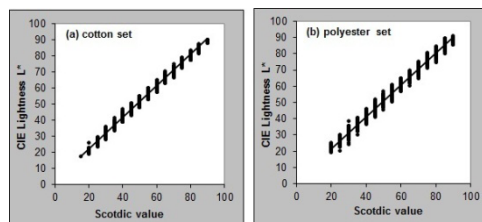

Figure 1. Correlation between SCOTDIC value and CIE lightness (a) cotton (b) polyester.

### SCOTDIC hue and CIELAB hue angle ( $h$ )

Figures 2 (a) and 2 (b) show the distribution of CIELAB hue angles against their corresponding SCOTDIC hues for all the samples of SCOTDIC cotton (2020) and SCOTDIC polyester (2050) sets respectively. The hue angles steadily increases with increasing SCOTDIC hue number except for some borderline hues. Thirty cotton SCOTDIC samples, mostly (except 2) belonging to very high SCOTDIC hue number (around 90), showed very low hue angle (around 10) instead of expected values around  $360^\circ$ . For polyester, the number of such samples is 58.

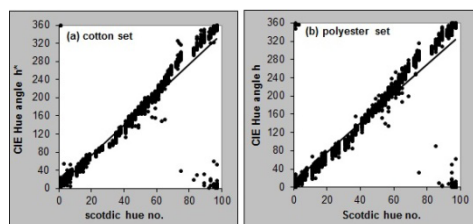

Figure 2 Correlation between SCOTDIC hue and CIE hue angle (a) cotton (b) polyester.

The ranges of hue angle are small for most SCOTDIC hues (10-20 for cotton set and 10-30 for polyester set, except some erratic hue angles for some extreme SCOTDIC hues as stated above. For some SCOTDIC hues, the ranges are narrower probably because of limited samples available for the said SCOTDIC hues. Among various trend lines, the linear and polynomial types showed high correlations. The linear trend lines are shown in the figures. The correlations are moderate (0.8217 for cotton and 0.7433 for polyester sets) though good numbers of samples are present on the both side of the trend line. When the samples of SCOTDIC hues having erratic hue angles are excluded, the  $R^2$  values for linear relation become as high as 0.9821 for cotton set and 0.9448 for polyester set.

For most of the Munsell hue, the hue angle vary between  $10^\circ$  and  $20^\circ$ , ( $10^\circ$ - $30^\circ$  for polyester set) but for a good number of Munsell hues, the hue angles vary within much broader ranges probably due to error in preparation of the samples. For a few borderline Munsell hues, the hue angles vary from  $0^\circ$  to  $360^\circ$ . But if we consider that hues belonging to hue angles  $0^\circ$  and  $360^\circ$  are identical, the range for variation of hue angle is quite narrow.

### SCOTDIC chroma and CIELAB chroma

Figures 3 (a) and 3 (b) show the distribution of CIELAB metric chroma against their corresponding SCOTDIC chroma for all the samples of SCOTDIC cotton (2020) and SCOTDIC polyester (2050) sets respectively. The CIELAB chroma for each SCOTDIC chroma distributes over a wide range and the ranges become broader with increasing SCOTDIC chroma.

At lower SCOTDIC chroma, CIELAB chroma varies within a range of 15-20 units, while at higher SCOTDIC chroma, it varies widely in a range of around 40 for cotton set and around 50 for polyester set.

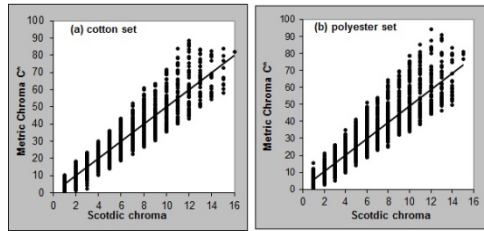

Figure 3 Correlation between SCOTDIC chroma and CIE chroma (a) cotton (b) polyester.

The distribution is little positively skewed at low chroma and reasonably negatively skewed at higher chroma. For high chroma samples, the maximum values are much more away from the average values as compared to the minimum values. The correlation coefficient between these parameters is moderate (for linear relation the coefficient of correlation is 0.8754 and 0.8295 for cotton and polyester sets respectively) and lower than those for SCOTDIC value and SCOTDIC hue (after excluding erratic samples of borderline hues). The correlation coefficients for hue and chroma with corresponding CIELAB parameters are better in smaller zones as compared to overall correlation.

*Constant SCOTDIC hue Loci*

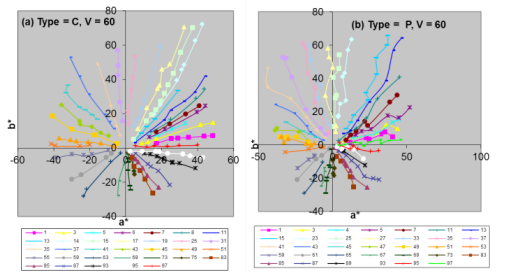

Figure 4. Constant SCOTDIC hue loci in CIELAB colour space (a) cotton (b) polyester.

Figures 4(a) and 4(b) show constant SCOTDIC hue loci in CIELAB diagrams at constant SCOTDIC value levels of 60 for cotton (type = C) and polyester (Type = P) sets respectively. The hues are chosen where there are at least 5 samples available. As expected for each SCOTDIC hue a nearly radial line emerging from origin is obtained. As shown in previous study, here also for many SCOTDIC hues the radial lines are curved at higher Chroma. But the curvature is more for polyester samples at all levels of lightness. This may be due to higher specular component of the polyester samples which disturbed the visual evaluation. During measurement the specular component has been excluded, but it may have affected visual evaluation. The hues show unequal angular spacing and in many cases, the spacing has changed at high chroma. This observation is in line with that of Hunt (1978) and may be due to visual non-uniformity of CIELAB colour space which might have been exaggerated due to error in preparation of the samples by the SCOTDIC manufacturers. For many SCOTDIC hues, the constant hue loci at various value levels overlap each other at low chroma levels, but deviate at higher chroma.

*Constant SCOTDIC chroma Loci*

Figures 5(a) and 5(b) show constant SCOTDIC chroma loci in CIELAB diagrams at constant SCOTDIC value levels of 60 for cotton set and polyester set respectively. Each diagram shows a\* and b\* values for samples of a particular chroma as separate series (chroma values are shown in the legend), but of different SCOTDIC hues. For realistic comparison of the figures, a\* and b\* values varied from +100 to -100 in each figure. The loci of constant

chroma represent near-circles with diameter increasing with increase of chroma. Theoretically all constant chroma points should be located at constant radial distance from the centre of  $a^*-b^*$  diagram. In reality, the points are increasingly scattered with increase in SCOTDIC chroma. The distortions are higher when the SCOTDIC Value is higher than 30. The distortion patterns are very similar for value levels of 50, 60 and 70. For polyester set, the points are more scattered, especially at higher chroma. Though at lower level of lightness ( $L^* = 30$ ), the chroma circles are more or less concentric with, but at higher levels of lightness ( $L^* = 50, 60, 70$ ) the radial distances of the chroma circles from the centre are higher for yellow hues i.e. the near-circles are tilted towards  $+b^*$  direction.

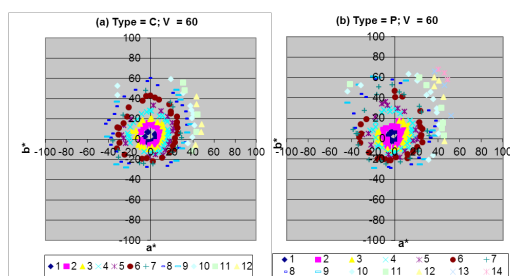

Figure 5. Constant SCOTDIC chroma loci in CIELAB colour space (a) cotton (b) polyester.

#### 4. CONCLUSIONS

The following conclusions can be made from the present study:

- 1) The correlation between SCOTDIC value and CIELAB lightness was quite high.
- 2) For some samples belonging to borderline hues (hue angle around  $0^\circ$  or  $360^\circ$ ) the predicted hue angles were quite different than expected (near zero instead of near  $360^\circ$ , and vice-versa). This resulted in moderate value of the correlation coefficient between SCOTDIC hue and CIELAB hue angle. However, the correlation improves significantly when these erratic samples are excluded. Moreover, if we consider that the hues at  $0^\circ$  and  $360^\circ$  are identical, such variations are not unexpected.
- 3) The correlation between SCOTDIC chroma and CIELAB chroma was only moderate because the CIELAB varied widely at higher chroma. It may be, therefore, concluded visual estimation of chroma is difficult and erratic for high chroma or pure colours,
- 4) In CIELAB diagram, the constant SCOTDIC hue loci take the shape of approximately linear radial lines starting from origin. However some deviations were observed for high chroma colours.
- 5) As expected, the constant chroma loci take the shape of approximately concentric circles with origin as centres at lower chroma levels. However, high chroma colours especially at higher lightness levels deviate considerably. At higher levels of lightness and chroma, the yellow hues have higher  $b^*$  values as compared to other hues of identical chroma. This is true for both cotton and polyester sets.
- 6) The polyester samples represent the visual colour spaces poorly than cotton samples and hence correlates poorly with the instrumental colour spaces.

#### REFERENCES

- Roy Choudhury, A. K., 2008. Colorimetric Study of SCOTDIC Colour Specifier, *Coloration Technology* (UK), 124, 273–284.
- Hunt, R.W.G., 1978. Colour terminology, *Color Res. Appl.* 3, 79-87

Address: Prof. A.K. Roy Choudhury,  
Govt College of Engineering and Textile Technology, Serampore – 712201 (W.B.)  
akrc2008@yahoo.in

# The Colour Perception in Shop Window and the Emotional Design: A Contribution

Simone Thereza A. MAFFEI,<sup>1,2</sup> Maria João DURÃO,<sup>2</sup> Marizilda dos Santos MENEZES<sup>3</sup>

<sup>1</sup> Faculty of Architecture, Arts and Communication, State University of São Paulo

<sup>2</sup> Colour Lab, Faculty of Architecture, Technical University of Lisbon

<sup>3</sup> Faculty of Architecture, Arts and Communication, State University of São Paulo

## ABSTRACT

The window of a store is a modulator of emotions of the viewer. Through awareness elements, driven primarily by the colour, the store takes the user to the desired object observed. That's the power of emotion in a shopping environment. The emotional message is perceived, carried to the brain by the vision and cognitively interpreted by the neural network. The result is the desire to purchase. Based on this thought, we propose a case study in shopping centres in Lisbon, Portugal. In today's period of political and financial turmoil, it is important to have knowledge of the visual result that the set of windows of a shopping centre may cause the consumer. During the months of December/12 and January/13 – the New Year festivities – windows of five shopping centres were observed and photographed from the perspective of emotional design. This study is part of the Research Doctorate in Design from the author, whose objective was to identify how colours were used during that period and what the possible effects on the emotional level, might cause the observers. The generated data corroborated the emotional design and fashion market in Lisbon.

## 1. INTRODUCTION

Over the years, the process of buying and selling has undergone several changes. Material and aesthetics have had great influence on the decision of the article to be purchased by the consumer. Currently the induction of desire is by appreciation of the subjective aspects of the product, as claimed by Garrefa (2011).

When we think of emotional reactions we may wonder if what happens with the consumer before a fashion product is an automatic reaction, an emotion of positive value. The importance of this consideration is the fact that the same product displayed will cause desire to purchase in different people.

Every act of perception begins in neurological processing of information captured. Among the senses, vision is recognized as the most important. The graphical visualization of space serves for the construction of visual thinking, ideation, perception and understanding of it. This process generates emotions and feelings.

Among the visual stimuli, colour is a sensation that results from the reflection of light on a surface and is interpreted by the brain through vision. When we consider colour, other attributes of fashion products like texture of material should be associated since it is responsible for different impressions, according to the lighting used. Furthermore, colours allied to forms also gain various and diverse meanings.

Durão (2005) refers that in order to conceptualize colour, one requires knowledge of multiple aspects of visual perception, such as physiology, psychology, history of material and the ability to articulate colour with light to give form to a given space. It is not only a matter

regarding the application of a pigment, since colours can produce many effects and have different actions on the observer depending on a complex range of variables.

Therefore, the designer needs to know how the user perceives the colour of the window. Assess whether the compositions evoke emotions in the expected consumer is equally important, since, if the window does not induce the purchase desire, the same does not fulfil its function.

The case study was based on the following premise: the set of elements of a shop window display promotes a chromatic composition full of meanings that provides different perceptions and emotions in users who observe them, because it is from the organization of visual stimuli by colours, that the forms, volumes, and textures are distinguished.

## 2. METHOD

Five shopping centres of Lisbon, chosen according to the number of movements of people and size were observed and photographed. The images were taken during the months of December 2012 and January 2013. For images, we used non-professional digital camera. The aim was to get images like those seen by any of the passers of the site and analyse the chromatic appearance of the entire window, in other words, to study the “chromatic sensations” when looking at the display.

This study did not intend to discuss the colours that should compose a showcase or review existing ones on captured images. To do so would require an instrumental analysis or comparison with standardized samples. Shop windows of fashion were photographed, focusing on clothing stores. The images were arranged in a panel of 100 × 100 cm. The first organization was random and a fragment thereof is shown in Figure 1.



Figure 1: Fragment of the first panel of the case study. Photo: Personal Archive, 2013.

After reviewing the panel a strong presence of blue-grey and earth tones stood out as main chromatic features. So there was a second rearrangement of photographs, this time by chromatic similarity. Figure 2 shows a fragment of the second panel.

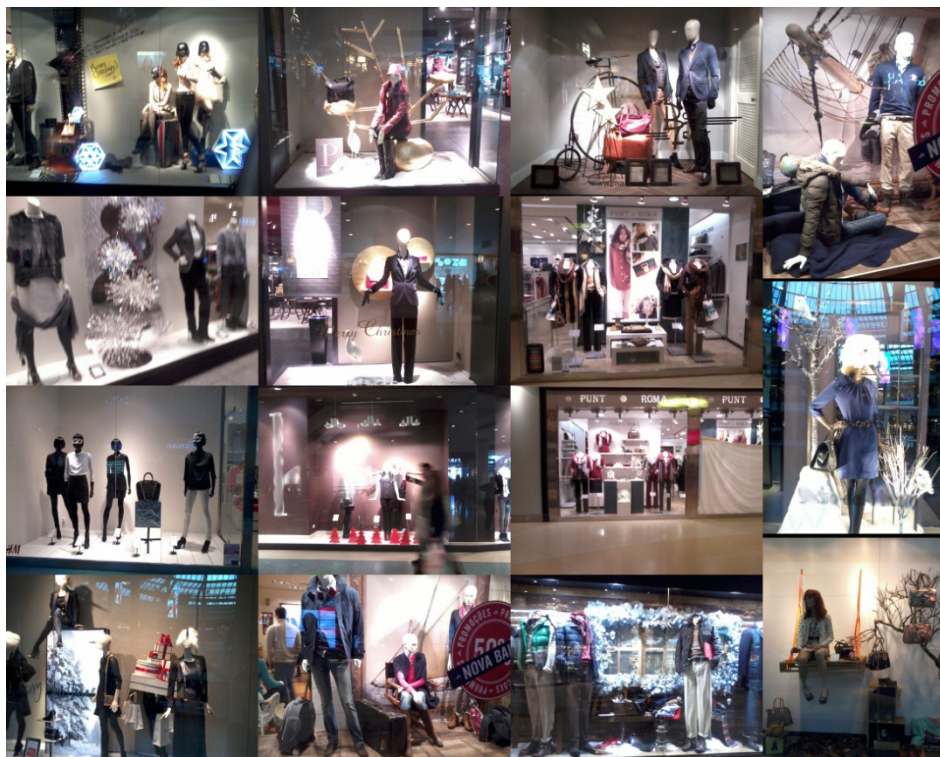

Figure 2: Second analysis panel - chromatic similarity. Photo: Personal Archive, 2013.

In a shopping centre there is a great deal of information available for the people passing by. Knowing the amount and quality of information in a store can guarantee success in sales and even customer loyalty. The designers responsible for the windows should then compare and weigh the items to display. However, to what extent is it interesting for the stores to maintain such chromatic monotony as observed in this analysis?

### 3. RESULTS AND DISCUSSION

What is intended with this study is that the professionals involved with the trademarks displayed in the window understand and consider the ability of the viewer to absorb and give sense to the relationships established between colour and size, shapes, structures and other interacting stimuli displayed in the window.

The perceived colours of the images are tonalities of black, grey, brown and blue. Heller (2012) presents a study of chromatic preferences showing that the less pleasing are firstly, brown (20%) and thirdly, grey (14%). In our study, these are two of the predominating hues found in the images. As for the black and bluish hues also found as predominant in our study, blue corresponds to the preferred colour in Heller's preference study (45%), with black as the fourth more pleasing colour.

Colour without meaning does not exist. The impression or message communicated is determined by its context and the elements that contain the colours. In the shop windows internal lighting systems create a chromatic ambience with several meanings for the observer of the exhibition system. The same occurs with the colours of the elements and forms of clothes

or dummies. In our photographic references, the chromatic compositions refer to introversion and negative emotions, according to colour psychology.

According to Itten (1973), the eye and the mind perceive through comparison and contrast. So you need to give special attention to the psychological, physiological, visual and aesthetic aspects of colours. Lancaster (1996) states that colour has great power of interference in the environment. The excess of visual information - chromatic in this case- results in the viewer only seeing what is differentiated by personality or else, when the observer identifies with the observed. However, since vision is motivated by stimuli, lack of information or monotony prevents the viewer to visually perceive the message.

#### 4. CONCLUSIONS

Chromatic effects depend on a positive balance between variety and contrast. Colours can model, harmonize, differentiate, unify, equalize or change proportions. Therefore, choice of the dominant colour in a shop window display is indeed important.

Each store is responsible for its shop window, but it is necessary to be aware of the chromatic set that results from the sequence of windows in a shopping centre. In this study, the promotion of chromatic monotony can create negative emotions, according to colour psychology. Fashion designers need to be aware of standardization and monotony of the fashion market. Innovation in product presentation to the consumer may cause some uncertainty as to how much receptivity it may achieve, but the homogenization of windows tends to be an obstacle in sales since it does not arouse attention and, consequently, the emotion.

#### ACKNOWLEDGEMENTS

CAPES Foundation, Ministry of Education of Brazil, Brasília – DF, 70040-020, Brazil.

#### REFERENCES

- Durão, M.J., 2005. *Abordagem conceptual e sensorial à cor na sua aplicação à arquitetura industrial*, FABRIKART: Arte, Tecnologia, Indústria, Sociedade. 5ª. Ed. Universidad Del País Vasco and Euskal Herriko Unibertsitatea. 34-39.
- Garrafa, F., 2011. *Shoppings Centers: de centro de abastecimento a produto de consume*. São Paulo: Editora Senac.
- Heller, E., 2012. *A psicologia das cores: como as cores afetam a emoção e a razão*. Barcelona: Editorial Gustavo Gili.
- Itten, J., 1973. *The Art of Color: the subjective experience and objective rationale of color*. New York: Van Nostrand Reinhold.
- Lancaster, M., 1996. *Colourscape*. London: Academy Editions.

*Address: Msc. Simone Thereza Alexandrino Maffei. Brazil: Post graduate Department of Design of Faculty of Architecture, Arts and Communication, State University of São Paulo “Júlio de Mesquita Filho”, Avenue Eng. Edmundo Carrijo Coube, Campus Bauru, São Paulo State. Portugal: Colour Lab of Faculty of Architecture, Technical University of Lisbon, Sá Nogueira Street, Campus Ajuda, Lisbon.  
E-mails: simone.maffei@hotmail.com; sithereza@gmail.com*



# Change in Food Color During Cooking with Steam Oven

Hiroyuki IYOTA,<sup>1</sup> Hideki SAKAI,<sup>2</sup> Yusuke MAMIYA<sup>1</sup>

<sup>1</sup> Graduate School of Engineering, Osaka City University

<sup>2</sup> Graduate School of Human Life Science, Osaka City University

## ABSTRACT

Steam ovens heated with hot air and/or superheated steam are becoming popular for domestic and commercial use. These ovens are known as “superheated steam ovens” or “steam convection ovens.” Food color is one of the most important metrics of an oven-cooking process. However, conventional colorimetric equipment cannot be used for measurement of color during food processing because such processes usually involve high temperatures and wet surfaces. Thus, in the present study, the change in food color during oven heating was measured. A spectrometer and a glass fiber probe were used for continuous measurements during heating under the temperature of 200 °C. Two types of food materials were used as samples: a crumb of sliced bread, and a raw meat pate. In the case of the bread sample, the baking time was shorter under the high humidity (the high dew point temperature) condition. In the case of the raw meat sample, rapidly increasing humidity caused the denaturation of meat protein, and this changed the meat’s color in a short period of time. These results, and the color-measurement techniques used in this study, could contribute to the technological advancement of oven design, and to the optimization of oven operation.

## 1. INTRODUCTION

Steam ovens that are heated with hot air and/or superheated steam are becoming popular for domestic and commercial use because they provide certain benefits such as good texture of the heated food, short heating times, homogeneous heating, and preservation of nutrients. These ovens are known as “superheated steam ovens” or “steam convection ovens.” During heating with these devices, the steam partial pressure in the oven chamber changes, particularly in the initial stages. Previously, we reported the effects of humidity changes on the properties of dried heat- and moisture-sensitive material using basic laboratory equipment and on the defatting and dehydration of meat products in a steam convection oven (Iyota 2008, Yamagata 2011).

In the cooking process, both food color and cooking time are the most important factors. In general, a food’s color is strongly related to its taste, smell, and texture. Thus, color measurement methods and objective evaluations of food color are essential for improving food quality. However, conventional colorimetric equipment is not applicable to the measurement of color during food processing as such processes usually involve high temperatures and wet surfaces. Furthermore, food color and corresponding colorimetric images are affected by observation conditions such as light source location and angle, distribution of space, intensity, light spectrum, and observational direction. Therefore, careful consideration of these conditions is necessary for the proper recording of food color information.

In the present study, the change in food color during oven heating was measured. To do this, a spectrometer and a glass fiber probe were used for continuous measurements during heating. Two types of food materials were used as samples: a crumb of sliced bread, and a raw meat pate. These samples differed from each other in terms of their initial color, heat

sensitivity, moisture content, and structure. The measurements were performed under three pre-set steam oven operation modes.

## 2. METHOD

### 2.1 Steam Convection Oven

A commercial steam convection oven (Tanico Corporation, Model TSCO-4GBN2), which was originally designed for a commercial kitchen but modified for this research, was used. A schematic model of the oven is shown in Figure 1. To measure color and humidity, a few small holes and windows were made in the upper side of the oven chamber (9), which was 510 mm wide, 390 mm high, and 390 mm deep. The humidity was continuously measured by monitoring the wet-bulb temperature ( $T_{\text{wet}}$ ) of wet spherical gauze (13). Both the dew-point temperature and steam mole fraction in the chamber were calculated from the wet-bulb temperature (Iyota 2008).

A multi-blade centrifugal fan (6) and a heating tube (7) with a diameter of 52 mm were placed on the left side of the chamber (9). The chamber temperature was regulated automatically to 200 °C by indirect gas combustion, and the steam mole fraction  $x$  (the mixing rate of air and steam) was varied by regulating the steam supply to the chamber. The flow rates of the city gas were monitored using flow meters (3). The sample food materials: a crumb of sliced bread, and a raw chicken pate, (11) were placed on a stainless tray (10) in the upper portion of the chamber for measurement of their respective surface colors.

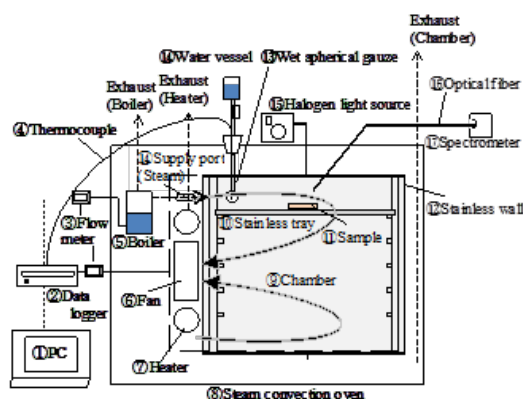

Figure 1: Steam convection oven.

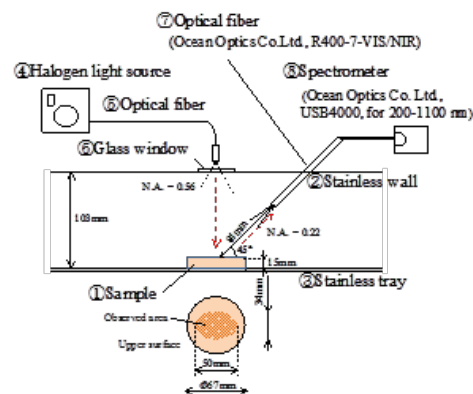

Figure 2: Colorimetric measurement configuration.

### 2.2 Colorimetric Measurement Configuration Setup

Figure 2 shows the colorimetric measurement devices used, and their dimensions. These devices were as follows: a halogen lamp (4), a multimode optical fiber (bundle diameter of 8 mm, N. A. = 0.56) to transmit the source light, and an emitting-receiving optical fiber (Ocean Optics Co. Ltd., R400-7-VIS/NIR, N. A. = 0.22, heatproof temperature of 300 °C) to transmit the light reflected from the food surface to a spectrometer (Ocean Optics Co. Ltd., USB4000). The emitting-receiving fiber probe is a commercial product and it consists of seven multimode glass fibers, each having a diameter of 400  $\mu\text{m}$ . In this study, we only used the center fiber of the probe as the receiving fiber (7). The receiving angle of the probe was set at 45°, as shown in Figure 2.

The reflectance spectra were recorded at 5 s intervals using a spectrometer connected to a PC via a USB port. The relative reflectance spectrum  $\rho(\lambda)$  of the sample was derived from the reflectance spectrum of a spectralon diffuser (Labsphere Co., Ltd.) with 99% reflectance.

The CIE 1976  $L^*a^*b^*$  values of the sample surface were derived from  $\rho(\lambda)$  using the spectrum of CIE Standard Illuminant D65 and the CIE 1931 2-deg. color-matching functions. During these optical measurements, the glass window on the front door of the steam convection oven was covered using an aluminum plate for ambient light shielding.

To investigate the accuracy of this color measurement method, a color chart (X-Rite, Inc., ColorChecker Classic), which consists of 24 precisely calibrated color chips, was used as a reference. The chart was cut into 24 pieces, where each piece had a unique color that was measured in the oven at room temperature. The average color differences between the standard reference values of the chart and the measured values for  $L^*$ ,  $a^*$ , and  $b^*$  of the 24 colors were 1.81, 4.07, and 10.92, respectively. The measured values for  $L^*$  were in good agreement with the standard reference values.

### 2.3 Experimental Heating Conditions

*In-situ* color measurement was performed under three pre-set steam operation programs: 1) heating without a steam supply (HA), 2) a sequence of steam supply for 20 s, followed by a break for 160 s (SHS\_low), and 3) a sequence of steam supply for 30 s with a break for 25 s (SHS\_high). Each test was performed three times. The chamber temperature  $T_g$  was automatically regulated at 200 °C, and the flow velocity of air near the sample, which was measured for reference at room temperature in room air without supplying steam, was around 3.3 m/s.

## 3. RESULTS AND DISCUSSION

Generally, when the temperature of a sample being heated was lower than the dew point temperature, steam condensation occurred on its surface. Simultaneously, the temperature and moisture content at the surface of the sample increased rapidly. Therefore, during heating, the properties of the sample, especially surface color and hardness, flavor, changes in size, etc., could have been affected by the steam mole fraction in the chamber.

Figure 3 shows the color change of the sliced bread crumb in a color bar with RGB values converted from the  $L^*$ ,  $a^*$ , and  $b^*$  values of the measured spectra (Note: this figure shows the original color only on well-calibrated sRGB monitor/printers). Below the color bar, the values of  $L^*$  are shown in a diagram. At each condition (pre-set steam operation programs), up to around 180 s, the value of  $L^*$  is approximately 90. At 180 s,  $L^*$  begins to decrease owing to browning of the sample. The browning of the bread was primarily caused by the Maillard reaction between free amino acids and reducing sugars under high temperature. Under the SHS\_high condition, the value of  $L^*$  decreases faster than it does under the other conditions. The reason for this could be an increase in the free amino acids and reducing sugars owing to the high dew point temperature and steam condensation on the sample surface at an early stage. However, the amount of condensate on the surface of the bread would be less than that observed on other food sample surfaces because the thermal conductivity and heat capacity (per unit volume) of the bread are smaller and because the bread has high porosity and low moisture content.

Figure 4 shows changes in the color of the chicken pate during heating. Under all the conditions, the values of  $L^*$  slightly decrease from the onset of heating. This could be due to the increasing density of solid components caused by drying at the surface. However, subsequently, the values of  $L^*$  significantly increase as the color of the chicken pate changes from red-tinged to white. The chicken breast meat contains approximately 75 % water as a

major ingredient and 20 % protein. The changes in the surface color and the value of  $L^*$ , in the early stages of heating, were due to thermal denaturation of the protein. The denaturation temperature of the protein ranged from 40–80 °C. These results reveal that the steam mole fraction (dew point and wet bulb-temperatures) in the oven chamber strongly affected the change in color of the meat samples. After approximately 720 s, the values of  $L^*$  decrease, and browning occurs as the samples bake.

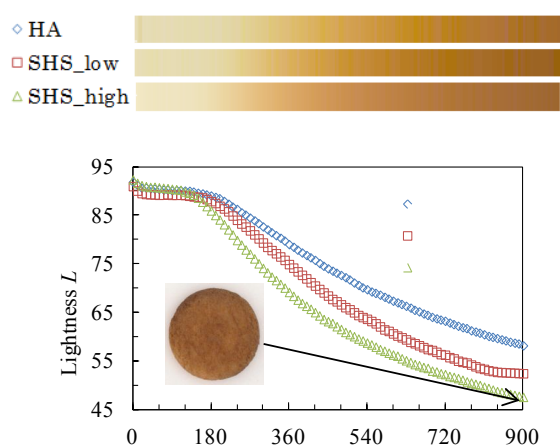

Figure 3: Results for sliced bread crumb.

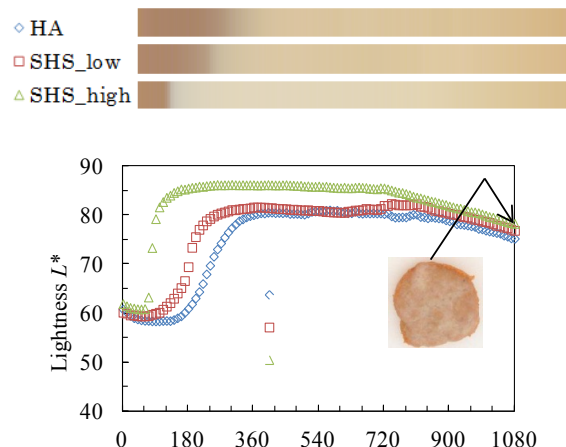

Figure 4: Results for chicken pate.

These results and the color-measurement techniques used in this study are expected to contribute to the technological advancement of oven design, and to the optimization of oven operation. For this purpose, we are also considering the formulation and the browning scale of the coloring process (Sakai 2011), as well as the relationship between the baked colors and sensory inspection data.

### ACKNOWLEDGEMENTS

This work was partially supported by the programs of the Grant-in-Aid for Scientific Research (C) by the Japan Society for the Promotion of Science, KAKENHI (No. 23500934).

### REFERENCES

- Iyota, H., T. Inoue, J. Yamagata and N. Nishimura, 2008. Effect of time-dependent humidity profiles from air to superheated steam on drying of a wetted starch sphere, *Drying Technology* 26(2): 211-221.
- Sakai, H., and H. Iyota, 2012. Development of Browning Scale of Baked Foods Based on Color Measurement. In *AIC 2012, Proceedings*, ed. by TR. Lee and J. Shyu. Taipei: Chinese Culture University, 258-261.
- Yamagata, J., H. Iyota, K. Sugiyama and N. Nishimura, 2011. Defatting and dehydration of meat products during heating in steam convection oven, *Journal of the Japanese Society for Experimental Mechanics* 11: SS86-SS91.

Address: Dr. Hiroyuki Iyota, Graduate School of Engineering, Osaka City University, Sugimoto 3, Sumiyoshi-ku, Osaka City, 558-8585 Japan  
E-mails: iyota@mech.eng.osaka-cu.ac.jp, hsakai@life.osaka-cu.ac.jp

# Online Consumer Expectation of Fresh-Cut Fruit and Vegetables Preference on Different Types of Monitor

Pratoomtong TRIRAT,<sup>1</sup> Somporn JENKUNAWAT<sup>2</sup>

<sup>1</sup> Faculty of Mass Communication Technology

<sup>2</sup> Faculty of Agricultural Technology

Rajamangala University of Technology Thanyaburi

## ABSTRACT

This research was aimed to study consumers' expectation on preference and purchasing decision of the fresh-cut fruit and vegetables in packages of different colours displayed through CRT, LCD and LED monitors. The results showed that the  $\leq 25$  year-old consumers rated at most preferred and more preferred for green packages ( $L^* 84.38$ ,  $a^* -43.85$ ,  $b^* 86.76$ ) displayed on LCD and LED monitors while the  $>25$  year-old consumers rated at moderate preferred and more preferred for green packages on LED monitor. Concerning the purchasing decision of the  $>25$  year-old group, the highest percentage was on green packages of all kinds of fresh-cut fruits and vegetables displayed on all types of monitors. The green packages showed major influence on preference and purchasing decision on fresh-cut fruit and vegetables.

## 1. INTRODUCTION

Fresh-cut produce implies fruit or vegetables that have been prepared and subsequently packaged to provide convenient and safe ready-to-eat products to consumers, while their live and fresh stage is maintained. In the past few years, fresh-cut produce has been increasing in sales worldwide (Gonzalez-Aguilar et al, 2011). This is an indication that the fresh-cut industry is expanding faster than any other segment of the fruit and vegetable market. The fresh-cut segment supplies both the food service industry and retail outlets. Due to the purchasing habit change by means of technology, online sale of different products including fresh vegetables and fruit is increasingly popular. Most research studied the utilization of colour on packages to represent the produce taste or the influence of colour on consumers' buying behavior. Packages for fresh-cut produce are different from snack packages as the former would allow consumers to see the produce as clearly as possible; thus, package colour will play an important role on consumer decision. For advertisements through the Internet, the monitor is an important media to connect the consumers and the products. Currently, the popular display monitors in Thailand are LED, LCD and CRT. The objectives of this study were to investigate types of monitors as well as the combination of the package and the produce colour that affect the consumers' expectation of preference and purchasing decision on fresh-cut fruit and vegetables.

## 2. METHOD

The experiment was done by online uploading the pictures of fresh-cut fruit and vegetables packed in various package colours. Six kinds of fresh-cut fruit and six kinds of fresh-cut vegetables were tested – pineapple (*Ananas comosus* L.), orange (*Citrus sinensis* Navel), dragon fruit (*Hylocercus undatus* (Haw) Brit.), watermelon (*Citrullus lanatus*), green cantaloupe (*Cucumis melo* L. var. *cantaloupensis*), green apple (*Malus domestica* Borkh), cauliflower (*Brassica oleracea* var. *botrytis*), broccoli (*Brassica oleracea* var. *italica*), yellow pepper (*Capsicum annuum* Linn.), tomato (*Lycopersicon esculentum* Mill.), purple cabbage

(*Brassica oleracea* Linn.) and carrot (*Daucus carota* Linn.). The CIEL\*a\*b\* of packages, fresh-cut fruit and vegetables were measured by using a colorimeter (CS-100 Konica Minolta). Sixty students and officials of the Faculty of Mass Communication Technology were divided in two groups: ≤ 25 and >25 years old, to rate their preference and purchasing decision, using a 1 – 5 rating scale after viewing the pictures of fresh-cut fruit and vegetables through three types of monitors – CRT (Cathode Ray Tube), LCD (Liquid Crystal Display) and LED (Liquid Emitting Diode). The experiment was set up in a daily life environment for participants to watch the display using computers.

Table 1. The CIE L\*a\*b\* of packages and fresh-cut fruit, average score on preference for package colour on different types of monitors.

Fruit/package colour (L*a*b*) ≤ 25		CRT		LCD		LED	
		≤ 25	>25	≤ 25	>25	≤ 25	>25
		$\bar{x} \pm S.D.$	$\bar{x} \pm S.D.$	$\bar{x} \pm S.D.$	$\bar{x} \pm S.D.$	$\bar{x} \pm S.D.$	$\bar{x} \pm S.D.$
Orange (58.32,8.24,59.60)	White (100,-6.17,6.16)	3.12±1.06	2.60±1.04	2.83±1.41	3.25±1.25	3.10±1.30	3.70±1.13
	Orange (66.21,61.24,61.65)	3.30±1.20	2.70±0.86	3.63±1.15	3.10±1.17	3.60±0.09	3.30±1.30
	Green (84.38,-43.85,86.76)	<b>3.47±1.26</b>	<b>3.70±0.80</b>	3.43±1.30	<b>3.85±1.09</b>	<b>3.73±1.24</b>	<b>4.25±0.85</b>
	Blue (59.53,-17.09,-40.34)	3.10±0.95	3.05±0.75	3.43±1.03	3.35±0.99	3.43±1.03	3.40±0.88
	Pink (51.61,64.46,-6.62)	3.30±1.01	2.90±0.78	<b>3.65±1.00</b>	3.35±0.93	3.68±1.02	3.45±0.94
Pineapple (75.34,0.40,52.86)	White (100,-6.17,6.16)	3.07±1.28	2.90±1.25	3.00±1.32	3.45±1.32	3.15±1.33	3.95±1.15
	Orange (66.21,61.24,61.65)	<b>3.57±0.87</b>	3.05±1.23	<b>3.60±0.81</b>	3.20±0.89	3.63±1.10	3.25±1.07
	Green (84.38,-43.85,86.76)	3.45±1.10	<b>3.30±1.17</b>	4.08±1.10	<b>3.70±1.03</b>	<b>3.68±1.23</b>	<b>3.95±1.15</b>
	Blue (59.53,-17.09,-40.34)	3.30±0.96	2.70±0.92	3.35±1.10	2.90±1.25	3.53±1.18	3.25±1.02
	Pink (51.61,64.46,-6.62)	3.47±0.98	3.00±0.73	3.68±1.19	3.25±0.79	3.60±1.19	3.75±0.91
Green apple (78.15,-9.39,32.07)	White (100,-6.17,6.16)	3.00±1.41	2.95±1.19	3.05±1.41	3.15±1.23	3.23±1.37	3.60±1.14
	Orange (66.21,61.24,61.65)	3.25±1.00	2.65±0.88	3.48±0.99	3.20±1.01	3.55±0.96	3.45±0.83
	Green (84.38,-43.85,86.76)	<b>3.85±1.33</b>	<b>3.00±1.17</b>	<b>4.20±1.04</b>	<b>3.75±1.07</b>	<b>3.98±1.31</b>	<b>4.25±0.91</b>
	Blue (59.53,-17.09,-40.34)	3.47±1.10	3.00±0.92	3.35±0.98	3.10±0.97	3.48±1.09	3.45±0.76
	Pink (51.61,64.46,-6.62)	3.30±1.01	2.85±0.88	3.48±0.99	3.50±1.05	3.78±1.07	<b>3.40±1.05</b>
Watermelon (39.50,25.85,26.06)	White (100,-6.17,6.16)	2.90±1.31	2.55±0.89	3.20±1.34	3.10±1.25	3.10±1.60	3.35±1.35
	Orange (66.21,61.24,61.65)	3.05±1.08	2.45±1.05	3.53±0.93	3.30±0.92	3.35±1.12	3.25±1.21
	Green (84.38,-43.85,86.76)	<b>3.52±1.35</b>	<b>3.45±1.23</b>	<b>4.33±0.94</b>	<b>4.05±0.76</b>	<b>4.10±1.03</b>	<b>4.20±0.83</b>
	Blue (59.53,-17.09,-40.34)	3.25±1.03	3.00±0.97	3.58±1.03	3.50±0.95	3.50±0.96	3.70±0.66
	Pink (51.61,64.46,-6.62)	2.97±1.22	2.90±1.02	3.28±0.88	3.80±0.83	3.63±1.19	3.60±0.99
Dragon fruit (50.60,-2.11,8.80)	White (100,-6.17,6.16)	2.32±1.38	2.85±1.14	2.48±1.22	3.05±1.28	3.00±1.52	3.60±1.23
	Orange (66.21,61.24,61.65)	3.25±0.92	2.80±1.01	3.60±0.87	3.10±1.12	3.48±1.06	3.45±1.00
	Green (84.38,-43.85,86.76)	<b>4.00±1.06</b>	<b>3.45±1.10</b>	<b>4.10±0.90</b>	<b>3.85±0.81</b>	<b>4.33±1.07</b>	<b>3.85±0.93</b>
	Blue (59.53,-17.09,-40.34)	3.15±0.97	2.60±0.82	3.20±1.20	3.30±0.86	3.55±1.08	3.45±0.94
	Pink (51.61,64.46,-6.62)	3.72±1.19	2.85±0.93	3.68±1.05	3.80±1.01	3.35±1.08	3.55±0.94
Green cantaloupe (64.43,-11.96,28.39)	White (100,-6.17,6.16)	2.77±1.34	2.85±1.18	2.93±1.40	3.30±1.13	2.98±1.46	3.60±1.27
	Orange (66.21,61.24,61.65)	3.30±1.04	2.55±1.28	3.68±0.92	3.55±0.94	<b>3.53±0.93</b>	3.45±0.83
	Green (84.38,-43.85,86.76)	<b>3.62±1.35</b>	<b>3.30±1.13</b>	<b>3.90±1.08</b>	<b>3.95±0.94</b>	4.13±1.20	<b>4.55±0.60</b>
	Blue (59.53,-17.09,-40.34)	3.22±1.04	2.70±0.98	3.55±1.06	3.30±0.80	3.48±1.13	3.60±1.10
	Pink (51.61,64.46,-6.62)	3.32±1.02	2.50±0.89	3.78±1.10	3.45±1.28	3.65±1.10	3.35±1.09

\* Preference score 4.21 – 5 = most preferred, 3.41 – 4.20 = more preferred, 2.61 – 3.40 = moderate preferred, 1.81 – 2.60 = less preferred, 1.00 – 1.80 = least preferred

**Bold letter** = the highest percentage of decision to purchase

### 3. RESULTS AND DISCUSSION

The results showed that both groups rated fresh-cut fruit displayed on LED monitor at highest score and the average score was most preferred for all fresh-cut fruit in green packages while pictures displayed on LCD monitor was rated at most preferred for watermelon packed in green packages by the >25 year-old group. The pictures displayed on CRT monitor were rated at moderate preferred while both groups rated all kinds of fresh-cut fruit at more preferred. The highest preference score was for the green packages for all kinds of fresh-cut fruit and display monitors. Similarly, purchasing decision was going along with the highest score for preference of the green packages for nearly all kinds of fresh-cut fruit and display monitors as rated by both groups (Table 1).

Table 2. The CIE L\*a\*b\* of packages and vegetables, average score on preference for package colour on different types of monitors and the purchasing decision.

Vegetable/package colour (L*a*b*)		CRT		LCD		LED	
		≤ 25	>25	≤ 25	>25	≤ 25	>25
		$\bar{x} \pm S.D.$	$\bar{x} \pm S.D.$	$\bar{x} \pm S.D.$	$\bar{x} \pm S.D.$	$\bar{x} \pm S.D.$	$\bar{x} \pm S.D.$
Cauliflower (56.84,-3.77,21.53)	White (100,-6.17,6.16)	2.50±1.30	2.95±1.00	2.60±1.39	3.30±1.13	3.08±1.35	3.60±1.14
	Orange (66.21,61.24,61.65)	3.50±1.01	2.75±1.16	3.68±0.89	3.20±1.06	3.60±0.74	3.45±0.89
	Green (84.38,-43.85,86.76)	4.05±1.11	3.05±1.19	4.20±1.02	3.85±1.04	4.03±1.03	4.35±0.93
	Blue (59.53,-17.09,-40.34)	3.23±1.00	2.75±1.12	3.50±1.04	3.05±1.10	3.48±1.09	3.30±0.80
	Pink (51.61,64.46,-6.62)	3.33±0.97	2.70±0.92	3.58±1.01	3.15±1.04	3.75±1.01	3.65±1.09
Broccoli (21.82,-9.60,15.24)	White (100,-6.17,6.16)	3.15±1.41	2.80±1.11	3.18±1.39	3.50±1.00	3.30±1.52	3.65±1.18
	Orange (66.21,61.24,61.65)	3.58±1.01	2.60±0.99	3.75±0.93	3.45±0.89	3.80±1.07	3.40±0.99
	Green (84.38,-43.85,86.76)	3.78±1.33	3.30±1.22	3.40±1.17	3.75±0.91	4.03±1.05	4.00±0.97
	Blue (59.53,-17.09,-40.34)	3.30±1.02	2.55±1.00	3.40±1.13	3.15±1.09	3.58±1.08	3.25±1.12
	Pink (51.61,64.46,-6.62)	3.33±0.94	3.00±1.17	4.13±1.09	3.55±1.10	3.48±0.88	3.55±0.94
Yellow Pepper (53.89,16.00,76.46)	White (100,-6.17,6.16)	3.15±1.23	3.15±1.09	3.43±1.43	3.45±1.05	3.43±1.34	3.45±1.10
	Orange (66.21,61.24,61.65)	3.25±1.43	2.65±1.09	3.33±1.07	3.15±1.04	3.65±0.92	3.35±0.93
	Green (84.38,-43.85,86.76)	3.68±1.14	3.30±1.08	4.03±1.17	3.65±1.23	4.08±1.02	3.75±1.21
	Blue (59.53,-17.09,-40.34)	3.55±1.22	2.95±1.10	3.58±1.15	3.35±0.75	3.65±1.00	3.40±0.99
	Pink (51.61,64.46,-6.62)	3.28±1.15	2.95±0.89	3.40±1.15	3.40±1.23	3.60±1.22	3.90±0.97
Tomato (32.96,23.00,23.25)	White (100,-6.17,6.16)	3.18±1.39	2.90±1.07	3.43±1.45	3.55±1.10	3.35±1.33	3.65±1.09
	Orange (66.21,61.24,61.65)	3.23±1.21	2.95±1.19	3.63±0.98	3.05±1.05	3.65±1.03	3.50±0.95
	Green (84.38,-43.85,86.76)	3.88±1.14	3.70±1.17	3.98±1.12	4.05±1.00	4.18±0.98	4.20±0.89
	Blue (59.53,-17.09,-40.34)	3.10±1.01	2.85±0.81	3.40±1.06	3.10±0.91	3.48±1.11	3.65±0.93
	Pink (51.61,64.46,-6.62)	3.13±1.24	2.95±1.23	3.30±1.09	3.60±0.94	3.30±1.16	3.85±1.04
Purple Cabbage (29.17,5.46,-1.48)	White (100,-6.17,6.16)	2.63±1.37	2.80±1.01	3.03±1.39	3.35±1.14	3.30±1.34	3.65±1.14
	Orange (66.21,61.24,61.65)	3.18±1.15	2.70±0.86	3.70±1.04	3.10±1.02	3.90±0.87	3.10±0.97
	Green (84.38,-43.85,86.76)	3.78±1.21	3.00±1.26	4.20±1.07	4.20±0.70	4.28±0.96	4.15±0.88
	Blue (59.53,-17.09,-40.34)	2.98±1.00	2.90±0.97	3.38±0.93	3.40±0.68	3.40±0.90	3.60±0.75
	Pink (51.61,64.46,-6.62)	3.10±1.08	2.90±1.21	3.45±1.11	3.65±0.99	3.73±1.11	3.75±1.12
Carrot (37.97,32.59,43.90)	White (100,-6.17,6.16)	2.63±1.37	2.80±1.01	3.03±1.39	3.35±1.14	3.30±1.32	3.70±1.08
	Orange (66.21,61.24,61.65)	3.18±1.15	2.70±0.86	3.70±1.04	3.10±1.02	3.50±1.20	3.60±1.19
	Green (84.38,-43.85,86.76)	3.78±1.21	3.00±1.26	4.20±1.07	4.20±0.70	4.38±0.98	4.30±0.80
	Blue (59.53,-17.09,-40.34)	2.98±1.00	2.90±0.97	3.38±0.93	3.40±0.68	3.33±1.02	3.50±0.69
	Pink (51.61,64.46,-6.62)	3.10±1.08	2.90±1.21	3.45±1.11	3.65±0.99	3.58±1.11	3.60±1.05

The results for vegetables were similar to fresh-cut fruit. The highest score of preference was for the green packages, especially for LED monitor on which most preferred was rated for carrot, purple cabbage and cauliflower and all were packed in green packages. The highest percentage of purchasing decision was also for green packages, except for the yellow pepper that the >25 year-old group went for pink packages and LED monitor, and for the tomato that the ≤ 25 year-old group went for white packages and CRT monitor (Table 2).

Quijano and Kadamani (2012) mentioned the essential of colour and subjective meanings derived from individual's personal experiences, culture and socialization in his environment. Meanwhile, the freshness perception of vegetables was highly influenced by the luminance distribution present in food texture (Arce-Lopera et. al, 2013). For product image, it was found that consumers' experience and product characteristics influenced the image's colour (Ngo et al, 2012). The green package showed its potential to create preference and final purchasing decision for almost fresh-cut fruit and vegetable colours displayed on monitors. This result from consumers' expectation indicated that fruit and vegetables should be presented in green environment. The results from this study could be of great benefits for marketing to present a colour combination of packages and fruit as well as vegetables for promoting the sale through the Internet.

#### 4. CONCLUSIONS

The green package made the best colour combination of packages and products that resulted in creating the customer preference of fresh-cut fruit and vegetables. The modern monitor, LED, gives better result for preference than others. Consumers' preference also led to the final purchasing decision.

#### ACKNOWLEDGEMENTS

The authors would like to thank students and officials that took part in the experiment. We would also like to thank the Faculty of Mass Communication, Faculty of Agricultural Technology, Rajamangala University of Technology Thanyaburi, Thailand for their support on our research and travel expense for the conference.

#### REFERENCES

- Arce-Lopera, C., T. Masuda, A. Kimura, Y. Wada and K. Okajima, 2013. Luminance distribution as a determinant for visual freshness perception: Evidence from image analysis of a cabbage leaf. *Food quality and preference*. 27. 202-207.
- Gonzalez-Aguilar, G.A., A.A. Kader, J.K. Brecht and P.M.A. Toivonen, 2011. Fresh-cut tropical and subtropical fruit products. In *Postharvest biology and technology of tropical and subtropical fruits*. Volume 1: Fundamental issues: 381-428.
- Ngo, M.K., B. Piqueras-Fiszman and C. Spence, 2012. On the colour and shape of till and sparkling water: Insights from online and laboratory-based testing. *Food Quality and Preference* 24: 260-268.
- Quijano, A., and S. Kadamani, 2012. Prototyping experiences with food colour. In *AIC 2012 In Color We Live: Color and Environment*, Proceedings, Taipei, 108-111.

*Address: Pratoomtong Trirat, Faculty of Mass Communication Technology,  
Rajamangala University of Technology Thanyaburi, Rungsit-Nakornnayok Rd,  
Thanyaburi, Pathumthane, 12110, Thailand.  
E-mail: pratoomtong\_t@hotmail.com*



# Effect of plate color on visual palatability of food dishes

Shino OKUDA,<sup>1</sup> Katsunori OKAJIMA<sup>2</sup>

<sup>1</sup> Faculty of Life and Science, Doshisha Women's College of Liberal Arts

<sup>2</sup> Faculty of Environment and Information Sciences, Yokohama National University

## ABSTRACT

Visual palatability of food dishes is influenced by many factors, such as the color of food, the material of the plate, the table coordination, the lighting condition and so on. To reveal the effect of plate color on visual palatability of food dishes, we conducted a subjective experiment by modifying the color of the plate rim with image processing. We prepared 4 kinds of food dishes, and acquired the chromaticity values of these dishes on a white plate with a rim under the standard illuminant D65. The rim color was replaced with one of 17 target colors. Participants evaluated the “visual palatability” of the modified images of the food dishes according to a categorical scale, and evaluated the image using a semantic differential method. As a result, it was revealed that visual palatability was higher on the plates with yellow-red rims, and lower on the plates with blue and blue-green rims. Also it was shown that visual palatability of the lettuce salad on the plates with the red rim was lower than that of the other dishes on the same plate. In conclusion, the plate color significantly affects the visual palatability of food dishes.

## 1. INTRODUCTION

Visual taste, palatability or pleasantness of food dishes are influenced by many factors, such as the color of food, the color and material of the plate or cutlery, the table coordination, the lighting condition, and so on (Spence et al. 2012).

It has been reported that cutlery coated with different materials really does influence taste significantly, and that these differences on the perception of the taste and pleasantness of food were large (Fizman et al. 2012). It was also reported that the atmosphere in dinner was affected by color. According to the results of experiments that changing the color of the food trays, pastel colors influenced positively for activity and relaxation whereas blue was associated negatively for activity (Tomita et al. 2010). In a study of an experimental restaurant opened to the public, an atmosphere of “Red and Black” was associated with stress, and an atmosphere of “Blue and White” was associated with relaxation (Jacquier and Giboreau 2012). In addition, we showed that color appearance is the most important factor in the estimation of “visual taste” according to the results of a subjective experiment under some light sources (Okuda et al. 2011).

This study aims at finding the effect of plate color on visual palatability of food dishes. We conducted a subjective experiment on the visual palatability of food dishes by modifying the color (only the chromaticity) of the plate rim with image processing. In the present color conversion, luminance values of all pixels in the rim were kept intact. Therefore, the shading of the rim after color conversion was still natural and no one noticed any artificiality in the modified images.

## 2. METHOD

### 2.1 Sample Preparation

First, we prepared 4 kinds of food dishes, a hamburger steak with sautéed carrots and kidney beans, a lettuce salad with onions, red bell peppers and yellow bell peppers, a bread roll, and a cream puff. Next, we acquired the chromaticity values of these dishes on a white plate with a rim using a 2D colorimeter (UA-1000:Topcon) under the standard illuminant D65. And then, we replaced the original rim color with one of 17 target colors as shown in Table 1. The modified images were presented on a calibrated LCD monitor (CG245:EIZO), some of the images are shown in Figure 1. This color management process ensures that the digital images can be displayed with the same chromaticity values as the real food and the target rim color.

Table 1: Chromaticity values of rim color.

No.	Color	L*	a*	b*	C	h(°)
1	Yellow	70.0	0.0	20.0	20.0	90
2	Yellow-Red	70.0	14.1	14.1	20.0	45
3	Red	70.0	20.0	0.0	20.0	0
4	Red-Blue	70.0	14.1	-14.1	20.0	-45
5	Blue	70.0	0.0	-20.0	20.0	-90
6	Blue-Green	70.0	-14.1	-14.1	20.0	-135
7	Green	70.0	-20.0	0.0	20.0	180
8	Green-Yellow	70.0	-14.1	14.1	20.0	135
9	Yellow	70.0	0.0	30.0	30.0	90
10	Yellow-Red	70.0	21.2	21.2	30.0	45
11	Red	70.0	30.0	0.0	30.0	0
12	Red-Blue	70.0	21.2	-21.2	30.0	-45
13	Blue	70.0	0.0	-30.0	30.0	-90
14	Blue-Green	70.0	-21.2	-21.2	30.0	-135
15	Green	70.0	-30.0	0.0	30.0	180
16	Green-Yellow	70.0	-21.2	21.2	30.0	135
17	Neutral	70.0	0.0	0.0	—	—



Figure 1: Modified images of food dishes used in this experiment.

### 2.2 Experimental procedure

Twenty participants evaluated the visual palatability of images of the food dishes according to a 7-step numerical scale, from -3 (bad) to +3 (good). Subsequently, they evaluated their impressions using a semantic differential method with twelve pairs of adjective antonym. Participants were all female and in their twenties.

### 3. RESULTS AND DISCUSSION

#### 3.1 Visual palatability

Figure 2 shows the average results of visual palatability evaluation for the 4 kinds of dishes on the plate with each rim color. It was revealed that high and low saturated yellow-red rims were evaluated as a favorable color but high saturated blue and red-blue rims as well as grey (neutral) were evaluated as an unfavorable color in all dishes. It was also shown that high and low saturated yellow rims were evaluated as a favorable color in 3 kinds of dishes except salad. Additionally, high saturated red was negative in palatability for the salad.

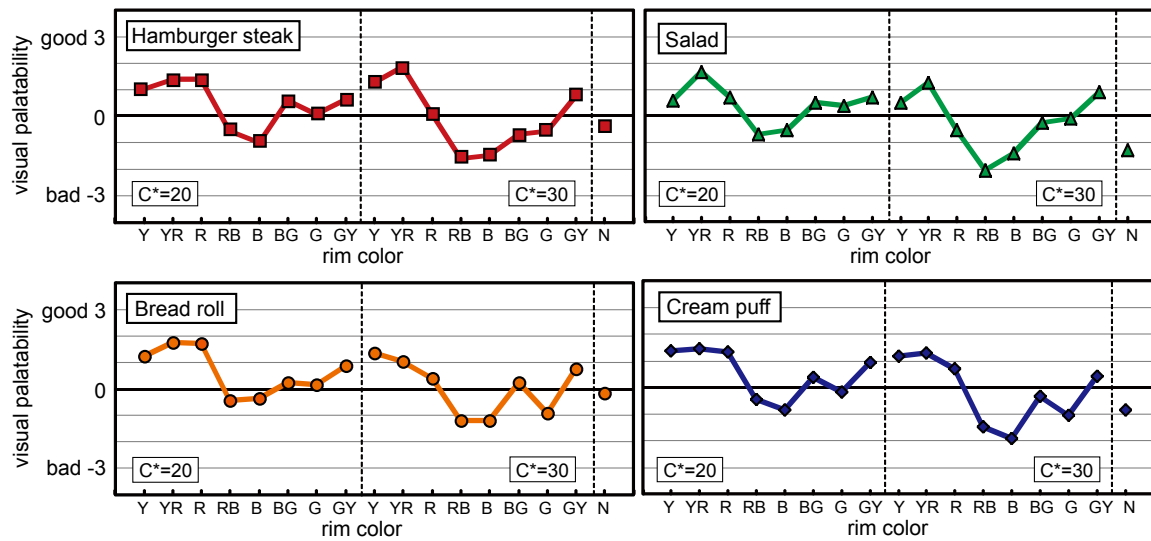

Figure 2: Evaluation results of visual palatability.

Table 2: Results of factor analysis on impression evaluation (Hamburger steak).

12 pairs of adjective antonym	component			communality
	familiarity	activity	freshness	
ordinary-extraordinary	.863	.201	-.035	.787
familiar-unfamiliar	.861	.313	.061	.843
natural-artificial	.815	.036	-.035	.667
common-distinct	-.753	.081	.166	.602
healthy-unhealthy	.717	.436	.050	.706
refined-unrefined	.689	-.049	-.031	.479
unstrained-strained	.511	.482	.039	.495
cheerful-gloomy	.210	.817	.213	.757
warm-cool	.292	.785	-.342	.820
dynamic-static	.061	.888	-.038	.793
childish-mature	.336	-.574	-.243	.502
juicy-dry	-.020	.041	.750	.564
contribution ratio(%)	35.128	24.786	6.870	
cumulative contribution ratio(%)	35.128	59.913	66.784	

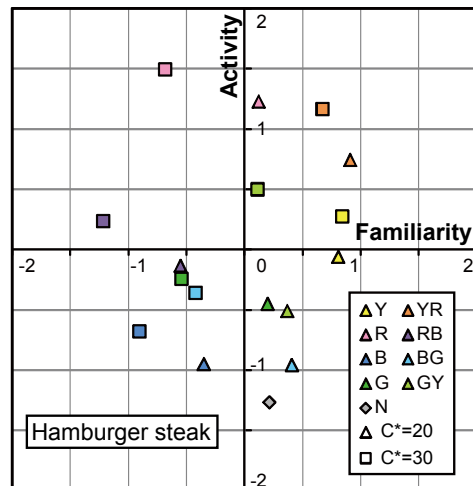

Figure 3: Factor scores acquired from results of factor analysis.

### 3.2 Impression evaluation

We conducted the factor analysis on the results of impression evaluation by using IBM SPSS Statistics 20.0, with principal component method and varimax rotation. We extracted three components, and named first component “Familiarity”, second component “Activity” and third component “Freshness”. Table 2 shows the results of factor analysis and Figure 3 illustrates the factor scores in the case of hamburger steak. The scores of high and low saturation yellow-red were high in both “Familiarity” and “Activity” whereas the scores of high saturation blue were low in both “Familiarity” and “Activity”. The scores of high and low saturation yellow were high in “Familiarity” whereas that of high saturation red-blue was low in “Familiarity”. Therefore, it is suggested that the color with the impression of familiarity and activity may promote the palatability of the dishes.

### 4. CONCLUSIONS

Yellow and yellow-red colors can make the dishes more palatable, but blue and red-blue colors make the dishes less palatable. High saturation red color is relatively favorable for the palatability of the dishes, but is not so favorable for salad including greens.

### ACKNOWLEDGEMENTS

This study was supported by Research Grants in Doshisha Women’s College of Liberal Arts, 2012. We would like to thank Kana Murayama, an undergraduate student in D.W.C.L.A. for helping our experiment, and thank Junya Ueda, an undergraduate student in Y.N.U. for modifying the digital image of the dishes.

### REFERENCES

- Fiszman, B.P., Z. Laughlin, M. Miodownik and C. Spence 2012. Tasting spoons: Assessing how the material of a spoon affects the taste of the food. *Food Quality and Preference* 24. 24-29.
- Jacquier, C. and A. Giboreau 2012. Perception and Emotions of colored atmospheres at the restaurant. *Proceedings of the 3rd International Conference on Appearance* #18.
- Okuda, S., Y. Fukumoto, K. Okajima and C.A. Lopera 2011. Effects of light on food appearance in color, glossiness, and visual texture. *Proceedings of the Midterm Meeting of the International Colour Association*, 629-632.
- Spence, C., V. Harrar and B.P. Fiszman 2012. Assessing the impact of the tableware and other contextual variables on multisensory flavour perception. *Flavour* 1:7.
- Tomita, K., T. Aiba, J. Kang, M. Matsui and K. Ohtani 2010. Psychological effects of the tray-color for meal on diners - comparison between young persons and elderly persons. *Proceedings of the Interim Meeting of the International Colour Association*, 386-389.

*Address: Associate Professor. Shino Okuda, Faculty of Life and Science,  
Doshisha Women’s College of Liberal Arts  
602, Genbu-cho, Kamigyo-ku, Kyoto, 602-0893, JAPAN  
E-mails: sokuda@dwc.doshisha.ac.jp, okajima@ynu.ac.jp*

# Banana Ripening: Ethylene and Chill Effects on Colour

Wei Ji,<sup>1</sup> Mahmood AKHTAR,<sup>2</sup> Georgios KOUTSIDIS,<sup>3</sup> M Ronnier LUO,<sup>4</sup>  
John HUTCHINGS,<sup>4</sup> Francisco MEGIAS,<sup>5</sup> Mick BUTTERWORTH<sup>6</sup>

<sup>1</sup> now of the College of Physics & Electronic Information Engineering,  
Wenzhou University, Wenzhou, PR China

<sup>2</sup> School of Food Science and Nutrition, University of Leeds, Leeds, UK

<sup>3</sup> School of Life Sciences, Northumbria University, Newcastle upon Tyne, UK

<sup>4</sup> School of Design, University of Leeds, Leeds, UK

<sup>5</sup> now of the Wm Morrison Supermarkets Plc, Bradford, UK

<sup>6</sup> VeriVide Limited, Enderby, Leicester, UK

## ABSTRACT

In another paper (Ji, et al., 2013) to be published in this conference, the authors studied banana ripening using different assessment technologies including colour imaging, physical, and sensory. The present paper reports the use of robust technology based on colour imaging to investigate different conditions applied to banana ripening with different storage treatments. The conditions included are the introduction of ethylene gas as a ripening catalyst, and the effect of chilling prior to storage. Altogether, four conditions were studied. The results showed that the colour imaging technology successfully quantified banana ripeness. It was found that ethylene treatment had a great effect in accelerating the process of ripening, indicated by a more rapid colour change. The chilling treatment, however, slowed down the ripening process of the samples even after treatment with ethylene, but the effect of ethylene addition still can be distinguished. The digital imaging methods can be used for detailed colour analysis of the banana.

## 1. INTRODUCTION

Appearance of fresh produce is one of the main parameters affecting purchasing and consumer choice (Hutchings, 1999). The fresh produce industry is currently employing a range of tools to assess quality as well as the ripening stage of fruits. One of the proposed tools is to use digital imaging method to assess the ripening stage. The method can provide digital readings to indicate the visually perceived quality of fruit. In this research, digital imaging method was used to assess banana ripening under a number of banana storage conditions. The aim of the research was to verify that the digital imaging method can be used for banana ripeness assessment under a wide range of storage conditions.

## 2. METHOD

Two batches of unripe bananas (ASDA Colour 1, two carton boxes, each containing 18 hands) were supplied in two consecutive weeks. In one box of each batch the bananas had been triggered by  $100 \text{ mL} \cdot \text{L}^{-1}$  ethylene for 3 hours. From each condition of each batch, 18 hands each having 5 or 6 fingers were selected. From the 18 hands, two were used for non-destructive imaging testing through an 8 day period. The other 16 hands (2 for each day) were used for destructive testing (Brix, texture and acidity). The outer three fingers of each hand were used for these tests.

There were two storage conditions. The first batch of samples were stored directly at  $16^\circ\text{C}$  using two incubators. The second batch of samples were first chilled at  $5^\circ\text{C}$  for 24 hours

before storage at 16°C in two incubators. All samples were placed in polypropylene boxes. Each box contained a pair of hands. The boxes were not sealed to avoid controlled atmosphere effect in each of the incubators. For each condition, 9 boxes of hands were kept in the same incubator, 16 hands for destructive tests and 2 hands for non-destructive imaging tests.

The measurements were carried out for 8 days continuously for each batch. On each day, one box with 2 hands was removed for imaging. The outer three fingers from each hand were detached for imaging, then for texture, brix and acidity measurements. These were destructive tests and no samples were returned to the incubators. However, the bananas for imaging were brought out each day and return after imaging process, i.e. non-destructive test. Images were captured of all banana hands and detached fingers using a lighting cabinet with a D65 fluorescent lamp simulator and a Nikon® D80 digital camera (Ji et al, 2012). In Batch II, after the same 8 day experiments, the imaging process was continued for another 6 days (for 2 days over the weekend there was no access to the testing facility) until the majority area of the banana skin had turned black.

Banana firmness (texture) was measured using a texture analyzer TAXT2i (Exponent Stable Microsystems, U.K.) fitted with a 5 kg force sensor and connected to a data acquisition system. Sugars were measured using a Quick-Brix 90 digital refractometer (Mettler-Toledo AG, Schwerzenbach, Switzerland) and acidity was determined using an autotitrator, Titration Excellence T50 (Mettler-Toledo AG, Schwerzenbach, Switzerland).

In image analysis, each banana image was segmented for a better understanding of the results on spatial colour changes. Firstly the edge of a banana finger was detected. The separating points were then automatically defined according to the number of segments required. In this work 16 segmentations were used. At each point, a perpendicular line to the edge was drawn and the banana section falling into that area was segmented. Similarly, the banana hand image segmentation was carried out using 16 equal divisions.

### 3. RESULTS AND DISCUSSION

Figure 1 and Figure 2 show the effects of ripening on brix and acidity values. As the banana ripens, brix values increase indicating the increased conversion of starch to sugar content. The sugar content of ethylene-treated banana (Batch 1, Hand 1) increases considerably after 3 days storage. The measured sugar contents were found to be low for Batch 2 (i.e. chilled banana) with ethylene and non-ethylene treatment. This indicated that the chilling injury had delayed the ripening process. Figure 2 shows that the acidity also changed but the effects of ethylene were not as clear as that with brix. The acidity values for non-ethylene treated bananas were found to be lower than the ethylene treated samples. As the non-treated banana samples were difficult to dissolve in the distilled water for acidity measurement and this resulted in lower values for measured acidity. No significant change in the acidity was observed for both batch 1 and 2 over a storage period of 8 days. Figure 3 contains results of the mechanical texture values calculated in terms of maximum force against ripening days. They all show similar trends, i.e. the riper the banana fruit, the more soft the flesh. The breaking force of ethylene treated banana decreases significantly over storage time. The texture of the banana samples becomes softer due to the ripening process triggered by ethylene at 16 °C storage. The results also show that ethylene treated bananas, Batch 2 – Hand 1, ripen slowly due to the chilling injury.

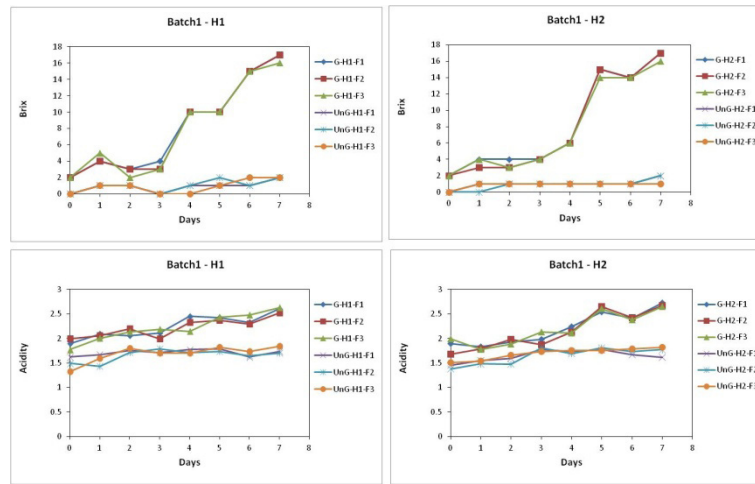

Figure 1. Brix values plotted as functions of days in the ripening process.

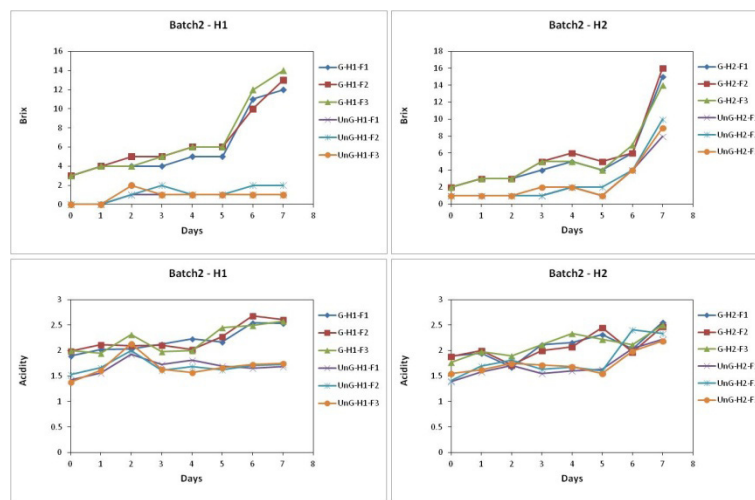

Figure 2. Acidity values plotted as functions of days in the ripening process.

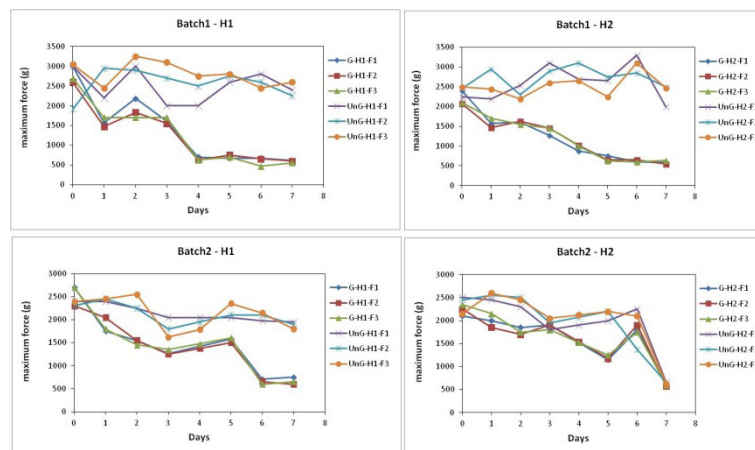

Figure 3. Texture values calculated in terms of maximum force plotted as functions of days in the ripening process.

The colour information is shown in Figures 4 and 5. For each finger, colour information of Sections 7-8 was averaged for the finger. For each of the two hands, the colours of the 3 fingers in each hand were also averaged. The resulting lightness, colourfulness and hue are plotted in Figure 4 for Hand 1 and Figure 5 for Hand 2. The two figures demonstrate that ethylene treated bananas had fast increments in lightness and chroma as the hue changed

from green to yellow. When chill treated, the whole ripening process slowed compared to the non-chill samples, with or without ethylene. In conclusion, the banana samples can be distinguished by colour information of lightness, colourfulness and hue among all ethylene treated samples and chilled samples.

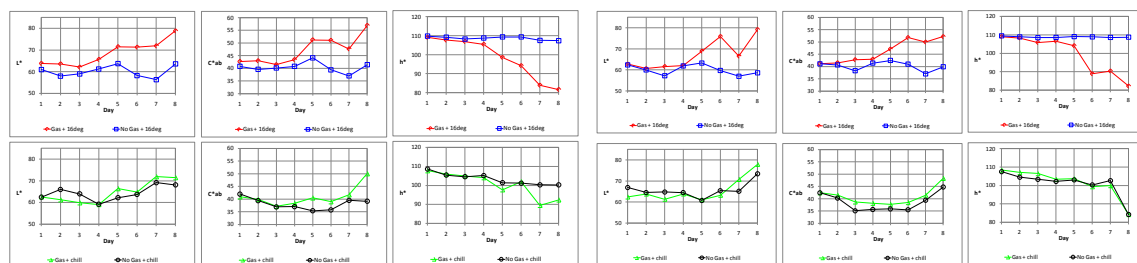

Figure 4. The lightness, colourfulness and hue vs. days of Hand 1 (avg. of 3 fingers) at the middle sections (Sections 7 – 9).

Figure 5. The lightness, colourfulness and hue vs. days of Hand 2 (avg. of 3 fingers) at the middle sections (Sections 7 – 9).

#### 4. CONCLUSIONS

In summary, ethylene treatment effects can clearly be seen in terms of the imaging, texture, brix and acidity measurements. It is evident that added value brought to this area of post harvest science by imaging science will be in at least two forms. These are first, by detailed examination of ripening patterns both along the banana and in the hand, and second by the ability to detect chill damage. Conclusions are that significant differences in temporal and spatial colour changes and blemishes in banana can be objectively mapped. Hence it may become possible to achieve pre-symptomatic visualization of disease. Thus the method will lead to the reduction of waste, and the possibility for the development of automatic ‘rejection’ systems.

#### REFERENCES

- Ji, W., M. Akhtar, G. Koutsidis, M.R. Luo, J.B. Hutchings, F. Megias, and M. Butterworth, 2013, Banana Ripening: Colour, Physical and Sensory Changes, *Proceedings of 12th International Congress of the AIC*, Newcastle, UK.
- Hutchings, J.B., 1999. *Food colour and appearance*, 2nd edition. USA: Aspen Publishers..
- Ji, W., M.R. Luo, and J.B. Hutchings, 2010. Measuring Banana Appearance Aspects Using Spectrophotometer and Digital Camera, *Proceedings of the Color and Food, Interim Meeting of the International Color Association (AIC)*, 401-404, Mar del Plata, Argentina.
- Ji, W., G. Koutsidis, M.R. Luo, J.B. Hutchings, M. Akhtar, F. Megias, and M. Butterworth, 2012. Digital Method for Measuring Banana Ripeness, *Color Research and Application*, Article first published online: 14 APR 2012, DOI: 10.1002/col.21741.

Address: Dr. Wei Ji,  
the College of Physics & Electronic Information Engineering, Wenzhou University,  
Chashan University district, Wenzhou City, Zhejiang Province, PR China, 325035  
E-mail: wji@wzu.edu.cn



# Study on How Different Indoor Colors Influence Human Body: Focus on Munsell Color Wheel B Line

Ji-seon RYU,<sup>1</sup> Hanna KIM,<sup>2</sup> Eun-ji SEO,<sup>3</sup> Jin-Sook LEE<sup>4</sup>

<sup>1</sup> Doctor Course, Dept. Architectural Engineering, Chungnam National University, Korea

<sup>2</sup> Doctor Course, Dept. Architectural Engineering, Chungnam National University, Korea

<sup>3</sup> Master Course, Dept. Architectural Engineering, Chungnam National University, Korea

<sup>4</sup> Professor, Dept. Architectural Engineering, Chungnam National University, Korea

## ABSTRACT

In order to explore the effects of colors on physiological and emotional reactions of humans by changing the brightness and chroma, using the B line of Munsell Color System that boosts concentration, this study measured the fluctuation in brain waves of humans using 7.5B line of Munsell Color System, as a basis of this study. During the experiment on the subjects, their brain waves were recorded to analyze the occurrence of concentration-related Sensory motor Rhythm and Mid beta waves and relaxation-related Alpha waves. The results showed that higher brightness and chroma led to higher level of concentration, and lower brightness and chroma led to relaxation. Such finding will be useful as a critical basic data for planning human-friendly environmental designs in a scientific and systematic manner in future interior space color planning and helpful for color arrangement.

## 1. INTRODUCTION

Colors are closely related to our lives with a huge impact in all kinds of areas. Therefore, continuous efforts to make our environment more pleasant through colors have been made. Thus, it is critical to conduct an in-depth research on human-friendly color planning in more scientific and systematic manner than ever before. Such view can be supported by brain wave-oriented color research. Our brains control the emotional reactions to physiological responses, and brain waves can be seen as measurement index reflecting such physiological and psychological functions of the brain. It allows for interpretation of emotions through figures or charts, based on brain waves that occur in response to tension or relaxation of memory stimulation. Exploring the effects on physiological and emotional reactions by measuring the effects of colors on human brains with stimulation to the area of brain that can be scientifically measured is a very useful method, as a scientific verification of color effects on humans. However, since many studies tend to analyze brain waves using particular colors which are then applied to particular physical and mental areas, the types and number of colors for research are irregular and limited. As a result, it has been problematic to generalize and quantify the physiological and emotional reactions to colors due to failure to analyze the brain waves that occur in response to colors in various ways. Therefore, this study is intended to explore the effects of colors on physiological and emotional reactions by changing the brain waves for systematic and quantitative collection of data for follow-up studies. Brain waves are generally classified by frequency and the types and characteristics are shown Table 1.

Table 1: Types and characteristics of brain waves.

Brain waves	Phase	Frequency (Hz)	stat of consciousness
$\delta$	$\uparrow$	0.1 – 3	Deep sleep, abnormal, brain condition
$\theta$	Slow	4 – 7	sleep
$\alpha$		8 – 12	relax or rest
Low $\beta$	fast	16 – 20	concentration and activity
High $\beta$	$\downarrow$	21 – 30	tension, anxiety, and stress

## 2. METHOD

For accurate results of this study, 14 male and female adults in their 20s and 30s were selected as subjects who are physically and mentally healthy with no brain, mental, eye diseases, color weakness, color blindness and usually normal blood pressure. The experiment was done with CG containing children’s rooms for resting and studying and original control group and experimental group with a total of four steps by changing the level of brightness and chroma, as shown in Figure 1.



Figure 1: Evaluation.

For experiment environment and measurement equipment connection to obtain brain waves, the ceiling, floor and four walls that are 4m long and 3.5m tall were all painted white, as shown in Figure 2, and the light was turned off during the experiment. The measurement equipment was attached to a total of 8 areas of the brain surface of the subjects in accordance with unipolar induction method and 10/20 international electrode system equally on the left and right sides of Fp1, Fp1, Fp2, F3, F4, T3, T4, P3, P4. The reference electrode was attached behind the right earlobe and the grounding electrode was attached behind the left earlobe. For measurement of brain waves, the external noise of lab was minimized and smoking or drinking caffeine and carbonated beverages was prohibited 8 hours prior to the experiment to obtain accurate results. The experiment was conducted in the following order. Each subject sat on a chair located 1m away from the wall in a comfortable position. Then they looked at the screen after the light was turned off and their



Figure 2: Before and during the experiment

brain waves were measured for a minute for each evaluation object. After that, they took a break while the monitor was turned off for 30 seconds for compliance and the next evaluation object was measured for a minute. After taking all the five steps in such manner, the brain waves in response to color stimuli were measured. The measured brain wave signals were converted into sampling frequency of 256 Hz, pass filter of 3.5~50Hz, and 12bit AD to be stored into computer and relative power was analyzed. . In particular, the brain wave proportion of 12~20 Hz area among the collected areas of 3.5~50Hz was observed, which are Sensory motor Rhythm (SMR, 12~15 Hz) and Mid beta waves(15~20 Hz) that are

known to occur when focusing on work or studying. During the analysis of final results, Ch3 and Ch4 values for frontal lobe were primarily used.

### 3. RESEARCH RESULTS AND ANALYSIS

#### 3.1 Results on Concentration Level Measurement

Whether or not the changes in brightness and chroma of colors affect the concentration level was examined through EEG activity, as shown in Figure 3. It shows the results on wavelength areas of SMR and Mid Meta waves extracted for analysis of concentration level, among the collected brain waves. When the brightness and chroma were both high, the subjects showed the highest concentration-related brain wave values. (Ch3 : 2.35, Ch4 : 2.49) On the other hand, the original evaluation objects showed the lowest level of concentration (Ch3 : 2.27, Ch4 : 2.40).

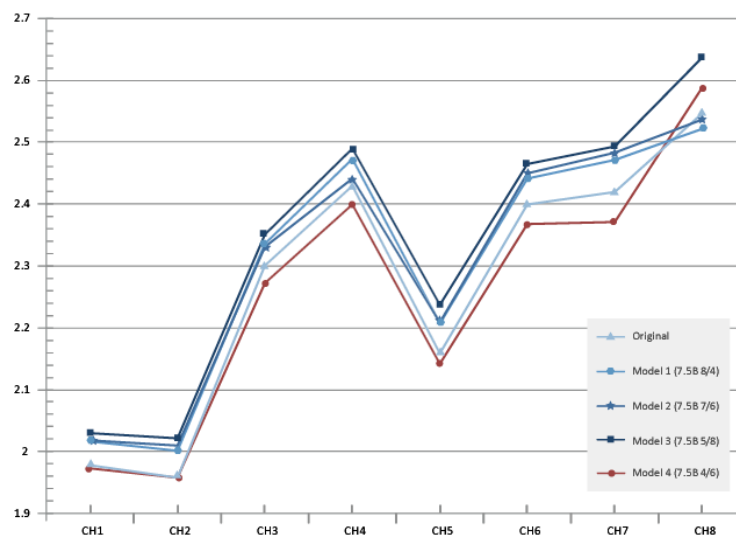

Figure 3: Results on Concentration Level Measurement.

#### 3.2 Results on Relaxation Level Measurement

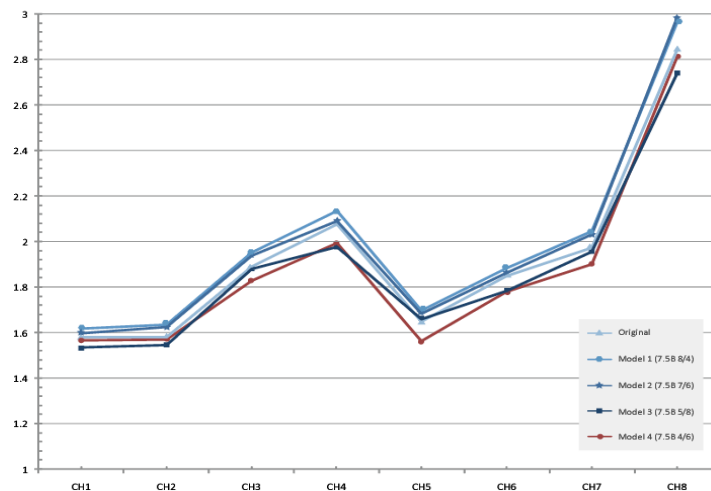

Figure 4: Results on Relaxation Level Measurement.

Whether or not the changes in brightness and chroma of colors affect the concentration level was examined through EEG activity, as shown in Figure 4. It shows the results on wavelength areas of SMR and Mid Meta waves extracted for analysis of concentration level, among the collected brain waves. When the brightness and chroma were both high, the subjects showed the highest concentration-related brain wave values (Ch3 : 2.35, Ch4 : 2.49). On the other hand, the original evaluation objects showed the lowest level of concentration (Ch3 : 2.27, Ch4 : 2.40).

#### 4. CONCLUSIONS

In order to explore the effects of colors on physiological and emotional reactions of humans by changing the brightness and chroma, using the B line of Munsell Color System that boosts concentration, this study measured the fluctuation in brain waves of humans using 7.5B line of Munsell Color System, as a basis of this study. The study revealed that B line shades that boost concentration with high brightness and chroma could be used for spaces related to studying and education, such as study room of children or adults. Since even a small amount of colors can lead to substantial overall color stimuli, adjustment of tones including brightness and chroma is more important than adjustment of colors. Therefore, this study can serve not only as a guide to color characteristics, but it suggests quantitative colors can be effectively utilized through scientific and systematic analysis method, based on measurement of brain waves. Follow-up studies will be conducted based on this research.

#### ACKNOWLEDGEMENTS

This work was supported by the National Research Foundation of Korea (NRF) grant funded by the Korea government (MSIP) (No. 2008-0061908).

#### REFERENCES

- Ju-yeon Kim et al., 2009. A Study on Interior Wall Color based on Measurement of Emotional Responses, *Korean Journal of the Science of Emotion & Sensibility*.
- Byoung-Kyong Min, 2009. Spectral analysis of brain oscillatory activity, *Korean Journal of Cognitive Science*.

*Address: Jiseon RYU, Dept. of Architectural Engineering,  
Chungnam National University 220 Gung-dong, Yuseong-gu, Daejeon, Korea  
E-mails: woman602@hanmail.net, js\_lee@cnu.ac.kr*

# Study of Chromatic Variables in Long-stay Spaces for the Elderly

Ana TORRES, Jorge LLOPIS, Juan SERRA, Ángela GARCÍA  
Colour Research Group, Institute of Heritage Restoration,  
Universitat Politècnica de València, Spain

## ABSTRACT

Social concern about the aging population in recent years has allowed architects and designers to work on new models for housing, living units or hospitals facilities, not only to facilitate the accessibility and remove architectural barriers, but to create spaces with more sustainable design innovations. This contribution deals with the analysis and study of the chromatic possibilities in geriatric architectures, with spaces specifically designed for the elderly. The aim is to reflect on the color design possibilities that help to ensure the improvement and welfare of the elderly according to studies related to dependence and quality of life, as well as the special characteristics of these types of architectural spaces, whose variables are not exactly those of the hospitals. The color should interact with the activities to be developed in these places in order to make them more livable.

## 1. ANALYSIS OF THE PROBLEM

The determination of the characteristics of the new accommodations that will fulfill the well-being and comfort of the elderly is one of the objectives of every residential model built, and the consideration of colour and light has been essential to achieve various spatial effects. However, the designing recommendations about the use of colour and light in architectural spaces have not always been scientifically proven, or have not taken into account the three basic visual requirements of the aging population simultaneously: *physical*, *sensory* and *psychological* satisfaction. Clearly, there are contributions and applications on the dimensions of color in architecture and design (Swirnoff, 2003) or trials on the effects and influences of color *stimuli* onto subjects in confined spaces (Mikellides, 2009), as well as numerous evidence and studies assessing that color affects the mood (Birren, 1978), etc.

There are architectural design variables that have been scientifically noted to have positive impact on visual ergonomics or psychological feeling of comfort: adequate lighting (Boyce 1981) (Lillo 2000) or the need for some colour variation (Mahnke 1996). Shougon & Schumann (1993) demonstrate the existence of a link between stress and lighting design or a good building orientation (Ulrich 1984).

Most of these studies base their findings on user's satisfaction surveys, and when that is not possible, in other physical evidences. Also there have been different works on color and human activities in hospitals indoors (Dérivé, 1964), or some examples of colour interventions in medical spaces since the beginning of s. XX with the problems of inadequate colour notation (Cesar, 2008). Nowadays, there is some color therapy experience in the rehabilitation of buildings for the public, as in Denver's Hospital (Richmond, 2008). Although successful, these specific projects have been carried out by architects and not interdisciplinary teams.

The International Color Association (AIC) has the "Study Group on Color Perception of the Elderly (CSE)". Katsunori Okajima (2002) is the head researcher and stands out for

his research on the relevance of the color saturation in the perception of the elderly (Melgosa 2003), also the *Portuguese da Cor Associação* (1) conducts research related to the application of colour in hospital spaces. The *Colour Design Research Centre* at the *London Sothbank University*, is responsible for the most relevant study that has been developed in relation to colour, considering the opinion of the users of 22 hospitals in England. The results have been formalized in practical guidance that establishes general design recommendations for hospitals (Dalke, 2004), which involves the development of previous studies conducted by the *Chartered Institution of Building Services Engineers* (CIBSE, 1989). The study provides a number of general recommendations for a good practice in the design of hospital spaces, without focusing specifically on the problems of the elderly. In this regard, the study highlights the need to use only the color contrast as a relevant factor in the design, which has been further investigated by other authors (Bright & Cook, 1997). In any case, must be referenced evident differences among users of health centers and those residing in a senior center. These users will develop a long time stay, for an indefinite period, inside buildings that become their new home, and whose characteristics are not exactly those of hospitals.

Nowadays After long chromatic interventions in hospital architecture, there are many graphic and artistic creations based in health factors, which have been well accepted by users. In Spain, various foundations such as *La Caixa* (Albert 2003) or latest research programmes by *Caser Foundation*, have conducted a review of those architectural environments that produce welfare to people who requires support. This latest multidisciplinary work led by “architects, researchers and specialists from various countries, presents elderly accommodation typologies that are being built in their respective countries” (Diaz Veiga 2012).

But what are the chromatic factors to consider for these kinds of homes? What are the colour features needed in these rooms to achieve more livable environments? These questions are the starting point for our research, considering that the residential centers, as the Institute for the Elderly and Social Services in Spain (IMSERSO) points out, are establishments for the temporary or permanent housing, with services and intervention programs fitted with the needs of people receiving attention, and directed to achieving a better quality of life and the promotion of personal autonomy.

Given the population growth in recent years, in Spain for instance, there are 8,221,047 people 65 and older, representing 17.4% of the population. The average for the EU-27 is 17.5%. These data show the big amount of seniors who would like to live in comfortable place, according to their needs and dependency, in order to get habitability specifically tailored to their physical, sensory and psychological satisfaction. These places could improve their personal autonomy and independence in their environment, with the final goal to reach wellbeing. In this respect, it is an axiom proven the ability to influence the perception of space on the physical, sensory and emotional level, thanks to architectural colour treatments.

We have outlined the state of the art of those environments designed for long stay living, and with a permanent coexistence of elder people, but we would focus in the city of Valencia (Spain). Based on the spatial characteristics of usual senior center, we define designing criteria for the different functional spaces, such as: (1) common spaces (living areas, dining and cafes, rehabilitation room, Gyms, medical spaces); (2) spaces for articulations (reception areas, circulation and waiting, etc.); (3) private use spaces (bedroom, services, etc.). Thus, it is necessary to develop color treatment alternatives that improve the current conditions of habitability and comfort, and the color combinations possibilities are almost infinite, taking into account not only the type of activities that take place in these spaces, but also the study of the colour proportions in the interior housing space.

According to the typological identification of common spaces in a center for the elderly, it should be studied the subject's profile, his mood and physical wealth, the subjective dimensions of aging, the quality of life of each person, the emotional state, etc. (Prieto D et al. 2009). Some other aspects such as the processes of solitude, the passage of time (night and day); the wandering through the building; the link to the group, or lack of safety presented by certain movements which cause disorientation or fear of emptiness, and of course the fear of loneliness, death and all those episodes which are experienced in these residences. At the moment of a colour intervention, we would add other specific facts specifically related with perception and visual processes.

According to the typological identification of common spaces in a center for older people should act accordingly, studying the subject's profile, their mood and physical, meet the subjective dimensions of aging, such as activities performed at each place setting or (external or internal), the quality of life of each person, their emotional state (Prieto, D.; Etxeberría, I.; Galdona, E. Urdaneta, A. 2009) Processes of Solitude, the passage of time: night and day (wandering), the space, the link to the group or lack of safety presented by certain movements causing disorientation or fear of emptiness and of course the fear of loneliness, death and all those episodes life that is experienced in an environment where transits inhabited and experienced sensations. At the time of intervention chromatic adds studies of perception and visual processes that logically by aging reached. When an intervention proposal would add the properly identified vision and other perceptual psychology concepts.

## 2. METODOLOGY OF THE RESEARCH

The methodology proposed for the development of this study is a multidisciplinary approach, centered in the analysis of the needs of the elderly as a social group both from a scientific and a technician point of view. This is because the final architectural intervention, at the end, should improve the living of the elderly, providing the right environment, which is essential to fulfill their physical, sensory and psychological needs. From this starting premise, it has been designed an action plan according to the activities described below.

The final result expected is the physical realization of the most successful design alternatives selected, among the developed, for each of the common spaces in the centers for the elderly. These interventions will serve as a reference for both the adaptation of existing residential centers, and the designing of new ones.

As a final formalization of the results, it is expected to publish a designing guide, to help in the development of direct application proposals, based on the actual characteristics of the spaces currently used for this type of building, replacing the theoretical nature of much of the current studies on the topic discussed. Such a publication would include a guidance color chart to be considered in the design of residential spaces for the elderly, and compositional criteria to adequately characterize colored spaces for this segment of the population and respond to their physical, sensory and psychological needs.

Results may be disseminated in public and private entities related with seniors, which the objective of providing those agencies such intervention mechanisms for chromatic characterization of architectural spaces for the elderly, in order to get a habitability specifically tailored to their physical, sensory and psychological satisfaction, thus helping to improve the chances of personal autonomy and independence in their environment, with the ultimate aim of improving their wellbeing.

## REFERENCES

- Birren, F., 1978. *Color and Human Response*. New York: Van Nostrand Reinhold. p. 23.
- Boyce, P.R., 1981. *Human Factors in Lighting*. London: Applied Science.
- Bright, K., G. Cook and J. Harris, 1997. *Selection and visual impairment: a design guide for building refurbishment. (Project Rainbow)*. University of Reading, Departments of Construction Management and Engineering and Psychology. Np, Dulux Technical Group.
- Cesar, J.C. de O, 2008. Colour in hospital architecture and the work of Howard Kempt Professor. *Proceedings of the AIC Interim Meeting*, Stockholm, 56.
- Dalke, H., P.J. Littlefair and D.L. Loe, 2004. *Lighting and Colour for Hospital Design*. London: TSO, 91.
- Déribéré, M., 1964. *El color en las actividades humanas*. Tecnos.
- Diaz Veiga, P., and M. Sancho, 2012 *Unidades de Convivencia. Alojamientos para personas mayores para "vivir como en casa"* Madrid: Informes Portal Mayores, 132.
- Albert, L., 2003. *Guia de Arquitectura. Adaptación y habilitación de viviendas para personas con alzheimer y deficiencias de movilidad*. Barcelona: La Caixa, Departamento de proyectos sociales y asistenciales, 49.
- Lillo, J., 2000. *Ergonomía: evaluación y diseño del entorno visual*. Madrid: Alianza.
- Mahnke, F.H., 1996. *Color, Environment, and Human Response: An Interdisciplinary Understanding of Color and its use as a Beneficial Element in the Design of the Architectural Environment*. New York; London: Van Nostrand Reinhold; Chapman & Hall distributor.
- Porter, T., and B. Mikellides, 2009. *Colour for Architecture today*. Oxford: Taylor & Francis.
- Prieto, D., I. Etxeberria, E. Galdona and A. Urdaneta, 2009. *Las dimensiones subjetivas del envejecimiento*. Madrid: Fundación Ingema, Colección Estudios.
- Shogun, M.G., and L.L. Schumann, 1993. The effect of environmental lighting on the oxygen saturation of pre-term infants in the NICU. *Neonatal Network*, 12(5), 7-13.
- Swirnoff, L., 2003. *Dimensional Color*. New York: W.W. Norton.
- Ulrich, R.S., 1984. *View from the window may influence recovery from surgery*. *Science*, 224, 420-421.

*Address: Prof. Ana Torres, Dep. Architectural Graphic Expression,  
School of Architecture, Polytechnic University of Valencia,  
Camino de vera s/n. 46019 - Valencia (Spain)  
E-mails: atorresb@ega.upv.es, jllopi@ega.upv.es,  
juaserl@ega.upv.es, angarcia@ega.upv.es*



# Preferable Color of Wall and Lighting in Dining Room for Migrainers

Akari KAGIMOTO,<sup>1</sup> Shino OKUDA<sup>2</sup>

<sup>1</sup> Graduate School, Doshisha Women's College, Japan

<sup>2</sup> Doshisha Women's College of Liberal Arts, Japan

## ABSTRACT

This study aims to reveal the preferable color of wall and lighting in a dining room for migrainers. We conducted an experiment on subjective evaluations in a dining room with a kitchen with changing color of wall and correlated color temperature (CCT) of lighting. Subjects evaluated "Preference" and "Impression" of a dining room. As a result, migrainers prefer a dining room where wall color in both dining and kitchen space were yellow (5Y9/4) under all lighting conditions. It was also shown that migrainers tended to prefer the dining room where the light color was low CCT when wall color in both space was white (N9.25). Additionally, impression of a dining room between migrainers and non-migrainers was different.

## 1. INTRODUCTION

About 20% of women ranging from twenty to forty years old have migraine (Sakai et al. 1997) and about 40% of migrainers have migraine headache triggered by light stimulation (Kelman 2007). In our past research, we reported that migrainers prefer low illuminance and low color temperature when they relax in a dining room (Kagimoto et al. 2012).

Generally, impression and preference of a room are influenced by color and material of wall and floor, lighting conditions, and so on. According to the studies on the evaluation of the material in houses, the floor materials in houses gave different impression, that woody flooring materials and Japanese traditional flooring material-tatami gave the comfortable impression, and that cork materials gave luxury impression (Inagaki et al. 2008). Also, it was reported that dominant hue has a significant impact on emotion, especially yellow and orange colored models made high pleasure ratings (Hirschmuller et al. 2008).

The purpose of this study is to reveal the preferable color of wall and lighting conditions in a dining room for migrainers. We conducted an experiment with subjective evaluation which combined wall color and CCT of lighting in each space of dining and kitchen.

## 2. METHOD

### 2.1 Experimental conditions

Figure 1 illustrates a plan of the experimental apparatus. We made 1/4 scale model of a dining room with a kitchen where dining and kitchen space was divided by a kitchen counter. The model size was 740mm (width) × 1440mm (depth) × 542mm (height). It was furnished with a dining table, four chairs, a sink cabinet, and a cupboard hanged from a ceiling above a kitchen counter as shown in Figure 2. All walls could be exchanged, we set two wall colors, white (N9.25) and yellow (5Y9/4) in each space of dining room.

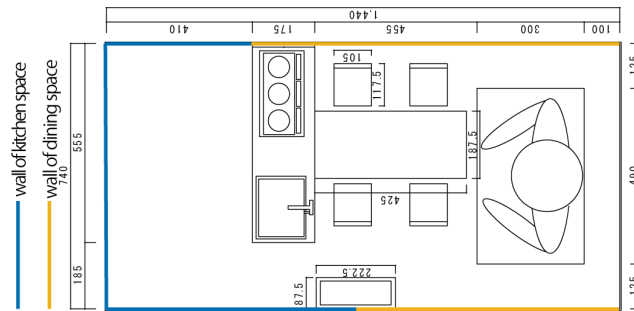

Figure 1: Plan of experimental apparatus.



a) yellow wall, 3000K with cupboard



b) white wall, 5000K no cupboard

Figure 2: Picture of experimental apparatus.

Two kinds of fluorescent lamp, 3000K and 5000K were equipped on the ceiling as ambient lighting, and horizontal illuminance on the table was 300lx. We created 18 conditions in combination with wall colors and CCT of lighting in each space as shown in Table 1. Subjects responded “Preference of a dining room”, “Preference of a kitchen” and “Preference of a dining room with kitchen” according to 6 steps verbal evaluation scales. They also evaluated “Impression of a dining room”, kitchen and dining room with kitchen using semantic differential method with 18 pairs of adjective antonym as shown in Table 2.

Table 1: Experimental conditions

wall color		light color	
Dining	Kitchen	Dining	Kitchen
Yellow	Yellow	3000K	3000K
Yellow	White	3000K	5000K
White	White	5000K	5000K

with cupboard / no cupboard

Table 2: Impression items.

elegant — vulgar	dyanmic — static
familiar — unfamiliar	soft — hard
natural — unnatural	lively — dull
calm — nervous	conspicuous — inconspicuous
luxury — unluxury	obvious — vague
united — ununited	modern — antique
light — heavy	new — old
open — closed	flashy — quiet
warm — cool	individual — ordinary

## 2.2 Subjects

Subjects were twenty females in their twenties. Half of the subjects were migrainers and the other half were non-migrainers.

### 3. RESULTS AND DISCUSSION

#### 3.1 Evaluation results of “Preference of the dining room”

Figure 3 shows the rate of positive responses (slightly good or good or very good) for “Preference of the dining room”. When the wall color was white, light color in both spaces was CCT5000K condition, 80% of non-migrainers responded positive evaluation, on the other hand, only 30% of migrainers responded positive evaluation ( $p < 0.05$ ). When the wall color in both spaces was yellow and light color was CCT5000K condition, 70% of non-migrainers responded positive evaluation, and all of migrainers responded positive evaluation. When the light color was CCT3000K, more than 90% of migrainers responded positive response in either wall color conditions. When the wall color in both spaces was white and light color in there was CCT3000K, all of migrainers responded positive evaluation. Therefore, it was revealed that in the case of light color in both spaces was CCT5000K, migrainers tended to prefer the condition that wall color of both spaces was yellow. And it was also cleared that in the case of wall color in both spaces was white, migrainers tend to prefer CCT3000K condition.

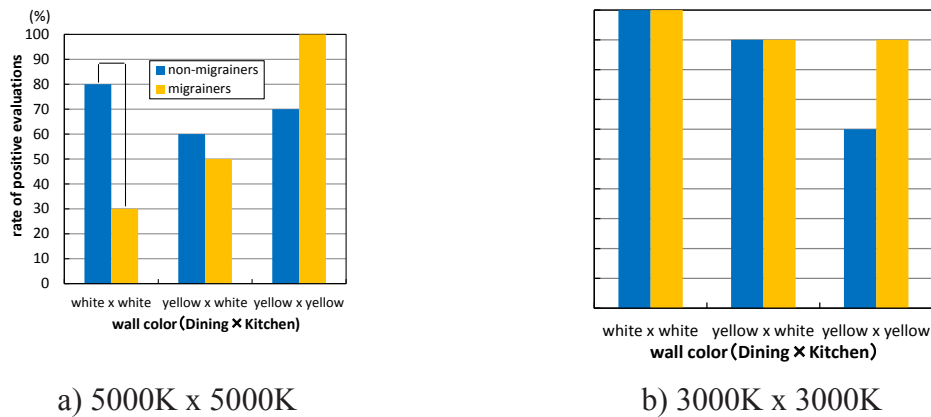

Figure 3: Rate of positive responses.

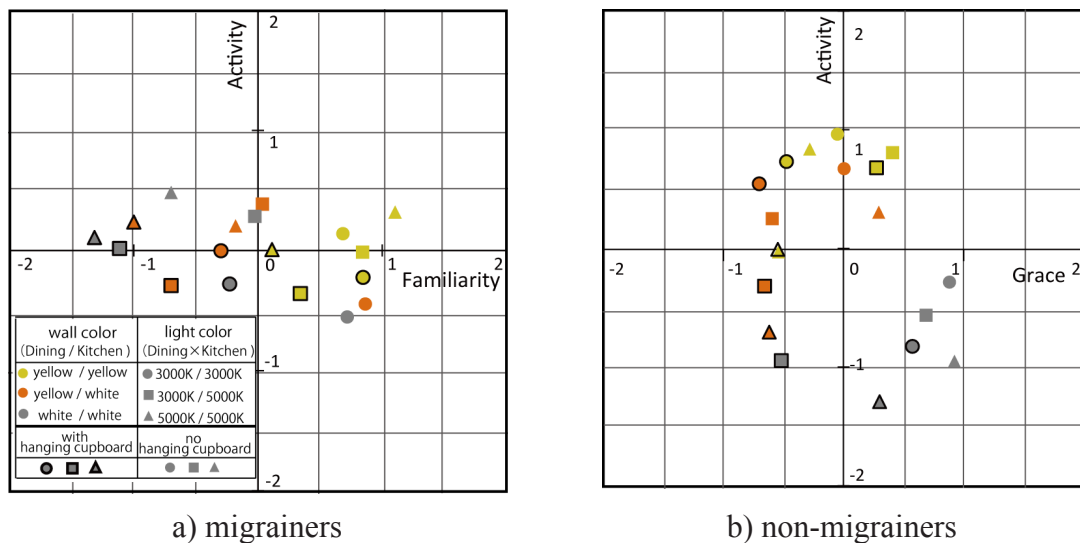

Figure 4: Factor scores acquired from results of factor analysis.

### 3.2 Results of “Impression of the dining room”

We conducted the factor analysis on the results of impression evaluation by using IBM SPSS Statistics 20.0, with principal component method and varimax rotation. We extracted three components from the results of migrainers, “Familiarity”, “Activity” and “Grace”. We also extracted three components from those of non-migrainers, “Grace”, “Activity” and “Novelty”. Figure 4 illustrates the factor scores acquired from results of factor analysis. It was shown that “Familiarity” was positive for migrainers when the wall color was yellow under all lighting conditions. It was also shown that the “Activity” was positive for non-migrainers when the wall color was yellow under all lighting conditions.

## 4. CONCLUSIONS

Migrainers prefer a dining room where wall color is yellow in both CCT3000K and CCT5000K. And also, migrainers prefer the room where the light color is CCT3000K. It was also shown that impression of the dining room was different for migrainers and non-migrainers. When the wall color in both spaces was yellow that migrainers prefer the condition, “Familiarity” was positive under all lighting conditions.

## ACKNOWLEDGEMENTS

We were deeply grateful to Dr. Muneto TATSUMOTO, neurologist in Dokkyo Medical University for determining of migraine of subjects in this experiment, and Yuko Kamemura who was an undergraduate student in D.W.C.L.A. for making experimental equipment and operating this experiment.

## REFERENCES

- Hirschmuller, A.K., H. Irtel and M. Schlegel 2008. Emotional response to interior room colour attributes – in full – scale room modelling, *Proceedings of the AIC Colour 2008*, 29-30.
- Inagaki, T. and S. IJIMA 2008. A preliminary study on the evaluation of the floor –finishing materials – the comparison with visual impression and feeling impression, *Proceedings of the AIC Colour 2008*, 145-146.
- Kagimoto, A., S. Okuda, M. Tatsumoto, K. Okajima and K. Hirata 2012. Preferable lighting conditions for migraineurs in relaxation room. *Proceedings of the 7<sup>th</sup> Lux Pacifica 2012*, 102-104.
- Kelman, L. 2007. The triggers or precipitants of the acute migraine attack, *Cephalalgia* 27(5) 394-402.
- Sakai, F. and H. Igarashi 1997. Prevalence of migraine in Japan: national wide survey, *Cephalalgia* 17(1) 15-22.

*Address: Akari Kagimoto, Graduate School, Doshisha Women's College  
602, Genbu-cho, Kamigyo-ku, Kyoto, 602-8093, JAPAN  
E-mails: ide001@dwc.doshisha.ac.jp, sokuda@dwc.doshisha.ac.jp*

# The Influence of the Extreme Thick Applied Layers of Varnish on Colour Properties of LED UV Curing Inkjet Prints

Igor MAJNARIC, Ivana BOLANCA MIRKOVIC,  
Aleksandra BIRTA, Sandra MUSTAC  
Universty of Zagreb Faculty of Graphic Arts

## ABSTRACT

The increase of the aesthetic value of the printed products is often performed so that the existing layers are covered with the additional ones. By thicker application of LED UV drying varnish based on acrylates and on two component polyurethane it is possible to create the additional effect, not considerably losing the original tonal value of the prints at the same time. Unfortunately the existing of the thicker layer results in the change of original tonal values. In this work the prints on the self-adhesive vinyl material which were printed on the LED UV Inkjet printer Roland LEC 300 were analyzed. With the aim of achieving better mechanical and optical properties the prints were additionally refined with the transparent polyurethane resin and with UV drying varnish. Based on the measurement (X-rite DTP 20) the gamuts of reproductions were created. The additional analysis of the reproduction of CMYK\_RGB patches in the area of 100% and 50% tone value. With the intention to eliminate influence of the applied layers, with application of Techon spectrophotometer and densitometric and spectrophotometric correction factors. In this way the prints with the added embossing effect with UV varnish and DOOM effect with polyurethane would be more natural.

## 1. THEORETICAL PART

In order to create the additional information on the printing products, except the ink the additional transparent layers were applied on the printing substrate. Because of low viscosity it was necessary to stabilize the Inkjet inks as soon as possible. In this connection the prints could be exposed to the defined electromagnetic radiation sources (mercury lamps and LED lamps) (Kiphan, 2001). For the LED lamps the spectrum with only one dominant wave length (peak) which is in the UV-A area (320-395 nm) is characteristic. Different from the traditional mercury lamps the LED sources are ecologically more suitable because they do not create the harmful ozone. (Hue,1998).

In order to secure the instantaneous solidification of UV Inkjet inks the varnishes had to obligatory contain two components: photo-initiators and acrylic monomers. Depending on UV printing technique different photo-initiators could be used in inks. They were usually the TPGDA ones (tripropylene-glycol-diacrylate), benzil-dimethylketal, 2-hidroksi-metil-1 phenil propane and hydroxicikloheksaphenilketone (Magdassi, 2009). During the imaging the photo-initiators would be activated and they wouldl form two types of free radicals: the radical which would find partners and the radical which would not find partners. In the case that the free radicals of the photo-initiators found the macro molecule (amine acrylate) the polymerization would happen, i.e. the mutual networking. The pigment particles were closed in that structure and fixed to the printing substrate. Contrary to the UV inks, the UV varnishes would replace the lack of ink carrier with the greater part of binders (oligomers and monomers) (Edison, 2006).

Polyurethanes which were used as coatings in printing industry belonged to the group so called PEUR consistencies – poly (ether-urethanes). Polyurethane resins were directly applied on the print, in which process the most often used method was varnishing. However, if it was necessary to create thicker layers the process of spraying was used. Contrary to the UV varnished prints, the refining with polyurethane would give much harder and mechanically more durable printing products. The reason for that was possible to find in the structure of PEUR consistent which contained two parts (hydrophilic and hydrophobic part). Hydrophilic chain was made of aliphatic carbohydrates, the atoms of which were arranged in one straight long chain. Hydrophobic radicals were bond to that chain. Their number could vary, i.e. with greater number of radical groups the compounds would be formed which would be more resistant to humidity. PEUR composites are non ionic polymers. The length of chains could be from  $C_{10}$  to  $C_{20}$ . Such radicals contained most often amino groups and at the end of the chains they would give hydrophilic properties (Tracton, 2007).

Both refining methods would have the decorative function because of the expressed gloss and smoothness, which could be used for decoration of different packaging products. It was particularly visible when the varnish was applied in greater number of layers in which the best applying method was the UV drying Inkjet printing (Thompson, 2004).

## 2. EXPERIMENTAL PART

For the needs of this experiment the digitalized printing form was used which contained 378 exactly defined patches (formed by permutation of the basic CMYK inks in the area of 25%, 50%, 75% and 100% screen value). They were printed on UV LED Inkjet machine Roland LEC 300 with the associated Wersa Work RIP (output resolution = 720 x720 dpi, ICC profile = Euro scale coated, halftone method = dither method). As the printing substrate 80  $\mu$ m calendered white self-adhesive vinyl foil was used (Multi Purpose Inkjet vinyl 3500 of the manufacturer Avery). After the finished printing (**Sample 1**) the additional finishing of the printed surface was done:

**Sample 2** – additional coating of the gloss UV drying varnish (25-35% solvent hexamethylene diacrylate hexanediol diacrylate), 10-20% synergistic acrylated amine, 30-40% acrylic esters, 10-20% photo sensitive monomers, 5-15% phosphine oxide derivate i 0-1% additives) in 4 layers with the UV LED Inkjet printer Roland LEC 300. The final thickness of varnish was 0,07 mm (Field, 1990).

**Sample 3** – by pouring the two-component liquid polyurethane resin which was formed by mixing the poly resin T826 (80% polyester and 20% polyvalent alcohol) with poly hardener K866 (hexamethylene diisocyanate) in the ratio 1:1 (of the manufacturer Euro Drop). After drying (24 h) the average layer with the thickness of 1,17 mm was generated.

For the needs of print analysis the spectrophotometer X-rite DTP20 Pulse (measuring geometry  $0^\circ/45^\circ$  and standard observer  $10^\circ$ ) was used. Based on the measured 378 LAB values and the application of *Monaco Profiler Platinum version* the ICC profiles were made, that is, the 3D gamut was constructed. For the comparative analysis of prints with the additional effects the characteristic CMYKRGB tonal patches were chosen (100% screen value, 50 % screen value, i.e. 66% screen value in black). On the basis of their CIE LAB coordinates the colour differences CIE  $\Delta E_{00}$ , CIE  $\Delta L_{00}$ , CIE  $\Delta C_{00}$  and CIE  $\Delta H_{00}$  were calculated (Luo & Rigg, 2001). For the visualisation of the formed changes the additional software OriginPro v8.6. was used. In order to determine the influence of the applied transparent layers the spectrophotometer and the densitometer Techon, version premium were used with the installed Ink Check Colour Guide, (including the standard values ISO 12647). That enabled the printer to

get the densitometric and the spectrophotometric corrective factors for achieving the optimal coating of 100% tonal value (CMYK\_RGB).

### 3. RESULTS AND DISCUSSION

The refining the Inkjet prints caused important colour changes. This was visible from the space gamut:  $V_{\text{without effects}} = 864,086$  gamut units,  $V_{\text{with varnish}} = 860,592$  gamut units and  $V_{\text{with polyurethane}} = 575,250$ . It was visible that the applying of any transparent coating on the original print resulted in the determined colour shift of the basic tonal values. It means that the thicker layer would have an important role. The variation in inking was not the same and it was specific for each colour area. Figure 1 presents  $L^*a^*b^*$  values for CMYK RGB patches (tonal values in full tone and in the medium tonal values).

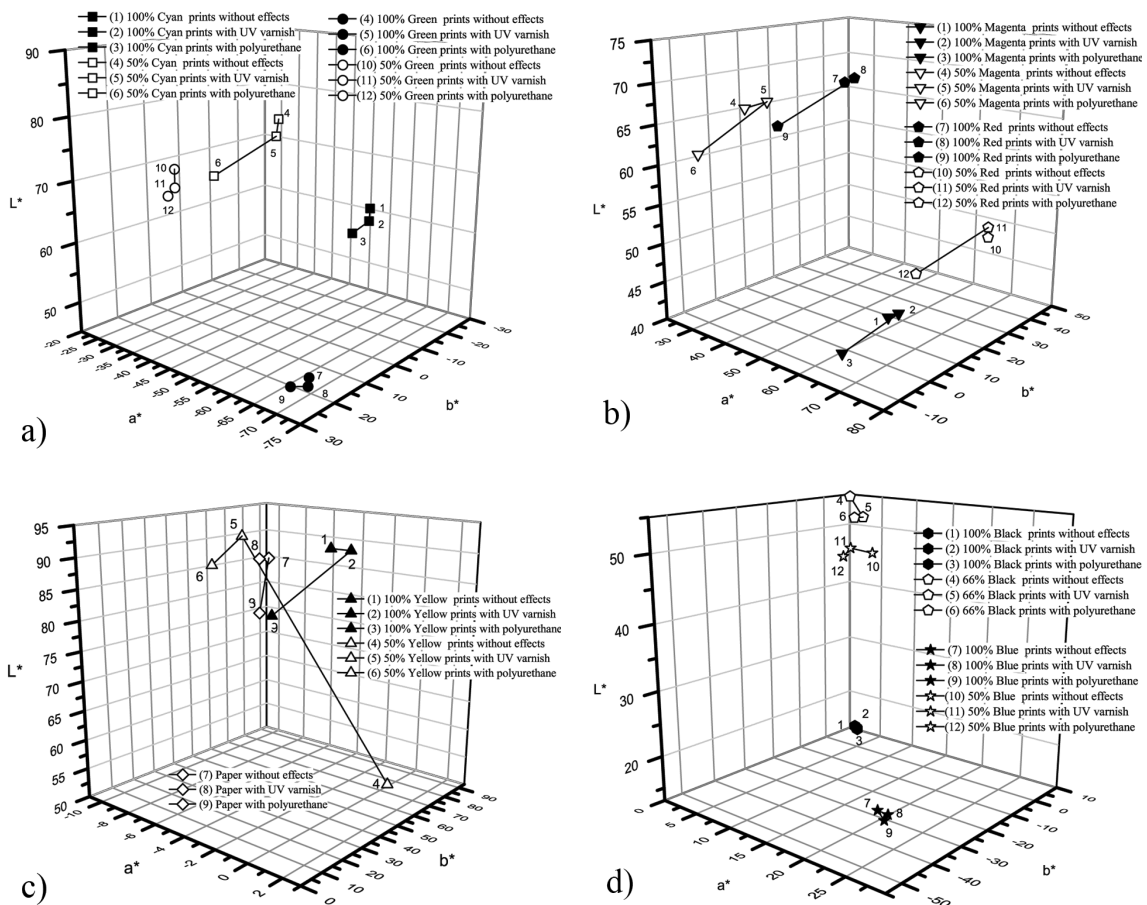

Figure 1: Colour variation of Inkjet prints (100% and 50% tone value) application 4 layers of LED UV curing varnish and polyuretane layer: a) cyan and green, b) magenta and red, c) yellow and substrate, d) black and blue.

Only the application of the transparent layers results in the change of the whole reproduction. UV varnished printing substrate has greater colour change ( $\Delta E_{UV\text{ Varnish}} = 7,35$ ) than the thicker and more transparent polyurethane layer ( $\Delta E_{\text{Polyurethane}} = 4,51$ ). By comparison of the effects realized by experiments the greatest colour change was noticed in the tones with high portion of yellow ( $\Delta E_{\text{Yellow}} = 9,30$ ). The reason for that was the decrease of lightness ( $\Delta L_{\text{Yellow}} = 8,20$ ) which is the characteristic of the other process inks. The secondary colours which contain the yellow pigments (green and red) behave in the same way. After the refining the

achromatic tones have the smallest change ( $\Delta E_{\text{Black}}=0,52$ ). The tones formed by screening (50%screen value) have much greater colour differences because of the influence of the printing substrate.

#### 4. CONCLUSIONS

With the aim to prevent the influence of the additional layers on colour inking the printer would have to foreseen in advance the final influence of the polyurethane resin and of the UV drying varnish. Unfortunately he would not be able to eliminate them completely. However he would be able to correct some of them. For that the application of the following correction factor was suggested (tab. 1 and tab. 2). In both effects the yellow ink changes chromatically most which is the reason for performing the measurements through the yellow channel.

*Table 1. Corrective factors for LED UV varnished prints (measured with Tachon)*

Colour	cyan	magenta	yellow	black	Red	Green	Blue
Request $\Delta E_{00}$	5,3	6,6	1,8	15,7	7,2	9,5	11,3
Possible $\Delta E$	1,2	1,4	1,3	13,9	0,5	2,2	2,1
Correction (D)	-0,11	-0,09	-0,06	+0,32	-0,04 (Y)	-0,23 (Y)	-0,11 (Y)

*Table 2. Corrective factors for prints with polyurethane (measured with Tachon)*

Colour	cyan	magenta	yellow	black	Red	Green	Blue
Request $\Delta E$	3,1	18,9	31,3	16,4	23,6	14,9	11,8
Possible $\Delta E$	3,1	4,0	23,2	16,4	4,9	3,3	2,6
Correction (D)	0,12	-0,15	-0,66	0,66	-0,16 (Y)	-0,23 (Y)	-0,13 (Y)

#### REFERENCES

- Edison, S., 2006. *UV Curable Inkjet Inks Revolutionize Industrial Printing*, Radtech Report, November/December, 28-33.
- Field, G.S., 1990. *Color Scanning and Imaging Systems*, Pittsburgh, GATF.
- Hue, P.L., 1998. *Progress and Trends in Ink Jet Printing Technology*, IS&T Journal of Image Science and Technology, 42 (1), 49-62.
- Luo, M.R., G. Cui and B. Rigg, 2001. *Color Research & Application* Special Issue: Special Issue on Color Difference, 26(5), 340–350.
- Kiphan, H., 2001. *Hand Book of Print Media*, Berlin: Springer
- Magdassi, S. 2009. *The Chemistry of Inkjet Inks*, The Hebrew University of Jerusalem, Israel.
- Thompson, B., 2004. *Printing Materials: Science and Technology*, Surrey, Pira International.
- Tracton, A.A., 2007. *Coatings Materials and Surface Coatings*, New York, CRC Press.

*Address: Assistant Prof. Igor Majnarić, Department of Printing,  
University of Zagreb, Getaldićeva 2., 10 000 Zagreb, Croatia  
E-mails: majnaric@grf.hr; ibolanca@grf.hr*



# Night Photography

Chavdar TSVETKOV  
St. Clement of Ohrid, University of Sofia, Bulgaria

## ABSTRACT

During the development of the photography as art there are a few different streams in its advance. The biggest and closest examination field is maybe its technological aspect. In its progress other fields of the methods of influence upon the public were underrated and mostly overlooked. For example like the games with natural and the public lightings in the field of the night photography. The main purpose of this study is to examine the role of the color change of the light from natural and artificial lighting sources by the night photography as an instrument for drawing the attention of the public using successfully the cultural patterns of the different cultural groups

Light effects its influence over the audience of photographic images at two major levels – physical-psychological and cultural. The physical sensitive level considers the capabilities of human vision and its range of perception, strongly limited as compared to other creatures' sensitive receptors, and – mostly – to technology progress. At technical level light sensitivity is measured by the ISO ratio, marking a sensor's photosensitivity, which already reaches more than 12,500 ISO, thus permitting the taking photographs in very low light. This is the second stage of physical perception of the colour and the psychological effects, influencing human consciousness. Human eye is limited, it can only distinguish light in the visible spectrum, positioned between 380 and 780 nm. **Calculated in frequency this comes to the interval of 400 to 750 terahertz.** Another constant which determines the effect of color change over the audience is the brightness of the object. The third constant is the color temperature, tightly connected to their length. According to the light emitted they have given temperatures, on which camera settings depend. For example, light from luminescent source, defined by human vision as blue, is in the range of 490-450 nm, its temperature is estimated at 5400 to 6000 m. All these compose the first module of the influencing the audience effect of photography. These values have led to the theory of trichromatic vision of Young-Helmholtz (Young, T., 1802). With the decrease of wavelength increases its temperature, which may be expressed as the inverse.

The perception capabilities of the human eye determine the way mind adapts colors to each relevant cultural model. Most convenient are the primary associations based on the color theory of Goethe, as developed in his *Study of Color* (Johann Wolfgang von Goethe 1810). This work served as base for analyses of various studies related to the psychological impact of color over the audience in the next 200 years. These studies over the years established certain templates for understanding some of the colors that are associated with certain cultural patterns, which in turn accumulate more cultural remnants in the form of different codes for interpretation. Some of these codes are worn by the most popular and easily perceived colors listed by Goethe as six.

One of the most accessible and commonly understood codes is this of the red color, even examined worldwide, apart from any domestic folklore deposits. Red is the incarnation of vital energy and activity. This is the color of passion, perhaps because the color red usually increases blood pressure and heart rate, as it is intense and deep; its darker shades create a

sense of intimacy, and in combination with other warm colors create a sense of comfort.

The psycho-physical influences of color vary widely and effect the perceptions for spatial dimensions, distance, zoom in or out, feeling hot or cold, senses of calmness, nervousness, excitement, etc. This influences extremely strongly night photography viewers, as some 60% of the night lights are characteristically warm and soft. The most common light-sources at night are street lighting lamps, using three types of lamps – with warm fluorescent light resembling incandescent, incandescent lamps, and lighting fixtures, using sodium hydroxide. With all these three types of light the wavelength is between 560-630 nm, which characterizes their light as warm with red, yellow and orange hues, giving objects a soft, pleasing to the eye brightness. This is the first aspect of the effect of an image on its audience.

The second one is connected to concrete cultural accumulations expressed in different associations emerging at the mentioning of a photographed location. They often vary between different cultural overlays having specific codes loaded with different meanings – from a meeting place, to a high traffic location, to a place with a particular cultural and historical status in the history of the respective country.

The role of color change, especially in night photography, is directly connected to these cultural codes, as they are only active during a certain time of day – its bright part. This suggests that they are recognizable at a certain color environment. With the coming of night and the color change of light, these codes, lacking the color frame making them current, become inactive. Therefore, the image of a place, filmed at night, is entirely devoid of the second module of the effect of influence over its audience. At night photography an image is completely devoid of its cultural deposits based on the certain brightness and colors of daylight.

Thus, an entirely new cultural model and understanding of the place is formed, created by the viewer of the photograph. It is built on the basis of color perception of any individual and the range of their personal cultural deposits. Thanks to the perception, a recipient adopts a new image of the site and builds a new unique cultural model about it, based on the color change. This could turn out to be a particularly useful tool in the field of cultural marketing as an instrument for influencing the audience.

This notion could be supported by some concrete examples from practices in the field of cultural management. This field is directly connected to night photography as it often uses its methods as attractive to the human eye effects for facilitating the attracting of attention to an object.

A simple example of this statement may be given by conducting an empirical study exploring how a photographed publicly known object changes by the changing colors at night photography and how this has been applied as a method for using it in advertisement practice. To prove this, the current study carried out an experiment as follows: objects have been photographed from the same place and position, with the same parameters of focus and distance, with the only difference in lighting. For this purpose two photo sessions were taken – a day and a night one, in order to detect the changes in the perception of photographs by different people from different social backgrounds.

Four photographs from two photo sessions are attached to this study, which were offered to the attention of 18 viewers from different social stripes. In the course of an inquiry among them, 16 of the 18 stated different views from the preliminarily described. This was found through discrepancies in the descriptions of the day and night compositions of the same photographed object. Furthermore, the audience started building a new cultural model for understanding and identification of the photographed object.

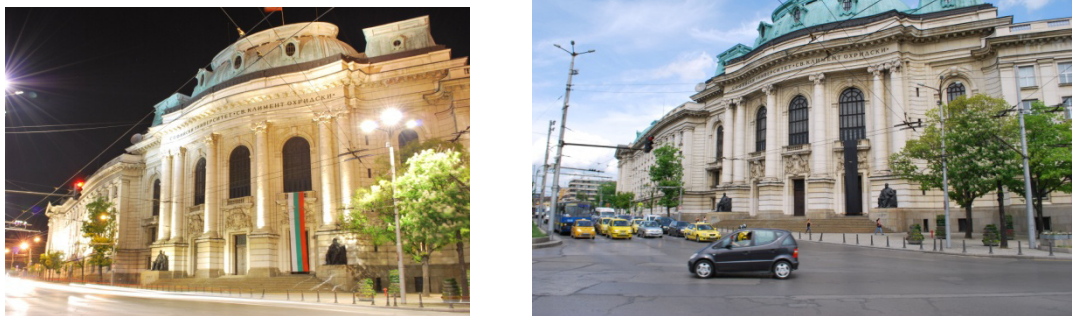

*Figure 1: Sofia University during daytime (left) and at night (right).*

The first photograph (Figure 1) is of Sofia University and in its daytime composition the view was recognized by 90% of the participants and associated with visions for higher education, student communities connected to the sub-model of their initiatives, its image among students and among outer audiences. But with the night picture, this same image was hardly recognizable and only 40% of the participants managed to identify the image in its night lighting. The more important to be mentioned here is that due to the lack of normal color perception, the cultural one changes, too. The evidence to this is that thanks to the city lights, complemented by traffic lights, an effect has been created described by 80% of the participants as “cozy”, which – in turn – brought associations to the history of the city and the cultural-archeological heritage, which is an inseparable part of the public image of the city of Sofia.

The experiment, of course, in turn, lead to secondary associations of the image, referring to the question of participants whether the position for the night mode shooting is freely available during the day and could it be visited as a cultural landmark. This is clear evidence that through the change of light the perception of cultural models is changed as well, which in turn leads to the formation of new ones.

This raises the issue that if the light sensitivity of modern digital cameras overleaps the vision range of human eye and brings demand for finer adjustments of camera settings through the balance of white in order of avoiding unpleasant light effects from too strong light, then the measuring of light sensitivity is of an extreme importance. Follows the question if the writing of software is possible to measure the values responsible for the light sensitivity index according to the formula derived from the law of Kepler (Hirakawa 2005), and what are the possibilities for this light sensitivity measuring software to be introduced into more basic camera models as well.

In conclusion it can be said that the change of light, and in particular – the change of light at day and night image taking, expressed in color change influencing the psychological perception of viewers, leads to the modification of existing cultural models or creation of entirely new ones.

This could be extraordinarily useful and widely applicable in the field of culture management in order of avoiding banal images of certain objects, which would also help the widening of the opportunities for carrying out a successful management program, totally different from the currently existing at least in regard of the photographed objects, given that so far the possibilities for their production are limited. Night photography, thanks to the possibility for new cultural models creation, widens namely these opportunities.

## REFERENCES

- Hirakawa, K., 2005. *Chromatic Adaptation and White-Balance Problem*.  
Judd, D.B., 1975. *Color in Business, Science and Industry*.  
Young, T., 1802. Bakerian Lecture: *On the Theory of Light and Colours*.  
Goethe, 1982. *Theory of Colours*, trans. Charles Lock Eastlake, Cambridge, MA: MIT Press.

*Артюшин Л. Ф. 1970. Основы воспроизведения цвета в фотографии, кино и полиграфии.*

# Colour Emotion and Colour Image Association of Black and White: A Study among Indian Urban Youth

Kaustav SENGUPTA, Anitha M. MANOHAR  
National Institute of Fashion Technology, Chennai, India

## ABSTRACT

Colour is an integral part of individual's visual interaction. The colour preference and emotion depends on demographic factors, such as age, gender, ethnicity and socio-economic level. Current proportion of population in India under 25 years is 51% and the proportion under 35 is about 66%. This predominance of youth in the population is expected to last until 2050 which is considered as the demographic dividend for the country. This study explores the colour emotion and colour-image association of Black and white among Indian urban youth. A survey was conducted with 201 young respondents from 11 urban cities of India. The results pointed that most of the colour emotions are positive and the youth (male and female) preferred black as one of the most preferred colours ( among other preferred chroma saturations ie Grey, Blue, Purple, Red, Pink, Orange, Yellow, Green, Brown and White) and it was associate with positive emotions. The socio-psychological reasons for such association were also discussed.

## 1. INTRODUCTION

Color, being an inseparable part of our everyday lives and everything we perceive is widely recognized to have a strong impact on our emotions and feelings (Hemphill, 1996; Lang, 1993, Mahnke, 1996, Stylesight, 2012). The Emotion Colour Wheel (made by David McCandless and published in Stylesight insights report, 2012) can help visualize the group feelings. The circle is divided into colours to show some basic emotions. Color black is associated with 'hystorical' as emotion while color white is associated with 'unsure'.

In a study examining colour-emotion associations among college students in Australia, Hemphill (1996) found that bright colours elicited mainly positive emotional associations, while dark colours elicited negative emotional associations. However, Saito (1996) found that the colour black elicited both negative and positive responses among Japanese subjects, and that black was often a preferred colour among young people. Stephen and Karen (2010) explained that colour preferences and colour emotions are culture specific and not universal.

Dr. Oken Akcay, Dr. Paul Sable and Dr. M. Halim Dalgin (2012) studied the importance of colour in product choice among young Hispanic, Caucasian and African-American groups in the USA. Their results indicated that black is the most favourite colour for many different items.

In India, colour preference and colour emotion plays very significant role and individuals have the stereotype image association with colours. A report in "The Hindu" newspaper dated 25th September 2011 stated that in Waynad (Kerala, south Indian state) police allegedly forced tribal women to remove the black cloth worn by them ostensibly to prevent "possible demonstrations" during a recent visit by Kerala Chief Minister Oommen Chandy. The black dress though was a "part of tribal attire", the paper reported. In this case, the colour emotion and image association of "black dress" was not the same between police and tribal women. A report published in "The Hindu" newspaper dated 14th February 2013 ('Power

Dressing gets a makeover’) explained that colour white has strong image association when it comes to the attires of political leaders in Kerala (a south Indian state). It points out that nearly 80% of the members of parliament still fit into the traditional image of all white dress code. Moreover the coloured attire is considered to be a symbol of ‘richness’ rather than being humble in white.

The population Council (2010) states, “there are 315 million young people aged 10 to 24 years in India. This cohort is healthier, more urbanized and better educated than the earlier generation”.

However, the author found no relevant studies being conducted in India on colour emotion and colour-image association among urban youth. Hence, the purpose of the present study was to explore the colour emotion and colour-image association of Black and white among Indian urban youth. Also, to understand the socio-psychological scenario of such emotion & association.

## 2. RESEARCH DESIGN

The convenient sampling method was followed with referral system across the cities. The time duration was 2 months and 201 respondents filled the questioner from 11 Indian cities (Chennai, Delhi, Mumbai, Kolkata, Bangaluru, Coimbatore, Pune, Shillong, Patna, Ahmedabad, Jaipur). 187 answered all the questions and 14 skipped few. Hence, for analysis 187 completed answers were considered. The proportion of male and female respondents were 58% and 42% respectively. Most of the respondents were in the age of 20 to 25 years (62%), 26 to 32 years (25%) and 16 to 19 years (8%) respectively. Most of them were studying in college (52.8%). The question regarding the colour preference was kept as open ended and respondents were encouraged to fill up their own preference instead of selecting from the given options. No colour reference card/ stimuli was used hence the respondents were free to perceive their colour preferences and express their colour-image association

## 3. ANALYSIS AND INTERPRETATION

The overall chorma of the preferred colours were not much varied and confined to 11 colours ( Black, Grey, Blue, Purple, Red, Pink, Orange, Yellow, Green, Brown and White). Author observed that Black was one of the key preferred colour among the youth in urban India. It was observed that the overall colour emotions were highly positive. Though as per the colour emotion wheel by David Mccandless black is associated with negative emotions like hysterical and despite but the respondents in the study evoked positive emotions about this colour (Figure 1). This supports the results found by Dr. Oken Akcay, Dr. Paul Sable and Dr. M. Halim Dalgin (2012). Saito (1996) found that the colour black elicited both negative and positive responses among Japanese subjects, and that black was often a preferred colour among young people.

The colour and gender wise colour emotions are displayed below:-

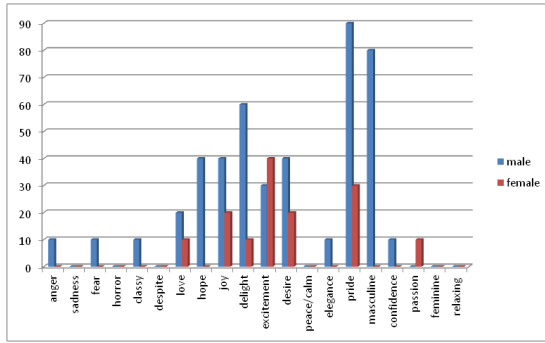

Figure 1: Emotions of colour Black (Male and Female respondents)

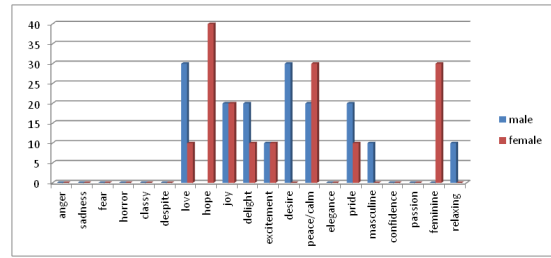

Figure 2: Emotions of colour White (Male and Female respondents)

Colour black evoked positive emotions such as pride, masculine, delight, hope, love, joy, delight among male and excitement, desire, pride, joy, love passion among female respondents. The highest emotions were pride, masculinity and delight.

Colour white evoked love, joy, delight, desire, masculine, excitement, calm, relaxing, pride among male and hope, calmness, peace, feminine, delight, pride among female respondents. The highest emotion was hope, for colour white. It was observed that the same colour evoked similar emotion across the cities in India.

The study revealed that the respondents had specific colour-image associations in their mind while preferring a colour. Often, the respondents associated a colour with celebrity persona (Black suite of Mr. Obama). It was noted that colour preference need not be on one's personal clothing but his/ her perception about other's wearing the preferred colour. Superstitious belief (i.e. Lucky colour) also sometime leads to colour preference and colour emotion. Images associated to Black and White colours are clustered and presented in Figure 3 & 4.

The colour black evoked dual colour-image representation and emotion such as "Classy car" vs "Death Metal music", "fear" vs "excitement" etc (Figure 3). The negative connotation of black brings in the feeling and emotion of "excitement" in the young mind and brain that is still in process of development and under the influence of "dopamine". The Dopamine stimulates youngsters to take action that leads to pleasure. The "risk taking" behaviour and "seeking excitement" are the results of disbalanced dopamine secretion (Jori Van den Bergh, Mattias Behrer, 2011).

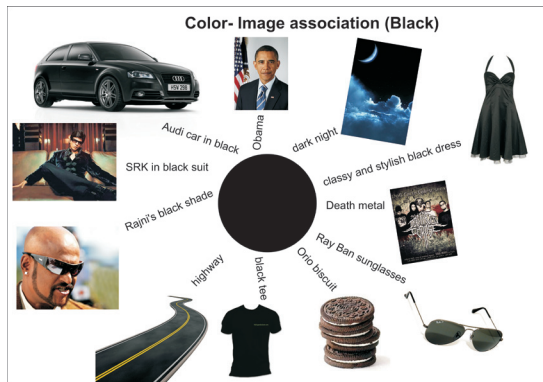

Figure 3: Author's visual interpretation of colour-image association (Black)

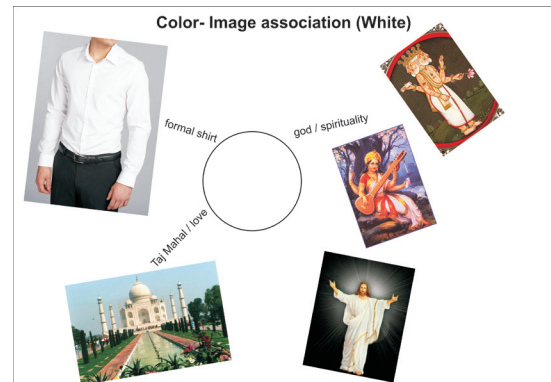

Figure 4: Author's visual interpretation of colour-image association (White)

Colour-image association for the colour Black was clustered in 4 broad segments. The colour was associated with products such as Audi Car, Black tee shirt, Ray Ban sunglasses and Black dress. The image association evoked classiness. The association with Orio Biscuits evoked love and good childhood memories. The colour was also associated with celebrities who evoked hope, aspiration and excitement.

Colour-image of White was associated with the formal white shirt, love (Taj Mahal, memorial of love), spirituality, holiness or God (Figure 4). In an article published online at [www.drivespark.com](http://www.drivespark.com) dated 15th may 2012 it was noted that white was one of the most sold cars in Indian subcontinent and among many reason one was the auspiciousness of the colour. Colour white evoked emotions such as peace, love and pride. The open ended questions revealed that colour white is associated with purity and higher social class. The results resonate with the understanding of Mr. Biyani and his failure of selling white colour shirts among middle class in India. Mr. Biyani stated, "One of our first mistakes was around the humble white shirt... but, the customer who walks into a Big Bazaar travels by train and bus. Even when the price of a white shirt is low, its maintenance cost is too high for him." Another good example of higher socio-psychological stereotype regarding colour white are the architectures of pre-colonial India where splendid white marvels were predominantly used (mostly imported) to build palaces, monuments (i.e. Taj Mahal), temples etc. to depict royalty and superiority.

#### REFERENCES

- Biyani Kishore, 2008. *It Happened in India: The story of Pantaloons, Big Bazar, Central and the great Indian consumer*. 2nd ed. New Delhi: Rupa & Co.
- Deanna J. Radeloff, 1991. Psychological Types, Color Attributes, and Color Preferences of Clothing, Textiles and Design Students: *Clothing and Textiles Research Journal* 9: 59-67
- Naz Kaya, Helen H. Epps, 2004. *Relationship Between Color and Emotion: A Study of College Students*: Project Innovation (Alabama)
- Dr. Akey Okan, Dr. Sable Paul, Dr. M. Dalgin Halim, 2012. The Importance of Color in Product Choice among Young Hispanic, Caucasian, and African-American groups in the USA. United States of America : *International Journal of Business and Social Science*. Vol3. No. 6: Special Issue.
- Madden J. Thomas, Hewett Kelly, Roth S. Martin, 2000. Managing Images in Different Cultures: A Cross-National Study of Color Meaning and Preferences. *Journal of International Marketing*, Vol.8, No.4, 90 – 107
- Adams. M. Francis, Osgood E. Charles, 1973. A Cross- Cultural Study of the Affective Meaning of Color. *Journal of Cross-Cultural Psychology*, Vol. 4, 135 – 155
- Mario De Bortoli, Jesus Maroto, 2001. Colours Across Cultures : Translating Colours in Interactive Marketing Communications. *Communication and Information Technologies (Elicit) Conference*, University of Paisley
- "The Hindu" : dated. 25th September 2011 & dated. 14th February 2013
- Data on youth population (2010): <http://youthportal.gov.in/statistics/demographicdetails.htm>

Address: Prof. Kaustav SenGupta,  
National Institute of Fashion Technology, Chennai, India  
E-mail: [kaustavsengupta@yahoo.com](mailto:kaustavsengupta@yahoo.com)



# The Effect of Coloured Lightings on the Judgment of Spontaneous Facial Expressions

Hyensou PAK,<sup>1</sup> Chan-Su LEE<sup>2</sup>

<sup>1</sup>LGE Advanced Research Institute, LG Electronics

<sup>2</sup>Department of Electronic Engineering, Yeungnam University

## ABSTRACT

In this study, we investigated the effect of coloured LED lightings on the judgment of spontaneous facial expressions. For this purpose, we used 22 photographs of New Guineans' facial expressions and 12 Korean affective words translated from English ones which were used for describing the facial expressions of the primitive tribe in previous studies (Ekman, 1980; Naab & Russell, 2007). Also, two types of LED lightings, red coloured and blue coloured, in an experimental room and fluorescent lightings in the university lecture room were used as experimental lightings. University students and young people in the similar age group participated in an emotion rating on the facial expressions using the affective words under the lighting conditions. The results showed that the average rating scores of the affective words were higher under the red coloured LED lighting compared to other lighting conditions. By analyzing the affective words into positive group ('happy', 'relaxed', 'interested'), negative one ('afraid', 'angry', 'disgusted', 'sad', 'contemptuous', 'surprised') and neutral one ('embarrassed', 'perplexed', 'hesitant'), we have found a tendency that the rating scores of some positive affective words were a bit higher under green LED lighting but those of negative affective words were higher under red one. These results suggest that coloured LED lightings are likely to influence to the interpretation of spontaneous facial expressions and the resulting our understanding of emotions.

## 1. FACIAL EXPRESSIONS AND AFFECTIVE WORDS

Emotional states or responses are usually revealed on people's facial expressions and we can effectively describe them with affective words. That is, we rely on the visual and linguistic information when we recognize people's emotions and then we properly respond to them. For this reason, many researchers from diverse disciplines like psychology, anthropology, and linguistics have been focused on the facial and linguistic expressions in different cultures for a long time to investigate the nature of human emotion. Particularly, spontaneous facial expressions are a useful tool for the universal emotion research, and they are actually used for various cross-cultural studies based on different ethnic groups. If people from different cultural backgrounds show a consistent response to the stimuli, it will be obvious that we have basic emotions which are universally perceived and interpreted by others.

Among the psychological studies on the human emotions, there are two different positions on the classification of basic emotions. Some researchers insist that our emotion is consisted of several primary or basic emotions like happiness, fear, anger, sadness, disgust, etc. and those emotions are described in our language, i.e., affective words (Ekman, 1980). However, some psychologists proposed dimensional approaches that the basic emotions can be positioned on a dimensional space consisted of two orthogonal axes (Russell, 1980; Naab

& Russell, 2007) or higher dimensional axes. However, both groups have been used affective words for describing the basic emotions and for comparing them in different cultures, though every language has not the same affective words that describe the emotions in the same meanings.

## 2. COLOURED LED LIGHTINGS

Recently, LED lightings are called as an emotional or affective lighting because they are widely applied to change a surrounding atmosphere and even to affect people's emotional state using various lighting parameters like colour temperature, brightness, and colours. Particularly, users of LED lightings can easily create a desirable illuminating environment that is more comfortable and proper to their emotional condition by manipulating the diverse colours of the lighting.

In our previous study (Pak, Lee, & Jang, 2011), we examined the possibility that the colours of LED lighting can influence on our perception to the affective pictures and words. More specifically, when IAPS (International Affective Picture Stimulus) photographs were used for the affective rating task, red LED lighting elicited an excitement at the arousal dimension and green LED lighting evoked pleasantness at valence one. In addition, recognition memory responses to the affective words presented under green LED lighting were significantly faster compared to the other coloured LED lightings.

To get more empirical evidences of the effect of coloured LED lightings on affective stimuli, we adopted the spontaneous facial expressions as the experimental stimuli in the study. This kind of research could help us to understand the characteristics of coloured LED lightings and give some insight about the application of the lightings.

## 3. EXPERIMENT

### 2.1 Method

*Participants* Ninety-seven university students and young people in the similar age range participated in the experiment. They were divided into 3 different lighting conditions. That is, 16 university students (male: 9, female: 7, average age: 23.6) for red LED lighting condition, 15 students (male: 7, female: 8, average age: 24.3) for green LED lighting condition, and 66 students (male: 22, female: 44, average age: 21.9) for fluorescent lighting condition.

*Stimuli & Apparatus* Twenty-two photographs of New Guineans' spontaneous facial expressions used in the study of Ekman (1980) and 12 Korean affective words corresponding to the English ones used by Ekman and Friesen (1986) were presented to the participants for an affective rating task in the form of questionnaire. Each photograph and 12 affective words with the rating scale were printed on the A4 sized paper, so totally 22 hardcopies were given to the participants. As the experimental lighting conditions, red and green coloured LED lightings in an experimental room and fluorescent lightings in a lecture room were used. Table.1 shows the details of experimental lighting conditions.

*Procedure* All participants observed the spontaneous facial expression of New Guineans for few seconds that was randomly presented. And, using the listed affective words (*happy, afraid, interest, angry, embarrassed, disgusted, sad, contempt, relax, surprised, perplexed, hesitant*), they indicated whether the facial expression had a specific emotion by circling

“yes” and then rated the emotion of it with 6 point rating scale which is ranged from barely to maximum intensity. There was no time limit for the rating. In general, the experiment took about 5 to 10 minutes to complete the ratings.

Table 1: Brightness and xy coordinates (CIE, 1931) of lighting conditions.

Lighting Condition	Lux (ave.)	x (ave.)	y (ave.)
Red LED lighting	107.50	0.687	0.304
Green LED lighting	114.56	0.188	0.739
Fluorescent lighting	425	0.327	0.347

## 2.2. Results

We analysed the rating data that participants indicated over 50% that the photographs had one of the 12 emotions. All photographs were used for the analysis although they didn't have rated data in every affective words related to a specific facial expression. A one-way ANOVA (analysis of variance) and *t*-test for independent samples were conducted.

The result of the ANOVA showed that there was a significant difference among the lighting conditions [ $F(2, 33) = 9.877, p < .005$ ]. The results of *t*-test showed that there was a significant difference between red LED lighting and green LED lighting [ $t(22) = 3.828, p < .001$ ] and between fluorescent lighting and green LED lighting [ $t(22) = 3.103, p < .005$ ], but no significant difference was found between red LED lighting and fluorescent lighting [ $t(22) = .948, p = n.s$ ]. Figure 1 shows the overall result of emotion rating on the all 22 spontaneous facial expressions when 12 affective words were used under 3 different experimental lightings.

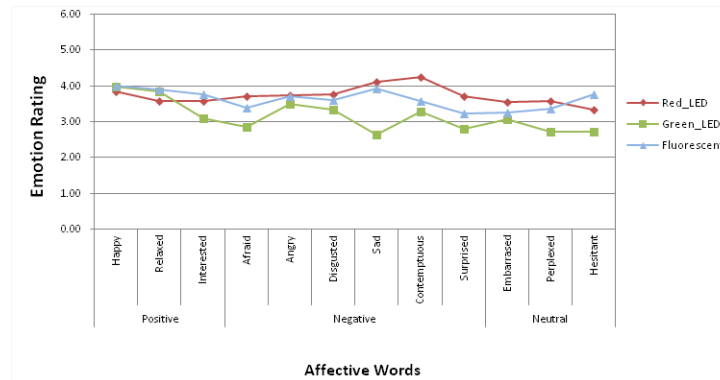

Figure 1: Result of emotion rating on affective words under experimental lighting conditions.

As revealed on the Figure 1, there is a tendency that emotion rating with some positive affective words is slightly higher under green LED lighting and fluorescent lighting than under red LED lighting except ‘interested’. In contrast, when the negative affective words are used, the emotion rating is higher under red LED lighting but lower under green LED lighting. Likewise, emotion rating with the neutral affective words shows that red LED lighting increases the score compared to green LED lighting, although neutral affective words have somewhat negative nuances and might covariate with the negative affective words. When the spontaneous facial expressions were classified to positive, negative, and neutral ones in the additional analysis, we could find a similar pattern of result according to the colours of lightings.

#### 4. CONCLUSIONS

Using spontaneous facial expressions of New Guinean and Korean affective words, we examined the effect of coloured lighting to our perception of emotion. Our results showed that red LED lighting increases the emotion rating of negative affective words but decrease the rating of positive ones. By contrast, green LED lighting seemed to influence to the rating in the opposite way. Particularly, red LED lighting and green LED lighting revealed a quite different effects when affective words related to the negative facial expressions were used. It implies that LED lighting colours have a significant influence on our perception and interpretation of people's facial expression and, consequently, of their emotions. Therefore, this kind of results suggest that coloured LED lighting is one of the most effective ways for us to change not only the surrounding atmosphere but also our visual information processing related to emotional status of others. Also, lighting colours will be useful means for easier mutual communication and understanding.

Now that we used the spontaneous facial expressions for this study, the results have more ecological validity compared to other experiments in which artificial and exaggerated facial expressions were used. However, we need to collect more data using various experiments and compare them to other studies' results in different cultures so as to confirm the universality of the effects of lighting colours on the judgment of basic emotions. In addition, it is necessary to use more colours of lighting to find out their effects on our perception of other's emotion and on our own emotional response to the lighting colours as well. They will shed a light on the applications of coloured lighting to our healthy emotional life.

#### REFERENCES

- Ekman, P., 1980. *The face of man: Expressions of universal emotions in a New Guinea village*, New York, NY: Garland Publishing, Inc.
- Ekman, P., and W. Friesen, 1986. A new pan-cultural facial expression of emotion, *Motivation and Emotion* 10 159-168.
- Russell, J.A., 1980. A circumplex model of affect, *Journal of Personality and Social Psychology* 36 1161-1178.
- Naab, P.J., and J.A. Russell, 2007. Judgments of emotion from spontaneous facial expressions of New Guineans, *Emotion* 7 736-744.
- Pak, H., C.S. Lee and J.S. Jang, 2011. The effect of LED lighting hues on the rating and recognition of affective stimulus, *Korean Journal of the Science of Emotion and Sensibility* 14(3) 371-384.

*Address: Prof. Chan-Su LEE, Dept. of Electronic Engineering, Yeungnam University,  
280, Daehak-Ro, Gyeongsan, Gyeongbuk, 712-749, South Korea  
E-mail: chansu@ynu.ac.kr*

# Analysis of Brain Activity to Varying LED Lightings Accompanied by Affective Audio Stimuli

Jongwoo NAM,<sup>1</sup> Chan-Su LEE,<sup>2</sup> Jiyea SHIN,<sup>2</sup> Jasoon JANG<sup>2</sup>

<sup>1</sup> LED-IT Fusion Technology Research Center, Yeungnam University

<sup>2</sup> Department of Electronic Engineering and LED-IT Fusion Technology Research Center,  
Yeungnam University

## ABSTRACT

LED (Lighting Emitting Diode) lighting system is easier to control illumination and color temperature than conventional lighting device. The change of color temperature or chromaticity of lighting affects human emotional response. This paper analyzes brain activity by statistical analysis of frequency domain sub-band signals. We performed two experiments to analyze the effect of LED lighting condition on human emotion: one for color temperature, the other for chromaticity. For affective stimulus, IADS (International Affective Digitized Sounds) audio signals are used. The audio signals have predefined valence level and arousal level, which is used to evaluate brain signals. In the first experiment, we controlled color temperature by 2700k, 4500k, and 7000k under the affective audio stimulus. Ten subjects participated in the primary experiment. FFT (Fast Fourier Transformation) is applied for frequency domain analysis. Average power in subdivided frequency bands are analyzed for different lighting conditions. Experimental results show that alpha band signal is increased under a lower color temperature like 2700K, which implies that subject is more relaxed. High-band alpha rhythms (10~12Hz) relative power of blue and green LED chromatic lighting is larger than that of white LED lighting for high arousal positive valence audio stimulus and high-band alpha relative power of red lighting is smaller than that of white lighting for low arousal positive stimulus.

## 1. INTRODUCTION

LED (Light Emitting Diode) lighting is promoted to exchange conventional lighting bulb for energy saving in general lighting. In addition, LED lighting is easier to control its color temperature and chromaticity than conventional lighting.

There has been several studies of the effect of color temperature on human biological rhythms and mood. It is reported that high color temperature lighting induces human high arousal level (Hu 2011). The colors of LED lighting influence on human emotion and cognition as well in the evaluation of affective rating of various IAPS (international affective picture system) photos containing affective contents (Pak 2011).

In the study of the effect of lighting and color on emotional states, not only self-reports of emotion but also physiological signals are used for the estimation of emotional states which are embedded by physiological response. The effect of illumination and color temperature on lowering physiological activity are studied with an ordinary residential setting (Noguchi 1999). Electroencephalogram (EEG) reflects electrical activity underlying central nervous system process and has therefore been useful in exploring the hemispheric specialization of emotion.

The effect of lighting color temperature and chromaticity on emotional response is studied using affective audio signals that are applied to stimulate human emotion. By stimulus of

different type of affective audio signals such as positive/negative audio and low/high arousal audio, we can estimate tendency of lighting effect on valence level, varying from negative to positive, and arousal level, varying from low to high.

## 2. METHOD

The audio stimuli, IADS (International Affective Digitized Sounds), provide both categorical and dimensional emotion identification for each sound (Stevenson 2008). Four sound stimuli are selected from low and high arousal level and positive and negative valence level.

Two different procedures are set: one is for correlated color temperature variation and the other for color chromaticity variation. Three different color temperatures (2700K, 4500K, 7000k) are specified and three different chromaticity values (red, green, blue) and white are specified in advance as shown in Figure 1. EEG signals are captured before and after playing affective audio stimulus. Plat LED lighting panel with RGB 3-in-1 chip LEDs are used in the experiment. LED lighting color temperature, chromaticity, and illumination level are controlled using DMX 512 protocol.

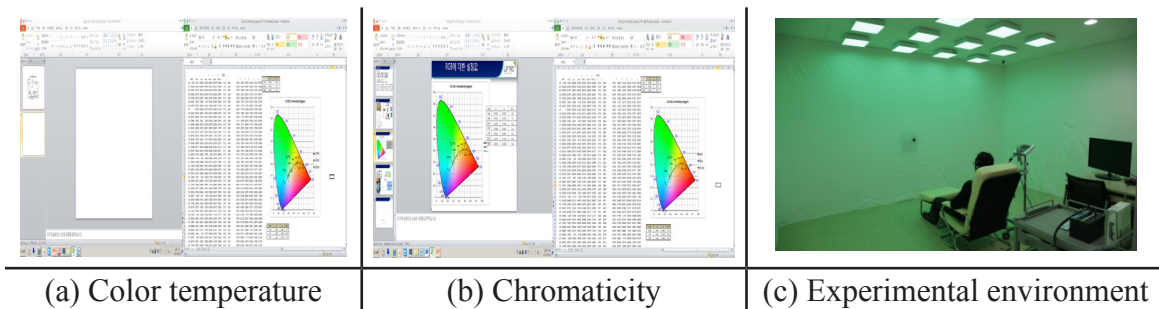

Figure 1: Color temperature and chromaticity used in the experiment.

Synamps2 and 32 channel Quick Cap are used to capture and amplify EEG signals. Electrodes are attached according to international 10-20 system. M1, and M2 are attached to mastoid as reference electrodes. The conductivity of vertical and horizontal area of eyes are measured to compensate eye blinking. Electrocardiogram (ECG) is acquired to compensate for noisy signals. Bandpass filter ranging from 1.0~30.0 Hz is applied and sampling rate is 1000Hz for each channel. Five male subjects and five female subjects with average age 23.8 are participated in the experiments.

### 2.1 Procedure for the experiment of color temperature variations

Three color temperature 2700K, 4500K, and 7000K are used for the experiment. Four audio stimuli are presented randomly under each color temperature. The presenting color temperature is also ordered randomly. Table 2 shows a time schedule in each session for a given color temperature. EEG signals are captured during 6 seconds stimulus time and 6 seconds prior time to apply the stimulus to measure brain signal variations by the stimulus.

Table 2. Procedure for measuring brain signal under selected color temperature.

Adaptation : open eyes (10s)	Rest (30s)	Stimulus (6s)	Rest (30s)	Stimulus (6s)	Rest (30s)	Stimulus (6s)	Rest (30s)	Stimulus (6s)	Rest : closed eyes (30s)
------------------------------------	---------------	------------------	------------	------------------	------------	------------------	---------------	------------------	-----------------------------

## 2.2 Procedure for the experiment of chromaticity variations

Red, green, blue, and white chromaticity color are used for the evaluation of the effect of color chromaticity of LED lighting on emotional response of affective sound stimulus. Four audio stimuli are presented randomly under each color illumination. Table 3 shows time schedule in each session for a given color chromaticity. Longer adaptation time and resting time are selected considering chromaticity adaptation time (Fairchild 1995). Figure 1 shows used color in the chromaticity diagram.

Table 3. Procedure for measuring brain signal under selected chromaticity illumination

Adaptation : open eyes (120s)	Rest (60s)	Stimulus (6s)	Rest (60s)	Stimulus (6s)	Rest (60s)	Stimulus (6s)	Rest (60s)	Stimulus (6s)	Rest : closed eyes (60s)
-------------------------------------	------------	------------------	------------	---------------	------------	------------------	---------------	------------------	-----------------------------

## 3. RESULTS AND DISCUSSION

FFT (Fast Fourier Transformation) is applied for frequency domain analysis of the measured EEG data. Average power in subdivided frequency bands are analyzed in different lighting conditions. Alpha (8~12Hz), beta(12~25Hz), low-band alpha (8~10Hz), high-band alpha (10~12Hz), high-band beta (25~30Hz) are analysed separately in each band paired t-test using SPSS statistical tools.

2700K and 7000K color temperatures are compared with 4500K color temperature data to find out the effect of low and high color temperature on emotion response. Fz, F3, F4, Fcz, Fc3, Fc4, Cz channels are analyzed from the relative power computed from Neuroscan software after preprocessing. In general, high arousal stimulus shows more significant difference than low arousal level and negative stimulus shows more frequent appearance in the significantly different signals in the paired t-test. In 2700K, alpha band power significantly increase and show relaxation in lower color temperature. Figure 2 shows different response of high alpha band, where negative stimulus increase concentration in lower color temperature and reduced concentration in positive stimulus.

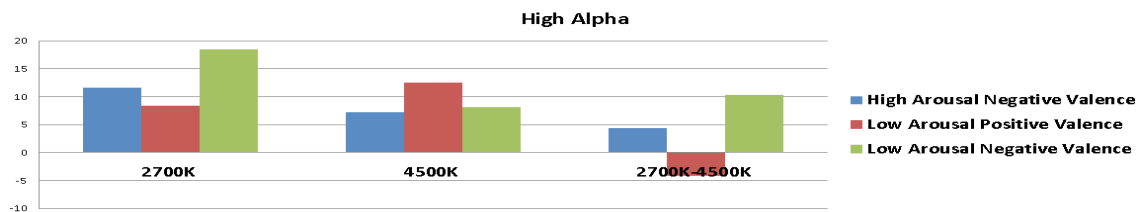

Figure 2: Different response of positive and negative stimulus in high alpha band.

In the chromaticity experiments, red, green, and blue color illumination are compared with white lighting illumination. Red, green, blue color illumination show lower spectral power in the alpha band than white color illumination, which implies that colored lights are less comfortable than white light. Table 4 shows statistically significant high-band alpha response. The result may imply that task-specific processes is better on white color illumination than blue and green illumination under high arousal positive stimulus, and red color illumination than white one under low arousal negative stimulus.

Table 4. Statistically significant pairs and their values of high-band alpha rhythm.

EEG	Chromaticity pair	Audio stimulus	Channel	Average	Standard deviation	t-value	Significance
High alpha	Blue-White	High Arousal Positive Valence	C3	-8.42	9.15	-2.90	0.017
			CZ	-5.80	7.73	-2.37	0.042
			F3	-9.26	2.53	-2.33	0.044
			FC3	-10.50	11.17	-2.97	0.016
			FCZ	-8.50	10.00	-2.68	0.025
	Green-White	F3	-5.98	8.11	-2.33	0.045	
	Red-White	Low Arousal Positive Valence	CZ	3.36	3.35	3.16	0.011

#### 4. CONCLUSIONS

This paper presented analyses of brain activity of alpha band, beta band, and their sub-bands to understand the effect of color temperature and color chromaticity of LED lighting on human emotional response using affective audio stimuli. High arousal level stimuli show significant difference of brain signals in each band than the low arousal level. The emotional response can be affected differently for positive and negative valence stimuli under the same lighting condition and further analysis and evaluation may be required.

#### ACKNOWLEDGEMENTS

This research was conducted under the industrial infrastructure program for fundamental technologies which is funded by the Ministry of Trade, Industry & Energy (MOTIE, Korea) and by the Ministry of Education, Science Technology (MEST) and National Research Foundation of Korea (NRF) through the Human Resource Training Project for Regional Innovation.

#### REFERENCES

- Hu, N.C. and Y.C. Fen, Z.Y. Huang, M.C. Chang, C.C. Wu and S.L. Hsiao, 2011. High color-rendering color tunable LED lighting for mediating noon drowsiness and mood, *In Proceedings of AIC midterm meeting*, pp.418-421.
- Pak, H., C.-S. Lee and J.S. Jang, 2011. The effect of colored LED lighting in the emotional and cognitive responses to affective picture stimuli, *In Proceedings of AIC midterm meeting*, pp.641-644.
- Noguchi, H., and T. Sakaguchi, 1999. Effect of illuminance and color temperature on lowering physiological activity, *Applied Human Science*, 18(4): 117-123.
- Stevenson, R.A., and T.W. James, 2008. Affective auditory stimuli: characterization of the International Affective Digitized Sounds (IADS) by discrete emotional categories, *Behavior Research Methods*, 40(1), pp. 315-321.
- Fairchild, M.D., and L. Reniff, 1995. Time course of chromatic adaptation for color-appearance judgments, *J. Opt. Soc. Am. A*, 12(5), pp. 824-833.

*Address: Prof. Chan-Su Lee & Prof. Jasoong Jang, Department of Electronic Engineering, Yeungnam University, Gyeongsan-si, Gyeongsanbook-do, South Korea*  
*E-mails: light@liftrc.re.kr, chansu@ynu.ac.kr, cat21011@naver.com, jsjang@ynu.ac.kr*



# Colour Appearance Differences for Self-luminous Unrelated Colours with 2° and 10° Field of View

Martijn WITHOUCK, Jeroen WATTEZ, Wouter R. RYCKAERT, Kevin SMET,  
Geert DECONINCK, Peter HANSELAER  
Light & Lighting Laboratory, ESAT/ELECTA, KU Leuven

## ABSTRACT

The difference in visual perception of hue and amount of white (related to colourfulness) of unrelated self-luminous colours with a field of view of 2° and 10° is investigated. For a group of ten observers no differences in hue perception, except for yellow-green, were found. Stimulus size also had no effect on the amount-of-white perceived.

## 1. INTRODUCTION

As CAM97u, a Colour Appearance Model (CAM) for unrelated colours (Hunt 1998), was developed based on 2° stimuli, its validity for stimuli with a larger field of view is uncertain. However objects with a field of view (FOV) larger than 2° often occur in real situations. Fu (Fu et al. 2012) investigated the colour appearance of unrelated colours under photopic and mesopic levels of adaptation for four stimulus sizes (0.5°, 1°, 2° and 10°) and found that the perception of hue is hardly changed when the stimulus size is changed. Xiao (Xiao et al. 2011) investigated changes in colour appearance due to changes in stimulus size (2° and 8°) under various media and viewing conditions but again found no significant effect for hue. However when increasing stimulus size both experiments found an increase of brightness and colourfulness.

As pilot experiments have shown that naïve observers found it difficult to evaluate colourfulness, an alternative with the amount of white was proposed by the authors (Withouck et al. 2012b). Therefore an experiment was set up to check for potential differences in perception of hue, amount of white and brightness due to the size of the FOV of the stimuli. In this experiment, only the hue and amount of white are investigated.

## 2. EXPERIMENTAL SETUP

An experimental setup has been built containing two stimuli of approximately 2° and 10° FOV (see Figure 1, left). The 2° stimulus is presented above the 10° stimulus. The viewing cabinet (74 cm wide, 54 cm high and 32 cm deep) is painted black and a black curtain is used to enclose the environment around the observer to maintain a completely dark surround. A chin rest is used at a distance of 32 cm of the stimuli. The stimuli are made of two identical LED-modules placed behind two holes in the background. The R, G, B intensities of the LED-module are controlled by DMX (a digital communication network to control lighting etc.).

Twenty-two coloured stimuli with a luminance for the CIE 10° observer around 60 cd/m<sup>2</sup> were carefully selected to cover a wide chromaticity gamut (see Figure 1, right). Next to the coloured stimuli, eight achromatic stimuli were chosen in view of the brightness experiment.

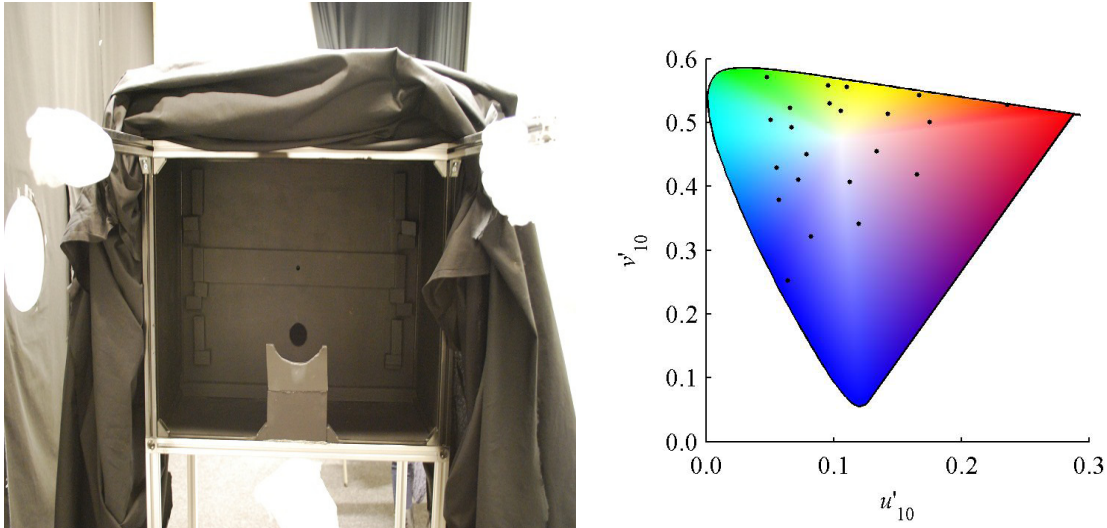

Figure 1: Left; Experimental setup. Right; Chromaticity coordinates of the 22 coloured stimuli plotted in the CIE  $u'_{10}v'_{10}$  chromaticity diagram.

### 3. PSYCHOPHYSICAL EXPERIMENT

In the psychophysical experiment the stimuli were evaluated by ten observers for hue and amount of white using the method described in (Withouck et al. 2012b). The 30 stimuli were randomly presented above and below for 15 seconds, yielding two times 30 estimates for both hue and amount of white for respectively  $2^\circ$  and  $10^\circ$  FOV. All observers, 5 female and 5 male, with ages ranging between 20 and 26 (mean 23) were naïve with respect to the purpose of the experiment. They had normal colour vision according to the Ishihara 24 plate Test for Colour Blindness and the Farnsworth-Munsell 100 Hue test. To investigate hue in this paper only the 22 coloured stimuli were used.

### 4. RESULTS AND DISCUSSION

#### 4.1 Data Analysis

The values for the inter-observer agreement were assessed with the coefficient of variation CV (Luo et al. 1991, Withouck et al. 2012a). The observer agreement ranged from 22% to 49% with a mean of 37% and from 7% to 25% with mean of 11% for the amount of white and the hue respectively (see Table 1).

Table 1. Inter-observer agreement.

CV (%)	Obs 1	Obs 2	Obs 3	Obs 4	Obs 5	Obs 6	Obs 7	Obs 8	Obs 9	Obs 10
Amount of white	22	42	28	31	35	49	39	42	48	33
Hue	8	10	9	25	12	7	7	9	11	12

## 4.2 Results

To compare the two stimulus sizes, the perception of hue and amount of white is averaged for each stimulus. Figure 2, left, shows that the amount of white is perceived to be the same for 2° and 10° stimuli. However, as expected from the high CV values, the error bars (95% confidence interval) are large for this perceptual attribute.

From figure 2, right, it is clear that the hue of the 2° and 10° FOV is only different for the yellow-green stimuli ( $u'_{10}, v'_{10}$  of 0.1859, 0.5589 and 0.1889, 0.5312). The hue of these two yellow-green stimuli were perceived as containing both yellow and green for the 10° FOV. However, for the 2° FOV only green was perceived to be present.

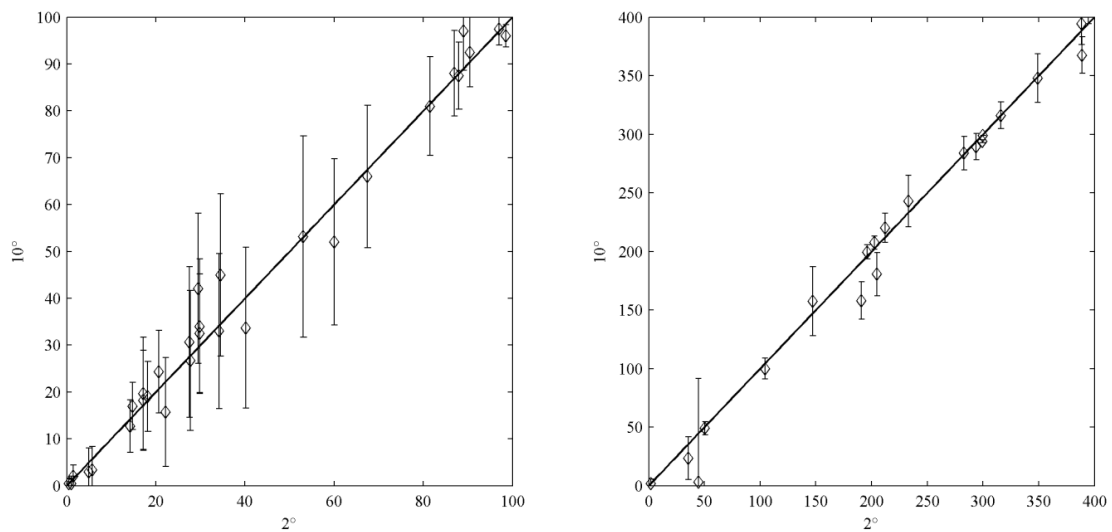

Figure 2: Comparison between 2° and 10° observer data. The 95% confidence intervals are also shown. Left; average amount of white. Right; average hue.

## 5. CONCLUSIONS

The amount of white and the hue of 2° and 10° FOV stimuli are perceived to be the same. Only for yellow-green, a more green hue is perceived for the smallest FOV.

As the confidence interval is large for the amount of white additional experiments are performed with the 2° stimulus below and the 10° stimulus above to ensure an unbiased experiment. Also a brightness matching experiment is carried out between the 2° and 10° stimuli. The results of both these experiments and a more extensive analysis of the current results will be presented in a forthcoming journal publication.

## ACKNOWLEDGEMENTS

The authors would like to thank the Research Council of the KU Leuven for supporting this research project (STIM - OT/11/056).

## REFERENCES

- Fu, Chenyang, Changjun Li, Guihua Cui, M. Ronnier Luo, Robert W.G. Hunt, and Michael R. Pointer, 2012. An investigation of colour appearance for unrelated colours under photopic and mesopic vision. *Color Research & Application* 37 (4):238-254.
- Hunt, R.W.G., 1998. *Measuring colour*. Third ed. Kingston-upon-Thames, England: Fountain Press.
- Luo, M. Ronnier, Anthony A. Clarke, Peter A. Rhodes, André Schappo, Stephen A. R. Scrivener, and Chris J. Tait, 1991. Quantifying colour appearance. Part I. Lutchi colour appearance data. *Color Research & Application* 16 (3):166-180.
- Withouck, M., W. R. Ryckaert, P. De Wilde, G. Deconinck, and P. Hanselaer, 2012a. Age related colour appearance differences for unrelated self-luminous colours. In *CIE 2012 Lighting Quality & Energy Efficiency*. Hangzhou, China.
- Withouck, M., W.R. Ryckaert, K. Smet, and P. Hanselaer, 2012b. Colour Appearance Modelling for self-luminous colours. Paper read at Predicting Perceptions: Proceedings of the 3rd International Conference on Appearance, April 17-19, 2012, at Edinburgh, UK.
- Xiao, Kaida, M. Ronnier Luo, Changjun Li, Guihua Cui, and Dusik Park, 2011. Investigation of colour size effect for colour appearance assessment. *Color Research & Application* 36 (3):201-209.

*Address: Martijn Withouck, Light and Lighting Laboratory, KU Leuven,  
Gebroeders De Smetstraat 1., 9000 Gent, Belgium  
E-mail: martijn.withouck@kahosl.be*

# Author Index

## A

ABDOLSAMADI, Mina 197  
ACIÉN-GERNÁNDEZ, F. Gabriel 759  
AGUILAR, Mariano 1629  
AHMED, Sahar 1709  
AKHTAR, Mahmood 61, 1253  
AKIZUKI, Yuki 1357  
AL-AYASH, Aseel 681  
ALBERT-VANEL, Michel 485, 1181  
ALDHAHIR, Shahin 1677  
ALMEIDA, Pedro 359  
ALMEIDA, Teresa 885  
AL-REYAMI, Ahmed Ben Jomaa 589  
ÁLVARO, Leticia 1593  
AMBALOV, Alexander A. 1117  
AMIRSHAHI, Seyed Ali 993  
AMIRSHAHI, Seyed Hossein 197, 503, 997, 1437, 1465, 1733  
ANGELO, Kine 1637  
ANTONIC, Davor 1353  
ARMITAGE, Joanne 723  
ARNKIL, Harald 969, 697  
ARRIGHETTI, Walter 1081  
ASANO, Yuta 299  
AZEVEDO, Alexandre F. 515

## B

BAAR, Teun 585  
BACHY, Romain 1149  
BAEK, Kyoung Jin 1325  
BAEK, Ye Seul 303  
BAENA-MURILLO, Ernesto 1009  
BAGHCHESSARAEI, Alireza 1517  
BAGHCHESSARAEI, Omid Reza 1517  
BAI, Yi-Ho 123  
BAKKEN, Eskild Narum 547  
BANG, Sungjin 1065  
BARAKZEHI, Marjan 997  
BARANCZUK, Zofia 307  
BARTAFI, Kholoud 1153  
BERGSTROM, Berit 417  
BERMEJO, Ruperto 759  
BERNS, Roy S. 347  
BEZERRA, Roselane 1477  
BIALOBLOCKA, Karolina 235  
BILLAH, Shah M. Reduwan 257  
BILLGER, Monica 673  
BIRTA, Aleksandra 1269  
BJØRNFOT, Anders 547  
BLONDÉ, Laurent 299  
BODART, Matthieu 1021  
BOERI, Cristina 219  
BOKARIS, Panagiotis-Alexandros 1381  
BOLANCA MIRKOVIC, Ivana 1269

BONNARDEL, Valérie 1149  
BOTTERI, Lea 1365  
BRAZ DE OLIVEIRA, M<sup>a</sup> Isabel 779  
BRENGMAN, Malaika 117, 1401  
BROADBENT, Peter J. 249  
BRUSTOLON, Veronica 815  
BURGOS, Fco. Javier 1373, 1729  
BURGOS, Francisco J. 1349, 1545  
BUTTERWORTH, Mick 61, 1253

## C

CALLET, Patrick 877, 905  
CALVO, Ingrid 39  
CAMPOS, Joaquín 581, 1361, 1445  
CAPELLE-LAIZÉ, A.S. 1049  
CARNIE, Bruce W. 1721  
CARRERAS, Josep 92  
CARRON, Jacqueline 1169  
CARVALHO, Cristina 427  
CARVALHO, Joana 799  
CARVALHO SANTOS, Paloma 393  
CASADO, Joaquín 929  
CASCIANI, Daria 771  
CASSIDY, Tom 881, 1721  
CERISE, Remi 905  
CESAR, João Carlos de Oliveira 775  
CHALMERS, Andrew 659, 1433  
CHANG, Chia-Chi 1397  
CHANG, Young Joong 449  
CHARMCHI AVAL, Shirin 1465  
CHAUHAN, Tushar 1109, 1653  
CHEN, Ailin 1381, 1577  
CHEN, Chung-Yun 881  
CHEN, Gaowen 525  
CHEN, Hung-Shing 1645, 1673, 1757  
CHEN, Jun-Hung 1205  
CHEN, Yui-Liang 1037  
CHEON, Jiyun 853  
CHEUNG, Vien 881, 909, 985, 1025, 1029, 1153, 1157, 1641, 1721  
CHOI, Gyoungsil 1529  
CHOI, Gyoung-sil 853  
CHOI, Jung Yeon 1001  
CHOI, Kyungah 1569  
CHORRO, Elísabet 581, 1349, 1373, 1545  
CHOU, Ching-Ju 1757  
CHO, Yang Ho 1085  
CHO, Yunah 1385  
CHRISTIE, Robert 193  
CHU, Alice 423  
CHUANG, Ming-Chuen 1797  
CHUNG, Sarah Hiwon 1553  
CILONA, Andrea 162  
CIORTAN, Irina 1381  
CIRACI, Isabella 1681  
CLARK, Matthew 601, 1033  
CLER, France 833  
CLER, Michel 833  
COHEN, Claire 577

CORDERO, Elisa 405  
CORREIA, Nuno 359  
COSTA, Ana 799  
CRICHTON, Stuart 295, 1069  
CUI, Guihua 525, 533, 1109, 1533, 1537, 1641  
CUTTLE, Christopher 659

## D

DALKE, Hilary 455  
DAL MAS, Giorgio 691  
DA POS, Osvaldo 691, 1681  
DASHTIZADEH, Maryam 1513  
DECONINCK, Geert 1289  
DE FREITAS, Helena 359  
DE LA CRUZ, Vivian M. 1669  
DEL DEGAN, Valeria 1681  
DELLA SANTINA, Siddharta 849  
DE MONTE, Roberta 815  
DENIZET, Philippe 877  
DENZLER, Joachim 993  
DE SILVA, Nimal 143  
DEVINE, Ken 227  
DINET, Eric 677, 1577  
DOI, Motonori 105, 201  
DOVAL, Valero 701  
DUAN, Yiting 1721  
DUBEY, Nijoo 1149  
DURÃO, Maria João 763, 1237  
DUTFIELD, Andrew 261  
DUYAN, Fazıla 977

## E

ECKHARD, Timo 291  
EDSTRÖM, Per 593  
EGERT, Marcia 405  
EJHED, Jan 849  
ELHADY, Ibrahim 1185  
ELMELEGY, Nessreen A. 431

## F

FAIRCHILD, Mark D 271, 299  
FAIRMAN, Hugh 1461  
FAISAL, Saira 601  
FARAJIKHAH, Syamak 1437  
FARHAT, Georges 845  
FARNAND, Susan 271  
FARUP, Ivar 537  
FENG, Yeng-cheng 1749  
FEREDAY, Gwen 1609  
FERNANDEZ-MALOIGNE, Christine 1049, 1121  
FERNÁNDEZ-SEVILLA, J. María 759  
FERRERO, Alejandro 581, 1361, 1445  
FIGUEIRO, Mariana G. 131, 1741  
FINLAYSON, Graham D 275, 1137  
FINLAYSON, Graham D. 1617  
FJIWARA, T. 1761  
FLACK, Zoe 1633

FLEMING, Karen 1693  
FORD, Bruce 35  
FOROUGHMAND, Mostafa 1505  
FOSTER, David H. 633  
FRANKLIN, Anna 1633  
FREYSSINIER, Jean Paul 651, 1725  
FRIDELL ANTER, Karin 673, 1561, 1637  
FRIGO, Oriel 1381  
FUCHIDA, Takayoshi 1345  
FUNT, Brian 507, 1133  
Fuseina MAHAMA 1401

## G

GAMITO, Margarida 647  
GAO, Yuxin 1537  
GARCÍA, Ángela 779, 1261  
GARCÍA-CODONER, Ángela 559  
GARCÍA, José Antonio 65  
GARCÍA, Pedro A. 173  
GASPARINI, Katia 787, 795  
GASTON, Elizabeth 1717  
GBEHOUNOU, Syntyche 1121  
GEORGOULA, Maria 1029  
GHARIRI, Racha 811  
GHOLAMI, Atena 1549  
GIACOMETTI, Alejandro 1809  
GIBSON, Adam 1809  
GILABERT, Eduardo 1009  
GLOGAR, Martinia Ira 1141  
GOETZ, Christian 1017  
GOMEZ, Omar 1545  
GÓMEZ, Omar 1009, 1349, 1373  
GOMEZ-ROBLEDO, Luis 65, 189  
GONG, Rui 1057  
GONG, Shi-Min 101  
GONZÁLEZ, Fernando 1593  
GOORAN, Sasan 597  
GORJI KANDI, Saeideh 1549  
GOTO, Miho 555  
GOUTON, Pierre 1765  
GRANCARIC, Ana Marija 1365  
GREEN-ARMYTAGE, Paul 31, 681, 917  
GREEN, Phil 1453  
GRIBER, Yulia 1525  
GRIES, Thomas 1017  
GUAN, Shing-Sheng 1045, 1201  
GUESTRIN, Julia 423  
GUO, Pan 1605

## H

HACKER, Charles 957  
HAMAZONO, Naoshi 1621  
HANARI, Takashi 113  
HAN, Hyejin 1345  
HANSELAER, Peter 1289  
HAN, Seung-Hee 1405  
HARA, Naoya 541



HARDEBERG, Jon Y. 1317, 1577  
HARDEBERG, Jon Yngve 139, 379, 1665, 1765  
HARKNESS, Nick 1557  
HÅRLEMAN, Maud 493, 673  
HARRIS, Michael 1137  
HAUSER, Carl 249  
HAUTA-KASARI, Markku 677  
HAVAS, Éléonore 901  
HAYN-LEICHSENRING, Gregor Uwe 993  
HEIKKINEN, Ville 371  
HEITMANN, Uwe 1017  
HENNO, Juliana Harrison 953  
HENRY, Philip 1157  
HERMSEN, Connie 75  
HERNÁNDEZ-ANDRÉS, Javier 291  
HERNANZ, María Luisa 581, 1361, 1445  
HERRERA-RAMÍREZ, Jorge A. 1729  
HETTIARACHCHI, Anishka 143  
HIRAI, Keita 355  
HIRDARAMANI, Nikhil 167  
HIRD, Emily 1653  
HIRSCHLER, Robert 515  
HOLDSTOCK, Christine 1417  
HONG, Chi-Chu 109  
HONG, Ji Young 1085  
HONKELA, Timo 697  
HOOVER, Keith 164  
HORIUCHI, Takahiko 355, 1053  
HOROBIN, Richard W. 265  
HOSKINS, Stephen 577  
HOSOKAWA, Natsumi 1041  
HSU, Wei-Chin 1781  
HUANG, Hsin-Pou 123  
HUANG, Min 525, 533, 1533, 1537  
HUANG, Qingmei 1113, 1605  
HUANG, Ting-Wei 1425  
HUERTAS, Rafael 65  
HUETE, María D. 173  
HUMPHREY, Diane 75  
HU, Neng-chung 1749  
HUNG, Hsing-Ju 1697  
HUNG, Shao-Tang 1673  
HUNT, Charles E. 90, 92  
HURLBERT, Anya 611, 1069  
HUTCHINGS, John 61, 445, 1253  
HU, Weigui 1113  
HWANG, Jungsub 1065

## I

IKEDA, Ryo 1457  
IKI, Yukari 607  
IMAI, Francisco 367  
IM, Sangkyun 303  
IÑARRA, Susana 783  
INGTHAISONG, Piyapong 1421  
INKAROJIT, Vorapat 1393  
INOUE, Youko 127  
ISHIDA, Taiichiro 1689

ISHIKAWA, Tomoharu 1713  
ISMAIL, Sumarni Binti 1505  
ISOMÄKI, Hannakaisa 1213  
IYOTA, Hiroyuki 57, 1241  
IZADAN, Hossein 973  
IZAWA, Hiroshi 1221

## J

JAFARI, Razieh 503  
JAIN, Naina 1149  
JANG, In-Su 1341  
JANG, Jasoon 1285  
JARILD-KOBLANCK, Henriette 849  
JEMO, Danijela 1021  
JENKUNAWAT, Somporn 53, 1245  
JENVEY, Fiona 157  
JEONG, Chanung 1753  
JESUS, Rui 359  
JIANG, Shihong 719  
JIN, Yang 1097  
JI, Wei 61, 1253  
JOHNSON, Jerome 905  
JORDAN, Beatrice 497  
JORDAN, Ian 497  
JUGN, Seolkyung 1501  
JUNG, Hyojin 1217  
JUNG, Min-Ho 1033  
JUNG, Yeonhong 663  
JUNIOR, Gérson 945

## K

KAGIMOTO, Akari 1265  
KAKU, Zui 1041  
KALWAROWSKY, Sarah 1625  
KANE, Robert 681  
KANG, Yoojin 1065  
KANHOLT, Magnus 165  
KAN'NO, Misaki 19  
KANTHAK, Thomas 231  
KARATZAS, Dimos 1653  
KASHINO, Kunio 1061, 1785  
KATAYAMA, Ichiro 173, 181  
KATEMAKE, Pichayada 1105, 1473  
KAWANISHI, Takahito 1061  
KAZLAUCIUNAS, Algy 253  
KHAKPOOR, Ali Reza 1513  
KHODEIR, Adel 589  
KHOLINA, Anna A. 1117  
KIEHELÄ, Hanna 441  
KIGLE-BÖCKLER, Gabriele 209  
KIMACHI, Akira 201  
KIM, Chang Yeong 1085  
KIM, Dong-Ho 1541  
KIM, Donghyun 663  
KIM, Hanna 1257, 1377  
KIM, Hea-Yeon 1405  
KIM, Jeffrey 449

KIM, Jin-Seo 177, 1341  
KIM, Kyungjin 1701  
KIMM, Jae Woo 177  
KIM, SeungHyun 1065  
KIM, Soyeon 1701, 1753  
KIM, Yoosun 1193  
KIM, Youngin 1001  
KIM, Young In 449, 1325  
KIM, Yu Hoon 1065  
KINCH, Nicoline 477  
KING, Julie 161  
KIRCHNER, Eric 529, 1073, 1077, 1197  
KIRINO, Fumiyoshi 1493  
KIRK, Joni 1657  
KITAGUCHI, Saori 1217  
KITA, Hideo 1461  
KITSARA, Chrysiida 1641  
KLARÉN, Ulf 989  
KLEMM, Ines 79  
KLIETZING, Tanja 1017  
KMITA, Anna 767  
KOBAYASHI, Masashi 1409, 1489  
KOBAYASI, Mituo 981, 1449, 1661  
KOJIMA, Kazuaki 1221  
KONG, Mário S. Ming 1521  
KONO, Masami 541  
KOUNTOURIS, Kyprianos 877  
KOUTSIDIS, Georgios 61, 1253  
KRANEVELD, Stephanie 397  
KRÜGER, Udo 1777  
KUEPPER, Dennis 307  
KUO, Wen-Guey 109, 1161  
KUO, Yi-Ting 1425, 1797  
KUREČIĆ, Maja Strgar 1093  
KWAK, Youngshin 303  
KWIATKOWSKA-LUBANSKA, Agata 409  
KWON, Jang-Un 1065  
KWON, Soon-Young 177

## L

LADSON, Jack 1461  
LAIA, César A.T. 885  
LANGFELDER, Giacomo 371  
LAPRESTA-FERNÁNDEZ, Alejandro 65  
LAYCOCK, Kevin 715  
LECELLIER, François 1121  
LEDENDAL, Marie 193  
LEDOUX, A. 1049  
LE DUFF, Natacha 901  
LEE, Chan-Su 1281, 1285  
LEE, Chung-Kan 109, 1161  
LEE, Eun Jung 1661  
LEE, Heewon 1377  
LEE, Ho Young 1085  
LEE, Jeongmin 1569  
LEE, Jeongsoo 663  
LEE, Jinsook 1377, 1701, 1753  
LEE, Jin-Sook 1257

LEE, Misun 1529  
 LEE, Song-Woo 177  
 LEE, Tien-Rein 1205  
 LEE, Wen-Yuan 101  
 LEE, Younjin 981  
 LE GONIDEC, Nathalie 905  
 LEMM, Jacqueline 1017  
 LEUNG, Terence S. 719  
 LEWIS, David M. 249  
 LIANG, Ya-Chen 1397  
 LIAO, Ningfang 525, 1113, 1533  
 LIBISH, Carlos 1593  
 LI, Changjun 511  
 LI, Dian 881  
 LI, Hung-Chung 1453  
 LILLO, Julio 1593  
 LIM, Moojong 1065  
 LIMÓN, Piedad 759  
 LINHARES, João 375  
 LIN, Jeng-Jong 1161  
 LIN, Jin-Ling 1037, 1089  
 LIN, Long 601  
 LIN, Shang-Ming 109  
 LIU, Anqing 43  
 LIU, Haoxue 525, 533, 1533, 1537  
 LIU, Nanbo 1113  
 LIU, Peng 1745  
 LIU, Xu 1745  
 LIU, Zhen 1097  
 LI, Wen-Bin 1089  
 LI, Xinyi 1113  
 LLINARES, Carmen 783  
 LLOPIS, Jorge 559, 779, 1261  
 LOGVINENKO, Alexander D. 507  
 LO, Mei-Chun 1037, 1089  
 LOPEZ-RUIZ, Nuria 189  
 LU, Aimin 1113  
 LUCASSEN, Marcel 529  
 LUO, Hung-Wen 1757  
 LUO, Lin 1329, 1769  
 LUO, M Ronnier 61, 463, 511, 525, 533, 1029, 1201, 1253, 1425, 1533, 1537, 1641, 1645, 1673, 1745, 1757,  
 1781  
 LUZZATTO, Lia 1801  
 LY, Minh Hiep 1665

## M

MACDONALD, Lindsay , 701, 623  
 MACEDO, Rita 359  
 MACKIEWICZ, Michal 295  
 MACLURE, Eleanor 705, 1597, 1613  
 MAFFEI, Simone Thereza A. 1237  
 MAGOULES, Frederic 905  
 MAGRIN-CHAGNOLLEAU, Ivan 1481  
 MAHAMA, Fuseina 1401  
 MAHYAR, Forough 973, 985  
 MAJNARIC, Igor 1269  
 MAKI, Kiwamu 97  
 MAMIYA, Yusuke 1241

MANABE, Yoshitsugu 19, 1773  
MANDIĆ, Lidija 1093  
MANN, Ptolemy 170  
MANOHAR, Anitha M. 1277  
MARIJANOVIC, Kristina 379  
MARKOVIC, Zoran 215  
MARTÍNEZ-DOMINGO, Miguel Ángel 371  
MARTINEZ-GARCIA, Juan 1189  
MARTÍNEZ-VERDÚ, Francisco M 581, 1009, 1349, 1373, 1545  
MARTIN, Penelope 1813  
MASTUO, Kousuke 1457  
MASUDA, Osamu 69, 287  
MATSUI, Tatsunori 1221  
MATSUMOTO, Kimio 181  
MATUSIAK, Barbara 1561, 1637  
MAYER, Flávia 469  
MAZAHERI TARI, Mahmood 819  
MCASPURN, Allanna 169  
MCAULIFFE, Marisha 1813  
MCCALLION, Peter 577  
MCCANN, John 733  
MCLEAN, Alex 723  
MEGIAS, Francisco 61, 1253  
MELGOSA, Manuel 173, 189, 525, 533, 537, 759, 1533  
MELO, Maria J. 359  
MENEZES, Marizilda dos Santos 1237  
MESSO, Jyrki 697  
MEYER-HAHN, Gisela 831  
MICÓ, Bàrbara 1009  
MIGLIAVACCA, Giancarlo 1801  
MINAH, Galen 389  
MIRZAEI, Hamidreza 507, 1133  
MIWA, Ryotaro 1773  
MIYAMOTO, Masako 243  
MIYASHITA, T. 1761  
MIZOKAMI, Yoko 607, 1441  
MOHSEN, Reham 1185, 1709  
MONTAGNER, Cristina 359  
MONTALVÁ, Jorge 1629  
MOON, Chaeyun 1193  
MOON, Seungho 1701  
MOORHEAD, Ian R. 709  
MOREIRA DA SILVA, Fernando 551, 647, 1225  
MOREIRA, Humberto 1593  
MORO, Monica 849  
MORRIS, Ian 163  
MOTTRAM, Judith 223  
MOUTINHO, Natacha 763  
MRANGO, Mbonea H. 1333  
MUCKLEJOHN, Stuart 519  
MUKAI, Ryo 1061, 1785  
MÜLLER, Pina 1073  
MURAI, Naoki 135, 1165  
MURAKAMI, Kozaburo 243  
MURAKAMI, Yuri 363  
MURAMATSU, Keiichi 1221  
MURGATROYD, Josef 1417  
MUSMECI, Corrado 1801

MUSSO, Maria Luisa 239  
MUSTAC, Sandra 1269  
MYLONAS, Dimitris 701

## N

NAKAGAWA, Masaya 1689  
NAKAMOTO, Suguru 355  
NAKAMURA, Ryuichi 243  
NAKASHIMA, Wataru 655  
NAKAUCHI, Shigeki 135, 1165  
NAM, Jongwoo 1285  
NA, Nooree 1569  
NARDINI, Marko 1625  
NASCIMENTO, Sergio 69  
NASCIMENTO, Sérgio 287, 359, 375  
NASKAR, Biswajit 1233  
Németh-Vidovszky, Agnes 965  
NETO, Maria 799  
NG, Kia 723  
NIEVES, Juan L. 383  
NIO, Marie 639  
NIRINO, Gabriela 1565  
NISHI, Shogo 201  
NISHIYAMA, Daisuke 1217  
NJO, Lan 529, 1073, 1077  
NODA, Kenta 181  
NORBERG, Ole 593  
NOURY, Larissa 563, 865  
NUSSBAUM, Peter 1637  
NYSTRÖM, Daniel 597

## O

OAKLEY, Beata 615  
OBERASCHER, Leonhard 23  
ODABAŞIOĞLU, Seden 643  
OE, Yuki 127  
OHNO, Haruyo 147, 541  
OHTSUKI, Rie 1337  
OI, Naoyuki 655  
OKAJIMA, Katsunori 1249, 1429, 1621  
OKAMOTO, Ikuko 1409, 1489  
OKAMOTO, Masahiko 181  
OKUDA, Shino 1249, 1265  
OLEN, Melissa 573  
OLGUNTÜRK, Nilgün 643  
OLIVEIRA, Danielle F. 515  
ORLOV, Paul A. 1117  
ORTIZ SEGOVIA, Maria V. 585  
OSUMI, Masayuki 1369, 1493  
OU, Li-Chen 123, 1397, 1697  
OU-YANG, Mang 1425  
OUYANG, Yujie 1097  
OWEN, Angela 611  
OWENS, Huw 1333  
OZAKI, Yuji 135, 1165

## P

PADFIELD, Joseph 91  
PAIS OLIVEIRA, Ana 489  
PAK, Hyensou 1281  
PAK, Hyeonsou 663  
PALMER, Stephen 629  
PANT, Dibakar Raj 537  
PARAC - OSTERMAN, Đurđica 1141  
PARAC-OSTERMAN, Đurđica 1021  
PARADA, Raúl 929  
PARAMEI, Galina 615  
PARK, Du Sik 1085  
PARKER, Andrew 15  
PARKES, Jacqueline H. 83  
PARK, Jiyong 303  
PARK, Jiyong 1701, 1753  
PARK, YungKyung 853, 1385, 1501, 1553  
PARRAMAN, Carinna 223, 573, 577  
PATERA, Marianne 727  
PAULINO, Nuno 885  
PEACOCK, Hayley 1497  
PEARCE, Bradley 295  
PELEGRINA, Antonio 1381  
PERALES, Esther 581, 1009, 1349, 1373, 1545, 1653, 1729  
PERNÃO, João 1005, 1009  
PETIT, Anne 827  
PETRULIS, Andrius 43  
PEYVANDI, Shahram 197, 997, 1465, 1733  
PINHEIRO, Maria Cristina 1225  
PINTO, Sílvia 945  
PIRAWAT, Jirawat 1589  
PIRES de MATOS, António 885  
PLEBE, Alessio 1669  
POBLETE, Francisca 405  
POGACAR, Vojko 869, 937  
POINTER, Michael 1109  
POLJIČAK, Ante 1093  
PONS, Alicia 581, 1361, 1445  
PRADO, Lilia 1593  
PREDA, Razvan Ion 1105, 1473  
PREMIER, Alessandro 567, 787  
PRESEČAN, Iva Hrvatina 1141  
PRESTON, Barry 519  
PUJOL, Jaume 1349, 1373, 1545  
PULTRONE, Dario 1681

## Q

QUEIROZ, Carlos A. 885  
QUEIROZ, Mônica 393  
QUINTAS, Fernando 885

## R

RABAL, Ana M 581, 1361, 1445  
RADANOVIC, Slobodanka 215  
RADMANESH, Azade 1733  
RAHAMAN, G M Atiqur 593  
RAIKE, Antti 697  
RAJA, Kiran B. 1189

RANGEL, Nallely 1229  
RANHAM, Peter 519  
RAO, Swati 1485  
RAVI, Sandhya 949  
REA, Mark 651, 1725  
REA, Mark S. 1741  
REDIES, Christoph 993  
RHODES, Peter A 1033, 1469  
RICHARD, N. 1049  
RIGOUT, Muriel L. 249  
RIPAMONTI, Caterina 1625  
RITANINGSIH, Destiana 1509  
RIU, Pier Paolo 567  
RIVAS, Monica 75  
ROBERT, Pauline 845  
RODRIGUES, Maria do Céu Ferreira 1521  
ROMERO, Javier 65, 291  
ROQUE, Tania 623  
ROSSI, Maurizio 771  
ROSSMAN, Jae 861, 893  
ROSTAMI, Mino 973  
ROY, Ashok 89  
ROY CHOUDHURY, Asim Kumar 1233  
RUEDEL, Ulrich 889  
RUGGABER, Benjamin 1777  
RUIVO, Andreia 885  
RYCKAERT, Wouter R. 1289  
RYU, Ji-seon 1257

## S

SAEDI, Faezeh 1549  
SAHIN, Levent 131  
SAITO, Miho 459, 1705, 1789, 1793  
SAITO, Yusuke 1621  
SAKAGUCHI, Yoshiyuki 1785  
SAKAI, Hideki 57, 105, 1241  
SAKAMAKI, Takeshi 1337  
SAKAMOTO, Takashi 1649  
SAKATA, Katsuaki 1685  
SANTOS, Gabriela 427  
SANTOS, Joaquim 27, 857, 897, 1173  
SASAKI, Kazuya 1713  
SÄTER, Monica 941  
SATO, Kou 1713  
SATO, Masato 555, 639  
SATO, Tetsuya 151, 1217  
SCHANDA, Janos 92, 965  
SCHINDLER, Verena M. 833  
SCHMIDT, Franz 1777  
SCHRÖDER, Ernst 1017  
SCHUMACHER, Jada 961  
SEIDE, Gunnar 1017  
SEMENOVA, Tatiana 401  
SENGA, Ryo 1793  
SENGUPTA, Kaustav 1277  
SENO, Takeharu 655  
SEO, Eun-ji 1257  
SEO, In Kyung 449



SERRA, Juan 559, 779, 783, 1261  
SHAO, Si Jie 1329  
SHAO, Si-Jie 279, 1769  
SHARP, Rachel 913  
SHEN, Hui-Liang 279  
SHIMANO, Noriyuki 1457  
SHIN, Jiyea 1285  
SHIN, Meong-Jin 1413  
SHINOMORI, Keizo 135, 1165  
SHRESTHA, Raju 1317  
SHUR, Michael 1129  
SHUR, Michael S. 43  
SIKIDES, Christos 1189  
SILVA, Ana 1177  
SILVA RAMOS, Marcelo 393  
SILVENNOINEN, Johanna 1213  
SIMÕES, Zélia 473, 1477  
SIMON-LIEDTKE, Joshua Thomas 139  
SIMONNOT, Nathalie 827  
SINGNOO, Jakkarin 275  
SIRET, Daniel 827  
SIVIK, Lars 417  
SKRBINEK, Andrej 869  
SLAVUJ, Radovan 379  
SMET, Kevin 1289  
SMITH, Dianne 681  
SMITH, Ken 873  
SOARES, Helena 837  
SOLE, Aditya 1637  
SOLTIC, Snjezana 1433  
SONG, Jia 383  
SOODSANG, Nirat 1589  
SPROW, Iris 307  
STABILE, Henrique 953  
STAHRE WÄSTBERG, Beata 673  
STANILAND, Michael 727  
STELLUTO, Francesco 691  
STERN, Claudia H. 921  
STEVENS, John 397  
STRGAR KURECIC, Maja 1353  
STUTTERS, Jonathan 701  
STYLIOS, George K 205  
SUÁREZ, Darío 823  
SUD, Shalini 1485  
SUEEPRASAN, Suchitra 151  
SUK, Hyeon-Jeong 1569  
SUNAGA, Shoji 655  
SUN, Pei-Li 1453, 1781  
SUNTHORN, Wanchanok 1581  
SUN, Vincent C. 1205  
SUTCLIFFE, Chris 249  
SUTLOVIC, Ana 1021  
SÜTTERLIN, Josef 1321  
SUWANNAWAJ, Suparug 1589  
SUZUKI, Minoru 1429  
SUZUKI, Taka-aki 135, 1165, 1429  
SUZUKI, Takuzi 19  
SZABÓ, Ferenc 92

## T

TAGUCHI, Satoko 1493  
TAKAHASHI, Shin'ya 113, 1209  
TAKAHASHI, Yoshika 1441  
TAKASHINA, Kenichiro 1357  
TAKAYANAGI, Aki 1785  
TAMURA, Shigeharu 147  
TANAKA, Hiromi T. 1785  
TANAKA, Midori 1053  
TANDY, Valencia 1509  
TANJI, Asami 363  
TANTANATEWIN, Warakul 1393  
TANTCHEVA, Elza 909  
TARAJKO-KOWALSKA, Justyna 791  
TARBUK, Anita 1365  
TAUKADA, N. 1761  
TAVARES, Monica 953  
TEHRAN, Mohammad Amani 1549  
TERRAS, Melissa 1809  
THOMAS, Jean-Baptiste 1765  
TIAN, Gui Yun 1069  
TOMINAGA, Shoji 201, 355, 1053, 1337  
TOMOHIRO, Junko 1357  
TOPPING, Pamela 1693  
TORRES, Ana 559, 779, 783, 1261  
TORTAJADA, Ignacio 1629  
TOWNSEND, Joyce H. 35  
TOWNSHEND, Piers 35  
TRÉMEAU, Alain 677  
TRIRAT, Pratoomtong 53, 1245, 1589  
TROEIRA, Magda 885  
TRONCOSO REY, Perla A. 1617  
TSAI, Cheng-Min 1045, 1201  
TSAI, Wang-Chin 1045  
TSAI, Yi-Chen 1645  
TSANG, Ka Man 1329, 1769  
TSIOUNTA, Margiori 727  
TSUCHIDA, Masaru 1061, 1785  
TSUJIMURA, Sei-ichi 1621  
TSUJI, Ryouta 1713  
TSUMURA, Norimichi 1041  
TSVETKOV, Chavdar 1273  
TUZIKAS, Arūnas 43

## U

UNVER, Rengin 977

## V

VAICEKAUSKAS, Rimantas 43, 1129, 1737  
VALERO, Eva 371  
VALERO, Eva M. 291, 383  
VAN DER LANS, Ivo 1077  
VAN DROOGENBROECK, Ellen 117  
VAN NOORT, Richard 1805  
VARAPASKUL, Teesit 1105  
VAZIRIAN, Marjan 1025  
VETTESE FORSTER, Samantha 193

VEZZANI, Valentina 669  
VIÉNOT, Françoise 93  
VILARIGUES, Marcia 359  
VIQUEIRA, Valentín 1349, 1373, 1545  
VITTA, Pranciškus 43, 1129  
VOLPE, Vanessa 83  
VON WYL, Noëlle 1321  
VOZCHIKOV, Lev 1013  
VRANJKOVIC, Ivana 1353

## W

WAKASUGI, Masahiro 1357  
WAKATA, Tadayuki 1789, 1793  
WALKER, Victoria 435  
WANG, Chao 1125  
WANG, H.H. 1745  
WANG, Qiang 1101  
WANG, Xingbo 1765  
WATANABE, Yasuto 243  
WATTEZ, Jeroen 1289  
WAUTERS, Birgit 1401  
WAYGOOD, Jem 803  
WEBB, Kieron 889  
WEBER, Ralf 231  
WEI, Shuo-Ting 1145  
WEIXEL, Sandra 209  
WEI, Yuh-Chang 109, 1161  
WELLS, Kate 933  
WESTLAND, Stephen 909, 985, 1025, 1153, 1157, 1201, 1389, 1413  
WEYRICH, Tim 1809  
WILD, Clyde 413, 957  
WILD, Francis 413, 957  
WILEY, Robert 885  
WINKLER, Jens-Christian 1017  
WITHOUCK, Martijn 1289  
WITZEL, Christoph 1633  
WON, Sea-hwa 1389  
WOO, Seunghyun 663  
WRIGHT, Angela 481  
WU, Cheng-Yen 1037  
WU, Chin-chuan 1749  
WUERGER, Sophie 511, 619, 1109, 1653  
WU, Jau-Yi 1697

## X

XIAO, Kaida 1109, 1653, 1805  
XIN, John H. 279, 1329, 1769  
XU, Haisong 1057, 1101

## Y

YAGUCHI, Hirohisa 607, 1441  
YAMAGUCHI, Masahiro 363  
YAMAMOTO, Shoji 1041  
YAMATO, Junji 1061, 1785  
YAMAUCHI, Yasuki 1429  
YANG, Danying 205  
YANG, Y. 1745

YATA, Noriko 19, 1773  
YATES, Julian M 1805  
YE, Wei 1125  
YOKOI, Azusa 1705  
YONGE, Melanie 925  
YOO, Jang Jin 1065  
YOSHIMURA, Akiko 1357  
YOSHIZAWA, N. 1761  
YOSHIZAWA, Yosuke 1601  
YOU, Ju-Yeon 1341  
YOU, Tianrong 1125  
YUWANAKORN, Tongta 151

## **Z**

ZAKIZADEH, Roshanak 1189  
ZARDAWI, Faraedon 1805  
ZENG, Li 1585  
ZENNARO, Pietro 685, 787  
ZHANG, Tingting 1101  
ZHANG, Xiandou 1101  
ZHANG, Yaoju 525, 1533, 1537  
ZHAO, Dazun 1605  
ZHENG, Chongwei 525, 1533, 1537  
ZHENG, Xiongzong 1101  
ZHENG, Zhenrong 1745  
ZITINSKI ELIAS, Paula 597  
ZOLLIKER, Peter 307  
ZUCCOLI, Franca 1573  
Žukauskas, Artūras 1737  
ŽUKAUSKAS, Artūras 43, 1129

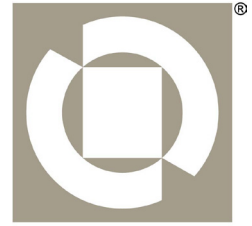

SPECTRAL EDGE



WILEY

The Colour Ministry

Holistic Light & Colour Specialists  
Courses, Readings & Sacred Ceremony



THE HEART OF COLOUR





© 2013 The Colour Group (Great Britain)  
[www.colour.org.uk](http://www.colour.org.uk)  
All rights reserved.



#### DISCLAIMER

Matters of copyright for all images and text associated with the papers within the AIC2013 Conference Proceedings and Book of Abstracts are the responsibility of the authors. The AIC and Colour Group do not accept responsibility for any liabilities arising from the publication of any of the submissions.

#### COPYRIGHT

Reproduction of this document or parts thereof by any means whatsoever is prohibited without the written permission of The Colour Group (Great Britain). All copies of the individual articles remain the intellectual property of the individual authors and/or their affiliated institutions.

ISBN 978-0901623027

Editors: Lindsay MacDonald, Stephen Westland and Sophie Wuerger