



# Proceedings of the International Colour Association (AIC) Conference 2021

Milan (Italy), August 30<sup>th</sup> - September 3<sup>rd</sup> 2021



Published by  
**International Colour Association (AIC)**



Sponsored by  
**Gruppo del Colore**  
(Associazione Italiana Colore)



© 2021 International Colour Association (AIC) International Colour Association Incorporated  
PO Box 764  
Newtown NSW 2042  
Australia  
[www.aic-colour.org](http://www.aic-colour.org)  
All rights reserved.

## **DISCLAIMER**

Matters of copyright for all images and text associated with the papers within the Proceedings of the International Colour Association (AIC) 2021 are the responsibility of the authors. The AIC does not accept responsibility for any liabilities arising from the publication of any of the submissions.

## **COPYRIGHT**

Reproduction of this document or parts thereof by any means whatsoever is prohibited without the written permission of the International Colour Association (AIC). All copies of the individual articles remain the intellectual property of the individual authors and/or their affiliated institutions.

ISBN: 978-0-6484724-3-8  
eISSN: 2617-2429  
ISSN: 2617-2410

## **HOW TO CITE THIS BOOK**

AIC (International Colour Association). 2021. Proceedings of the International Colour Association (AIC) Conference 2021. Milan, Italy. AIC.  
How to cite an article included in this book:  
Author's name. 2021. Title of the article. In: Proceedings of the International Colour Association (AIC) Conference 2021. Milan, Italy. AIC, page numbers of the article.





## INDEX

<b>AIC President's Message</b>	<b>11</b>
2020-2021 EXECUTIVE COMMITTEE	13
<b>AIC 14<sup>th</sup> Congress Milano 2021</b>	<b>15</b>
Gruppo del Colore-Associazione Italiana Colore President's Message	15
The AIC2021 14 <sup>th</sup> Congress - Chairs introduction	17
<b>AIC 14<sup>th</sup> Congress Milano 2021 is organized by Gruppo del Colore – Associazione Italiana Colore</b>	
GENERAL CHAIRS	19
ORGANIZING COMMITTEES	19
SCIENTIFIC PEER REVIEW COMMITTEE	20
SPONSORS	25
PATRONAGE	25
<b>CALL FOR PAPERS</b>	<b>26</b>
<b>PROGRAM AT A GLANCE</b>	<b>29</b>
<b>SCIENTIFIC PROGRAM</b>	<b>30</b>
Monday August 30 <sup>th</sup> , 2021 (single session)	30
Tuesday August 31 <sup>st</sup> , 2021 (2 parallel sessions)	34
Wednesday September 1 <sup>st</sup> , 2021 (2 parallel sessions)	41
Thursday September 2 <sup>nd</sup> , 2021 (2 parallel sessions)	50
Friday September 3 <sup>rd</sup> , 2021 (single session)	59
<b>INVITED LECTURES</b>	<b>64</b>
Color deficient see this way ... Or don't they?	64
The influence of cfa choice on automotive and other critical imaging systems	64
Color in fashion design	65
Conservation science and changing colours - approaches to measuring and managing change	66
Lighting and color design in the show	66
Leonardo's colour today: from the dark to the light	67
Chromatic sustainability: a new approach to color design	68
<b>AWARD LECTURES</b>	<b>69</b>
AIC Award for Colour in Art, Design and Environment (CADE) 2021	69
Citation - Jean-Philippe Lenclos: AIC Award for Colour in Art, Design and Environment 2021 recipient	69
AIC CADE Award Lecture	69
AIC Deane B. Judd Award 2021	70
Citation - John McCann: AIC Deane B. Judd Award 2021 recipient	70
AIC Judd Award Lecture	70
<b>PREMIO COLORE GdC – Associazione Italiana Colore 2021</b>	<b>71</b>



<b>INVITED LECTURES</b>	<b>73</b>
Robin Jenkin - "The influence of CFA choice on automotive and other critical imaging systems"	75
Pietro Marani - "Leonardo's color today: from the dark to the light"	85
Clino Trini Castelli - "Umbrella Diagram - 1981-2021, four decades of forecasts and CMF design"	97
<b>AWARDS</b>	<b>103</b>
Jean-Philippe Lenclos - CADE Award Lecture: Living in colour - Vivre en couleur	105
John McCann - Judd Award Lecture: Color Vision responds to Natural Scenes: Roles of Glare, Receptor Quanta Catch, and Neural Spatial Comparisons	117
<b>COLOR AND MEASUREMENT / INSTRUMENTATION</b>	<b>129</b>
Kanoko Makino, Kaoruko Kitamura, Haruno Tsuda, Yuki Oe, Nozomu Yoshizawa - Colour appearance of a white space with greenish daylight	131
Shimpei Fukagawa, Hiroyuki Iyota, Hideki Sakai, Mai Isomi - Development of color and gloss measurement system with wide-range temperature and humidity control unit	137
Pei-Li Sun, Raymond Chiang - Identify the characteristics of optically variable inks with deep learning	143
Shuheji Watanabe, Takahiko Horiuchi - Estimation of authenticity model considering the colour: Leather as a case study	149
Jiaxun Zhang, Haisong Xu, Hao Jiang - Cross-media color reproduction under mixed adaptation condition	155
Ye Zhang, Kaiyin Chen, Shulei Ma - Study on colour effect of transparent material under colour-light	161
Qinyuan Li, Jinxing Liang, Yan Lu, Kaida Xiao, Michael Pointer - Quantification of the effect of colour appearance and materials on the visual-tactile properties of fabrics	167
Shahin Aldhahir - Differential Color Perception Theory	173
Esther Perales, Andrea Morales, Alejandro Ferrero, Juan Carlos Fernández-Becáres, Marjetka Milosovic, Joaquin Campos, Khalil Huraibat, Jorge Pérez, Valentín Viqueira - Impact of the color hue on the sparkle perception	179
Khalil Huraibat, Esther Perales, Eric Kirchner, Ivo Van der Lans, Alejandro Ferrero, Joaquín Campos - Multiangle visual validation of a physically based rendering of goniochromatic colors	185
Rada Deeb, Graham Finlayson - The Locus Filter	191
<b>COLOR AND DIGITAL</b>	<b>197</b>
Yiming Huang, Haisong Xu, Zhengnan Ye - HDR image quality evaluation for mobile displays	199
Li Yumei, Liao Ningfang, Wu Wenmin, Deng Chenyang, Li Yasheng - Research on HDR image tone mapping algorithm based on modified ICAM06	203
Sandhiya Jayaprakash Brindha, Monica Vatteroni, Gabriele Simone - HDR imaging using CMOS technology inspired by human eyes for Automotive applications	209
Yi-Tun Lin, Graham Finlayson - Recovering Real-World Spectra from RGB Images under Radiance Mondrian-World Assumption	215
Pengpeng Yao, Jack Hc Wu, John Xin - The use of LED-based illumination for Multispectral Imaging System	221
Cristian Bonanomi, Kedar Sathaye - Imaging colorimeters to evaluate Camera Monitor Systems	227
Simone Bianco, Marco Buzzelli, Gianluigi Ciocca, Raimondo Schettini, Mikhail Tchobanov, Simone Zini - Analysis of Biases in Automatic White Balance Datasets	233
Chloe Game, Michael Thompson, Graham Finlayson - Chromatic Weibull Tone Mapping for Underwater Image Enhancement	239
Marco Buzzelli, Simone Bianco, Raimondo Schettini - Angle-Retaining Color Space for Color Data Visualization and Analysis	245
Ana Belén López-Baldomero, Manuel Rubiño, Carolina Ortiz, Carlos Salas - Comparison of color gamuts generated by digital printing devices under different conditions	251
Alfonso De Lucas Tron - The perceptual calibration of color. An exploration	257
Hao Cui, Renzo Shamey - Diagnosis of Psoriasis using image segmentation and deep learning	263
Yuteng Zhu, Graham Finlayson - Designing a Single Pre-filter for Making a Group of Cameras more Colorimetric	269
Jake McVey, Graham Finlayson - Fast and Optimal Contrast Limited Tone Mapping	275
Arjan Gijzenij, Peter Spiers, Stephen Westland, Pim Koeckhoven - Deriving representative color palettes from mood board images	282



Emilie Robert, Magali Estribeau, Rémi Barbier, Gregory Swiathy, Justin Plantier, Pierre Magnan - Impact of the training data used in LLS optimization for faithful scene-specific color correction of raw images	287
Barbara Blaznik, Franci Kovač, Grega Bizjak, Sabina Bračko - Fastness of black dye-based ink-jet printing inks in aqueous solution in the presence and absence of oxygen	293
Brandon Hogley, Graham Finlayson, Michal Mackiewicz, Julie Bremner, Tony Dolphin, Riccardo Arosio - Improving image registration using colour transfer methods in remote sensing applications	299
Pedro Pardo, Francisco Díaz Barrancas, Halina Cwierz López - Color Constancy in virtual reality scenes. A first step toward a color appearance model in virtual reality	305
Marisol Fernández-Carvelo, Miguel Angel Martinez-Domingo, Eva M. Valero, Juan Luis Nieves, Javier Romero, Javier Hernández-Andrés - Band selection for different dehazing algorithms in the visible range	311
<b>COLOR AND LIGHTING</b>	<b>317</b>
Maurizio Rossi - A proposal for the definition of colored light sources in lighting CAD	319
Laura Bellia, Francesca Diglio, Francesca Fragliasso - Lighting quality for home-working spaces: a survey	325
Laura Bellia, Urszula Błaszczak, Francesca Fragliasso, Lukasz Gryko - The colours of light in indoor environments: Mixing daylight and electric light spectra to define a proper match	331
Hyeonju Park, Hyeon-Jeong Suk - Design Guidelines for Light Interfaces of Home Appliances	337
Jingyi Lin, Keyu Shi, Ming Ronnier Luo - Colour Performance Evaluation for LED Simulator Technology	343
Stine Louring Nielsen, Emma-Sofie Hestbech, Nanna Hasle Bak, Michael Mullins - Moving in Colour Illuminated Space: An Exploration of Analysis	349
Ayse Nihan Avci, Saadet Akbay - OLED Lighting and Human Circadian System: A Review	355
Lorrain Caumon, Georges Zissis, Céline Caumon, Élodie Bécheras, Estelle Guerry, Christelle Infantes - Colours, light and well-being: characterisation of chromatic phenomena in collective housing	361
Andrea Siniscalco - A design approach to lighting and color rendering in indoor sets	367
Mengyuan Chen, Stephen Westland - User acceptance of innovative blue light therapy to treat seasonal affective disorder	373
Oscar Santilli - Colored light shapes. Protect and enhance the colors of artworks	379
<b>COLOR AND PHYSIOLOGY</b>	<b>385</b>
Kota Akiba, Midori Tanaka, Takahiko Horiuchi - Effect of ipRGC on Colour Perception of Display Device under Various Illuminants	387
Miyoshi Ayama, Minoru Ohkoba, Tomoharu Ishikawa, Shoko Hira, Sakuichi Ohtsuka - Difference Scaling and Color Naming of Red-Green Color Deficiencies	393
Firdevs Gökmenoğlu, Saadet Akbay - Effects of Colour on the Sense of Immersion in Virtual Interior Environments	399
Hideki Sakai - Brightness evaluation under the closed-eye condition: Measurement of optical transmittance of eyelid	403
Taesu Kim, Hyeon-Jeong Suk - EEG Responses to In-Car Dynamic Cluster Light	409
Francisco Díaz-Barrancas, Halina Cwierz, Pedro José Pardo - A study of physical and perceived linearity in a virtual reality environment	415
Kari Bjerke Gjørde, Anne Kristin Kvitle, Phil Green, Peter Nussbaum - How accurate is an on-line test for colour vision deficiency?	421
Laura Rey-Barroso, Mónica Roldán, Francisco J. Burgos-Fernández, Susanna Gassiot, Anna Ruiz Llobet, Ignacio Isola, Meritxell Vilaseca - Evaluation of Confocal Microscopy as a Diagnosis Tool on Red Blood Cell Diseases	428
Kazim Hilmi Or - A specific use of colour and dyes: "Vital dyes in ophthalmology"	433
Marisa Rodriguez-Carmona, Benjamin E. W. Evans, John L. Barbur - Assessing colour vision using single and multi test protocols	437
Flávia Mayer - The Construction Of Color By The Congenitally Blind	443
Francisco J. Burgos-Fernández, Tommaso Alterini, Fernando Díaz-Doutón, Meritxell Vilaseca - Colorimetric analysis of eye fundus structures with multispectral retinography	449
<b>COLOR AND PSYCHOLOGY</b>	<b>455</b>
Mahshid Baniani - What color is your mood? The association between moods and colors	457
Jinyoung Kim, Jiyeon Lee, Yungkyung Park - Why are common nature colors (soil, sand, trees, sky, stones, etc.) useful? Why does it go well with all colors?	463
Byeongjin Kim, Taesu Kim, Hyeon-Jeong Suk - Comfortable Brightness for Watching Television in the Dark	469



Akira Asano, Ayaka Shimura, Chie Muraki Asano - Effect of red color and external interferences in selection tasks	475
Ray-Chin Wu, Chao-Lung Lee, Ming-Hsiu Mia Chen, Chien-Wei Chang, Yun-Maw Cheng - A study on colour emotions of the mask	481
Andrew Chalmers - Is "Naturalness" a valid lighting concept	485
Yoonjeong Jo, Yungkyung Park - Changes in Color Appearance and Preference of Rose Affected by Color Temperature and Illuminance	491
Ichiro Katayama, Kin'nosuke Yamaji - Effect of the shade due to the surface unevenness of objects on whiteness perception	497
Muhammad Farhan Mughal, Ming Ronnier Luo, Michael R. Pointer - Perceived attractiveness across Chinese and Pakistani ethnic groups	503
Tzuhao Liu, John Hutchings, Ming Ronnier Luo - The Valence and Arousal contribution of colour parameters	510
Rui Vasques, António José Macedo Coutinho da Cruz Rodrigues, Diamantino S. Abreu - Visual and sensory perceptions between static and dynamic colors	515
Pia Lopez-Izquierdo - The Emotional Language of Colour	521
Sachiko Noguchi, Rumiko Takata, Kaori Segawa, Ichiro Katayama - Application of color feelings prediction formulas to the estimation of two-color combination feelings of "kimono"	527
Shi-Min Gong, Wen-Yuan Lee - Color Preference for Color Combinations Applied onto Three-Dimensional Color Configuration	533
Alessandro Bortolotti, Loreta Cannito, Stefano Anzani, Riccardo Palumbo, Maurizio Rossi - Lighting emotions: a review of the emotional influence of color perceived lightness	539
Anna Marotta, Alessandra Brosio - Color as a therapeutic adjuvant: theories and applications in the hospital setting	545
Barbara Matusiak, Marzieh Nazari, Kine Angelo - Colour shift due to Chromogenic dynamic glass	551
Juan Serra, David De Andrés, Ana Torres - ColorDoku 3d, gamification to improve perceptual color discrimination ability and spatial vision	558
Katherine Carpenter, Susan Farnand - Determination of the Representative Color of a Smartphone Image	563
Nian Xiong, Henry J. Trussell, Renzo Shamey - Psychophysical Study of the Perception of Color Gradient Boundaries	569

## **COLOR AND PRODUCTION 575**

Vesna Marija Potočić Matković, Ana Sutlovic, Martinia Ira Glogar - Colour fading in the polyurethane coating depending on the substrate and conditions of natural weathering	577
Ji Eun Lee - Evaluation of Emotional Images According to Differences in Post-processing of Plastic Cosmetics Containers	583
Georgina Ortiz Hernández, Citlali Q. Ortiz Hernández, Oscar Francisco Bustamante - Shape, Color and Meanings. Comparison of Two Studies	589

## **COLOR AND RESTORATION 596**

Junglim Lee, Yungkyung Park - Colour Prediction Method of Digitalized Korean Court Documentary Painting	598
Wensi Lin, Mengyue Zhang, Jisheng Wang, Mengqi Li, Jing Chen - The Experimental Restoration of the Colour of Nanjing Brocade from China	603
Yuton Jiang, Luke Li, Yihua Zheng - Quantitative color examination and restoration of historical architecture: the study of polychrome decoration of a Qing-style timber-frame structure in Tsinghua University (Beijing, China)	609
Martina Redi, Sofia Ceccarelli, Alessandra Terrei, Noemi Orazi, Fulvio Mercuri - Diagnostic analysis for colour restoration of a painted Japanese emakimono	615
Marcello Picollo, Costanza Cucci, Andrea Casini, Filippo Cherubini, Lorenzo Stefani - Hyper-Spectral Imaging Technique: Application for Colorimetric Analysis of Paintings	621
Guido Frison, Maurizio Aceto, Angelo Agostino, Dimitris Mylonas, Alberto Calatroni - Spectrographic analysis of the colourants of cultural items: from a qualitative to a semi-quantitative data treatment through BCTs	627
Jimena Vanina Odetti, Alberto Reyes González - Color, landscape and cultural heritage. The case of the Pitillal river, in Puerto Vallarta, Jalisco, Mexico.	633
Olivia Kuzio, Susan Farnand - LED-based versus Filter-based Multispectral Imaging Methods for Museum Studio Photography	639
Eric Kirchner, Carola van Wijk, Henni van Beek, Tammo Koster, Pim Koeckhoven - A new target to test color accuracy in technical photography of fine arts	645



Hortense de La Codre, Charlotte Marembert, Rémy Chapoulie, Laurent Servant, Aurélie Mounier - Hyperspectral mapping (VIS-SWIR) of materials of three 18th C. tapestries of Royal Manufactures in France (Gobelins, Beauvais, Aubusson)	651
Márcia Hazin, João Pernão - The NCS color notation as a guide to produce colors from traditional pigments in conservation: The case study of two painted ceilings from eighteenth-Century Churches in colonial Brasil	653
Ângela Santos, Vanessa Otero, Márcia Vilarigues Colours of pre-cinema projections: the evolution of hand-painted magic lantern glass slides' palette	659

## **COLOR AND BUILT ENVIRONMENT 666**

Jean-Luc Capron - Spatio-temporal Factors of Colored Light Sequences in the Built Environment: the case of a choral concert – Part One	668
Camilla Giani, Cristina Boeri - Children's colour preferences in the school context	673
Estelle Guerry - Prehension and qualification of chromatic and lighting environment. Study case – Paimio Sanatorium, Alvar Aalto	679
Justyna Tarajko-Kowalska - Is "yellow house" really "yellow"? Survey on determining the range of perceiving the yellow color on building facades depending on the hue, lightness and chroma	685
Ana Sutlović, Martinia Ira Glogar, Ivana Padavić, Koraljka Kovač Dugandžić - Plant Transfer Printing on Cotton and Silk	691
Sari Yamamoto - Practice-based research on color planning for educational facilities	697
Asako Nakamura, Fabrizio I. Apollonio, Marco Gaiani - Urban color mapping in Tokyo: the case study of Hillside terrace	703
Lanqing Gu, Adamantia Batistatou, Yvonne N. Delevoye-Turrell, Jenny Roe, Martin Knöll - Using artificial ground color to promote a restorative sidewalk experience: an experimental study based on manipulated street view images	709
Changying Xiang, Barbara Szybinska Matusiak - Aesthetic Evaluation of Facade Integrated Coloured Photovoltaics Designs-an International Online Survey	715
Esra Küçükkılıç Özcan, Fatma Rengin Ünver - A screen experiment on the assesment of façade colour perception factors	722
Patrizia Falzone - Complexity of the theme of the Painted Façades in the large and medium historical centers in relation to the environmental contexts to which they belong	727
Doreen Balabanoff - Colour and Design of Birth Spaces: A transdisciplinary review of the literature	733
Zhaohua Lei, Fabrizio I. Apollonio, Marco Gaiani - A multiscale approach to the urban space color analysis starting from the case of study of the Collegio di Milano	739
Filippo Cherubini, Andrea Casini, Costanza Cucci, Marcello Picollo, Lorenzo Stefani - Application of hyperspectral camera and spectroradiometer for spectroscopic and colorimetric measurements on polychrome surfaces in a controlled environment: pros and cons of the presented technologies	745
Jorge Llopis, Juan Serra, Irene De la Torre - Color, ceramics and architecture in the Spanish Renaissance. Serlian serial ceramics and their role in the construction of a new spatiality	751
Beichen Yu, Simon Bell, Giorgio Ponso - The emerging trend of saturated colour in the contemporary urban environment: an updated view of colour	757
Ralf Weber, Kine Angelo, Thomas Kanthak, Maya Weber - A Color Inventory of and a Color Guide to Dresden's Neustadt	763
Francesca Salvetti, Michela Scaglione - The use of color in the urban landscape through regeneration projects of the degraded open spaces of the city	769
Margherita Cicala, Luciano Lauda - The color in the street art of Gianluca Raro and Fabio Biodpi: between social impact and urban periphery in Scampia	775

## **COLOR AND DESIGN 781**

Aigerim Shunayeva, Taesu Kim, Bokyoung Lee, Hyeon-Jeong Suk - Style assessment of home appliances in various interiors using virtual reality	783
Gyunpyo Lee, Taesu Kim, Hyeon-Jeong Suk - Is Blue still a Representative for Future Vehicles?	789
Boram Kim, Hyeon-Jeong Suk - Visualization of chair color data through network analysis	795
Terumi Konno, Koichiro Kakiyama, Yasuhiro Kawabata - Observed changes in garment color selection of university students across normal and test periods	801
Masato Sakurai, Ryoma Yamamoto - Relationship Between Taste Impression and Color in Snack Packages	807
Tomoharu Ishikawa, Takumi Nakajima, Yoshiko Yanagida, Minoru Mitsui, Kazuya Sasaki, Miyoshi Ayama - Effect of Sensation Modalities on Texture Evaluation of Beige Fabrics by Japanese and Chinese	813



Yumi Awano, Masayuki Osumi - The visual effect of costume woven with peacock feathers and the symbolism in Japanese culture - Evaluation derived from gonio-photometric spectrum analysis and microscopic observation	818
Eunji Han, Yungkyung Park - A study on associative color attributes of Antonyms in Korean language	823
Agata Kwiatkowska-Lubańska - Colour and ornament in the Polish Art Deco style. Karol Homolacs and his colour course at the Cracow Workshops 1913-1926	828
Verena M. Schindler, Yulia A. Griber - The evolution of environmental colour design in the French period	833
Anna Kmita - CMF in commemorative ceramics. Project of a color and texture palette on the example of "Ckliwe na szklwie"- Nostalgic Glaze. Personal collection of memories on ceramic plates.	837
Marcus Farr, Andrea Macruz - Colored Response: Technology, Thermo-chromic Material Systems and Human Awareness	843
Francesco Scullica, Elena Elgani, Umberto Monchiero - The relevance of color in post COVID-19 interior design	849
Anna Barbara, Reejy Atef Abdelatty Mikhail, Maria Camila Álvarez García - The Odor of Colors: Correspondence from a Cross-Cultural Design Perspective	855
Gyeonghwa Lee, Vien Cheung, Tang Tang - - The role of colour designers in the design process	861
Michel Albert-Vanel - Combinations of colours as an analogue model in Modern Art	867
Gisela Costa Pinheiro Monteiro, Robert Hirschler - A mount-it-yourself 3D colour model for designers	873
Ingrid Calvo Ivanovic, Marta Elisa Cecchi, Clorinda Sissi Galasso, Ambra Borin, Claudia Mastrantoni, Martina Scagnoli - The Colours of Individual and Collective Memory: Mnemosphere, a Visual Atlas of Memory, Emotions and Atmosphere of Places	879
Luwen Yu, Stephen Westland, Vien Cheung, Guobin Xia - Analysis of research strategies to determine colour preference II: AFC, rank-order and rating	885
Déborah Epicoco, Christine Mohr, Mari Uusküla, Michael Quiblier, Maliha Bouayed Meziane, Eric Laurent, Domicela Jonauskaitė - Making sense of free associations with PURPLE – A new coding scheme testing French speakers in three countries	891
Inez Michiels - Design Semantics Database	897
Martinia Ira Glogar, Sandra Flinčec Grgac, Antonia Zanchi Sarwari, Jose M. Canal - Interaction of Colour and Cotton Fabric Surface Coated with Ultrafine Cellulose (UFC)	903
Guobin Xia, Philip Henry, Francisco Queiroz, Stephen Westland, Luwen Yu - Colour–cognitive performance interaction in Virtual Reality (VR): A study of gender differences	909
Delia Dumitrescu, Marjan Kooroshnia, Erin Lewis, Kathryn Walters - Colour, texture, and luminance: Textile design methods for printing with electroluminescent inks	915
Elizaveta Kushnirenko - Color in Fashion Design: orange that changed our perception of Luxury - the use of color at Hermès Paris	921
Xuechang Leng - The meaning of blue-green tiles on the roofs of the Qinzhen Hall complex at the Summer Palace	927
Rebecka Pires - Application of color in domestic interior design: an analysis of the 1960s, 1970s and 1980s	933
Gianluca Guarini, Maurizio Rossi - Procedure to obtain trustful colors in renderings produced by BIM	939
Ana Paula Pinheiro, Rui Duharte - Color and Sustainability in Fashion Design: DUARTE, Portugal	945

## COLOR AND CULTURE

951

Martino Pavignano, Ursula Zich - Colour, material and prototyping for Architecture	953
Enrico Zampieri, Vincenzo Baldoni, Simone Garagnani, Andrea Gaucci, Michele Silani - Digital reproduction of colors and materials used in pottery: a case study from the ancient Picenum	959
Marcela Sepúlveda - Polychromy from the Atacama Desert (South America). An interdisciplinary approach for an archaeology of color	965
Camilla Tartaglia - The hidden history of woad blue: a path through technology and diffusion of "European indigo" in 18 <sup>th</sup> -century technical literature	971
Qian Huang - A Study on the Color of Miao's Badai Culture in Fenghuang County of China	977
Zoriana Lotut - Reading Medieval Colour. The Case of Blue in the Canterbury Tales	983
Xiaochan Ge, Xue Mao, Jie Xu - Identifying the colour of Longquan Celadon Porcelain	989
Lia Luzzatto - Colors in the feminine between the Middle Ages and the Renaissance	993
Renata Pompas - Chagall e Malevič: the colors of the imagination and the colors of the absolute	999
Dimitris Mylonas, Alexandros Kolioussis, Mari Uusküla - Synonymy in the language of colour	1005
Letizia Bollini, Martina Falta - Brides in black widows in white. Semantic evolution of the social and cultural meaning of the colours	1011
Yulia A. Griber, Dimitris Mylonas, Galina Pamei - Age-related differences in richness and diversity of Russian color lexicon	1017
Anna Marotta, Rossana Netti - Knowledge as a project parameter: comparative colour theories	1023





Anna Marotta - Scientific basics in art from the Theories of Color: Authors, methods, rules, applications	1029
Cristiana Bartolomei, Cecilia Mazzoli, Caterina Morganti - The building materials of Luis Barragán: light and colour	1035
Joaquim Santos - Tili Wiru Tjuta Nyakutjaku - Towards an Extensive Cultural Paradigm	1041
Mark D. Fairchild - System for Visual Assessment of Wine Color	1047
Petronio Bendito - Algorithmic Color Methods of Media Arts	1053
Zhaohua Lei, Elza Tantcheva-Burdge, Vien Cheung - Investigation into the Colours of the DunHuang Murals from the Tang Dynasty	1060
Henriette Jarild Koblanck, Monica Moro - Straw/Light – Colour	1065

## **COLOR AND EDUCATION 1071**

David Briggs - More than Three Dimensions: Communicating the Attributes of Colour Perception in Colour Education	1073
Ching Chih Liao - Analysis and Application of Artwork Color - Awakening Students' Color Aesthetics and Narrative Ability through Artworks at the National Palace Museum in Taipei	1079
Woon Lam Ng - Factors that Influence Color Choice – A Study of Cultural, Symbolical and Synesthetic Behaviors	1085
Gülru Mutlu Tunca, Saadet Akbay, Güler Ufuk Demirbaş - Parametric Design Studio in Interior Architecture Education: A Case of Integration of Colour Design	1091
Paul Green-Armytage, Maggie Maggio - Beyond the Rainbow: A New Sorting Set for Teaching colour	1097
Lea Jeong, Yungkyung Park - Color Names Education Effect on the Color Range Recognition	1103
Jihye Choi, Paolo Calafiore - Colorful safety guide	1109
Junior Vendrami, Marley de Lira, Berenice Gonçalves - Educational resources based on augmented reality applied to Color Theory contents / UFSC	1115
Berta Martini, Rossella D'Ugo, Monica Tombolato - Teaching and learning color. An insight into STEM/STEAM approach	1121
Caroline Bouchez, Blandine Chorein, Dominique Corger - Color and Polymers at ITECH	1127
Saara Pyykkö - How to convert the experience-based university course about colour, light and space for the web?	1134
Franca Zuccoli - Mario Lodi: "Children's colours are festive, flamboyant, vivid colours"	1139
Flora Gaetani, Fausto Brevi, Donatella Balloni - Colour proposals consistency in the CMF for car design education	1145
Craig Kirkwood - We don't know Jack about Hue: the Colour Knowledge Survey	1152

## **COLOR AND COMMUNICATION / MARKETING 1157**

Zena O'Connor - Data visualization: The power and persuasive capacity of color	1159
Qinyue Chen, Yuchun Yan, Hyeon-Jeong Suk - Designing Voice-Aware Text in Voice Media with Background Color and Typography	1165
Boshuo Guo, Stephen Westland, Peihua Lai - Sentiment Analysis Based on Frequency of Colour Names on Social Media	1171
Daniela F. Pinheiro, Teresa Almeida, Domingos Loureiro - Color Specificity: the perception of difference through exhausting repetition	1177
Anica Hunjet, Sandra Križan, Dijana Vuković - Influence of wine color on wine selection and consumption	1183
Lidija Mandić, Maja Strgar Kurečić - The role and significance of color when choosing cars	1189
Peihua Lai, Boshuo Guo, Stephen Westland - Why do people choose their car colours?	1195

## **SPECIAL SESSIONS 1201**

### **INNOVATION AND RESEARCH IN COLOR FOR BEAUTY CARE AND HAIRSTYLE 1201**

Christine Fernandez-Maloigne - History of colors and beauty	1203
Helene De Clermont-Gallerande - A comparative study of lipstick shades preferences by geographical area	1209
Isabel Espinosa Zaragoza - Parallelism as advertising strategy in Maybelline's lipstick colour names	1215
Yuchun Yan, Hyeon-Jeong Suk - Fifty Shades of Beige: An Analysis on the Color System for Liquid Foundation	1221
Xiaoxuan Liu, Rui Peng, Ming Ronnier Luo - The impact of skin colours on visual impression	1227
Yan Lu, Kaida Xiao - Quantifying facial colour appearance of Caucasian and Chinese faces	1233



Kumiko Kikuchi, Shoji Tominaga, Jon Hardeberg - Development of measurement system for optical properties of facial skin using 3D camera and projector	1239
Katsuaki Sakata, Hitomi Shimakura - The reference point for judging human facial skin tone	1245
Simone Liberini, Alessandro Rizzi - Munsell and Ostwald color spaces: a comparison in the field of hair coloring	1251
Alessandro Rizzi, Roberta Suardi, Simone Liberini - Hair color wheels and charts	1257
Alice Toninelli, Simone Liberini, Roberta Suardi, Giannantonio Negretti - Chromatic appearance of nylon swatches in hair color charts	1263
Daniele Fusari - Influence of color discrimination proficiency on wellness professionals' training and craft	1269
Giannantonio Negretti - Hair coloring and customer satisfaction	1275
Lupe Voss, Sherman Wong - More than a tube of Hair Colour - The Emotion	1279
<b>ALL THE COLORS OF CINEMA</b>	<b>1286</b>
Ivan Magrin-Chagnolleau - Handling Color in Photography and Film: From Photo Retouching to Color Grading	1288
Pedro Felipe Pinho Souza - Color correction and color grading: how a film colorist works	1293
Manuela Piscitelli - Colour in characters' identity in the animation cinema	1299
Alice Plutino, Beatrice Sarti, Gabriele Simone, Alessandro Rizzi - A film in a frame: movie barcodes for film restoration	1305
Mark Wentworth, Orly Morgenstern, Tania Erandeni Fuentes Villa - The Lilac Scarf – Color as a visual narrative as depicted in the film Far from Heaven (2002)	1311
Paula Csillag, Amanda Sabião - PIXAR's Colorscripts: Chromatic Analyses of Four Films Using Sens Org Int Model	1317
Sabrina Negri - Fine Arts on Film: The Hand-Painted Work of Stan Brakhage	1323
Giorgio Trumpy, Sreya Chatterjee, Ulrich Ruedel, Barbara Flueckiger - A Material Investigation of Color Film Technology through the Koshofer Collection	1330
Luca Giuliani - Digital color in cinema: an incomplete transition	1335
Beatrice Sarti, Arianna Crespi, Giulia Morabito, Alice Plutino, Alessandro Rizzi - Film Repository for Restoration (FiRe2): identification of photographic and cinematographic films	1341
<b>ALL THE RECENT BOOKS ON COLOR</b>	<b>1347</b>
Maria João Durao - Colour: Urban Space, Architecture and Design	1349
Jodi Sandford - The Sense of Color: A Cognitive Linguistic Analysis of Color Words	1355
Verena M. Schindler, Yulia A. Griber - Publications: The International Scientific Conference of the Color Society of Russia	1361
<b>COLOUR, LIGHT &amp; SOUND: HOLISTIC APPROACH FOR WELLBEING</b>	<b>1367</b>
Thelma van der Werff, Mary Ashby-Green - Colour as a coaching tool with Colournostics	1369
Pascal Vidal - Photonic Medicine, the therapeutic use of light and colours in Medicine	1373
Pauline Allen, Heather Benghiat, Phil Stickland - How the sensory systems impact our journey through life	1379
Susana Ribeiro - Bodygraphy - Chromatic performance on surrounding space	1385
Angelika Klotz - Post-Pandemic Support with Colour, Light and Frequencies	1391
Valérie Bonnardel - Colour, Human experience and cyborgism	1397
Margo Ruiter - The power of earth colours	1404
Claudia Bonollo - The imagined body (2001-2021)	1409
Daniel Asis - Auricular Chromotherapy in the treatment of Psychological Trauma	1415
Arzhan Surazakov - Principles of regenerative therapy with low-intensity laser, colour, ultrasound and magnetic field (coMra)	1420
Abhay Wadhwa - Soul-X: The Experience Center for Mind-Body Harmony	1425
Anadi Martel, Christophe Desteuque - Treating chronic pain and depression with color and sound: recent studies using the Sensora system	1431
<b>CITATIONS</b>	<b>1437</b>
<b>PHOTO OF THE CLOSING CEREMONY</b>	<b>1455</b>
<b>INDEX BY AUTHOR</b>	<b>1457</b>





## AIC PRESIDENT'S MESSAGE

Welcome to AIC 2021, the 14<sup>th</sup> AIC Congress. It is the time again to get together at our annual colour event.

First and foremost, I would like to express my sincere gratitude to Gruppo del Colore – Associazione Italiana Colore, the AIC 2021 Organising Committee. The continued uncertainties of the coronavirus pandemic situation have added substantial challenges to the congress arrangements. In January 2021, just under 8-month countdown to the congress, a tough decision of converting the traditional physical-venue-based congress to entirely online format had to be made. The AIC 2021 Organising Committee responded to the exceptional circumstances positively. To provide maximum participation opportunities, the congress programme is structured to well-suit both the eastern and western time zones. The refreshing 5-minute short-paper presentations stand-in for the conventional poster presentations.



The AIC has been awarding outstanding work in the field of colour science via its Deane B. Judd Award for over 40 years. I am pleased to announce that the Deane B. Judd Award 2021 will be presented to John McCann. Established in 2015 and first given in 2017, the AIC Award for Color in Art, Design and Environment (CADE) recognises excellence in the areas of design, art, architecture and humanities. Many congratulations to Jean-Philippe Lenclos, the recipient of the CADE Award 2021.

During the Congress General Assembly, Regular Members will be voting on the AIC Statutes revisions that introduced by our former Auditors (2016-2017) and Executive Committee (2018-2019). Regular Members will also be electing the new Executive Committee for the term-of-office 2022-2023.

As part of the community and public engagement promoting colour, the AIC established the International Colour Day (ICD), held on 21<sup>st</sup> March each year, over a decade ago. To-date we have twenty-seven Regular Members, over five continents, participated the ICD celebrations. This achievement marks an important step towards the AIC's planned application for international days observed at UNESCO.

Last but not least, AIC 2021 would not be possible without the support of the AIC and wider colour communities. I would like to thank the authors for submitting and presenting their papers, the Scientific Committee for their help with the review process, the Session Chairs for the smooth running of the programme, the Chairs and Co-Chairs of the AIC Study Groups for hosting a selection of workshops, the Co-operating Societies for their assistance and the Sponsors for their financial contributions.

***I hope you enjoy the programme. Have a productive time at AIC 2021!***

*Vien Cheung*





*AIC President, July 2021*



International Colour Association  
Internationale Vereinigung für die Farbe  
Association Internationale de la Couleur

**AIC, International Colour Association**

[www.aic-color.org](http://www.aic-color.org)

## 2020-2021 EXECUTIVE COMMITTEE



**PRESIDENT**

Vien Cheung

UK



**PAST PRESIDENT**

Tien-Rein Lee

Taiwan



**VICE PRESIDENT**

Leslie Harrington

USA



**SECRETARY /  
TREASURER**

Ralf Weber

Germany



Maurizio Rossi

Italy



Paula Csillag

Brazil



Takahiko Horiuchi

Japan



Robert Hirschler

Hungary



**AUDITOR**

Berit Bergström

Sweden



**AUDITOR**

José Luis Caivano

Argentina



## **AIC REGULAR MEMBERS**

**Argentina** Grupo Argentino Del Color  
**Australia** Colour Society Of Australia  
**Belgium** Interdisciplinary Colour Association-Belgium  
**Brazil** Associação Pró-Cor Do Brasil  
**Bulgaria** Colour Group - Bulgaria  
**Canada** Colour Research Society Of Canada  
**Chile** Asociación Chilena Del Color  
**China** Color Association Of China  
**Croatia** Hrvatska Udruga Za Boje  
**Finland** Suomen Väriyhdistys Svy Ry  
**France** Centre Français De La Couleur  
**Germany** Deutscher Verband Farbe  
**Great Britain** The Colour Group (Great Britain)  
**Hungary** Hungarian National Colour Committee  
**Italy** Gruppo Del Colore - Associazione Italiana Colore  
**Japan** Color Science Association Of Japan  
**Korea** Korean Society Of Color Studies  
**Mexico** Asociación Mexicana De Investigadores Del Color  
**Norway** Forum Farge  
**Portugal** Associação Portuguesa Da Cor  
**Slovenia** Slovensko Zdruzenje Za Barve  
**Spain** Comité Español Del Color  
**Sweden** Stiftelsen Svenskt Färgcentrum  
**Switzerland** Pro/Colore  
**Taiwan** Color Association Of Taiwan  
**Thailand** Color Society Of Thailand  
**The Netherlands** Stichting Kleurenvisie: Het Nederlands Platform Voor Kleur  
**United States** Inter-Society Color Council

## **AIC ASSOCIATE MEMBERS**

**North America** International Association of Color Consultant/Designers  
**USA** Color Marketing Group

## **AIC INDIVIDUAL MEMBERS**

**Australia** Zena O'Connor  
**Colombia** Lia Margarita Tapis  
**The Czech Republic** Martina Vikova  
**France** Jaqueline Carron  
**Greece** Yannis Skarpelos  
**Russia** Yulia A. Griber  
**Slovakia** Andrea Urland  
**Turkey** Kazim Hilmi Or

## **AIC STUDY GROUPS**

### **Arts and Design (AD)**

Chair: Maria João Durão

### **Color Education (CE)**

Chairs: Robert Hirschler, Maggie Maggio

### **Color Vision and Psychophysics (CVP)**

Chairs: Katsunori Okajima, Manuel Melgosa

### **Environmental Color Design (ECD)**

Chairs: Verena M. Schindler, Yulia A. Griber

### **Language of Color (LC)**

Chairs: Dimitris Mylonas, Galina Paramei



## 14TH AIC CONGRESS AIC 2021 - MILAN, ITALY



**WELCOME  
to the  
14th AIC  
CONGRESS**



### **Gruppo del Colore-Associazione Italiana Colore President's Message**

The Congress of the International Color Association (AIC) is a unique multidisciplinary event that brings together scholars and professionals from a wide range of fields. It has been held every four years since its inception in 1969. The 2021 event, which is the 14th AIC Congress, will be organized in Italy, for the first time. The Italian Gruppo del Colore - Associazione Italiana Colore has prepared it for five years since Italy was chosen to host it under the decision of the AIC Executive Committee in the AIC Interim Meeting, which was held in Santiago, Chile, in 2016.



On behalf of the 14th AIC Congress Organizing Committee, we welcome you to the first AIC Congress fully online. The decision to organize it online was made at the beginning this year due to the Covid-19 pandemic, that imposes multiple constraints all over the world with its trail of dead and ailing. Nevertheless, the 14th AIC Online Congress will comply with the provisions of the AIC Regulations for general congresses in which the following events must be present: Opening Ceremony, Award Ceremony, AIC General Assembly, Workshop of Working Groups AIC and Closing Ceremony. In addition, all standards required for publications and the handover of the AIC banner to AIC2022 will be respected.



The Congress received about 270 Abstract submissions from 37 countries and the abstracts were reviewed and selected by the International Scientific Committee consisting of 112 experts from around the world. The total number of papers that will be presented in this Congress is circa 250 including 200 oral presentations (regular and short), eight Invited Lectures, and two Award Lectures. In addition, there are four special sessions, namely 'Innovation and research in color for beauty care and hairstyle', 'All the colors of cinema', 'Colour, light & sound: holistic approach for wellbeing' and 'All the recent books on color'. There are also four AIC Study Group Workshops with special programs, such as AIC 2021 Study Group on Environmental Color Design, AIC 2021 Study Group on Arts and Design, AIC 2021 Study Group on Language of Color, and AIC 2021 Study Group on Color Education. As is evident, the program is international and highly multidisciplinary.

I wish to thank you all in advance for your patience as we navigate through the complexities of a fully digital conference. I also wish to thank my friends and colleagues, the local organizers, for making this event possible. I also wish to thank the Scientific Committee members who dedicated their time to promoting the conference and reviewing the submissions.

Online Milan, together with the Università degli Studi di Milano and the Congress organizers (Gruppo del Colore – Associazione Italiana Colore), is ready to welcome the participants from all over the world to the 14th AIC Congress, both as presenters and auditors, to explore the scientific and cultural themes of human activity in which color intervenes or assumes a prominent place.

*Marcello Picollo*

*Gruppo del Colore-Associazione Italiana Colore President*





## The AIC2021 14<sup>th</sup> Congress - Chairs introduction

The International Color Association (AIC) Congress is a unique multidisciplinary event that brings together scholars and professionals from a wide range of fields. It has been held every four years since its inception in 1969, and in 2021, it is hosted in Italy, for the first time, organized by the Gruppo del Colore - Associazione Italiana Colore.



The Covid19 pandemic imposes multiple constraints all over the world. In Italy, the state's laws and the safety rules of the previously chosen Venue (Ca' Granda, Università degli Studi di Milano) prohibit any socializing, which is one of the fundamental reasons for the participation in presence. Moreover, due to travel-related risks and restrictions, the Gruppo del Colore – Associazione Italiana Colore, in agreement with the AIC, has decided to organize the AIC 14th Congress online in compliance with the program elements required by the AIC rules: Opening Ceremony, Awards, AIC General Assembly, AIC Study Groups Workshops and Closing Ceremony.

In AIC2021, which should have been in presence, the Chairs wanted to create an **Ethically Sustainable Congress**, thinking about young people, retired people, and professionals who cannot afford to spend too much to attend a Congress. This was our leading idea since 2016 when we proposed Italy to AIC EC in Santiago. Following this idea, the early registration fee available since 2020 for the 14th AIC Congress is about half that of the previous Congress. The early registration is nearly the same fee of students in the previous Congress. On January 5th 2021, in agreement with the AIC, it was decided that, due to Covid19, the AIC 14th Congress will be online. Therefore, we have decided to halve further the early registration fee, which is less than a quarter of the previous Congress, lower than the fee of students, and the single-day fee of the previous congresses. With a fee equivalent to what used to be the registration of a single day, now participants can follow in the entire five-day Congress. To achieve this goal, the AIC2021 Congress is organized and directly administered by Gruppo del Colore - Associazione Italiana Colore, a non-profit association. Gruppo del Colore - Associazione Italiana Colore could have decided to delegate the organization and administration of the Congress to a company specialized in the organization of events, but this would have more than doubled the current registration fee even for an Online congress and would also have added VAT (+ 22% in Italy). For a 5-day online Congress, this would have resulted in doubling the registration fee. This has been possible thanks to the volunteer work of the members of the Gruppo del Colore - Associazione Italiana Colore in the organizing committee, which here we want to acknowledge and thank.

AIC is a society that gathers together color experts from the broadest set of different approaches of study and practice. The conference aims at keeping all of them under the same (virtual) "roof" to foster discussion and cross-fertilization. Hence, in the AIC2021 Congress, all the topics related to color have been welcome.



They have been divided into areas to organize the time schedule of the attendees that are free to switch between sessions. We have made our best to shrink the more than 250 talks in a timespan that could be attended by everyone regardless of the time zone from which one is connected. This resulted in a trade-off for which the morning sessions (Italian time) will be easier to follow for the eastern participants, while the afternoon sessions are more suitable for the western ones. For this reason, we have put the official moments exactly in the middle of the Italian day. A perfect solution was not possible, so we hope you can consider our effort to be as inclusive as possible and forgive us for any possible inconvenience for which we apologize in advance.

In this 2021 edition, we have promoted special thematic sessions that resulted in four of them. The first that opens the conference is a special session on "Innovation and research in color for beauty and hairstyle" followed on the same day (Monday) by "All the colors of cinema". Two more special sessions follow, one organized by the International Light Association (ILA) on Tuesday and the last one closing the conference on Friday about "All recent books on colour". There will also be a special session for the awards: the AIC "Judd" award founded in 1973, the AIC "Color in Art and Design" (CADE) award, and the Gruppo del Colore – Associazione Italiana Colore "Premio Colore GdC" award.

Precious guests are eight invited speakers, highly esteemed scholars in the field that (in alphabetical order) will give us a series of special talks:

**Reiner Eschbach** *"Color deficient see this way .. or don't they?"*

**Robin Jenkin** *"The influence of CFA choice on automotive and other critical imaging systems"*

**Pietro Marani** *"Leonardo's colour today: from the dark to the light"*

**Luca Missoni** *"Color in fashion design"*

**John McCann** (Judd Award) *"Edges in illumination control appearance in natural HDR scenes"*

**Austin Nevin** *"Conservation science and changing colours - approaches to measuring and managing change"*

**Giovanni Pinna** *"Lighting and color design in the show"*

**Francesca Valan** *"Chromatic Sustainability: a new approach to color design"*

***We hope you will find in the Congress all the stimuli you are searching for your future research and career, and you will keep joining this growing multidisciplinary, international community.***

*The AIC2021 14<sup>th</sup> Congress Chairs  
Alessandro Rizzi and Maurizio Rossi*





## AIC 14TH CONGRESS MILANO 2021 IS ORGANIZED BY GRUPPO DEL COLORE - ASSOCIAZIONE ITALIANA COLORE

[www.gruppodelcolore.org](http://www.gruppodelcolore.org)



### GENERAL CHAIRS

Alessandro Rizzi

Università degli Studi Milano

Maurizio Rossi

Politecnico di Milano

### ORGANIZING COMMITTEES

#### Publicity Committee

Marcello Picollo

Chair

*Filippo Cherubini*

*Lia Luzzatto*

*Veronica*

*Marchiafava*

*Gianluca Guarini*

#### Publications Committee

Marco Gaiani

Chair

*Fabrizio Ivan*

*Apollonio*

*Silvia Bertacchi*

*Simone Garagnani*

*Franco Nicolucci*

*Carlo Bianchini*

*Michela Cigola*

*Berta Martini*

#### Online Congress Committee

Alice Plutino

Chair

*Alessandro Rizzi*

*Gabriele Simone*

*Albana Muco*

#### Finance & Fundraising Committee

Maurizio Rossi

Chair

*Andrea Siniscalco*

*(treasurer)*

*Clelia Gotti*



## SCIENTIFIC PEER REVIEW COMMITTEE

Michel Albert-Vanel	Ecole Polytechnique de Paris	FR
Paula Jean Alessi	Inter-Society Color Council	US
Kine Angelo	Norwegian University of Science and Technology	NO
Fabrizio Ivan Apollonio	Alma Mater Studiorum Università di Bologna	IT
Harald Arnkil	Aalto University	FI
Ulrich Bachmann	ICL	CH
Doreen Balabanoff	OCAD University	CA
John Barbur	City University London	GB
Giovanni Bartolozzi	IFAC-CNR	IT
Laura Bellia	Università di Napoli Federico II	IT
Berit Bergstrom	Swedish Colour Centre Foundation	SE
Silvia Bertacchi	Alma Mater Studiorum Università di Bologna	IT
Janet Best	Natific	GB
Carlo Bianchini	Sapienza Università di Roma	IT
Valérie Bonnardel	University of Winchester	GB
Aldo Bottoli	B&B Colordesign	IT
Sabina Bračko	University of Ljubljana	SI
Axel Buether	Bergische Universität Wuppertal	DE
José Luis Caivano	Universidad de Buenos Aires	AR
Patrick Callet	École Centrale Paris	FR
Joaquín Campos	Instituto de Óptica Daza de Valdés	ES
Filippo Cherubini	IFAC-CNR	IT



Vien Cheung	University of Leeds	GB
Michela Cigola	Università di Cassino	IT
Verònica Conte	University of Lisbon	PT
Paula Csillag	ESPM University	BR
Osvaldo Da Pos	Università degli Studi di Padova	IT
Hélène De Clermont-Gallerande	Chanel Parfum Beauté	FR
Annamaria Di Cara	STUDIO DC Disegno Colori	AU
Reiner Eschbach	NTNU	NO
Christine Fernandez-Maloigne	University of Poitiers	FR
Raffaella Fontana	INO-CNR	IT
Brian Funt	Simon Fraser University	CA
Davide Gadia	Università degli Studi di Milano	IT
Marco Gaiani	Alma Mater Studiorum Università di Bologna	IT
Margarida Gamito	Universidade de Lisboa	PT
Simone Garagnani	Alma Mater Studiorum Università di Bologna	IT
Martinia Glogar	University of Zagreb	HR
Clelia Gotti	GdC-Associazione Italiana Colore	IT
Paul Green-Armytage	Curtin University	AU
Yulia A. Griber	Smolensk State University	RU
Gianluca Guarini	Politecnico di Milano	IT
Jon Hardeberg	Norwegian University of Science and Technology	NO
Nick Harkness	NHPL	AU
Leslie Harrington	Inter-Society Color Council	US



Robert Hirschler	Serviço Nacional de Aprendizagem Industrial	BR
Takahiko Horiuchi	Chiba University	JP
John B. Hutchings	University of Leeds	GB
Mitsuo Ikeda	Rajamangala University of Technology Thanyaburi	TH
Francisco Imai	Canon	US
Maria João Durão	University of Lisbon	PT
Domicela Jonauskaitė	University of Lausanne	CH
Robin Kingsburgh	York University	CA
Agata Kwiatkowska-Lubańska	Academy of Fine Arts, Kraków	PL
Mette L'Orange	University of Bergen	NO
Michela Lecca	FBK	IT
Tien-Rein Lee	Huafan University	TW
Anahi Lopez	CICPBA LEMIT	AR
Ronnier Luo	Zhejiang University	CN
Lindsay MacDonald	University College London	GB
Maggie Maggio	AIC S.G. on Color Education	US
Veronica Marchiafava	GdC-Associazione Italiana Colore	IT
Gabriel Marcu	Apple	US
Anna Marotta	Politecnico di Torino	IT
Berta Martini	Università di Urbino	IT
John McCann	McCann Imaging	US
Fiona McLachlan	University of Edinburgh	GB
Manuel Melgosa	Universidad de Granada	ES



Inez Michiels	CITY OF 8 Design Semantics	BE
Galen Minah	University of Washington	US
Albana Muco	Università degli Studi di Milano	IT
Dimitris Mylonas	University College London	GB
Sabrina Negri	University of Colorado Boulder	US
Zena O'Connor	Colour Collective Sydney	AU
Katsunori Okajima	Yokohama National University	JP
Lia Maria Papa	Università degli Studi di Napoli Federico II	IT
Galina Paramei	Liverpool Hope University	GB
Pedro Pardo	Universidad de Extremadura	ES
Carinna Parraman	UWE	GB
Laurence Pauliac	Historienne de l'Art et de l'Architecture	FR
Silvia Piardi	Politecnico di Milano	IT
Marcello Picollo	IFAC-CNR	IT
Alice Plutino	Università degli Studi di Milano	IT
Jean Pretorius	Colour Society of Australia	AU
Boris Pretzel	Victoria & Albert Museum	GB
Katia Ripamonti	Cambridge Research System	GB
Alessandro Rizzi	Università degli Studi di Milano	IT
Frank Rochow	Dfwg	DE
Javier Romero	University of Granada	ES
Maurizio Rossi	Politecnico di Milano	IT
Jodi L. Sandford	Università di Perugia	IT
Tetsuya Sato	Kyoto Institute of Technology	JP



Raimondo Schettini	Università degli Studi di Milano Bicocca	IT
Verena M. Schindler	AIC S.G. Environmental Colour Design	CH
Renzo Shamey	NC State University	US
Gabriele Simone	Università degli Studi di Milano	IT
Andrea Siniscalco	Politecnico di Milano	IT
Vicky Syriopoulou	International Light Association	IT
Shin'ya Takahashi	Tokaigakuen University	JP
Elza Tantcheva	Colour Group	GB
Justyna Tarajko-Kowalska	Cracow University of Technology	PL
Shoji Tominaga	Chiba University	JP
Sophie Triantaphillidou	University of Westminster	GB
Mari Uusküla	Tallinn University	EE
Francesca Valan	Studio Valan	IT
Eva Valero	University of Granada	ES
Thelma van der Werff	International Light Association	NZ
Merixell Vilaseca Ricart	Universitat Politècnica de Catalunya	ES
Ralf Weber	Technische Universität Dresden	DE
Mark Wentworth	Colour for Life	GB
Stephen Westland	University of Leeds	GB
Hirohisa Yaguchi	Chiba University	JP



## SPONSORS



## PATRONAGE

- Associazione Italiana di Illuminazione – AIDI
- Associazione Italiana per la ricerca in Computer Vision – CVPL
- Associação Portuguesa da Cor
- Associação ProCor do Brasil
- Comité del Color
- Color Science Association of Japan
- Federchimica Avisa
- ILA – International Light Association
- Inter-Society Color Council
- Politecnico di Milano
- Procolore
- Società Italiana di Fisica – SIF
- Società Italiana di Ottica e Fotonica – SIOF
- Society for Imaging Sciences and Technology
- Suomen Väriyhdistys Svy ry



## CALL FOR PAPERS

Authors are invited to submit abstracts only if they really intend to participate in the congress.

All submissions must be in English and describe original work that has not been published or submitted elsewhere. All abstracts will be reviewed by at least two members of the Scientific Peer Review Committee in a double-blind peer-review process. Abstracts sent by email will not be accepted. Abstracts must be uploaded on the on-line management conference system EasyChair available at:

<https://easychair.org/conferences/?conf=aic20210>

To send contributions you must first register on EasyChair creating an account or, if you are already registered, you can use the one you have. To register for the first time, choose "Create an account" on the first page and follow the instructions. It is important to enter complete data by carefully filling in the format, entering real data and valid e-mails so that the congress organization can contact you.

### **Abstract submission deadline: March 31st, 2021**

To send the abstracts, connect to the EasyChair system by entering the login and password obtained from the previous registration and choose "Make a New Submission", then:

- fill in the data of the authors and tick "Corresponding Author" so that the email address indicated (at least one) receives communications from the organizers;
- enter the title and abstract in the prefixed fields (maximum 4000 characters including spaces and references);

choose the topic of interest to which the paper will refer:

1. COLOR AND MEASUREMENT / INSTRUMENTATION. Colorimetry, photometry and color atlas: method, theory and instrumentation; quality control and food coloring, dyes, organic and sustainable color.
2. COLOR AND DIGITAL. Reproduction, management, digital color correction, image processing, graphics, photography, film and video production, printmaking and 3D print, artificial vision, virtual reality, multispectral imaging, data visualization.
3. COLOR AND LIGHTING. Metamerism, color rendering, adaptation, color constancy, appearance, illusions, color memory and perception, color in extra-atmospheric environments, lighting design, lighting technologies, visual comfort.
4. COLOR AND PHYSIOLOGY. Mechanisms of vision in their experimental and theoretical aspects, color vision and color appearance, deficiencies, abnormalities, clinical and biological aspects, synesthesia, health, well-being.
5. COLOR AND PSYCHOLOGY. Phenomenology of colors, color harmonies, color & form, perceptive, emotional, aesthetic and diagnostic aspects.





6. COLOR AND PRODUCTION. Food and beverages, agriculture, textiles, plastic materials, ceramics, paints, gemology, color in the food industry.
7. COLOR AND RESTORATION. Archaeometry, painting materials, diagnostics and techniques of conservation, restoration and enhancement of cultural heritage.
8. COLOR AND ENVIRONMENT. Representation and drawing, urban planning, project of color, architecture, interior design, landscapes & horticulture, color and architectural syntax, territorial identities, biodiversity.
9. COLOR AND DESIGN. Furniture, CMF design, fashion, textiles, textures, cosmetics, food design, museography.
10. COLOR AND CULTURE. Arts and crafts, history, philosophy, aesthetics, ethno-anthropology, graffiti, geology, sociology, lexicology, semantics, anthropology of vision, food culture and heritage, color naming.
11. COLOR AND EDUCATION. Pedagogy, didactics of color, aesthetic education, artistic education.
12. COLOR AND COMMUNICATION / MARKETING. Graphics, communication, packaging, lettering, exposure, advertising.

### **Special Sessions**

1. Innovation and research in color for beauty care and hairstyle
2. All colors of cinema
3. All the recent books on colour
4. Colour, light & sound: holistic approach for wellbeing

Presentations can be oral or poster, the authors must indicate their preference (the final decision will be up to the organizing committee); enter at least 3 keywords relating to your abstract; a confirmation e-mail will be sent to the corresponding author that the abstract has been correctly sent to the organizers. By May 5th, 2021, the organizers will communicate if the work has been accepted with any suggestions for drafting the final paper.

The final manuscript must be sent by July 15th 31st, 2021. The deadline for submitting papers on EasyChair has been extended again to August 15. After this date, papers will no longer be accepted for the publication of the Congress proceedings. Papers must be submitted only through the EasyChair online system, do not send email.

Please note that at least one of the authors of the accepted submissions must register for the congress and send the Transfer\_of\_Copyright by May 15th 22nd 29th 2021, participate in the congress and present the work in the format decided by the organizing committee (full oral or short presentation). The registration of 1 author is valid for the submission of a maximum of 1 abstract/paper.



Each author and/or co-author wishing to participate in the congress must pay the registration fee.

People who have not previously registered to the congress and paid the registration fee will not be admitted to the congress.

### **Proceedings**

Only the accepted papers that will have been presented (oral or poster) during the Congress will be published in the AIC2021 Proceedings. Papers not uploaded to EasyChair within the indicated deadline will not be published in the proceedings. Papers that do not comply with the template required by the AIC will not be published in the AIC proceedings. Please read carefully the instructions on the Final Paper Submission Guidelines page. As requested by the AIC, only the papers of the abstracts that have been accepted after the double-blind peer review closed on May 2021, and the Awards, will be published in the proceedings.

### **Special issues**

Plans are underway to have the best papers, in extended version, selected for possible publication in some reputable journal as a special issue. Detailed information are available on the congress website.

## PROGRAM AT A GLANCE

Time-zone UTC+2	Monday 30-Aug-2021	Tuesday 31-Aug-2021		Wednesday 1-Sep-2021		Thursday 2-Sep-2021		Friday 3-Sep-2021
09:00 10:00	<i>Special Session</i>	Colour and Physiology	Color and Design	Color and Education	Color and Psychology	Color and Measurement / Instrument	Color and Comm./ Marketing	Color and Lighting
10:00 11:00	Innovation and Research in Color for Beauty Care and Hairstyle			Color and Restoration				
11:00 12:00				Invited Speaker		Invited Speaker	Invited Speaker	Invited Speaker
12:00 13:00	Break	Break	Break	Break	Break	Break	Break	
13:00 13:30	Opening Ceremony	AIC General Assembly	AIC Study Groups Workshop	AIC Study Groups Workshop	AIC Awards	Closing Ceremony		
14:30 15:30							Break	Break
15:30 16:00	Invited Speaker	Invited Speaker	Break		Color and Digital	Color and Culture	Color and Built Environment	
16:00 16:30	<i>Special session</i>	ILA Color, Light & Sound: holistic approach for wellbeing	Color and Design	Invited Speaker				Color and Measurement/ Instrument
16:30 17:00	All the Colors of Cinema			Color and Lighting	Color and Psychology			
17:00 18:00				Color and Restoration	Color and Education			
18:00 19:00	Color and Culture	Color and Built Environment	Color and Education	Color and Production	All the Recent Books on Color			
19:00 20:00						Color and Culture		
20:00 21:00								

## SCIENTIFIC PROGRAM

Note: all time scheduling is refer to UTC+2

### Monday August 30<sup>th</sup>, 2021 (single session ROOM 1)

<b>09:00 - 10:05</b> <b>SPECIAL SESSION</b> <b>INNOVATION AND RESEARCH IN COLOR FOR BEAUTY CARE AND HAIRSTYLE -1</b> <i>Chairs: Alessandro Rizzi, Maurizio Rossi</i>	
<b>Oral:</b>	
<b>Christine Fernandez-Maloigne</b>	<b>History of colors and beauty</b>
<b>Helene De Clermont-Gallerande</b>	<b>A comparative study of lipstick shades preferences by geographical area</b>
<b>Isabel Espinosa Zaragoza</b>	<b>Parallelism as advertising strategy in Maybelline's lipstick colour names</b>
<b>Yuchun Yan, Hyeon-Jeong Suk</b>	<b>Fifty Shades of Beige: An Analysis on the Color System for Liquid Foundation</b>
<b>10:05-10:15 BREAK</b>	
<b>10:15 - 11:05</b> <b>SPECIAL SESSION</b> <b>INNOVATION AND RESEARCH IN COLOR FOR BEAUTY CARE AND HAIRSTYLE -2</b> <i>Chairs: Christine Fernandez-Maloigne, Helene De Clermont-Gallerande</i>	
<b>Oral:</b>	
<b>Xiaoxuan Liu, Rui Peng, Ming Ronnier Luo</b>	<b>The impact of skin colours on visual impression</b>
<b>Yan Lu, Kaida Xiao</b>	<b>Quantifying facial colour appearance of Caucasian and Chinese faces</b>
<b>Kumiko Kikuchi, Shoji Tominaga, Jon Hardeberg</b>	<b>Development of measurement system for optical properties of facial skin using 3D camera and projector</b>
<b>Short presentation:</b>	

<b>Katsuaki Sakata, Hitomi Shimakura</b>	<b>Reference point for judging human facial skin tone</b>
<b>11:05-11:15 BREAK</b>	
<b>11:15 - 12:00</b> <b>SPECIAL SESSION</b> <b>INNOVATION AND RESEARCH IN COLOR FOR BEAUTY CARE AND HAIRSTYLE - 3</b> <i>Chairs: Helene De Clermont-Gallerande, Christine Fernandez-Maloigne</i>	
<b>Oral:</b>	
<b>Simone Liberini, Alessandro Rizzi</b>	<b>Munsell and Ostwald color spaces: a comparison in the field of hair coloring</b>
<b>Alessandro Rizzi, Roberta Suardi, Simone Liberini</b>	<b>Hair color wheels and charts</b>
<b>Alice Toninelli, Simone Liberini, Roberta Suardi, Giannantonio Negretti</b>	<b>Chromatic appearance of nylon swatches in hair color charts</b>
<b>12:00-12:10 BREAK</b>	
<b>12:10 - 12:55</b> <b>SPECIAL SESSION</b> <b>INNOVATION AND RESEARCH IN COLOR FOR BEAUTY CARE AND HAIRSTYLE - 4</b> <i>Chairs: Alessandro Rizzi, Marcello Picollo</i>	
<b>Oral:</b>	
<b>Daniele Fusari</b>	<b>Influence of color discrimination proficiency on wellness professionals' training and craft</b>
<b>Giannantonio Negretti</b>	<b>Hair coloring and customer satisfaction</b>
<b>Lupe Voss, Sherman Wong</b>	<b>More than a tube of Hair Colour - The Emotion</b>
<b>12:55-13:30 BREAK</b>	



<p><b>13:30-15:30 <u>OPENING CEREMONY</u></b></p> <p><b>Maurizio Rossi - Congress Chair welcome</b></p> <p><b>Vien Cheung - AIC President</b></p> <p><b>Marcello Picollo - Associazione Italiana Colore President</b></p> <p><b>Alessandro Rizzi - Congress Chair to introduce the Congress Program</b></p> <p><b>Premio Colore GdC 2021 - Vittorio Storaro</b></p>	
<p><b>15:30 - 16:00 BREAK</b></p>	
<p><b>16:00-16:40 Invited Speaker</b></p> <p><b>Reiner Eschbach "Color deficient see this way...or don't they?"</b></p> <p><b>Chair: <i>Alessandro Rizzi</i></b></p>	
<p><b>16:40-16:50 BREAK</b></p>	
<p><b>16:50-18:05</b></p> <p><b>SPECIAL SESSION</b></p> <p><b>ALL THE COLORS OF CINEMA - 1</b></p> <p><b>Chairs: <i>Sabrina Negri, Mark Wentworth, Alice Plutino</i></b></p>	
<p><b><u>Oral:</u></b></p>	
<p><b>Ivan Magrin-Chagnolleau</b></p>	<p><b>Handling Color in Photography and Film: From Photo Retouching to Color Grading</b></p>
<p><b>Pedro Felipe Pinho Souza</b></p>	<p><b>Color correction and color grading: how a film colorist works</b></p>
<p><b>Manuela Piscitelli</b></p>	<p><b>Colour in characters' identity in the animation cinema</b></p>
<p><b>Alice Plutino, Beatrice Sarti, Gabriele Simone, Alessandro Rizzi</b></p>	<p><b>A film in a frame: movie barcodes for film restoration</b></p>
<p><b>Mark Wentworth, Orly Morgenstern, Tania Erandeni Fuentes Villa</b></p>	<p><b>The Lilac Scarf - Color as a visual narrative as depicted in the film Far From Heaven (2002)</b></p>
<p><b>18:05-18:15 BREAK</b></p>	
<p><b>18:15-19:45</b></p> <p><b>SPECIAL SESSION</b></p> <p><b>ALL THE COLORS OF CINEMA - 2</b></p> <p><b>Chairs: <i>Alice Plutino, Mark Wentworth, Sabrina Negri</i></b></p>	

<b>Oral:</b>	
<b>Paula Csillag, Amanda Sabião</b>	<b>PIXAR's Colorscripts: Chromatic Analyses of Four Films Using Sens Org Int Model</b>
<b>Ângela Santos, Vanessa Otero, Márcia Vilarigues</b>	<b>Colours of pre-cinema projections: the evolution of hand-painted magic lantern glass slides' palette</b>
<b>Sabrina Negri</b>	<b>Fine Arts on Film: The Hand-Painted Work of Stan Brakhage</b>
<b>Giorgio Trumpy, Sreya Chatterjee, Ulrich Ruedel, Barbara Flueckiger</b>	<b>A Material Investigation of Color Film Technology through the Koshofer Collection</b>
<b>Luca Giuliani</b>	<b>Digital color in cinema: an incomplete transition</b>
<b>Beatrice Sarti, Arianna Crespi, Giulia Morabito, Alice Plutino, Alessandro Rizzi</b>	<b>Film Repository for Restoration (FiRe2): identification of photographic and cinematographic films</b>
<b>19:45-19:55 BREAK</b>	
<b>19:55-20:55</b>	
<b>SESSION 1 - COLOR AND CULTURE</b>	
<b>Chairs: <i>Doreen Balabanoff, Letizia Bollini</i></b>	
<b>Oral:</b>	
<b>Martino Pavignano, Ursula Zich</b>	<b>Colour, material and prototyping for Architecture</b>
<b>Enrico Zampieri, Vincenzo Baldoni, Simone Garagnani, Andrea Gausci, Michele Silani</b>	<b>Digital reproduction of colors and materials used in pottery: a case study from the ancient Picenum</b>
<b>Marcela Sepúlveda</b>	<b>Polychromy from the Atacama Desert (South America). An interdisciplinary approach for an archaeology of color.</b>
<b>Camilla Tartaglia</b>	<b>The hidden history of woad blue: a path through technology and diffusion of "European indigo" in 18th-century technical literature</b>

## Tuesday August 31<sup>st</sup>, 2021 (2 parallel sessions)

<b>ROOM 1</b>		<b>ROOM 2</b>	
<b>09:00-10:15</b>		<b>09:00-10:25</b>	
<b>SESSION 2 - COLOR AND PHYSIOLOGY</b>		<b>SESSION 4 - COLOR AND DESIGN</b>	
<i>Chairs: John Barbur, Marisa Rodriguez-Carmona</i>		<i>Chairs: Berit Bergstrom, Maurizio Rossi</i>	
<b>Oral:</b>		<b>Oral:</b>	
<b>Larry Wallace</b>	<b>An introduction to Syntonic Phototherapy, and Vision Rehabilitation</b>	<b>Aigerim Shunayeva, Taesu Kim, Bokyung Lee, Hyeon-Jeong Suk</b>	<b>Style assessment of home appliances in various interiors using virtual reality</b>
<b>Kota Akiba, Midori Tanaka, Takahiko Horiuchi</b>	<b>Effect of ipRGC on Colour Perception of Display Device under Various Illuminants</b>	<b>Gyunpyo Lee, Taesu Kim, Hyeon-Jeong Suk</b>	<b>Is Blue still a Representative for Future Vehicles?</b>
<b>Miyoshi Ayama, Minoru Ohkoba, Tomoharu Ishikawa, Shoko Hira, Sakuichi Ohtsuka</b>	<b>Difference Scaling and Color Naming of Red-Green Color Deficiencies</b>	<b>Boram Kim, Hyeon-Jeong Suk</b>	<b>Visualization of chair color data through network analysis</b>
<b>Firdevs Gökmenoğlu, Saadet Akbay</b>	<b>Effects of Colour on the Sense of Immersion in Virtual Interior Environments</b>	<b>Terumi Konno, Koichiro Kakiyama, Yasuhiro Kawabata</b>	<b>Observed changes in garment color selection of university students across normal and test periods</b>
<b>Short presentation:</b>		<b>Short presentation:</b>	
<b>Hideki Sakai</b>	<b>Brightness evaluation under the closed-eye condition: Measurement of optical transmittance of eyelid</b>	<b>Masato Sakurai, Ryoma Yamamoto</b>	<b>Relationship Between Taste Impression and Color in Snack Packages</b>



<p><b>Taesu Kim, Hyeon-Jeong Suk</b></p>	<p><b>EEG Responses to In-Car Dynamic Cluster Light</b></p>	<p><b>Tomoharu Ishikawa, Takumi Nakajima, Yoshiko Yanagida, Minoru Mitsui, Kazuya Sasaki, Miyoshi Ayama</b></p>	<p><b>Effect of Sensation Modalities on Texture Evaluation of Beige Fabrics by Japanese and Chinese</b></p>
<p><b>10:15-10:25 BREAK</b></p>		<p><b>Yumi Awano, Masayuki Osumi</b></p>	<p><b>The visual effect of costume woven with peacock feathers and the symbolism in Japanese culture - Evaluation derived from gonio- photometric spectrum analysis and microscopic observation</b></p>
		<p><b>Eunji Han, Yungkyung Park</b></p>	<p><b>A study on associative color attributes of Antonyms in Korean language</b></p>
		<p><b>10:25-10:35 BREAK</b></p>	
<p><b>ROOM 1 10:25-12:00 SESSION 3 - COLOR AND PHYSIOLOGY Chairs: <i>Valérie Bonnardel, Cristian Bonanomi</i></b></p>		<p><b>ROOM 2 10:35-12:10 SESSION 5 - COLOR AND DESIGN Chairs: <i>Saara Pyykkö, Francesca Valan</i></b></p>	
<p><b>Oral:</b></p>		<p><b>Oral:</b></p>	
<p><b>Francisco Díaz- Barrancas, Halina Cwierz, Pedro José Pardo</b></p>	<p><b>A study of physical and perceived linearity in a virtual reality environment</b></p>	<p><b>Agata Kwiatkowska- Lubańska</b></p>	<p><b>Colour and ornament in the Polish Art Deco style. Karol Homolacs and his colour course at the Cracow Workshops 1913- 1926</b></p>

<b>Kari Bjerke Gjørde, Anne Kristin Kvitle, Phil Green, Peter Nussbaum</b>	<b>How accurate is an on-line test for colour vision deficiency?</b>	<b>Verena M. Schindler, Yulia A. Griber</b>	<b>The evolution of environmental colour design in the French period</b>
<b>Laura Rey-Barroso, Mónica Roldán, Francisco J. Burgos-Fernández, Susanna Gassiot, Anna Ruiz Llobet, Ignacio Isola, Meritxell Vilaseca</b>	<b>Evaluation of Confocal Microscopy as a Diagnosis Tool on Red Blood Cell Diseases</b>	<b>Anna Kmita</b>	<b>CMF in commemorative ceramics. Project of a color and texture palette on the example of "Ckliwe na szkliwie"- Nostalgic Glaze. Personal collection of memories on ceramic plates.</b>
<b>Kazim Hilmi Or</b>	<b>A specific use of colour and dyes: „Vital dyes in ophthalmology“</b>	<b>Marcus Farr, Andrea Macruz</b>	<b>Colored Response: Technology, Thermo-chromic Material Systems and Human Awareness</b>
<b>Marisa Rodriguez-Carmona, Benjamin E. W. Evans, John L. Barbur</b>	<b>Assessing colour vision using single and multi test protocols</b>	<b>Francesco Scullica, Elena Elgani, Umberto Monchiero</b>	<b>The relevance of color in post COVID-19 interior design</b>
<b>Flávia Mayer</b>	<b>The Construction Of Color By The Congenitally Blind</b>	<b>Anna Barbara, Reejy Atef Abdelatty Mikhail, Maria Camila Álvarez García</b>	<b>The Odor of Colors: Correspondence from a Cross-Cultural Design Perspective</b>
<b>Short presentation:</b>		<b>Short presentation:</b>	
<b>Francisco J. Burgos-Fernández, Tommaso Alterini, Fernando Díaz-Doutón,</b>	<b>Colorimetric analysis of eye fundus structures with multispectral retinography</b>	<b>Gyeonghwa Lee, Vien Cheung, Tang Tang</b>	<b>The role of colour designers in the design process</b>

<b>Meritxell Vilaseca</b>			
<b>12:00-12:20 BREAK</b>		<b>12:10-12:20 BREAK</b>	
<b>ROOM 1</b> <b>12:20-13:00 Invited Speaker</b> <b>Robin Jenkin "The influence of CFA choice on automotive and other critical imaging systems"</b> <b>Chair: <i>Gabriele Simone</i></b>			
<b>13:00-13:30 BREAK</b>			
<b>ROOM 1</b> <b>13:30-15:30 AIC General Assembly</b>			
<b>15:30-16:00 BREAK</b>			
<b>ROOM 1</b> <b>16:00-16:40 Invited Speaker</b> <b>Luca Missoni "Color in fashion design"</b> <b>Chair: <i>Maurizio Rossi</i></b>			
<b>16:40-16:55 BREAK</b>			
<b>ROOM 1</b> <b>16:55-17:55</b> <b>SPECIAL SESSION ILA - 1</b> <b>COLOUR, LIGHT &amp; SOUND: HOLISTIC APPROACH FOR WELLBEING</b> <b>Chairs: <i>Vicky Syriopoulou, Jeannette Hanenburg</i></b>		<b>ROOM 2</b> <b>16:55-17:55</b> <b>SESSION 6 - COLOR AND DESIGN</b> <b>Chairs: <i>Ralf Weber, Agata Kwiatkowska-Lubańska</i></b>	
<b>Oral:</b>		<b>Oral:</b>	
<b>Thelma van der Werff, Mary Ashby-Green</b>	<b>Colour as a coaching tool with Colournostics</b>	<b>Michel Albert-Vanel</b>	<b>Combinations of colours as an analogue model in Modern Art</b>

<b>Pascal Vidal</b>	<b>Photonic Medicine, the therapeutic use of light and colours in Medicine</b>	<b>Gisela Costa Pinheiro Monteiro, Robert Hirschler</b>	<b>A mount-it-yourself 3D colour model for designers</b>
<b>Pauline Allen, Heather Benghiat, Phil Stickland</b>	<b>How the sensory systems impact our journey through life</b>	<b>Ingrid Calvo Ivanovic, Marta Elisa Cecchi, Clorinda Sissi Galasso, Ambra Borin, Claudia Mastrantoni, Martina Scagnoli</b>	<b>The Colours of Individual and Collective Memory: Mnemosphere, a Visual Atlas of Memory, Emotions and Atmosphere of Places</b>
<b>Susana Ribeiro</b>	<b>Bodygraphy - Chromatic performance on surrounding space</b>	<b>Luwen Yu, Stephen Westland, Vien Cheung, Guobin Xia</b>	<b>Analysis of research strategies to determine colour preference II: AFC, rank-order and rating</b>
<b>17:55-18:05 BREAK</b>		<b>17:55-18:05 BREAK</b>	
<b>ROOM 1</b> <b>18:05-19:05</b> <b>SPECIAL SESSION ILA - 2</b> <b>COLOUR, LIGHT &amp; SOUND: HOLISTIC APPROACH FOR WELLBEING</b> <b>Chairs: <i>Vicky Syriopoulou, Jeannette Hanenburg</i></b>		<b>ROOM 2</b> <b>18:05- 19:15</b> <b>SESSION 7 - COLOR AND DESIGN</b> <b>Chairs: <i>Dimitris Mylonas, Doreen Balabanoff</i></b>	
<b>Oral:</b>		<b>Oral:</b>	
<b>Gerald Zrenner</b>	<b>echobell - "Sound-pharmacy to go" Effective treatment with sound, vibration and light</b>	<b>Déborah Epicoco, Christine Mohr, Mari Uusküla, Michael Quiblier, Maliha Bouayed Meziane, Eric Laurent,</b>	<b>Making sense of free associations with PURPLE - A new coding scheme testing French speakers in three countries</b>

		<b>Domicela Jonauskaitė</b>	
<b>Angelika Klotz</b>	<b>Post-Pandemic Support with Colour, Light and Frequencies</b>	<b>Inez Michiels</b>	<b>Design Semantics Database</b>
<b>Valérie Bonnardel</b>	<b>Colour, Human experience and cyborgism</b>	<b>Martinia Ira Glogar, Sandra Flinčec Grgac, Antonia Zanchi Sarwari, Jose M. Canal</b>	<b>Interaction of Colour and Cotton Fabric Surface Coated with Ultrafine Cellulose (UFC)</b>
<b>Margo Ruiter</b>	<b>The power of earth colours</b>	<b>Guobin Xia, Philip Henry, Francisco Queiroz, Stephen Westland, Luwen Yu</b>	<b>Colour-cognitive performance interaction in Virtual Reality (VR): A study of gender differences</b>
<b>19:05-19:15 BREAK</b>		<b>19:05-19:15 BREAK</b>	
<b>ROOM 1</b> <b>19:15-20:45</b> <b>SPECIAL SESSION ILA - 3</b> <b>COLOUR, LIGHT &amp; SOUND: HOLISTIC APPROACH FOR WELLBEING</b> <b>Chairs: <i>Vicky Syriopoulou, Jeannette Hanenburg</i></b>		<b>ROOM 2</b> <b>19:15-20:25</b> <b>SESSION 8 - COLOR AND DESIGN</b> <b>Chairs: <i>Vien Cheung, Francesca Valan</i></b>	
<b>Oral:</b>		<b>Oral:</b>	
<b>Claudia Bonollo</b>	<b>The imagined body (2001-2021)</b>	<b>Delia Dumitrescu, Marjan Kooroshnia, Erin Lewis, Kathryn Walters</b>	<b>Colour, texture, and luminance: Textile design methods for printing with electroluminescent inks</b>

<b>Daniel Asis</b>	<b>Auricular Chromotherapy in the treatment of Psychological Trauma</b>	<b>Elizaveta Kushnirenko</b>	<b>Color in Fashion Design: orange that changed our perception of Luxury - the use of color at Hermès Paris.</b>
<b>Arzhan Surazakov</b>	<b>Principles of regenerative therapy with low-intensity laser, colour, ultrasound and magnetic field (coMra)</b>	<b>Xuechang Leng</b>	<b>The meaning of blue-green tiles on the roofs of the Qinzheng Hall complex at the Summer Palace</b>
<b>Abhay Wadhwa</b>	<b>Soul-X: The Experience Center for Mind-Body Harmony</b>	<b>Rebecka Pires</b>	<b>Application of color in domestic interior design: an analysis of the 1960s, 1970s and 1980s</b>
<b>Anadi Martel, Christophe Desteuque</b>	<b>Treating chronic pain and depression with color and sound: recent studies using the Sensora system</b>	<b><u>Short presentation:</u></b>	
		<b>Gianluca Guarini, Maurizio Rossi</b>	<b>Procedure to obtain trustful colors in renderings produced by BIM</b>
		<b>Ana Paula Pinheiro, Rui Duharte</b>	<b>Color and Sustainability in Fashion Design: DUARTE, Portugal</b>

## Wednesday September 1st, 2021 (2 parallel sessions)

ROOM 1 09:00-10:35 SESSION 9 -COLOR AND EDUCATION <i>Chairs: Robert Hirschler, Jodi Sandford</i>		ROOM 2 09:00-10:35 SESSION 14 -COLOR AND PSYCHOLOGY <i>Chairs: Osvaldo Da Pos, Alessandro Bortolotti</i>	
<b>Oral:</b>		<b>Oral:</b>	
<b>David Briggs</b>	<b>More than Three Dimensions: Communicating the Attributes of Colour Perception in Colour Education</b>	<b>Mahshid Baniani</b>	<b>What color is your mood? The association between moods and colors</b>
<b>Ching Chih Liao</b>	<b>Analysis and Application of Artwork Color - Awakening Students' Color Aesthetics and Narrative Ability through Artworks at the National Palace Museum in Taipei</b>	<b>Jinyoung Kim, Jiyeon Lee, Yungkyung Park</b>	<b>Why are common nature colors (soil, sand, trees, sky, stones, etc.) useful? Why does it go well with all colors?</b>
<b>Woon Lam Ng</b>	<b>Factors that Influence Color Choice - A Study of Cultural, Symbolical and Synesthetic Behaviors</b>	<b>Byeongjin Kim, Taesu Kim, Hyeon-Jeong Suk</b>	<b>Comfortable Brightness for Watching Television in the Dark</b>
<b>Gülru Mutlu Tunca, Saadet Akbay, Güler Ufuk Demirbaş</b>	<b>Parametric Design Studio in Interior Architecture Education: A Case of Integration of Colour Design</b>	<b>Akira Asano, Ayaka Shimura, Chie Muraki Asano</b>	<b>Effect of red color and external interferences in selection tasks</b>
<b>Paul Green-Armytage, Maggie Maggio</b>	<b>Beyond the Rainbow: A New Sorting Set for Teaching colour</b>	<b>Ray-Chin Wu, Chao-Lung Lee, Ming-Hsiu Mia Chen, Chien-Wei Chang,</b>	<b>A study on colour emotions of the mask</b>

		<b>Yun-Maw Cheng</b>	
<b>Short presentation:</b>		<b>Short presentation:</b>	
<b>Lea Jeong , Yungkyung Park</b>	<b>Color Names Education Effect on the Color Range Recognition</b>	<b>Andrew Chalmers</b>	<b>Is "Naturalness" a valid lighting concept</b>
<b>Jihye Choi, Paolo Calafiore</b>	<b>Colorful safety guide</b>	<b>Yoonjeong Jo, Yungkyung Park</b>	<b>Changes in Color Appearance and Preference of Rose Affected by Color Temperature and Illuminance</b>
<b>Junior Vendrami, Marley de Lira, Berenice Gonçalves</b>	<b>Educational resources based on augmented reality applied to Color Theory contents / UFSC</b>	<b>Ichiro Katayama, Kin'nosuke Yamaji</b>	<b>Effect of the shade due to the surface unevenness of objects on whiteness perception</b>
<b>10:35-10:45 BREAK</b>		<b>10:35-10:45 BREAK</b>	
<b>ROOM 1</b>		<b>ROOM 2</b>	
<b>10:45-12:00</b>		<b>10:45-12:00</b>	
<b>SESSION 10 - COLOR AND RESTORATION</b>		<b>SESSION 15 - COLOR AND PSYCHOLOGY</b>	
<b>Chairs: <i>Marco Gaiani, Anna Marotta</i></b>		<b>Chairs: <i>Cristian Bonanomi, Yulia A. Griber</i></b>	
<b>Oral:</b>		<b>Oral:</b>	
<b>Junglim Lee, Yungkyung Park</b>	<b>Colour Prediction Method of Digitalized Korean Court Documentary Painting</b>	<b>Muhammad Farhan Mughal, Ming Ronnier Luo, Michael R. Pointer</b>	<b>Perceived attractiveness across Chinese and Pakistani ethnic groups</b>
<b>Wensi Lin, Mengyue Zhang, Jisheng Wang,</b>	<b>The Experimental Restoration of the Colour of Nanjing Brocade from China</b>	<b>Tzuhao Liu, John Hutchings, Ming Ronnier Luo</b>	<b>The Valence and Arousal contribution of colour parameters</b>



Mengqi Li, Jing Chen			
Yuton Jiang, Luke Li, Yihua Zheng	Quantitative color examination and restoration of historical architecture: the study of polychrome decoration of a Qing-style timber-frame structure in Tsinghua University (Beijing, China)	Rui Vasques, António José Macedo Coutinho da Cruz Rodrigues, Diamantino S. Abreu	Visual and sensory perceptions between static and dynamic colors
Martina Redi, Sofia Ceccarelli, Alessandra Terrei, Noemi Orazi, Fulvio Mercuri	Diagnostic analysis for colour restoration of a painted Japanese <i>emakimono</i>	Pia Lopez-Izquierdo	The Emotional Language of Colour
Marcello Picollo, Costanza Cucci, Andrea Casini, Filippo Cherubini, Lorenzo Stefani	Hyper-Spectral Imaging Technique: Application for Colorimetric Analysis of Paintings	<b>Short presentation:</b>	
<b>12:00-12:20 BREAK</b>		Sachiko Noguchi, Rumiko Takata, Kaori Segawa, Ichiro Katayama	Application of color feelings prediction formulas to the estimation of two-color combination feelings of "kimono"
		Shi-Min Gong, Wen-Yuan Lee	Color Preference for Color Combinations Applied onto Three-Dimensional Color Configuration

	<b>Alessandro Bortolotti, Loreta Cannito, Stefano Anzani, Riccardo Palumbo, Maurizio Rossi</b>	<b>Lighting emotions: a review of the emotional influence of color perceived lightness</b>
	<b>12:00-12:20 BREAK</b>	

**ROOM 1**

**12:20-13:00 Invited Speaker**

**Austin Nevin "Conservation science and changing colours - Approaches to measuring and managing change"**

**Chair: *Marcello Picollo***

**13:00-13:15 BREAK**

**ROOM 1**

**13:15-16:15 AIC Study Groups Workshop**

**13:15 - 14:45 AIC 2021 Study Group on Environmental Color Design**

**Chairs: *Yulia A. Griber, Verena M. Schindler***

The authors of this session have not been subjected to double-blind peer-review. Therefore as requested by the AIC, they will not be published in the AIC proceedings series.

**-Zena O'Connor "Identifying and managing the factors that impact variability between specified and perceived color"**

**-Pablo Manyé "Variability of sociocultural colour associations related to the environment in Northeastern Brazil"**

**ROOM 2**

**13:15-16:15 AIC Study Groups Workshop**

**13:15 - 14:45 AIC 2021 Study Group on Arts and Design**

**Chair: *Maria João Durão***

The authors of this session have not been subjected to double-blind peer-review. Therefore as requested by the AIC, they will not be published in the AIC proceedings series.

**13:15 WELCOME REMARKS**

**13: 20 Jeannette Hanenburg "Art Classes at Ações Sociais Amigos Solidários (ASAS)-Florianopolis, Brasil. Room with a view - A case study"**

**13:45 ARTS & DESIGN VIRTUAL EXHIBITION (Part 1) - Curated by Maria João Durão**

**-Monica Kuo "East vs. West: How color is perceived differently in psychological and physical environments of different cultures"**

**-Kazim Hilmi Or "Colours of face masks used during Covid-19 pandemic and social messaging"**

**- Stig Evans "London's Largest Painting"**

#### **ROOM 1**

**14:45-16:15 AIC 2021 Study Group on Language of Color**

**Chairs: *Galina Paramei, Dimitris Mylonas***

The authors of this session have been subjected to double-blind peer-review. Therefore they will be published in the AIC proceedings series.

**- Emanuela Valeriani & Lourdes García Ureña "The language of color in the Bible (Hebrew, Greek, Latin): A methodology to approach the meaning of color terms"**

**- Maria Michela Del Viva, Ilaria Mariani, Carmen De Caro, Galina Paramei "Florence blues are clothed in triple basic terms"**

**- Mari Uusküla "From Welsh *gwyrd* to Italian *azzurro*: Translation of colour language between and within languages"**

**Galina Paramei & Dimitris Mylonas, Discussion & the SGLC by 2021**

**14:00 Larissa Noury "COLOUR HARMONY: ART, DESIGN & ARCHITECTURE.**

**Tactile painting & Haute Couture"**

**14:15 ARTS & DESIGN VIRTUAL EXHIBITION (Part 2) - Curated by Maria João Durão**

**14:30 DISCUSSION**

#### **ROOM 2**

**14:45-16:15 AIC 2021 Study Group on Color Education**

**Chairs: *Robert Hirschler, Maggie Maggio***

The authors of this session have not been subjected to double-blind peer-review. Therefore as requested by the AIC, they will not be published in the AIC proceedings series.

<b>16:15-16:30 BREAK</b>			
<b>ROOM 1</b> <b>16:30-17:10 Invited Speaker</b> <b>Giovanni Pinna "Lighting and color design in the show"</b> <b>Chair: <i>Maurizio Rossi</i></b>			
<b>17:10-17:15 BREAK</b>			
<b>ROOM 1</b> <b>17:15-18:15</b> <b>SESSION 11 - COLOR AND LIGHTING</b> <b>Chairs: <i>Andrea Siniscalco, Gianluca Guarini</i></b>		<b>ROOM 2</b> <b>17:15-18:35</b> <b>SESSION 16 - COLOR AND PSYCHOLOGY</b> <b>Chairs: <i>Galina Paramei, John McCann</i></b>	
<b>Oral:</b>		<b>Oral:</b>	
<b>Maurizio Rossi</b>	<b>A proposal for the definition of colored light sources in lighting CAD</b>	<b>Anna Marotta, Alessandra Brosio</b>	<b>Color as a therapeutic adjuvant: theories and applications in the hospital setting</b>
<b>Laura Bellia, Francesca Diglio, Francesca Fragliasso</b>	<b>Lighting quality for home-working spaces: a survey</b>	<b>Domicela Jonauskaitė, Christine Mohr</b>	<b>Colour-emotion associations: What have we learned so far and what are the unknowns?</b>
<b>Carolina Espinoza-Sanhueza, Claude Mh Demers, Jean-François Lalonde, Charles-Antoine Pelletier, Marc Hébert</b>	<b>Potential of colour in interiors for human light-responsive ambiances in northern locations</b>	<b>Barbara Matusiak, Marzieh Nazari, Kine Angelo</b>	<b>Colour shift due to Chromogenic dynamic glass</b>

<b>Laura Bellia, Urszula Błaszczak, Francesca Fragliasso, Lukasz Gryko</b>	<b>The colours of light in indoor environments: Mixing daylight and electric light spectra to define a proper match</b>	<b>Juan Serra, David De Andrés, Ana Torres</b>	<b>ColorDoku 3d, gamification to improve perceptual color discrimination ability and spatial vision</b>
<b>18:15-18:25 BREAK</b>		<b>Katherine Carpenter, Susan Farnand</b>	<b>Determination of the Representative Color of a Smartphone Image</b>
<b>ROOM 1 18:25-19:35 SESSION 12 - COLOR AND RESTORATION Chairs: <i>Austin Nevin, Marcello Piccolo</i></b>		<b><u>Short presentation:</u></b>	
<b><u>Oral:</u></b>		<b>Nian Xiong, Henry J. Trussell, Renzo Shamey</b>	<b>Psychophysical Study of the Perception of Color Gradient Boundaries</b>
<b>Guido Frison, Maurizio Aceto, Angelo Agostino, Dimitris Mylonas, Alberto Calatroni</b>	<b>Spectrographic analysis of the colourants of cultural items: from a qualitative to a semi- quantitative data treatment through BCTs</b>	<b>18:35-18:45 BREAK</b>	
<b>Jimena Vanina Odetti, Alberto Reyes González</b>	<b>Color, landscape and cultural heritage. The case of the Pitillal river, in Puerto Vallarta, Jalisco, Mexico.</b>	<b>ROOM 2 18:45-20:15 SESSION 17 - COLOR AND EDUCATION</b>	

		<b>Chairs: <i>Maggie Maggio, Verena M. Schindler</i></b>	
<b>Olivia Kuzio, Susan Farnand</b>	<b>LED-based versus Filter-based Multispectral Imaging Methods for Museum Studio Photography</b>	<b>Oral:</b>	
<b>Eric Kirchner, Carola van Wijk, Henni van Beek, Tammo Koster, Pim Koeckhoven</b>	<b>A new target to test color accuracy in technical photography of fine arts</b>	<b>Berta Martini, Rossella D'Ugo, Monica Tombolato</b>	<b>Teaching and learning color. An insight into STEM/STEAM approach</b>
<b>Short presentation:</b>		<b>Caroline Bouchez, Blandine Chorein, Dominique Corger</b>	<b>Color and Polymers at ITECH</b>
<b>Hortense de La Codre, Charlotte Marembert, Rémy Chapoulie, Laurent Servant, Aurélie Mounier</b>	<b>Hyperspectral mapping (VIS-SWIR) of materials of three 18th C. tapestries of Royal Manufactures in France (Gobelins, Beauvais, Aubusson)</b>	<b>Saara Pyykkö</b>	<b>How to convert the experience-based university course about colour, light and space for the web?</b>
<b>Márcia Hazin, João Pernão</b>	<b>The NCS color notation as a guide to produce colors from traditional pigments in conservation: The case study of two painted ceilings from eighteenth-Century Churches in colonial Brasil</b>	<b>Franca Zuccoli</b>	<b>Mario Lodi: "Children's colours are festive, flamboyant, vivid colours"</b>

<b>19:35-19:45 BREAK</b>		<b>Flora Gaetani, Fausto Brevi, Donatella Balloni</b>	<b>Color proposals consistency in the CMF for car design education</b>
<b>ROOM 1</b> <b>19:45-21:00</b> <b>SESSION 13 - COLOR AND BUILT ENVIRONMENT</b> <b>Chairs: <i>Anna Marotta, Larissa Noury</i></b>		<b>Craig Kirkwood</b>	<b>We don't know Jack about Hue - the Colour Knowledge Survey</b>
<b>Oral:</b>			
<b>Jean-Luc Capron</b>	<b>Spatio-temporal Factors of Colored Light Sequences in the Built Environment: the case of a choral concert - Part One</b>		
<b>Camilla Giani, Cristina Boeri</b>	<b>Children's colour preferences in the school context</b>		
<b>Estelle Guerry</b>	<b>Prehension and qualification of chromatic and lighting environment. Study case - Païmio Sanatorium, Alvar Aalto</b>		
<b>Justyna Tarajko- Kowalska</b>	<b>Is "yellow house" really "yellow"? Survey on determining the range of perceiving the yellow color on building facades depending on the hue, lightness and chroma.</b>		
<b>Ana Sutlović,</b>	<b>Plant Transfer Printing on Cotton and Silk</b>		

<b>Martinia Ira Glogar, Ivana Padavić, Koraljka Kovač Dugandžić</b>	
---------------------------------------------------------------------	--

### Thursday September 2<sup>nd</sup>, 2021 (2 parallel sessions)

ROOM 1		ROOM 2	
09:00-09:55		09:00 - 10:35	
SESSION 18 - COLOR AND MEASUREMENT/INSTRUMENTATION		SESSION 25 - COLOR AND COMMUNICATION/MARKETING	
Chairs: <i>Ming Ronnier Luo, Hyeon-Jeong Suk</i>		Chairs: <i>Anna Marotta, Larissa Noury</i>	
<b>Oral:</b>		<b>Oral:</b>	
Kanoko Makino, Kaoruko Kitamura, Haruno Tsuda, Yuki Oe, Nozomu Yoshizawa	Colour appearance of a white space with greenish daylight	Zena O'Connor	Data visualization: The power and persuasive capacity of color
Shimpei Fukagawa, Hiroyuki Iyota, Hideki Sakai, Mai Isomi	Development of color and gloss measurement system with wide-range temperature and humidity control unit	Qinyue Chen, hun Yan, Hyeon-g Suk	Designing Voice-Aware Text in Voice Media with Background Color and Typography
Raymond Chiang, Pei-Li Sun	Identify the characteristics of optically variable inks with deep learning	Boshuo Guo, Stephen Westland, Peihua Lai	Sentiment Analysis Based on Frequency of Colour Names on Social Media
<b>Short presentation:</b>			



Shuhei Watanabe, Takahiko Horiuchi	Estimation of authenticity model considering the colour: Leather as a case study	Daniela F. Pinheiro, Teresa Almeida, Domingos Loureiro	Color Specificity: the perception of difference through exhausting repetition
<b>09:55-10:05 BREAK</b>		<b>Short presentation:</b>	
<b>ROOM 1</b> <b>10:05 - 10:55</b> <b>SESSION 19 - COLOR AND MEASUREMENT/INSTRUMENTATION</b> <b>Chairs: <i>Takahiko Horiuchi, Dimitris Mylonas</i></b>			
<u>Oral:</u>		Anica Hunjet, Sandra Krizan, Dijana Vuković	Influence of wine color on wine selection and consumption
Jiaxun Zhang, Haisong Xu, Hao Jiang	Cross-media color reproduction under mixed adaptation condition	Lidija Mandić, Maja Strgar Kurečić	The role and significance of color when choosing cars
Ye Zhang, Kaiyin Chen, Shulei Ma	Study on colour effect of transparent material under colour-light	Peihua Lai, Boshuo Guo, Stephen Westland	Why do people choose their car colours?
Qinyuan Li, Jinxing Liang, Yan Lu, Kaida Xiao, Michael Pointer	Quantification of the effect of colour appearance and materials on the visual-tactile properties of fabrics	<b>10:35-10:45 BREAK</b>	
<b>ROOM 2</b> <b>10:45-11:40</b> <b>SESSION 26 -COLOR AND CULTURE</b> <b>Chairs: <i>Oswaldo Da Pos, Simone Garagnani</i></b>			

<b>Short presentation:</b>		<b>Oral:</b>	
Shahin Aldhahir	Differential Color Perception Theory	Jing Chen, Wensi Lin, Jisheng Wang, Mengqi Li	Digitizing and Recovering the Tacit Knowledge of the Traditional Color of China
<b>10:55-11:05 BREAK</b>		Zoriana Lotut	Reading Medieval Colour. The Case of Blue in the Canterbury Tales
<b>ROOM 1</b> <b>11:05-12:10</b> <b>SESSION 20 - COLOR AND DIGITAL</b> <b>Chairs: Arjan Gijzenij, Javier Hernández-Andrés</b>			
<b>Oral:</b>		<b>Short presentation:</b>	
Yiming Huang, Haisong Xu, Zhengnan Ye	HDR image quality evaluation for mobile displays		
Li Yumei, Liao Ningfang, Wu Wenmin, Deng Chenyang, Li Yasheng	Research on HDR image tone mapping algorithm based on modified ICAM06	Xiaochan Ge, Xue Mao, Jie Xu	Identifying the colour of Longquan Celadon Porcelain
Sandhiya Jayaprakash Brindha, Monica Vatteroni, Gabriele Simone	HDR imaging using CMOS technology inspired by human eyes for Automotive applications	Lia Luzzatto	Colors in the feminine between the Middle Ages and the Renaissance
Yi-Tun Lin, Graham Finlayson	Recovering Real-World Spectra from RGB Images under	Renata Pompas	Chagall e Malevič: the colors of the imagination and

	<b>Radiance Mondrian-World Assumption</b>		<b>the colors of the absolute</b>
<b>Short presentation:</b>		<b>11:40-12:20 BREAK</b>	
<b>Pengpeng Yao, Jack Hc Wu, John Xin</b>	<b>The use of LED-based illumination for Multispectral Imaging System</b>		
<b>12:10-12:20 - BREAK</b>			
<b>ROOM 1</b>			
<b>12:20:13:00 Invited Speaker</b>			
<b>Pietro Marani "Leonardo's color today: from the dark to the light"</b>			
<b>Chair: Maurizio Rossi</b>			
<b>13:00-13:30 BREAK</b>			
<b>ROOM 1</b>			
<b>13:30-15:30 <u>AWARDS</u></b>			
<b>Leslie Harrington - AIC Vice President will chair this session</b>			
<b>Vien Cheung - AIC President will show the CADE Medal</b>			
<b>Verena M. Schindler - Citation for Jean-Philippe Lenclos: the AIC Award for Colour in Art, Design and Environment (CADE) 2021 recipient</b>			
<b><u>Jean-Philippe Lenclos - CADE Award</u> Lecture: «Living in colour» - «Vivre en couleur»</b>			
<b>Leslie Harrington - AIC Vice President will show the Judd Medal</b>			
<b>Alessandro Rizzi - Citation for John McCann: the AIC Deane B. Judd Award 2021 recipient</b>			
<b><u>John McCann - Judd Award</u> Lecture: "Color Vision responds to Natural Scenes: Roles of Glare, Receptor Quanta Catch, and Neural Spatial Comparisons"</b>			

<b>15:30-16:00 BREAK</b>			
<b>ROOM 1</b> <b>16:00-17:15</b> <b>SESSION 21 - COLOR AND DIGITAL</b> <b>Chairs: <i>Pedro Pardo, Susan Farnand</i></b>		<b>ROOM 2</b> <b>16:00-17:15</b> <b>SESSION 27 - COLOR AND CULTURE</b> <b>Chairs: <i>Berit Bergstrom, Leslie Harrington</i></b>	
<b>Oral:</b>		<b>Oral:</b>	
<b>Cristian Bonanomi, Kedar Sathaye</b>	<b>Imaging colorimeters to evaluate Camera Monitor Systems</b>	<b>Dimitris Mylonas, Alexandros Koliouisis, Mari Uusküla</b>	<b>Synonymy in the language of colour</b>
<b>Simone Bianco, Marco Buzzelli, Gianluigi Ciocca, Raimondo Schettini, Mikhail Tchobanou, Simone Zini</b>	<b>Analysis of Biases in Automatic White Balance Datasets</b>	<b>Yannis Skarpelos</b>	<b>Color semantics in popular culture: Greek women's magazines and music albums colors in the postwar era</b>
<b>Chloe Game, Michael Thompson, Graham Finlayson</b>	<b>Chromatic Weibull Tone Mapping for Underwater Image Enhancement</b>	<b>Letizia Bollini, Martina Falta</b>	<b>Brides in black widows in white. Semantic evolution of the social and cultural meaning of the colours</b>
<b>Marco Buzzelli, Simone Bianco, Raimondo Schettini</b>	<b>Angle-Retaining Color Space for Color Data Visualization and Analysis</b>	<b>Mari Uusküla, David Bimler</b>	<b>The green-blue border does not depend on the number of blues in a language: Evidence from cross-linguistic colour-naming data</b>
<b>Short presentation:</b>		<b>Yulia A. Griber, Dimitris</b>	<b>Age-related differences in richness and diversity of</b>

		<b>Mylonas, Galina Paramei</b>	<b>Russian color lexicon</b>
<b>Ana Belén López-Baldomero, Manuel Rubiño, Carolina Ortiz, Carlos Salas</b>	<b>Comparison of color gamuts generated by digital printing devices under different conditions</b>	<b>17:15-17:25 BREAK</b>	
<b>Alfonso De Lucas Tron</b>	<b>The perceptual calibration of color. An exploration</b>		
<b>Hao Cui, Renzo Shamey</b>	<b>Diagnosis of Psoriasis using image segmentation and deep learning</b>		
<b>17:15-17:25 BREAK</b>			
<b>ROOM 1</b> <b>17:25-18:45</b> <b>SESSION 22 - COLOR AND DIGITAL</b> <b>Chairs: <i>Laura Bellia, Mark Fairchild</i></b>		<b>ROOM 2</b> <b>17:25-18:55</b> <b>SESSION 28 - COLOR AND CULTURE</b> <b>Chairs: <i>Robert Hirschler, Verena M. Schindler</i></b>	
<b>Oral:</b>		<b>Oral:</b>	
<b>Yuteng Zhu, Graham Finlayson</b>	<b>Designing a Single Pre-filter for Making a Group of Cameras more Colorimetric</b>	<b>KEYNOTE SPEAKER</b> <b>Clino Trini Castelli</b>	<b>Umbrella Diagram - 1981-2021, four decades of forecasts and CMF design</b>
<b>Jake McVey, Graham Finlayson</b>	<b>Fast and Optimal</b>	<b>Anna Marotta, Rossana Netti</b>	<b>Knowledge as a project parameter:</b>

	<b>Contrast Limited Tone Mapping</b>		<b>comparative colour theories</b>
<b>Arjan Gijsenij, Peter Spiers, Stephen Westland, Pim Koeckhoven</b>	<b>Deriving representative color palettes from mood board images</b>	<b>Anna Marotta</b>	<b>Scientific basics in art from the Theories of Color: Authors, methods, rules, applications</b>
<b>Emilie Robert, Magali Estribeau, Rémi Barbier, Gregory Swiathy, Justin Plantier, Pierre Magnan</b>	<b>Impact of the training data used in LLS optimization for faithful scene-specific color correction of raw images</b>	<b>Cristiana Bartolomei, Cecilia Mazzoli, Caterina Morganti</b>	<b>The building materials of Luis Barragán: light and colour</b>
<b>Short presentation:</b>		<b>Joaquim Santos</b>	<b>Tili Wiru Tjuta Nyakutjaku:* Towards an Extensive Cultural Paradigm</b>
<b>Barbara Blaznik, Franci Kovač, Grega Bizjak, Sabina Bračko</b>	<b>Fastness of black dye-based ink-jet printing inks in aqueous solution in the presence and absence of oxygen</b>	<b>18:55-19:05 BREAK</b>	
<b>Brandon Hoble, Graham Finlayson, Michal Mackiewicz, Julie Bremner, Tony Dolphin, Riccardo Arosio</b>	<b>Improving image registration using colour transfer methods in remote sensing applications</b>		

<p><b>Pedro Pardo, Francisco Díaz Barrancas, Halina Cwierz López</b></p>	<p><b>Color Constancy in virtual reality scenes. A first step toward a color appearance model in virtual reality</b></p>	<p><b>ROOM 2</b> <b>19:05-20:15</b> <b>SESSION 29 - COLOR AND CULTURE</b> <b>Chairs: <i>Mari Uusküla, Paula Csillag</i></b></p>	
<p><b>Marisol Fernández-Carvelo, Miguel Angel Martinez-Domingo, Eva M. Valero, Juan Luis Nieves, Javier Romero, Javier Hernández-Andrés</b></p>	<p><b>Band selection for different dehazing algorithms in the visible range</b></p>	<p><b>Oral:</b></p>	
<p><b>18:45-18:55 BREAK</b></p>		<p><b>Mark Fairchild</b></p>	<p><b>System for Visual Assessment of Wine Color</b></p>
<p><b>ROOM 1</b> <b>18:55-19:40</b> <b>SESSION 23 - COLOR AND MEASUREMENT/STRUMENTATION</b> <b>Chairs: <i>Renzo Shamey, Francesca Fragliasso</i></b></p>		<p><b>Petronio Bendo</b></p>	<p><b>Algorithmic Color Methods of Media Arts</b></p>
<p><b>Oral:</b></p>		<p><b>Short presentation:</b></p>	
<p><b>Esther Perales, Andrea Morales, Alejandro Ferrero, Juan Carlos Fernández-Becáres, Marjetka Milosovic, Joaquin Campos, Khalil Huraibat, Jorge Pérez, Valentín Viqueira</b></p>	<p><b>Impact of the color hue on the sparkle perception</b></p>	<p><b>Zhaohua Lei, Elza Tantcheva-Burdge, Vien Cheung</b></p>	<p><b>Investigation into the Colours of the DunHuang Murals from the Tang Dynasty</b></p>
<p><b>Khalil Huraibat, Esther Perales, Eric Kirchner, Ivo Van der Lans, Alejandro Ferrero, Joaquín Campos</b></p>	<p><b>Multiangle visual validation of a physically based rendering of</b></p>	<p><b>Henriette Jarild Koblanck, Monica Moro</b></p>	<p><b>Straw/Light - Colour</b></p>

	<b>goniochromatic colors</b>		
<b>Rada Deeb, Graham Finlayson</b>	<b>The Locus Filter</b>		
<b>19:40-19:50 BREAK</b>			
<b>ROOM 1</b> <b>19:50-20:15</b> <b>SESSION 24 - COLOR AND PRODUCTION</b> <i>Chairs: Maria João Durão, Filippo Cherubini</i>			
<b><u>Oral:</u></b>			
<b>Vesna Marija Potočić Matković, Ana Sutlovic, Martinia Ira Glogar</b>	<b>Colour fading in the polyurethane coating depending on the substrate and conditions of natural weathering</b>		
<b><u>Short presentation:</u></b>			
<b>Ji Eun Lee</b>	<b>Evaluation of Emotional Images According to Differences in Post-processing of Plastic Cosmetics Containers</b>		
<b>Georgina Ortiz Hernández, Citlali Q.</b>	<b>Shape, Color and Meanings.</b>		





<b>Ortiz Hernández, Oscar Francisco Bustamante</b>	<b>Comparison of Two Studies</b>	
--------------------------------------------------------	------------------------------------------	--

## Friday September 3<sup>rd</sup>, 2021 (single session ROOM 1)

**09:00-10:25**

### SESSION 30 - COLOR AND LIGHTING

*Chairs: Laura Bellia, Andrew Chalmers*

**Oral:**

<b>Hyeonju Park, Hyeon- Jeong Suk</b>	<b>Design Guidelines for Light Interfaces of Home Appliances</b>
<b>Jingyi Lin, Keyu Shi, Ming Ronnier Luo</b>	<b>Colour Performance Evaluation for LED Simulator Technology</b>
<b>Stine Louring Nielsen, Emma-Sofie Hestbech, Nanna Hasle Bak, Michael Mullins</b>	<b>Moving in Colour Illuminated Space: An Exploration of Analysis</b>
<b>Ayse Nihan Avci, Saadet Akbay</b>	<b>OLED Lighting and Human Circadian System: A Review</b>
<b>Short presentation:</b>	
<b>Lorrain Caumon, Georges Zissis, Céline Caumon, Élodie Bécheras, Estelle Guerry, Christelle Infantes</b>	<b>Colours, light &amp; well-being: characterisation of chromatic phenomena in collective housing</b>
<b>Andrea Siniscalco</b>	<b>A design approach to lighting and color rendering in indoor sets</b>
<b>Mengyuan Chen, Stephen Westland</b>	<b>User acceptance of innovative blue light therapy to treat seasonal affective disorder</b>
<b>Oscar Santilli</b>	<b>Colored light shapes. Protect and enhance the colors of artworks</b>

**10:25-10:35 BREAK**

**10:35-12:05**

### SESSION 31 - COLOR AND BUILT ENVIRONMENT

**Chairs: *Anna Marotta, Ralf Weber***

**Oral:**

<b>Sari Yamamoto</b>	<b>Practice-based research on color planning for educational facilities</b>
<b>Asako Nakamura, Fabrizio I. Apollonio, Marco Gaiani,</b>	<b>Urban color mapping in Tokyo: the case study of Hillside terrace</b>
<b>Lanqing Gu, Adamantia Batistatou, Yvonne N. Delevoye-Turrell, Jenny Roe, Martin Knöll</b>	<b>Using artificial ground color to promote a restorative sidewalk experience: an experimental study based on manipulated street view images</b>
<b>Changying Xiang, Barbara Szybinska Matusiak</b>	<b>Aesthetic Evaluation of Facade Integrated Coloured Photovoltaics Designs-an International Online Survey</b>
<b>Esra Küçükkılıç Özcan, Fatma Rengin Ünver</b>	<b>A screen experiment on the assesment of façade colour perception factors</b>
<b>Patrizia Falzone</b>	<b>Complexity of the theme of the Painted Façades in the large and medium historical centers in relation to the environmental contexts to which they belong</b>

**12:05-12:20 BREAK**

**12:20-13:00 Invited Speaker**

**Francesca Valan "Chromatic Sustainability: a new approach to color design"**

**Chair: *Andrea Siniscalco***

**13:00-13:30 BREAK**

**13:30-14:30 CLOSING CEREMONY**

**Marcello Picollo - Associazione Italiana Colore President chair this session**

**Valérie Bonnardel presenting the Color Group GB - Robert W G Hunt Poster Awards**

**Doreen Balabanoff - AIC 2022 Canada presentation**

**Pichayada Katemake - AIC 2023 Thailand presentation**



**Paula Csillag - AIC 2024 Brazil presentation**

**Tien-Rein Lee - AIC 2025 Taiwan presentation**

**Ceremony of the virtual passage of the Banner from AIC2021 to AIC2022 (video)**

**Alessandro Rizzi & Maurizio Rossi - AIC2021 Chairs short talk on the numbers of AIC2021**

**Vien Cheung - AIC President closing talk**

**14:30-15:00 BREAK**

**15:00-16:15**

**SESSION 32 - COLOR AND BUILT ENVIRONMENT**

**Chairs: *Fabrizio Ivan Apollonio, Fausto Brevi***

**Oral:**

<b>Doreen Balabanoff</b>	<b>Colour and Design of Birth Spaces: A transdisciplinary review of the literature</b>
<b>Zhaohua Lei , Fabrizio I. Apollonio, Marco Gaiani</b>	<b>A multiscale approach to the urban space color analysis starting from the case of study of the Collegio di Milano</b>
<b>Jenny Roe, Martin Knöll</b>	<b>The variability of 'green' and blue' in natural and built environments and the implications for restorative environment research and psychological wellbeing.</b>
<b>Filippo Cherubini, Andrea Casini, Costanza Cucci, Marcello Picollo, Lorenzo Stefani</b>	<b>Application of hyperspectral camera and spectroradiometer for spectroscopic and colorimetric measurements on polychrome surfaces in a controlled environment: pros and cons of the presented technologies</b>
<b>Jorge Llopis, Juan Serra, Irene De la Torre</b>	<b>Color, ceramics and architecture in the Spanish Renaissance. Serlian serial ceramics and their role in the construction of a new spatiality</b>

**16:15-16:25 BREAK**

**16:25-17:25**

**SESSION 33 - COLOR AND BUILT ENVIRONMENT**

**Chairs: *Marco Gaiani, Simone Garagnani***

<b>Oral:</b>	
<b>Beichen Yu, Simon Bell, Giorgio Ponzo</b>	<b>The emerging trend of saturated colour in the contemporary urban environment: an updated view of colour</b>
<b>Ralf Weber, Kine Angelo, Thomas Kanthak, Maya Weber</b>	<b>A Color Inventory of and a Color Guide to Dresden's Neustadt</b>
<b>Francesca Salvetti, Michela Scaglione</b>	<b>The use of color in the urban landscape through regeneration projects of the degraded open spaces of the city</b>
<b>Margherita Cicala, Luciano Lauda</b>	<b>The color in the street art of Gianluca Raro and Fabio Biodpì: between social impact and urban periphery in Scampia</b>
<b>17:25-17:40 BREAK</b>	
<b>17:40-18:30</b>	
<b>SPECIAL SESSION ALL THE RECENT BOOKS ON COLOR - 1</b>	
<i>Chairs: Verena M. Schindler, Yulia A. Griber</i>	
<b>Oral:</b>	
<b>Juan Serra</b>	<b>Color for Architects</b>
<b>Ana Torres</b>	<b>Modifications of the visual comfort in residential centers to improve the quality of life for the elderly</b>
<b>Berit Bergström</b>	<b>COLOUR CHOICES A practitioner's guide to creating colour schemes and design</b>
<b>Maria João Durao</b>	<b>'Colour: Urban Space, Architecture and Design'</b>
<b>Paula Csillag</b>	<b>Color Communication: a scientific approach from visual perception</b>
<b>18:30-18:40 BREAK</b>	
<b>18:40-19:30</b>	



**SPECIAL SESSION ALL THE RECENT BOOKS ON COLOR - 2**

**Chairs: *Verena M. Schindler, Yulia A. Griber***

**Oral:**

<b>Yannis Skarpelos</b>	<b>Book: The Uncertain Signs</b>
<b>Jodi Sandford</b>	<b>The Sense of Color: A Cognitive Linguistic Analysis of Color Words</b>
<b>Anadi Martel</b>	<b>Light Therapies - A complete guide to the healing power of light</b>
<b>Verena M. Schindler, Yulia A. Griber</b>	<b>Publications: The International Scientific Conference of the Color Society of Russia</b>

## INVITED LECTURES

### COLOR DEFICIENT SEE THIS WAY... OR DON'T THEY?

**Reiner Eschbach**

*Norwegian University for Science and Technology (NTNU)*

Color deficient vision has been studied for more than 200 years and we have built models that simulate color deficiency for a color normal observer. But is this really how a color deficient person sees? Or is there more to the human experience of “vision” than we include in our models? This talk will take a look at our understanding of color deficiency and show areas that can not easily be explained within current assumptions. As such, this talk tries more to establish a new look into the problem area than it tries to be a summary of the “as is”.



### THE INFLUENCE OF CFA CHOICE ON AUTOMOTIVE AND OTHER CRITICAL IMAGING SYSTEMS

**Robin Jenkin**

*NVIDIA Corp*

There are a wide variety of color filter array (CFA) colors and combinations available to modern imaging sensors intended for automotive applications. The spectral transmission curve of an individual filter dictates the wavelengths of interest, color saturation and the transparency of the filter and hence is one of the largest influences on the overall sensitivity and color fidelity of the sensor. Recently, combinations of pale filters including clear, yellow, magenta and cyan, have been used with more traditional red, green and blue colors, in an attempt to increase sensitivity. Typically, red, green, blue filters will have total transparency in the 400 to 650nm range of below 35% whereas, clear, yellow, magenta, cyan, in excess of 60%. This increase comes at the expense of effectively reduced color signals leading to larger terms in color correction matrices (CCM) that are subsequently applied and possible cross-correlation of noise between output color channels. Additionally, combining highly transparent channels, such as clear, with those that are less transparent, such as red or blue, can impact performance as exposure has to be reduced to avoid saturation in the most sensitive channel. This can further constrain the less transparent channels.



This work examines this tradeoff and its effect on post-CCM signal quality for a number of CFA combinations and typical automotive spectra of interest, such as traffic lights, signs, and lines. Signal and noise are traced through simulated systems to examine pre- and post-CCM signal quality, via color accuracy, signal-to-noise, modulation transfer function and noise equivalent quanta analysis. Further, the computational cost, benefit, and effect on MTF and post-CCM noise of pre-filtering chroma channels prior to applying the CCM is analyzed. Results are discussed within the context of human viewing and computer vision target applications.



## COLOR IN FASHION DESIGN

### Luca Missoni

*Artistic Director of the Missoni Archive*

Luca Missoni is the Artistic Director of the Missoni Archive that he's developing into a communication and research tool to valorize the Brand Heritage.

Tai and Rosita Missoni's second-born, he grew up artistically in the workshops of the factory. By the end of the 1970s he began working full time for the family company developing knitwear design, sparking interactions between technical advancements and the creative process: "I love discovering new potentials without compromising production, going beyond the results originally intended for a particular mechanism, to apply the art of our craftsmanship to the very outmost."

Formerly the creative director of the Menswear and Sport Collections, since 2007 he dedicated his efforts to give a structure to the archival material the family had been accumulating over more than 65 years of creative work in the fashion and design industry. He conceived and curated exhibitions as *MISSIONOLOGIA* in Florence and in Milan (1994), *Missoni Story* in Gallarate (1995), *OPERA* in Tokyo (1996), *Caleidoscopio Missoni* in Gorizia (2006), *Taller Missoni* in Madrid (2009), *Workshop Missoni* in London (2009), *Ottavio Missoni. Il Genio del Colore* in Slovenia and Croatia (2012), *MISSIONI, L'ARTE, IL COLORE* in Gallarate (2015) and in London (2016), *Marc Chagall - Ottavio Missoni, Sogno e Colore in Noto* (2017). He is also a photographer and a star-gazer. For Luca Missoni photography has always been an essential part of his visual research. Passionate of Astronomy, the Moon is the protagonist of his artistic statement recently acknowledged with the publication of his book *Moon Atlas*. He lives in Varese and New York with his wife Judith, an American artist.





## **CONSERVATION SCIENCE AND CHANGING COLOURS - APPROACHES TO MEASURING AND MANAGING CHANGE**

**Austin Nevin**

Department of Conservation, Courtauld Institute of Art

Colour in paintings and works of art is of fundamental importance in conservation, as is the understanding of the ways that pigments are used by artists to create different optical effects in paint. Part of conservation is technical study which involves understanding paint application, the layering pigments in a binding medium, and the role of the varnish or surface coatings – and work at The Courtauld Institute of Art has played a fundamental role in the understanding of the technology of easel paintings and wall paintings. My talk will highlight new research in the use of imaging and spectroscopic techniques for the visualization and mapping of pigments that will include wall paintings in India, Italy and Sweden. A vast range of pigments and layer structures are found in easel and wall paintings, from the single layers to multiple and complex mixtures found in Cypriot Byzantine wall paintings. Conservation is also faced with challenges related to pigment deterioration – which may often have a strong impact on the appearance of paintings and the colour of pigments. Indeed, many factors can affect paintings and the stability of pigments – from photooxidation as a results of light exposure of red and yellow organic lake pigments, to chemical reactions between pigments and binding media, to the degradation of modern pigments. Recent research can shed new light on the mechanisms behind colour change – and may suggest how we may be able to prolong the life of paintings. Here analytical techniques are of fundamental importance to reveal molecular changes on the microscale. Examples of research on cadmium and copper-based pigments from historical samples of easel and wall paintings and works by Picasso and Leonardo da Vinci will be shown.



## **LIGHTING AND COLOR DESIGN IN THE SHOW**

**Giovanni Pinna**

Live shows are about emotions and the LD is in charge of translating in visions what the audience hears. Freedom of expression and interpretation is unique in this field allowing us to design and create lighting settings following nothing else but our inspiration, taste and personality. Feelings and sensations and continuously involved and when it comes up to color choices, we often follow some kind of unconscious guide that develops in the creation of luminous scenes that compose each cue of our shows in the most personal suggestive way. There is a lot of technique and technical knowledge, necessary and essential to achieve our goals, that gives us a huge backup in the creative process ,but the “subjective factor” rules and color ,interacting with balance ,intensity,position and direction make the essence of our job.





## LEONARDO'S COLOUR TODAY: FROM THE DARK TO THE LIGHT

**Pietro C. Marani**

*Politecnico of Milan*

For a long time Leonardo has been considered a “chiaroscurista” Painter: this definition was formulated by Eugéne Muentz at the end of nineteenth century ( 1899 ) when his paintings were compared, according to the taste of the Romantic era, to those ones by Rembrandt. Furthermore the diffusion of the images of his paintings through the first photographs of mid-nineteenth century and the bad reproductions in popular books until a few decades ago did contribute to the idea that he was not familiar with colours and this concept also prevailed in art criticism of the first half of the twentieth century. Despite being well known that Leonardo dealt extensively with colours, light and coloured reflections in his Treatise on Painting and particularly on Colours Perspective, we have to wait the radical changes in art criticism caused by the important restorations which took place at the end of the last century, first of all the restoration of the Last Supper painted in “a secco” technique ( not in fresco technique ) in the Refectory of the Church of Santa Maria delle Grazie in Milan. This restoration lasted almost twenty years ( 1977-1999 ) and revealed the true colours of the composition remained covered under many layers of repaints for five centuries that produced ( together with the effect of alteration and pollution ) a very dark look of the painting. The restoration of the Adoration of the Magi at the Uffizi in Florence, in these last years, always considered to be a monochromatic painting, has revealed, in turn, to be an unfinished coloured painting as it is the Sainte Anne in the Louvre, which appears indeed, after recent cleaning, in all its subtlety of colour passages. Even the Leonardo's masterpiece, the Mona Lisa at the Louvre, should appear richly coloured, and not dark and yellowish, if a very light cleaning should be tempted to improve its look.



## CHROMATIC SUSTAINABILITY: A NEW APPROACH TO COLOR DESIGN

**Francesca Valan**

Color design is an activity that, dealing with different sectors in different geographical markets at the same time, allows to have a view on how the language of color evolves in product design around the world. Color language evolves also in relation to new technologies, and color project must evolve at the same pace: colored LED lights used as new accents, online shopping based on purely digital colors, etc. require new ways of interpreting color design.



The novel concept of Chromatic Sustainability responds to the need to reduce consumption, by extending the visual life of products through the use of new finishing with iconic colors, which have a longer lifecycle on the market.

The color design of a product involves well-defined phases. Firstly, the Historical Analysis of the brand identifies iconic colors and chromatic schemes. Competitor Analysis is the second step and is essential to conquer new markets. Trend analysis is one of the best-known phases in color design and leads to the definition of new Identity Scenarios. The color Tools design is less known, but it is the most strategic phase: it collects and analyses all the color data related to the brand and allows to plan the future color strategy. Only at the end of this process color is applied to the product.

This presentation will go through all these phases and present some examples that will show how this activity not only gives a product the most suitable color, but also defines and reinforces the Brand Identity.



## AWARD LECTURES

### AIC Award for Colour in Art, Design and Environment (CADE) 2021

#### Citation - Jean-Philippe Lenclos: Recipient of the AIC Award for Colour in Art, Design and Environment (CADE)

**Verena M. Schindler**

*Art and Architectural Historian, Zollikon, Switzerland  
Co-Chair, AIC Study Group on Environmental Colour Design  
ecd.studygroup@yahoo.com*



In 2021 Jean-Philippe Lenclos who is a colour designer, colour researcher, professor and visual artist has won the AIC Award for Colour in Art, Design and Environment (CADE). Established in 2015 the prize is to recognize those who excel in the areas of design, art, architecture and the humanities. The award is presented every two years at congresses of the International Colour Association (AIC). The selection is a rigorous procedure that includes nominations by AIC members and the analysis of the work of the nominees by a jury.

#### AIC CADE Award Lecture Living in Colour

**Jean-Philippe Lenclos**

*Colour Designer, Colour Researcher, Visual Artist,  
Professor Emeritus École nationale supérieure des  
Arts Décoratifs, Paris, France  
jeanphilippelenclos@wanadoo.fr ;  
<https://www.jeanphilippelenclos.com>*



Ph. Martin Lenclos

This AIC CADE Award Lecture outlines the biographical profile and career of a colour designer, colour researcher, and artist. It describes the interaction of the cross- and multidisciplinary universes in the fields of colour design related to urbanism, architecture, decorative arts, textile, and industrial design products, such as the ground transportation, aeronautics, household appliances, telephony, sports equipment, etc. It also draws attention to the philosophical, sociocultural, ethnographic, historical, semiological, symbolic, and practical foundations of *The Geography of Colour* as an inexhaustible subject of study under permanent development. Practiced individually or collectively, colour is a living material evolving through time and space. Further, it addresses colour education methodology in the various disciplines taught at art schools. The fields of colour design, colour research, and colour education are interrelated and ultimately nourished by creative art practices such as drawing and painting.



## AIC Deane B. Judd Award 2021

### Citation - John McCann: AIC Deane B. Judd Award 2021 recipient

**Alessandro Rizzi**

*Dept. Computer Science, Univ. Milano; [alessandro.rizzi@unimi.it](mailto:alessandro.rizzi@unimi.it)*

Color is the intersection of the physics of light, the psychophysics of appearance, and the art and technology of reproduction. John has a unique career; he is one of the few that deeply experimented in all these fields. This makes John one of the most influential persons in the field of color. These pages aim at summarizing his vast and fruitful work in which I had the honor and the opportunity to share a certain part. That made me a privileged observer. Many of the anecdotes reported come from direct experience, the others come from a long series of personal communications with John.

### AIC Judd Award Lecture

#### Color Vision responds to Natural Scenes: Roles of Glare, Receptor Quanta Catch, and Neural Spatial Comparisons

**John McCann**

*McCann Imaging; [mccanns@tiac.net](mailto:mccanns@tiac.net)*

The goal of human color vision research is to understand how we see Color. Our vision has evolved to guide us through the world's Natural Scenes. Appearances made by our color vision are the result of: optics of the eye, molecular quanta catch of receptors, and spatial image processing of neurons. The scene in front of the lens is the first critical variable in modeling vision. The spatial distribution of radiances coming to the eye initiates the first major visual event, namely intraocular glare. Imaging the retinal image redistributes the very large dynamic range of light in complex Natural Scenes. The second event is the receptors' response, namely, Light/Matter reactions in atoms and molecules. Color results from the different spectral sensitivities of rods and cones. The third event is that receptors initiate the network of neural spatial comparisons that lead to Appearances. This network is stimulated by the output of all receptors in the retina simultaneously. This talk is about the effects of scenes, glare, quanta catches, neural image processing, and Appearances. This talk introduces 8 different studies of vision that trace the light from the scene, through measurements of Appearances. It discusses Theoretical Color experiments, and practical Color technologies that respond to complex Natural Scenes.



**Citations for both the CADE Award 2021 and the Judd Award 2021 are reported in detail at the end of these Proceedings (p. 1437).**



## PREMIO COLORE GdC – ASSOCIAZIONE ITALIANA COLORE 2021 Vittorio Storaro

This year the “premio del Colore” award, conceded by the Gruppo del Colore – Associazione Italiana Colore, was given to Vittorio Storaro, who is considered to be one of the most influential cinematographers of all time.

Vittorio Storaro is an Italian cinematographer widely recognized for his work on numerous films now considered classics; he is well known and highly appreciated all over the world. He has won three Academy Awards for Best Cinematography and numerous other national and international awards.

He is originally from Rome where he began studying photography when he was only 11 years old; at 16 he graduated as maestro di fotografia, which roughly translates as Master Photographer. At 18 he was certified as Color Cameraman and became one of the youngest students attending and graduating from the Experimental Center of Cinematography.

In 1966 he had the opportunity to work with Bernardo Bertolucci as assistant cameraman in *Before the Revolution*, and in 1968 he was director of photography for the first time in *Giovinezza*, *Giovinezza* by Franco Rossi. After having worked with Dario Argento in *The Bird with the Crystal Feathers*, in 1970 he returned to work with Bertolucci in *The Spider's Strategy*, a film that marked the beginning of a fruitful collaboration between Storaro and the director. Storaro's first mainstream studio film was *Apocalypse Now* directed by Francis Ford Coppola in 1979, which resulted in Storaro earning his first Academy Award. He received his second Academy Award in 1981 for *Reds*, directed by Warren Beatty, and the third one for *The Empire of the Sun*, in 1987, directed by Bertolucci.

His research, training, and work experience have led him over time to recognize the fundamental meaning that color has in life. Storaro believes that it is not possible to express oneself in the visual arts, including cinematographic photography, without knowing the physiological, dramaturgical and philosophical meaning of colors, or what Leonardo da Vinci called the “children of light and shadow”. The study of color has been one of the greatest thrills of his life and his life philosophy focuses on the effects colors have on human actions and reactions, and how they influence human perception.







## **INVITED LECTURES**

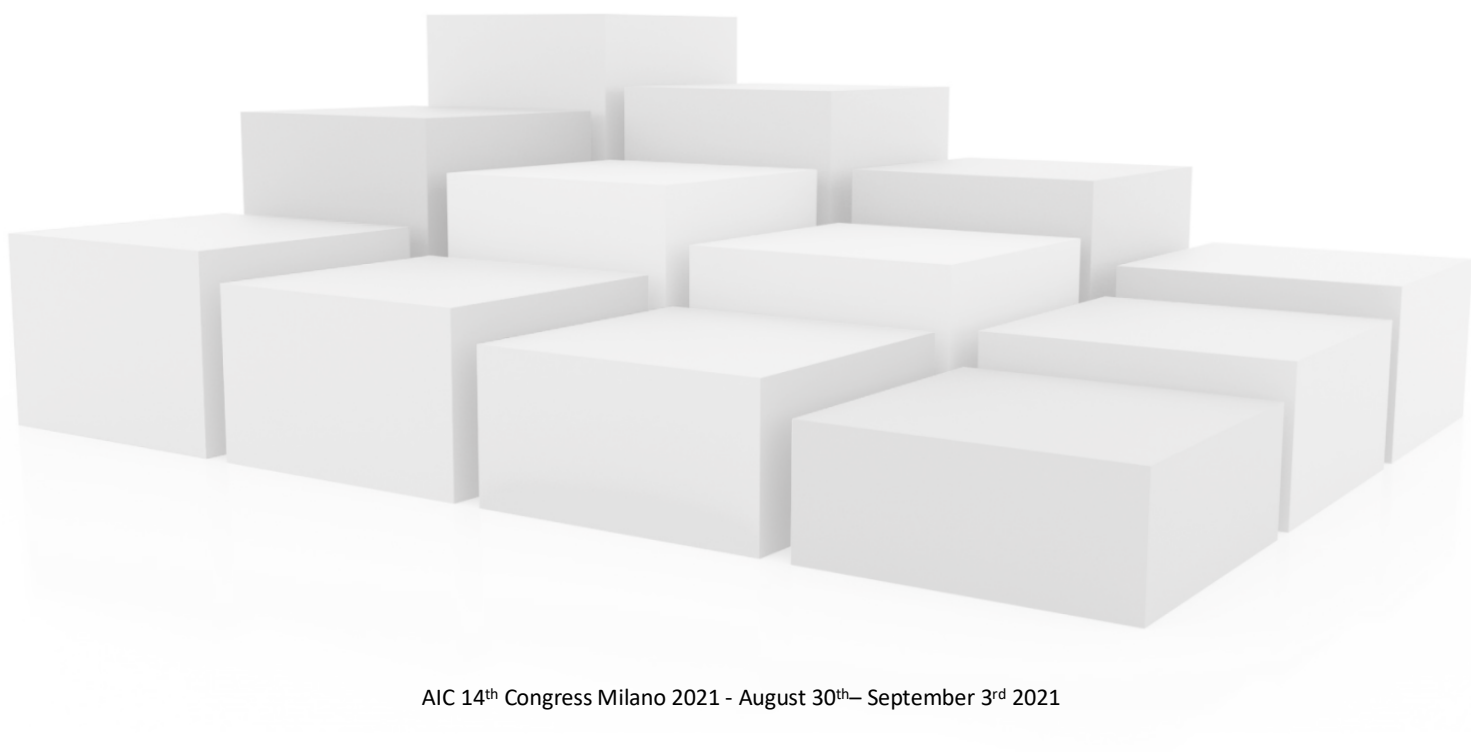

AIC 14<sup>th</sup> Congress Milano 2021 - August 30<sup>th</sup>– September 3<sup>rd</sup> 2021





# The influence of CFA choice on automotive and other critical imaging systems

Robin Jenkin <sup>1,\*</sup>

<sup>1</sup> NVIDIA Corporation; rjenkin@nvidia.com

\* Corresponding author: rjenkin@nvidia.com

## Abstract

The spectral transmission curves of a color filter array dictate the wavelengths of interest, color saturation and the transparency of the filter and hence is one of the largest influences on the overall sensitivity and color fidelity of an imaging sensor. Recently, combinations of pale filters including clear, yellow, magenta and cyan, have been used with more traditional red, green and blue colors, in an attempt to increase sensitivity for automotive applications. This increase comes at the expense of effectively reduced color signals leading to larger terms in color correction matrices (CCM) that are subsequently applied and increased cross-correlation of noise between output color channels.

This work examines this tradeoff and its effect on signal quality for a number of CFA combinations and typical automotive spectra of interest, such as traffic lights, signs, and lines. Signal and noise are traced through simulated systems to examine pre- and post-CCM signal quality, via color accuracy, signal-to-noise, modulation transfer function and noise equivalent quanta analysis.

**Keywords:** *Automotive, Color Filter Array, CCM, Sensitivity, Color Separation*

## INTRODUCTION

Driving is an inherently visual process. The systems of signs, lights and road markings intended for human viewing reflect this. Smart infrastructure to support autonomous vehicles is likely to take many decades to fully implement and may not reach remote locations. Therefore, some form of color capable camera is likely to remain the backbone of autonomous vehicles for the foreseeable future. Additionally, to save system cost, cameras often need to serve the dual functions of providing input streams for computer vision and human viewing, such as augmented reality or parking assist. Resultant images need to be of sufficient quality to present to the user, regardless of whether they facilitate successful object detection and perception of surroundings.

Autonomous vehicles represent the first mass deployment of camera systems as input to safety critical functionality. As such, automotive cameras are required to work across a wide range of illumination conditions and optimization of design has to occur across many parameters, such as pixel and sensor size, f-number, focal length, exposure regime and transmission. One such system design choice is the color filter array to be used with the sensor.

There are a wide variety of color filter array (CFA) colors and combinations available to modern imaging sensors intended for automotive applications. The spectral transmission curve of an individual filter dictates the wavelengths of interest, color saturation and the transparency of the filter and hence is one of the largest influences on the overall sensitivity and color fidelity of the sensor. Recently, combinations of pale filters including clear, yellow, magenta and cyan, have been used with more traditional red, green and blue colors, in an attempt to increase sensitivity. Typically, red, green, blue filters will have total transparency in the 400 to 650nm range of below 35% whereas, clear, yellow, magenta, cyan, in excess of 60%. This increase comes at the expense of effectively reduced color signals leading to larger terms in color correction matrices (CCM) that are subsequently applied and increased cross-correlation of noise between output color channels. Additionally, combining highly transparent channels, such as clear, with those that are less transparent, such as red or blue, can

impact performance as exposure has to be reduced to avoid saturation in the most sensitive channel. This can further constrain the signal-to-noise ratio (SNR) achievable in less transparent channels.

To explore the effect of CCM choice on imaging, a radiometric model of a camera system was created in a similar manner to that detailed by Jenkin (2021) and Jenkin and Kane (2018) previously. Color filter arrays for red, clear, blue, green, yellow and cyan channels were created and white point preserving color correction matrices for the camera system with different combinations of filters generated (Finlayson and Drew 1997). Simulations of the exposure of the camera systems to a Macbeth Color checker chart, various traffic signals, lights, signs and a sloping edge target (Jenkin 2005) were undertaken to determine the performance of color separation, noise, sharpness, noise equivalent quanta and a number of other key parameters.

## SIMULATION

A radiometric model of a 2.1 $\mu\text{m}$ , f1.6, camera system was created as detailed in previous work by Jenkin (2021). The exposure time, unless where otherwise specified, was set at 10ms as this is the shortest practical long (or base) exposure for a typical automotive system considering mains flicker. Read noise was set at  $1.5e^-$ , dark current at  $64e^-s^{-1}$ , dark signal non-uniformity (DSNU) at  $2e^-$  and photo-response non-uniformity (PRNU) at 0.5%. The transaction factor was set at 2.2, representing high conversion gain typical for the long exposure of a high dynamic range (HDR) sensor. The bit-depth of an individual exposure was 12 bits yielding a linear full well of approximately  $1860e^-$ . Lens and windshield transmission were set at 0.95 and 0.7 respectively. An infra-red cut off filter was modeled with a mean transmission of 0.95 at 50% cut-offs at 400 and 650nm, Figure 1.

Quantum efficiency curves representing red, green, blue, yellow, cyan and magenta channels were estimated using Fujifilm CFA materials as a starting basis (FujiFilm 2021). Transmission curves were individually scaled to typical peak quantum efficiencies of modern sensors. Additionally, a monochrome (or clear) channel was estimated and scaled to a typical peak value of 85%, Figure 1.

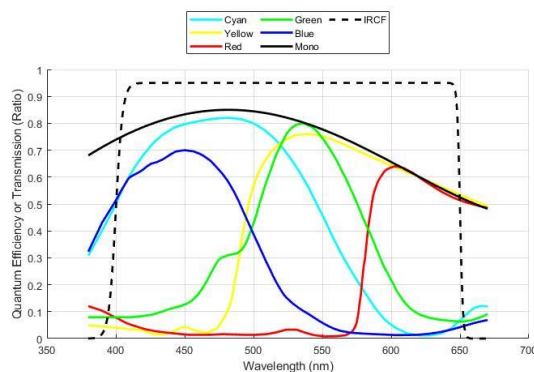

Figure 1: Quantum efficiency curves estimated for the simulation. Also shown is the infra-red filter modeled.

Spectra for various light sources including red, yellow and green led and incandescent traffic signals, a blue led, CIE D65 and a LED headlamp were obtained via published sources or measurement with a PR670 spectroradiometer, Figure 2, (Wisconsin 2021). Macbeth color checker spectral reflectance for each patch were obtained from BabelColor 2021. The spectral reflectance of traffic signs and lines were measured using an ATM510 Colorimeter, Figure 3 (Amtast 2021). Approximately 10 measurements each of yellow and white lines, a warning sign, a stop sign and a speed limit sign, which have been in situ for at least 10 years were measured and averaged.

Color Correction matrices were generated for RGB, RCB, RYCy and RCG configurations by simulating exposure of the sensors to each patch of the Macbeth color checker in combination with a CIE D65 light source at 50 lux to ensure no clipping of the output signal. Finlayson and Drew’s white point preserving least squares method was used to generate CCMs (Finlayson 1997) for each system using the illuminant as the white point for the calculation. This method was chosen in preference to a non-linear or iterative optimization as it is deterministic and considered the most equitable approach for the comparison of each system. Similarly, no noise or Bayer decomposition was used in the simulated exposure to reduce the influence of random noise and demosaic artifacts on the generated CCM. White balance gains were also calculated by using the ratio of the green or clear channels to the others for each system for the illuminant considered.

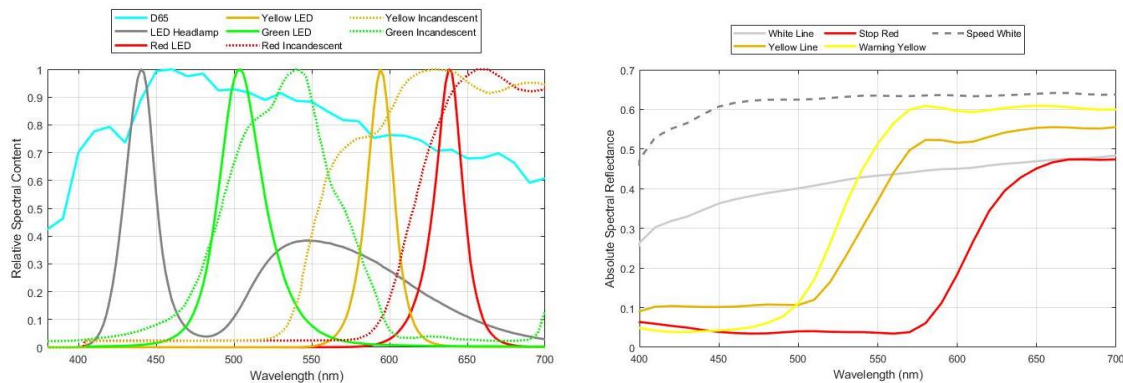

Figure 2(a) and (b): (a) Light spectra used in the simulation, obtained via measurement via a PR670 spectroradiometer or published sources (Wisconsin 2021). (b) Traffic sign and asphalt spectra used in the simulation, obtained via measurement via a ATM510 Colorimeter (Amtast 2021).

Simulated exposures of uniform fields were created by first scaling the selected light source spectrum to a specified lux value using the 2 deg CIE Standard Observer and cascading with a target spectral reflectance. Assuming a Lambertian surface, this is then used in the sensor simulation which accounts for lens geometry and transmission, windshield loss, the infra-red filter, pixel size and quantum efficiency per channel to yield photoelectrons per pixel at the sensor plane for a given exposure time. The photoelectrons per pixel are used in combination with other parameters to estimate the noise. The transaction factor is applied to generate  $n \times n$  pixel images for each channel in the sensor scaled to the bitdepth specified for an individual exposure with noise added. The  $n \times n \times 3$  pixel image is flattened to a Bayer representation by selecting the appropriate plane at each pixel position. White balance gains are applied followed by demosaicing. One of two demosaicing methods are used: bilinear or gradient, as described by Swirski and Burnett (2009) and implemented in MATLAB by Lin (2021). The appropriate CCM is then applied to yield a linear RGB image for the exposure. Clipping of the signal between 0 and  $2^{12}-1$  is applied after multiplication by the transaction factor, application of the white balance gains, demosaicing and application of the CCM in order to represent bit width constraints of the processing pipeline. Where appropriate  $L^*a^*b^*$  images were created by converting the linear RGB images using the same CCM illuminant as the white point. Color metrics and other measures may then be calculated from these images.

To generate sloping edge images from which to measure the modulation transfer function (MTF) a hyperbolic tangent is used to create a step edge image with a known profile and spatial frequency content as detailed by Jenkin et al (2005). The edge image is then degraded using a  $31 \times 31$  pixel finite

impulse response (FIR) filter accounting for the MTF of the pixel and the f-number of the lens. This degraded sloping edge image may be then by scaled by the photoelectrons calculated for a particular illuminant, light level, and surface spectral reflectance to yield an edge image as exposed by the system. Calculations may then proceed as above to yield a white balanced, color corrected, demosaiced image from which the spatial frequency response (SFR) may be calculated using ISO12233 (2017) as implemented by Burns (2020). Finally, the SFR may be corrected using the known spatial frequency content of the hyperbolic tangent to yield the MTF of the simulated system. The slope of the hyperbolic tangent edge is set at 1.5 and designed to yield an input modulation of approximately 0.25 at the Nyquist frequency of the simulated system to avoid aliasing. Similarly to images used for CCM generation, noise addition can be omitted to yield optimized measurements if desired.

**RESULTS AND DISCUSSION**

CCMs were generated for a CIE D65 white point for RGB, RCB, RYCy and RCG systems by exposing the simulation to a MacBeth color checker chart, Table 1. The constituent red, green, and blue, coefficients for a single channel appear in each row of the matrix. The white balance gains appear below each matrix and the columns under which they appear may be multiplied to yield the total gain.

	RGB			RCB			RYCy			RCG		
	Red	Green	Blue	Red	Clear	Blue	Red	Yellow	Cyan	Red	Clear	Green
Red Out	0.641	0.397	-0.039	0.463	0.902	-0.365	0.484	0.489	0.027	0.663	-0.114	0.450
Green Out	0.205	1.120	-0.325	-0.306	2.562	-1.256	-0.321	1.568	-0.247	0.384	-0.899	1.515
Blue Out	0.026	-0.278	1.252	0.161	-0.658	1.497	0.573	-1.369	1.796	-0.659	3.415	-1.756
White Balance Gains	1.904		1.276	4.113		2.758	2.523		0.968	4.113		2.161
Mean Delta E 2000		2.96			3.11			3.07			2.99	

Table 1: WPPLS CCM and white balance gains generated for RGB, RCB, RYCy and RCG systems for D65 and illumination. Also shown are the white balance gains for each system and the mean delta E<sub>∞</sub>.

In ascending order, the white balance gains for the RYCy, RCG, and RCB systems are higher than those of the RGB, indicating higher channel imbalance. The higher amplification in those channels indicates more noise being introduced to the system per unit exposure. Higher off-diagonals indicate stronger rectification required to yield corrected colors and increased channel mixing. In order, off-diagonals appear to become stronger for RGB, RYCy, RCB and RCG respectively. Of particular note is the higher component of clear than red in the red channel output for RCB. Also, the large negative blue component in the green output. For RCG, the blue output contains large differences between the clear and the green channel, as would be expected. Higher degrees of channel mixing leads to increased cross correlation of noise between channels, generally leading to increased chroma noise. More amplification of any channel may also lead to color artifacts being exaggerated. The high red and blue amplification in RCB systems can lead to flare being colored purple for example. Also, as shown in Figure 3, small artifacts after demosaic can be exaggerated by stronger CCM terms.

Higher noise, because of white balance gains, and chroma noise because of channel mixing, places additional pressure on subsequent noise reduction in the image signal processing (ISP) pipe. Increased visibility of demosaic artifacts after color correction leads to heightened pressure on the demosaic algorithms used and any subsequent color artifact de-coloring algorithms. Local optimization of a single component can create pressure elsewhere when considering the imaging system as a whole.

Table 2, over page, details luma SNR calculated using a luma channel formed using ITU BT.709-1 weights (0.2125, 0.7154, 0.0721) for the 12 lower patches of the MacBeth color checker chart.

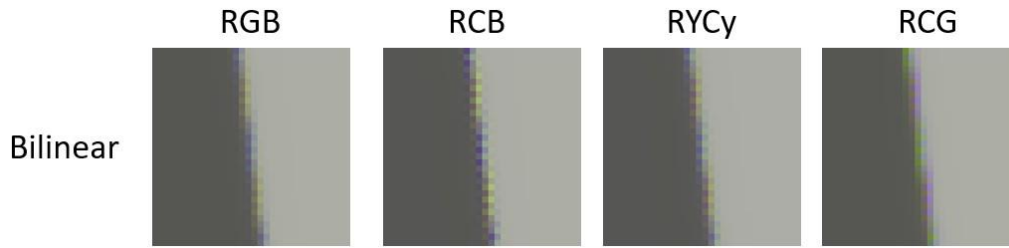

Figure 3. Edge patches for RGB, RCB, RYCy and RCG patches demosaiced with a bilinear method and color corrected using the white balance and CCMs in Table 1. The appearance of the artifacts relates to the strength of the white balance and CCM terms, appearing worse for stronger correction.

Each CFA combination is imaged at 100, 10 and 1 lux and bilinear, gradient and no demosaic applied. The CCM is omitted in one set of calculations, but white balance gain is applied in both. Prior to applying color correction it is clear that the RCB system has the best overall luma SNR for all light levels and demosaic methods applied. For strongly colored patches, such as the green, red, yellow and magenta the RCG system occasionally out performs the RCB. This is due to the lower sensitivity of the blue channel compared to the green channel for these two systems.

The high sensitivity of the clear channel in the RCB and RCG systems generates more photo-electrons than either the RYCy or the RGB systems. It is important to note however this is an un-color-corrected signal. The channels are operating in isolation and the output is unsuitable for human consumption. It may be possible that a deep neural network (DNN) could be trained to use this signal successfully to perform driving. These uncorrected signals, however, are unique to each imaging system and a change of CFA or other components that alter color significantly, such as the IRCF, would likely cause the DNN to require extra training. Color correction is necessary to generate human viewable content and to reduce data collection for DNN training.

Applying the CCM has a dramatic effect, reversing the order of performance of the systems. The RGB and RYCy systems provide the best luma SNR followed by the RCG and RCB. To reiterate an earlier point, the strong white balance terms and channel mixing causes noise in the less sensitive channels to be correlated into the luma signal. It may be seen that as the sophistication of the demosaic increases that some of the luma SNR for the RCB and RCG systems may be recovered. Of note though, is that at 1 lux using gradient based demosaic RYCy universally outperforms RCB. RGB has better luma SNR than RCB in 9 out of 12 patches.

It is recognized that further luma SNR gains may be made by increasing the demosaic sophistication beyond that used here and pre-filtering chroma channels before application of the CCM to avoid cross correlation of noise into the luma channel. The pre-filtering of chroma channels adds a not-insignificant number of operations to the demosaic. Typical automotive systems require 8 to 16 cameras with frame rates in excess of 30 FPS and computational loads are carefully balanced to ensure system safety.

Table 3(a) shows dynamic range and SNR 1 for each system. The dynamic range is calculated between the lux level at SNR 1 to 95% of the maximum response for the raw channels for patch 22 exposed at 100 lux for 10ms. The dynamic range for the most sensitive channels in each system are very similar, as would be expected as the underlying pixel performance is the same. The lux level at which SNR 1 is achieved for these simulated systems changes because of the difference in the channel sensitivity. If we consider the system as a whole and calculate the dynamic range as the lux level at which the least sensitive channel achieves SNR 1 to the point at which the first channel saturates, or



No CCM

Patch Number 13 - Blue			Patch Number 14 - Green			Patch Number 15 - Red			Patch Number 16 - Yellow			Patch Number 17 - Magenta			Patch Number 18 - Cyan				
RGB	RCB	RCG	RGB	RCB	RCG	RGB	RCB	RCG	RGB	RCB	RCG	RGB	RCB	RCG	RGB	RCB	RCG		
None 100	20.99	24.7	23.88	25.88	26.42	None 100	23.02	26.1	25.5	25.9	None 100	28.43	30.12	30.17	28.59	26.98	28.43		
10	9.08	13.81	12.59	14.22	15.18	10	11.32	14.55	14.51	14.99	10	18.07	19.77	19.56	20.37	10	13.83	16.73	16.57
1	1.09	2.36	2.49	3.75	4.63	1	1.48	3.52	2.86	3.62	1	4.91	7.34	7.21	7.75	1	2.35	5.07	2.71
Bilinear 100	22.76	27.19	22.88	26.47	26.47	Bilinear 100	24.98	28.18	28.06	29.09	Bilinear 100	30.9	32.92	32.33	32.51	Bilinear 100	27.03	30.48	28.79
1	11.41	15.81	10.24	15.1	17.21	1	13.43	17.23	16.6	17.99	1	19.84	22.26	21.98	22.29	1	16.01	19.1	15.93
1	3.16	4.87	2.78	4.51	5.45	1	4.12	5.53	5.09	5.45	1	7.66	9.62	9.39	9.95	1	5.18	7.75	6.26
Gradient 100	20.42	24.68	20.05	24.25	24.25	Gradient 100	22.82	26.68	25.51	26.46	Gradient 100	27.96	30.86	30.05	31.04	Gradient 100	25.63	28.88	26.75
10	8.76	14.2	8.52	12.85	14.25	10	11.11	15.61	14.49	15.24	10	18.06	20.42	19.62	20.76	10	13.09	17.43	13.61
1	1.34	3.35	0.98	2.82	3.11	1	1.53	4.13	2.5	4.08	1	5.01	7.92	7.04	8.66	1	2.55	6	4.01

With CCM

Patch Number 19 - White (0.05D)			Patch Number 20 - Neutral (0.23D)			Patch Number 21 - Neutral (0.44D)			Patch Number 22 - Neutral (0.70D)			Patch Number 23 - Neutral (1.05D)			Patch Number 24 - Black (1.5D)				
RGB	RCB	RCG	RGB	RCB	RCG	RGB	RCB	RCG	RGB	RCB	RCG	RGB	RCB	RCG	RGB	RCB	RCG		
None 100	30.91	33.63	31.46	33.26	31.7	None 100	29.01	31.73	30.26	31.7	None 100	26.97	29.73	28.3	29.7	None 100	24.63	26.91	25.41
10	20.38	22.83	21.59	23.99	23.99	10	18.5	21.28	19.91	21.52	10	16.01	19.02	17.43	18.75	10	13.2	15.73	14.13
1	8.53	11.17	9.73	11.29	11.29	1	5.78	9.66	7.46	9.19	1	3.95	6.68	4.72	6.71	1	2.1	4.44	2.84
Bilinear 100	33.17	35.2	34.14	35.34	35.34	Bilinear 100	31.08	33.44	32.08	33.54	Bilinear 100	26.53	29.44	27.39	29.21	Bilinear 100	23.11	25.74	24.04
1	22.66	25.03	23.83	25.11	25.11	1	21.19	23.78	21.71	23.29	1	19.04	21.33	19.38	20.86	1	10.24	13.91	11.78
1	10.5	13.07	11.87	14.07	14.07	1	7.73	12.01	9.2	11.68	1	5.68	9.39	6.71	9.03	1	2.63	4.13	3.29
Gradient 100	30.58	33.28	31.11	33.11	33.11	Gradient 100	28.38	31.26	30.01	31.51	Gradient 100	26.27	29.41	27.69	29.94	Gradient 100	20.48	22.96	21.57
10	20.02	23.18	21.4	23.03	23.03	10	18.34	21.58	19.39	21.4	10	15.43	18.35	17.28	18.89	10	8.06	12.07	10.17
1	7.52	11.63	9.52	11.73	11.73	1	6.01	9.9	7.24	9.49	1	3.9	7.71	4.72	7.38	1	0.92	2.56	1.56

Patch Number 13 - Blue			Patch Number 14 - Green			Patch Number 15 - Red			Patch Number 16 - Yellow			Patch Number 17 - Magenta			Patch Number 18 - Cyan				
RGB	RCB	RCG	RGB	RCB	RCG	RGB	RCB	RCG	RGB	RCB	RCG	RGB	RCB	RCG	RGB	RCB	RCG		
None 100	14.88	8.86	16.27	13.39	13.39	None 100	23.21	19.89	22.74	21.38	None 100	22.7	18.78	20.9	20.41	None 100	27.95	25.46	26.99
10	5.53	2.93	6.38	4.83	4.83	10	11.68	8.84	11.51	9.69	10	10.74	7.95	9.75	8.63	10	12.46	14.27	16.84
1	0.95	-1.14	-0.03	-0.39	-0.39	1	1.5	0	0.99	1.35	1	1.34	0.24	1.13	0.93	1	4.89	3.39	5.43
Bilinear 100	17.76	10.86	18.67	16.14	16.14	Bilinear 100	25.28	21.96	25.11	24.06	Bilinear 100	24.36	21.11	22.94	22.75	Bilinear 100	25.97	27.53	29.29
1	6.8	3.6	7.75	5.85	5.85	1	13.97	11.01	14.07	12.26	1	19.7	16.51	18.72	17.89	1	13.84	10.02	13.52
1	1.29	-0.79	1.03	0.95	0.95	1	3.31	0.79	3.14	2.96	1	6.45	4.18	6.94	5.84	1	3.36	1.91	3.19
Gradient 100	16.02	11.58	18.23	14.75	14.75	Gradient 100	33.53	33.47	25.24	23.12	Gradient 100	23.77	22.09	22.83	22.52	Gradient 100	24.25	21.59	24.67
10	4.75	4.32	7.22	5.4	5.4	10	12.58	11.55	14.1	12.09	10	11.69	10.93	11.69	9.87	10	13.2	10.86	13.89
1	0.64	-0.11	1.03	0.51	0.51	1	1.84	1.5	2.55	2.91	1	1.89	1.77	2.82	1.51	1	2.27	2.38	3.26

Table 2. Luma SNR (dB) for the lower 12 patches of the MacBeth Color Checker chart for RGB, RCB, RYC and RCG systems, with and without color correction matrices applied. No demosaic, bilinear and gradient methods were applied at 100, 10, and 1 lux. For each row the best SNR is indicated by green and the worse by red for each row. The exposure time is 10ms.

the system range for which we receive a viable signal from all three channels, it drops significantly. Dynamic range is best for the RGB followed by RYCy and then RCB and RCB. The dynamic range is dominated the imbalance between the red and clear channels for the RCB and RCG systems. Though this simulation is for an individual exposure, HDR systems would follow the same trend. Generally, shorter exposures designed to capture very bright sources do not contain LED flicker mitigation (LFM), whether the HDR functionality is provided by split pixel or sequential architectures. The high sensitivity of the clear channel will cause it to transition to exposures that do not contain flicker mitigation earlier potentially further causing issues with effective dynamic ranges over which computer vision may be performed.

Table 3(b) shows the color separation for combinations of traffic signals, lines and sign colors considered important for driving tasks. This is calculated as the separation in mutual standard deviations in the a\*b\* plane between the color coordinates of the objects when imaged by each system using a 32x32 pixel patch. The patches are white balanced, and color corrected prior to conversion to L\*a\*b\* and the mean and standard deviation of the a\*b\* signals evaluated before calculation of the separation,  $S_{ab}$ , using Equation 1.

$$S_{ab} = \frac{\sqrt{(a_{c1}-a_{c2})^2+(b_{c1}-b_{c2})^2}}{\frac{1}{2}(\sigma_{ac1}^2+\sigma_{ac2}^2+\sigma_{bc1}^2+\sigma_{bc2}^2)} \quad \text{Equation (1)}$$

where a and b are the mean a\* and b\* values of colors c1 and c2 and  $\sigma$  the standard deviation of the same. The metric is a quasi-detection value representing the Euclidean distance between the color coordinates divided by noise associated with each. Higher numbers will relate to better color discrimination. Red and yellow LED and incandescent traffic lights were simulated at 10,200 cdm<sup>-2</sup> with an exposure of 5 $\mu$ s. All other signs and lines were simulated using D65 at 100 lux and an exposure of 10ms. While the results should be considered a relative indication of trends, universally the RGB system shows the highest color discrimination followed by RCB, RYCy and RCG. The difference between RGB and RCB is markedly higher than that between RCB, RYCy and RCG. Undoubtedly, clear or monochrome channels yield higher numbers of captured photons, but this comes at the expense of color fidelity and the generation of chroma noise. Higher chroma noise requires increased noise reduction and may limit the strength of local tone mapping gains that can be applied. Large noise reduction kernels are needed to remove low spatial frequency noise and some residual chroma mottle may remain in images if they are not large enough.

	RGB	RCB	RYCy	RCG
Dynamic Range (Best Channel)	55.43	55.49	55.34	55.49
Dynamic Range (System)	49.86	43.18	47.15	43.18

	RGB	RCB	RYCy	RCG
SNR 1 (Best Channel)	1.82	0.84	1.39	0.84
SNR 1 Red Channel	3.45			

	RGB	RCB	RYCy	RCG
Red/Yellow LED	2.28	0.30	0.13	0.21
Red/Yellow Ind	1.16	0.30	0.16	0.08
Yellow/White Line	1.48	0.52	0.44	0.20
Red/Yellow Sign	2.21	0.68	0.62	0.24
Yellow/White Sign	3.75	1.16	1.28	0.47

Table 3(a) and (b). (a) Dynamic range and SNR 1 calculated for each system. (b) Color separation in terms of mutual standard deviations of separation as calculated for each system using Equation 1 for combinations of common traffic objects.

Figure 4 shows noise equivalent quanta (NEQ) calculated for each system with different demosaic algorithms applied. Noise equivalent quanta is a Fourier metric and has units of SNR<sup>2</sup> per unit area with respect to spatial frequency, calculated using Equation 2, (Keelan 2016).



$$NEQ(V_x, V_y) = \frac{MTF^2(V_x, V_y)}{NPS(V_x, V_y)/u^2} \quad \text{Equation (2)}$$

where  $v$  is spatial frequency, and  $u$  the mean linear signal. Using spatial frequency units of cycles per pixel this effectively becomes  $SNR^2$  per pixel. As  $SNR^2$  is the variance of the signal, it is also equivalent to the effective number of quanta per pixel with respect to spatial frequency for the exposure. Keelan (2016) gives an accessible description and examples of NEQ calculations for automotive imaging. Other treatments by Barrett and Myers (2004) and also Dainty and Shaw (1974) give good foundations on the topic.

The MTF is calculated using ISO12233. The simulation is exposed to a 64x64 pixel slanted edge created using a hyperbolic tangent function as described by Jenkin (2005). No noise is added to the exposure, but it is white balanced, demosaiced and color corrected. The spatial frequency response (SFR) is calculated using *sfrmat3* from Burns (2020). The SFR is corrected for the original spatial frequency content of the hyperbolic tangent target and a luma MTF is formed using the ITU BT.709-1 weights. The noise power spectra (NPS) is calculated using patch 19 of the Macbeth Color checker chart exposed to 100 lux D65 for a 10ms exposure. Noise is added, after which the target is white balanced, demosaiced and color corrected. The target size is 2048x2048 pixels and the block size for the NPS calculation is 128x128 pixels (Allen et al 2010:438-441). The NPS is calculated for each color-

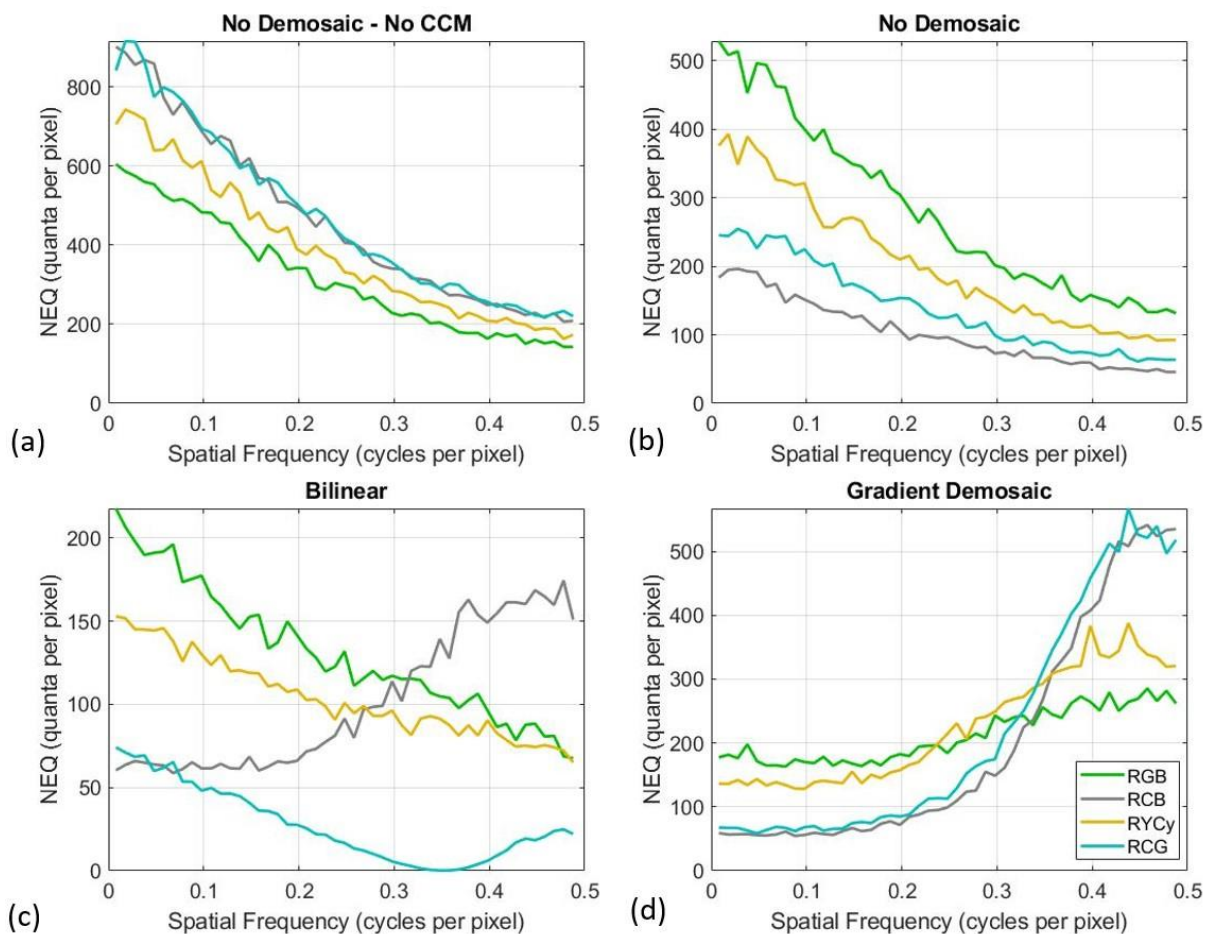

Figure 4(a) through (d). Noise equivalent quanta calculated for each CFA for patch 22 exposed at 100 lux for 10ms. (a) is white balanced though no demosaic or CCM is applied. (b) has white balance and CCM applied, though no demosaic. (c) is as (b) with bilinear demosaic and (d) with gradient demosaic applied.



corrected channel and a luma channel formed using the ITU BT.709-1 weights as for the MTF. The NEQ is calculated using the luma channels.

Figure 4(a) shows the NEQ (higher is better) calculated from raw signals values that have only had white balance applied and no CCM. No demosaic was used so the image is effectively a three channel full resolution exposure. Both the RCB and RCG have very similar responses due to the dominance of the clear channel in the output. RYCy outperforms RGB due to the increased sensitivity of the C and Y channels. When the CCM is applied is in (b) we see that the RGB system is largely undegraded, remaining with a DC NEQ of approximately 500 quanta, however, every other system suffers due to correlation of noise from less sensitive channels back into the most sensitive. Creating a Bayer image and subsequently demosaicing using a bilinear, (c), and gradient based, (d), demosaic we find all systems degraded. The number of quanta for the RGB system at DC has dropped to approximately 200 for the bilinear demosaic followed by 150 for the RYCy. The NEQ curve for the RCB starts at approximately a third of the value of the RGB and increases towards the Nyquist.

This should be thought of more as a decrease of the NEQ curve in the low spatial frequencies due to poor estimates of the red and blue signals at missing locations being correlated into the luma channel during correction with the strong CCM coefficients for the RCB system. The gradient demosaic, (d), attempts to combat this by estimating edge directions and can increase the RCB and RCG at Nyquist to in excess of 500 quanta, however, cannot improve the response in the low spatial frequencies. Both the RGB and RYCy systems also benefit somewhat from the gradient based demosaic towards the Nyquist frequencies. Up to approximately Nyquist/2, the RGB system has higher NEQ than any other system. The low NEQ at low spatial frequencies correlates well with the appearance of low frequency color mottle in RCB systems.

## **CONCLUSIONS**

Clear CFA channels generate more captured photons per lux second than green channels, but at the expense of color fidelity, separation, system dynamic range and placing increased pressure on demosaic, noise reduction and color artifact chroma reduction algorithms. The difference in sensitivity of clear, red and blue channels causes stronger white balance and CCM terms to be used, increasing cross correlation and amplification of noise. Color separation of typical traffic objects crucial to automated driving suffer as a consequence. Additionally, the clear channel may be pushed into a non-LFM range of operation far earlier than other channels. The low light sensitivity improvement of RCB systems is often considered on a component level when the analysis of the imaging system as a whole is more appropriate. While clear channels are more sensitive, they place more pressure on other system components. RGB channels are better balanced and provide better overall system response.

## **REFERENCES**

- Allen, E., and S. Triantaphillidou. 2010, *The Manual of Photography*, 10<sup>th</sup> ed. Focal Press.
- Amtast. 2021, <https://amtast.com/content-93.html>. Last accessed August 2021.
- BabelColor. 2021, <https://www.babelcolor.com/colorchecker.htm>. Last accessed August 2021.
- Barrett, H., and K.J. Myers. 2004, *Foundations of Image Science*, Wiley & Sons Inc.
- Burns, P., 2020, [http://losburns.com/imaging/software/SFRedge/sfrmat3\\_post/index.html](http://losburns.com/imaging/software/SFRedge/sfrmat3_post/index.html). Last Accessed August 2021.

- Dainty, J. C. and R. Shaw. 1974. *Image Science: Principles, Analysis and Evaluation of Photographic-type Imaging Processes*. London: Academic Press Ltd.
- Finlayson, G. D., and M.S. Drew. 1997, White Point Preserving Color Correction. In: *The 5<sup>th</sup> Color Imaging Conference*, Proc. IS&T.
- FujiFilm. 2021. FujiFilm Holdings Corporation  
<https://www.fujifilm.com/us/en/business/semiconductor-materials/image-sensor-color-mosaic/rgb/applications>, Last Accessed August 2021.
- ISO 12233. 2017. Photography — Electronic still picture imaging — Resolution and spatial frequency responses, <https://www.iso.org/standard/71696.html>. Last Accessed August 2021.
- ITU-R BT.709-1. 1993. Parameter values for the HDTV Standards for production and international programme exchange, <https://www.itu.int/rec/R-REC-BT.709-1-199311-S/en>. Last accessed August 2021.
- Jenkin, R. B. , R.E. Jacobson, M.A. Richardson, and I.C. Luckraft. 2005. Extension of the ISO 12233 SFR measurement technique to provide MTF bounds for critical imaging arrays. In: *Proceedings of the SPIE*, Volume 5668: 129-138.
- Jenkin., R., and P. Kane. 2018. Fundamental Imaging System Analysis for Autonomous Vehicles. In: *Proc. IS&T Electronic Imaging, Autonomous Vehicles and Machines*, Burlingame, California.
- Jenkin., R., and P. Zhao. 2021. Radiometry and Photometry for Autonomous Vehicles. In: *Proc. IS&T Electronic Imaging, Autonomous Vehicles and Machines*, Burlingame, California.
- Keelan, B. 2016. Imaging Applications of Noise Equivalent Quanta. In: *Proc. Electronic Imaging, Image Quality and System Performance XIII, Imaging Sci. and Technol.*
- Lin, J. 2021. demosaicing\_v2(input,type)  
[https://www.mathworks.com/matlabcentral/fileexchange/63628-demosaicing\\_v2-input-type](https://www.mathworks.com/matlabcentral/fileexchange/63628-demosaicing_v2-input-type), MATLAB Central File Exchange. Retrieved August 5, 2021
- Wisconsin. 2021. University of Wisconsin-Madison, Interdisciplinary Education Group,  
[https://chem.beloit.edu/edetc/background/LED/traffic\\_light/spectra.htm](https://chem.beloit.edu/edetc/background/LED/traffic_light/spectra.htm). Last Accessed August 2021.
- Swirski, L., and C. Burnett. 2009. CFA Interpolation Detection.  
<https://www.cl.cam.ac.uk/teaching/0910/R08/work/essay-ls426-cfadetection.pdf>, Last accessed August 2021.

# Leonardo's Colour today: from dark to light

Pietro C. Marani<sup>1</sup>

<sup>1</sup> Politecnico di Milano; [pietro.marani@polimi.it](mailto:pietro.marani@polimi.it)

\* Corresponding author: [pietro.marani@polimi.it](mailto:pietro.marani@polimi.it)

## Abstract

For a long time, Leonardo has been considered a “chiaroscurista” painter: this definition was formulated by John Ruskin (1843-1860) and by Eugène Muentz (1899) in the second half of the Nineteenth century, when his paintings were compared, according to the taste of the Romantic era, to those by Rembrandt. Furthermore, the diffusion of the images of his paintings through the first photographs of the mid-Nineteenth century together with the bad reproductions in popular books until a few decades ago, did contribute to the idea that he was not familiar with colours. This concept also prevailed in art criticism of the first half of the Twentieth century. Despite being well known that Leonardo dealt extensively with colours, light and coloured reflections in his Treatise on Painting and particularly on Colours Perspective, we have to wait the radical changes in art criticism that followed the important restorations at the end of the last century, first of all the restoration of the *Last Supper* painted in “a secco” technique (not in fresco technique) in the Refectory of the Church of Santa Maria delle Grazie in Milan. This restoration lasted more than twenty years (1977-1999). It revealed the true colours of the composition remained covered under many layers of repaints for five centuries that produced (together with the effect of alteration and pollution) a very dark look of the painting. The recent restoration of the *Adoration of the Magi* at the Uffizi in Florence, always considered to be a monochromatic painting, has revealed, in turn, to be an unfinished coloured painting as it is the *Sainte Anne* in the Louvre, which appears indeed, after recent cleaning, in all its subtlety of colour passages. Even Leonardo's masterpiece, the *Mona Lisa* at the Louvre, should appear richly coloured, and not dark and yellowish, if a very light cleaning should be tempted to improve its look.

**Keywords:** *Leonardo, Painting, Colour, Chiaroscuro, Restoration*

## INTRODUCTION

The critical debate on Leonardo da Vinci's colour started five centuries ago. Several critics argued that in his paintings he was interested in showing the effects of *chiaroscuro* rather than those offered by the use of colours. They devoted themselves to study the relations between colour and *chiaroscuro* in Leonardo's work. However, this attitude changed completely after the recent restorations of some of the most celebrated Leonardo's paintings, such as the *Last Supper*, *The Adoration of the Magi* and the Louvre *Saint Anne*. This section may be divided by subheadings.

From the time of Giorgio Vasari's *Vite* (first edition 1550; second edition 1568, see Vasari 1976), Leonardo was considered one of the best artists, within the Tuscan tradition, who tried to reach the “perfezione dell'arte” in representing “rilievo” (relief) in painting. Thus, he added a certain obscurity to the oil colours using deep and very dark shadows in contraposition to the clear areas. Hence, according to Vasari, Leonardo was in a very different position in relation to the use of drawing by Florentine painters as well as the use of colour in Venetian art. The relation between “colore” and “chiaroscuro” in Leonardo's work was better understood by the Milanese painter and writer Giovan Paolo Lomazzo who (1584; Lomazzo 1973-1974) argued that the peculiar character of Leonardo's art could be recognized in the movements of the mind and in the “lumi” (lights). Even if Lomazzo exaggerated the chromatic character of Leonardo *chiaroscuro*, he was able to underline the function of the light in the representation of the movements of the body. But for Leonardo - Lomazzo says - the movement is produced by the light, and light is indeed colour. Thus Lomazzo, for the very first time,

reached the true center of Leonardo's art.<sup>1</sup> To achieve perfection in painting, the artist can, thus, abandon the search for perfection in drawing and concentrate in the depiction of light effects, shadows and colours. From this time, the debate on the relation between colour and *chiaroscuro* runs until the Romantic age, when the painter's freedom and the new representation of natural and light effects gave rise to a renewed attention to Leonardo's *chiaroscuro*.

Between the end of the Eighteenth century and the beginning of the following century, Leonardo's paintings were translated in many copies, engravings and prints in which the use of "disegno" became fundamental. Leonardo's paintings were approached like monuments of the classic age (the Renaissance) and compared to antique works of art. They were perceived as ancient monuments to be understood and reconstructed, or restored, with tools and methods similar to those ones used by the first archaeologists to reconstruct classical monuments. The translation of the subtle and delicate effects of *chiaroscuro*, typical of his paintings - such as the *Last Supper* (Figure 1) - in dry engraved lines and a monochromatic look is particularly evident in the famous engraving of the *Last Supper* executed by Raffaello Morghen (between 1797 and 1800)<sup>2</sup> (Figure 2).



Figure 1: Leonardo da Vinci, *The Last Supper*, 1494-1498. Milan, Refectory of the church of St. Maria delle Grazie.



Figure 2: Raffaello Morghen, *L'Ultima cena (The Last Supper)*, from Leonardo, engraving (acquaforte), 1797-1800. Milano, Castello Sforzesco, Raccolta Bertarelli (F.S.8/17).

It is evident that neither problem of colour, nor understanding of Leonardo's *chiaroscuro* were among the concerns of the engravers and artists of this time. They only aimed to reconstruct a composition already damaged. As is well known, the state of preservation of the *Last Supper* was very bad because of Leonardo's particular technique (*tempera* on wall, i.e. a *secco* technique) and the damages caused by time and by previous restorers. The latter added new materials, new pigments, oils, and varnishes to the original surface of the mural, obtaining, in the process of time, a very dark look of the surface of the painting. Indeed, the idea was to go back to the original "drawing" of the *Last Supper*, not to its original colours. When John Ruskin wrote his fundamental work on the *Modern Painters* (Ruskin 1843-1860),<sup>3</sup> Wolfgang Goethe, had already written that "Light is the truth... darkness is the fake",<sup>4</sup> probably referring to the *Last Supper*. A sentence that recalls Leonardo's one: "Verità: il sole. Bugia: maschera" (The truth: the sun. The lie: the mask).<sup>5</sup> Probably also, for this reason, Ruskin considered Leonardo among the "Chiaroscuristi" painters, the other two categories he adopted being

<sup>1</sup> As it was noted by Venturi 1919, p. 112.

<sup>2</sup> On the "archaeological" attitude of the artists in the second half of the Eighteenth century on the *Last Supper* see now Marani and Mori, eds., 2017.

<sup>3</sup> Ruskin 1843-1860. See the recent critical Italian edition Ruskin 1998.

<sup>4</sup> See Venturi 1919, p. 132. This sentence is in a Goethe's letter to Friedrike Oeser published by Seidlitz 1909, II, p. 263.

<sup>5</sup> A Leonardo's passage (Windsor, Royal Library, inv. CIN 912700) quoted and commented in Chastel 1982, p. 16.

the "Linearisti" and the "Coloristi" painters. The "Coloristi" were the only true and real painters, given that colour goes beyond *chiaroscuro*. Ruskin also argued that Leonardo is one of "Chiaroscuristi" who was only able to draw, and occasionally to paint, and that also the artists of the Dutch school did the same, without any genius for colour.

It is probably following this judgement that forty years later, Eugene Muentz, in his important monograph on Leonardo published in French and English in 1899, compared Leonardo to Rembrandt. Speaking about the *Portrait of a Musician* in the Pinacoteca Ambrosiana in Milan, he wrote: "Two other pictures in the Ambrosiana, one of a man, the other of a woman, seem to belong to the category of official portraits. The first, a bust three-quarters to the front, represents a beardless man of about thirty; in a red cap and black doublet, relieved by two bands of brown. In spite of a vigor of modelling worthy of Rembrandt, the work lacks freedom and individuality. The expression is sullen. The painter seems to have taken little pleasure in his task. The excessive brownness of the colour also injures the general effect".<sup>6</sup> Muentz's statements were contradictory, since he also liked Rembrandt's work for its vigor of modelling (Figure 3). Furthermore, he based his judgement either on a bad photo of the *Musician* or on the original painting, at that time overpainted and darkened, as a photograph of the end of the century, taken before the cleaning of 1904, demonstrates (Figure 4).



Figure 3: Rembrandt Harmenzoon van Rijn, *Selfportrait*. 1640. Londra, National Gallery.



Figure 4: Leonardo da Vinci, *Portrait of a Musician*. 1485-87. Milan, Pinacoteca Ambrosiana. Photographed before the early Twentieth-century restoration.



Figure 5: Leonardo da Vinci, *Portrait of a Musician*, after 1904 cleaning and removal of the overpaintings.

When Muentz was writing (1899), the painting was still considered to be a "Portrait of a Duke of Milan" because the sitter's right hand with a sheet of music had not yet been discovered under the repaints. Anyhow, Muentz's comments on the *Musician* sound a little bit strange given that elsewhere he admired Leonardo's dark tonalities. And indeed, he wrote about the Uffizi *Adoration* that Leonardo "substitutes a subtle scale, made up of subdued tints, such as bister and bitumen; <and> in these matters he was more ingenious than Rembrandt himself".<sup>7</sup> On the *Adoration* we will discuss later on. The *Musician* was restored in 1904 by Luigi Cavenaghi and Antonio Grandi, and a different image appeared, less dark and less brownish than it seemed to Muentz, and new in the composition; in fact

<sup>6</sup> Muentz 1899, English edition, vol. I, pp. 207-8, footnote 1. For recent comments on Muentz's point of view see Marani 1999, and Marani 2019, pp. 156-157.

<sup>7</sup> Muentz 1899, I, p. 76.

the right hand was discovered underneath (Figure 5), and this changed the identification of the sitter totally. From this moment onwards the painting was called "A portrait of a Musician".<sup>8</sup>

The quality of the photographs in the second half of Nineteenth century, and their dissemination in books and prints, but also the state of preservation of Leonardo's originals at that time, do not facilitate the understanding of Leonardo's colour. Exactly twenty years after Muentz book, a very first effort to understand the use of the colour in Leonardo's paintings was made by Lionello Venturi<sup>9</sup>, who underlined Giovan Paolo Lomazzo's important role in the comprehension of Leonardo's color and light. Venturi, who followed the critical debate from Lomazzo's time until his years, tried to define Leonardo's *chiaroscuro* and "sfumato" in their specific value and historical role. From Muentz's time, it seems than more than a century had passed. After a period of over-evaluation of Leonardo's work as a technician and a scientist between the two World Wars, in coincidence with the propaganda definition of Leonardo as an "Italian genius" promoted by Fascism, the debate on Leonardo's colour was resumed in the sixties of the Twentieth century by John Shearman.<sup>10</sup> According to this author there is no opposition between *colore* and light and shadow (*chiaroscuro*) in Leonardo's painting. Thus it is not correct to separate colour from *chiaroscuro*. Even if he seems, in the exam of Leonardo's paintings, to contradict himself, because he observes a continuous development in Leonardo's career, i.e. a change in Leonardo's style from the Florentine works to the Milanese ones, in a progressive "development of tonal unity". Anna Maria Brizio immediately criticized this point of view in her review of Shearman's article.<sup>11</sup> She argued that, from a historical perspective, light and shadow were no more the physical result of a particular use of colour, and instead became a new vision and a new style that marks a different historical moment in which *chiaroscuro* is rightly opposed to colour.<sup>12</sup> She poses, definitively, the need to define the point of departure of a historical change in style that eventually arrived until Caravaggio.

Thirty years after Shearman's essay the problem of the relation between colour and *chiaroscuro* was again reconsidered by Claire Farago (Farago 1991). Forgetting Brizio's statements and Brizio's review, it was also re-proposed very recently by Alessandro Nova. He tried to re-read Shearman's arguments,<sup>13</sup> comparing Shearman's ideas expressed in the 1962 article with the more extensive and deeper treatment of the use of colour in early Renaissance Tuscany that Shearman did in his Ph.D. dissertation of 1957.<sup>14</sup> In this work, Shearman was more open to considering that colour can be "a possible subject of historical analysis" Nova considers this as "a major contribution to the history of art. Shearman's argument seems to imply that colour is culturally coded, a point made absolutely clear in the memorably lucid introduction to his thesis" (Nova 2019: 378-79). According to Nova, however, Shearman's essay of 1962 "has taught us to concentrate on the original lighting conditions when viewing works of art *in situ* and on their effect on the shades of colours" (Nova 2019: 389). Besides further recent contributions to this topic, and particularly to the problem of coloured shadows in Leonardo's painting and theory,<sup>15</sup> the attention can now be exactly directed to the material aspects of some of Leonardo's paintings, as they appear after recent restorations and in their original conditions of light.

<sup>8</sup> On this painting see now Marani 2010.

<sup>9</sup> Venturi 1919.

<sup>10</sup> See Shearman 1962.

<sup>11</sup> Brizio 1964.

<sup>12</sup> "Luce ed ombra cessano di essere il risultato materiale, fisico di un determinato modo di maneggiare il colore e si fanno un modo di visione nuova, nuovo stile, e, nella conversazione del critico, nuova categoria visuale, diverso momento storico e, come tale, legittimamente contrapposibile al colore": Brizio 1964, p. 413.

<sup>13</sup> Nova 2019.

<sup>14</sup> Shearman 1957.

<sup>15</sup> Fiorani 2008; Summers 2013.



The most important advancement in our understanding of Leonardo's colour was, without any doubt, related to the restoration of the *Last Supper*, executed by Pinin Brambilla Barcilon between 1977 and 1999, under the direction of the Soprintendenza per i Beni Artistici e Storici di Milano (Superintendence for Cultural Heritage). Important fragments of the original Leonardo's colours were discovered after removing a significant part of the repaints that, from the end of Sixteenth century until the first half of the Twentieth century, were added over the original layers of ground preparation and on what remained of the original pigments by Leonardo. On these discoveries, important pieces of information were first given on various occasions by Carlo Bertelli (Bertelli 1982; Bertelli 1986). The discovery of the "true" colour of the *Last Supper*, clear, brilliant, and very luminous (Figure 6), forced critics to re-write the history of painting in Northern Italy and to give back to Leonardo a very important role in the dissemination of the 'Maniera moderna' in Lombardy (Romano 2005; 2011) and the use of brilliant colours, the so-called *cangianti*, and the effects of light on draperies and objects. The discovery of Leonardo's colours in the *Last Supper* explains the reception of his art and theories in Lombardy at least until the mid-Sixteenth century.



Figure 6: Leonardo da Vinci, *The Last Supper*, 1494-1498. Milan, Refectory of the Church of Santa Maria delle Grazie. After Pinin Brambilla's restoration (1977-1999).

New features were also discovered regarding the technique and the solutions adopted by Leonardo in rendering the transparencies of glasses, the effects of the light on the draperies according to the illuminated parts or on those ones in shadow, the effects to the light coming from the real windows of the Refectory on the faces and apostles expressions, the variations in rendering with extreme accuracy and objectivity the still life on the table and its tablecloth (Figure 7), the coloured reflections on dishes and the sense of luminosity in the far landscape. These and many other novelties were the object of a book presenting all the aspects of the restoration (Brambilla Barcilon-Marani 1999; see also Marani 2018). Here, for the very first time, it was noticed that the various layers of colours used by Leonardo, namely in the blue areas, as for example, on the St. Matthew robe (Figure 8), the superimposition of two layers of different blue (azurite plus lapis lazuli), very transparent and thin, painted on two layers of white (calcium carbonate and magnesium, plus white lead), permit to the real light (coming through

the real windows on the left wall on which the painting is situated) to penetrate through the pictorial film. This is the reason of the extraordinary luminosity of the overlying colour, almost if it is *luminescent* in itself. By this way, the lapis lazuli blue seems almost *iridescent*, i.e. very brightening, as having the power of light in itself (Marani 2014: 164).

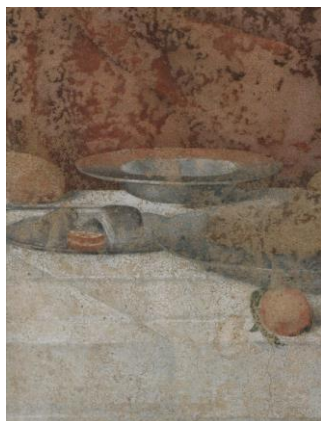

Figure 7: Leonardo da Vinci, *The Last Supper*, 1494-1498. Detail of the still life on the table after Brambilla's restoration.



Figure 8: Leonardo da Vinci, *The Last Supper*, 1494-1498. Detail of the drapery of St. Matthew after Brambilla's restoration.

The exact use of different layers of colours to obtain effects of luminosity can be observed in the execution of red and green parts of the draperies and the faces of the apostles. Here the softness and accuracy of St. Matthew's face (Figure 9) is one of the best demonstrations that the last restoration has reached the original and final layers of the painting indeed. These colours are not simply the "physical colours" revealed under a lot of repaints. They appear as the result of a particular Leonardo treatment in order to represent the colours as they are seen through the atmospheric *medium*, according to Leonardo's theory of the so-called *aria grossa* (the air containing all impurities and eventual pollution) theorized in the *Treatise of Painting*.<sup>16</sup>

The removal of ancient additions to the *Last Supper* has also aroused the problem of the retouchings and restorations as an element of distortion in the perception of the mural. The great part of the ancient literature on the *Last Supper*, before the last restoration (1977-1999), offers in many cases distorted readings caused by the overpaintings, or, even worst, by photographs and prints intentionally retouched. In no other way can we explain Kenneth Clark's use of the term "grimaces" for the apostles' expressions and heads in the *Last Supper*.<sup>17</sup> because he was looking to faces so much repainted by restorers, that their original expressions were completely changed and altered.

After Brambilla's restoration, the discovery of the original colours in the *Last Supper*, despite its fragmentary state, also confirms that it is thanks to the colour that Leonardo was able to give shape and real volume to the monumental figures he painted. Ernst Gombrich was so smart to observe, even well before Brambilla's restoration, that in the *Last Supper* Leonardo could represent a fragment of reality that has nothing to envy to the Masaccio's and Donatello's figures.<sup>18</sup>

In fact, before its cleaning and restoration, the composition seemed flat and dark (Figure 10), and also the perspectival effect was reduced. After the recent restoration, it seems, on the contrary, to

<sup>16</sup> Leonardo, *Libro di Pittura*, 1995, i.e. paragraphs 149, 150 ("aria grossa") e 151 (this latter with important observations on colours which must be less clear and less dark according to their backgrounds), pp. 208-209.

<sup>17</sup> Clark 1939 (in the following edition of 1952, Clark was less negative according to the results of the Pelliccioli's restoration, in progress at that time).

<sup>18</sup> Gombrich 1950.



suggest a very deep space moving from the first plane in which are placed the coloured figures toward the far background in which colour is transforming itself in *chiaroscuro* just to describe the interior of a very deep room half in shadow and half illuminated. In this newly revealed painting, we may also wonder if there is indeed more *chiaroscuro* than colour, as the romantic writers argued when they labelled Leonardo as *chiaroscurista*.



Figure 9: Leonardo da Vinci, *The Last Supper*, 1494-1498. Detail of St. Matthew head after Brambilla's restoration.

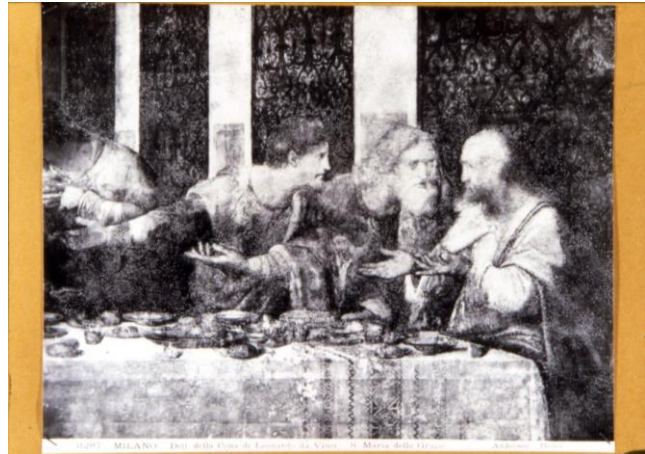

Figure 10: Leonardo da Vinci, *The Last Supper*, detail of the right part in a photograph after 1904.

Confirmations about the use of colour in terms of body construction and of a three-dimensional rendering of a composition is offered also by the recent restoration of the *Adoration of the Magi* in the Gallerie degli Uffizi in Florence. For a long time considered to be a monochromatic painting and compared to a tentative to equal painting to sculpture (Figure 11), the recent restoration (Figure 12) has revealed the use of many different materials and pigments and a variety of steps in its execution, including the use of pencil drawings, grey-blue watercolours, different tones of sepia one over the other, and finally brush strokes (*rialzi*) in white. The new look of the painting can be compared almost to a coloured one, not yet finished however, especially if we consider the use of a palish blue in the background (Figure 13).

It is possible that Leonardo worked on this panel in different moments. After having begun to work on it around 1481, he left it when he went to Milan in 1482, and he eventually came back to Florence and added other layers of paint. He probably added varnishes to obtain a satisfactory look, i.e. a painting not in all of its parts completed, but suitable to represent a good example of how painting, expressing itself only with few colours and *chiaroscuro*, could reproduce the real and nature in competition with sculpture. And because sculpture is very easy to do, as Leonardo himself wrote, given it uses materials as nature offers, painting is much more difficult because it has to do only with colours, *chiaroscuro* and perspective on a flat surface.

The *Adoration of the Magi* is already a masterpiece especially if we consider Leonardo did it at the age of thirty, or less. But it is already a summary of the motifs, groupings of figures, attention to nature, and the representation of the "movements of the mind" that he will re-use later in his career. The *Adoration* is, essentially, a pre-figuration of the *Last Supper* because the movements of the people around the Virgin and Child are generated by the Epiphany of the latter, and the waves of emotion which spread off can be compared to those ones generated by the Christ words "one of you will betray me" in the *Last Supper*.



Figure 11: Leonardo da Vinci, *The Adoration of the Magi*. 1480-1481. Florence, Gallerie degli Uffizi. Before last restoration.



Figure 12: Leonardo da Vinci, *The Adoration of the Magi*. After recent restoration.

The spread of motion starts from the Virgin and Child in the very center of the composition and the dramatic reactions generated around it – the true meaning of the painting - make unnecessary to finish the panel with colours. It was sufficient to have sketched it with *chiaroscuro*. Few colours were only necessary to give shape and volume to the figures, animals in motion, nature and architecture in a composition in which colour may be considered a kind of “ornamento” (*ornament*) according to Leon Battista Alberti’s *De pictura* in the final aim to represent an *historia* painting, i.e. the narrative of an historical event. Alberti himself, in his small treatise, recommended to the painter not using “tutta la moltitudine de’ colori” (all the quantity of colours), which of course “molto giova” to the graciousness and beauty of the painting. On the contrary, he said that the most difficult thing in painter’s practice is the use of white and black. Thanks to black and white the painter can reach effects of “rilievo” (relief), together with the study of light and shadow, but Alberti concludes by saying that, at the very end, he would appreciate a good coloured composition.<sup>19</sup>



Figure 13: Leonardo da Vinci, *The Adoration of the Magi*. Detail of the background with the pale blue sky after recent restoration.



Figure 14: Leonardo da Vinci, *The Adoration of the Magi*. Detail of the right standing figure after restoration.

Leonardo seems to have followed in many ways Alberti’s recommendations, just to begin with the lateral standing figures in the *Adoration* (the so-called *figure quinta*) who invite the viewer to

<sup>19</sup> See Alberti, *De pictura* (1436), ed. Grayson 1975, pp. 80-86, capp. 46, 47, 48. On the “ornamento” in Alberti’s and Leonardo’s writings see now Marani 2016.

participate to the historical event and almost to get *into* the painting. Precisely in these two figures we can observe another application of Alberti's suggestions: the relief of the right figure is reached using almost exclusively black and white (Figure 14), and this is absolutely one of the most beautiful and sculptural figures within the general composition.

The *Adoration* anticipates by more than fifteen years the *Last Supper*. For this reason, and because it is the last work of his first Florentine period, it represents the top of his youth, and it reflects more strictly the albertian theories than we will see later reinterpreted by Leonardo more freely in the *Last Supper*. With *St. Anne* now in the Musée du Louvre (Figure 15) we are in the presence of a painting begun in 1503 and finished (almost) around the last years of Leonardo's life.<sup>20</sup>



Figure 15: Leonardo da Vinci, *The Virgin with the Child, Saint Anne and the lamb*, c. 1503-1517. Paris, Musée du Louvre. After recent restoration.



Figure 16: Leonardo da Vinci, *The Virgin with the Child, Saint Anne and the lamb*, c. 1503-1517. Detail of the landscape in the background after restoration.

In the past, this painting was often considered not entirely autograph. The yellowish and brownish look due to ancient and modern varnishes together with the many repaints and retouchings - especially on the blue robe of the Virgin which generated a curious dotted effect (the panel was also enlarged and repainted on both the borders) - gave the impression that the painting had been executed by Leonardo and some of his assistants.

The recent restoration of 2010-2011 by Cinzia Pasquali in the Louvre Laboratories<sup>21</sup>, with the removal of the more recent oxidated varnishes and the cleaning of the pictorial surface, offers the evidence of a complete autograph work. The traces of the preparatory drawing and *pentimenti*, put in light through reflectography and x-rays examinations, not to mention a new analysis of its style, confirm an execution made by Leonardo according to his practice and theory. Particularly the depiction of the beautiful landscape of mountains and waters seen at a distance, and seen through *aria grossa* and fog, correspond to the last chapters of Leonardo's *Treatise on Painting*, and especially to the precepts in the Fifth Part of it, in the chapters devoted to the representation of mountains and their

<sup>20</sup> For this painting see now Delieuvin 2012.

<sup>21</sup> See Pierre Curie and Cinzia Pasquali in Delieuvin 2012, pp. 381-392.



colour variation when observed at a distance, and they can appear blue during the summer and whitening during the winter<sup>22</sup> (Figure 16).

These annotations date from around 1510 to 1515 circa, and they correspond to the long elaboration of the painting, began in 1503 with the St. Anne's face (as the famous annotation by Agostino Vespucci in the Heidelberg Cicero says: Zoellner 2011) and lasted with the landscape in the last years of Leonardo's life. With all this in mind, we can now appreciate how much Leonardo recreated his previous colour palette, and at the same time transformed *chiaroscuro* into *sfumato*, i.e. mixing the passages from a colour to another one "a guisa di fumo" (like smoke does) without tracing precise areas with drawing or borderlines. Now, the general effect is more luminous than in the *Adoration*, light and colours are strictly related one to the other and the light prevails on the shadow. Faces and bodies are full illuminated and *sfumati* (Figure 17), and light produces more brilliant and transparent colours than before, as for example in rendering the veils and the pink robe of the Virgin on which the blue of the mantle is overpainted (Figure 18).

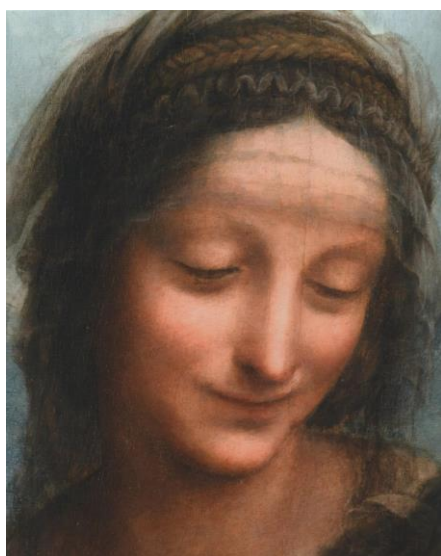

Figure 17: Leonardo da Vinci, *The Virgin with St. Anne*, detail of the St. Anne's head.



Figure 18: Leonardo da Vinci, *The Virgin with St. Anne*, detail of the Virgin bust and right arm and draperies.

We may conclude that this painting represents the very last of Leonardo's ideas about colour and its way to be interlaced through *sfumato*. The colour was made from very thin layers of paint, as the result of a vision in which light plays the main role, and thus generates forms reaching in the oil technique which he adopted here what he was unable to achieve in the *Last Supper* "secco" technique. We must consider that the chronology of this painting corresponds almost exactly to the dating of the *Monna Lisa*, to whom it is parallel. I am sure that if in the future a very light cleaning of this painting will be tempted, we will discover under the yellowish *patina* that we observe today the same brilliant colours generated by natural light we have noted now in the *St. Anne*. Only a stripe at the top of the *Monna Lisa* (Figure 19), covered thoroughly centuries by the frame, permits today to imagine the real tonality of the blue sky behind the sitter. We can, thanks to this well preserved blue (almost in its original state because never altered by light), to extend our considerations also to the most famous painting of the modern era: the same light which has offended the great part of painted surface of the *Monna Lisa* is the same which inspired Leonardo to create his miraculous colours.

<sup>22</sup> See Leonardo da Vinci, *Libro di pittura*, 1995, pp. 452-467, particularly the paragraphs 794-808.



Figure 19: Leonardo da Vinci, *The Monna Lisa*, 1503-1518 circa. Paris, Musée du Louvre. Detail of the top of the panel with a stripe of the original blue of the sky at the top discovered under the frame.

## ACKNOWLEDGEMENTS

I would like to thank Maurizio Rossi, Marco Gaiani, Simone Garagnani, Paola Cordera and Stefano de Martino for their help and support in editing this paper and the first two of them also to have invited me to this Conference.

## REFERENCES

- Alberti, L. B. *De pictura*, reprint Grayson, C. (ed.). 1975. Bari: Laterza.
- Bertelli, C. 1982. Verso il vero Leonardo. In Dell'Acqua, G. A. (ed). *Leonardo a Milano*. Milano: Silvana, 83-88.
- . 1986. Leonardo e l'Ultima Cena (ca. 1495-97). In Borsook, E. and Superbi Gioffredi, F. *Tecnica e stile: esempi di pittura murale del Rinascimento italiano*. Florence: The Harvard University Center for Italian Renaissance Studies, Villa I Tatti. 31-42.
- Brambilla Barcilon, P. and P. C. Marani. 1999. *Leonardo. L'Ultima Cena*. Milano: Electa.
- Brizio, A. M. 1964. Review to J. Shearman, Leonardo's colour and chiaroscuro (1962). *Raccolta Vinciana*: fasc. XX, 412-414.
- Chastel, A. 1982. *Les limites du savoir scientifique chez Léonard*. In Bellone, E. and Rossi, P. *Leonardo e l'età della ragione*, Milano: Scientia. 7-20.
- Ciatti, M. and C. Frosinini. 2017. *Il restauro dell'Adorazione dei Magi di Leonardo. La riscoperta di un capolavoro*. Florence: Edifir.
- Clark, K. 1939. *Leonardo. An Account of his Development as an Artist*. Cambridge: The Cambridge University Press. See also 1952 ed. with Introductory essay by Kemp, M. 1988, 1989. London: Phaidon.
- Delieuvin, V. 2012. *La Sainte Anne. L'ultime chef-d'oeuvre de Léonard de Vinci*. In *Catalogue de l'exposition (Paris, Musée du Louvre, 29 mars-25 juin 2012), sous la direction de V. Delieuvin*. Paris-Milan: Louvre Editions-Officina Libraria.
- Farago, C. 1991. Leonardo da Vinci's Color and Chiaroscuro Reconsidered: The Visual Force of Painted Images. *The Art Bulletin*, vol. LXXIII, 53-78.
- Fiorani, F. 2008. The Colors of Leonardo's Shadows, in Leonardo. *The International Society of the Arts, Sciences and Technology*, XLI/3. 271-278.
- Gombrich, E. 1950. *The Story of Art*, London: Phaidon, 1950, 1966 (ed. it. Torino: Einaudi, 1966, 1970, 1973, 1974; french ed. Paris: Gallimard, 2006).
- Leonardo da Vinci, *Libro di Pittura*. Codice Urbinate lat. 1270 nella Biblioteca Apostolica Vaticana. Pedretti, C. (ed.) 1995. *Trascrizione critica di Vecce*, C. Firenze: Giunti, 2 volumes.

- Lomazzo, G. P. 1974. *Scritti sulle arti*. In Ciardi, R.P. 1973 vol. I, Pisa: Demarchi & Bertolli, 1973, e vol. II, Firenze: Centro di, 1974.
- Marani, P. C. 1999. *Leonardo. Una carriera di pittore*. Milano: Motta. (Leonardo. *The complete Paintings*, New York: Harry H. Abrams. Ed.).
- . (ed.) 2010. Leonardo da Vinci. In *Il Musico, exh. Cat.* (Rome, Musei Capitolini, 11 dicembre 2010-27 febbraio 2011), Cinisello Balsamo: Silvana.
- . 2014. Leonardo's Last Supper: technique of execution and conservation thirteen years after its restoration. In Menu, M. *Leonardo da Vinci's Technical Practice, Paintings, drawings and influence / La pratique technique de Léonard de Vinci. Peintures, dessins et influence*. Proceedings of the Colloque (London, National Gallery, 13-14 janvier 2012). Paris: Hermann. 162-168.
- . 2016. "Admirable... par sa gracieuse simplicité, par son élégance modeste sans aucune odieuse surcharge". Léonard et la question de l'ornement. In Caye, P. and Solinas, F. 2016. *Les Cahiers de l'Ornement, 1, sous la direction de*, Paris: Collège de France - Rome: De Luca Editori d'Arte. 74-92.
- . 2018. *Leonardo. L'Ultima cena, nuova edizione aggiornata*, Milano: Electa.
- . 2019. *Leonardo, terza edizione accresciuta*, Milano: Il Sole24 Ore/Motta cultura.
- Marani, P. C. and G. Mori. (eds. in collaboration with O. Cucciniello) 2017. *Archeologia del Cenacolo. Ricostruzione e fortuna dell'icona leonardesca: disegni, incisioni, fotografie, Catalogo della Mostra (Milano, Castello Sforzesco, Sale dell'antico Ospedale spagnolo, April 1st- June 25th 2017)*. Cinisello Balsamo: Silvana Editoriale.
- Muentz, E. 1899. *Leonardo da Vinci. L'artiste, le Penseur, le Savant*. Paris. (English ed. *Leonardo da Vinci: Artist, Thinker, Man of Science*. Boston: Hardy, Pratt & Co.).
- Nova, A. 2019. John Shearman's Leonardo. In Barone, J. and Avery-Quash, S. (eds.). *Leonardo in Britain. Collections and Historical Reception*, Florence: Leo S. Olschki, 377-390.
- Romano, G. 2005. Il restauro del Cenacolo di Leonardo: una nuova lettura. In Piva, C. and Sgarbozza, I. *Il corpo dello stile. Cultura e lettura del restauro nelle esperienze contemporanee. Studi in ricordo di Michele Cordaro*. Proceedings of the Conference (Rome, 2004), Bergamo-Rome. 53-64 (republished in Romano, G. 2010. *Rinascimento in Lombardia. Foppa, Zenale, Leonardo, Bramantino*. Milano: Feltrinelli. 141-152).
- Ruskin, J. 1843–1860. *Modern Painters*, Oxford, 5 volumes.
- . Pittori moderni. In Leoni, G. (in collaboration with Guazzi, A. and introduction by Leonelli, G.). 1998. Torino: Einaudi. 2 volumes.
- Von Seidlitz, W. 1909. *Leonardo da Vinci: Der Wenepunkt der Renaissance*. Berlin.
- Shearman, J. 1957. *Development in the Use of Colour in Tuscan Painting of the Early Sixteenth Century*, Ph.D. dissertation, London: University of London, Courtauld Institute of Art.
- . 1962. Leonardo's Colour and Chiaroscuro. *Zeitschrift für Kunstgeschichte*, vol. XXV, fasc. 1, 13-47.
- Summers, D. 2013. Chiaroscuro, or the Rethoric of Realism. In Fiorani, F. and Nova, A. (eds.). *Leonardo da Vinci and Optics*. Venice: Marsilio. 29-53.
- Vasari, G. 1550-1568. *Vita di Lionardo da Vinci pittore e scultore fiorentino*, in *Giorgio Vasari, Le Vite de' più eccellenti pittori, scultori e architettori*. In Bettarini, R. 1966-1997, commented by Barocchi, P. vol. IV, Testo, Firenze.
- Venturi, L. 1919. *La critica e l'arte di Leonardo da Vinci*. Bologna: Zanichelli (reprint, 1988. Bologna: Zanichelli).
- Zoellner, F. 2011. The "Heidelberg Cicero". In *Leonardo da Vinci 1452-1519. The Complete Paintings*. Koeln: Taschen. 251-252.

# Umbrella Diagram: 1981-2021, four decades of forecasts and CMF design

Clino Trini Castelli <sup>1,\*</sup>

<sup>1</sup> Castelli.Design; work@castellidesign.it

\* Corresponding author: work@castellidesign.it

## Abstract

The *Umbrella Diagram*, developed by Clino Trini Castelli since 1978, is a fundamental tool to configure CMF design languages and forecast historical color and material trends survey. The tool, based on decades, is represented by arches instead of an evolution of a timeline. This cyclical progress proved to be premonitory of the strong changes observed between the color languages of the decades. The umbrella shape of the diagram stems from the coexistence of large arches (historical trends) with smaller arches (fashion trends), frequently in conflict. Castelli first turned to the past of the 70s, 60s and 50s, testing his format backwards based on what was already observed. He then applied the same principles and parameters, looking rather at the 1980s and, till today, to the other four upcoming decades. The Umbrella Diagram was conceived as a proprietary tool of Castelli Design and reserved for his international customers and educational activities.

**Keywords:** *CMF design and forecasting, Iconic Colors, Syntactic Colors, Color Presence, Color Distribution*

## INTRODUCTION

This of the AIC 2021 Milan congress is the first public presentation of the *Umbrella Diagram* executed outside of a professional or educational confidential context. Despite the current presentation of this proprietary tool is taking place exactly forty years after its creation (1980-1981), to this day continue not to be any web recurrences on search engines, except one not-authorized imitations that appeared several years ago using the same graph and the same four basic parameters.

Intending to take over the design company *CDM - Consulenti Design Milano*, Clino Trini Castelli had already begun, in 1978, the search for a tool that would make it possible to predict the identity of colors and materials languages in advance, as well the related trends.

With the advent of the additive color synthesis era (then completely unnoticed) Castelli founded and directed the *Colorterminal IVI* in Milan (1978). The *Colorterminal* was the *Center of Creative Colorimetry* where was developed the theory of color as a new “culture of the project” asset. Equipped with the *Graphicolor* electronic simulator it was the first color research center for design and architecture in the world, enabling the chromatic potential discover of the additive RGB synthesis. The *Umbrella Diagram* was going to be a new dialogic tool – like the *Gretl's Diagram* (1977) now in the CCI Collection of Centre Pompidou in Paris – proper for guiding and training also the designers of the first international customers by Castelli Design, including Louis Vuitton.

With CDM, founded in 1974, Castelli introduced the “extensive vision” of the metaproject in the professional field through the *Design Primario*, this in opposition to the “intensive vision” of traditional design process. This had led to the development of qualitative aspects of modernity which was still unsolved, as evidenced by the success of the *Colordinamo* and *Decorattivo* manuals of the *Centro Design Montefibre* (1974-1978).

In the *CDM - Consulenti Design Milano*, beyond Clino Trini Castelli, Andrea Branzi and Massimo Morozzi, also participated for a while the architects Ettore Sottsass and Alessandro Mendini. Since 1980 the international activity of Castelli Design - with Vitra in Europe, Herman Miller in the USA and

Mitsubishi in Japan - has pointed to a great development of *CMF design* (Colors, Materials and Finishes), an acronym born in 1981 with the CMF project for Herman Miller by Clino Castelli.

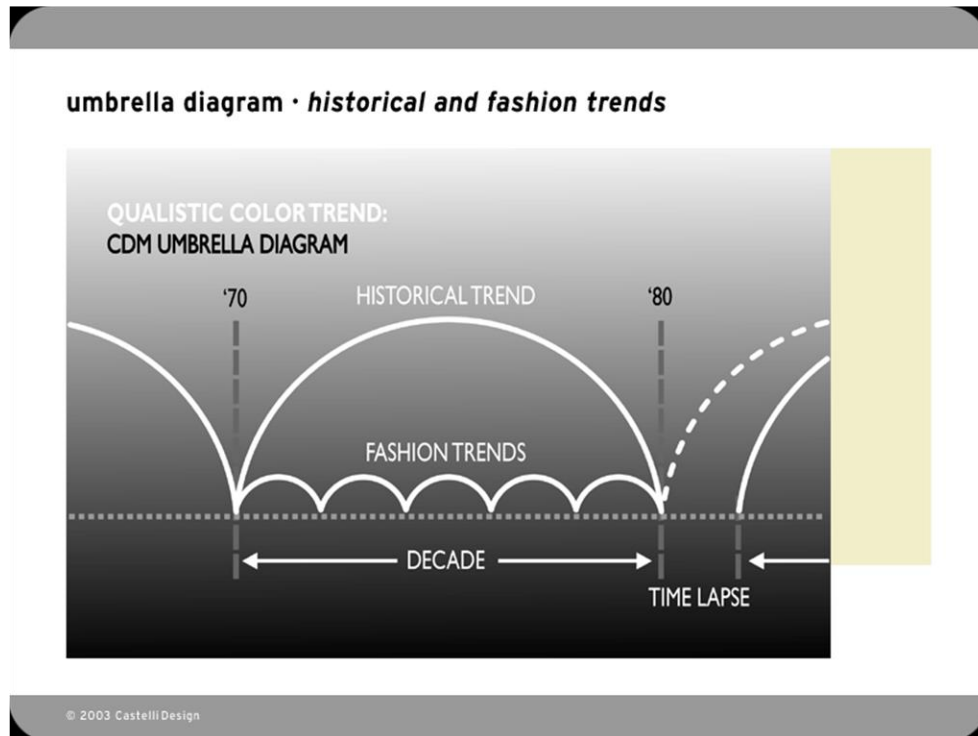

Figure 1: The *Umbrella Diagram* graph with small and large arches inspired by the Kircher's Diagram (1646).

Umbrella Diagram graph:

- Color Arches (Historical Trend arch, Fashion Trend arch)
- Time Lapse (Run-Out or Deviation: anticipation or delay from the ideal Historical Trend)

The *Umbrella Diagram* graph (Figure 1) is derived from the interlaced arches of Kircher's Diagram (1646) published on the art magazine *Data Arte*. The article *I diagrammi del colore* (Trini Castelli 1978) describes the evolution of the color diagrams found in ancient books and other documents provided to the *Colorterminal* by Faber Birren, the founder of the *Yale University Color Library*, with which Castelli had begun to collaborate since 1977. The *Umbrella Diagram* is a tool based on decade divisions, represented by large arches instead of the classic linear evolution of a timeline. The main idea was to connect a precise historical color language to a decadic trend, already started from the 50s. This cyclical progress proved to be premonitory of the strong changes observed between the languages of the various decades. The umbrella shape of the diagram derives from the coexistence of large arches (historical trend) with smaller arches (fashion trends) that develop, often in conflict with the historical trend of the overlying decade. When Clino Castelli developed the diagram, starting from 1978, he first turned to the past of the 70s, 60s and 50s, testing the format backwards based on what was already known. He then applied the same principles, looking instead at the 1980s of the upcoming decades, thus anticipating the great novelty of Post-modern and Memphis polychromatic languages, with their Syntactic and Tonal colors (Lentati 1984). The qualities that make the *Umbrella Diagram* tool dialogic and peculiar stand in a specific articulation of the factors of judgment and evaluation of the inherent nature of color (such as: Iconic color/Syntactic color) (Figure 2), on the chromatic characteristics of the colors in use and their application on objects and environments (such as: color Presence/color



Distribution) (Figure 3). These factors are always connected to the social, economic and technological contexts of the individual decades (such as: Socioeconomic context/Technoscientific context).

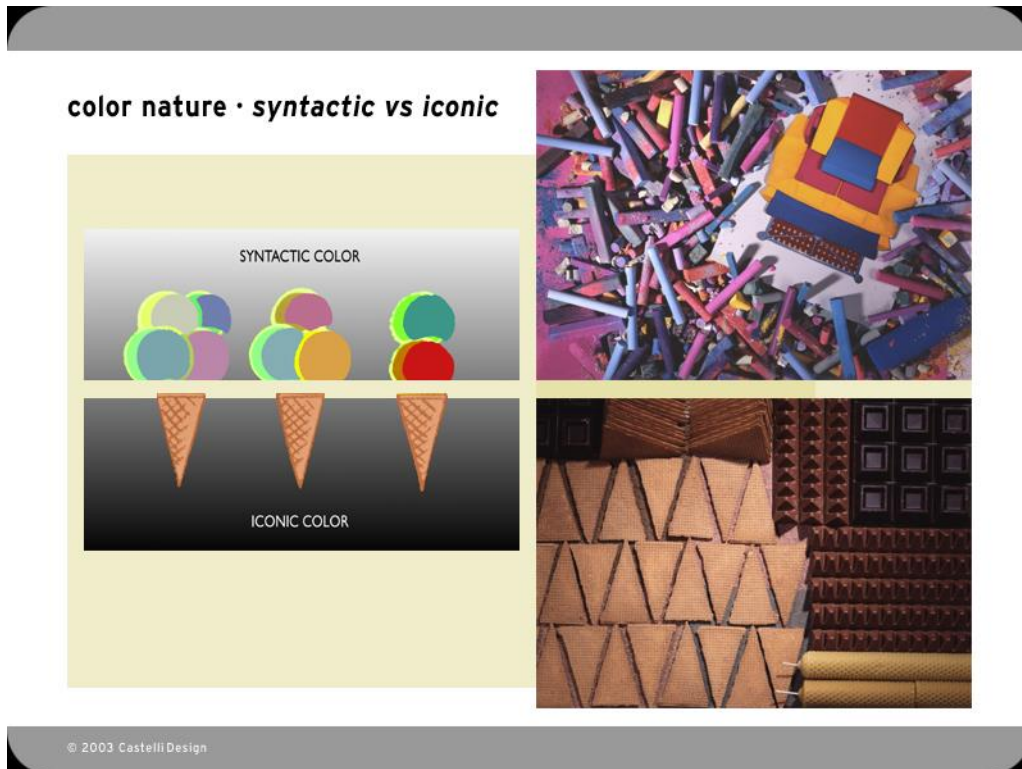

Figure 2: The *Umbrella Diagram* Chromatic Nature: Syntactic Color vs Iconic Color.



Figure 3: The *Umbrella Diagram* Color Distribution feature. “The gentleman and the rascal”: paradox effect of inverted color distribution on a same black & white color presence.

*Umbrella Diagram's* original Chromatic Parameters (Table 1) and context:

- Chromatic Nature (*Iconic Color, Syntactic Color*)
- Chromatic Features (*Color Presence, Color Distribution*)
- Historical Context (*Socioeconomic Context, Technoscientific Context*)

### Umbrella Diagram's Historical Trend Identities

The entire *Umbrella Diagram* historical trends identities show a sharp decadic opposition jump between the Chromatic Nature languages (Figure 4), that are alternatively Iconic and Syntactic. This is probably due to the need to reach the maximum possible sensation of chromatic novelty.

Decade	Color Presence	Color Distribution	Chromatic Nature
50s	Pastels (Tint)	Bichromatic	Iconic / Syntactic
60s	Primaries	Monochromatic	Syntactic
70s	Naturals	Achromatic	Iconic
80s (Figure 5)	Tonals	Polychromatic	Syntactic
90s (Figure 6)	Iconics	Metachromatic	Iconic
00s	Transitives	Heterochromatic	Iconic / Syntactic
10s	Dissonants	Hyperchromatic	Syntactic / Iconic
20s	Opponents (?)	Polychromatic (?)	Syntactic (?)

Table 1: All the parameters seen simultaneously with a hint on 20s decade, that marks the end of the modernity.

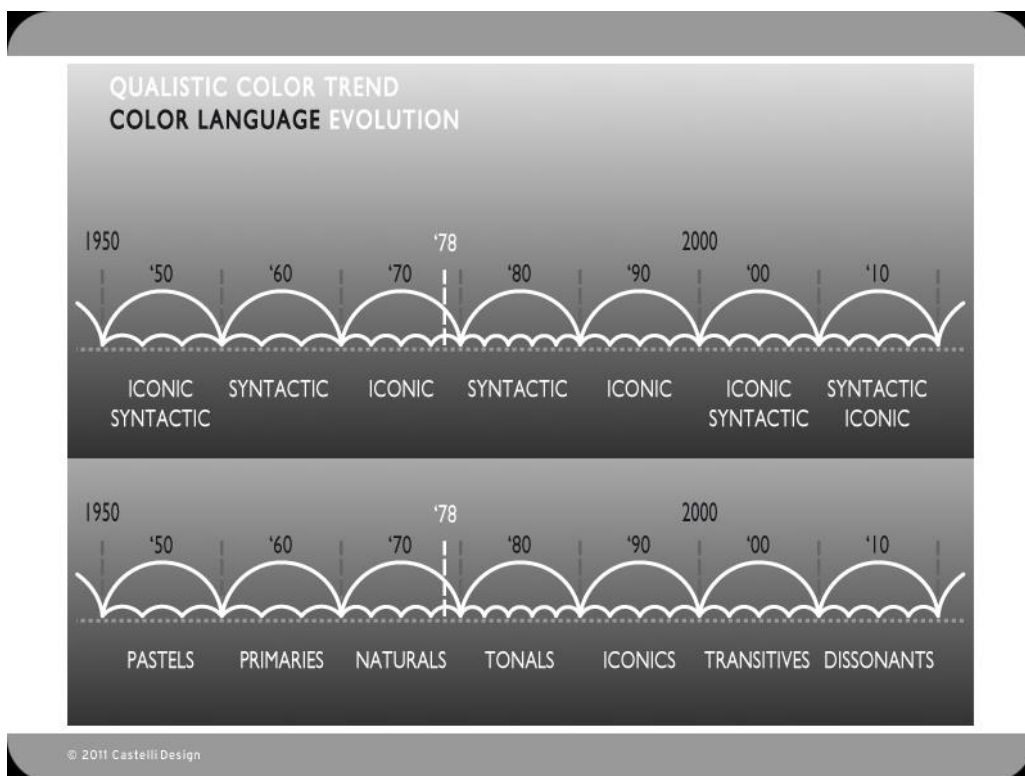

Figure 4: The *Umbrella Diagram* Color Language evolution graph that show the alternation of Chromatic Nature.

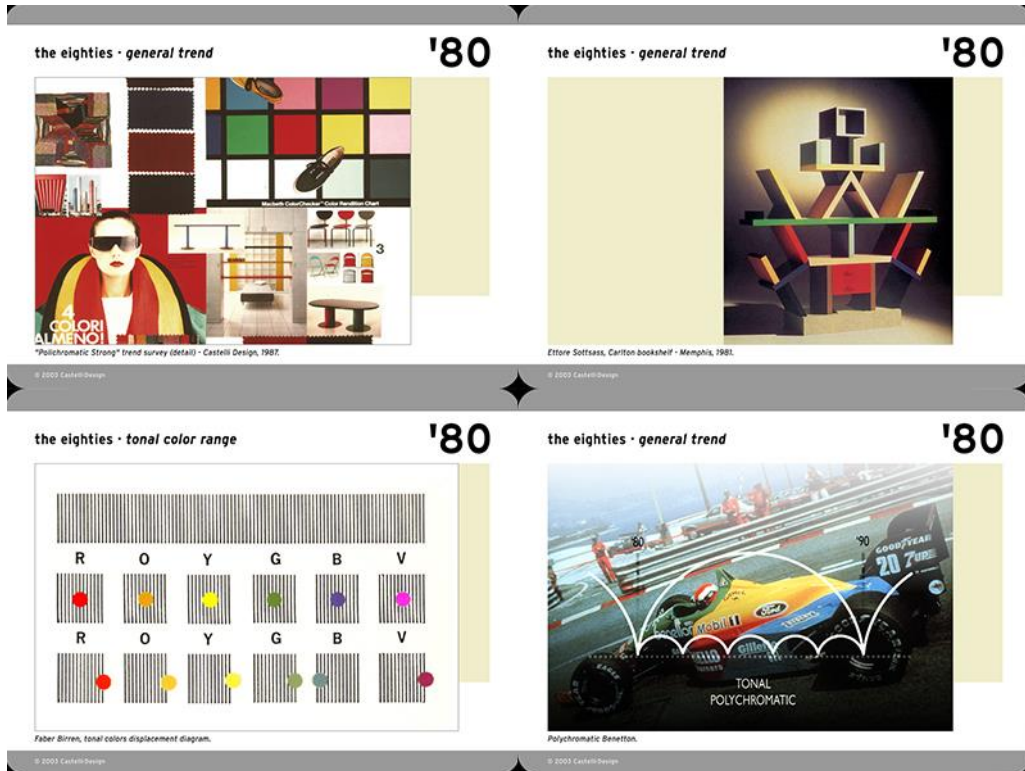

Figure 5: The Eighties Color Trend with Tonal and Syntactic languages.

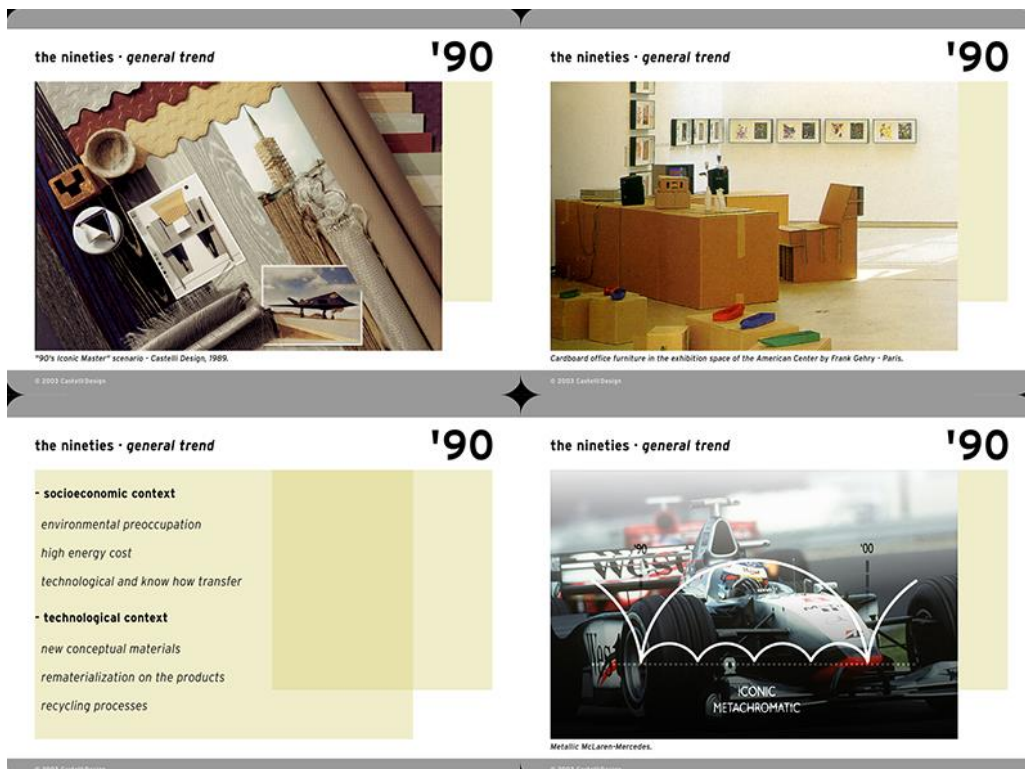

Figure 6: The incoming decade of the Nineties with the *Second Ecologism* created a strong mutation of the Color Trend in relation to the Eighties.

## Statement on the Umbrella Diagram

“[...] we analyze trends with an umbrella diagram based on decades, which I elaborated at the end of the seventies in order to look back and to look into the future. This diagram is something very important for me [...]” (Mitchell 1996: 68).

The diagram format and images were closely linked to the issues that could interest my customers, as the field of new materials (Europe, Japan), automotive production and related *CMF languages* (Takehara 1984) (Japan, Europe, USA), large office systems (Europe, USA, Japan, Australia), office equipment, including large servers (Europe, Japan), etc. This meant, for example, that for each decade was selected a *Formula 1* racing car because, in addition to having a livery suited to the emerging color schemes of the moment, in most cases was also potentially the winning stable. In addition to the *Second Ecologism* of the nineties (Trini Castelli 1995), where Color Distribution (Metachromatic) became irrelevant, the *Umbrella Diagram* has also highlighted the Natural and Achromatic experience of the *First Ecologism* of the seventies (Club of Rome, 1968-1973) to which I actively participated in its promotion with the magazine *Domus*.

However, the most sensational anticipation came with the publication of the book *Transitive Design*: (Trini Castelli 1999) and the presentation of the languages of the zero years of the new century where instead the duality of Color Distribution (Heterochromatic) became relevant again. *Transitive Design* also anticipated the visions of *Transmodernity* that anticipated the great ecological transition that began after the current global crisis due to the pandemic. This crisis was somehow anticipated by the alarming emergence of the Dissonant harmonies, the extreme languages and Hyperchromatic colors of the 10s. The *Umbrella Diagram* has been doubly important to me because over time it has allowed to maintain constant attention to certain signals coming from human ambitions and emotions connected to the global “sentiment of color”. This is how I had the certainty of having definitively emerged from what was the long and extraordinary human experience of modernity, to now enter in the 20s of *Transitive Time* floating season.

## ACKNOWLEDGEMENTS

Special thanks to: Esperanza Nunez, Antonio Petrillo, Anna Barbara, Paolo Lorini, Daniela Domina.

## REFERENCES

- Lentati, G. 1984. Il colore in versione tonale policromatica. *Ufficiostile* 1: 44-45.
- Mitchell, T. C. 1996. *New Thinking in Design: Conversations on Theory and Practice*. New York: Van Nostrand Reinhold.
- Takehara, A. 1984. The Philosopher of Color Clino Castelli. *Car Styling* 48: 13-36.
- Trini Castelli, C. 1978. I diagrammi del colore. *Data Arte* 31: 12-17.
- Trini Castelli, C. 1995. At the native state: rise and destiny of the ecological product. In: *Design of Amenity. Selected Paper of International Symposium*. AA.VV., ed. Kyushu: University Press, 464-468.
- Trini Castelli, C. 1999. *Transitive Design: A Design Language for the Zeroes*. Milano: Electa.

# AWARDS

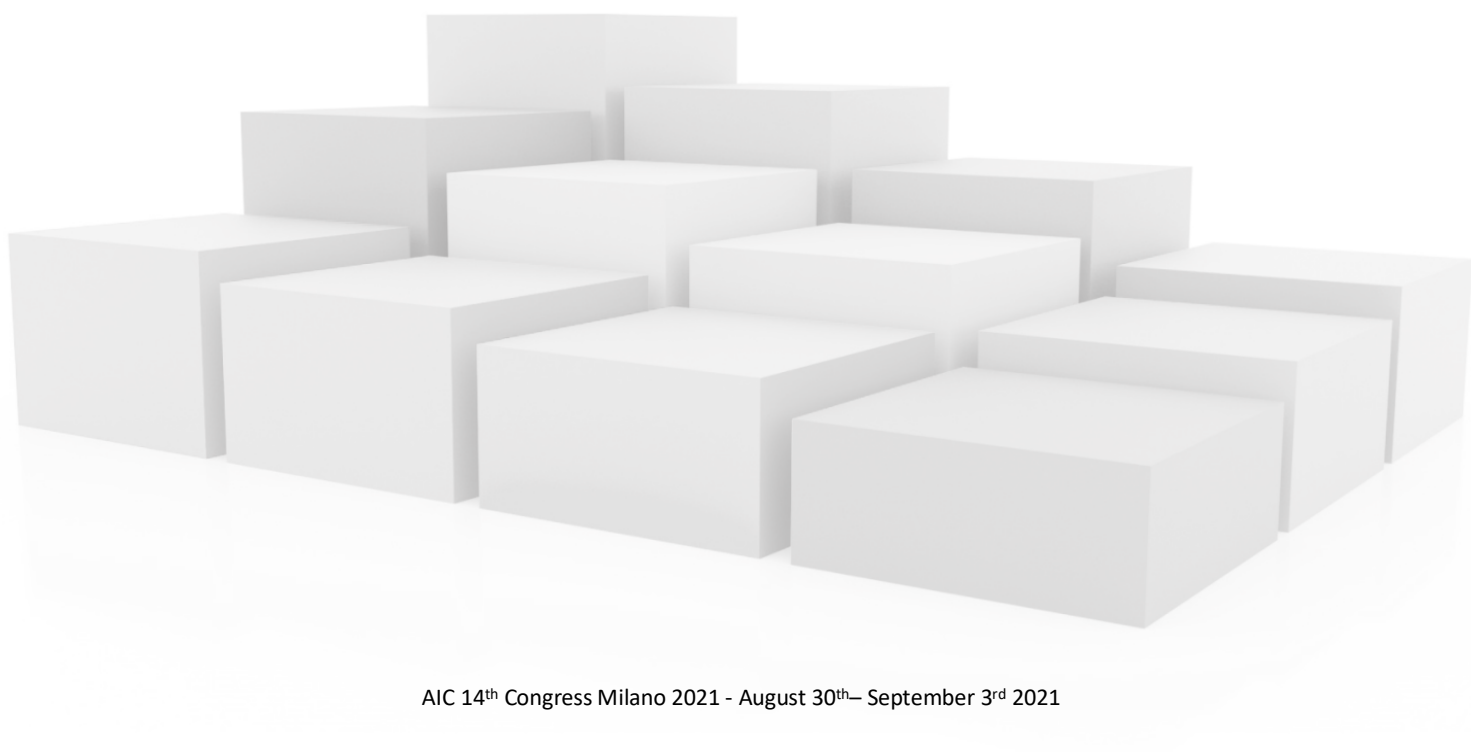

AIC 14<sup>th</sup> Congress Milano 2021 - August 30<sup>th</sup>– September 3<sup>rd</sup> 2021





## Living in Colour

Jean-Philippe Lenclos<sup>1,\*</sup>

<sup>1</sup> Colour Designer, Colour Researcher, Visual Artist, Professor Emeritus École nationale supérieure des Arts Décoratifs, Paris, France

\* Corresponding author: jeanphilippelenclos@wanadoo.fr



### Abstract

This AIC CADE Award Lecture outlines the biographical profile and career of a colour designer, colour researcher, and artist. It describes the interaction of the cross- and multidisciplinary universes in the fields of colour design related to urbanism, architecture, decorative arts, textile, and industrial design products, such as the ground transportation, aeronautics, household appliances, telephony, sports equipment, etc. It also draws attention to the philosophical, sociocultural, ethnographic, historical, semiological, symbolic, and practical foundations of *The Geography of Colour* as an inexhaustible subject of study under permanent development. Practiced individually or collectively, colour is a living material evolving through time and space. Further, it addresses colour education methodology in the various disciplines taught at art schools. The fields of colour design, colour research, and colour education are interrelated and ultimately nourished by creative art practices such as drawing and painting.

**Keywords:** *colour design, colour education, research, The Geography of Colour, Lenclos methodology*

### ROOTS AND EDUCATION

In a few words I would like to talk about my origins and the context that led me to become a designer and an artist. My father was a sculptor and he drew (Figure 1). I always saw him with a pencil in his hand. During my childhood my main activity was drawing. This was during the war and my drawings were of airplanes flying in squadron formation over our house, scenes of bombing and war in the nearby town that we could see from the window. I was a distracted child and not very good at school, so when I was fifteen years old my father decided to send me to the École des Beaux-Arts in Lille. I spent a year there before going to Paris. I was still a teenager and the youngest student in the class. I watched my older mates with fascination. One of them had family members living in Paris where he went regularly. He would come back with stories of his visits to exhibitions, introducing us to Balthus, Alberto Giacometti, Bernard Buffet, and many others. But above all, we had a certain romanticism for the *peintres maudits* [the cursed painters], such as Vincent Van Gogh, Chaïm Soutine, or Amedeo Modigliani, whose Bohemian lifestyle and work made us dream. For me this was a discovery, an opening of my mind to art which definitely pursued me. In 1954 I went to Paris to the École Boulle to the cabinetmaking workshop to learn the craft of furniture making. I found myself in another context learning a refined manual trade. The teachers were all highly experienced professionals. Their standard was the ideal of excellence of the Compagnons du Tour de France. From these four years at the workbench I have kept not only a sense of method, precision, and professional rigor, but also respect and love for work well done. I continued my studies at the École nationale supérieure des Arts Décoratifs (EnsAD), the School of Decorative Arts in Paris, to train as an interior architect. I was suddenly immersed in a cross- and multidisciplinary universe. We didn't really talk about design, but we could sense its beginnings. The disciplines of the decorative arts, visual communication, textile design, and, of course, the fine arts were all present. Taught by renowned professionals who were acknowledged as celebrities of the time and whose fame impressed us, the pedagogical approach was modern and lively. Louis Sognot, one of my interior architecture professors, had decorated the palace

of the Maharaja of Indore; another professor, Pierre Gauthier Delaye, had been Raymond Loewy's assistant and had designed agencies of Air France around the world. Students cultivated a spirit of conquest and competition with an ambition to assert and position themselves in relation to others. The school encouraged this spirit by stimulating our individual creativity. In this context some of us wanted to go abroad to experience other worlds. At that time Scandinavia was the most coveted destination. We read about it in the Danish magazine *Mobilia* and admired Hans J. Wegner's chairs. When I discovered the works of Eero Saarinen, Alvar Alto, Artek, and Marimekko, I got the idea to go to Finland. But ultimately I discovered a correspondence of thought and style between these great names and Japanese art. I was particularly impressed by the architecture of the Katsura Imperial Villa and the work of the designers Isamu Noguchi and Sori Yanagi. Then in 1961 I decided to go to Japan after obtaining a two-year scholarship to study traditional architecture at the Kyoto University of Fine Arts. The discovery of this country so far away for me was a violent cultural shock. I was impressed by the geography, the landscape, and the way of life of the inhabitants in the city as well as in the countryside. Especially with architecture, where I had been impregnated with classical French culture, with amazement I compared the purity of the Katsura Imperial Villa with the sumptuous Château de Versailles with its symmetrical façades. Built in the 17<sup>th</sup> century as a residence for the prince, the Katsura Imperial Villa is characterized by space, sobriety, simplicity of materials, and the beauty of proportions foreign to any symmetry. I completed this observation by studying calligraphy, ikebana, and in particular through discovering the tea ceremony. While this art, a culture of space and of the essential, introduced me to the contemplative thought and spirituality of the Zen culture, the most influential discovery I made was of colour in architecture. I was born in northern France where the habitat is built of red and orange terracotta. In Japan the vernacular habitat at that time had roofs clad with grey tile, the walls were made of wood, and the sliding walls of white rice paper. As found in the field of comparative literature, this awareness of differences between the colours of France and those of Japan introduced me unconsciously to what I later called *The Geography of Colour*.



Figure 1: (left to right) My father Camille Lenclos at Beaux-Arts de Lille, 1921; Myself as a student at École Boulle, 1954; Drawing, ink on paper, 1956; Calligraphy book, 1962; Kyoto landscape, pastel, 1961. Photo © Jean-Philippe Lenclos.

### **PROFESSIONAL BEGINNINGS**

When I went back from Japan, I was contacted again by the company Peintures Gauthier for whom I had worked as a student at the Arts Déco School, a company specialized in paints for the building industry. I worked there part-time. The atmosphere was almost family-like and I appreciated this human quality and liked being there. I was then asked to do colour projects of factories, apartment buildings, hospitals, and more. This was the beginning of my professional life.

Soon I became the artistic director of this booming industry. It was my first confrontation with the industrial world. Far from the artistic studies that I had practiced until then, I discovered the



complementarity of commercial, financial, marketing, technical, and communication directions. At the beginning my main mission was to explore new colour ranges of the products. Very quickly, I was promoted to emphasize these ranges by creating a new system of visual communication for Peintures Gauthier. My objective was to endow this company with a creative modern image centred on the dynamics of colour (Figure 2). The packaging of the Textone brand of façade paints was the perfect place to start expressing myself. I designed a graphic motif in the form of a blue and yellow geometric module, colours I selected because of the intensity of their contrast and developed on the principle of connecting one packaging to another. By rotating the packaging, we obtained infinitely variable combinations (Figure 2, right two). In a way this was the beginning of supergraphics.



Figure 2: (left to right) Neopakol colour fan; Peintures Gauthier's new corporate identity; Neoprim paint pots; Textone paint pots arranged as a supergraphic. Photo © Jean-Philippe Lenclos.

At the same time I began reflecting about the question: "What colours are to be used for architecture?" This was a new field for me in which I had no previous experience. And, at this time there were no books to be found on colour yet. The French translation of Johannes Itten's book *Kunst der Farbe* (1961) [in English, *The Art of Colour*] only appeared in 1974. As always, I began by trial and error. On the one hand, the difficulty was to conceive colour in space in three dimensions, and, on the other, to estimate the difference between a small colour sample on the table and its appearance at a monumental scale. I had no method to rely on. And I only knew about the buildings where Le Corbusier had applied basic colours. Working in a spirit of curiosity and research, only my own concrete experience in the field enabled me to advance and make progress. About colour itself, again, I was plunged into the unknown. My first objective was to use colour in an aesthetic sense: to create beauty, wonder, and a sense of well-being for the observers and users, i.e., to venture forward with some successes and some failures. As a beginner, I sometimes tended to use too much colour where a modest palette would have been sufficient. Employing colour should not be confused with applying polychromy. A vast programme and big difference!

### Colour Charts

The first colour chart I designed was Neopakol glossy lacquer. Generally lacquer had been used for exterior woodwork and in interior architecture for kitchens and bathrooms. I liked the shine and the mirror effect of this paint. I then had the idea to promote it for the noble rooms of the house. To do this, I developed a colour chart of about one hundred colours that allowed for a range of new tones and shades for decoration. Finding the best colours was an apprenticeship that gave me a taste for research. In 1965 this colour chart was the richest of the French brands at that time. It was a great success with architects and decorators. And it positioned Peintures Gauthier at the forefront of its competitors.

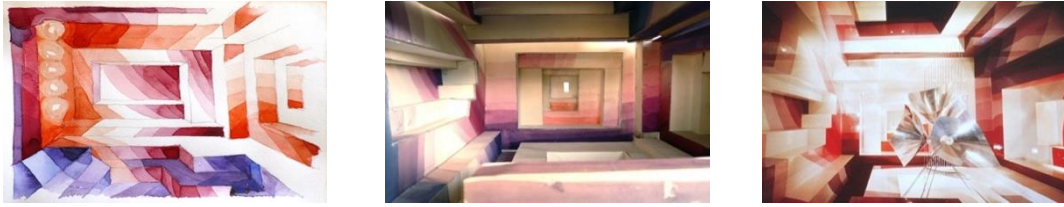

Figure 3: (left to right) Auditorium, 1967: watercolour sketch; model; realization at Salon des Artistes Décorateurs. Photo © Jean-Philippe Lenclos.

### The Auditorium

To demonstrate the decorative richness of Neopakol lacquer in architecture, I created an auditorium in the form of an inhabitable sculpture that was presented at the Salon des Artistes Décorateurs in Paris in 1967 (Figure 3). The fully lacquered and reflective interior surfaces played actively with the programmed lighting system. The space was crossed by large bands of colour, illustrating the concept of supergraphics. Numerous architecture and design publications released images of this auditorium, in particular the magazine *Domus* in Milan, which resulted in international recognition for Peintures Gauthier. The conjunction of these events and the complementarity of my various activities sparked the interest of specialized magazines which started to publish my work. The publicity resulting through the professional press not only contributed to making me known as an expert in the field, but also served to launch this new profession of colour designer.

### Textone

The second colour chart I investigated was for Textone exterior façade paints. This research was also decisive and one of the highlights furthering my future career: it became the genesis of the concept of *The Geography of Colour* which I had intuited in Japan. The composition of this colour chart led me to develop an investigation in a dozen regions in France. The goal was to identify the regional particularities of colour in the vernacular habitat through the analysis of traditional materials and local customs. Textone was a didactic colour chart intended to guide decision-makers and users to a choice of colours that best enhances the heritage and regional environment. The originality and effectiveness of this research, which began empirically, was to design synthesizing plates that showed in a clear and practical way the chromatic characteristics of the vernacular habitat of different regions of France. The results of this research were published in 1974 in the magazine *Maison Française* and in 1982 in the book *Couleurs de la France* published by Éditions du Moniteur.



Figure 4: (left to right) Colours of Tokyo, 1970–1971, book cover; Colour synthesis of Ueno district; Colour synthesis of Kyobashi district. Photo © Jean-Philippe Lenclos.

### Transitional Period 1965–1970

Working only part-time for Peintures Gauthier, I could devote the remaining time to my own research or commissions. In 1969 one was decisive: the French Pavilion at the Universal Exhibition in Osaka,

which was executed in 1970. My task was to be in charge of the colour concept and signage. Going back to Japan allowed me to contact the Color Planning Center of Tokyo.

There I exhibited my work about the analysis of regional colours in France. The rational method and the objective results convinced its director Masaomi Unagami to engage me to conduct a similar study for the city of Tokyo. After the execution, it was officially exhibited in 1972 in Tokyo (Figure 4). The Color Planning Center then commissioned me to work on other projects including colours for a new line of bicycles for the Bridgestone brand. This was how my first commissions with Japan began. This period of transition had been fertile in the exploration of colour in its various fields. Then came the moment to change from being an independent designer working as a freelancer or for companies. In 1978 I founded my own agency specialized in three-dimensional colour: architecture, urbanism, and industrial products.

### **ATELIER 3D COULEUR**

I called the studio I created Atelier 3D Couleur (Figure 5, top left).

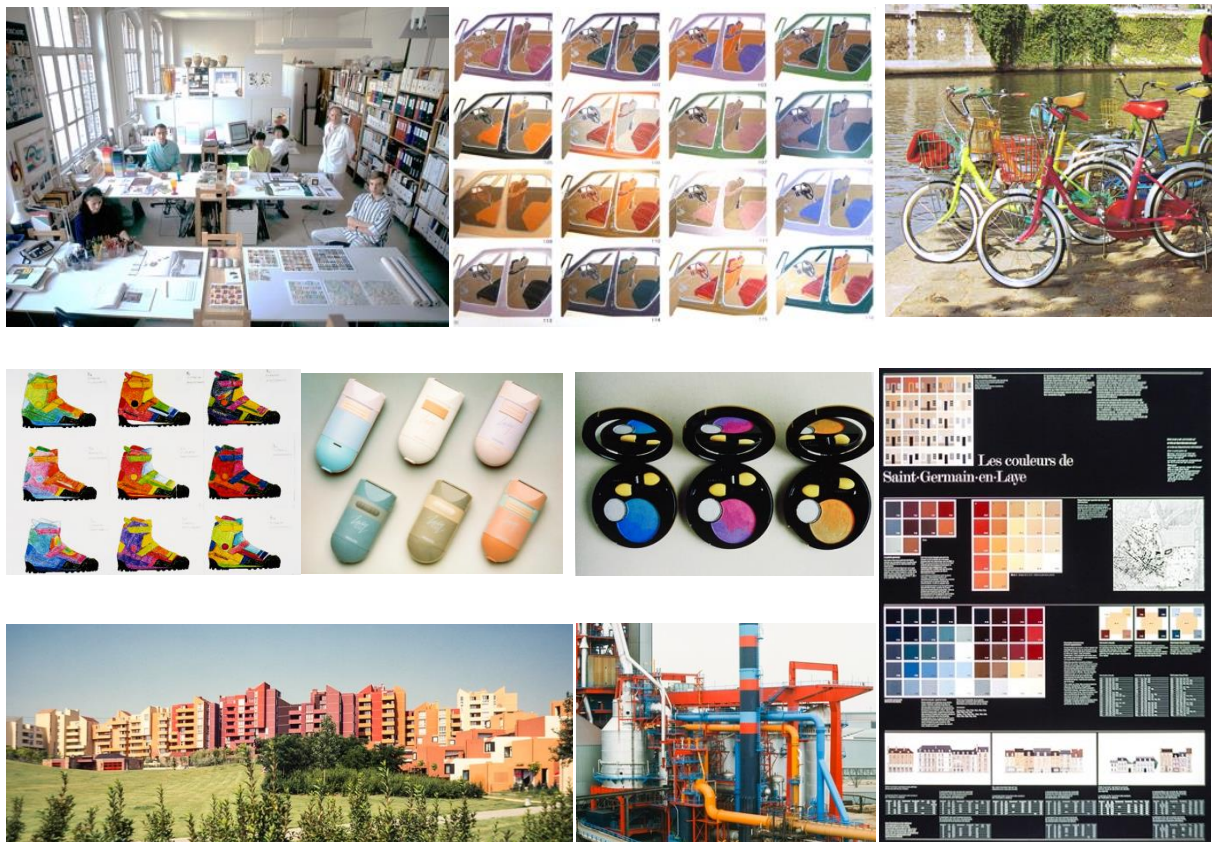

Figure 5: (left to right) Atelier 3D Couleur, 1991; Interior and body colour schemes for Renault cars, 1980; Colours for Bridgestone bicycles, 1971; Colour study for Salomon ski boots, 1985; Colour schemes for Philips' Ladyshave, 1990; Colours for Shiseido cosmetics, 1985; Les Linandes, Cergy-Pontoise, Architects Viguier & Jodry, 1976; Steelworks Solmer, Fos-sur-Mer, 1976; Saint-Germain-en-Laye, colour chart, 1981. Photo © Jean-Philippe Lenclos.

We practiced in a cross-, multidisciplinary way, applying our curiosity and our professionalism to all the fields of colour design with the exception of fashion. The name "Atelier" echoed that of my father, a sculptor, and my studies as a cabinetmaker at the École Boulle. This name corresponded to my idea



of doing artisanal research in a team. I have always favoured the spirit of collaboration that stimulates creativity, with everyone actively participating and sharing in the development of a project.

While naturally the primary objective of the Atelier 3D Couleur was to earn a living, our philosophy was to simultaneously pursue the research on regional colours that I had started with Peintures Gauthier. Apart from focusing on paid commissions, each year we invested time and resources in our investigations into *The Geography of Colour*. With my team and my wife Dominique, we published the research results in the book *Les couleurs de la France* [The Colours of France] in 1982. We extended these colour studies beyond France by publishing *Couleurs de l'Europe* [The Colours of Europe] in 1995, *Couleurs du monde* [Colours of the World] in 1999, and *Couleurs de la Méditerranée* [Colours of the Mediterranean Region] in 2016.

In terms of our ongoing research, Atelier 3D Couleur was permanently investigating the evolution of chromatic universes in fields of design concerning textiles, decoration, and industrial products, the latter being quite diversified entailing such sub-fields, e.g., as ground transportation, aeronautics, household appliances, telephony, or sports equipment (Figure 5).

### Mira X, Art and Design

Among the many projects realized at Atelier 3D Couleur, one to which I attach particular importance concerns the textile collection Mirvana. The Swiss firm Möbel Pfister, which had created the high-end furnishing textiles brand Mira X, commissioned us to create a new collection called Mirvana. The aim was to expand the market to all European countries. This collection was intended for architects and interior architects who could draw from a wide range of textile features for use in interiors.



Figure 6: (left to right) Textile collection Mira X: Reflections on a water surface; Black and white graphic vocabulary; Painting, oil on canvas, 1988; Textiles, initial design black and white, and bichrome; Printed fabrics with stoneware jars from Brittany; Printed textiles with Murano glass jars, 1988. Photo © Jean-Philippe Lenclos.

I was delighted with this commission because I was able to bring together the three initial elements of my commitment: colour, painting, and the mass-produced industrial product. Certainly this was the opportunity to continue my pictorial research on the scale of textile production, thus giving me the opportunity to associate my work as a painter with that of a designer. Returning to a research method that I had unconsciously initiated in Japan in the learning of calligraphy, i.e., graphic writing in black and white and the quality of rhythm and space, I started with the representation of the reflections of light on a water surface dear to the painter Claude Monet. From this impulse I developed a graphic vocabulary in black and white in graduations and undulations and then assembled and arranged the results in patterns that were the subject of all possible colour variations ranging from bi-colourism to more than two colours (Figure 6). I later realized that this method of the initial rhythmic pattern in black and white is a leitmotif in my career as a colour designer that I have applied since my training in calligraphy. Black and white, space, rhythm, Yin and Yang are the starting points of my chromatic signature with its nuances and poetry.

## THE GEOGRAPHY OF COLOUR

As mentioned above, in 1965 I undertook a detailed analysis of the colours of the vernacular habitat in different regions of France. The objective was to produce palettes for paints for buildings, accompanied by a reflection placing them in the history, environment, and local traditions of this habitat as well as with regard to physical, geological, and climatic conditions. To carry out this research, I conceived an original method of analysis presented in the form of synthesizing plates, each one being composed of twenty-five vignettes which illustrate in a simplified way the components of each façade: walls, doors, windows, shutters, frames, and bases. Developed according to a modular system this mode of presentation allows an easy reading of the composition of the dominant colours: the comparison of the syntheses of one architectural site with another makes it possible to clearly observe the two identities and their differences (Figure 7). This research continued in European countries and beyond on other continents. The comparative study of the colours of vernacular architecture has demonstrated in a spectacular way that for the inhabitants each geographical location generates a particular choice of the colours in their homes. Practiced individually or collectively, colour is a living and evolving material! Called *The Geography of Colour* this observation is an inexhaustible subject of study under permanent development. To further this ongoing research means to inevitably explore knowledge of the socio-cultural practices of colour in many fields of the human sciences.

- **Sociology** provides an obvious field of research concerning colour and respective socio-cultural codes, behaviour, decorum, and customs.
- **Ethnological studies** reveal the influence of particularities stemming from different geographies, history, and local traditions. This discipline entails the semiological dimension of the expression and language of colour.
- The **historical** evolution of colour is an inexhaustible theme of research as it has been applied through the emergence of diverse civilizations, as the cross fertilization between and through the mixture of cultures as well as how colour appears in the marking events of which they testify. Colour is a significant feature of scientific and technical discoveries which not only generate artistic and intellectual movements, but also economic trends. Colour is the witness and evidence of its age and its environment.
- If the relationship between vernacular architecture and symbolic expression seems obvious, the relationship between colours and symbols is just as apparent. Another field of the human sciences relevant to colour is the **symbolic dimension**, which is universal: it can be verified in all domains that touch human beings, religion, customs and habits, perception, art, or even the habitat. However, the symbolism of a particular colour can vary according to places and times and each of the colours of the spectrum lends itself to many interpretations.
- Through the angle of **semiology** the study of colours entails as well an analysis of profane and religious behaviour and in particular individual and collective choice. Today in the marketing of equipment and consumer goods colour is an essential material applied to personalize and enhance the selection according to the geographical location of distribution. In visual communication systems where colour plays an essential emotional and cultural role, its semiological dimension reveals the human environments where it is used.

These examples are only a sampling of how *The Geography of Colour* and its methodology open a vast range of fields for research and reflection in the human sciences. In a general way what can be the scope of this concept facing the challenges of accommodating new architectures and landscapes?

Undoubtedly the rise of rapid urbanization endangers this heritage of regional territories and carries the risk of an ineluctable threat to the diversity of this living heritage.



Figure 7: (left to right) *The Geography of Colour*: Le Morayshire, Scotland; Analysis and synthesis of the site; Burano, Italy, and two synthesizing plates. Photo © Jean-Philippe Lenclos.

## COLOUR EDUCATION

### Pedagogy at École Nationale Supérieure des Arts Décoratifs

I had never imagined teaching colour. In 1968 the student revolution broke out in Paris: everything had to be changed. The students of the École nationale supérieure des Arts Décoratifs (EnsAD) came looking for me. They had been inspired by my publications, my studies in Japan, and the auditorium exhibition in supergraphics. They wanted to change the traditional approach to teaching and especially they wanted to introduce colour already in the first year. I accepted. My ambition and the philosophy of my commitment were to transmit and share my knowledge and my know-how as a practitioner as well as to deepen the foundations of my reflection on colour.

The objective was to teach future designers to create with colour. My first conviction was that colour was becoming a major component of the living environment and that it needed to be learned. Undeniably colour is an essential crossdisciplinary endeavour that is part of any visual creation, from the smallest domestic object taken in isolation to the city as a whole. From fashion to industrial design, from scenography to architecture, all the disciplines taught in an art school raise the issue of colour. In my first-year course, my project consisted of familiarizing students with the three fundamental aspects of colour: the colour wheel, colour contrasts, and colour families, an approach based in part on the theories of Michel-Eugène Chevreul and Johannes Itten. In truth the colour wheel is the basis of learning: it is the simplest tool to identify hues and precisely classify their positions. Then comes the series of contrasts which is key to grasping how colours function and interact. Any colour put in the presence of another colour generates a contrast. In fact, considering the composition of the pigment and its material individually, each colour has its own identity and its own qualities. But positioned in contact with one or more other colours any single colour acquires a different appearance. Moreover, the same colour can appear very different according to the angle of visual perception and its tactile expression, i.e., depending on its texture, surface features, and exposure to different kinds of light. Families of colours indicate homogeneous sets in terms of their chromatic environment and qualities of expression. In theory a selection of specifications of such colour families might include, e.g., bright ones, pastels, coloured whites, natural ones, neutrals, coloured greys, earthy ones, deep ones, coloured blacks, fruity, acidulous, spicy ones and more. It is moreover possible to build as many chromatic circles as there are colour families. It is from these three aspects—the chromatic circle, contrasts, and families of colours—that everything is articulated in chromatic composition and creation. This first initiation to the solfeggio and language of colour took on its full meaning, first in two dimensions and then in three, in each of the successive stages of my pedagogy and through concrete projects such as those I had completed during my professional practice. Here are some examples:

- a silk scarf in six colours for a prestigious fashion brand;
- scenography for a dance performance;
- a metaphysical landscape as a cubic volume; and,
- at the end of the year through a more ambitious theme entitled “the city, dream, and utopia” according to the concept of the polychrome city dear to Fernand Léger.

Although some students have no particular aptitude for colour, a methodical introduction can familiarize them with this means of expression which they will then be able to apply in due course. Others are shy with colour, but very quickly in the course of the first exercises, an ignored and buried talent can suddenly emerge and these students will quickly join the best of the class, those who have a natural and intuitive ability to play freely with colour. However, they need to acquire all the theory to go beyond intuitive practice. By mastering all the mechanisms of colour they will save time and go much further with their creativity.

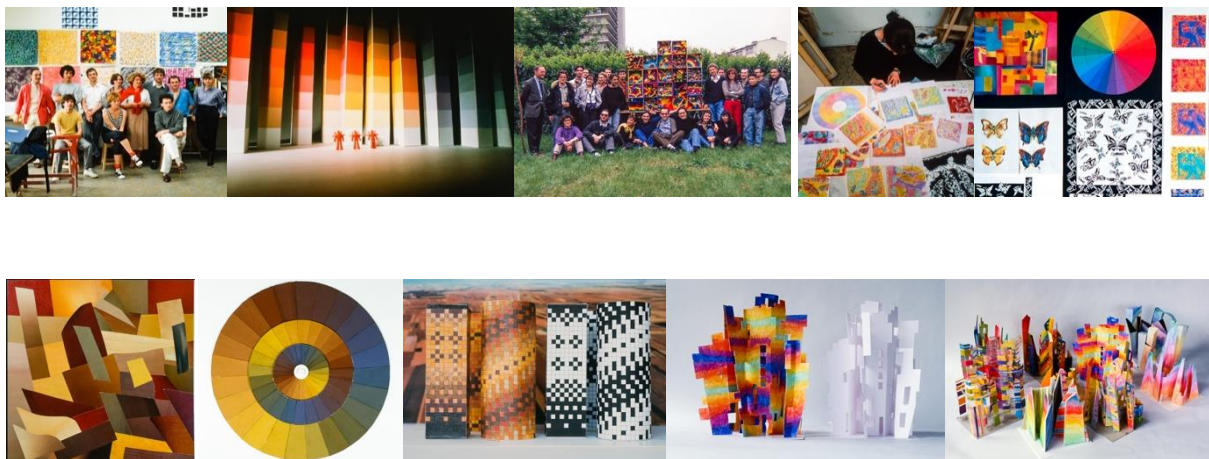

Figure 8: (left to right) EnsAD: First year students and their work; Scenography; Three-dimensional colour composition; Colour schemes for textiles; Collage with earth tones; Corresponding colour wheel; The polychrome city (right three). Photo © Jean-Philippe Lenclos.

### Colour in Specialized Workshops

After the first year I adapted my courses to each of the disciplines in specialized workshops, in particular in the art-space and interior architecture departments where I was keen to place the students in the situation of a designer of interiors dealing with his or her client. The programs covered two areas. On the one hand, the realization of projects for private clients, likely to stimulate the imagination and inventiveness of students. To close the year, on the other hand, I proposed a more complex subject where architecture, design, and colour-materials were mixed, such as the design of a pavilion for an industrial firm participating in an international event such as the São Paulo Biennale. These different research themes illustrated the concept of the globality of colour. In fact, the scenography of a place integrates a whole set of visual and sensory components: materials and textures, colours, light/lighting, graphics, furniture, and even sound.

The daily practice of my professional life at the Atelier 3D Couleur permanently nourished the themes of new projects proposed to the students. It also gave me the opportunity to share the experiences I had had in the operational field. Relationships, contacts, operating methods, project management, and price studies were the subject of regular communications that I liked to detail to my

students. I considered it important for students to have professionals as teachers who could share their experiences and knowledge acquired in their projects and on sites, thus going beyond the academic perspective and theoretical teachings.

### **Art–Space**

In this context of the visual arts my objective was to make future visual artists aware of the essential role they will give to colour in the exercise of their art on the scale of architecture and landscape. The contexts are numerous, but they can be classified into three main categories: scenography, landscape, and large facilities, i.e., any environment in which it is impossible to do without the expressive and semantic power of colour.

### **Scenography**

This area concerns the development of spaces intended for shows, exhibitions, or events for which the artist is regularly engaged to compose durable or ephemeral decors. In all cases colour and light play an essential role in the expression and personalization of the execution.

### **Landscape**

The old city, the new city, the industrial or natural landscape—there are so many environments in which the artist is challenged to bring his or her creative talent and sensitivity, sometimes as an individual but often within a multidisciplinary team. For example, the creation of colour charts (colour scheme, colour city planning) requires an in-depth methodology of analysis and conception, partially evoked in the above section *The Geography of Colour*. Regarding the development of new cities and industrial zones, the role of colour is important in visually coordinating and harmonizing the different sites involved in the project. Colour also plays an essential role in personalizing and identifying buildings in large housing developments or facilities. These programs are all related to urban planning and require an overall vision in a long-term development, which is beyond the scope of teaching. However, to study this problem, I have always used applications over the course of a term to treat a few residential buildings or to study the colours of industrial buildings.

### **Public Facilities**

Strategic buildings in the city include, e.g., hospitals, cultural centres, shopping malls, airports, subways, train stations, etc. Fine artists generally intervene here within the framework of multidisciplinary teams. In order to demonstrate the importance of colour/material and the role it can play in a public building, the programme can be applied, e.g., to a school complex or a medical clinic. Regardless of its aesthetic dimensions, the focus is on the functionality of colour to personalize and identify spaces. A particular approach is developed based on the semantics of colours and their contrasts. In this case the role of colour is to create an atmosphere favourable to the functioning and well-being of staff and users (Figure 8).

## ***PAINTING AND DRAWING***

As a child, I loved to draw. Since then, I haven't stopped. It is a necessity that I practice in a permanent and natural way. As a schoolboy, I used to draw with violet ink on the wooden desk during class. At home I used pencil like all children. At that time we had no other materials. At the School of Fine Arts in Lille where I began studying art from 1953 to 1954, with admiration I watched my older mates painting. I dreamed of becoming a painter, an artist in my turn. However, the successive schools where



I studied gradually oriented me towards the profession of colour designer. At the same time, I never gave up drawing and painting. It was a need for me to express myself, to nourish and inspire myself with painting, and to give life to colour in this way. For me, drawing and painting are both part of the same procedure: a means of abandoning myself to an inner process that mysteriously takes place in silence and concentration.

### Colour Pencil

Always very busy throughout my professional life, it was impossible for me to find the time to paint. I often compensated by drawing with colour pencils, which actually is my first tool of expression (Figure 9, left two). In point of fact my sketches for the colouring of architectural or industrial projects got me used to this practice. The Mira X project is a good example. As luck would have it, in the 1970s, a wide range of colour pencils were launched on the market. Some came from England, others from Germany or Japan. Drawing with colour pencil therefore preceded my painting. Or rather, I practiced the two side-by-side. However, I must admit that colour pencils certainly introduced me to painting. Each of the pencils has a predefined, ready-made colour, just as pastels do. And this arrangement helped me to become freer and more creative with colours. Some drawings are already small paintings, a painting in the making.



Figure 9: (left to right) Colour pencil, 1986; Colour pencil, 2000; Watercolour, 2006; Landscape, oil on canvas, 1982; Landscape, oil on canvas, 1994. Photo © Jean-Philippe Lenclos.

### Watercolour

The year 2000 marked a turning point in my professional activities. Indeed I was 62 years old and knew that I would have to decide imminently about retirement. From this perspective it seemed desirable to me to invest myself soon in a personal activity detached from all the professional constraints of a firm. I then decided to devote myself daily to my work as an artist. Whether it was with colour pencils or with watercolours, I devoted an hour each morning to these elementary exercises before going to work. Borrowing my inspiration from painters, in particular, Paul Cézanne, I decided to start painting fruit using watercolour (Figure 9, centre). For months I have been painting one after the other, a succession of watercolour drawings in a small format. My idea was to paint the same fruit throughout its life, often for more than a month. And the progressive transformation of the colours of the same fruit presented a wealth of nuances that I could have never imagined. Drawn alone or placed against a background, in this process fruit provided the subject matter of many small paintings. I then continued my exercises by painting series of flowers.

Painting flowers has always been self-evident and a pleasure. From the most modest to the most sophisticated exemplar, flowers are the archetype of beauty. The particularity of their foliage, the

delicacy of their petals, their structural system, and especially their colours make each flower a work of art. Later I would practice on more complex compositions of several fruits, like living landscapes. Without having a precise vision of my objectives, I was nevertheless clearly pursuing my learning of colour. In truth despite the practice of chromatic language that I had been able to develop during the forty years of my professional life, I always had the feeling that I still had to progress. Above all, I like to “make colours sing,” i.e., give them more visual musicality. Watercolour is the experience of the unpredictable. Each of the four components involved—brush, paper, pigments, and water—play their own role. And despite all the accumulated experience, the result is never entirely predictable. As a matter of fact, the flexibility and humidity of the brush, fluidity of the water in which the colours melt, and grain and texture of the paper each have their own way of performing. With watercolour we know how to evoke rather than describe, and better than any other pictorial technique, it has the power to translate the unspeakable charm and poetry of a silent light on a piece of fruit, on a flower, or on a landscape.

### **Oil Painting**

If I had previously had some doubts about taking up oil painting, the event that triggered the ultimate decision to take it up seriously was my meeting the painter Balthus in Tokyo. This unexpected encounter led me to the French Academy in Rome, the Villa Medici, which Balthus was directing at the time and where he invited me on several occasions. Here I must mention Georges Seurat, whose drawings and paintings attracted me for their very constructed, sober, and rigorous compositions. Moreover, his pointillist technique interested me in terms of its production of the fragmentation of colours, optical mixtures, and vibration of light. Moreover, it was the calm and serenity that I felt in Seurat's work that attracted me and stimulated my personal reflection (Figure 9, right two).

### **Abstract Painting**

By carefully painting series of flowers, sometimes the same ones for several weeks, I gradually forgot about figuration and my painting evolved to represent only an interpretation of rhythms, sequences, and resonances of colours. I often find myself in this situation when painting a plant landscape. The graphic structure of the branches, the lively contrasts of the ranges of green vegetation, warm, cold, light, or dark, lead me to forget the figure. For me my compositions, apparently abstract, are the play of colours and the transposition of a real and chromatic motif (Figure 10).



Figure 10: (left to right) Abstract paintings, oil on canvas, 2003; 2020; 2019; 2007; Zigzag, acrylic paint on canvas, 2020. Photo © Jean-Philippe Lenclos.

### **ACKNOWLEDGEMENT**

My special thanks go to Verena M. Schindler for the English translation of my French text.

# Color Vision responds to Natural Scenes: Roles of Glare, Receptor Quanta Catch, and Neural Spatial Comparisons

John McCann<sup>1,\*</sup>

<sup>1</sup> McCann Imaging; mccanns@ac.net

\* Corresponding author: mccanns@ac.net

## Abstract

The goal of human color vision research is to understand how we see Color. Our vision has evolved to guide us through the world's Natural Scenes. Appearances made by our color vision are the result of: optics of the eye, molecular quanta catch of receptors, and spatial image processing of neurons. The scene in front of the lens is the first critical variable in modeling vision. The spatial distribution of radiances coming to the eye initiates the first major visual event, namely intraocular glare. Imaging the retinal image redistributes the very large dynamic range of light in complex Natural Scenes. The second event is the receptors' response, namely, Light/Matter reactions in atoms and molecules. Color results from the different spectral sensitivities of rods and cones. The third event is that receptors initiate the network of neural spatial comparisons that lead to Appearances. This network is stimulated by the output of all receptors in the retina simultaneously. This talk is about the effects of scenes, glare, quanta catches, neural image processing, and Appearances. This talk introduces 8 different studies of vision that trace the light from the scene, through measurements of Appearances. It discusses Theoretical Color experiments, and practical Color technologies that respond to complex Natural Scenes.

**Keywords:** *Intraocular glare, Rod/Lcone Color, Appearance in Complex Scenes, Calculate Appearances, Neural Spatial Comparisons, Algorithms that mimic vision.*

## INTRODUCTION

Studies of Color Vision and Light/Matter interactions are 24 centuries old. Plato and Aristotle speculated about color vision. Ancient Greeks reported light-sensitive matter. When certain substances were exposed to light, the substances changed, indicating a chemical reaction. These Light/Matter interactions are the result of photons transferring energy to atoms and molecules. This energy transfer is called quanta catch, or matter's spectral response to light. When light exposes silver-halide salt, each quanta catch converts a silver ion to a stable silver atom. All Light/Matter interactions take place in the spatial dimensions of angstroms. Human vision captures information over a solid angle of  $>140^\circ$ . It begins by optically imaging light on receptors in the retina. After that it sends the quanta catch information from 100,000,000 receptors to the brain, using only 1,000,000 optic nerves. From neural junctions every receptor sends its light responses to neurons. These neurons make Spatial Comparisons to make visual Appearances. Traditional photography, movies, and analog videos are records of sensors' responses to quanta catch. Today, we talk of picture elements, or pixels. Cameras capture light, and record it as digital pixel values. Imaging technologies transmit the array of all those digit values to different media: print, television, and digital displays. The vast majority of imaging technologies perform this task one pixel at a time. Namely the capture, transmission, and presentation to observers works the same as a landline telephone wire connecting the sensor response with the display output. These imaging pipelines, from photon capture to display, are constant for all local image segments. Every segment is processed separately - independent of all the signals from all the other segments. In 1961, as a Freshman at Harvard, I began a part-time Lab Tech job for Edwin Land, and Nigel Daw of Polaroid in its Vision Research Laboratory. Land's study of Red and White (Two-Color) Photography made him realize that vision is fundamentally different from photography. Light/Matter interactions are limited to a single pixel's response to light. Silver halide film responds to individual microscopic scene segments, independent of the rest of the scene. However, Land realized that visual Appearances respond to the spatial content of the entire scene,

after the receptors' responses. In the mid-1960's Land and I spent time discussing vision's response to the Natural Scene. One of the themes we discussed was "How human spatial vision worked". Could understanding human spatial vision lead to better photographs? Land was equally fascinated with both Color challenges: Theory and Practice. How could technology "mimic human vision"? Over the decades that challenge was refined to become: accurately capture light from the entire scene, calculate appearances of all scene segments (using multi-resolution spatial comparisons), and write all appearances on film, now media. Figure 1 illustrates three stages of photography. The three photos were taken out of the same laiced window in Fox Talbot's home, Lacock Abbey, Wiltshire, UK. Figure 1A is a reproduction of Talbot's 1835 negative photo. It is the oldest surviving silver halide negative image. Figure 1B is a digital rendition of the same scene using three fixed (R,G,B) tone-scale reproduction responses to spectral light. This photo mimics the combined positive and negative responses of Kodacolor and Fujicolor prints. In other words, it mimics the pipeline process that made most color photo prints from 1940 to 2000. Each input pixel determined the value of the output pixel. All pixels used the same pipeline (Tone Scale Function). Figure 1B is a pixel-by-pixel rendition of the films' quanta catch.

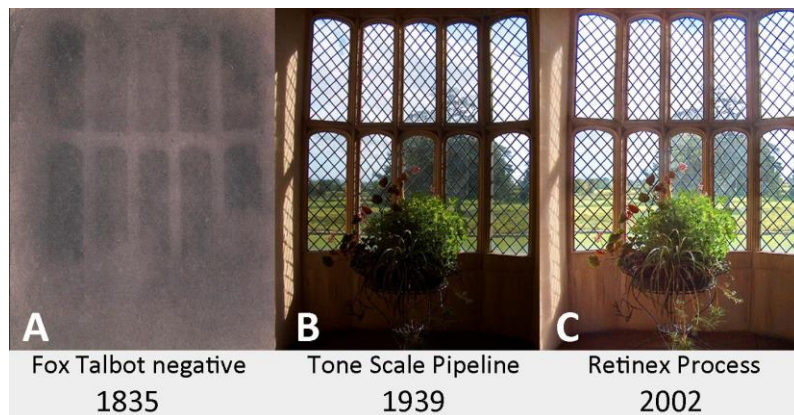

Figure 1: Three photos of Fox Talbot's window. 1A is a reproduction of Talbot's surviving negative. 1B illustrates color prints made using 3 (RGB) fixed Tone Scale Curves (eg. Kodacolor). 1C Digital camera image made with spatial comparisons to compress the scene's high range of light to fit the print's low range of reflectances.

Figure 1C is an icon of photography that mimics human vision. It is a digital photograph using HP's Digital Flash image processing that incorporated Frankle and McCann's (1983) Retinex algorithm. The image used spatial comparisons to transform the scene's high-dynamic-range into a low-dynamic-range image for printing. By emphasizing edges and controlling gradients the algorithm compressed the scene's range of light to render the Appearances of the bright garden and dim interior. Vision's response to the Natural Scene is to build Appearances out of multi-resolution spatial comparisons. These spatial comparisons tend to cancel the effects of optical glare by transforming quanta catch into a new unique rendition of the scene. Optical glare's scene transformation responds to the distribution of light in the scene. Vision counteracts glare by neural spatial processing that responds to the distribution of light on the retina. (McCann et al. 2012). This talk compares and contrasts vision's spatial processing with the single pixel pipelines used in photography from 1835 to 1981. Until digital image processing, photography lacked the technology to compare quanta catches from every part of the scene. As well, this talk discusses how digital photography is currently moving from Tone Scales to Spatial Processes to improve its rendition of all scenes. This talk describes 8 studies in which the receptor quanta catches after intraocular glare, and neural spatial comparisons interact with the Natural Scene, and other complex images. These studies emphasize that vision's spatial comparison network vastly expands our ability to do much more than just count quanta. Further, studies of Natural Scenes "opens our eyes" to incorrect hidden assumptions associated with single-pixel pipelines.



## UNIFORM APPEARANCE COLOR SPACE

Newton, Goethe, and painters describe many different hue circles. Munsell was a fine-art painter who taught at Mass College of Art, Boston. He also invented a uniform color space. Munsell did not use theoretical principles to define his space. Instead, he gave observers the practical task of selecting a sample that appears equidistant from two endpoints in a Natural Scene. The Munsell space we use today is a work of the first 1975 Judd Medalist, Dorothy Nickerson. Her work defined the volume of the uniformly spaced papers in today's Munsell Re-notation (Newhall et al. 1943). Figure 2A shows Munsell's early painting of a color space in 1900. It is an idealized color sphere with white as north pole, and black as south pole. Different hues are arranged around the equator. Nickerson's model (Figure 2B) shows the actual color space built up using equal increments in hue, lightness, and chroma. The white/black polar axis is a cube-root function of reflectance. The hue circumference is a much more complex shape. It is the result of the spectra of illumination, the atomic orbitals of dye and pigment molecules, the quanta catch of human receptors, and their post-receptor neural processing. The Color Space that has uniform spacing is far from spherical. Each hue angle has a unique lightness/chroma population of colorants.

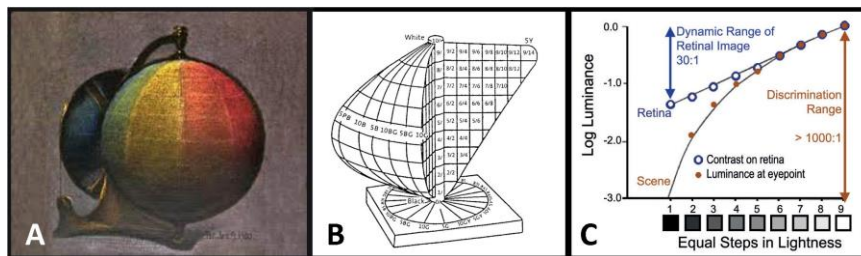

Figure 2: Three representations of Munsell's Uniform Color Space. 2A Munsell's painting of a color sphere in 1900. 2B Nickerson's plot of 1943 Re-notation. 2C Stiehl's 1983 plots of 9 HDR equal steps in Lightness (scene and retina).

The 1943 Munsell-OSA space has traded the globe's elegant simplicity for the most valuable property in digital imaging, namely a Uniform Color Space. Distances in color appearance have to be calculated in a uniform 3-D space. Digital images live in the domain of numbers, and their manipulation. The molecular physics of light sensors (silver halides and silicon chips) counts photons to make a linear scale. The average of 2 linear quanta catches is the midpoint between them. All subsequent pipeline image-processing manipulations are non-linear in radiance. In non-linear spaces ordinary arithmetic averages act differently. Nonlinear digit values need definitions and calibrations. In the reflectance of papers, the white is  $\sim 100\%$ , and black is  $\sim 4\%$ ; average is  $\sim 52\%$ . Munsell asked observers to tell him the midpoint between white and black, and extended the principle to make an entire uniform color space. Munsell's middle-gray Nt5.0 reflects 20% of incident photons not 52%. Photographers recognize middle-gray as the antiquated Kodak 18% Gray Card, used to set camera exposures. Photographers used 18% Gray Cards as an object at the center of the Natural Scene.

### WHY IS MIDDLE GRAY 20%, NOT 52% REFLECTANCE?

Physiologists since the 1930's have measured retinal receptor's response to light. Neural response is proportional to log of the outer segments quanta catch (Oyster, 1999). But, Appearances in a Natural Scene do not fit a logarithmic function. Munsell's Lightness Values, CIE  $L^*$ , and Savoy's HDR experiment (bisecting Lightness) fit a cube root function. Figure 2C plots log luminance in blue circles, and cube-root luminance in dark red dots from 9 equally space Lightnesses. Stiehl, Savoy, and McCann (1983) used Munsell's bisection technique to make an HDR uniform lightness scale using transparencies on a light box. Figure 2C plots the telephotometer luminance measurements of the display as dark-red dots. The data fits the cube root of scene luminance. The authors also calculated the light on the retina after intraocular glare. They used the work of

the 1991 Judd Medalists Hans Vos, namely his Glare Spread Function (GSF) to calculate the receptors' actual stimulus, plotted as blue circles. The GSF converted scene luminances to retinal luminances:

- Equally-spaced Lightnesses fit log Retinal Luminance
- Retinal Receptor response fits log Retinal Luminance
- Lightness is proportional to Retinal Receptor response
- Mid-point in Receptor response = 20%; Mid-point in quanta catch = 52%

Middle-gray, Lightness step 5 in Figure 1C is 20% of the maximum retinal luminance. Above middle gray, the log and cube root functions superimpose. As scene luminances decrease below 20%, optical veiling glare adds scattered light from the rest of the scene to the darker steps. Equal Lightness steps required observers to select darker and darker transparencies in order to overcome scattered light.

[ Summary: Lightness is proportional to Retinal Receptor response (after glare) ]

### CONTRAST AND ASSIMILATION

Visual illusions are a popular pursuit of color scientists. Null experiments are a favorite. How does the rest of the scene influence the appearance of identical stimuli? In Figure 3A we have 8 identical Gray luminances (4 circles-top and 4 crosses-bottom). On the left side Grays are on a uniform background, and all appear the same Gray lightness. On the right the four Grays have different backgrounds. On top-right we see Gray circles on the traditional Contrast backgrounds of black (lighter appearance), and white (darker appearance). Below the Contrast illusion, we have Assimilation by Todorović, (1997). It is scaled to fit the Contrast illusion above it. In Assimilation we see Gray circles behind slits in white and black foregrounds. In this spatial arrangement, the mostly white ground makes the Gray appear lighter, the mostly black ground makes the Gray appear darker.

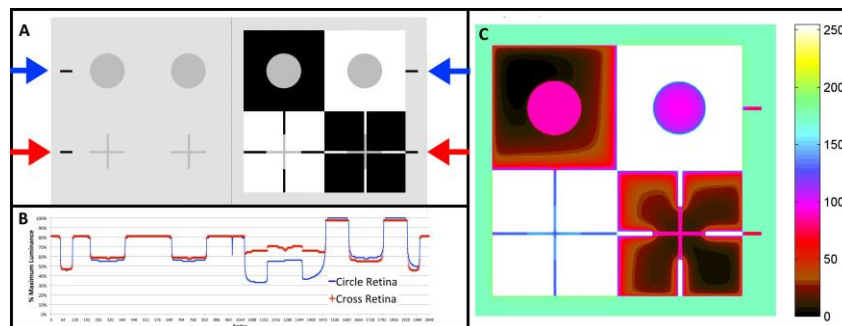

Figure 3: Contrast and Assimilation analysis. 3A Reproduction of the illusion. 3B Two horizontal plots of calculated retinal luminance (blue=Contrast / red=Assimilation). 3C Pseudocolor visualization of retinal 3A with color map.

As scientists, how do we sort out our observations that the top Contrast-white ground makes darker Gray appearance; and bottom Assimilation-white makes lighter Gray. How does the top Contrast- black ground make lighter Gray; and the bottom Assimilation-black make darker gray? The answer is that there are two different, independent spatial transformations of the light coming to our eyes. The first transformation is pre-retinal, namely intraocular glare. The pair of Contrast/Assimilation illusions has 4 identical Grays at the cornea (Scene luminance). They are spatially transformed by glare. The 4 Grays become 4 markedly different Retinal stimuli. While all Grays are identical at the cornea, the receptor responses are very different because of glare light. We used the McCann and Vonikakis (2018) Matlab program to calculate the pattern of light on the retina caused by Figure 3A image (2048 x 1024 pixels; 8 bit). Figure 3A was viewed on an iMac computer screen at 30 inches, subtending 15° by 7.5°. The digit to screen luminance calibration was made using a Konica Minolta CS100 colorimetric telephotometer. Measurements were made using an opaque mask blocking all other light from the screen in a dark room. The blue arrows in Figure 3A indicate the location of a horizontal digital scan of the calculated retinal image (Contrast Illusion). The blue plot in Figure 3B is the average retinal luminance

of a 3 pixel high scan across the middle of the 4 gray circles in the Contrast illusion. The red arrows in Figure 3A indicate the location of a second horizontal digital scan. The red plot in Figure 3B is the average retinal luminance scan across the middle of the 4 Gray crosses in the Assimilation illusion. The hidden assumption in both Figure 3A Contrast and Assimilation illusions is that there is zero intraocular glare. Comparisons of Contrast and Assimilation assume that equal digits sent to the display device causes equal retinal luminances. However, the red and blue scans of the gray scene components are different. In Figure 3B-left, Grays on a uniform light gray background, the crosses scan (red) have more background scatter than the circles (blue). In Figure 3B-right, Assimilation's white foreground is adjacent to the Gray cross, and it adds still more glare light. As well, Contrast's Black circle caused the least amount of glare in all 8 Gray segments. These plots shows that glare is the first transformation that distorts scene luminances. The neural (2nd spatial) transformations that create Contrast and Assimilation begin with unequal retinal luminances. This takes the Null experiment (Equal Stimuli) argument "off the table". The illusions in Figure 3A do not make a constant neural input for all Grays in the scene. Figure 3A is an abstract simulation of the Natural Scene. It is made up of uniform patches of light with perfect square-wave edges. There are no gradients in this digital image. The retinal image of 3A is different. All the sharp edges become a wide variety of different slope gradients. Figure 3C is a pseudocolor rendition of the calculated retinal digits proportional to log retinal luminance. The digital map on the right side identifies the hues used to visualize the gradients in the retinal image. Digit 255 is rendered as white, Digit 127 is gray blue green, and digit 0 is black. By rendering the retinal image in 64 discrete colors, pseudocolor breaks gradients into visible bands that allow us to visualize the shapes of the gradients. Gradients in pseudocolor are much more visible that in an achromatic rendition. In the illusions white areas contribute more glare than they receive, They show little change. Glare transforms uniform scene blacks into a wide assortment of gradients on the retina. Figure 3C shows many different local spatial transformations of the "equal grays" in the scene. Intraocular glare upsets the null experiment; it redistributes Scene's light in the retinal image.

[Summary: Retinal Luminances ≠ Scene Luminances] Intraocular Glare is the first Spatial Transformation of scene information ]

### **LIGHT/MATTER INTERACTIONS OF MOLECULAR PHYSICS → COLORIMETRY**

Color is our response to light from a scene. Colorimetry's Matches are the result of the Light/Matter interactions of molecular physics. Colorimetry's input is the spectral radiances of a spot of light. As David Wright, the 1977 Judd Medalist, pointed out "colorimetry ends once the light has been absorbed by the colour receptors in the retina and that appearance science begins as the signals from the receptors start their journey to the visual cortex" (Wright 1987). David Wright splits Color into two topics: Colorimetry, and Appearance. Colorimetry is a triumph of psychophysics. The spectral sensitivities of the receptors are the input to vision (Figure 4A). Light/matter interactions lead to the color matches that David Wright contributed to Colorimetry. These matches are the result of the individual quanta catch of independent light receptors. Equal receptor quanta catches make matches that take place in the retinal rod and cone outer segments. The red ellipse at the top of the left side identifies the only site of light/matter cone interactions.

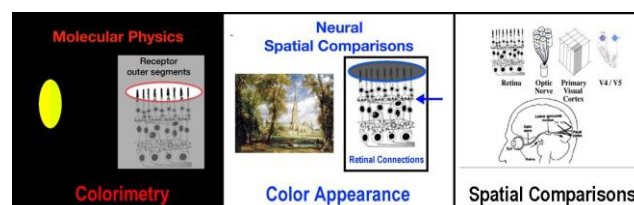

Figure 4: Wright's Colorimetry/Appearance distinction. 4A Wright's Colorimetry is limited to receptors' quanta catch. 4B Color Appearance begins to renders HDR scenes using a network of neurons that make Spatial Comparisons in the retina. 4C Spatial Comparisons continue at every stage in the visual pathway.



The only scene radiance measurements allowed in all CIE Colorimetry calculations are the X, Y, Z values of a single small spot of light on these receptors. Colorimetry predicts matches from the spectral radiances of single spots of light on a no-light background. If there is no glare from surrounding scene segments, then the only glare comes from the spot itself. The red ellipse in Figure 4A illustrates Wright's stop sign for Colorimetry, namely the independent quanta catch in receptor outer segments (McCann 2020).

[Summary: Colorimetry calculates equal quanta catches to predict color matches. Applying CIE X,Y,Z to Natural Scenes requires an additional calculation of the effects of intraocular glare]

### **APPEARANCE: NEURAL SPATIAL COMPARISONS → RENDITION OF NATURAL HDR SCENES**

Figure 4B uses a scene icon, namely, John Constable's 1825 HDR painting. It illustrates the Bishop, his cathedral in sunlight, and his garden in shade. It is a record of what Constable saw. His Appearances of the scene were recorded by his painting. Unlike Colorimetry, real HDR Natural Scenes have abundant optical glare in both vision and cameras (McCann and Rizzi 2012; McCann, et al. 2018). Glare transforms the HDR scene radiances into a substantially different image on the retina (McCann et al. 2018). While scene radiance of a single spot is the appropriate input to Colorimetry's Matches, we cannot use the single pixel radiance as the input to neural spatial processing. A spot of scene radiance does not include the substantial scattered light from all other scene segments. Neural input is the complete array of all receptors' quanta catch after glare, not the scene radiance of a single pixel. In Figure 4B at the neural junctions (blue arrow), on the lower end of the rod and cone receptors, the study of Appearance begins. Color Appearance models use all receptors' response as input to the retina's complex spatial processing. Figure 4B is based on John Dowling's map of retinal connections. It is the start of the cascade of neural interactions that travel down the optic nerve and throughout the brain. Figure 4C shows the many different types of neural spatial comparisons, and their location along the visual pathway. It illustrates the work of Dowling, Kuffler, Barlow, Daw, Hubel, Wiesel, Devalois, Zeki, and Conway. The visual pathway is a cascade of spatial comparisons starting with receptor's synapses and continuing at every neural stage (McCann 2020).

[ Summary: Neurons build Appearances using spatial comparisons ] [ Neurons make the second Spatial Transformation of scene information (quanta catch) ]

### **NEURAL SPATIAL COMPARISONS - EDGES NOT LIGHT CONTROL COLOR APPEARANCE**

Figure 5A is a simple illustration of edges. On a white page we see a reproduction of a smooth digital gradient from 255 to 0. On top of that gradient are 9 identical rectangles, each with uniform digit 146. (Use your computer's Digital Color Meter to verify that all these rectangles are identical.) The Appearance of the 9 rectangles varies from light gray to dark gray. Scene luminance does not correlate with appearance. The uniform gray luminances have distinctly different edge ratios with the surrounding gradient. Edges, not uniform luminance, control Appearance. Figure 5B (left) illustrates a section of Land's BlackandWhite Mondrian - complex array of achromatic matte papers (Land and McCann 1971). The illumination was a smooth luminance gradient (low at top to high at bottom). Two middle gray papers are in the red rectangle. There are two points on this pair that measured 160. The upper 160 is the combination of a higher reflectance paper (right) in slightly lower illumination. The lower 160 is the combination of a lower reflectance (left) in slightly higher illumination. The luminance of the right paper is 200 in the higher illumination. The lower change from luminance 160 to 200 is an edge caused by an edge in luminance. Edges causes substantial changes in Appearance. The vertical change from luminance 160 to 200 is caused by a smooth gradient in luminance. Gradients cause almost invisible changes in Appearance.

[Summary: Edges, not light, control Appearance. In Natural Scenes Edges and Gradients are critical variables, not Reflectance and Illumination].

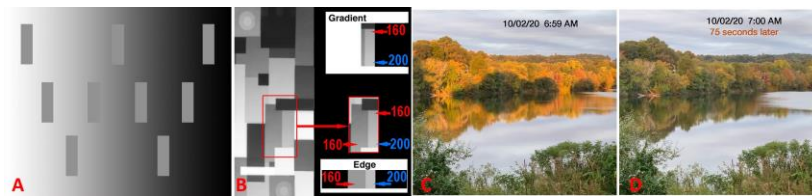

Figure 5: Edges and Gradients. 5A Nine identical gray luminances have 9 different appearances. 5B Edges cause large changes in appearances, while gradients are almost invisible. 5C Photo with edge in sunlight illumination. Vision does not discount edges in illumination. 5D Photo without illumination edge taken 75 seconds later.

### EDGES IN ILLUMINATION

Figure 5C,D is a pair of photographs made 75 seconds apart. The photos were taken just after sunrise in the fall of 2020. In 5C the distant trees were in sunlight. A large clump of closer trees were in the shadow of a low cloud. That cloud created a sharp edge in illumination. In 75 seconds a cloud moved to block all sunlight (5D). The edge in illumination was gone. The trees in the photographs have markedly different appearances. Edges in illumination cause major changes in Appearance. Most people pay attention to objects in the Natural Scene. Photographers study illumination. They observe the interaction of objects and illumination. We are good at recognizing approximate luminance; sunny vs. cloudy day; sunrise, dusk, sunset. Illumination contributes to our emotional state. The two photographs in Figure 5C, D have different emotional impact, even though two-thirds of their pixels are identical. There is strong evidence that Helmholtz's Unconscious Inference exists. The important question, however, is whether there is any actual evidence that Inferences affect Appearances, rather than just being a consequence of them. In Figure 5C, observers do not discount illumination.

[ Summary: Edges in Illumination generate the same visual response as Edges in Reflectance.]

### CAPTURING THE APPEARANCE OF MULTI-COLORED NATURAL SCENES

J.C. Maxwell's invention of color photography used three different R, G, B spectral photo records of the light from the scene. This invention is a most helpful process in studying Color in the Natural Scene because it allows us to experiment independently with the scenes' color information, and the spectral transfer to receptors. Experimenting directly by changing illumination on objects changes both scene information and receptor responses at the same time. Figure 6A shows the R,G,B color separation photographic records. It lists three wavelengths used to make an additive color projection (656, 546, 450 nm illumination). Note the six color squares added to the photograph (RGBYMC). Also note their grayscale rendition in each of the three achromatic separations. Red square is the color associated with white square in 656nm, black in 556nm, black in 450 nm. The Y square is black in the B record, and white in both G and R. Full color reproductions are possible with RGB spectral information of the entire scene, and different wavelengths of light to transmit the color information to the L-, M-, S-cones (Fig 6A). These photo color separations are a constant record in all wavelengths. Full color photographs require different spectral information (R,G,B separation records) and different sensory color channels (L, M, S, rods). If the separation records are identical, the appearance is monochromatic. L, M, and S cones work best in roughly equal energy illumination, such as daylight.

### TWO-COLOR NATURAL SCENES

We can use spatial records and channel wavelengths to analyze natural complex colored scenes. Maxwell's color separation photographs on black and white film has frozen the spectral information from each scene segment. Full color reproductions requires three separations and three transmission wavelengths. However, two spectral separation photos, and two illumination spectra make multicolor scenes (Figure 6B). Here we have the same three wavelengths illuminating the records. However, we have used the G records in both the

Color Vision responds to Natural Scenes: Roles of Glare, Receptor Quanta Catch, and Neural Spatial Comparisons  
556nm and 456nm light. The result is a two-color rendition of the scene that has many different hues, lightnesses, and chromas, but not all of them.

[Color Separations freeze scene's spatial information that Spectral light sends to them to LMS cones]

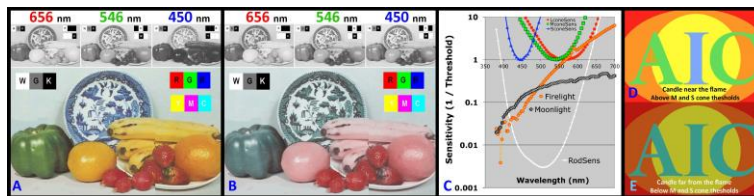

Figure 6: Three Color, two Color channels, and Color from rods and L-cones. 6A Photo mimicking Maxwell's 3 color photos using 3 records in 3 wavelengths. 6B Two channel color. 6C Spectra of receptors, moonlight and firelight. 6D Appearance in bright firelight (> MandS cone threshold). 6E Appearance in dim firelight (< MandS cone threshold).

### RODS IN DIM FIRELIGHT ARE COLOR RECEPTORS (BELOW M-AND S-CONE THRESHOLD)

While life on earth dates back 3.5 billion years, and vision's Opsin chemistry dates back 600 million years, our L-cones mutation is much more recent, namely, 30 to 6 million years (McCann, 2006a). Most moonlit scenes appear achromatic. Highly colored objects appear as shades of gray without a full moon. Max Schultze (1866) proposed Duplicity Theory; simply stated, rod receptors form an achromatic channel; cones form chromatic channels. Figure 6C plots the relative light needed for absolute threshold of rods and L,M,S cones at each wavelength. Blue curve plots S-cones spectral sensitivity. The green and red curves plot M- and L-cone sensitivities. The white curve plots rod sensitivity. At 500 nm rods are 1000 times more sensitive to light than cones (McCann 2006a). A large collection of different experiments have shown that rods and cones interact to generate two-color vision. (For current reviews: see Stabell and Stabell (2006), and McCann, (2021:Rod-Lcone). These experiments use the many distinct physiological properties of rods and cones to identify whether a particular visual response is from rods, or from cones. These physiological properties include: action spectra, dark adaptation threshold, Stiles-Crawford effect, flicker fusion frequency, gray vs. color appearance of monochromatic stimuli, and apparent sharpness of the image. In these experiments observers reported seeing multicolor images when G record illumination levels were well below M- and S-cone thresholds. Using rods and L-cones makes multicolor scenes. As an example, observers adjusted the G record luminance of a multicolored (two color) image to measure the best color balance - not too warm, nor too cool. The luminance of the 656nm on the R record was constant. The measurement was repeated varying the wavelength of the G record illumination from 420 to 610nm. Observers adjusted each wavelength's luminance for best color balance. The plot of best color balance luminance vs. wavelength measured the action spectra of the color judgement. That action spectra fit the scotopic (rod) sensitivity curve. The action spectra showed that G record best-color adjustments were made using rods alone. (McKee et al. 1977).

### DEMONSTRATION OF ROD/L-CONE COLORS

At low light levels reflected moonlight excites the rods, but does not have enough light to excite the L, M, S cones. The spectrum of firelight is 1700°K. In Fig 6C moonlight and firelight have equal radiances at 500nm. Firelight has nearly 10 times more radiance at 650nm than moonlight. Dim firelight is an ideal emission spectra to excite rods and L-cones to making spatial comparisons in two color channels, while having insufficient light to excite M- and S-cones. Observers report 2 channel Color vision at low-illumination intensities in firelight.

Figure 6D illustrates the appearance of an inkjet print illuminated by a single burning candle placed close to the print. Letters A, C appear green; letter I appears blue. These are 3 channel colors. By simply moving the printed AIC target away from the candle, its illuminance decreases with distance. Figure 6E illustrates the appearance of the same inkjet print illuminated by that candle far from the print. Observers report that letters A, I and C all appear cyan. When the AIC print is far from the candle, the color appearances are the result of 2

Color Vision responds to Natural Scenes: Roles of Glare, Receptor Quanta Catch, and Neural Spatial Comparisons channel rod and L-cone color interactions. The AIC print in the observer's hand does not change, but the decrease in firelight took it from above L,M,S cone threshold - to below M, S cone threshold. The cyan AIC is from rod/L-cone color interactions. Download the AIC file, print it, and try it (McCann, 2021: DemoRod-Lcone).

[ Summary: The rods are a perfectly good color receptor in appropriate firelight illumination ]

### **WHAT IS VISION'S RESPONSE FUNCTION (VRF) TO LIGHT?**

We often talk about the response of the eye to light. Too often we talk about it as if we have a fixed Vision Response Function (VRF) to light, just as silver halide film does. Film catches quanta that convert ions to atoms that absorb light. That response is constant in all parts of all scenes, in all conditions. We all know that human response to light is variable. We know that pupil size is variable, and that dark and light adaptation is variable. Measurements of Human VRF ask the question: "If a spot of light has two times the luminance, how much does appearance change?" This is a trick question. The answer is that there are many distinctly different VRFs. Observers answer specific questions. Each question, such as "Can you detect this light?" gives reproducible answers across many observers. The problem is that different scenes, and different questions give a wide range of reliable answers! Figure 7A plots the VRF for three scenes.[See inset with illustrations: 100%W (top);50%W(middle); 0%W Bottom)]. It is the plot of Lightness vs. Retinal luminance (after glare) for three different HDR transparency test targets, all with ranges close to 6 log<sub>10</sub> units. The VRF of 40 gray squares in the Black surround (0% Max luminance) is a low slope log plot over the range of 10,000:1 between Appearance White and Appearance Black. In the 100% Max luminance surround, the same range of Appearance White to Appearance Black plots over only 30:1 range of retinal luminances. In 50% Max Luminance the White to Black change plots a 100:1 range of luminances. The content of the retinal image changed the White to Black VRF of retinal luminances by a factor of 300 in range. (McCann and Rizzi 2012; McCann and Vonikakis 2018). Figure 7B plots the VRF for four circular gray scales with different luminances in an opaque surround. These gray-scale transparencies have a range of 20:1. The top circle had maximum luminance; others had neutral filters that reduced luminances by factors of 10, 100, 1000. The overall target has a range of 18,909:1. Figure 7B (blue) plots VRF Lightness vs. log scene luminance. All 4 VRF Appearances have parallel slopes, each normalizes to the local maxima in each circle. The green line plots the Appearances of just the local Maxima (McCann 2006b; McCann and Rizzi 2012: 113-219). Maxima have the same slope VRF in single spots of light, in complex scenes, and in local regions of a complex scene. Neural processing assigns all maxima to the same (green line) VRF. Other nearby darker scene elements have variable slope VRF that depends on the local content of the scene.

[ Summary: The Appearance of Maxima have a fixed slope VRF in all scenes. ] [ The VRF Appearance of darker scene segments varies with the content of the scene. ]

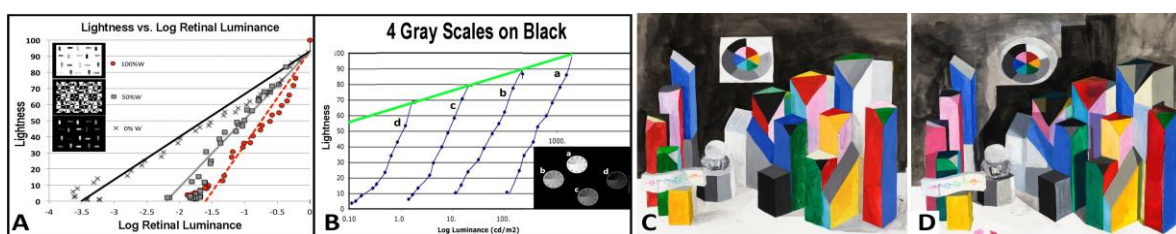

Figure 7: Studies of VRFs and 3-D Mondrians. 7A plots Lightness vs. HDR retinal Luminance in 3 displays with different surrounds. 7B plots Lightness vs. Scene luminance in 4 circles in one display. 7C and 7D shows Carinna Parraman's watercolor paintings of 3-D blocks in LDR (7C) and HDR (7D) illumination.

### **MEASUREMENTS OF COLOR CONSTANCY WITH EDGES IN ILLUMINATION**

A low-dynamic-range scene can be thought of as an arrangement of papers mounted on a flat surface in perfectly uniform ambient illumination. The range of the scene is limited by the range of surface reflectances

of the papers. White to Black matte papers have a range of 30:1. High-dynamic-range is the direct result of nonuniform illumination. Natural scenes, with sun and shadows, often have ranges of >3,000:1. By combining light emitters, reflective surfaces, transparencies, and shadows, one can create almost any scene dynamic range. The practical limits of image dynamic range is imposed by the optics, not scene radiances. How does expanding illumination range affect color constancy? McCann, Parraman and Rizzi (2014) used a 3-D arrangement of blocks with 104 painted facets. All facets were painted with one of 11 paints (R, Y, G, C, B, M, W, G1, G2, G3, Bk). The experiment used two sets of identical blocks in two different illuminations: LDR illumination using a light-diffusion tent; HDR illumination with directional lights that made sharp shadow edges. In the first experiment observers used color maps to identify all surfaces painted with one color paint. Observers used magnitude estimation to measure the departures from constancy for all red painted surfaces. Then, observers measured Constancy departures for all paint surfaces in both LDR and HDR scenes. Departures from Constancy were substantially larger in HDR illumination. In the second experiment Carinna Parraman made watercolor paintings of the LDR (Figure 7C) and HDR (Figure 7D) 3-D Mondrians. Her paints matched the appearance of every image segment. She painted them in uniform illumination on the watercolor paper. She then measured the surface reflectance of each segment to quantify their appearances. The reflectances of these matching Appearances showed the same result. Identical painted surfaces in HDR illumination had much larger departures from perfect constancy.

[ Color Constancy is absent in single spots of light in darkness; strongest in flat LDR Mondrians in uniform illumination; and much weaker in Natural 3-D scenes with edges in HDR illumination. Prior knowledge of the surface's actual reflectance does not affect Appearances.]

## **HDR RENDITIONS**

Figure 8 is an illustration of successful HDR rendition algorithms. In Figure 8A Leonardo da Vinci made Chiaroscuro paintings around 1500 that renders both objects and illumination. Figure 8B shows van Honthorst's 1620 painting of four figures at different distances from a candle, in different levels of illumination. The painter used local maxima to compress the range of the scene. Below the painting is a plot of appearances of 4 pie-shaped gray scale transparencies (described above in Figure 7C). The candle and the faces of the four people are local maxima. They darken at a very low rate (Green line). The scenes around them have a very high rate. This recent psychophysical experiment gives quantitative calibration to the Appearances that van Honthorst observed 500 years ago. Figure 8C shows "John at Yosemite, 1981" digital print of multi-resolution calculated Appearances on film. The HDR photo was taken in Yosemite Valley. The shade of the tree had 30 times (5 stops) less illumination than the sunlight. Spot photometer readings from John's white card (in shade) were equal to ColorChecker's black square (in sunlight). The sun-shade scene's dynamic range was 10 stops, or 1,000:1. Color print's range cannot reproduce this scene. However, color negatives have >1,000: 1 sensitivity range. Figure 8C used color negative film to capture the scene; an Itek scanner to digitize it; and Frankle and McCann's (1983) multi-resolution Retinex image processing to calculate appearances to reduce the output range to 30:1 to print on film (McCann and Rizzi, 2012). Figure 8D shows three photos of the same scene; (left Da) is a control photo using a fixed RGB tone-scale pipeline for pixels; (Db) is an HP's Digital Flash implementation of Frankle and McCann's Retinex algorithm (1983); (Dc) is a iPhone X synthesis of local regions selected from many different exposures. By selecting the image segments with best local rendition and fusing it with other optimal renditions from different images it synthesizes the best overall rendition. All of these techniques of painting, calculating, and firmware processing are different, but they make renditions that human vision accepts as an Appearance record of the entire original scene.



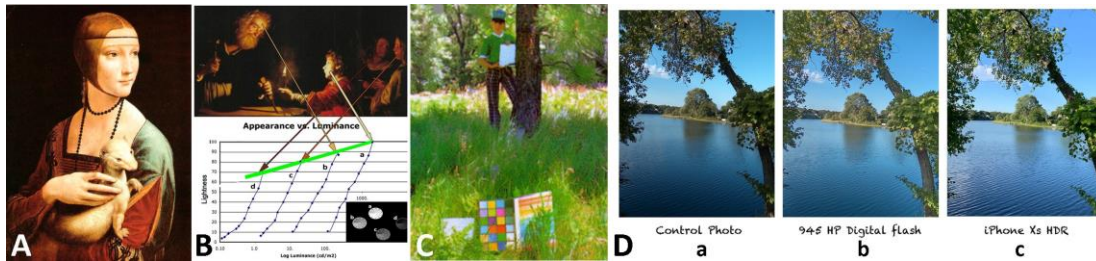

Figure 8: Successful HDR Spatial Processes: (A) da Vinci painting; (B) van Honthorst's painting with local normalization; (C) Retinex algorithm; (Da) Control; (Db) HP Retinex Camera; (Dc) Apple iPhone X.

These very different technologies all mimic vision's response to the Natural Scene. They all render the HDR scenes in LDR images. They are all spatial transformations of scene radiances. The most important feature of Figure 8's processes is they work in all scenes, HDR and LDR. Unlike pixel pipelines, vision and multiresolution spatial comparison algorithms successfully process all scene ranges in all types of scenes. Electronic Imaging has begun to learn what painters did 6 centuries ago.

[ Electronic Imaging is beginning to mimic our color vision's interpretation of Natural Scenes ]

### **SUMMARY: COLOR VISION'S RESPONSES TO COMPLEX NATURAL SCENES**

Human color vision is the result of light captured by receptors, and followed by the neural processes that lead to Appearances. This talk reviews 8 different studies of complex and Natural Scenes. Traditionally vision research emphasizes the quanta catch of molecules as the first step. While necessary, molecular physics is not sufficient because of pre-retinal intraocular glare, and post-retinal neural spatial processing. These 8 studies of complex scenes expand our understanding in many ways. They include Uniform Color Space, Null visual illusions of Contrast and Assimilation, Edges in illumination, Rods as color receptors, Appearance normalization to local maxima, digital image processing, and HDR scene compression technology. Many new ideas and understandings about Color Vision have come from simply using the complex Natural Scene as the experimental stimulus. These ideas and properties of vision cannot be observed in the too-restrictive experiments of spots of light. Furthermore, the integration of multi-resolution spatial comparisons of 3 color channels has led to proven models of Appearance, and practical real-time technology implementations of Color Constancy. These successful spatial-comparison processes do not need unproven inference and illumination detection in order to calculate Appearances. Color is the response of 20th century edges and gradient, not 19th century reflectances and illumination. Spatial comparisons make the job of AI computer models of object recognition practical. When spatial processing calculates Appearances, the job of calculating spatial inferences become much, much easier. Painters have rendered both scene and its illumination since da Vinci. They do it by local normalization and controlling edges and gradients. They render the high-dynamic-range world in low- dynamic-range media. These same image processing principles are becoming obvious from the study of the spatial patterns of light on the retina, the variability of visions response to light with the contents of scenes, as well as the neurophysiology of spatial image processing in the visual pathway. These 8 distinct studies show that the contents of Natural Scenes have a major active role in Color Appearances. The contents of each Natural Scene determines the optical glare transformation that becomes the retinal quanta catch. The contents of the retinal image response determines the neural spatial transformations that becomes Appearance. While receptors count quanta, both pre-retinal glare and post-receptor spatial transformation make substantial modifications to scenes' radiances. Too often we think of Color as a signals from a single spot of retina sent to the brain. In fact, it is the optical imaging of all the scene's light introduces glare that transforms the HDR Natural Scene radiances to a new light distribution on receptors. The retina responds simultaneously to the quanta catch of all receptors. Then, neural image processing make spatial



Color Vision responds to Natural Scenes: Roles of Glare, Receptor Quanta Catch, and Neural Spatial Comparisons comparisons. Glare is substantial in the Natural Scene, but spatial processing makes it hard to see. Neural vision responds to the content and arrangement of the array of receptor responses. Neurons process the spatial information, not just transmit it to undefined higher cognitive levels. Neurons respond to edges to synthesize Appearances, by compressing dynamic range, and compensating for the effects of optical glare. Unlike the HDR Natural scene, glare is inconsequential in Colorimetry's spot of light. The effects of Natural Scenes on Color Vision cannot be observed in experiments limited to a single spot of light in a dark room. Our vision evolved over the last 30 million years to extract information from all possible Natural Scenes.

## **ACKNOWLEDGEMENTS**

My interest in the Natural Scene began with my mentors: Edwin Land, his friend Ansel Adams, and Nigel Daw. They taught me an appreciation of vision and photography, and the skills of observing, and measuring, capturing, and rendering scenes. John Dowling taught me the intricate beauty of receptors, retinal neural pathway and its dark- and light-adaptations. I particularly want to appreciate all my colleagues over the years: Jeanne Benton, Jon Frankle, Alan Stiehl, Bill Roberson, Suzanne McKee, Karen Houston, Jay Thornton, Bill Wray, Jim Burkhardt, Vassilios Vonikakis, Carinna Parraman, and Alessandro Rizzi. Their work made this talk possible. I want to thank Mary McCann for her contributions and innumerable conversations about Color.

## **REFERENCES**

- Frankle, J. and J.J. McCann. 1983. Method and apparatus of lightness imaging. US Patent 4,384,336. filed Aug 29,1980; issued May 17, 1983.
- Land E.H. and J.J. McCann. 1971. Lightness and retinex theory. *J. Opt. Soc. Am.* 61:1-11.
- McCann, J.J. 2006a. Ideal illuminants for rod/L-cone color. *Proc.SPIE:SanJose.6058* : 605801-605808
- McCann, J.J. 2006b. Measuring Constancy of Contrast Targets in Different Luminances in Complex Scenes. in *ISandT Color Imaging: Sconsdale, Arizona.* 14:297-303.
- McCann,J.J., C. Parraman, and A. Rizzi. 2014. Reflectance, illumination, and appearance in color constancy. *Frontiers in Psychology,24,2014,00005*
- McCann, J.J. and A. Rizzi, 2012. *The Art and Science of HDR Imaging.* Chichester: ISandT Wiley.
- McCann, J.J. and V. Vonikakis. 2017. Calculating Retinal Contrast from Scene Content: A Program. *Frontiers Psychology.* 2017
- McCann, J.J, V. Vonikakis, and A. Rizzi. 2018. HDR Scene Capture and Appearance. *SPIE Spotlight Tutorial.*
- McCann, J.J. 2020. What scene information is needed for Models of Color Appearance in the Natural World?. *Coloration Tech,137:5-15.*
- McCann, J.J. 2021. Demo Rod-L cone. <https://www.retinex2.nettiPublicationstidemorod-lcone.html>
- McCann, J.J. 2021. Rod-L cone. <https://www.retinex2.nettiPublicationstirod-lcone.html>
- McKee, S.P., J.J. McCann, and J.L. Benton. 1977. Color Vision from Rod and Long-Wave Cone Interactions. *Vision Research* 17:175-185.
- Newhall, S., D. Nickerson, and D. B. Judd. 1943. Final Report of the OSA. Subcommittee on Spacing of the Munsell Colors, *J. Opt. Soc.A.* 33: 385-418.
- Oyster, C. W. 1999. *The Human Eye, Structure and Function.* Sunderland, MA: Sinauer Associates. Schultz, M. 1866. Zur Anatomie und Physiologie der Retina. *Archiv f. mikrosk. Anatomie* 2, 175–286. Stabell, B. and U. Stabell. 2009. *Duplicity theory of Vision.* Cambridge: Cambridge Un. Press.
- Stiehl, W. A., J.J. McCann and R.L. Savoy.198. Influence of intraocular scattered light on lightness-scaling experiments. *J. Opt. Soc. Am.* 73: 1143-1148.
- Todorović, D. 1997. Lightness and junctions. *Perception* 26: 379–394.
- Wright, W. G. 1987. A plea to Edwin Land. *Color Research and Applications* 12(3):119–120.

<b>1</b> COLOR AND MEASUREMENT INSTRUMENTATION	2 COLOR AND DIGITAL	3 COLOR AND LIGHTING	4 COLOR AND PHYSIOLOGY
5 COLOR AND PSYCHOLOGY	6 COLOR AND PRODUCTION	7 COLOR AND RESTORATION	8 COLOR AND BUILT ENVIRONMENT
9 COLOR AND DESIGN	10 COLOR AND CULTURE	11 COLOR AND EDUCATION	12 COLOR AND COMMUNICATION MARKETING

# 1 COLOR AND MEASUREMENT INSTRUMENTATION

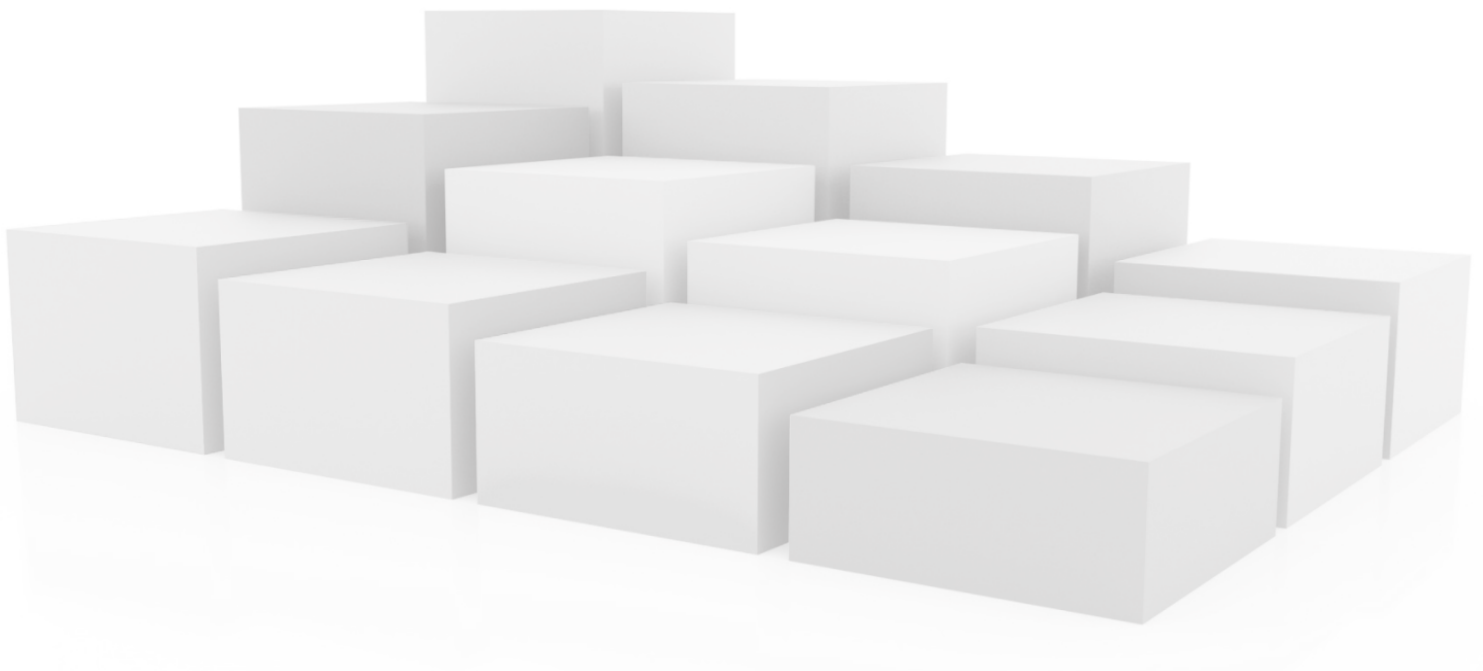



# Colour appearance of a white space with greenish daylight

Kanoko Makino<sup>1</sup>, Kaoruko Kitamura<sup>2</sup>, Haruno Tsuda<sup>1</sup>, Yuki Oe<sup>1</sup> and Nozomu Yoshizawa<sup>1, \*</sup>

<sup>1</sup> Tokyo University of Science; kanopii@outlook.jp, hyphen\_haru0505@outlook.jp; yukioe@rs.tus.ac.jp; yoshizawa@rs.tus.ac.jp

<sup>2</sup> Mukogawa Women's University; kitamura@mukogawa-u.ac.jp

\* Corresponding author; yoshizawa@rs.tus.ac.jp

## Abstract

White is a special colour used in modern architecture. According to a previous study (Kitamura et al. (2020)), the white in actual architecture appeared with various tints and tones. For example, the white walls inside are sometimes coloured green subtly by daylight with the reflected light of the surrounding greenery. The purpose of this study is to clarify to what extent the appearance of green in space can be varied with daylight coloured by the surrounding green, and to investigate its mechanism. In this paper, we conducted a model experiment, and the result showed that the area selected by observers as the most coloured area contained boundaries between the high and low luminance areas. The mechanism of the perception was discussed from the viewpoints of Mach band effect, Bezold-Brücke phenomenon, and chromatic adaptation.

**Keywords:** colour appearance, greenish daylight, white space, window

## INTRODUCTION

White is a special colour that has been used repeatedly in some traditional and modern architecture. In a previous study (Kitamura et al. 2020), it was clarified that the white in actual architecture appeared with various tints and tones. For example, the white walls inside are sometimes coloured green subtly by daylight with the reflected light of the surrounding greenery (trees, lawns, etc.). Observers can perceive the minute changes in colour and atmosphere inside architecture when various daylight enters achromatic spaces. The purpose of this study is to clarify to what extent the appearance of white in space can be varied with daylight, which is tinted by the surrounding green, and to investigate its mechanism. In this paper, as the first step, we focused on finding out the areas in a white room that is strongly tinted with green due to daylight from a window.

## EXPERIMENTAL METHODS

A model experiment was conducted to examine the difference in the degree of colour tint of the white interior space depending on the position and the size of a window. The full-scale model was installed on the lawn without surrounding tall buildings at Chiba Prefecture, Japan (N35°57'). The size of the model was 1800mm in width, 1800mm in depth, and 1800 mm in height. Its interior was made of polystyrene finished with white matte paper (x: 0.3144-0.3165, y: 0.3325-0.3344, on the CIE 1931 xy chromaticity diagram). As shown in the plan and the cross section of the experimental space in Figure 1, a peephole was cut on the front wall where an observer was seated, and a window was installed on the left wall.

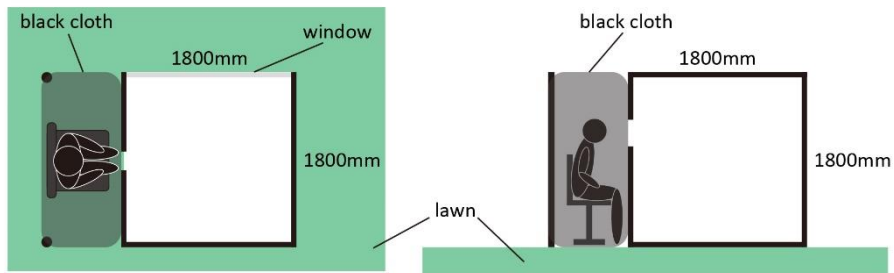

Figure 1: The plan and the cross section of the experimental space.

The position of the window, its size (height/width), and the window-to-wall ratio (window area/left wall area) in 6 conditions (as shown in Figure 2) are as follows: Condition 1: middle, 180 mm/600 mm, 3%, Condition 2: low, 180 mm/1800 mm, 10%, Condition 3: center, 180 mm/1800 mm, 10%, Condition 4: center, 180 mm/1800 mm, 10% - whereas the setting of the window was the same as in Condition 3, the lawn around the window was covered with a black cloth to remove the effect of greenery- Condition 5: upper, 180 mm/1800 mm, 10%, Condition 6: full height, 1800 mm/1800 mm, 100%. The experimenter adjusted the direction of the model to prevent direct sunlight from entering through the window. The experiment was conducted from 9:00 a.m. to 12:00 noon and from 13:00 p.m. to 15:00 p.m. for two days in September 2020, the first day was a mostly sunny day and the second day was a mostly cloudy day. A total of seven observers were divided into two groups, four observers on the first day and three observers on the second day. The observers were all in their early 20s with normal colour vision.

	Condition1	Condition2	Condition3	Condition4	Condition5	Condition6
Figure						
*Perspective drawings seen through the peephole.						
Position	middle	low	center	center	upper	full height
Size(width/height)	180mm/600mm	180mm/1800mm	180mm/1800mm	180mm/1800mm	180mm/1800mm	1800mm/1800mm
Window-to-wall ratio	3%	10%	10%	10%	10%	100%

※Condition4: Remove the effect of green

Figure 2: The window conditions.

After 10 minutes of dark adaptation with sunglasses, the observer observed the inside of the model through a peephole for 30 seconds in a black cloth to cut unnecessary daylight, selected up to 5 areas perceived as colour-tinted and circled these areas on a perspective drawing on a sheet, and then observers recorded their perceived colour of the selected area using a tablet device by the method explained in the previous study (Tsuda et al. 2021). This evaluation was carried out for each window condition. Luminance and chromaticity distributions were measured every time the observers evaluated the colour appearance of the model using the CCD camera system. (camera: Baumer TXG 13c, fisheye lens: FUJIFILM FE185C046HA-1 and program: C-Cube) The presentation order of the experimental conditions was randomized on each experimental day.

## RESULTS AND DISCUSSIONS

Colour in architecture can be generally measured or judged in three different ways. The first method is the measurement method of psychophysical colour, whose tristimulus values can be measured in a contact state using a reflectance spectrophotometer or colourimeter (hereafter referred to as 'Psychophysical colour' in this paper). The second method is the measurement way of the colour under actual lighting in architecture, where non-contact surface colour measurements are made using chroma meters like KONICA MINOLTA CS-100 (hereafter referred to as 'Colour under actual lighting'). The third method is the judgement of perceived colour in actual architecture, which is affected by the human perception system, such as light adaptation and colour contrast (hereafter referred to as 'Perceived colour', Tsuda et al. 2021).

Figure 3 shows the  $u'$  and  $v'$  (on the CIE 1976  $u'v'$ ) of the perceived colour of the areas judged by the observers as colour-tinted in all the window conditions. The range of  $u'$  for the light measured in front of the observer's eyes was 0.1901-0.2041, while the range of  $u'$  for the area selected as colour-tinted was 0.1876-0.2046, indicating that the observer perceived colour-tinted white surfaces as slightly greenish or bluish.

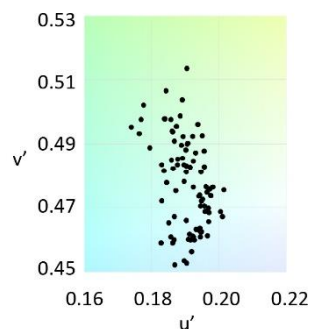

Figure 3: The  $u'$  and  $v'$  of the perceived colour of the areas judged by the all observers as colour-tinted.

Figure 4 shows examples of the colour-tinted areas judged by the observers. These areas were mainly classified into two types: the area which is illuminated by the reflected light from the lawn (Figure 4 (a)), and the boundary area on which luminance changed significantly (Figure 4 (b)). In this paper, we focused on the latter and investigated its mechanism of colour tint from the viewpoint of Mach band effect and Bezold-Brücke phenomenon.

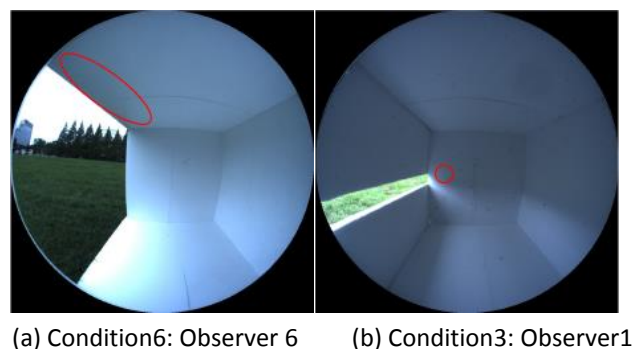

Figure 4: Examples of fisheye images and the colour-tinted areas circled by the observers (a)(b)

In the three conditions: Condition 2, Condition 3, and Condition 5, many observers selected the area near the window opposite the wall with the peephole as the most colour-tinted area. Based on



this result, we firstly hypothesized that the observers' selection of the boundary between high and low luminance was due to the Mach band effect, which made it appear emphasized. The classic Mach bands effect (named after physicist Ernest Mach) is a visual illusion noted by illusory bright and dark bands seen where a luminance plateau meets a ramp (Tsofe et al. 2009).

The luminance values on two orthogonal lines through the center of the selected area were extracted from the luminance distribution data, and the inflection points of the luminance gradient were found out by the second order derivative. As a result, all the selected areas as colour-tinted in Condition 2, 3 and 5 contained inflection points of luminance gradients, meaning these areas had the points where the luminance changed rapidly. It was also confirmed that these areas were perceived by the observers as greenish or bluish, judging from their  $u'$   $v'$  values. However, according to the study (Tsofe et al. 2009), the Mach band effect in chromatic colours makes the perceived colour transform in the direction of the complementary colour of the presented light stimuli, and it indicates that the colour-tinted areas in our experiment would have been perceived reddish if the Mach band effect actually worked, because the psychophysical colour of the light stimuli on the wall was slightly greenish. Therefore, we could not ascribe the colour appearance phenomena in our experiment to the Mach band effect.

The next hypothesis is that eyes adapted to the same light stimuli in wide and dark areas with low-luminance in the space, and in the areas with high luminance, colour perception became difficult due to colour saturation, and then as a result, the boundary areas between dark and bright appeared greenish (Figure 5).

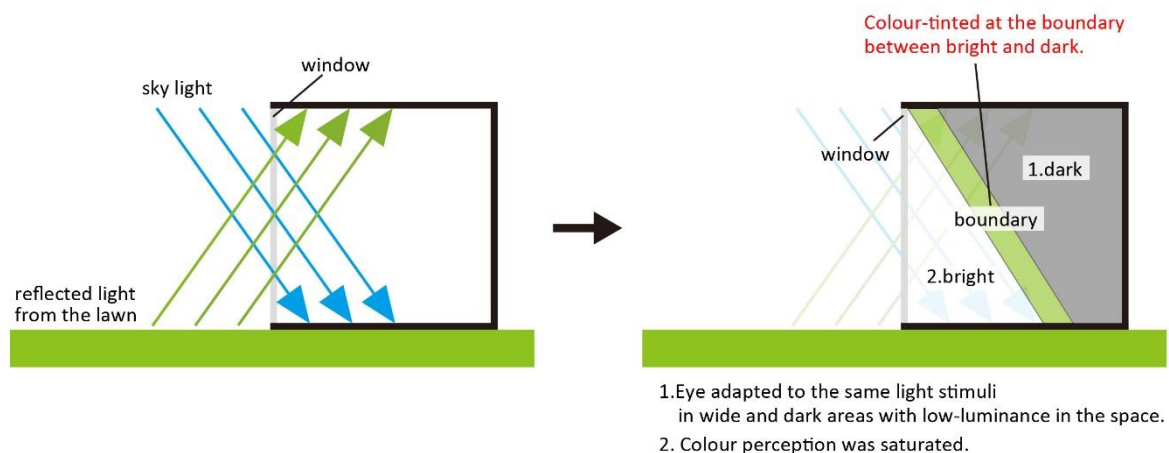
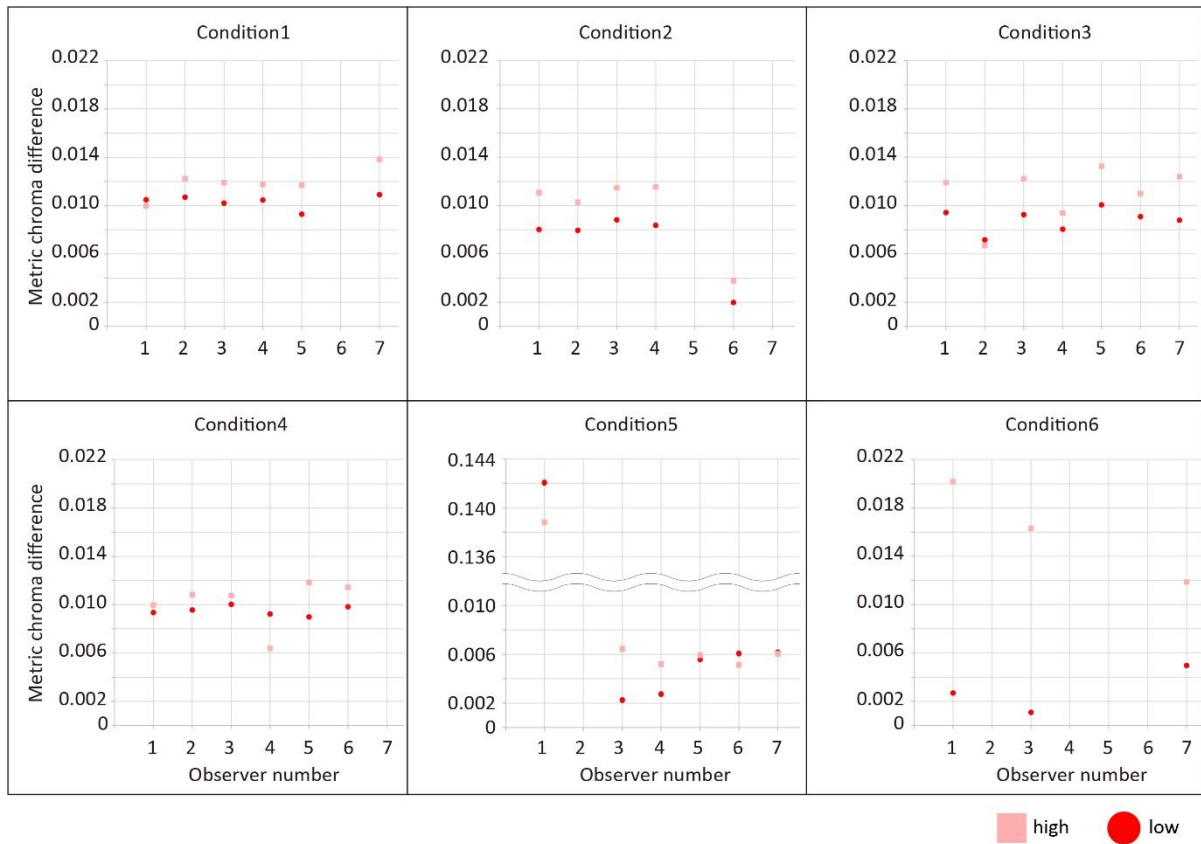

Figure 5: The next hypothesis of the cause of the colour appearance in the boundary areas.

Firstly, based on the luminance distribution inside the model measured from the observer's eye level using a CCD camera system, the interior space of the model was classified into three groups: the high luminance area (high), the low luminance area (low), and the area in the middle of these two areas (middle). The middle area covered the surfaces where the observers judged them as colour-tinted. Firstly, the chromaticity of the light reaching the eyes was compared with the chromaticity of the high and low areas. The results are shown in Fig 6, where the horizontal axis is the observer number and the vertical axis is the metric chroma difference ( $\Delta C^*_{uv}$ ) between the high/low areas and the adapted light in the eyes calculated from the  $u'$  and  $v'$  values. The  $\Delta C^*_{uv}$  of the low area was smaller than the high area in almost all conditions. In addition, even if the colour of the high area was closer to the colour of adapted light than the low area, the  $\Delta C^*_{uv}$  of them are often very close. This suggests

that the shaded areas with low-luminance covered a wide range of the space and it did not appear colour-tinted because the observers adapted to the same light stimuli of these low luminance area.



The data for observers who did not select the boundary(middle) is not plotted on the graph.

Figure 6: Metric chroma differences ( $\Delta C^*uv$ ) between the high/low areas and the adapted light in the eyes.

Secondly, we examined the possibility that the green tinted colour was difficult to perceive in the areas with high luminance due to the Bezold-Brücke phenomenon. In a 1986 paper by Vos, the invariant hue loci and the unique hue loci did not match, and the Bezold-Brücke phenomenon was explained by saturation of sensitivity at the time of signal output of the receptor, not by an opponent colour process. (Vos 1986) The cause of phenomenon has not been clearly established and remains unresolved, however, from the graphs in the paper by Vos, the perceived hue is assumed to converge to white as luminance increases. (Vos 1986) In our model experiment, it could be argued from the viewpoint of Vos's paper that the colour of the high luminance area was perceived to be whitish because of the colour saturation.

**CONCLUSIONS**

In this research the model experiment was conducted to understand the degree to which the colour appearance in space changes depending on the surrounding green daylight, and also to grasp the location where tinted colour appears depending on the window types. One hypothesis is that only the boundary areas between dark and bright appeared greenish, because the dark and wide areas with low luminance in the space does not appear colour-tinted owing to the eye adaptation, whereas colour of the high luminance area was perceived to be whitish due to Bezold-Brücke phenomenon. In future works, we would like to conduct more experiments with various conditions to elucidate the colour-

tinted mechanism in architecture, and verify the hypothesis concerning Bezold-Brücke phenomenon and colour adaptation.

### **REFERENCE**

- Kitamura, K., H. Tsuda, A. Takei and N. Yoshizawa. 2020. Variation and classification of white in architecture based on field survey. In: *AIC 2020, Proceedings of the International Colour Association Conference*: 512-517
- Tsuda, H., K. Kitamura, Y. Oe, A. Takei and N. Yoshizawa. 2021. An evaluative study on perceived colour measurement method in architecture using tablet devices. *Journal of the International Colour Association*: 26, 49-58
- Tsofe, A., H. Spitzer and S. Einav. 2009. Does the chromatic Mach bands effect exist? *Journal of Vision* 9(6):20,1-29
- Vos, J. 1986. Are unique and invariant hues coupled? *Vision Res.* Vol 26 No2: 337-342.

# Development of color and gloss measurement system with wide-range temperature and humidity control unit

Shimpei Fukagawa <sup>1,\*</sup>, Hiroyuki Iyota <sup>1</sup>, Hideki Sakai <sup>2</sup> and Mai Isomi <sup>2</sup>

<sup>1</sup> Graduate School of Mechanical Engineering, Osaka City University, Japan; fsgreen060720@outlook.jp, iyota@eng.osaka-cu.ac.jp

<sup>2</sup> Graduate School of Human Life Science, Osaka City University, Japan; hsakai@life.osaka-cu.ac.jp, mai03isomi@gmail.com

\* Corresponding author: iyota@eng.osaka-cu.ac.jp

## Abstract

We have developed equipment for measuring the color and glossiness of objects in a wide range of temperature and humidity conditions. This equipment can control temperatures up to 100 °C and 5%-100% humidity ranges and measure the color and glossiness of objects using a well-calibrated digital camera. We verified the measurement accuracy and found that the color difference is quite small and that we can obtain accurate glossiness data in the of dark color range. We demonstrated the results of the measurement of silica gel (whose color changes with humidity) and black beans (Japanese traditional food, whose glossiness changed with temperature). We obtained important experimental data on the relationship among temperature/humidity, weight of the materials, and color/glossiness.

**Keywords:** *non-contact colorimetry, rough surface, diffuse illumination, digital camera*

## INTRODUCTION

The appearance of objects and materials is significantly affected by their color and glossiness (Arce-Lopera et al. 2012; Okuda et al. 2015). Therefore, a quantitative evaluation of these indexes is required when we consider the quality management of objects, materials, energy conservation, and food loss reduction. However, the conventional method of measurement requires contact with the target objects or materials. For this reason, it is impossible to use a general contact-type colorimeter when measuring that have complicated shapes and moisture/oil on their surfaces. To address this problem, non-contact two-dimensional (2D) color-measuring equipment using dome-shaped illumination and a digital camera have been developed. In addition, we installed a light absorber (we call it a “light trap”) inside the dome. By moving the light trap, we can obtain 2D images of the specular component included (SCI) and specular component excluded (SCE). We can obtain color information from SCE images and glossiness information from the difference in  $L^*$  values between SCI and SCE (Sakai et al. 2013; Sakai et al. 2018).

In this study, to investigate how temperature and humidity around the objects and materials affect their color and glossiness, we have developed new equipment that can control the temperature and humidity in a closed unit (“test section”). To measure the color and gloss of objects in the test section, it is necessary that the unit is made from a transparent window glass. However, because of its high glossiness, the transparent glass reflects parts of the illuminating light by specular reflection, which disturbs the reflected light from the sample objects. To measure the color and glossiness of the sample objects, it is necessary to receive only the reflected light from the objects. The angle of specular reflection is equal to the incident angle of illumination; therefore, under incident-receiving conditions with 45°/normal, this equipment does not receive the specular reflected light from the surface of the glasses. In contrast, under incident-receiving conditions with diffuse/normal, part of the specular reflected light on the window glass is received in the normal direction, which disturbs the measurement of the reflected light from the surface of the objects. Therefore, the 45°/normal condition is suitable for measurement in the closed space. However, if the surface of the object has

some roughness, only one condition of incidence (i.e., 45°) tends to make the shadow of the rough surface, and precise color measurement is not possible. In this study, to address this problem, we propose to use a concave glass window to seal the space such that the diffuse illumination is not reflected in the specular manner in normal directions.

We verified the measurement accuracy and demonstrated the results of the measurement of silica gel (whose color changes with humidity) and black beans (whose glossiness changes with temperature).

### EQUIPMENT/METHOD

Figures 1(a), (b), and (c) show an overview of the remodeled equipment. In Figure 1(c), an LED was used as the light source (Ra 90, 29 W, 6200 K, illuminance 279.4 lx). The dome was made of stainless steel, and its interior was painted white. The light from the LED was reflected several times on the inner wall of the dome and irradiated on the surface of the sample from all directions. Hence, the occurrence of shadows due to the shapes of the samples was suppressed. As explained in the introduction, part of the inner wall of the dome is covered with a light trap (made of black paper at about 30° per light trap) to make a part of the image specularly excluded, as shown in Figure 1(a). By rotating the light trap by 30° and capturing 12 images at each position using a digital camera (Canon EOS Kiss 7), all parts of the SCE image were obtained. This process is automated by installing a microcomputer (Arduino) using a stepping motor. Then, by using the image analysis software developed in Python, the lightest and lowest pixels were extracted and synthesized. Subsequently, the SCI and SCE images were obtained.

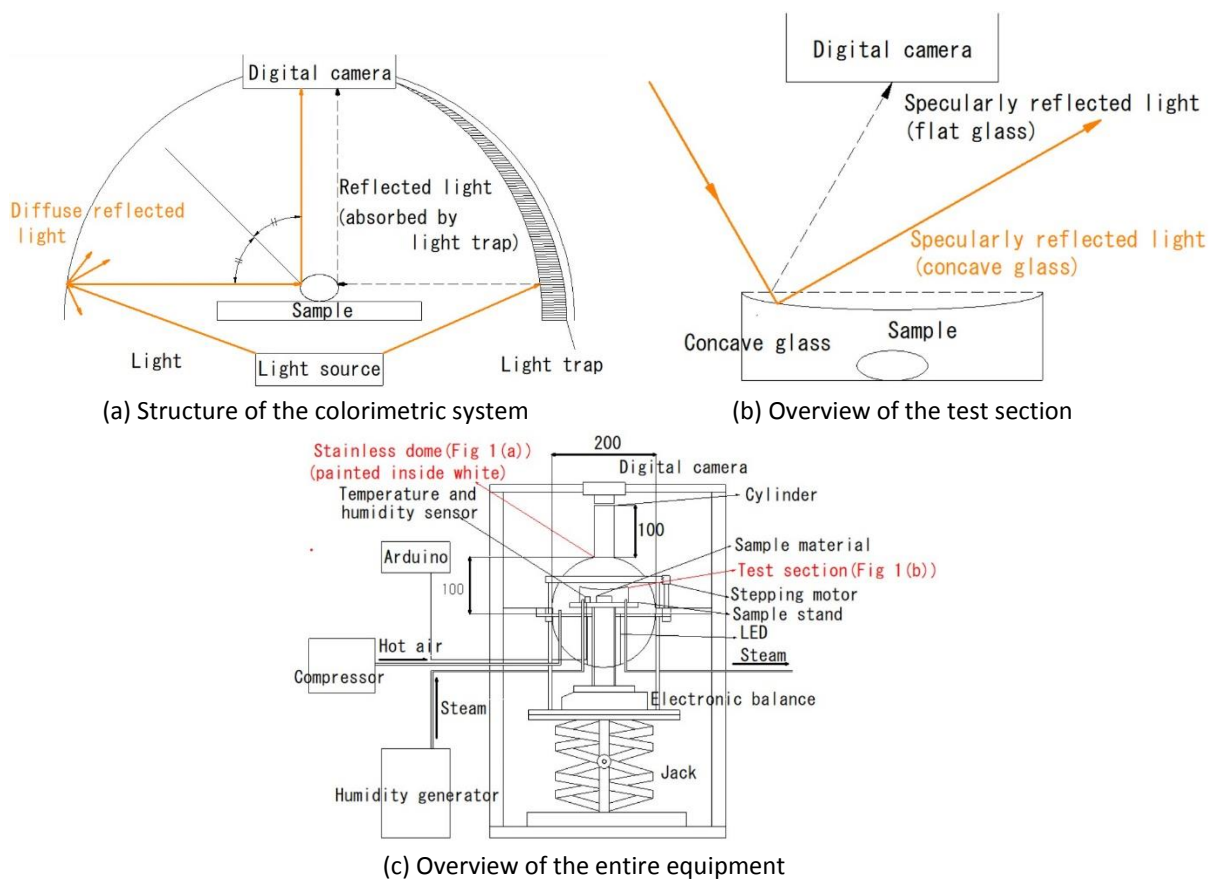

Figure 1: Overview of the equipment.

The temperature and humidity were controlled in the test section of the dome by sending water vapor into it. To avoid condensation in the test section, hot air was sent into the dome but outside of the test section. As shown in Figure 1(b), the test section consists of a concave glass window to seal the space such that there is no specular reflection of the diffuse light to the camera.

Additionally, an electronic balance was installed in the dome to measure changes in the weight of the sample during measurement, and a temperature and humidity sensor (SENSILION, SHT75) was installed to measure the temperature and humidity in the test section.

## RESULTS

### Verifying accuracy of color and glossiness measurement

We have conducted verification of measurement accuracy of the equipment. Figures 2(a) and (b) show the photographs that were captured in the experiment, and Table 1 shows the results of the color measurement accuracy. We calculated the color difference  $\Delta E_{ab}^*$  of two color charts (24 colors made by X-rite for calibration and sample) and found it to be small enough. Table 2 shows the accuracy of the glossiness measurements. We made glossiness samples; one was covered with four colored paper and the other was covered with glass. We derived an equation for measuring glossiness (1) where  $\alpha$  is calculated by Eq.(2). Then, we compared the results of contact-type measurements with those of the non-contact type. It was found that the glossiness of objects with dark colors could be measured with good accuracy.

$$G_s(20^\circ) = \alpha(L_{SCI}^* - L_{SCE}^*)^2 \quad (1)$$

$$\alpha = \exp(0.0143 \times L_{SCE}^* - 0.6895) \quad (2)$$

	$ \Delta L^* $	$ \Delta a^* $	$ \Delta b^* $	$\Delta E_{ab}^*$
average	0.78	0.86	0.8	1.64
max	2.42	2.57	2.1	3.54
min	0.07	0.1	0.03	0.32

Table 1: Accuracy in color measurement.

Sample	$L_{SCI}^* - L_{SCE}^*$	Glossiness $G_s(20^\circ)$		
		Contact	Non-contact	Difference
Black gloss	18.2	167	168	-1
Black matt	3.1	0.1	4.6	-5
Dark gray gloss	13.2	168	167	1
Dark gray matt	3.1	0.3	9.9	-10
Light gray gloss	9.3	168	166	2
Light gray matt	3.3	0.7	22.6	-22
White gloss	4.8	167	96	71
White matt	1.3	1.5	7.8	-6

Table 2: Accuracy in glossiness measurement.



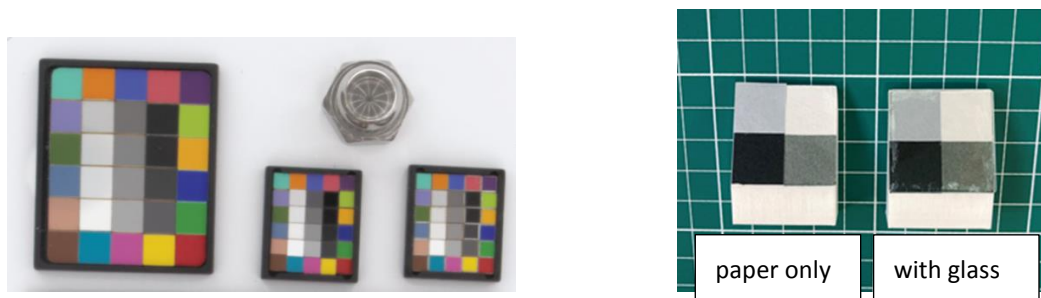

(a) Photograph of the color charts

(b) Photograph of the glossiness samples

Figure 2: Photograph of the samples.

### Specific samples in a particular temperature and humidity environment

To test objects that would be affected by temperature and humidity, we measured samples of silica gel and sweet black bean (Japanese traditional food) for their color and glossiness.

#### Color change of silica gel

It is known that cobalt chloride in silica gel absorbs moisture in the air, and its color changes to red. In addition, if it is dried, its color changes to blue. In this experiment, we controlled the temperature and humidity so that the color of the silica gel (originally red) changed to blue and returned to red. We took data 55 times every 3 min (total of 160 min).

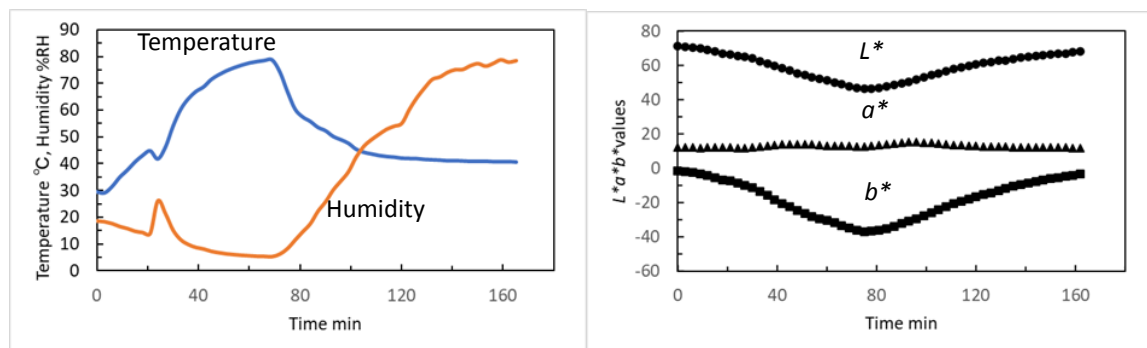

(a) Relationship between temperature/humidity and time

(b) Relationship between  $L^*a^*b^*$  values and time

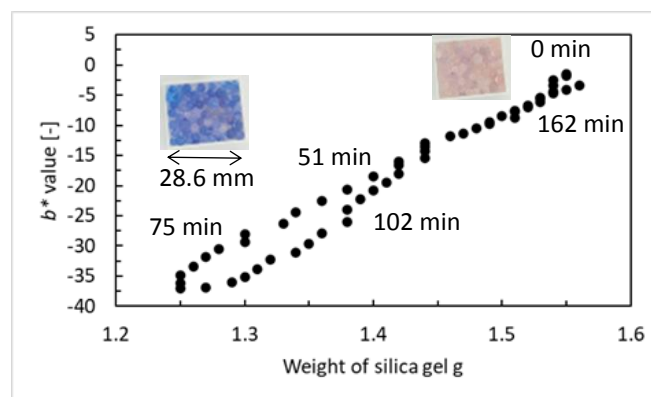

(c) Relationship between  $b^*$  values and weight

Figure 3: Silica gel experiment.

Figure 3 shows the data for this experiment. Figure 3(a) indicates that we could intentionally control the temperature and humidity. In Figure 3(b), we obtained quantitative data on the relationship between  $L^*a^*b^*$  values and time and found that the color change in silicagel is mainly caused by the change in  $b^*$  values. Figure 4(c) shows the relationship between the  $b^*$  values and the weight change. Along with the change in weight by 19.4%,  $b^*$  values changed linearly by approximately 35.4.

*Drying experiment of black beans*

We conducted a drying experiment on black beans at approximately 100 °C/5% temperature and humidity conditions. We observed three black beans and collected data 34 times every 10 min (total of 330 min).

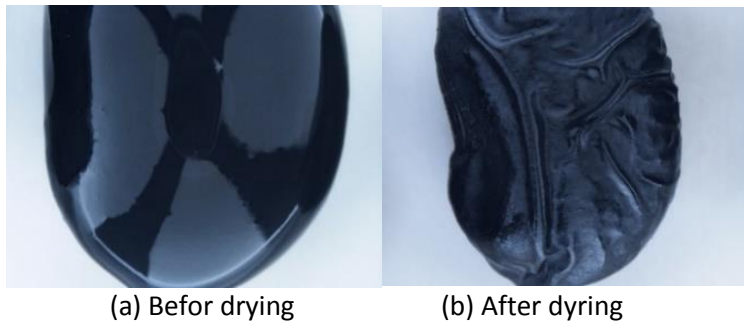

Figure 4: Photographs of black bean by microscope.

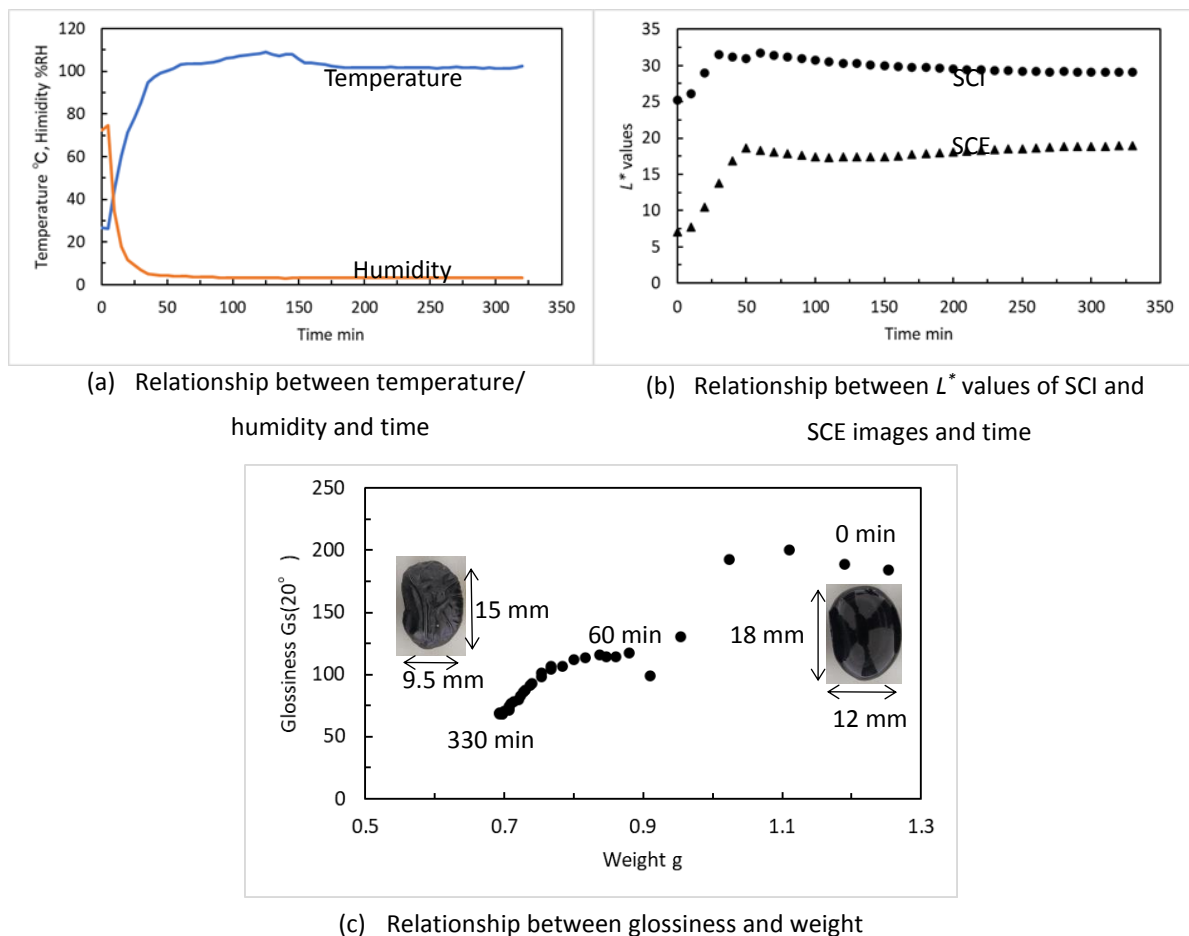

Figure 5: Experiment of black beans.

Figure 4 shows a photograph of a black bean taken using stereoscopic microscope to observe the surface of the black bean. We could see tiny wrinkles on the surface. Figure 5 shows the average data for the three samples. Figure 5(a) shows that the drying process was performed as planned. Because the  $a^*$  and  $b^*$  values are almost 0, we compared the  $L^*$  values of the SCI image with those of the SCE image, as shown in Figure 5(b). The difference in  $L^*$  values decreased as they dried. This indicates that the drier that the black beans become, the lower the glossiness. Figure 5(c) shows the relationship between glossiness and weight, and it was found that the glossiness of black beans decreased by 44.7% with a 44.0% reduction in weight. It seemed that the sauce on the surface of black bean evaporated in the first 60 min, and then some wrinkles appeared on the surface as they dried.

## **CONCLUSIONS**

We have developed equipment for measuring the color and glossiness of objects in a wide range of temperature and humidity environments and we obtained SCI and SCE images. We verified the accuracy of color and glossiness measurements. Measurements of specific samples, which are greatly affected by temperature and humidity, were also demonstrated, and it was proved that this equipment is useful for examining how temperature and humidity affect the color and glossiness of the sample.

## **REFERENCES**

- Arce-Lopera, C., T. Masuda, A. Kimura, Y. Wada, and K. Okajima. 2012. Luminance distribution modifies the perceived freshness of strawberries. *i-PERCEPTION* 3: 338-355
- Okuda, S., K. Okajima, and C. Arce-Loppera. 2015. Visual Palatability of Food Dishes in Color Appearance, Glossiness and Convexo-concave Perception Depending on Light Source. *Journal of Light & Visual Environment* 39: 8-14
- Sakai, H., S. Yoshikawa, and H. Iyota. 2013. Accuracy of color measurement by using digital cameras and the standard color chart. *Proceedings of the 1st Asia Color Association Conference*: 248-251.
- Sakai, H., M. Isomi, and H. Iyota. 2018. Non-contact colorimetric measurement using dome illumination for complex shape objects. *Proceedings of the 4th Asia Color Association Conference*: 183-186.

# Identify the characteristics of optically variable inks with deep learning

Pei-Li Sun<sup>1</sup> and Raymond Chiang<sup>2,\*</sup>

<sup>1</sup> National Taiwan University of Science and Technology, Taiwan (R.O.C.); plsun@mail.ntust.edu.tw

<sup>2</sup> Central Engraving and Printing Plant, Taiwan (R.O.C.); colorful\_ray@hotmail.com

\* Corresponding author: colorful\_ray@hotmail.com

## Abstract

The optically variable ink (OVI) displays different colors according to different viewing angles. It is often used as an essential item for anti-counterfeiting of security documents. Forensic authentication of OVI is very important. In this study, 5 pairs of color samples were made by painting either authentic or fraud inks using an ink squeegee. A multi-angle spectrophotometer, a flatbed scanner, a camera with multi-angle lighting and a microscopic magnifier are used for recognizing authentic OVI. The results show that the OVI images obtained by the flatbed scanner have a 99.96% successful recognition rate through a Convolutional Neural Network.

**Keywords:** *Optically Variable Ink, convolutional neural network, anti-counterfeiting, forensic*

## INTRODUCTION

According to a survey (Hallman 2018) of 10 popular banknotes from around the world, the most commonly used security features of newly issued banknotes since 2011 can be summarized as plastic materials, holograms, watermarks, micro text, optically variable inks, security threads, and invisible inks. 42% of banknotes use the color shift effect of optically variable ink (OVI), which belongs to the first stage of anti-counterfeiting function and can be printed regardless of plastic or paper substrate. Optically Variable Ink (OVI) displays two distinct colors depending on the viewing angle. For example, one color appears when viewed vertically, and the other color appears when turned to another angle. Due to this reason, OVI is often used as anti-counterfeiting ink (Phillips 1990) when printing banknotes or security documents (Van Renesse 1998). In order to verify the authenticity of the optically variable ink on the banknotes, 5 pairs of color samples were made by painting either authentic or fraud inks using an ink squeegee. The color changes of the two sets of OVI samples with the naked eyes are very similar. How to use more reliable method to determine whether the ink is authentic or forged is a major problem at present.

## PRINCIPLE OF OVI INK

OVI utilizes the optical interference effect, and the pigment of the ink is made of interference thin film. The optically various layers are deposited successively on top of each other by physical vapor deposition processes to form a continuous sheet of a multilayer thin-film stack onto a flexible carrier. The carrier is preferably a web of a PET or similar polymer foil. Then, grinding of the multilayer thin-film sheet to pigment particles of the desired size results in substantially flat pigments, i.e. flakes (as shown in figure 1 and 2), with irregularly broken edges. At these edges, perpendicular to the plane of the layers which form the stack, the opaque totally reflecting central layer is no longer protected by the superposed dielectric layer. Moreover, the mechanical stress exerted onto the pigment during the grinding process can result in hairline cracks in the dielectric layers. As a result, corrosion of the inner layers of the multilayer stack may take place at multiple sites upon contact with suitable chemical reagents. Such reagents are omnipresent, as e.g. in printing ink formulations (resins, solvents, etc.). When light is incident on the upper surface of the transparent film, part of the light is reflected, and

Identify the characteristics of optically variable inks with deep learning

part of the light is refracted into the film. The light entering the film is reflected and refracted on the lower surface. These reflected light and transmitted light all come from the same incident light, forming an interference phenomenon. The first color is seen when observing perpendicular to the surface. At this time, as  $\sin(90^\circ)$  equals 1 unit of optical path difference, which creates constructive interference. When the surface is rotated by  $60^\circ$  until the line of sight is  $30^\circ$  with the banknote surface,  $\sin(30^\circ)$  equals 1/2 in the optical path difference formula, the first color will cause destructive interference and disappear, thus forming the second color. Thus, OVI can also be called optical interference ink.

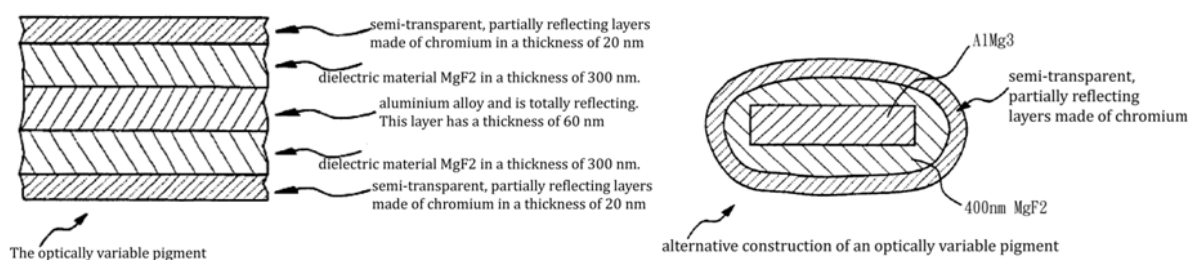

Figure 1: Left: A cross-sectional view of the corrosion-resistant optically variable pigment. Right: Alternative construction of an optically variable pigment (US patent 6521036 B1).

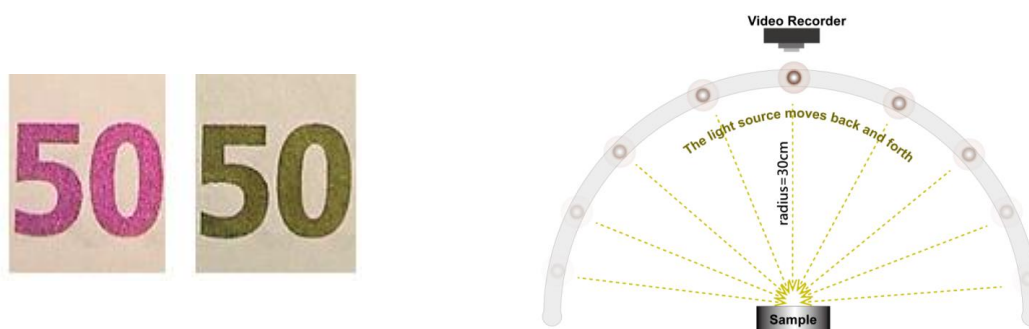

Figure 2: €50 euro banknote details, seen from different angles. "50" was printed with OVI ([https://en.wikipedia.org/wiki/Optically\\_variable\\_ink](https://en.wikipedia.org/wiki/Optically_variable_ink)).

Figure 3: Moving light source and the lighting geometry.

## METHODS

In order to compare whether the color changes are consistent in different angle positions, a continuous angle along a semicircular orbit with a handheld moving light source (Figure 3) was used to illuminate the OVI samples, and then the images were taken by a color calibrated digital camera (Canon EOS-60D) for comparison and analysis. During photography, samples of the two inks were placed side by side on the sample stage for relative comparison analysis.

In this study, authentic OVI (denoted as A) and fake OVI (denoted as F) were taken out by an ink pipette, and then squeezed the A and F inks side by side to a white card using an ink squeegee (Figure 4 left). When the color card is rotated at the same time and observed by human eyes, the color of A and F are very close in different rotation angles, and it is difficult to distinguish visually. Because the

Identify the characteristics of optically variable inks with deep learning

production of OVI pigment involves many professions such as optics, high-tech vacuum evaporation technology, cracking and solvent suspension pigment formulation, the surface characteristics of the ink, sizes and arrangements of the pigment particles produced by different OVI brands would be slightly different. The texture and color changes when viewed from different angles are also different, although it is difficult for the human eye to detect them. As Convolutional Neural Network (CNN) performs well in pattern recognition, we use it to extract ink characteristics (Bianco et al. 2017) on paper to determine the authenticity. In this study, four methods were used for comparison:

- A. Use a BYK-mac multi-angle spectrophotometer, and draw the color locus in CIELAB color space.
- B. Contact: Use a Microtek ArtixScan DI2020 Plus flatbed scanner ( $45^{\circ}/0^{\circ}$  measuring geometry), the scanned image was first segmented into  $32 \times 32$  pixel blocks with a total of 28,800 samples (blocks), and then analyzed their colors via a CNN model.
- C. Normal view: Use the camera with the movable light source to record a video with fixed exposure in 15 seconds, and then extract 57,908 color blocks, each of which has a size of  $32 \times 32$  pixels, and then use the CNN model to analyze the authenticity of color blocks.
- D. Micro view: Use a Leica M205C microscope plus an adjustable ring LED light source with a DFC450 image recorder to capture light and shadow changes at 50x, 200x, 400x and 800x magnifications (Figure 4 right). The images were analyzed by the CNN model.

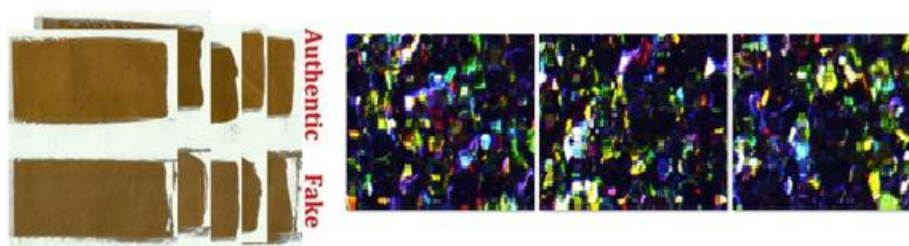

Figure 4: Left: 5 OVI samples made by squeezing authentic and fake OVI inks side by side onto 5 white cards. Right: OVI ink magnifies 800 times and switches LED light sources in different lighting angles ( $0^{\circ}$ ,  $120^{\circ}$  and  $240^{\circ}$ ) to show color differences.

## RESULTS

### Multi-angle instrument (BYK) numerical comparison

The five OVI samples measured by the multi-angle spectrophotometer are plotted in CIELAB color space. The shape of the color trajectory changes from yellow-red to yellow-green (as shown in Figure 5), and the hue-differences between authentic and fake inks are very close from  $15^{\circ}$  to  $110^{\circ}$  measuring angle. Only  $-15^{\circ}$  shows moderate different. However, OVI ink keeps changing its color at different viewing angles, so it is difficult for human eyes to distinguish the differences.



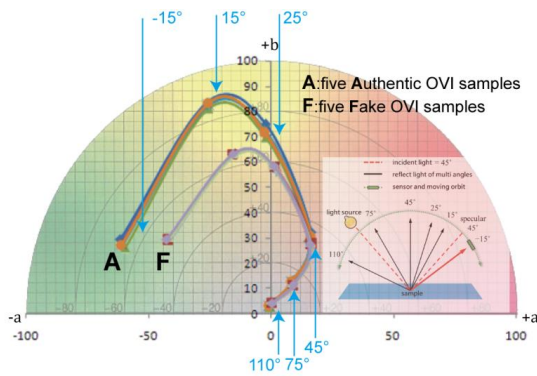

Figure 5: Using multi-angle spectrophotometer to measure the color trajectory of OVI inks. The angle indication refers to the sensor angle of the multi-angle spectrophotometer.

### Comparison of contact, normal and micro views

#### A. Flatbed scanner (contact measurement)

Convert the RGB images scanned at the same time to CIELAB values, and cross-check one of the 32x32 pixels of the authenticity and fake ink images. Regardless of whether it is compared with itself or authentic and fake inks, the average color difference is greater than  $3 \Delta E^*ab$ , and the standard deviation is also greater than 1, indicating that the dispersion of the color difference is not concentrated within 68% (1 standard deviation). It can be seen that in this case, judging OVI ink by color is unreliable. Therefore, other methods need to be used to identify the authenticity of the ink.

#### B. CNN(Convolutional Neural Network)

The image obtained from the flatbed scanner divided into 28,800 color blocks. 80% of which was used for training, and the remaining 20% was used for validation. The construction of the model is divided into two convolution layers and one full-connected (flatten) layer, as shown in Figure 6:

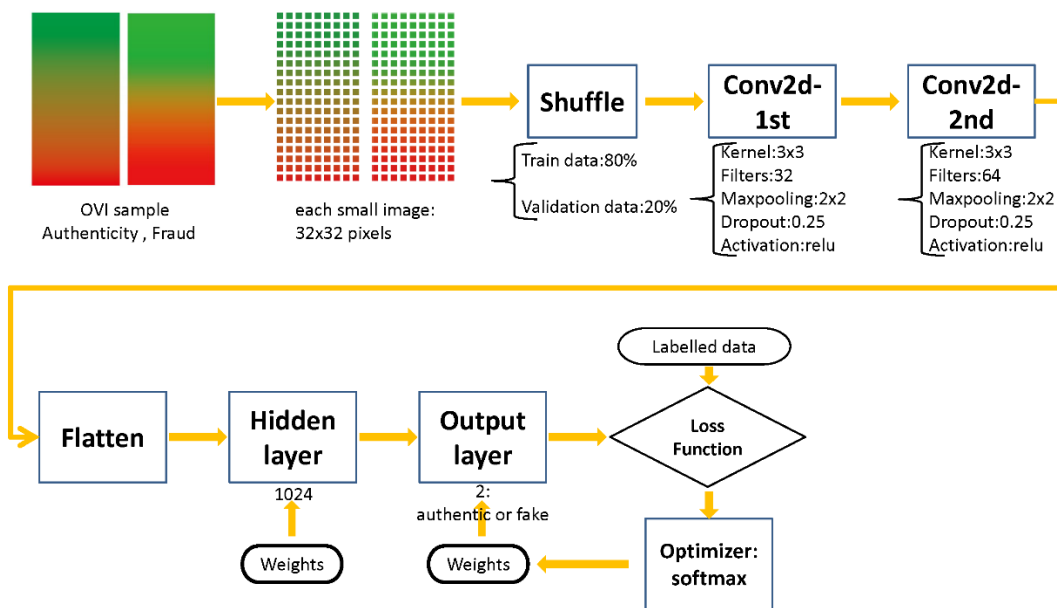

Figure 6: The workflow and parameters of the CNN model.

A comparison with other methods are shown in Table 1 and Figure 7. The accuracy and loss history curves of training and validation of the method B (contact measurement of a flatbed scanner) in Figure 7 are very close, indicating that there is no overfitting. Only one block was predicted incorrectly, and all other samples were correct. The accuracy rate is 99.96%.

Viewing Method	Contact (Scanner)	Normal (Camera)	Micro 50x	Micro 200x	Micro 400x	Micro 800x
Accuracy %	99.96	98.93	98.96	98.98	97.71	93.35

Table 1: Accuracy of model prediction in different viewing methods.

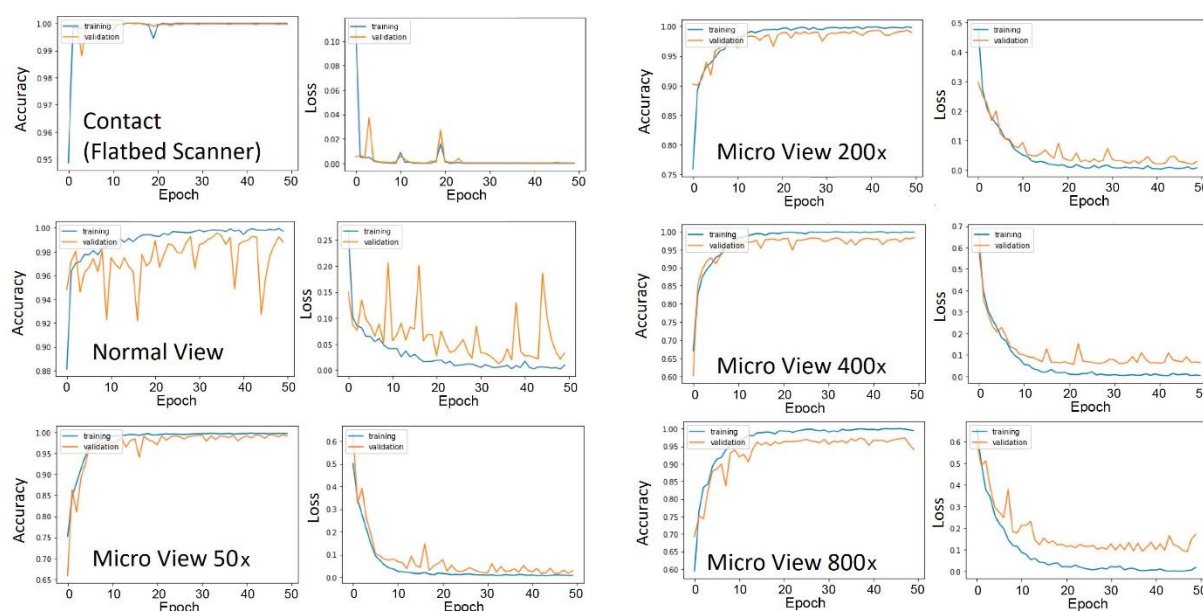

Figure 7: CNN training histories: The accuracy and loss with different viewing methods. The orange and blue lines represent the training and validation histories of the CNN model, respectively.

## CONCLUSIONS

The present study compares four methods for identifying the authenticity of OVI inks. The measurement results of the multi-angle spectrophotometer show that only one of six sensor angles can distinguish hue difference between authentic and fake OVI inks. In the other hand, a microscope can be used to magnify the micro-structured taggants in the ink to identify the authenticity, but no matter whether the OVI ink containing the micro-structured particles, the human eye cannot see the microstructure. However, no matter whether the OVI ink is added with the taggants, contact scanning or low-magnification methods can obtain a very high authenticity recognition rate through artificial intelligence feature extraction.

## ACKNOWLEDGEMENTS

Thanks to Central Bank (R.O.C. Taiwan) and Central Engraving and Printing Plant for supporting this research.

## **REFERENCES**

- Hallman, C. 2018. *Banknote Security Around the World---Counterfeit Money Prevention and Detection Tips*, <https://www.titlemax.com/discovery-center/money-finance/banknote-security-around-the-world>
- Phillips, R. W. 1990. Optically Variable Films, Pigments, and Ink, Proceedings of Optical Thin Films III: New Developments, *SPIE*, Vol. 1323.
- Van Renesse, R. L. 1998. *Optical Document Security*, Second Edition, Boston: Artech House.
- Bianco, S., C. Cusano, P. Napoletano and R. Schettini. 2017. Improving CNN-Based Texture Classification by Color Balancing, *J. Imaging, IEEE computer society* ,3: 33.

# Estimation of authenticity model considering the colour: Leather as a case study

Shuhei Watanabe <sup>1, 2, \*</sup> and Takahiko Horiuchi <sup>2</sup>

<sup>1</sup> Digital Strategy Division, Ricoh Company Ltd., Japan; shuuhei.sw.watanabe@jp.ricoh.com

<sup>2</sup> Graduate School of Science and Engineering, Chiba University, Japan; horiuchi@faculty.chiba-u.jp

\* Corresponding author: shuuhei.sw.watanabe@jp.ricoh.com

## Abstract

Material appearance and perception have important aspects of product design. In this study, we focus on the authenticity perceived from leather. In various products, not only genuine leather but also artificial leather is used due to animal rights and environmental issues. The artificial leather is manufactured to resemble genuine leather, but it may give consumers a different perception. In previous studies, we investigated using black leather samples. The model was proposed based on a layered model that imitations the perception mechanism. However, it is clear that colour affects perception. Therefore, the purpose of this study is to derive the perception model considering colour. Using various colour samples, we conducted measurement and subjective experiments. As a result, the model considering the surface colour showed a high correlation with subjective scores. The model can contribute to understanding the human perception of leather and efficient appearance design of artificial leather.

**Keywords:** *Perception model, Gonio-spectrophotometer, Leather, Material appearance*

## INTRODUCTION

Information of the material appearance and perception has an important aspect to product design and manufacturing. However, the information is qualitative, ambiguous, and complex. Therefore, in recent years, methods for understanding and quantifying them have been studied.

In this study, we focus on the authenticity (not a genuine or artificial classification) we perceive from leather. In various products, not only genuine leather but also artificial leather is used due to animal rights and environmental issues. The surface of artificial leather is manufactured to resemble genuine leather, but it may give consumers a different perception than genuine leather. In our previous studies, we used black leather samples to construct a hierarchical authenticity perception model (Watanabe et al. 2020). The model was proposed based on a multi-layered model that imitations the human perception mechanism, and a high correlation with the subjective score was confirmed. However, the model still has some limitations. For example, our previous study used monochrome samples to avoid the effects of colour. On the other hand, as Giesel and Gegenfurtner (2010) and Granzier et al. (2014) reported, it is clear that colour affects perception. Therefore, the purpose of this study is to derive the perception model of authenticity considering the effects of colour.

To achieve this purpose, using various colour leather samples, we conducted measurement experiments to obtain the properties of leather and subjective experiments to obtain the subjective score of authenticity. Sixteen samples consisted of eight genuine and eight artificial leather were prepared for the experiments. Figure 1 shows the enlarged leather samples. The sample colours were yellow, green, brown, red, blue, gold, silver, and black, and each colour had one genuine and artificial leather. The sample size was 210 × 300mm (W × H). By deriving the model considering colour, we expect to provide a contribution to understand the perception of wide range of leather and improve the quality of artificial leather.

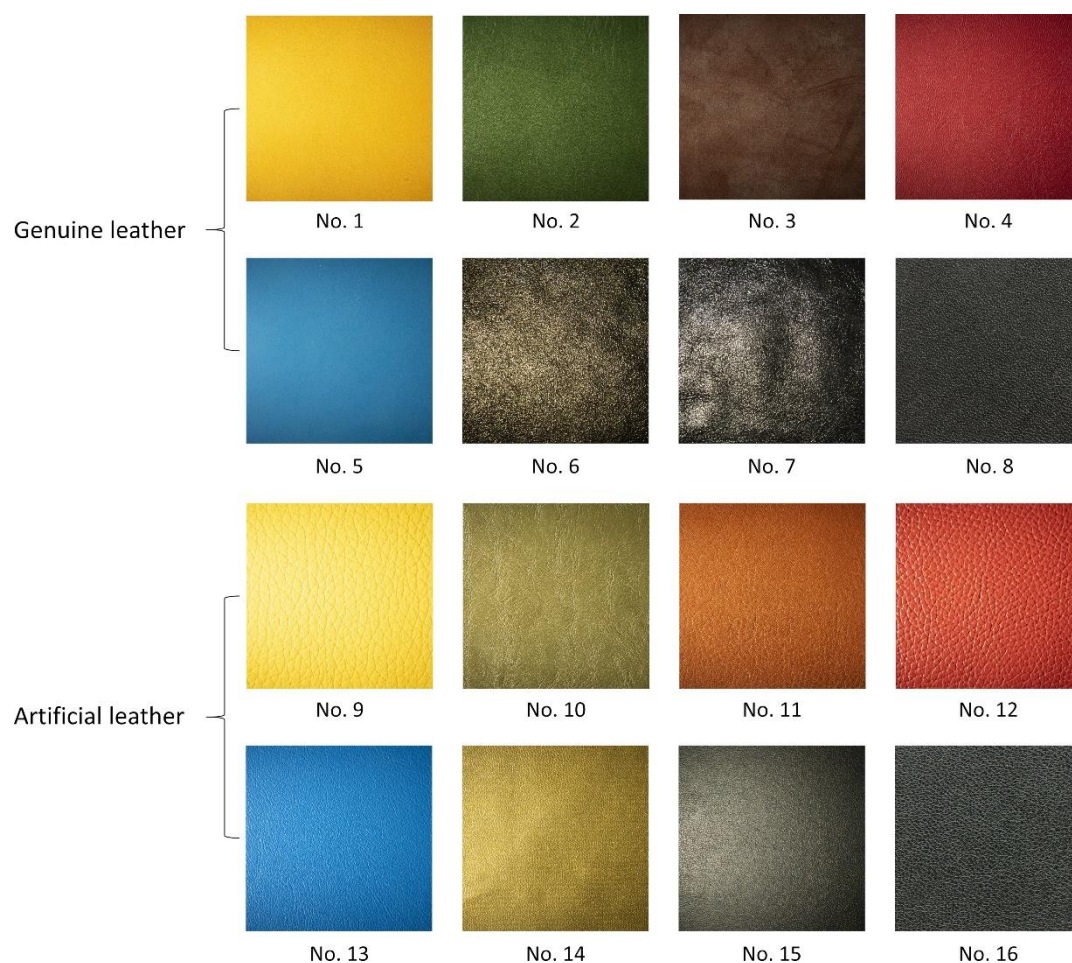

Figure 1: The enlarged surface of the colour leather samples.

### **DESCRIPTION OF EXPERIMENTS**

We first conducted measurement experiments. In addition to the same three measurements (colour measurement, surface texture experiment, and gradation measurement) performed our previous study, we performed a measurement using the gloss meter (Rhopoint IQ-S 20°/60°/85°, Rhopoint Instruments, East Sussex, UK) to obtain 20°, 60°, and 85° gloss values. Figure 2 shows the setup of the colour measurement. The measurement system was composed of a spectral camera, a lighting device, and a sample stage. The sample stage and the lighting device were each mounted on a rotating stage, which allowed images to be recorded under various angular conditions. In the colour measurement, we measured the colour samples under the five angle conditions shown in Figure 2 (b).

Next, we conducted subjective evaluation experiments. The experiments were conducted in two steps. In the first experiment, participants observed curved samples and evaluated the order of authenticity perceived from them. In the experiment, ten participants observed the sample illuminated by fluorescent light. The jig for bending the samples could compare up to eight samples side by side. In the next experiment, under the light booth (D65 light source), the participants confirmed the samples whether there was any change in the ranking evaluated in the previous experiment. We used the average rank obtained in the second step experiment as a result of the subjective evaluation experiment. However, the average ranks were ordinal scales, and the magnitudes of the ranks could be compared, but the differences between the ranks could not be compared. Therefore, the author normalised these results and converted them into a distance scale. Figure 3 shows the normalised

subjective authenticity score of the samples. We confirmed that green, brown, and black had high scores, and gold and silver had low scores. We considered that even genuine leather had a low score because gold and silver leather had few opportunities to observe daily.

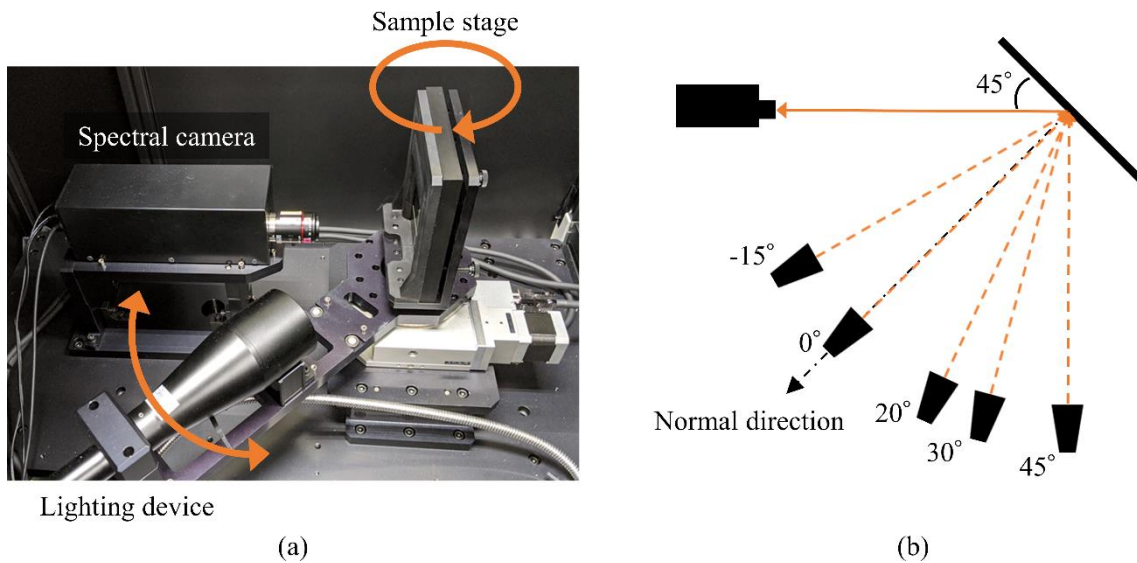

Figure 2: Colour measurement setup. (a) Arrangement of device. (b) Measurement angle conditions.

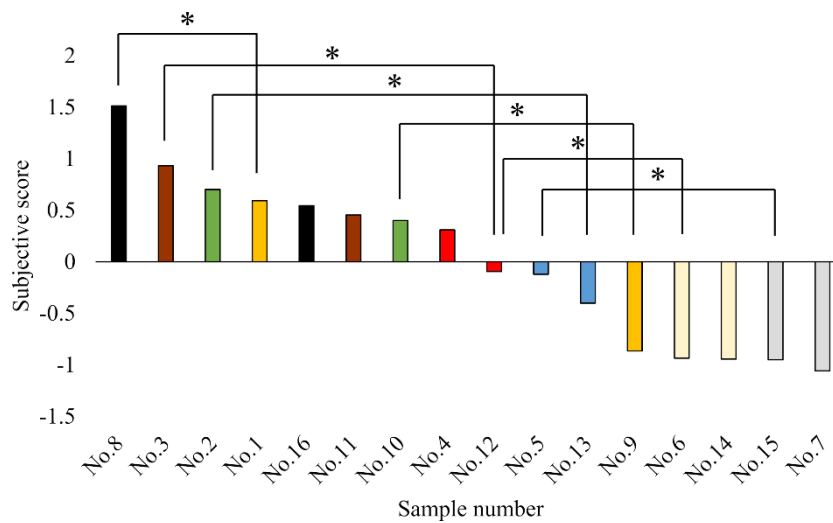

Figure 3: Subjective authenticity score. (a) Arrangement of device. (b) Measurement angle conditions. We can confirm that the sample pairs connected with black frames differ significantly ( $p < 0.05$ ), while we cannot confirm that the samples inside the frame differ significantly.

## RESULTS AND DISCUSSION

We examined the correction of the authenticity model. First, we confirmed the correlation between the estimated score of the model derived in the previous study and the subjective score. Figure 4 shows the result. We confirmed that there was a low negative correlation between them (R-squared value of 0.21). That is, the previous authenticity estimation model could not apply to the colour samples due to the previous model did not contain colour-related properties.



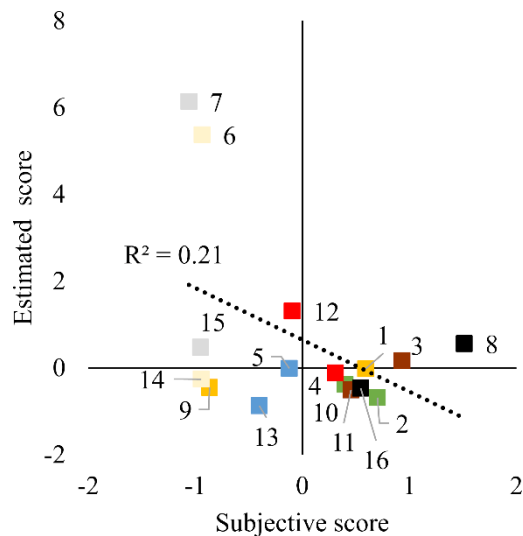

Figure 4: Correlation between the estimated authenticity values calculated in the previous study and subjective values.

In both results of Figures 3-4, the gold and silver samples showed characteristic results. Therefore, we corrected the model in the following two steps: 1) Correction of the result excluding gold and silver. 2) Correction by adding the samples to the result of 1). The correction for each step was showed as in Equations (1) and (2):

$$\text{Corrected authenticity (step 1)} = 0.25 \cdot \text{Authenticity} - 1.38 \cdot x_1 + 0.70 \cdot x_2, \quad (1)$$

$$\text{Corrected authenticity (step 2)} = 0.21 \cdot \text{Authenticity} - 0.10 \cdot x_1 - 0.91 \cdot x_2 + 0.42 \cdot x_3. \quad (2)$$

Here, *Authenticity* represents the estimated score calculated by the previous model, and  $x_1$ ,  $x_2$ ,  $x_3$  represent  $30^\circ/45^\circ$  C\*,  $30^\circ/45^\circ$  L\*, and  $85^\circ$  gloss value respectively. Figure 5 shows the correlations between the value estimated in Equations (1) and (2), and the subjective score for the authenticity. The R-squared values of 0.82 and 0.81 were obtained ( $p < 0.01$ ), and we could correct the authenticity model to adapt it to colour leather samples. Based on these results, we first confirmed that L\* and C\* under the highlight conditions were used for the correction. The difference between steps 1 and 2 was that the coefficient of C\* value in step 2 was smaller than in step 1. We thought that this is because the L\* value became more important due to the addition of gold and silver samples with large specular reflection values. Also, the sign of L\* was converted from plus to minus. We thought this was also due to the addition of gold and silver samples with large L\*.

## CONCLUSIONS

In this study, we corrected the model constructed in our previous study so that it could be applied to colour samples. The experiments with various colour samples showed that correction was basically possible with L\* and C\*. Furthermore, the gloss value had to be added when correcting the result,

Estimation of authenticity model considering the colour: Leather as a case study including gold and silver samples. In this examination, we made the linear correction, but it is necessary to continue more investigation.

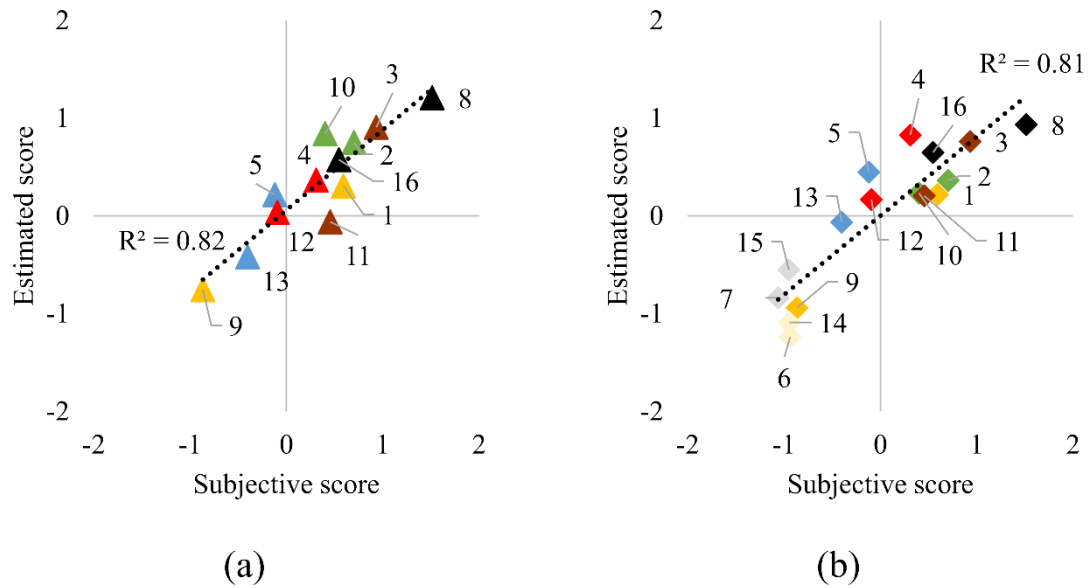

Figure 5: Correlation between the estimated values calculated by Equation (1-2) and subjective values. (a) The results regarding Equation (1). (b) The results regarding Equation (2).

## REFERENCES

- Giesel, M. and K. R. Gegenfurtner. 2010. Colour appearance of real objects varying in material, hue, and shape. *Journal of Vision* 10(9). DOI:10.1167/10.9.10.
- Granzier, J. J. M., R. Vergne, and K. R. Gegenfurtner. 2014. The effects of surface gloss and roughness on colour constancy for real 3-D objects. *Journal of Vision* 14(2). DOI:10.1167/14.2.16.
- Watanabe, S., S. Tominaga, and T. Horiuchi. 2020. The Difference in Impression between Genuine and Artificial Leather: Quantifying the Feeling of Authenticity. *Journal of Perceptual Imaging* 3(2): 20501-1-20501-11.



# Cross-media color reproduction under mixed adaptation condition

Jiaxun Zhang<sup>1</sup>, Haisong Xu<sup>1,\*</sup> and Hao Jiang<sup>1</sup>

<sup>1</sup> State Key Laboratory of Modern Optical Instrumentation, College of Optical Science and Engineering, Zhejiang University, Hangzhou 310027, China; jasonxzhang@126.com, chsxu@zju.edu.cn, zjuijh@163.com

\* Corresponding author: chsxu@zju.edu.cn

## Abstract

Mixed adaptation occurs when an observer is evaluating the cross-media color reproduction using a successive binocular observation. This study focuses on the influence of the luminance disparity between the two media on the mixed adaptation status. A color matching experiment was conducted to obtain the corresponding colors between the fabric samples illuminated by a light booth and the softcopy images displayed on a monitor with a much lower luminance level. Compared with the prediction of the existing mixed adaptation models intended for the condition with the two media being roughly equal in luminance, the reproduced colors on the monitor requires higher lightness or colorfulness to compensate for the luminance difference in the present experiment, indicating that the luminance-dependent color appearance phenomena may play an important role in the mixed adaptation. In addition, the texture effect is discussed as well, which turns out to have an insignificant impact on color reproduction.

**Keywords:** *corresponding colors, cross-media color reproduction, mixed adaptation, luminance disparity*

## INTRODUCTION

The observer is in the state of mixed adaptation when comparing a digital image on a self-luminous display and an object under a particular illumination using a successive binocular observation. There has been attempts to derive mixed chromatic adaptation transformation models, such as the revised CIECAM02 for mixed chromatic adaptation recommended by CIE TC 8-04. However, most previous studies only focused on the controlled experimental conditions, where the illumination and the display have an analogous luminance level (Oicherman et al. 2008; Sueeprasan et al. 2003; Komatsubara et al. 2002; Katoh et al. 1998). Therefore, it is inappropriate for the existing models to deal with the luminance-dependent color appearance phenomena, like Hunt effect and Stevens effect.

In industrial applications, like textile printing and dyeing, the colored samples are usually illuminated by a light booth for visual appraisal. According to the standard ASTM D1729-2016, for example, a light booth should produce an illuminance of 2150 lux with a chromaticity of D65, whereby the luminance reflected by the sample placed at the bottom of the light booth is up to 684 cd/m<sup>2</sup> under the assumption of Lambertian surface. However, the peak luminance of common desktop monitors is only about 100-300 cd/m<sup>2</sup>, much lower than that under the light booth.

Regarding the large disparity in media luminance levels in the practical applications, this study aims to investigate the mixed adaptation under unequal-luminance conditions. Through a psychophysical experiment, the corresponding colors were obtained between the fabric samples and the displayed softcopies. A data analysis was performed on the inter-observer variability and corresponding colors to give a deeper understanding of the mixed adaptation and assess the feasibility of the color reproduction between the standard light booths and desktop monitors. Additionally, several previous studies reported that the fabric texture influenced the color appearance (Chae 2020; Dimitrovski et al. 2020). Hence, this study would also discuss whether the texture affects the practical color reproduction performance.

## EXPERIMENT

An asymmetric color matching experiment was carried out between the fabric samples illuminated by a light booth and the corresponding softcopies displayed on a monitor. The light booth has a luminance of 760 cd/m<sup>2</sup> and a chromaticity of D65. The peak luminance of the monitor is 218 cd/m<sup>2</sup> and the correlated color temperature of the white point was adjusted to 7273K, which was found to have a similar appearance to the D65 illumination of the light booth according to a preliminary experiment. The monitor was placed adjacent to the light booth, as illustrated in Figure 1.

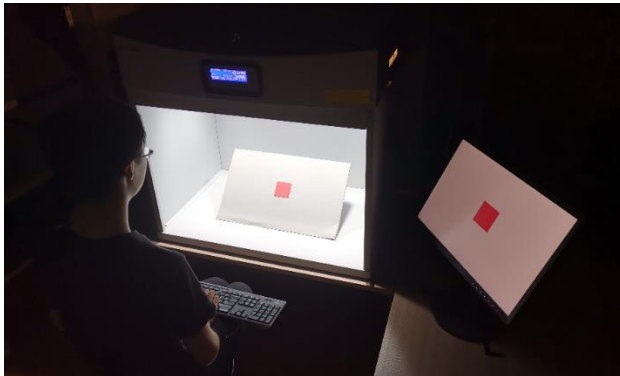

Figure 1: The set-up of the experiment.

A total of 43 fabric samples with varying colors were involved in the experiment. They were divided into 6 categories according to their textures, labeled as Type 1-6, of which some are demonstrated in Figure 2. All the samples were clipped to the same size, equivalent to a 4° field of view. And their texture images and the spectral reflectance data were acquired beforehand to generate the corresponding softcopies.



Figure 2: Some examples of the fabric samples. To demonstrate the textures on the sample surfaces, the sizes of the images are scaled to be equivalent to 10mm×10mm.

The visual experiment was conducted in a dark room. A 2-min dark adaptation and a 1-min background adaptation to the light booth illumination were performed at the beginning of the experiment. The corresponding colors of the fabric samples were obtained via the psychophysical method of constant stimuli. For each sample, the central color was predetermined by another preliminary experiment with the method of adjustment. A series of softcopies were generated with varying colors distributed around the center and evenly along the axes of lightness and colorfulness. The observers were instructed to compare the softcopies, which were presented on the monitor in a random order, to the real sample using successive binocular observations, allowing their gaze to shift

back and forth between the two media. Therewith, the observers judged whether (to accept or reject) the softcopy appeared to match the real sample. A panel of 14 observers with normal color vision participated in the experiment.

## **RESULTS AND DISCUSSION**

### **Inter-observer variability**

The inter-observer variability is represented by the coefficient of variation (CV). Table 1 lists the averaged CV values over all observers and fabric samples of the individual texture type, in terms of lightness and colorfulness, respectively.

<b>Texture type</b>	<b>Lightness</b>	<b>Colorfulness</b>
1	31.41	25.04
2	31.19	29.66
3	28.37	24.84
4	28.43	24.83
5	34.50	24.70
6	32.79	27.33

Table 1: The inter-observer variability for lightness and colorfulness.

As seen in Table 1, the visual results on the lightness attribute vary considerably among the observers, while for the colorfulness, the observers' judgments are in a good agreement. This trend is consistent with the findings of Oicherman et al. (2008), who suggested that the variability in color matching could be result from the observer metamerism and the contribution of non-image-forming visual mechanisms. Furthermore, to discuss whether the inter-observer variability is associated with the fabric texture, a repeated measures ANOVA has been implemented, for which the texture type is regarded as the independent variable and the CV in lightness or colorfulness is regarded as the dependent variable. The analysis indicates an insignificant relationship between the fabric texture and the inter-observer variability ( $p = 0.062$  for colorfulness variability and  $p = 0.105$  for lightness variability). Thus, the fabric texture may not be the factor reducing the accuracy of the color matching experiment in this study.

### **Corresponding color**

The visual judgments were analyzed to obtain the corresponding colors. For each sample, the Probit analysis was adopted to derive the T50 points, which were then fitted into an ellipse, outlining the accepted zone. The center of the ellipse represents the corresponding color of the real sample, with the maximum possibility to be accepted. Figure 3 plots the corresponding color pairs for all samples on the lightness-colorfulness plane of CIECAM02-UCS, of the which the coordinates are calculated by the CIE recommended revision of CIECAM02 for the mixed chromatic adaptation.

For the dark samples with the lightness being lower than 50 (approximating to the lightness of the viewing background), the corresponding colors mainly shift towards higher colorfulness, whereas, for the bright samples, considerable lightness shifts are found between the corresponding colors and the



real sample colors. The deviations of the corresponding colors observed in this experiment reveal that the luminance-dependent color appearance phenomena also play an important role in the cross-media color reproduction, which have been ignored in many existing models on mixed adaptation. It is possible that not only the chromatic adaptation but also the light adaptation (or post-adaptation nonlinear compression) is influenced by both media simultaneously.

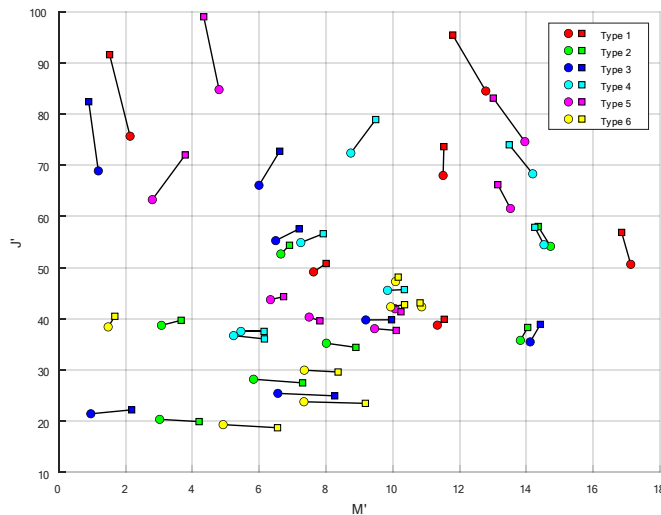

Figure 3: The corresponding color pairs plotted on the lightness-colorfulness plane of CIECAM02-UCS. The circle marks represent the samples' surface colors and the square marks represent the softcopy colors. And the different sample types are distinguished by various color symbols.

This experiment indicates that the texture has insignificant impact for the deviations in the corresponding color pairs, according to a MANCOVA ( $p = 0.320$ ) with the texture type as the independent variable, the deviation of the corresponding colors as dependent variable and the coordinates of the real sample color as the covariates. This result may not contradict the previous reports about the texture effect on the fabric sample's color appearance. A possible explanation is that, due to the same texture patterns of the real samples and the softcopies in this experiment, their effects counteract each other when the observer is comparing the targets on the different media.

## CONCLUSION

In this study, a cross-media color matching experiment was conducted to investigate the mixed adaptation under the unequal-luminance condition. Despite of the disagreement on lightness judgments among the observers, it is still possible to achieve a globally acceptable color matching under the unequal-luminance condition. Compared with the prediction of the existing models, the corresponding colors on the display require higher lightness or colorfulness to compensate for the luminance disparity in the present experiment, revealing that the luminance-dependent color appearance phenomena may play an important role in the mixed adaptation. Additionally, the texture effect turns out to have an insignificant impact on the color reproduction performance according to the data analysis on the inter-observer variability and corresponding colors.

## **REFERENCE**

- Chae, Y. 2020. The color appearance shifts of woven fabrics induced by the optical blending of colored yarns. *Textile Research Journal* 90: 395-409.
- Dimitrovski, K., A. Grmek, and H. G. Tomc. 2020. Use of a predictive colour model for managing the colour appearance of two-colour woven fabrics. *Coloration Technology* 136: 270-287.
- Katoh, N., K. Nakabayashi, M. Ito, and S. Ohno. 1998. Effect of ambient light on the color appearance of softcopy images: Mixed chromatic adaptation for self-luminous displays. *Journal of Electronic Imaging* 7: 794-806.
- Komatsubara, H., S. Kobayashi, and N. Nasuno. 2002. Visual color matching under various viewing conditions. *Color Research and Application* 27: 399-420.
- Oicherman, B., M. R. Luo, B. Rigg, and A. R. Robertson. 2008. Effect of Observer Metamerism on Colour Matching of Display and Surface Colours. *Color Research and Application* 33: 346-359.
- Sueeprasan, S., and M. R. Luo. 2003. Applying chromatic adaptation transforms to mixed adaptation conditions. *Color Research and Application* 28: 436-444.



# Study on colour effect of transparent material under colour-light

Ye Zhang <sup>1</sup>, Kaiyin Chen <sup>2</sup> and Shulei Ma <sup>3</sup>

<sup>1</sup> China Academy of Art, Hangzhou, China; 406849110@qq.com

<sup>2</sup> China Academy of Art, Hangzhou, China; 542595974@qq.com

<sup>3</sup> China Academy of Art, Hangzhou, China; 724200531@qq.com

\* Corresponding author: 406849110@qq.com

## Abstract

Transparent materials are often used in different light environment because of vibrant visual effects. However, it lacks in-depth research on the relationship between transparent materials and colour light, especially in design. This paper thus from a colour design perspective demonstrates a systematic research on the visual effects through transparent materials, colour and light and further proposes a theoretical model based on the experimentation. The study explores the colour effects under the conditions of additive & subtractive colour mixing. The experiment includes two phases that constitutes a colour-light system through transparent materials with various colour gamut, and illumination density. By changing colour of the light, the transparent materials appear a regularity of overlapping visual effects. The finding shows four variables of visual effects: colour mixtures, colour, transparency, and materiality, which provide alternatives for designers and artists who involved in the construction of colour-light urban contexts.

**Keywords:** *Transparent materials, Colour and light, Colour effect.*

## INTRODUCTION

Descartes proposed that color perception correlates with three relationships: object, light, and perceptual subject. The color effect produced by the object and light is the visual object of the perceptual subject. Color is not only a visual phenomenon, but also a way of being perceived by the transformation of information.

Color vision is deceptive. This is a kind of misjudgment, which is due to the past experience of perceptual subject. So, could we use transparent materials to make more possibilities for the conversion between three-dimensions and two-dimensional visual effects? And what color effects can be created under this illusion possibility? It is exactly the question that this study needs to explore.

People have an instinctive choice of color harmony. However, when people's visual judgments are related to memory, people will have dramatic misperceptions. Josef Albers (2012) once placed different colors on top of each other, creating an illusion of transparency between colors. Through contrast of colours, we can see 'transparency' visually with color.

When transparent materials and light are related to people's lives in space, visual objects and perceptual subjects begin to be inseparable. At this time, the spatiality and timeliness of the color effect have been reflected to the greatest extent. This study focus on the regularity and organizational color effects, which formed by transparent materials under color, in order to further explore how is the transparency with material influence the experience of color effects.

## METHODS

### (1) Factors

The factors that need to be controlled in the experiment are color light, transparent material, and the position of transparent material. Color light includes RGB color, white light, and secondary color composed of two different amounts of RGB colors. We choose 20 different colors for experiment, which belong to five different hues, ranging from medium brightness to high brightness, and low

saturation to high saturation area. Transparent materials of different colors can be combined in the position of parallel and perpendicular.

## (2) Apparatus

The transparent material was set in two experiment space. One is a black space of 100cm\*100cm\*250cm. We use flashlights which has RGB light which can be used for color mixing.

And another is a black space of 300cm\*300cm\*300cm. The light source is located on the top, side and bottom of the space, so the color effect of transparent materials can be observed from the front. Using the RGBW mode lighting equipment, three primary light colors were selected in the experiment, and the 6 intermediate colors and the color temperature were 3000K white light. Considering people's demand for light intensity in a conventional light environment, the light intensity of the color light is divided into 7 levels between 0 and 300 lux.

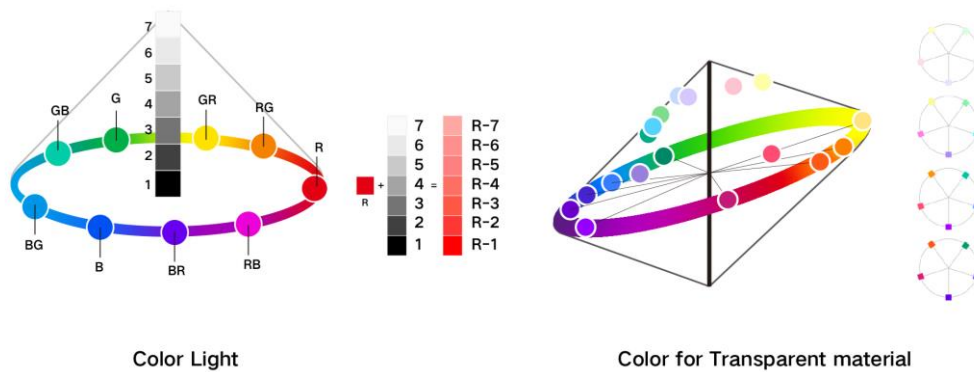

## ANALYSIS AND FINDINGS

At the same time, the influence of light color on the visual effects of transparent materials with different brightness and brilliance is initially explored, and the law of possible color effects is assumed: transparent materials with low brilliance than high brilliance are more affected by the hue of color light. Preliminary experiments have found that after adding white light to the colored light environment, both the transparent material itself and the back projector show the original color more or less. However, transparent materials with different brilliance and brightness are different in the degree to which they are affected by white light.

In the second round of experiments, the experiment not only records the value of the color light, but also controls the increase of white light in the color light environment to observe and record the dynamic changes of the color of transparent materials with different brightness, brilliance and hue affected by the color light.

The color change pattern presented by transparent materials is as follows: In an environment without white light intervention, the RGB colors have the greatest impact on the color of the transparent material. And the order of influence on the color is red light, green light, and blue light. When white light is involved in the environment, the appropriate amount of white light will not only change the color atmosphere, but also help the transparent materials showing their real color.

Subsequently, in order to explore the influence of the difference in the amount of light transmission of different transparent materials, under the color light on the color effect, the transparent materials were laminated and laminated under the color light in two layers and three

layers. As the light transmittance of the transparent material changes under different color light environments, the visual effect of the transparency of the transparent material changes. We can observe that the same superimposing method presents a dynamic color effect in the latitude of time. Transparent materials have the contrast of "hidden" and "shown" effects, which makes us have a change in spatial perception of transparent materials.

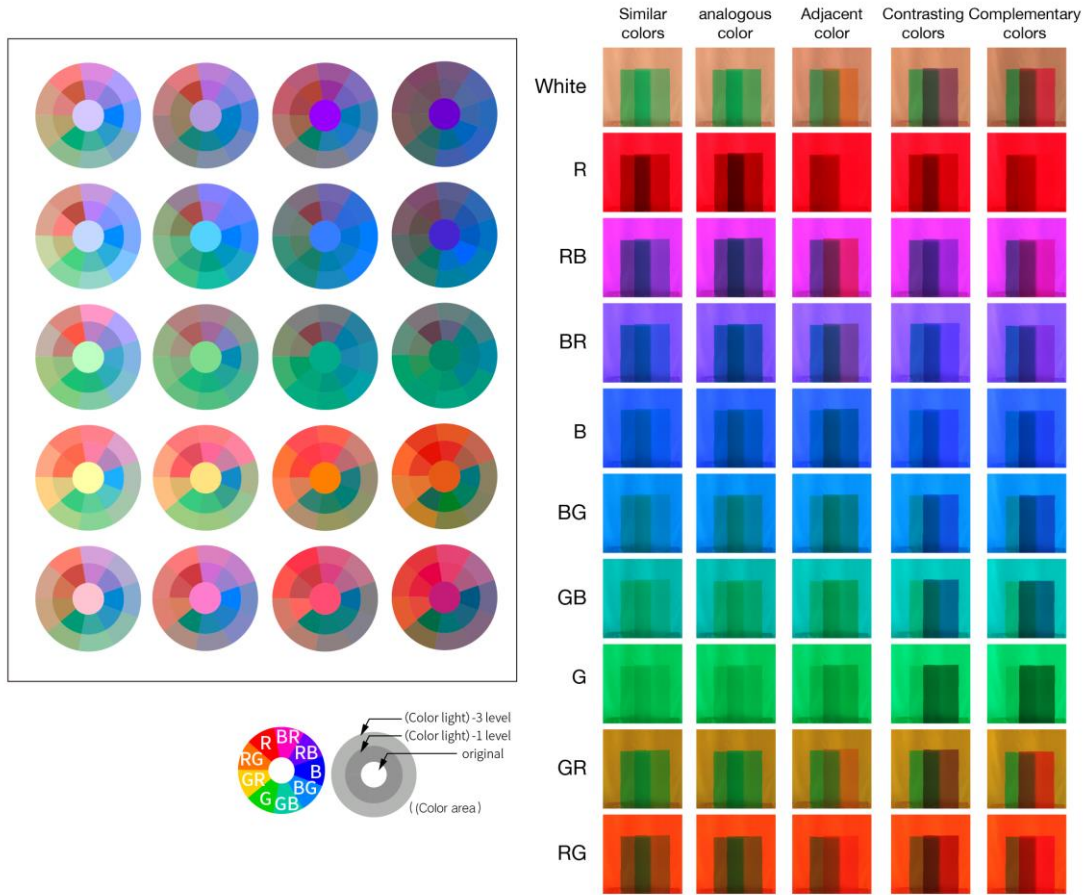

**RESULT**

In order to verify the objectivity and authenticity of the visual effects, research is conducted to extract the data of on-site intuitive perception and measurement. The algorithm derives the data of the transparency and color change of transparent materials by fitting experiments. The experimental data is fitted by the smallest chi-square. The experiment is set to an ideal state, eliminating the prejudgment of the error, and the recorded data is processed with weight function.

### Analysis of light transmittance of transparent materials

The light transmittance data is collected based on the first experiment space. The Pearson correlation coefficient is measured by the transmittance of White light, Red light, Green light and Blue light through different color transparent materials.

It can be seen from the chart that when the R value of the material is higher, the transmittance of the incident red light in the transparent material is higher, and the correlation coefficient  $r=0.65$ . And we could come to the same conclusion with Green light. However, due to the large difference between the measured data during the experiment, the conclusion of blue light is not valid. WRGB incident light changes with the value of the transparent material [RGB], and the best-fitting mathematical relationship expression is as follows:

$$T = \alpha + (\beta MR + \gamma MG + \delta MB) / 255$$

Among them, the T represents the transmittance of incident light, which influence visual with brightness of color effects. And the M represents a transparent material, corresponding to the RGB value of the transparent material, and each has its own corresponding fitting parameters. According to the formula, it can be found that when the sum of the RGB values of the transparent material is higher, the transmittance of the incident light will increase. This can be verified by the experiment found in the previous section. The higher the brightness of the transparent material, the higher influence of light color.

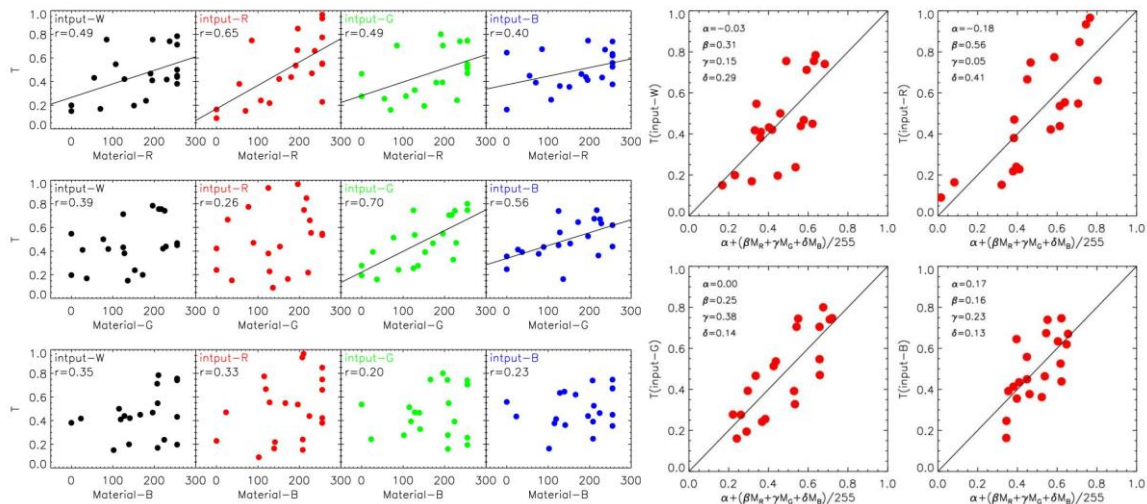

### Analysis of color change data of transparent materials affected by colored light

Because we want to explore the effect of white light on the color of transparent materials on the saturation, brightness, and hue, white light is used as a channel fitting when setting parameters. The best fitting mathematical relationship diagram:

$$V_R = \alpha + (\beta R + \gamma G + \delta B + \epsilon R' + \lambda G' + \eta B' + \zeta W') / 255$$

$$V_G = \alpha + (\beta R + \gamma G + \delta B + \epsilon R' + \lambda G' + \eta B' + \zeta W') / 255$$

$$V_B = \alpha + (\beta R + \gamma G + \delta B + \epsilon R' + \lambda G' + \eta B' + \zeta W') / 255$$

Among them, V represents the RGB value of the transparent material under the color and light condition. R, G, B represent the original value of the transparent material color. And R'G'B' represents the numerical value of the middle shade light color.

According to the formula, it can be found that the R value of red light and transparent material is positively correlated in terms of color effect, similarly to the G value of green light and transparent



material, and the B value of blue light and transparent material. At the same time, it can also be found that the fitting parameter  $\eta = -53.64$  of the green light in the VR fitting relationship is much smaller than  $\epsilon = -25.16$ , because they are in a negative correlation in the effect.

Therefore, the smaller the fitting parameter, the higher influence of color effect. This can also explain the phenomenon that the red transparent material is close to jet black under green light and has a lower lightness in the experiment in the previous section, while the green transparent material is dark red under red light and has a relatively higher lightness.

The chart shows that when the red transparent material is in a green light environment, as the white light content increases, the RGB values increase, and the brightness and brilliance of the transparent material is increasing. But when the green transparent material is in a red-light environment, as the white light content increases, the brightness of the transparent material increases, it can be seen that the saturation of the transparent material is decreasing.

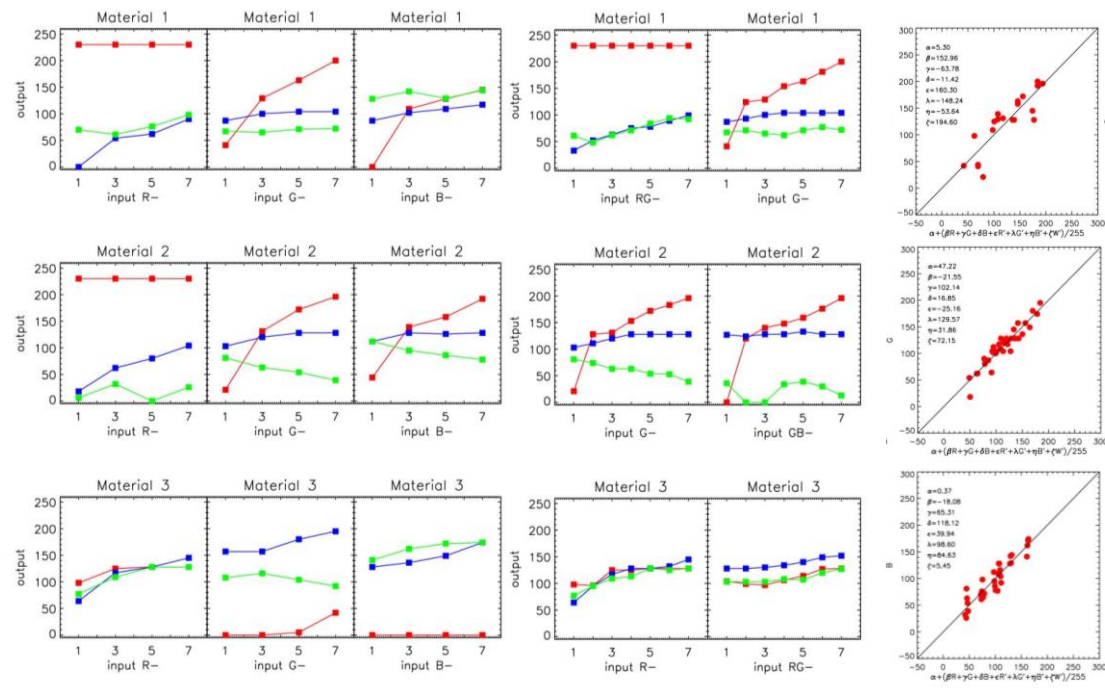

## DISCUSSION

### The influence of white light on the color effect of transparent materials

When there is no white light, the RGB colors will cause the surface of the transparent material to show a bright fluorescent color, or too dark to show color. The color of the transparent material and the light tend to be close, and the transparent material appears more gorgeous; when the color tends to oppose, the color of the transparent material become darkness.

When white light is involved in the light environment, a small amount of white light will not change the color atmosphere of the light environment as a whole, but it can help the transparent material present the original color to a certain extent. At the same time, the whiter light, the closer the color appears to the color of the material itself.

### The influence of color light on the change of the transparency for materials

The color of the transparent material is affected by the color light. When the changed color changing great different, the light transmission of the transparent material is reduced. At the same time, in

terms of visual presentation, the transparency is reduced. Therefore, when the color relationship between transparent material and light is seemingly contrast, if the transparent material is medium or high brightness, the color light will strengthen its effect. However, transparent materials with high brightness will easily produce the effect of blending into the color and light environment after the color changes under the influence of the light color. From the visual perception, the transparent materials become more transparent.

As a result, there is a contrast between explicit and implicit, and there are phenomena such as changes in contrast between blur and clarity. Its essence is the change in the amount of light transmitted by transparent materials in different colors. The visual effect needs to be assisted by the temporality and spatiality of the color light to be better reflected.

## **CONCLUSION**

This study shows that the exploration of color visual effects requires record of phenomena. Meanwhile, we can essentially find that the color effect overlaps between the medium and the light is much greater than the effect of one plus one equals two.

This study outlines two key points for the perceptual subject producing color perception of its visual phenomena in a transparent material environment in a colored light environment: the proportion of white light in the colored light environment, and the change in the visual transparency of the transparent material. Based on these two key points, it is not only conducive to transparent materials to present a more comfortable color effect in the night scene, but also can cooperate with the color and light to produce more interesting and orderly rich changes. The sense of space, resulting in the effect that the margins are being blurred, created by transparent materials and colored lights is based on the visual psychological response of the transformation of visual experience.

## **REFERENCES**

Albers, J. 2012. *Interaction of Color: 50th Anniversary Edition*. Paris: Artists Rights Society.

# Quantification of the effect of colour appearance and materials on the visual-tactile properties of fabrics

Qinyuan Li <sup>1</sup>, Jinxing Liang <sup>2</sup>, Yan Lu <sup>1</sup>, Kaida Xiao <sup>1,\*</sup> and Michael Pointer <sup>1</sup>

<sup>1</sup> University of Leeds; liqinyuan2621@gmail.com, sdy1@leeds.ac.uk, k.xiao1@leeds.ac.uk, mrpointer@btinternet.com

<sup>2</sup> Wuhan Textile University; jinxing0727@126.com

\* Corresponding author: k.xiao1@leeds.ac.uk

## Abstract

This paper presents the results of experiments to evaluate the human perception of the visual-tactile properties: *flexible-stiff*, *smooth-rough* and *soft-firm* of fabrics as seen on a mobile-phone display. The aim of this study was to test whether different colours and different fabrics have significant effects on these properties, and to evaluate the differences between the effects of these parameters. Eighty images, representing four fabrics and 20 colours, were used to judge the human responses to tactile properties. The results showed that observers can be significantly affected by colour when assessing smoothness, roughness, softness and firmness on woollen wool fabric, while most colours have no significant effect on the human perception of flexibility and stiffness. Fabric materials which have different textures have more significant effects than colour for smoothness, roughness, softness and firmness, but there is little difference between the effects of colour and fabric material when assessing flexibility and stiffness.

**Keywords:** *visual-tactile properties, colour effect, fabric effect*

## INTRODUCTION

People are able to visually predict the tactile properties and surface characteristics of materials (Xiao et al. 2016; Plaisier et al. 2009; Yuan et al. 2017; Fleming 2014). When people purchase products, factors that include appearance, colour, quality, and material, affect their preferences and hence their desire to purchase. With online shopping becoming a greater tendency, the decision to purchase a product has to be made based on the images of that product viewed on a display, be it a phone, a tablet or a computer. In the field of textiles, the tactile properties of the fabric are significant factors that affect the perception of the quality of the product, and hence influence the decision to purchase. When fabrics are viewed on a display, those tactile properties can only be perceived through images, leading to a different response, namely the perception of the “visual-tactile properties” of the fabric. Colour is an important parameter that attracts a potential purchaser to, for example, a particular garment. Thus the display has to adequately represent the garment not just in terms of the colour but in terms of the colour, overlaid on to the texture of the fabric from which the garment is made (Shen 2006).

The aim of this study was to evaluate whether the colour and the fabric material have a significant effect on the human perception of the visual-tactile properties of fabrics, and to assess the significance of the differences between the effects of these two parameters.

## EXPERIMENT

Four samples of 100% worsted wool (fabric 1), 100% woollen wool (fabric2), 100% polyester (fabric 3) and twill 100% cotton (fabric 4) were selected for the experiment because of their high occurrence in the popular fashion market. As shown in Table 1, their texture differentiates between the four fabrics, making it an importance appearance parameter, that will be altered in the experiment.





Fabric 1	Fabric 2	Fabric 3	Fabric 4
Worsted 100% wool	Woollen 100% wool	100% polyester	100% cotton
			

Table 1: Original images of four fabrics and their description.

The second important appearance factor is the colour of the fabric. Images of each fabric were rendered to obtain 20 differently coloured images of each, Table 2, giving 80 images in total. The final images of the samples appeared to represent 'real' fabric samples when displayed, which is necessary to enable products to be sold online. Four colours of different chroma and lightness were set close to the five CIE reference colour centres, grey, red, yellow, green and blue, (Luo 2006) giving an average distribution in CIELAB colour space, Figure 1.





















Colour	Colour	Colour	Colour
1		11	
2		12	
3		13	
4		14	
5		15	
6		16	
7		17	
8		18	
9		19	
10		20	

Table 2: Specification of 20 colours.

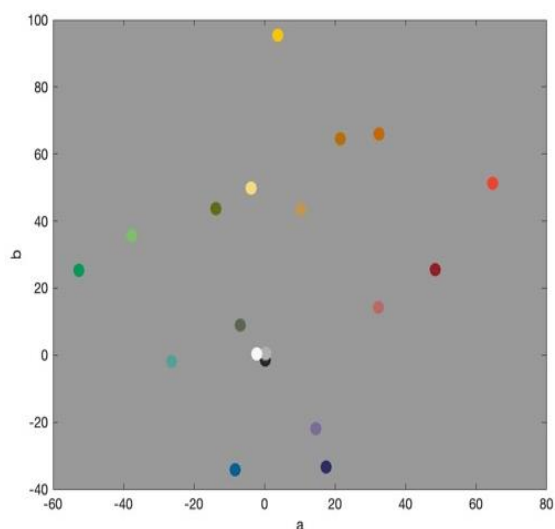

Figure 1: Location of the 20 colours in CIELAB a\*b\* colour space

Three pairs of descriptors of the tactile properties of fabrics were selected from the Touch Perception Task (TPT) developed by Guest et al. (2011): *flexible-stiff*, *smooth-rough* and *soft-firm* and each pair used to evaluate the response of observers to the images of the fabrics. To aid the observers, they were given definitions of the descriptors to maintain consistency in their judgements.

Eighteen observers (9 males and 9 females) with ages that ranged from 21 to 37 years were invited to carry out the experiment which was performed in a dark room on one specific mobile phone, a HUAWEI P20 Pro, model CLT-AL00. The phone was fixed to a table to ensure that the field-of-view of the observers was horizontal to the screen and that their distance from the screen was approximately 40 cm. Each observer made assessments of each property, *flexible-stiff*, *smooth-rough* and *soft-firm* separately with no time constraints.

Observers were first asked to read and understand the explanation of the pairs of descriptors. The 80 images were then displayed on the phone one at a time, in random order, with each repeated once.

Two tasks were set for each assessment. First, the observers were asked to select one descriptor in the pair that best described the tactile properties of the fabric. Second, the observers were asked to locate the selected descriptor on an equal-interval scale ranging from one to seven. For the colour samples that were assigned the first descriptor in the pair (i.e., *flexible, smooth, soft*), the score was recorded as a negative number from -7 to -1, where -7 meant the most flexible, the smoothest or the softest, and -1 meant the least flexible, the least smooth and the least soft, respectively. For colour samples that were assigned the second descriptor in the pair (i.e., *stiff, rough, firm*), the score was recorded as a positive number from one to seven where 7 meant the stiffest, the roughest and the firmest, and 1 meant the least stiff, the least rough and the least firm. The higher the absolute value that a colour sample was judged, the greater was the perception of the extent of the that descriptor.

## **RESULTS AND DISCUSSION**

### **Observer variability**

To test the intra-observer variability of the two results of each observer, the Pearson product-moment correlation coefficient values ( $r$ ) were calculated using the IBM SPSS Statistics software. The correlation coefficient ( $r$ ) is a factor that ranges from -1 to +1, where -1 denotes a perfect negative linear relationship and +1 denotes a perfect positive linear relationship (Ou et al. 2004). All observers showed reasonably high consistency with the  $r$  values higher than 0.60.

The mean category value ( $c$ ) was used to calculate the inter-observer variance for the three separate assessments (Morovic 1998) and the values were 40%, 36% and 36% for *flexible-stiff*, *smooth-rough* and *soft-firm* respectively. Even though observers showed moderately high variability compared, for example, to Morovic (1998: 177), it is considered a reasonable result given the subjective nature of the experiment.

### **The effect of colour on visual tactile properties.**

The original data were recorded as integer values that indicated the judgement of the visual-tactile properties of the fabrics. For each image, the 36 integer values of each assessment given by the 18 observers were converted to statistical z-scores according to the law of categorical judgement.

The z-scores of each image for the three pairs of descriptors are shown in Figure 2-4. A higher z-score means the image was visually perceived as *stiffer, rougher or firmer*. A 95% confidence interval was calculated for each of the colour samples (Morovic 1998). For any sample, if the z-score was higher than the 95% confidence interval of another sample, then those two samples could be considered to be significantly different. In each figure, a horizontal line indicates the position of the upper boundary of the lowest confidence interval. In Figures 2-4 samples that have the minimum z-score are marked yellow and those that have the maximum z-score are marked green.

For the judgement of *flexibility* and *stiffness*, colour proved to be significant only for the woollen wool fabric, Figure 2, where the z-score was significant for eight of the coloured samples (1, 4, 5, 12, 13, 16, 18, 20), and that of sample 7 did not overlap with colour samples 5 and 12. Thus, only a small number of colours have a significant effect on the human perception of *flexible-stiff* woollen wool fabric. For worsted wool, cotton and polyester, the 95% confidence intervals of all samples overlap with each other, which implies that colour has little effect on the perception of *flexible-stiffness*.

Quantification of the effect of colour appearance and materials on the visual-tactile properties of fabrics

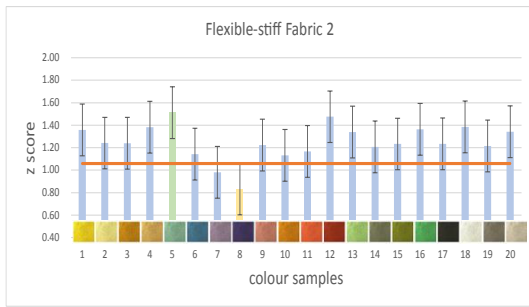

Figure 2: z-score for *flexible-stiff* on woollen wool fabric.

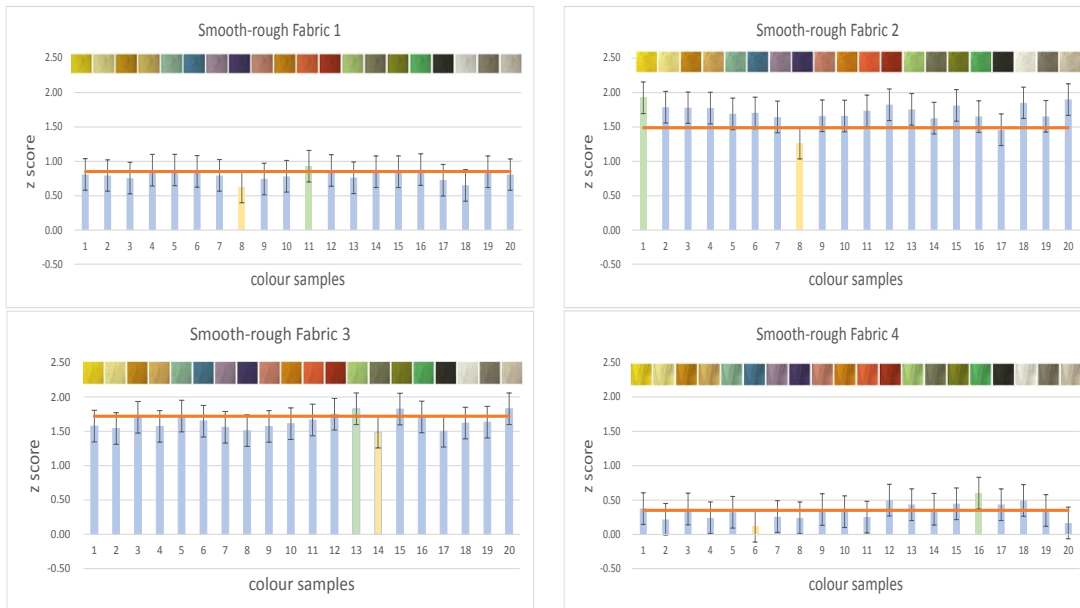
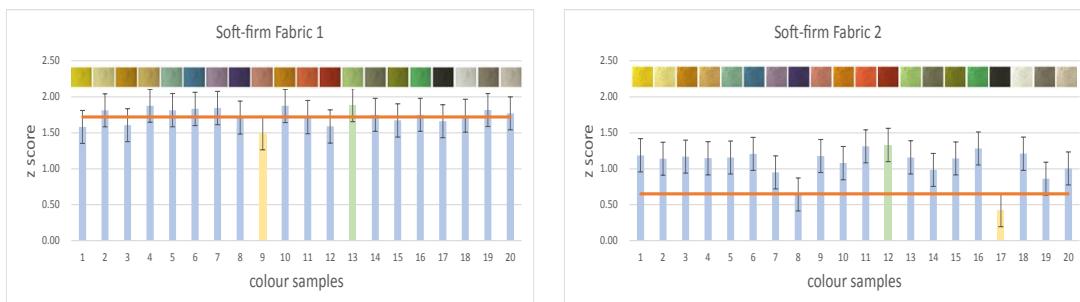

Figure 3: z-score for *smooth-rough* on four fabrics.

For the judgement of smooth-rough, Figure 3, the 95% confidence intervals of the 20 coloured samples all overlapped for fabrics 1 and 3, indicating that colour had no significant effect on smooth-rough when viewing worsted wool and 100% polyester. For woollen wool, fabric 2, a significant colour effect was shown for colour 8 with all colour samples except 14, 16 and 17 showing some overlap, suggesting that observers were significantly influenced by the colour when assessing the smooth-rough of woollen wool. For 100% cotton (fabric 4), non-overlap of 95% confidence intervals only occurs between for colours 6-16.



## Quantification of the effect of colour appearance and materials on the visual-tactile properties of fabrics

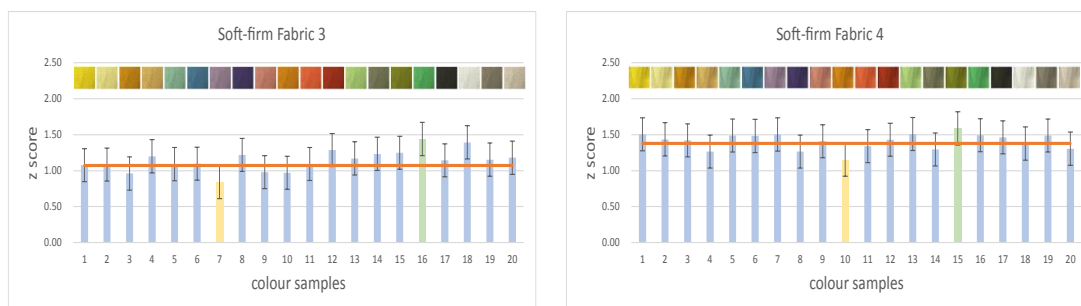

Figure 4: z-score for soft-firm.

Figure 4 shows the observer’s judgement on *soft-firm*. For worsted wool (fabric 1) and 100% cotton (fabric 4), the 95% confidence intervals of all colour samples overlapped with each other, indicating that colour has no significant effect on the visual perception of *soft-firm*. For woollen wool (fabric 2), however, colour sample 17 showed a significant difference from the others, except for samples 8 and 19. The 95% confidence interval of colour sample 7 for 100% polyester (fabric 3) did not overlap. Thus, it can be deduced that only a small number of colours had a significant influence on the specific fabric materials when assessing *soft-firm*.

### The effect of fabric material on visual-tactile properties

Sorting the z-scores by the different fabrics and the different colours, with the four fabrics of the same colour placed adjacent in each colour group, shows that the fabrics have no significant effect when assessing *flexible-stiff*. The z-scores for fabrics 2 and 3 however, are significantly higher than those of fabrics 1 and 4 when assessing *smooth-rough*, and the z-score of fabric 1 was also different from that of fabric 4 for most colours suggesting that the fabric material can significantly affect human visual perception of the *smooth-rough* effect. A significant difference was, however, found between fabric 1 and fabrics 2-4 when assessing *soft-firm*. In summary, when assessing smoothness, roughness, softness and firmness, the effect of fabric material was a significant factor, while the perception of flexibility and stiffness correlated less well.

To quantify the different effects of colour and fabric material, the standard deviation was separately calculated for samples of the same fabric and samples of the same colour. Statistically, the standard deviation ( $\sigma$ ) is a measure of dispersion (Morovic 1998). In this experiment, a higher value of  $\sigma$  indicates a more significant effect given by colour or fabric materials. The value of  $\sigma$  was calculated by colour and fabric separately and are shown in Table 3.

	<i>Flexible-stiff</i>	<i>Smooth-rough</i>	<i>Soft-firm</i>
$\sigma$ -colours	0.12	0.11	0.15
$\sigma$ -fabrics	0.12	0.67	0.32

Table 3: Standard deviation of colour samples.

The effect of fabric material on the perception of *smooth-rough* was the most significant, with the value of  $\sigma$ -fabrics six times higher than that of  $\sigma$ -colours. For *soft-firm*, the difference between the effect of fabric and colour was smaller, but the results still indicated that the fabric materials affect the human perception of the tactile properties more than the colour. The values of  $\sigma$ -colours and  $\sigma$ -fabrics for *flexible-stiff* however, are equal. Given that only a few colours have significant effects on



Quantification of the effect of colour appearance and materials on the visual-tactile properties of fabrics *flexible-stiff* when viewing woollen wool, it is reasonable to assume that there is little difference between the colour effect and the fabric effect for the human perception of tactile properties.

## **CONCLUSION**

In this research, a psychophysical experiment was conducted to evaluate the effect of colour and fabric material on the human perception of visual-tactile properties of fabrics. Visual-tactile properties refer to the fabric handling properties that were evaluated visually through images with no actual touch involved. Three pairs of descriptors, *flexible-stiff*, *smooth-rough* and *soft-firm*, were used to judge the tactile properties. Statistically, human observers can be significantly affected by colour when assessing the smoothness, roughness, softness and firmness of woollen wool fabric, for example, purple fabric tends to be smoother and yellow fabric rougher, black fabric is softer and red fabric is firmer. For flexibility and stiffness, only a few colours affect human perception significantly, for example, purple fabric tends to be more flexible and green fabric is stiffer. In addition, fabric material has more significant effects than colour on the perception of the tactile properties except perhaps flexibility and stiffness, making it an essential appearance factor in the evaluation of these tactile properties.

Images viewed on a display are important in the entire textile industry, including the design process, manufacturing process control, online selling and consumer purchasing. Textile designers can employ these assessments to predict the degree to which retailers and consumers perceive the tactile properties. More importantly, the results of this study can assist consumers to correctly perceive the information portrayed by the images and hence make a reliable purchase. This will reduce the occurrence of problems, such as product return, refunds and complaints. In this way, with increased satisfaction in online shopping, this relatively new business model can be further developed and better serve human beings in our present life model.

## **REFERENCES**

- Fleming, R. W. 2014. Visual perception of materials and their properties. *Vision research* 94: 62-75.
- Guest, S., J. M. Dessirier, A. Mehrabyan, F. McGlone, G. Essick, G. Gescheider, A. Fontana, R. Xiong, R. Ackerley, and K. Blot. 2011. The development and validation of sensory and emotional scales of touch perception. *Attention, Perception, & Psychophysics* 73(2): 531-550.
- Luo, M. R. 2006. Colour difference formulae: Past, present and future. In: *CIE Expert Symposium*, 13-15.
- Morovic, J. 1998. *To Develop a Universal Gamut Mapping Algorithm*. PhD thesis, University of Derby. Bibliographic information on INIS: [http://inis.iaea.org/search/search.aspx?orig\\_q=RN:31032448](http://inis.iaea.org/search/search.aspx?orig_q=RN:31032448); Available from British Library Document Supply Centre- DSC: DX206639.
- Ou, L. C., M. R. Luo, A. Woodcock, and A. Wright. 2004. A study of colour emotion and colour preference. Part I: Colour emotions for single colours. *Color Research & Application* 29(3): 232-240.
- Plaisier, M. A., A. M. Kappers, W. M. B. Tiest, and M. O. Ernst. 2009. Visually guided haptic search. *IEEE Transactions on Haptics* 3(1): 63-72.
- Shen, H. X., and J. H. Xin. 2006. Colour simulation of textiles. In: Xin, J.H. ed. Total colour management in textiles. Ch.6. Cambridge: Woodhead Publishing.
- Xiao, B., W. Bi, X. Jia, H. Wei, and E. H. Adelson. 2016. Can you see what you feel? Color and folding properties affect visual-tactile material discrimination of fabrics. *Journal of vision* 16(3): 34-34.
- Yuan, W., S. Wang, S. Dong, and E. Adelson. 2017. Connecting look and feel: Associating the visual and tactile properties of physical materials. In: *Proceedings of the IEEE Conference on Computer Vision and Pattern Recognition*, 5580-5588.

# Differential color perception theory

Shahin Aldhahir <sup>1, \*</sup>

<sup>1</sup> Alkindy for R&D; aldhahirshahin@gmail.com

\* Corresponding author: shahinaldhahir@yahoo.com

## Abstract

Color theorists have been misled to what is called trichromatic color theory under the influence of pigments color theory made by artists at the early times of color history since artists using three primaries to reproduce the whole visible spectrum of colors. The absence of S-cones from our fovea is anatomical evidence that our vision system is dichromatic with red and green as the only primaries. Each of the L and M-cones on our fovea can detect the whole visible spectrum from 400 to 700nm which is far enough for our brain to perceive the whole visible spectrum including blue. Afterimage phenomena showing that our L and M-cone receptors are bipolar responsive. Purkinje shift phenomena give a strong indication that S-cones with rods surrounding our fovea are in charge of our night vision.

**Keywords:** Human Dichromatism, Red green vision, differential color perception, divariant color space, night vision

## INTRODUCTION

In the year 1704 Isaac Newton could split the white light into seven remarkable colors called visible spectrum.

In the year 1802 Tomas young declared that the visible spectrum of Newton is just as three primary colors blending each other to form the whole visible spectrum, fifty years later, a German Physicist and mathematician Helmholtz introduced a new color theory called Trichromatic color theory considering that Red, Green and Blue are the only three primary colors which can be mixed to introduce the whole visible spectrum (Malacara 2011).

In 1959 Jeremy Nathans has discovered four types of electromagnetic wave receptors located on human retina, rods for night vision, while short wavelength receptors or S-cones, medium wavelength receptors named M-cones and long wavelength receptors named L-cones for daylight vision (Gegenfurtner and Sharp 2001).

All of the three daylight receptors are responsible for detecting electromagnetic waves from 400 to 700nm with different unique absorption characteristics performing the principle assumptions of trichromatic color theory (Kulb 1991).

As a matter of fact trichromatic color theory assumptions has been considered as the inverse of pigments color mixing made by painters since painters use three primary colors to establish the full color spectrum. Holmz trivariant color system was a big mistake misleads the color theory scholars away from the actual divariant properties of our color vision system.

It is been found that our vision system depends upon L and M-cone cells to detect the whole wave lengths of color spectrum including short waves. Smith et al. (1975) which explains the absence of S-cons from our fovea itself. Churchland et al. ( 1996). S-cones founded out of our fovea have to be in charge of night vision with rods.

The following analytical procedures could proof the divariant properties of our color vision system.

## Mathematics explain the dichromaticity principle of our color vision system

Luminosity considered as a measure of how bright or dark a hue is (Kremers et al. 2016).

Starting from the principle phenomena of luminosity which indicates that Black is the zero intensity of white light.

$K = -W$  ..... 1

Where:

K = black

W = white

But  $W=R+G+B$  (trichromatic color theory)..... 2

Where:

R = red color

G = green

B = blue

$-(R+G+B) = K = 0$  ..... 3

$-R = (G+B) = C$  .....4

$-G = (R+B) = M$  ..... 5

Where:

C = cyan

M = magenta

Adding equation 4 to 5

$-(R+G) = C+M = B$  ..... 6

Equations 4, 5 and 6 could be represented as in Figure 1.

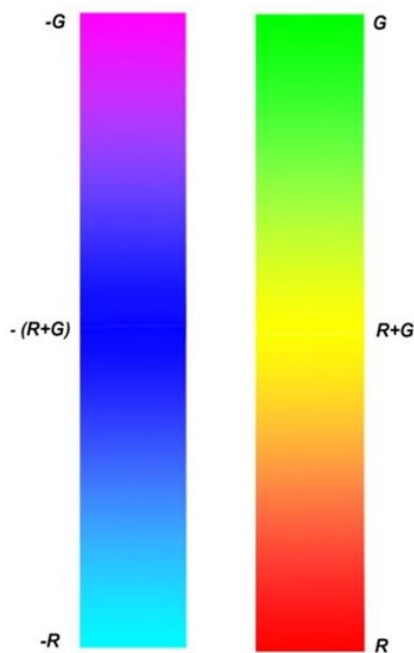

Figure 1: Color representation of equations 4, 5 and 6.

Figure 1 shows that “differential color perception theory” is a divariant Color system.

Each spectral color on the color space can be identified with two components, Red and Green only (Aldhahir 2013).

**L and M- cone signals are enough for our brain to perceive the whole visible spectrum**

Starting from Okkm’s razor principle “simpler solutions are more likely to be correct than complex ones.”

Our eye seems to detect electromagnetic waves in the range of 400 to 700n or what we call visible spectrum.

M- Cones detect electromagnetic energy in between 400 to 700n, L-cones detect between 400 to 700n as well (Smith et al. 1975).

Accordingly the process of detection for both types of cones will include short waves, medium waves and long waves, it explains the absence of S-Cones from the fovea where the colorful image projected by our eye lens (Williamson and Cummins 1983).

**No need for S-cones to be in our fovea**

Cone mosaic of Figure 2 shows that S-cones is absent from the fovea where the color image is projected by our eye lens (Gegenfurtner and Sharp 2001).

It is obvious that our vision system needs only the M-cones and L-cones to handle the two proper signals necessary for our brain to perceive the whole visible spectrum (See Figure 3).

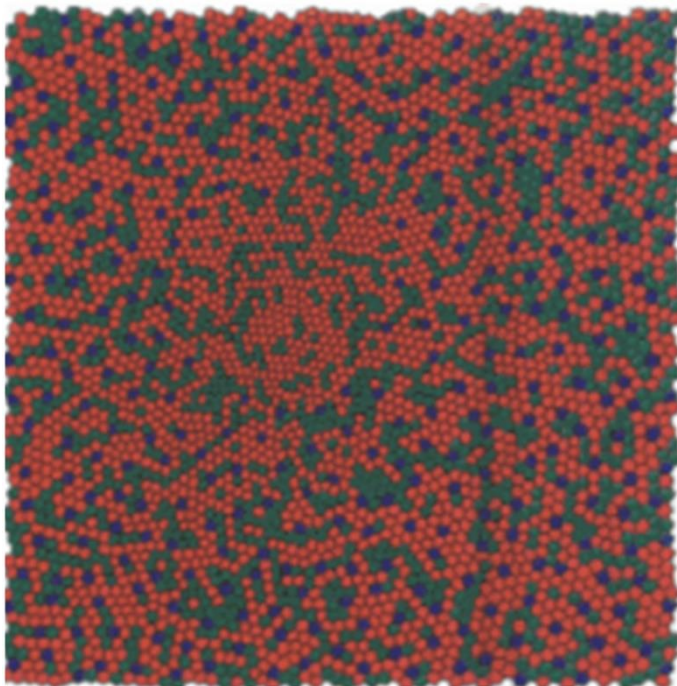

Figure 2: Map of human retina mosaic, S-cones almost zero density at the center and maximum at the slope.

**Our color vision system is additive and subtractive at the same time**

Starting with the phrase of Aristotle “The whole is greater than the sum of the parts”

If the result of adding two quantities to each other is greater than any of the two inputs, it means that each of the inputs and the output is positive.

Mathematically:

If  $a + b = c$  ..... 7

And  $b < c > a$  ..... 8

Then  $a$  is positive,  $b$  is positive and  $c$  is positive value as well.

The process of mixing green to red results in yellow, yellow luminance is always higher than green luminance and higher than red luminance as well, this process proves that red luminance value is positive and green luminance value is positive and yellow luminance is positive as well.

Also if the result of adding two quantities to each other is less than any of its inputs, it means that each of the two inputs and the output is negative.

Mathematically again:

If:  $a > c < b$  ..... 9

Then:  $a$  is negative,  $b$  is negative and  $c$  is negative as well.

The process of mixing magenta  $M$  with cyan  $C$  results in Blue (Equation 6).

Since blue is the darkest color on the spectrum then Magenta has a negative luminosity and Cyan has a negative luminosity which yields to a negative value to the blue resultant ( See Figure 3).

Considering the luminance of color spectrum of Figure 1, it is very well recognised that blue is always the most dark color and yellow is the most bright color.

Figure 3 represents the whole responsive characteristics of L and M-cones showing that our vision system is subtractive between 400-520nm and additive between 520-700nm (Aldhahir 2013).

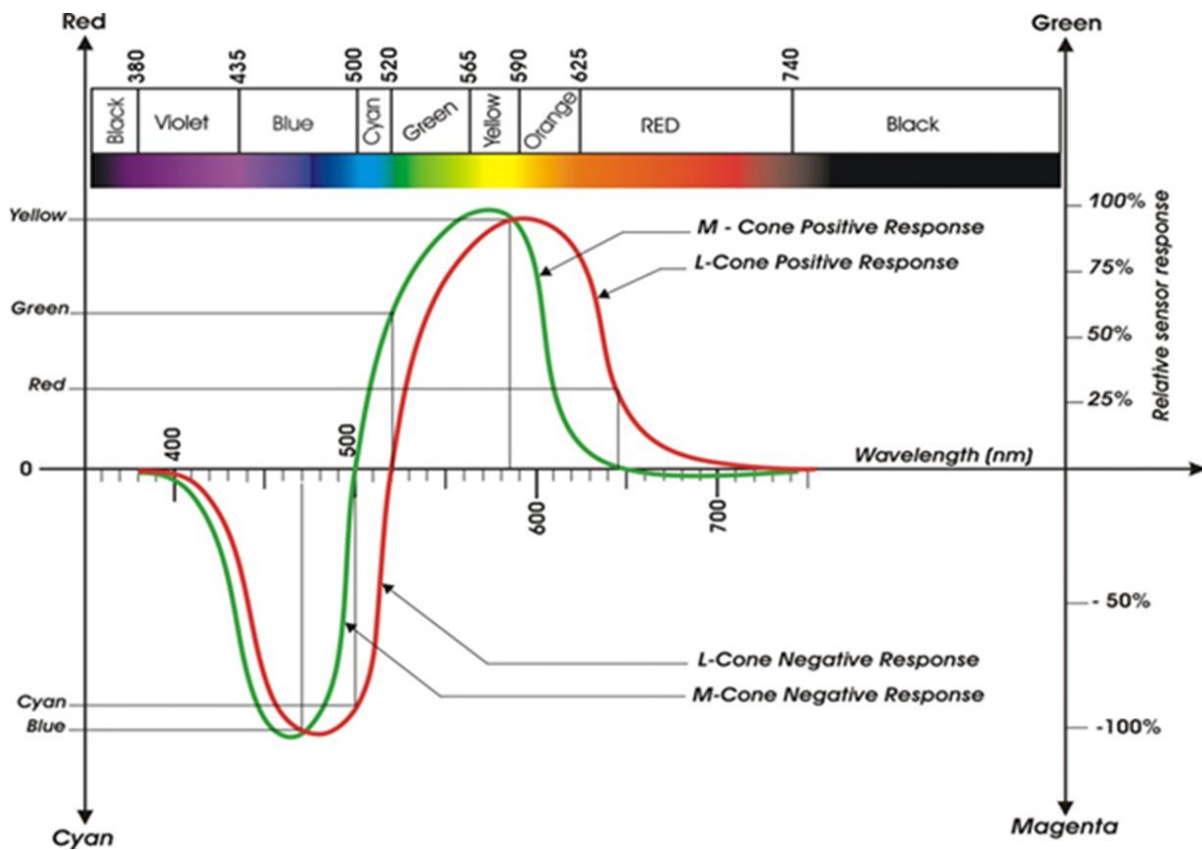

Figure 3: Charateristic curves of L and M receptors, showing yellow as:  $(R+G)$  while blue as:  $-(R+G)$ .

**After Image phenomena**

Figure 4 represents the hysteresis effect of the L-cone cell through the process of electromagnetic energy absorption of long wave and two possibilities of energy relief.

The absorption process of long wave rays as indicated on Figure 4 started through the path rate 1 exceeding the saturation limit to some extent, after removing the stimuli away, the process of desaturation will follow path rate (2) showing the negative color perception of red to be as cyan.

Path rate 3 is a positive desaturation showing the color under test which is red at this example.

Same behavior will be performed by the M-cone perceiving magenta for path 1 of desaturation and green for path 3 of desaturation.

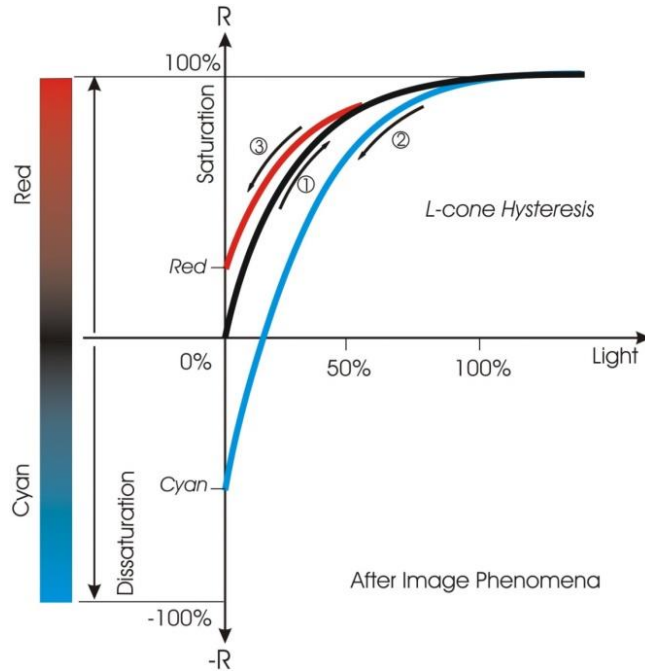

Figure 4: After image phenomena is just a hysteresis property of L and M receptors respectively.

**Red and green opsin genes are very similar and very much different from Blue opsin gene.**

Red and green opsin genes are adjacent to each other on the same X chromosome and they are very much identical while blue opsin located on chromosome 7 and it is much different from red and green opsin genes. Nathans et al. (1986), it gives an indication that S-cones are in charge of different function such as night vision together with rods.

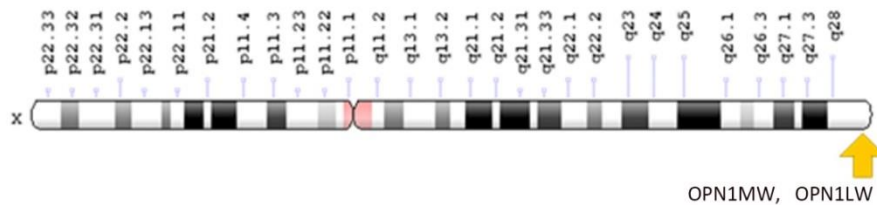

Figure 5: chromosome X showing the location of red and Green OPSIN.

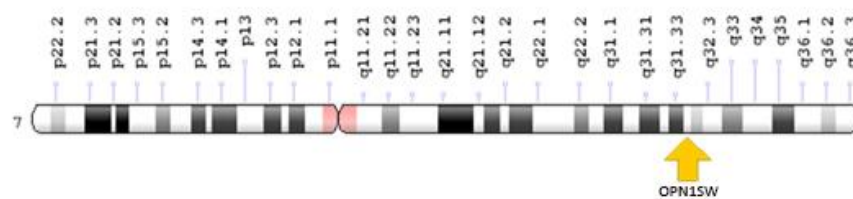

Figure 6: Chromosome 7 showing the location of Blue OPSIN.

### S-cones with rods surrounding our fovea perform our night vision

Figure 7 shows that the peak luminous efficiency of our eyes shifted towards the blue region at the scotopic mode of our vision (Arecchi et al. 2007).

Referring to Purkinje shift phenomena S-cones stay working at night while L and M-cones stop working at early dim light (Wade and Brožek 2008).

S-cones with rods perform together the shift of the peak luminous efficiency of our eyes towards 507nm region during the scotopic mode of our vision (Verdon et al. 1978).

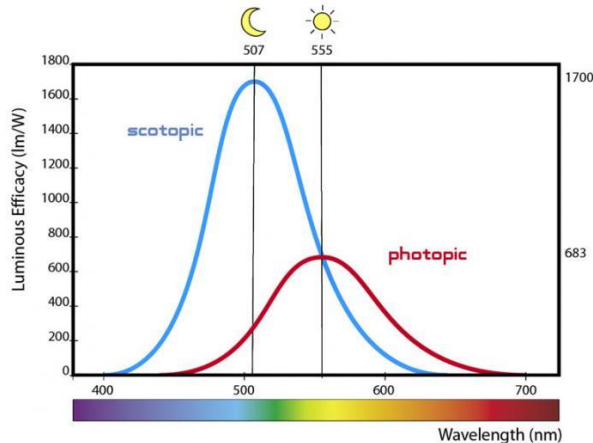

Figure 7: Referring to Purkinje shift phenomena S- cones stay working at night while L and M- cones stop at early dim light.

### REFERENCES

- Ahnelt, P., and H. Kolb. 2000. The mammalian photoreceptor mosaic-adaptive design. *Prog Ret Eye Res* 19: 711-777.
- Aldahir, S. 2013. <https://api.semanticscholar.org/CorpusID:54512063>.
- Arecchi, A. V., T. Messadi, and R. J. Koshel. 2007. *Field Guide to Illumination*. <https://doi.org/10.1117/3.764682>.
- Churchland & Ramachandran, 1996; Dennett, 1996; Pessoa, Thompson, & Noë, 1998; Spillmann & deWeerd.
- Gegenfurtner, K. R., and L. T. Sharpe. 2001. *Color vision: from genes to perception*. Cambridge University Press.
- Kulb, H., R. Nelson, E. Fernandez, and B. Jones (Eds.). 1995. *The Organization of the Retina and Visual System*.
- Kremers, J., R. C. Baraas, and N. J. Marshall (Eds.). 2016. *Human color vision*. Springer International Publishing. DOI:10.1007/978-3-319-44978-4.
- Malacara, D. 2011. *Color Vision and Colorimetry: Theory and Applications*, Second Edition. SPIE Press. <https://doi.org/10.1117/3.881172>.
- Nathans, J., D. Thomas, and D. S. Hogness. 1986. Molecular genetics of human color vision: the genes encoding blue green, and red pigments. *Science* 232-4747: 193-202.
- Verdon, W., and A. J. Adams. 1987. Short-wavelength-sensitive cones do not contribute to mesopic luminosity. *Journal of the Optical Society of America A* 4: 91-95.
- Wade, N. J., and J. Brožek. 2008. *Purkinje's vision. The Dawning of Neuroscience*. Lawrence Erlbaum Associates.
- Williamson, S. J., and H. Z. Cummins. 1983. *Light and Color in Nature and Art*. New York: Wiley.



# Impact of the color hue on the sparkle perception

Esther Perales <sup>1,\*</sup>, Andrea Morales <sup>1</sup>, Alejandro Ferrero <sup>2</sup>, Juan Carlos Fernández-Becáres <sup>3</sup>, Marjetka Milosevic <sup>3</sup>, Joaquín Campos <sup>2</sup>, Khalil Huraibat <sup>1</sup>, Jorge Pérez <sup>1</sup> and Valentín Viqueira <sup>1</sup>

<sup>1</sup> Departamento de Óptica, Farmacología y Anatomía, Universidad de Alicante, Alicante, Spain;

esther.perales@ua.es, andreamoralesr24@gmail.com, khalil.huraibat@ua.es, valentin.viqueira@ua.es

<sup>2</sup> Instituto de Óptica, Consejo Superior de Investigaciones Científicas, Madrid, Spain; alejandro.ferreo@csic.es, joaquin.campos@csic.es

<sup>3</sup> PPG Ibérica, Laguna de Duero, Valladolid, Spain; jcferrandez@ppg.com, milosovic@ppg.com

\*Corresponding author: esther.perales@ua.es

## Abstract

The objective of this work is the design and development of a psychophysical experiment to evaluate the impact of the color hue on the sparkle perception. A visual experiment was designed based on the triplet method. Samples are subsequently shown to the observers, one sample in the middle and two at each side, and the observer is forced to choose between the more similar sample (left or right) to the sample in the middle. Nine samples with three different hues and three different sparkle levels were selected. 19 observers participated in the experiment. The results were processed with a multidimensional scaling algorithm, with which mainly one significant dimension is obtained. The linear correlation coefficient between the obtained visual data (perceived sparkle) and the sparkle grade index (Sg) provided by the BYK-mac instrument is 0.855. According to this study, the hue of the absorption pigments in the samples would not impact on the sparkle perception.

**Keywords:** *visual texture, sparkle, psychophysical experiment, multidimensional scaling, special effect pigments*

## INTRODUCTION

Visual appearance is the way we perceive the objects around us. This perception depends on different factors, and it is processed in the brain based on cultural, social and personal factors. This perception determines the sensations that an object generates, such as desire or rejection. In addition, the visual appearance is related with the quality of an object, and therefore, it can be a critical factor that affects the purchasing decision of potential customers (Campos et al. 2017). Thus, it is essential for industries to control it. Nowadays, different attributes are defined to characterize the visual appearance of an object: color, gloss, translucency and texture. However, the progress for measuring each attribute is different for each one. The challenge is to be able to determine traceable and reproducible measurement scales for all the visual attributes.

On the other hand, in recent years, an effort has been done to achieve more attractive visual effects, such as the use of special effect pigments (Pfaff 2009; Klein et al. 2010). These pigments provide a strong change in color with respect to the angles of illumination and observation. In addition to this angular dependence for color, coatings with special effect pigments exhibit complex textures called sparkle and graininess. In particular, sparkle is defined as the presence of tiny bright points on a much darker background under directional illumination (ASTM 2017). On the other hand, the graininess is an irregular light/dark pattern under diffuse lighting conditions. The visual validation of these textures is of crucial importance for the quality control of these coatings, as well as for the visual discrimination between products. In previous works, preliminary measurement scales for sparkle and graininess were proposed to be standardized by the International Commission on Illumination (CIE) (Ferrero et al. 2020; Ferrero et al. 2021). These scales are correlated with the visual impression and traceable to standards of optical radiation metrology. These preliminary scales were obtained from the study of achromatic

samples, and the role played by the color hue of the absorption pigments is not considered. The impact of this hue on the sparkle perception is addressed here.

## **MATERIALS AND METHODS**

A visual experiment was designed to obtain the relative value of the perceived sparkle. To run the experiment, a set of samples was selected. This set was provided by PPG Iberica. It is composed of three groups of three samples (9 samples), where each group contains samples with absorption pigments with three different color hue (blue, green and red) (Figure 1). The structural parameters producing sparkle and graininess are controlled to provide three specific levels of sparkle. Silver dollar metallic pigments of different particle size (from D50 = 11  $\mu\text{m}$  to 34  $\mu\text{m}$ ) were used so that the samples in each group have the same average particle size. In addition, the ratio between absorption pigment to metallic pigment was constant (1:9) to be able to analyze exclusively the effect of the hue on the sparkle perception. A relative difference of sparkle lower than 12% was obtained within each group (using the Sg index from BYK-mac i multi-angle spectrophotometer), and a relative lightness lower than 13%, with the same instrument.



Figure 1: Set of samples used in the visual experiment where each group contains samples with absorption pigments with three different color hue (blue, green and red).

The visual experiment was based on the triplet method. In this way, triplets of samples are subsequently shown to the observers, one sample in the middle and two at each side, and the observer is forced to choose between two possible alternatives: the more similar sample (left or right) to the sample in the middle. A total of 84 different trials were established for each observer, which are all the combinations of the nine samples taken three at a time, with the sample at the center randomly selected. The sessions lasted approximately 30 minutes to avoid observer fatigue. To conduct the visual experiment the Byko-spectra effect light booth from BYK-Gardner was selected, since it includes well-defined directional light sources. For this experiment, the 45°:0° illumination/ observation geometry was selected. The illumination level on the samples was 2400 lux. The experiment was conducted in a dark room and at the beginning of each session, the observer remained 3 minutes with the cabinet light on to get adapted to the lighting conditions. All observers had good visual acuity with their optical compensation and good color vision assessed with the Ishihara test. The experiment involved 19 observers. In particular, 11 females and 9 males participated in this study with an age ranging from 20 to 61 years, with an average value of  $26 \pm 9$  years. Each observer performed three repetitions, therefore, a total of 4788 trials have been conducted. A multidimensional scaling analysis was applied to build a space where the pseudo-Euclidean distance between samples corresponded to the perceived sparkle distance. The set of dissimilarities is obtained for the triad comparison following the procedure described in Wills et al. (2009).

## RESULTS

The visual data obtained were processed using multidimensional scaling. The algorithm provides nine dimensions, of which only the first one provides really meaningful information to characterize the perceived sparkle. This dimension, called visual sparkle, is a relative scale and depend on the design of the visual experiments, but their tendency allows conclusions to be drawn on the sparkle perception. Once the visual sparkle was established, the observer variability associated with the visual experiment was analyzed based on these visual data. The analysis was focused on intra-variability (same observer, different repetitions) and inter-variability (responses of different observers). In both cases a variability of less than 10% was obtained by considering a variation coefficient defined as a percentage of the standard deviation with respect to the total range of the visual data (Figure 2). From this low value, it is possible to confirm that the visual data obtained can be considered as reliable to carry out its analysis.

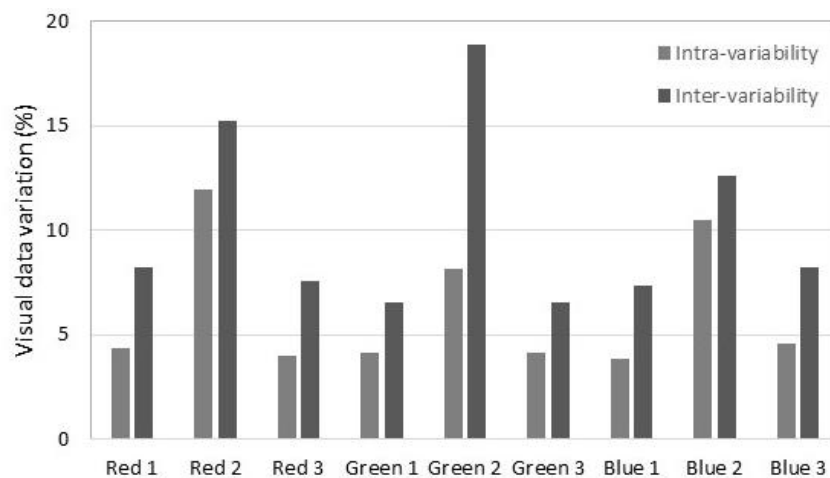

Figure 2: Intra- and inter-observer variation as a percentage of the standard deviation with respect to the total range of the visual sparkle.

Next, the instrumental and visual correlation of the sparkle is analyzed to check if there is consistency between the two magnitudes. The instrumental scale considered is that provided by the BYK-mac i instrument. Figure 3 shows the correlation between the sparkle grade (Sg) and the visual sparkle. A correlation coefficient equal to 0.8635 is obtained for a linear adjustment. Therefore, a good correlation is obtained by comparing visual and instrumental data.

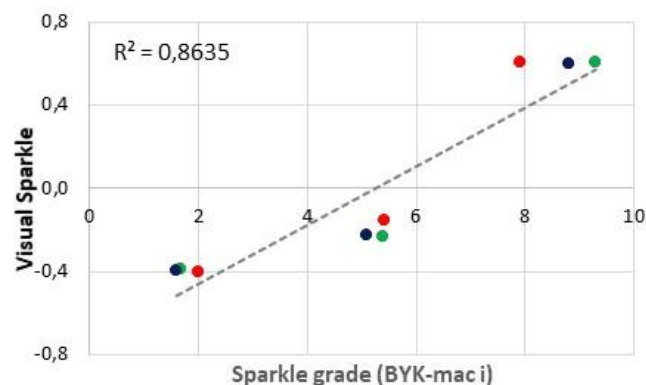

Figure 3: Linear relationship between the instrumental and visual data for the sparkle attribute.

As said before, three different metallic pigments of different particle size (7, 11 and 34  $\mu\text{m}$ ) was used to provide different levels of sparkle. Thus, the relationship between the particle size and the perceived sparkle was also studied. This relation and the linear fitting results are shown in Figure 4. Again, it was confirmed that the larger the average size of the sparkle pigments the more apparent the sparkle (Ferrero et al. 2013; Ferrero et al. (2021)). However, from this figure, there are no influence of the color hue of the absorption pigments on the sparkle perception. The perceived sparkle is approximately the same independently the color of the background. Although, if the intermediate level of sparkle is considered, a variation in the perceived sparkle is obtained.

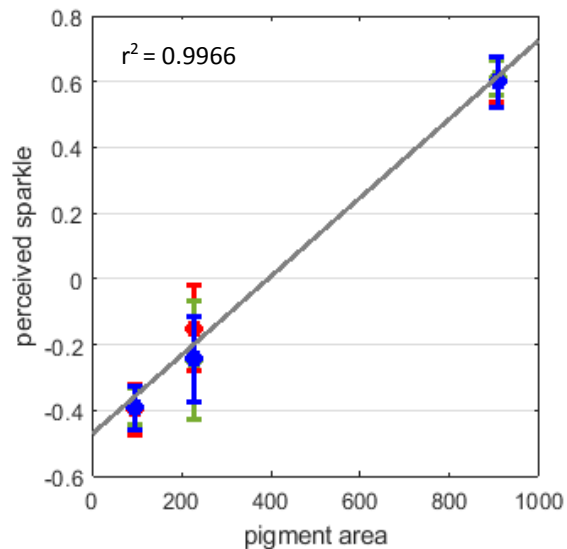

Figure 4: Linear relationship between the instrumental and visual data for the sparkle attribute.

The variation of the perceived sparkle within the same group is represented in Figure 5 by considering also the inter-variability associated with the visual experiment. The variation was calculated by subtracting the mean perceived sparkle value within the same group to each point. In general, there is no impact on the color hue of the absorption pigments on the perceived sparkle. However, a new experiment will be conducted to check the results for the metallic pigment with a pigment size of 11  $\mu\text{m}$ . For this experiment, nine different absorption pigments with different color hue by covering all the chromatic diagram will be selected to be combined with this metallic pigment in order to corroborate the influence of the color hue on the perceived sparkle.

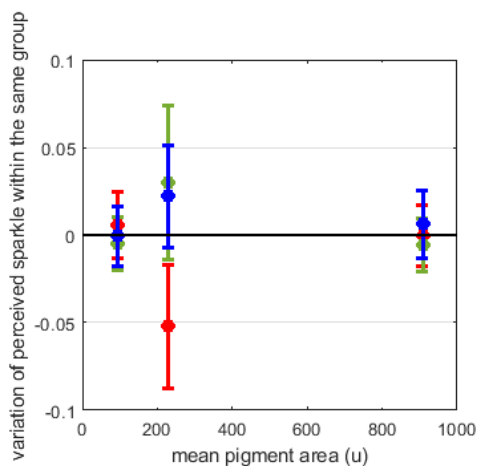

Figure 5: Variation of the perceived sparkle within the same group.

## CONCLUSION

A visual experiment was conducted to analyze the impact of the color hue on the sparkle perception. The variability results for the experiment are less than 10%, both for the intra- and inter-variability. Therefore, the visual experiment was well designed, and the visual data are reliable to be analyzed.

A visual scale for the sparkle attribute was obtained from the multidimensional analysis. This visual scale was compared with the sparkle grade index provided by the BYK-mac i instrument. The linear correlation coefficient between the obtained visual data (perceived sparkle) and the sparkle grade index (Sg) was close to 0.9, therefore, a good correlation was found. Finally, according to this study, the hue of the absorption pigments in the samples would not impact on the sparkle perception.

## ACKNOWLEDGEMENTS

The authors thank the Spanish Ministry of Economy and Competitiveness (RTI2018-096000-B-I00). The authors also thank the Ministry of Economy and Competitiveness for the pre-doctoral fellowship (FPIBES-2016-077325).

## REFERENCES

- ASTM E284-17, *Standard Terminology of Appearance* (ASTM International, West Conshohocken, PA, 2017).
- Campos, J., A. Ferrero, B. Bernad, J.L. Velázquez, E. Borreguero, A. Pons, and M.L. Hernanz. 2017. *Metrología de la apariencia visual. Congreso español de metrología*, Ponencia R22, San Fernando.
- Ferrero, A., J. Campos, A.M. Rabal, and A. Pons. 2013. A single analytical model for sparkle and graininess patterns in texture of effect coatings. *Optics express*, 21(22), 26812-26819.
- Ferrero, A., E. Perales, N. Basic, M. Pastuschek, G. Porrovecchio, A. Schirmacher, J.L. Velázquez, J. Campos, F.M. Martínez-Verdú, M. Smid, P. Linduska, T. Dauser, and P. Blattner. 2021. Preliminary measurement scales for sparkle and graininess. *Optics express*, 29(5): 7588–7600.
- Klein, G. A., and T. Meyrath. 2010. *Industrial color physics*. Vol. 154. New York: Springer.
- Maile, F.J., G. Pfaff, and P. Reynders. 2005. Effect pigments-past, present and future. *Progress in organic coatings*. 54(3): 150- 163.
- Wills, J., S. Agarwal, D. Kriegman, S. Belongie. 2009. Toward a perceptual space for gloss. *ACM Trans. Graph*, 28(4), 1–15.



# Multiangle visual validation of a physically based rendering of goniochromatic colors

Khalil Huraibat <sup>1,\*</sup>, Esther Perales <sup>1</sup>, Eric Kirchner <sup>2</sup>, Ivo Van der Lans <sup>2</sup>, Alejandro Ferrero <sup>3</sup> and Joaquín Campos <sup>3</sup>

<sup>1</sup> Department of Optics, Universidad de Alicante, Alicante, Spain; khalil.huraibat@ua.es, esther.perales@ua.es

<sup>2</sup> AkzoNobel Color Technology Group, Sassenheim, the Netherlands; eric.kirchner@akzonobel.com, Ivo.VanderLans@akzonobel.com

<sup>3</sup> Instituto de Óptica, Consejo Superior de Investigaciones Científicas, Madrid, Spain; alejandro.ferrero@csic.es, joaquin.campos@csic.es

\* Corresponding author: khalil.huraibat@ua.es

## Abstract

In this work, we evaluate the capability of a physically based rendering framework to reproduce the color flop phenomena of effect coatings through psychophysical tests. For this task, a digitally simulated lighting environment (the Byko-spectra effect light booth) is built to set up the visual tests, in which physical objects inside the physical light booth are visually compared to the rendered images of virtual objects inside the virtual light booth. Two separate visual tests were conducted by judging the color variation on flat and curved metallic painted panels. Fifteen metallic samples were selected in order to cover different hues and color flop values. Both tests show good intra- and interobserver reproducibility. We found that observers are more tolerant when judging curved samples; the acceptability of visualizing the sample colors over various angles was highest at 97% when using curved panels, versus 80% when flat panels were evaluated.

**Keywords:** *Goniochromatism, physically based rendering, visual assessments*

## INTRODUCTION

Rendering of gonio-apparent coatings is a very active hot topic since this type of coatings changes considerably its visual attributes such as color and texture with the illumination/viewing geometry. It is complex to characterize the appearance of these coatings due to the presence of special effect pigments, which can be metallic, interference or pearlescent pigments (Maile et al. 2005; Pfaff 2009; Klein and Meyrath 2010).

We recently developed a fully spectral rendering pipeline that we use for creating physics based-rendered images (Kirchner et al. 2019; Huraibat et al. 2021). The rendering is based on physical measurements, and it makes use of the spectral, spatial and angular distribution of the reflectance to improve the color reproduction accuracy. In addition, it allows real-time rendering and only requires modest hardware and display (iPad display computer). This framework is dedicated to rendering complex materials such as gonio-apparent coatings, gloss, sparkle, but it can also be adapted for rendering other textured materials. The rendering is based on the spectral reflectance and texture measurements of the BYK-mac i Multiangle Spectrophotometer. It takes as input the spectral, angular and spatial data, and also the physical models of the reflectance of these kinds of coatings (Kirchner et al. 2012; Kirchner et al. 2015; Ferrero et al. 2013).

In this work, we focus on evaluating the capability of the presented rendering framework to reproduce the color flop phenomena of effect coatings. Through psychophysical tests we evaluated the changes in color at different viewing geometries. For this task, a digitally simulated and well-defined lighting virtual environment, commonly used in industry and specifically for evaluating the appearance of gonio-apparent coatings (the Byko-spectra effect multi-directional light booth, Figure 1) is virtually built to set up visual tests, in which physical objects inside the physical light booth are visually compared to the rendered images of virtual objects inside the virtual light booth. Two



Multiangle visual validation of a physically based rendering of goniochromatic colors  
separate visual tests were conducted by judging the color variation on flat and curved metallic painted panels at different viewing geometries.



Figure 1: The Byko-spectra effect light booth (BYK-Gardner). The left image shows the inner structure and the rotation platform of the light booth.

In the current phase of the investigation, we focus on color aspects only and observers were asked to ignore other aspects of appearance. Fifteen metallic samples were selected in order to cover different hues and color flop values. Observers were asked to judge the perceived difference between the simulated and the physical panels, by using an evaluation score ranging from “0: No/hardly any difference” to “5: large difference, very bad match”.

In future work, we will extend the analysis to include accurate rendering of graininess and sparkle.

## **METHODS**

To achieve an accurate rendering of colors, it is important to have a well-characterized lighting environment. Therefore, we firstly built a well characterized virtual model of the Byko-spectra effect light booth. Six different models of the virtual light booth were built, one for each of the illumination-viewing geometries (45as-15, 45as15, 45as25, 45as45, 45as75 and 45as110) supported by the Byko light booth and the BYK-mac i instrument.

Two separate visual tests were conducted by judging the color variation on flat and curved metallic painted panels at different viewing geometries. Figure 2 shows a screenshot of the flat and curved panels simulation for the same physical sample as viewed on the iPad screen. The final rendered images on the iPad screen mimics the viewing slit on the physical light booth. The tablet is placed next to the viewing slit to allow a simultaneous visual assessment of both the virtual and the physical object under study. The evaluations were carried out in a dark room with two minutes for dark adaptation before starting each test. All the selected observers pass the Ishihara test and have normal color vision.

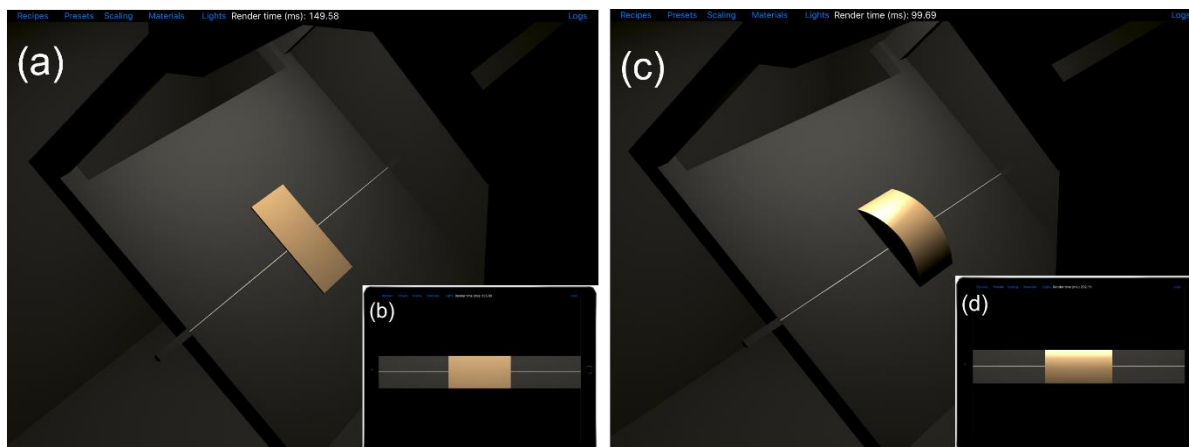

Figure 2: Screenshots of the real-time rendering on the iPad of color-only simulation of a metallic coating panel inside the virtual light booth. (a) shows a flat panel simulation at geometry 45as45. (c) shows a simulated curved panel. The observer view on the tablet is represented in the sub-images (b) and (d).

In the current phase of the investigation, we focus on color aspects only and observers were asked to ignore other aspects of appearance. Fifteen metallic samples were selected in order to cover different hues and color flop values. Observers were asked to judge the perceived difference between the simulated and the physical panels, by using an evaluation score ranging from “0: No/ hardly any difference” to “5: large difference, very bad match” as shown on Table 1.

Score	Description
0	No / Hardly any difference
1	Small, negligible difference
2	Difference visible but still acceptable
3	Difference visible, doubtful match
4	Difference clearly visible, not correct match
5	Large difference, very bad match

Table 1: Descriptions of scores for the Scoring method.

The first test addressed color matching of flat panels, where a total of 60 different judgements were performed at three different geometries (as25, as45, as110). An additional judgement of the total color travel is also performed after judging the previously mentioned three geometries. For the total color flop evaluation, observers continuously swapped between the renderings of each panel at different angles, thus simulating sweeping in the Byko-spectra effect light booth. The evaluations were performed by 5 different observers and included repetitions.

The second test was carried out by evaluating 3D objects. Observers evaluated the perceived color difference for curved and color-only rendered images by comparing them to the curved physical panels. A curved magnetic platform was used, and the samples were placed on top of it to mimic 3D objects. 8 different observers judged the color matching at four different geometries (as-15, as25, as45 and as110) for each of the 15 samples, i.e., 60 visual judgments in total.

## RESULTS

The rendering tool is well able to reproduce the color flop of effect coatings as seen in Figure 3. The color change is easily perceived, and the panels are getting darker when moving from small (as25) to large aspect angles.

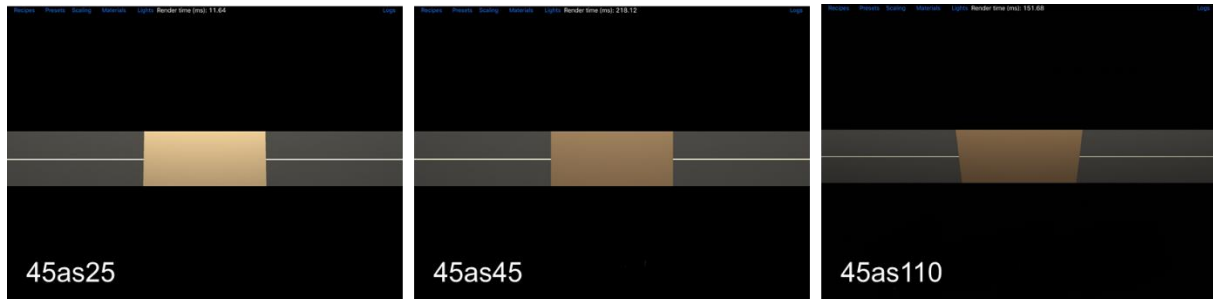

Figure 3: Screenshots of the rendering on the iPad of color-only simulation of a flat metallic coating panel inside the virtual light booth at three different geometries.

In these two visual tests, we evaluated the capability of the rendering framework to reproduce the color flop effect of metallic coatings. A set of 15 metallic samples were selected. In the first test we evaluated the perceived color difference on flat and color-only rendered images against the physical flat metallic panels. We studied the intra-observer repeatability and the inter-observer reproducibility. We found that the intra-observer repeatability is 0.4 units, covering less than 7% of the total scale of 6 steps, and the inter-observer reproducibility is 0.78 units, thus covering 13% of the total scale. Both values are small enough to be smaller than the quantification limit of the scoring method. The inter-observer reproducibility is higher than the intra-observer reproducibility, which is expected since observers are more likely to agree with themselves than with others.

In the second test, observers evaluated the perceived color difference for curved and color-only rendered images by comparing them to the curved physical panels. The intra-observer repeatability for this test is 0.61 units, covering 10% of the total scale of 6 steps, and the inter-observer reproducibility is 0.68 units, thus covering 11% of the total scale. Both variabilities are similar to Each OTHER and smaller than the quantification limit of the scoring method.

For the evaluation of flat panels, the average observer accepted the match for 12 of the 15 samples (average acceptance: 80%), while the average observer accepted 14 from the 15 samples when curved panels are evaluated. Therefore, we find an increased average acceptance of 93% for curved samples as compared to 80% when flat panels are evaluated. From these results we conclude that observers are more tolerant for rendering the color flop of curved 3D objects than for flat objects, which can be related to the gradual variation in appearance of 3D objects and its complexity. This could be due to the fact, that a curved gonio-apparent surface includes various geometries at the same time and the resulting visual impression is continuous and much more realistic than the impression generated by a single geometry at once.

## CONCLUSION

The rendering approach was found to well reproduce the color shift of effect coatings. Our rendering approach shows a high average value for the acceptance percentage, when visually assessing both flat and curved panels. We also found that observers are more tolerant when judging curved sample, with an average acceptance of 93% compared to the 80% for flat samples. This could be due to the

fact that a curved gonio-apparent surface includes various geometries at the same time and the resulting visual impression is continuous and much more realistic than the impression generated by a single geometry at once.

In future work, we will extend our investigation to include accurate rendering of sparkle and graininess of effect coatings.

## **ACKNOWLEDGEMENTS**

The authors thank the Spanish Ministry of Economy and Competitiveness (RTI2018-096000-B-I00). The authors also thank the Ministry of Economy and Competitiveness for the pre-doctoral fellowship (FPIBES-2016-077325).

## **REFERENCES**

- Pfaff, G. 2009. *Special Effect Pigments, in High Performance Pigments*. Wiley-VCH Verlag GmbH & Co. KGaA, 75-101.
- Maile, F. J., G. Pfaff, and P. Reynders. 2005. Effect pigments—past, present and future. *Progress in organic coatings* 54(3): 150-163.
- Klein, G. A., and T. Meyrath. 2010. *Industrial color physics*. Vol. 154. New York: Springer.
- Kirchner, E., I. Van der Lans, P. Koeckhoven, K. Huraibat, F. M. Martínez-Verdú, E. Perales, A. Ferrero, and J. Campos. 2019. Real-time accurate rendering of color and texture of car coatings. In: *Proceedings of IS&T International Symposium on Electronic Imaging*, 076.1-5, <https://doi.org/10.2352/ISSN.2470-1173.2019.14.COLOR-076>.
- Huraibat, K., E. Perales, E. Kirchner, I. Van der Lans, A. Ferrero, and J. Campos. 2021. Visual validation of the appearance of chromatic objects rendered from spectrophotometric measurements. *JOSA A* 38(3): 328-336. <https://doi.org/10.1364/JOSAA.413890>.
- Kirchner, E., and W. Cramer. 2012. Making sense of measurement geometries for multi-angle spectrophotometers. *Color Research & Application* 37(3): 186-198.
- Kirchner, E., I. Van der Lans, E. Perales, F. Martínez-Verdú, J. Campos, and A. Ferrero. 2015. Visibility of sparkle in metallic paints. *JOSA A* 32(5): 921-927.
- Ferrero, A., J. Campos, A. M. Rabal, A. Pons. 2013. A single analytical model for sparkle and graininess patterns in texture of effect coatings. *Optics express* 21(22): 26812-26819.
- Huraibat, K., V. Perales, E. Viqueira, E. Kirchner, I. Van der Lans, A. Ferrero, and J. Campos. 2019. Byko-Spectra effect light booth simulation for digital rendering tool. In: *Proceedings of the XII Congreso Nacional del Color*, R. B. Román et al., Editors. Linares, 45-48.



# The Locus Filter

Rada Deeb <sup>1,\*</sup> and Graham Finlayson <sup>1</sup>

<sup>1</sup> School of Computing Sciences, University of East Anglia, Norwich NR4 7TJ, UK; r.deeb@uea.ac.uk

<sup>2</sup> School of Computing Sciences, University of East Anglia, Norwich NR4 7TJ, UK; g.finlayson@uea.ac.uk

\* Corresponding author: r.deeb@uea.ac.uk

## Abstract

We study the design of a particular filter for digital photography, that we call the Locus Filter. It is built in a way that guarantees that the light in the scene after applying the filter stays on the Planckian locus. In this paper we provide a physical basis for designing such a filter based on the Wien approximation of Planck's law. While locus filtered Planckian lights are on the locus, the amount they shift depends both on the locus filter and the colour temperature of the light. In experiments we show that real lights shift more or less as if they were Planckian in terms of the changes in their correlated colour temperatures.

**Keywords:** *Filter design, Colour temperature, Wien approximation, Planckian locus*

## INTRODUCTION

Coloured filters have been historically used in photography to modulate the colour of the prevailing illuminant. A filter is usually a piece of coloured glass (or another substrate) that is placed in front of the lens of the camera leading to a change in the colours of the scene in the acquired photo. One of the main goals of using these filters is to change the way the camera sees the light which depends on the spectral properties of the filter used. As an example, we might use a 'warm' filter when taking a picture under a cool light to render the effective illuminant colour neutral.

Some research in the literature focused on filter design for illuminant change, they attempt to design a particular filter that changes a specific illuminant in the scene to another chosen one. Gage (1933) presented a study of the properties of a filter that brings a Planckian illuminant with one colour temperature to a another specific one. Weaver (1936) also considered the design of a filter that converts lights from one color temperature to another. In complementary work, Estey (1936) studied the properties of color temperature change for some commercially available filters. The principal application of these approaches was to change the colour temperature for colour measurement. More recent research has focused on the design of filters for other tasks in image processing or digital photography. In Finlayson, et al. (2018) filters were designed to make the camera sensors more colorimetric. Specific colour filters have also been shown to be useful in the estimation of the colour of the light and the determination of where lights change in an image, Finlayson, et al. (2005) and Fredembach and Finlayson (2008).

In this paper, we propose that it would be a useful property if a coloured filter is guaranteed to map all lights from one position (color temperature) on the locus to another. That is, we wish to avoid the circumstance where a coloured filter might for example, make a Planckian light (yellows, whites and blues) slightly greenish. We show that it is indeed possible to design a filter that guarantees that the resulting light stays on the Planckian locus. We call this filter "the locus filter", and present a physical basis for the design of a locus filter. Significantly, the locus filters are the only ones that have the property that they map Planckian lights to other lights that are also on the Planckian locus.

A Planckian light, by definition, is dependent on a single number, the colour temperature (in Kelvin). As we move from 3000 to 5000 to 10000 Kelvin the corresponding Planckian light 'looks' respectively yellowish, to whitish to bluish. Our locus filter maps a given input colour temperature to another (the formulas are given later) and this mapping is non-linear. The analogous correlated colour temperature

(CCT) is often used as a measure of the colour temperature of real lights. For a real light we calculate the CCT before and after application of the locus filter. Experiments demonstrate that the CCTs of real lights shift very similarly to the corresponding Planckian.

The rest of this paper is organized as follows, we will first give the physical and mathematical basis for the design of the locus filter. We will then study the nature of temperature change and how well it applies to real lights.

### THE LOCUS FILTER MODEL

Colours in a Lambertian scene can be described with the Image formation equation. Let the surface spectral reflectance be  $S(\lambda)$ , the spectral power distribution of illuminant be  $E(\lambda)$ , and the camera sensitivities be  $Q_k(\lambda)$ , (where  $k = R, G, B$  for a trichromatic camera), then sensors responses  $\rho_k$  can be written as:

$$\rho_k = \int_{\omega} Q_k(\lambda)S(\lambda)E(\lambda)d\lambda \quad (1)$$

Ignoring complexities such as interreflections, when a coloured filter is put in front of the lens of the camera the filtered colours  $\rho_k^F$  can be written as:

$$\rho_k^F = \int_{\omega} Q_k(\lambda)S(\lambda)F(\lambda)E(\lambda)d\lambda, \quad (2)$$

where  $F(\lambda)$  defines the filter spectral transmittance.

We are interested in designing a filter that shifts a Planckian illuminant towards another Planckian illuminant. In order to get the radiation of a black body emitted under a specific temperature Planck's law can be used. The illuminant radiation,  $E$ , which is a function of temperature  $T$ , and wavelength,  $\lambda$ , approximated by Planck's law is written as:

$$E(\lambda, T) = Ic_1\lambda^{-5}(e^{\frac{c_2}{T\lambda}} - 1)^{-1}, \quad (3)$$

where  $c_1$  and  $c_2$  are constants equal to  $3.74183 \times 10^{-16} \text{ Wm}^2$  and  $1.4388 \times 10^{-2} \text{ mK}$ , respectively. For Planckian lights with temperatures between 2500K and 10000K (the typical range of most day and artificial lights), the Wien approximation of Planck's law can be used (without significant loss of accuracy):

$$E(\lambda, T) \approx Ic_1\lambda^{-5}e^{-\frac{c_2}{T\lambda}} \quad (4)$$

Now, let us focus on the problem at hand i.e. designing a filter that maps one light to another. Suppose we have a Planckian illuminant with a temperature  $T_1$ , and that after applying the filter we would like to obtain another Planckian illuminant with a temperature  $T_2$ . By dividing the spectra of these two illuminants provided by Equation (4) we obtain a filter function  $Tr(\lambda, T_f)$  that has the desired property:

$$Tr(\lambda, T_f) = e^{-\frac{c_2}{T_f\lambda}} \quad (5)$$

The  $T_f$  parameter is called **the locus filter-temperature (LFT)**, The LFT is equal to:

$$(6)$$



$$T_f = \frac{1}{\frac{1}{T_2} - \frac{1}{T_1}}$$

We prove elsewhere that the form of the filter equation is unique. However, there are a set of locus filters with varying LFTs that have the desired property of shifting a Planckian light on the Planckian locus. Clearly, from Equation 6, given a pair of Planckian lights defined by temperatures  $T_1$  and  $T_2$ , the LFT,  $T_f$ , is not uniquely defined (by the pair). That is there are many pairs of temperatures that can lead to the same LFT. Also following from Equation 6, the LFT can be negative (but we do not consider this case here).

Let us now calculate the product of the filter  $Tr(\lambda, T_f)$  with a third light that has a temperature  $T_3$  to make a new light spectrum  $E'(\lambda)$ :

$$E'(\lambda) = E(\lambda, T_3)Tr(\lambda, T_f) = I c_1 \lambda^{-5} e^{-\frac{c_2}{T_3 \lambda}} e^{-\frac{c_2}{T_f \lambda}} = I c_1 \lambda^{-5} e^{-\frac{c_2}{T' \lambda}} \quad (7)$$

Clearly,  $E'(\lambda)$  lies on the (Wien definition of the) Planckian locus with temperature  $T'$  calculated as:

$$T' = \frac{1}{\frac{1}{T_f} + \frac{1}{T_3}} \quad (8)$$

Evidently, the resulting temperature has a non-linear relationship with the initial temperature and the locus filter temperature. We call any filter designed according to Equation (5) a Locus filter.

Compared to the prior art, this paper makes two contributions. First, serendipitously, we show that the formalism of Gage (1933) actually produces a filter of the form we seek i.e. a filter that maps all Planckian lights to another Planckian (even though in his application he sought to move one specific light to another). Second, according to Equation (8) we have an explicit formula for calculating the colour temperature of a new light for a given locus filter.

In the following section, we will analyze this relationship and will investigate how this change of temperature applies when using real illuminants instead of Wien approximated ones.

## EXPERIMENTS

### FILTERING PLANCKIAN LIGHTS

In the last section, we demonstrated that filtered lights also lie on the Planckian locus. However, the change of temperature after applying the filter depends on both the initial temperature of the Planckian light and LFT temperature of the applied filter (see Equation 8). Table 1 shows the change of temperature when applying filters with a locus filter temperature (LFT) of 5000, 7500 and 10000 to different Planckian illuminants. See, Equation 6 for definition of LFT.

From Table 1 we see that all three locus filters we consider have the property of making the illuminant warmer<sup>1</sup>. However, the degree of the shift is dependent on the LFT  $T_f$  (see Equation 8). Moreover, it is evident that the cooler the light (higher temperature), the more it is shifted by the locus

---

<sup>1</sup> To have a filter that makes illuminant colours cooler we need a negative LFT.

filter. Notice that the lower the LFT the larger the shift in color temperature (using the corresponding filter).

Output light after filtering by a Locus filter			
Input Light Temperature	$T_f = 5000$	$T_f = 7500$	$T_f = 10000$
4000K	2222K	2609K	2857K
6000K	2727K	3333K	3750K
8000K	3077K	3871K	4444K
10000K	3333K	4286K	5000K

Table 1: The change of temperature after applying the locus filter. The input light ranges from 4000 to 10000K, and the LFT  $T_f$  ranges from 5000 to 10000.

In Table 1, we see that 4000K light filtered by locus filter with LFT=5000 shifts to 2222K (i.e. a colour temperature change of 1778).

### Filtering real lights

Let us quantify the change of correlated color temperature (CCT) using a locus filter. For lights we use the 102 illuminants compiled by Barnard et al. (2002) (this set includes many artificial lights) and the set of 99 measured daylight in Granada (Hernandez-Andres et al. (2001)). The CCT is the temperature of the Planckian illuminant giving the closest perceived color to the real illuminant. Interestingly, how to calculate the CCT is still an active area of research. Here, we used McCamy (1992) cubic approximation to obtain the CCT from the x and y chromaticity coordinates of the light.

Our hypothesis is that the change of CCT after applying a filter is consistent to the change of colour temperature when the same filter is applied to a Planckian illuminant whose temperature is equal to that of the real light. In order to confirm this hypothesis, we compare the CCT of a filtered real light with the colour temperature of a filtered Planckian light whose temperature is equal to the CCT of the real light. Suppose a real light with a correlated colour temperature  $CCT_1$ , and its Planckian equivalent whose color temperature  $T_1 = CCT_1$ . By applying a locus filter to the real light, we obtain a new light with  $CCT_1^{\text{filtered}}$ . Applying the filter to the Planckian we – by construction – generate a second Planckian light with temperature  $T_1^{\text{filtered}}$ . We would like the change in CCT to be close to the change in corresponding temperature of the Planckian and its filtered counterpart. The absolute temperature error is defined as  $|CCT_1^{\text{filtered}} - T_1^{\text{filtered}}|$  and the relative temperature error is equal to  $|CCT_1^{\text{filtered}} - T_1^{\text{filtered}}| / T_1^{\text{filtered}}$ .

For our illuminant dataset we take all our lights and apply a locus filter with an LFT of 5000. For the Barnard and Grenada datasets we calculate the shift in CCT and report the mean shift in the first row of Table 2. For both sets of lights, the average CCT shift is more than 3000K. In the next two rows we report the mean absolute temperature error and the mean relative temperature error. Table 2 reports also the max and the 95<sup>th</sup> percentile relative temperature error. Broadly, we see that the change in CCT of real lights mirrors the change in Planckian temperature. We observe that the set of Barnard et al. (2002) has higher errors and we found that this is due to the spikiness of some of the artificial lights.

Lights set	Barnard et al. (2002)	Hernandez-Andres et al. (2001)
Mean CCT shift	3217K	3412K
Mean absolute temperature error	130K	73K
Mean relative temperature error	0.054	0.025
Max relative temperature error	0.237	0.197
95 <sup>th</sup> % relative temperature error	0.044	0.018

Table 2: The absolute and relative temperature errors for filtered real lights compared to filtered Planckian counterparts (both filtered with a locus filter with LFT=5000).

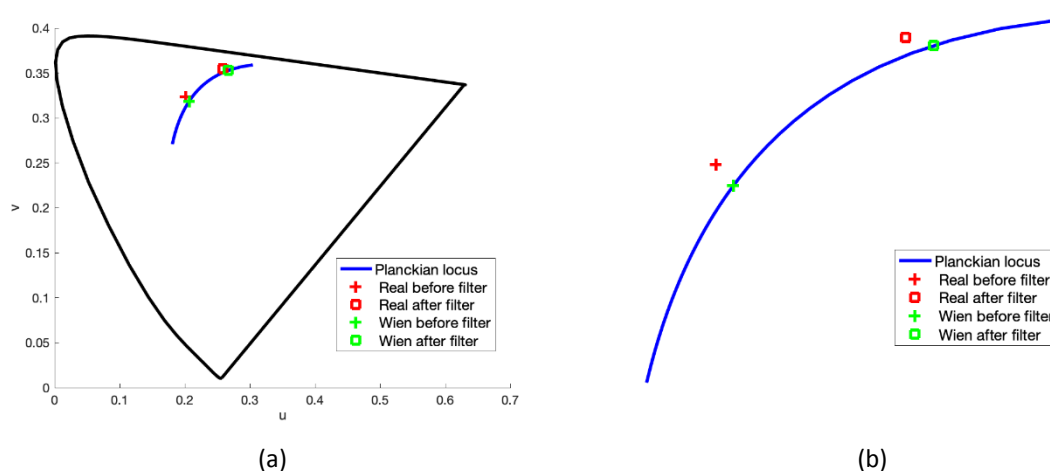

Figure 2: The change in color temperature between a real light whose temperature is 5450K, and its Planckian equivalent applying a locus filter with an LFT of 5000. (a) Change of temperature in  $u, v$  chromaticity diagram. (b) Zooming in.

Figure 2 shows an example of the temperature shift in the  $u, v$  chromaticity diagram after applying the locus filter of a filter temperature of 5000 on a light with a CCT of 5450K and on its equivalent Planckian light. We can observe that the shifts are consistent between real and Wien approximated lights.

## CONCLUSION

The locus filters, designed in this paper, have the property that they map all Planckian lights from one temperature to another. Each locus filter is defined by a single parameter that we called the locus filter-temperature, or LFT. Experiments demonstrated that the locus filter shifts illuminant toward a warmer colour but the magnitude of this shift is related to the illuminant colour temperature and the filter temperature. The correlated color temperature of real lights shifts analogously to the corresponding Planckian lights.

## ACKNOWLEDGEMENT

This research is supported by EPSRC grant EP/S028730/1.

**REFERENCES**

- Barnard, K., V. Cardei, and B. Funt, B. 2002. A comparison of computational color constancy algorithms. I: Methodology and experiments with synthesized data. *IEEE transactions on Image Processing*, 11(9), 972-984.
- Estey, R. S. 1936. The selection of color temperature altering filters. *JOSA*, 26(7), 293-297.
- Finlayson, G. D., S. D. Hordley, and P. Morovic. 2005. Colour constancy using the chromagenic constraint. *2005 IEEE Computer Society Conference on Computer Vision and Pattern Recognition (CVPR'05)*. 1, pp. 1079-1086. IEEE.
- Finlayson, G. D., Y. Zhu, and H. Gong. 2018. Using a simple colour pre-filter to make cameras more colorimetric. In: *Color and Imaging Conference*. Society for Imaging Science and Technology: 182-186.
- Fredembach, C., and G. Finlayson. 2008. Bright chromagenic algorithm for illuminant estimation. *Journal of Imaging Science and Technology*, 52(4), 40906-1.
- Gage, H. 1933. Color filters for altering color temperature. Pyrometer absorption and Daylite glasses. *JOSA*, 23(2): 46-54.
- Hernandez-Andres, J., J. Romero, J.L. Nieves, and R. L Lee. 2001. Color and spectral analysis of daylight in southern Europe. *JOSA A*, 18(6): 1325-1335.
- McCamy, C. S. 1992. Correlated color temperature as an explicit function of chromaticity coordinates. *Color Research & Application*, 17(2): 142-144.
- Weaver, K. 1936. The Calculation of Filters for Color Temperature Conversion. *JOSA*, 26(9), 339-342.

1 COLOR AND MEASUREMENT INSTRUMENTATION	2 <b>COLOR AND DIGITAL</b>	3 COLOR AND LIGHTING	4 COLOR AND PHYSIOLOGY
5 COLOR AND PSYCHOLOGY	6 COLOR AND PRODUCTION	7 COLOR AND RESTORATION	8 COLOR AND BUILT ENVIRONMENT
9 COLOR AND DESIGN	10 COLOR AND CULTURE	11 COLOR AND EDUCATION	12 COLOR AND COMMUNICATION MARKETING

## 2 COLOR AND DIGITAL

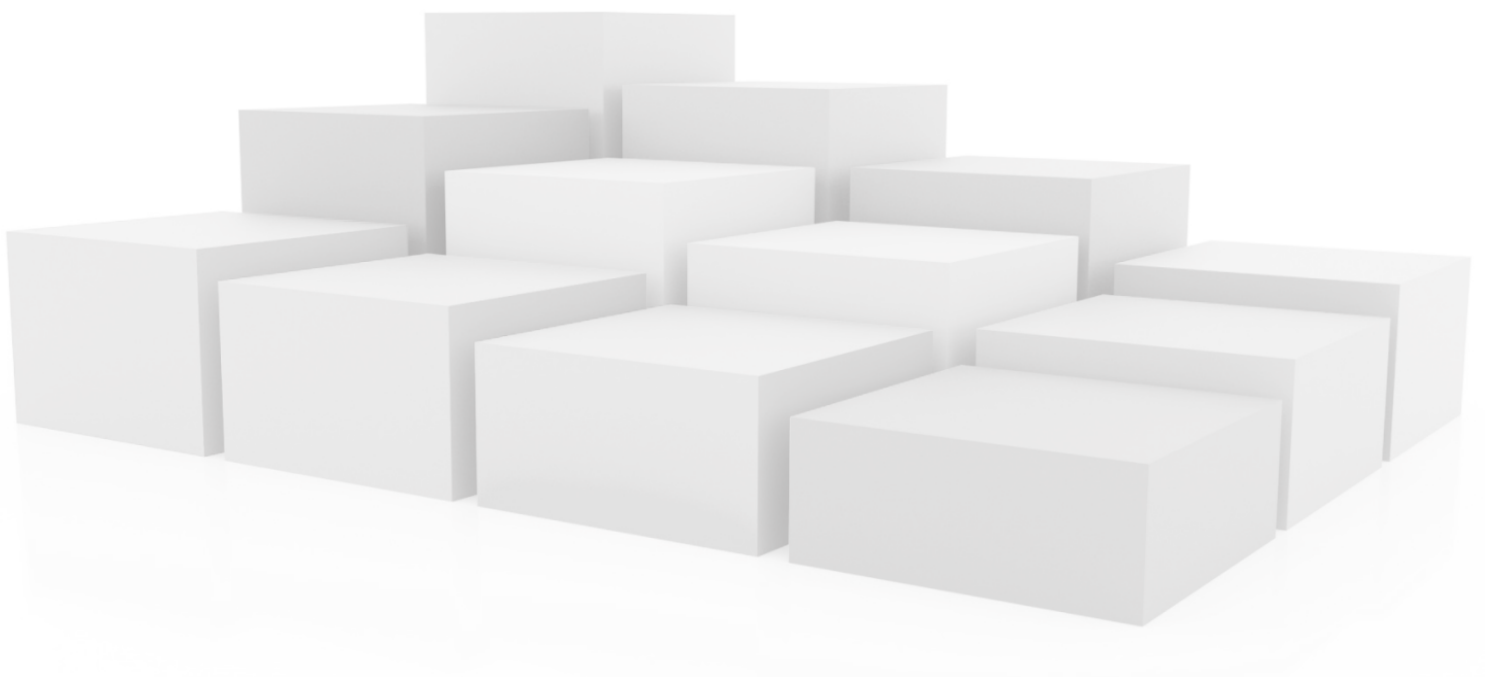

AIC 14<sup>th</sup> Congress Milano 2021 - August 30<sup>th</sup>– September 3<sup>rd</sup> 2021



# HDR image quality evaluation for mobile displays

Yiming Huang <sup>1</sup>, Haisong Xu <sup>1,\*</sup> and Zhengnan Ye <sup>1</sup>

<sup>1</sup> State Key Laboratory of Modern Optical Instrumentation, College of Optical Science and Engineering, Zhejiang University, Hangzhou 310027, China; ymhuang9783@gmail.com, chsxu@zju.edu.cn, yezhnan@163.com

\* Corresponding author: chsxu@zju.edu.cn

## Abstract

A series of psychophysical experiments were carried out on three OLED-based mobile displays from different manufacturers to evaluate the perceived image quality in high dynamic range (HDR) mode by a panel of 15 observers. Eight perceptual attributes, i.e., naturalness, colorfulness, brightness, contrast, sharpness, gradation, preference, and overall image quality, were investigated via rank order method. The experimental results demonstrate that a wide color gamut helps the perception of colorfulness, while higher peak luminance would not mean better performance on brightness and contrast. The analysis of variance (ANOVA) indicates that there are no significant differences among the overall image quality of the three mobile devices.

**Keywords:** *image quality, mobile display, psychophysical evaluation, OLED, high dynamic range*

## INTRODUCTION

In response to the call of displaying contents with a higher dynamic range, the high dynamic range (HDR) displays (Hammer 2014) were developed. Differing from the traditional standard dynamic range (SDR) displays, HDR displays generally provide more details of the images due to their advantages of high peak luminance and low black luminance (Ye et al. 2017). With the development of display technology, as indispensable devices in our daily life, more and more smart-phones support HDR display mode. In this context, a variety of color management strategies have been implemented by different manufacturers, resulting in diverse visual perceptions of terminal display devices.

In this paper, a series of psychophysical experiments were carried out on three latest OLED-based mobile displays in HDR mode under 500lx lighting level, corresponding to the typical indoor environment. Eight perceptual attributes, i.e., naturalness, colorfulness, brightness, contrast, sharpness, gradation, preference, and overall image quality (IQ), were evaluated via rank order method to investigate the image quality performance among the three mobile displays as well as the factors that affect the HDR image quality of smart-phone displays.

## EXPERIMENTS

### Physical measurement

The basic physical parameters of the three OLED-based smart-phone display panels are listed in Table 1.

	Panel-1	Panel-2	Panel-3
Pixel resolution	2340×1080	2400×1080	2436×1125
Pixels per inch (PPI)	389	409	463
Peak luminance (cd/m <sup>2</sup> )	586.82	741.72	727.37
CCT (K)	7700	8177	6700

Table 1: The basic physical parameters of the three OLED-based smart-phone display panels.



It can be seen that Panel-2 has the highest peak luminance and the highest correlated color temperature (CCT), while the peak luminance of Panel-1 is the least. And Panel-3 has the highest pixels per inch (PPI). Figure 1 plots the color gamuts of the three test displays along with sRGB and DCI-P3 in CIE1976  $u'v'$  diagram, indicating that Panel-1 has the largest color gamut. The gamut area ratios of Panel-1, Panel-2, and Panel-3 are 137.93%, 129.92%, and 127.62%, respectively, with sRGB as reference, and 109.83%, 103.45%, and 101.62%, respectively, with DCI-P3 as reference.

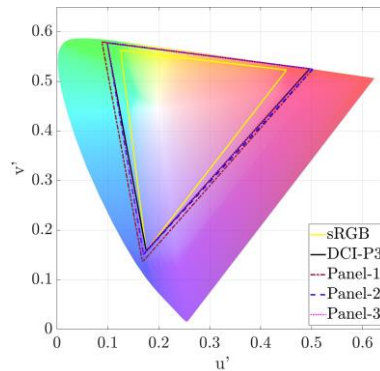

Figure 1: The color gamuts of the three smart-phone displays in CIE1976  $u'v'$  diagram.

The electro-optical transfer function (EOTF) of the three panels in HDR mode along with SMPTE ST 2084 (SMPTE 2014) are shown in Figure 2. The normalized EOTF of Panel-3 is cut-off at the peak luminance for each channel, while different roll-off algorithms are found to be implemented to Panel-1 and Panel-2.

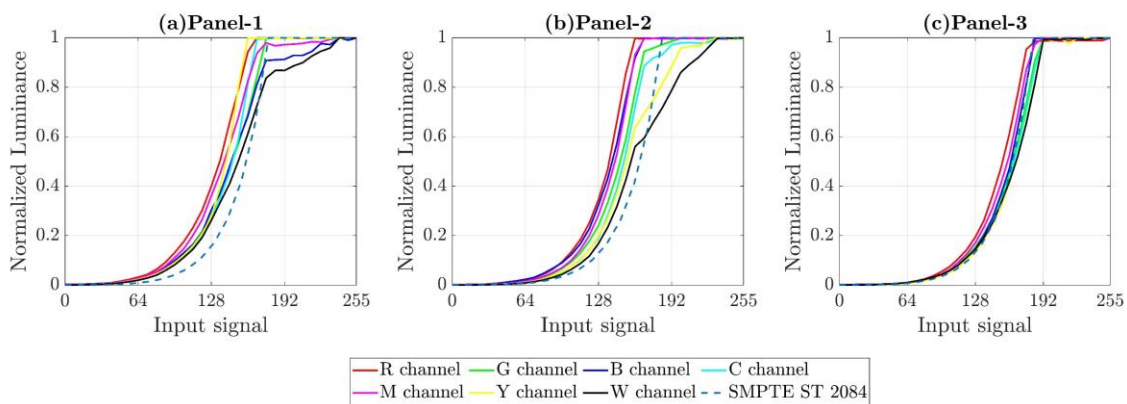

Figure 2: The EOTFs of the three smart-phone panels in HDR mode.

### Psychophysical Procedures

A panel of 15 observers, including 7 females and 8 males, participated in the visual experiments via the psychophysical method of rank order. For each perceptual attribute, 6 test images from different categories were evaluated. All the test images were resized to ensure that all the images shown on the three smart-phone displays had the same physical size. Figure 3 illustrates the setup of the psychophysical experiments. Two lighting modules with the CCT of about 5600K were symmetrically arranged to the test displays to provide uniform illumination as far as possible. The test displays were placed side by side upon a 45° neutral gray platform and each was covered by a gray mask to avoid them being identified by the observers. The viewing distance was set at 30 cm by a frontal bracket, resulting in the view angles of 40.9° × 16.9° for the three smart-phones. The duration of the experiment

for each observer was approximately 40 mins, including a 2-min dark adaptation and 1-min lighting adaptation. In total, 2160 judgments were collected in the visual experiments, i.e., 3 smart-phones × 8 attributes × 6 images × 15 observers.



Figure 3: The setup of the psychophysical experiments.

The definitions of the evaluated perceptual attributes are as follows.

**Naturalness:** the degree of correspondence between the visual representation of the image and knowledge of reality as stored in memory (Gong 2012).

**Colorfulness:** the saturation of the colors in the image.

**Brightness:** a visual perception according to the image appears to emit more or less light.

**Contrast:** the overall distinguishability of the light and dark regions of the image.

**Sharpness:** how clear to recognize the details of the image such as lines, edges, and characters, similar to clearness.

**Gradation:** the details of the highlights and dark regions of the image.

**Preference:** the extent of the image being preferred by the observers.

**Overall image quality (IQ):** the integrated perception of the overall quality of the image, including all the above perception attributes.

## RESULTS AND DISCUSSION

For each IQ attribute, the interval scale values are demonstrated in Figure 4, which are obtained by adopting Case V of Thurstone’s law of comparative judgments (Thurstone 1927).

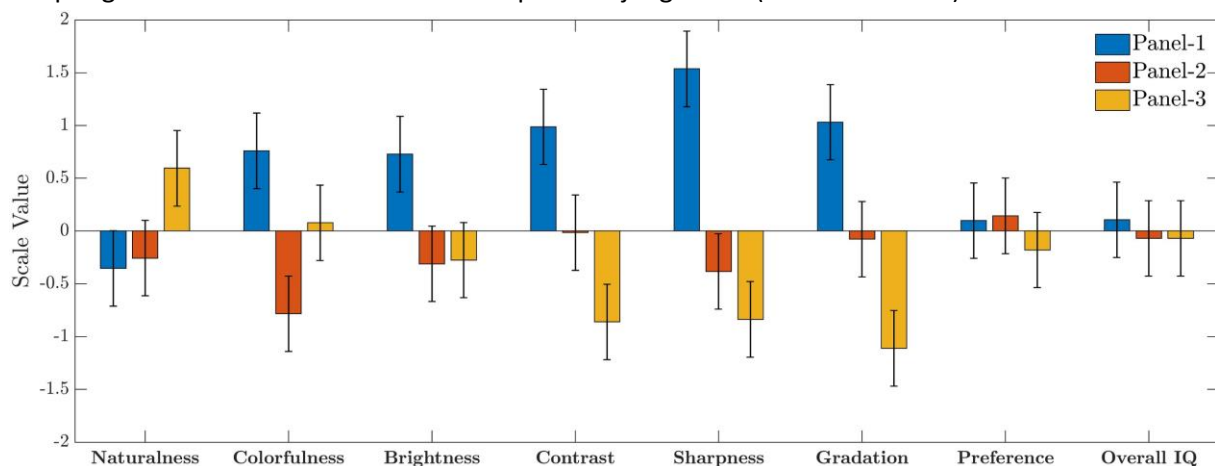

Figure 4: The scale values of the three test displays for each perceptual attribute.

Panel-1 presents a higher scale value in the perceptions of brightness and contrast compared to Panel-2 and Panel-3, although it has the lowest peak luminance. That is because HDR imaging is not attempting to make the whole image brighter but aims to provide additional brightness headroom for

highlight detail. In addition, it can be seen from Figure 2 that the normalized EOTFs of Panel-1 and Panel-2 are above the PQ curve with the normalized input data being below 0.6, which would increase the brightness of the image. The sharpness perception of Panel-1 is the highest, which is consistent with the perceptions of brightness and contrast. The experimental results of gradation indicate that the image detail of Panel-3 is not enough, which is caused by the direct "clipping" of the EOTF of Panel-3 in the highlight region, as shown in Figure 2(c).

The colorfulness perception of Panel-1 is again the highest among the three displays due to its wide color gamut. As depicted by the Hunt effect (Fairchild 2013), the outstanding performance of brightness of Panel-1 also helps the performance of colorfulness. According to the comments from the observers, Panel-1 and Panel-2 are over-saturated and under-saturated, respectively, which makes their images look "unnatural".

	<b>Naturalness</b>	<b>Colorfulness</b>	<b>Brightness</b>	<b>Contrast</b>
P value	0.033	0.000	0.039	0.000
	<b>Sharpness</b>	<b>Gradation</b>	<b>Preference</b>	<b>Overall IQ</b>
P value	0.000	0.004	0.717	0.755

Table 2: Results of ANOVA performed separately on the eight perceptual attributes (significance level:  $p=0.05$ ).

The analysis of variance (ANOVA) indicates that there is no significant difference in the preference and overall IQ among the three mobile displays, as given in Table 2. This is because the perceptions of the two perceptual attributes are affected by multiple attributes such as naturalness, colorfulness, and brightness. In addition, the test images for the two attributes contain complex scenes, so they are more difficult to be evaluated by observers with comparison to other attributes.

## CONCLUSION

The image quality of three OLED-based smart-phone displays was visually assessed at the indoor lighting condition. The physical measurements and psychophysical experiments demonstrate that a wide color gamut helps the colorfulness performance of the mobile displays. The characteristics of EOTF would affect the perception of brightness, contrast, and gradation, while high peak luminance has a little impact on the global brightness of the images.

## REFERENCES

- Fairchild, M. D. 2013. *Color appearance models*, 3rd ed. Hoboken: John Wiley & Sons.
- Gong, R., H. Xu, B. Wang, and M. R. Luo. 2012. Image quality evaluation for smart-phone displays at lighting levels of indoor and outdoor conditions. *Optical Engineering* 51: 084001.
- Hammer, M. 2014. *High-dynamic-range displays: contributions to signal processing and backlight control*. Eindhoven: Technische Universiteit Eindhoven.
- SMPTE ST 2084: 2014. High dynamic range electro-optical transfer function of mastering reference displays. Society of Motion Picture and Television Engineers.
- Thurstone, L. L. 1927. A law of comparative judgment. *Psychological review* 34: 273.
- Ye, Z., J. Qiu, H. Xu, M. R. Luo, and S. Westland. 2017. Image Quality Evaluation of HDR Displays. In: *SID Symposium Digest of Technical Papers*, 1192-1195.

# Research on HDR images tone mapping algorithm based on modified iCAM06

Li Yumei<sup>1</sup>, Liao Ningfang<sup>1,\*</sup>, Wu Wenmin<sup>2</sup>, Deng Chenyang<sup>2</sup> and Li Yasheng<sup>2</sup>

<sup>1</sup> Beijing Institute of Technology, School of Optoelectronics, Ministry of Education of China,

<sup>2</sup> National Professional Laboratory of Color Science and Engineering, Beijing 100081, China

\* Corresponding author: liaonf@bit.edu.cn

## Abstract

To solve the problem that the LDR display device is difficult to meet the HDR display, the HDR image tone mapping algorithm is studied. A new modified algorithm based on iCAM06, iCAM06-n for short, is proposed. The iCAM06-n algorithm combines iCAM06 and multi-scale decomposition algorithm, compensates the images chroma via using the compensation method. 4 kinds of algorithms are analyzed. Then 6 typical HDR images were compressed, and the psychophysical experiments were organized to evaluate the images reproduction effects subjectively. The experimental results show that the objective and subjective evaluation tend to be the same, and iCAM06-n has the better performance, which improves the shortcomings of other algorithms. The chroma compensation method effectively improves the problem of saturation reduction and hue shift in the HDR image compression processed by iCAM06. The introduction of multi-scale decomposition algorithm ensures the details and sharpness of images in the tone mapping.

**Keywords:** HDR image, Tone mapping, Saturation compensation, Image detail

## INTRODUCTION

High dynamic range (HDR) image is widely used in medical images, aerospace remote sensing, and cross-media color reproduction because of its wider dynamic range, richer image details. However, the HDR image is 16 bits or more higher and the general display device is 8 bits which limits the display of HDR images. So, the problem of dynamic range mismatching exists between the HDR image and the conventional display device. At present, HDR image tone mapping algorithm has become popular researches. Swamy A (2021) studied the multi-scale down sampling of intensity levels for HDR image. Jiang F and Fairchild MD (2019) study the Perceptual Estimation of Diffuse White Level in HDR Images. Chiang J C (2021) studied optimization of multi-exposure image coding for HDR image. At present, HDR image tone mapping algorithms mainly consist of the global algorithm, local algorithm, and image color model related algorithms. Typical global algorithms mainly include linear-gradient compression and histogram adjustment compression proposed by Ward (1997). Adaptive log transform compression was proposed by Dargo et al. (2003). The main advantages of this algorithm are that the intensity of all pixels of images are processed according to the same scale, the calculation method is simple. The disadvantages are that the image contrast is reduced and a lot of image details are lost. Typical local algorithms mainly include the Multi-scale Retinex proposed by Jobson (1997) and the Reinhard compression proposed by Reinhard (2002). This kind of algorithm considers the difference perception of brightness in different image regions, which can well simulate human perception. At the same time, the image contrast and local detail information can be preserved, but the continuity of gradient is poor after tone mapping, which is easy to cause halo. Global and local tone mapping algorithm mostly focus on the mapping relationship of brightness, as well as the reproduction and preservation of image details, less on the accurate reproduction of color. Therefore, the introduction of image color appearance into the HDR image tone mapping has become the research hotspots. Fairchild and Johnson (2002, 2004) proposed the iCAM, then applying the iCAM to HDR image compression (2003). In 2007 Kuang and Fairchild revised the iCAM model, named iCAM06. And Chae et al. (2012) proposed

a compensation method to solve the problem of white point shift in iCAM06. The HDR image tone mapping based on image color appearance model integrates the traditional color appearance model with the spatial vision model, considering the interaction of adjacent colors. It is more suitable for tone mapping reproduction of HDR images, but it also has the problems of hue shift and saturation reduction. Therefore, in this paper the proposed algorithm based on iCAM06 to ensure the best reproduction effect on traditional LDR display devices.

## ALGORITHM METHOD

In this paper, 3 kinds of HDR image tone mapping algorithms were studied, including the iCAM06 (Kuang 2007), Guided filter (Sun Q, 2016), and multi-scale decomposition (Gu 2013). Then the new modified algorithm, iCAM06-n for short, combining iCAM06 and multiscale decomposition, was proposed. What's more, iCAM06-n compensates the images chroma via the compensation method.

### Proposed Algorithm

#### *iCAM06*

The model of iCAM06 is proposed based on iCAM, both of which have the same data entry method. The superiority of iCAM06 lies in the combination with bilateral filtering (Tomasi 1998), splitting the HDR image into base and detail layer. Bilateral filtering can effectively retain the image edge details in detail layer, also can effectively blur the image in base layer, to avoid the artificial halo phenomenon in the local compression process.

$$B_{out} = \frac{1}{W} \sum_{p,q \in S} f(\|p - q\|) g(I_p - I_q) I_p \quad (1)$$

$$\text{with } W = \sum_{p,q \in S} f(\|p - q\|) g(I_p - I_q) \quad (2)$$

The parameter I represents the input image, B is the filtered image, W normalizes the sum of the weights, f(X) is the space-domain Gaussian filtering, g(X) is the intensity-domain filtering. However, due to the large calculation of bilateral filtering, Dutand F (2002) proposed the fast bilateral filtering method. the processed method of the base layer is the same as that of the image processing method in iCAM. Color adaptation and nonlinear compression are performed in image base layer, and local contrast enhancement is processed in image detail layer. Comparing with iCAM, the iCAM06 has been greatly improved, but the decrease of color saturation, hue drift and loss of image details are still existed. The multi-scale decomposition is applied with image detail layer in proposed algorithm to remain more image details.

#### *Chroma compensation*

When iCAM06 converts images, the proportion of RGB in reverse is changed due to the error of conversion coefficient, which leads to the decrease of image saturation and hue shift. Although iCAM06 model is transferred to IPT color space for color correction after tone mapping, the problem is still not completely solved. A chroma compensation algorithm is proposed in CIE Lab color space. (1) Firstly, the chromaticity and hue plane angle of the compressed image can be calculated as Eq. (3 and 4):

$$C_{after} = \sqrt{a_{after}^2 + b_{after}^2} \quad (3)$$

$$\theta_{after} = \arctan\left(\frac{b_{after}}{a_{after}}\right) \quad (4)$$

(2) Then the chromaticity compensation factor  $\beta$  and hue angle compensation value  $\Delta\theta$  are calculated for image correction, supposing the chromaticity of the image before tone mapping is  $C_{before}$ :

$$\beta = \frac{C_{before}}{C_{after}} \quad (5)$$

$$\theta_{before} = \arctan\left(\frac{b_{before}}{a_{before}}\right) \quad (6)$$

$$\Delta\theta = \theta_{before} - \theta_{after} \quad (7)$$

(3) Finally, the corrected chroma value is calculated, let the corrected chroma be  $C_{comp}$ :

$$C_{comp} = \beta C_{after} \quad (8)$$

$$\theta_{comp} = \theta_{after} + \Delta\theta \quad (9)$$

$$a_{comp} = C_{comp} \cos(\theta_{comp}) \quad (10)$$

$$b_{comp} = C_{comp} \sin(\theta_{comp}) \quad (11)$$

At present, the compensation value of  $\beta$  and  $\theta$  is empirical value, the accurate compensation factor and hue angle need further experiments. The chromaticity compensation is carried out after tone mapping in the base layer, which can produce a better compensation effect.

### Objective evaluation indices of images

The key aspects of objective evaluation indices in digital image processing algorithms can be listed as follows: image entropy, image sharpness and image chroma. The image entropy refers to the information contained in the image, one-dimensional entropy is the expression of gray distribution features, the larger value of one-dimensional entropy, the more uniform the gray distribution, and more details of the image. which can be calculated as Eq. (12):

$$H = \sum_{i=0}^{255} -p_i \log(p_i) \quad (12)$$

Where H is image entropy, i is the brightness value,  $p_i$  is the probability of i.

The image clarity is the ability to present minute details, which can be calculated as Eq. (13):

$$D = \frac{1}{(R-1)(C-1)} \sum_{i=1}^{R-1} \sum_{j=1}^{C-1} \sqrt{\frac{(x_{i,j} - x_{i+1,j})^2 + (x_{i,j} - x_{i,j+1})^2}{2}} \quad (13)$$

Where D is image clarity, R and C are the numbers of rows and columns, respectively.

## EXPERIMENTATION

### HDR images

In the experiment, 6 HDR images were selected, including indoor environment, outdoor scenery, and specific objects, which are all representative images used to evaluate HDR image compression algorithm. The URL for the HDR image is [https://www.cis.rit.edu./research/mcsl2/icam/hdr/rit\\_hdr/](https://www.cis.rit.edu./research/mcsl2/icam/hdr/rit_hdr/).

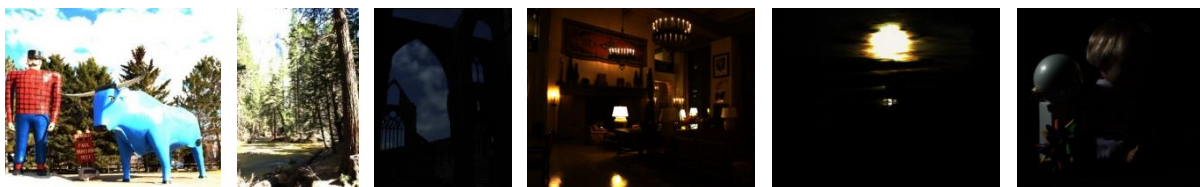

(a). Paul bunyan (b). Yosemite (c). Tinterna (d). Great Lounge (e). Snowman (f). Doll

Figure 1: HDR images uncompressed by any algorithm.

**Procedural of Subjective Evaluation**

The HDR images after tone mapping were presented on the 23.8 in. HP liquid crystal monitor (24mq), the white point is set to D65. The subjective evaluation experiment was carried out in a dark room, and the computer was turned on for 30mints before the experiment. Then 5 observers, with the average age of 27, having normal color vision after color vision test, evaluated the images. the category evaluation method of psychophysical experiment is adopted. The 6 types of processed images are evaluated and scored used the indices of display preference and perceptual accuracy. The corresponding image quality levels and score standards are shown in Table 1. During the evaluation, the original image and the tone mapping images are arranged in parallel. The background of the image is neutral gray, the observation distance is 50cm, and the field of view is 5°. Each observer performs 3 rounds of evaluation, a total of 36 times, about 40 minutes.

Grade	Image preference	Perception accuracy	Evaluation scores
1	Extremely satisfied	Extremely excellent	3
2	Very satisfied	Excellent	2
3	Satisfied	Good	1
4	Generally satisfied	Average	0
5	Unsatisfied	Poor	-1
6	Very dissatisfied	Vary poor	-2
7	Extremely satisfied	Extremely poor	-3

Table 1: Subjective evaluation score.

**Experimental Result and analysis**

The evaluation results of the algorithm performance for HDR image tone mapping are mainly analyzed subjectively and objectively. Two type images processed by above algorithms are shown in Figure2.

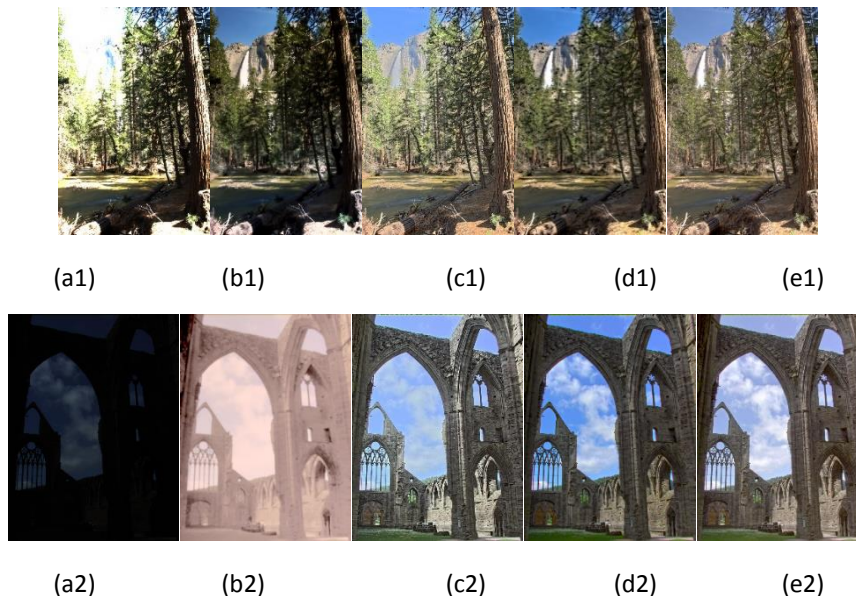

Figure 2: Images after tone mapping by 4 algorithms. In order from left to right, (a)the image is directly displayed without any tone mapping, (b)the image is processed by iCAM06, where the Guide Filter instead of the Fast bilateral Filter, (c) the image is operated by Multi-scale Decomposition algorithm, (d)the proposed algorithm, (e)the image processed by iCAM06.



**Subjective evaluation**

The evaluation results of the four algorithms are shown in the figure 1. From the figure, the evaluation accuracy is very close to the preference statistics. The proposed algorithm iCAM06-new has the highest performance on HDR image tone mapping. Followed by iCAM06 and MSD, the two are relatively close. The worst performer is guided filtering. The compression performance of the four algorithms for each picture is shown in the fig.2. It can be seen from the figure that the newly proposed algorithm has a good performance on the compression performance of each picture, except for the image doll, and the compression result are all batter and stable. The compression performance of the GF algorithm at the worst. The MCD algorithm performs better in some images, but does not perform well in others, and the algorithm stability needs to be improved.

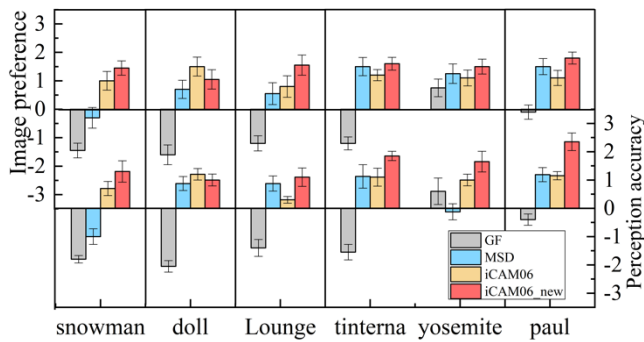
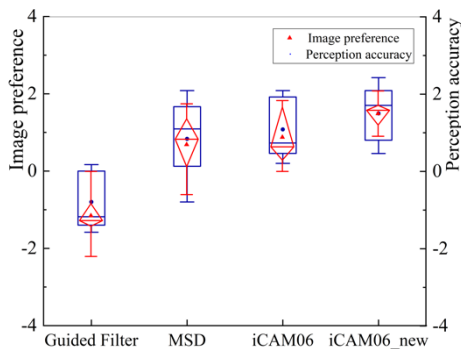

Figure 3: Evaluation of four algorithms

Figure 4: Compression Performance Evaluation for each image

**Objective evaluation**

The objective evaluation is mainly from the image entropy, sharpness and chroma. The image entropy and sharpness are obtained by calculating the detail layer of the image. The average value of the image chroma does not include the image lounges and snow, because the results of MSD algorithm for these two images are severe inaccurate, leading to high saturation. It can be seen from table2 that the new algorithm has similar performance in image entropy index with MSD, and the best performance in image sharpness and saturation index.

Image name	Entropy				Sharpness				Chroma			
	GF	MSD	iCA M06	New	GF	MSD	iCA M06	New	GF	MSD	iCA M06	New
Paul	3.59	7.54	4.53	7.51	6.31	12.48	9.66	12.82	16.55	22.96	20.12	26.15
Bunyan	3.30	7.78	4.51	7.61	9.84	22.52	17.02	22.02	11.59	16.06	15.49	16.52
Yosemite	1.31	7.68	4.20	7.52	0.41	13.14	10.46	15.77	11.79	11.11	12.26	15.58
Tinterna	1.81	7.47	4.61	7.57	0.76	8.41	9.20	12.64	7.48	58.36	27.33	38.71
Lounge	0.65	7.38	4.21	7.26	0.30	7.35	5.70	9.85	8.45	10.18	9.57	13.60
Doll	0.63	7.66	4.51	7.60	0.26	12.43	8.97	12.93	4.60	20.58	7.60	8.28
Snow	1.88	7.59	4.43	7.49	2.98	12.72	10.17	14.34	12.09	15.08	14.36	17.96
Mean	3.59	7.54	4.53	7.51	6.31	12.48	9.66	12.82	16.55	22.96	20.12	26.15

Table 2: Objective evaluation results of image clarity and chroma

**CONCLUSION**

According to the subjective and objective evaluation results, the performance of the proposed algorithm iCAM06-new is outstanding, which is consistent with the subjective evaluation results.

iCAM06-new algorithm combines the advantages of both iCAM06 and MSD algorithms, and overcomes the shortcomings of other algorithms: (1) The proposed algorithm inherits the stability of iCAM06 for tone mapping; (2) Retains the image clarity and rich image details of the MSD multi-scale decomposition enhancement algorithm; (3) The chroma compensation algorithm improves the saturation of the image and enhances the hue correction, to meet the accuracy of cross-media color reproduction. In summary, the HDR image compressed by the proposed algorithm has accurate hue, high saturation, more image details, and more vivid color performance.

## **ACKNOWLEDGEMENTS**

National Natural Science Foundation of China (61975012).

## **REFERENCES**

- Erik Reinhard, Michael Stark, Peter Shirley, James Ferwerda. Photographic Tone Reproduction for Digital Images[J], ACM Transactions on Graphics, 2002,21(3):267-276.
- Chiang J C, Shih W H, Deng J Y. Rate-distortion optimization of multi-exposure image coding for high dynamic range image coding[J]. Signal Processing Image Communication, 2021, 95(3):1162-1173.
- Chae S M, Lee S H, Kwon H J, et al. A tone compression model for the compensation of white point shift generated from HDR rendering[J]. IEICE. 2012, E95 A (8):1297-1301.
- Drago F, Myszkowski K, Annen T, Chiba N. Adaptive logarithmic mapping for displaying high contrast scenes[J]. Computer Graphics Forum, 2003, 22(3):419-426.
- Durand F, Dorsey J. Fast Bilateral Filtering for the Display of High-Dynamic-Range Images[J]. ACM Trans. Graphics, 2002, 21(3): p.257-266.
- Fairchild M. D, Johnson G. M. Meet iCAM: A Next Generation Color Appearance Model[C]. IS&T/SID 10th Color Image Conference, 2002: 33-38.
- Fairchild M.D, Johnson G.M. The iCAM framework for image appearance, image differences, and image quality[J], Journal of Electron Imaging, 2004, 13(1):126
- Fairchild. M.D. Color appearance models[M]: John Wiley & Sons, 2013.
- Gu B, Li W, Zhu M, et al. Local edge-preserving multiscale decomposition for high dynamic range image tone mapping[J]. Image Processing, IEEE Transactions on, 2013, 22(1): 70-79.
- Gregory Ward Larson, Holly Rushmeier, and Christine Piatko. A Visibility Matching Tone Reproduction Operator for High Dynamic Range Scenes[C], IEEE, 1997, 3(4):291-306.
- Kuang J, Johnson G.M, Fairchild M.D. iCAM06: A refined image appearance model for HDR image rendering[J]. Journal of Visual Communication and Image Representation, 2007, 18(5): 406-414.
- Jiang F, MD Fairchild, Masaoka K. Perceptual Estimation of Diffuse White Level in HDR Images[J]. Color and Imaging Conference, 2019, 2019(1):195-200.
- Jobson D J, Rahman Z, Woodell G A. A multi scale retinex for bridging the gap between color images and the human observation of scenes[C]. IEEE,1997, 6(7):965-976.
- Johnson G.M, Fairchild M.D. Rendering HDR images[C], CIC, 2003:36-Conference, 2003:36--41.41.
- Swamy A, Shylashree N. HDR Image Compression by Multi-Scale down Sampling of Intensity Levels[J]. International Journal of Image and Graphics, 2021:2150048.
- Sun Q, Jiang H, Zhu G, et al. HDR Pathological Image Enhancement Based on Improved Bias Field Correction and Guided Image Filter[J]. BioMed Research International, 2016, 2016(7):1-11.
- Steven A. Cover. Another look at Land's Retinex algorithm[J]. IEEE proceedings of South Eastcon'91, 1991, 4 351-355.
- Tomasi C, Manduchi R. Bilateral filtering for gray and color images[C]. IEEE,1998.836-846.

# HDR imaging using CMOS technology inspired by human eyes for Automotive applications

Sandhiya Jayaprakash Brindha<sup>1,\*</sup>, Monica Vatteroni<sup>2</sup> and Gabriele Simone<sup>3</sup>

1 Politecnico di Milano; sandhiyajb@gmail.com

2 Eyetechn; monica.vatteroni@eye-tech.biz

3 University of Milano; gabriele.simone@di.unimi.it

\* Corresponding author: sandhiyajb@gmail.com

## Abstract

Automobiles, with multi-sensor and multi-camera systems, are striving hard to improve the image quality. This is driven by several factors including the need to improve safety and establish an efficient urban plan. This study is focused on the use of EYE-TECH (EYE-TECH 2021) technology which aims to overcome such limitations by mimicking the behavior of the human eyes thanks to the possibility to dynamically change the setting of the sensor in terms of dynamic range and sensitivity. In this paper, a custom setup for automotive application is presented and a special focus on images in a dark environment is proposed. RAW images are captured with different settings in a controlled light environment. Pain area for an image in low light is the high noise (Cho and Yang, 2002), hence the images captured from the sensor are processed in order to reduce the noise and improve the quality. The optimal settings to capture the image and the method to improve the quality of the image are investigated.

**Keywords:** HDR, Automotive, CMOS sensor, AI Vision, Lowlight

## INTRODUCTION

In contrast to industrial machine vision systems, automotive camera systems must deal with unconstrained environments, i.e., a wide range of temperature, illumination, and weather conditions (IEEE P2020, 2020). The quality of the image plays a crucial role in both AI vision and human viewing in automobiles. In today's world of advanced imaging technologies with great performance, high speed, hyper resolution, and High Dynamic Range (HDR) imaging, achieving an optimal response in any light condition, as the human eyes do, is still a challenge. For this study, a monolithic Full-HD camera-on-a-chip sensor, EYE-TECH1080 (EYE-TECH 2021), integrating EYE-TECH technology for adaptive HDR with a resolution of 1080×1080 and with a color filter array based on a GBRG Bayer mosaic to provide RGB pixels has been used. The dynamic range of the sensor can be tuned by a simple input setting of the imager. Images with different dynamic ranges have been captured by the sensor in a global shutter mode by synchronizing the external light source which was pulsed in sync with the integration time of the pixels by using a signal named LEDOUT, generated by the sensor. It is worth mentioning that the global shutter operation can be also implemented with a suitable shutter device (synchronized with the LEDOUT signal) installed on the optical setup of the camera where the chip was used (Cavallotti, et al. 2014). Focus of this paper is to optimize the image quality, with particular attention to operate in low light conditions.

This paper is organized as follows; Section 1: Sensor Setup, explains how the sensor is configured for the automotive application. Section 2: Process, explaining the methods used to enhance image quality and the process to determine the optimal settings. Section 3: Analysis of the results from the experiment above. Section 4: Conclusions.

### SENSOR SET-UP

The uniqueness of the approach to HDR proposed in this study is the possibility to tune the dynamic range of the sensor even in real-time, achieving adaptive HDR. The technique is based on the control of the saturation voltage by adjusting the reset level of the pixels. The reset voltage is progressively decreased with a discharge curve, which combines stepwise and ramp linear behaviour. The discharge curve is created internally to the sensor chip by using a set of parameters given by the user or, in alternative, by an artificial intelligence algorithm, via an I2C-like interface, as presented in Figure 1.

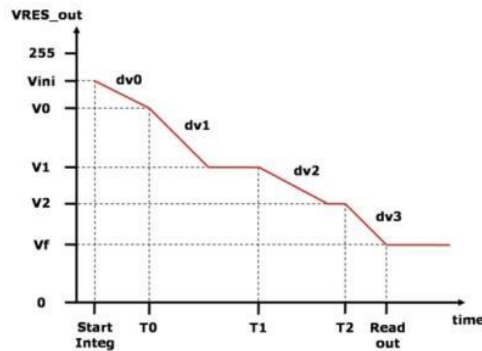

Figure 1: Reset discharge curve created by the sensor based on the assigned parameters.

The parameters are 12: 5 setting the voltage steps ( $V_{ini}$ ,  $V_0$ ,  $V_1$ ,  $V_2$ ,  $V_f$ ), 3 setting the time steps ( $T_0$ ,  $T_1$  and  $T_2$ ) and 4 setting the slope ( $dv_0$ ,  $dv_1$ ,  $dv_2$  and  $dv_3$ ). The sensor can be quickly reconfigured, even frame by frame, by the computational unit to extract in the best way the relevant information from the scene. The entire set up is placed in a controlled light environment. For each target, the sensor dynamic range has been changed, 6 different configurations have been chosen and presented in this paper. These settings have been chosen because they give a good overview of possible dynamic ranges. The parameters for the different settings are reported in Table 1.

Param. Name	Set1 (LDR)	Set2 (HDR2)	Set3 (HDR6)	Set4 (HDR9)	Set5 (HDR10)	Set6 (HDR11)	Set7 (HDR12)
$V_{ini}$	255	255	255	255	255	255	255
$V_0$	100	204	150	230	213	245	213
$V_1$	100	191	120	220	177	177	177
$V_2$	100	161	110	190	138	120	138
$V_f$	100	100	100	100	100	100	100
$T_0$	1	200	220	100	64	64	100
$T_1$	230	230	249	130	128	128	150
$T_2$	250	247	253	253	192	192	200
$Dv_0$	16	16	16	16	16	16	16
$Dv_1$	1	1	1	1	1	1	1
$Dv_2$	2	2	2	2	2	2	2
$Dv_3$	4	4	4	4	4	4	4

Table 1: Time, voltage, and slope input settings for the CMOS sensor.

## **PROCESS**

In this study, each RAW image was captured with a size 1178 x 1080 from the sensor. It is worth mentioning that the size is larger than the sensitive area (1080x1080) because of the dummy pixels at the beginning and end of the frame. Two target images with the settings in Table 1 have been captured. To subtract the offset component of the fixed pattern noise, an average on a set of 10 black images has been produced. This average has been subtracted from each image. The gain offset has been calculated for each pixel and the correction applied to the image. Then the image has been demosaiced based on the GBRG pattern to get an RGB matrix. The images are inverted since white of the original raw images is zero.

After this process, following correction methods are applied to the images in the RGB domain with the goal to enhance the quality of the images in any HDR configuration.

### *Grey world method*

The Grey World Assumption is a white balance method that assumes that the scene, on average, is a neutral grey. Grey World assumption holds with a good distribution of colors in the scene.

The followed steps are,

- Desired grey is assigned as 50%.
- Mean for each channel is calculated.
- Each pixel is multiplied by the desired grey and then divided by the mean of their respective channel.

### *Histogram equalization*

Intensity values of image pixels are adjusted using histogram equalization, producing an output image with pixel values evenly distributed throughout the range of the image.

### *Reduce Haze*

This method was used to improve the visibility of an image in low-light conditions. The histogram of pixel-wise inversion of low-light images or HDR images is like the histogram of hazy images.

The followed steps are,

- Invert the low-light image.
- Apply the haze removal algorithm to the inverted low-light image.
- Invert the enhanced image.

### *Color space conversion*

This is another method to improve the visibility of an image in low-light conditions. Before enhancing, the image has been converted from the RGB to CIELAB color space.

The followed steps are,

- Convert the input image from the RGB color space to the CIE L\*a\*b\* color space.
- Invert the CIE L\*a\*b\* image. Haze is reduced from the inverted image.
- Increase the saturation.
- Convert the image back to an RGB image.

**RESULTS AND DISCUSSION**

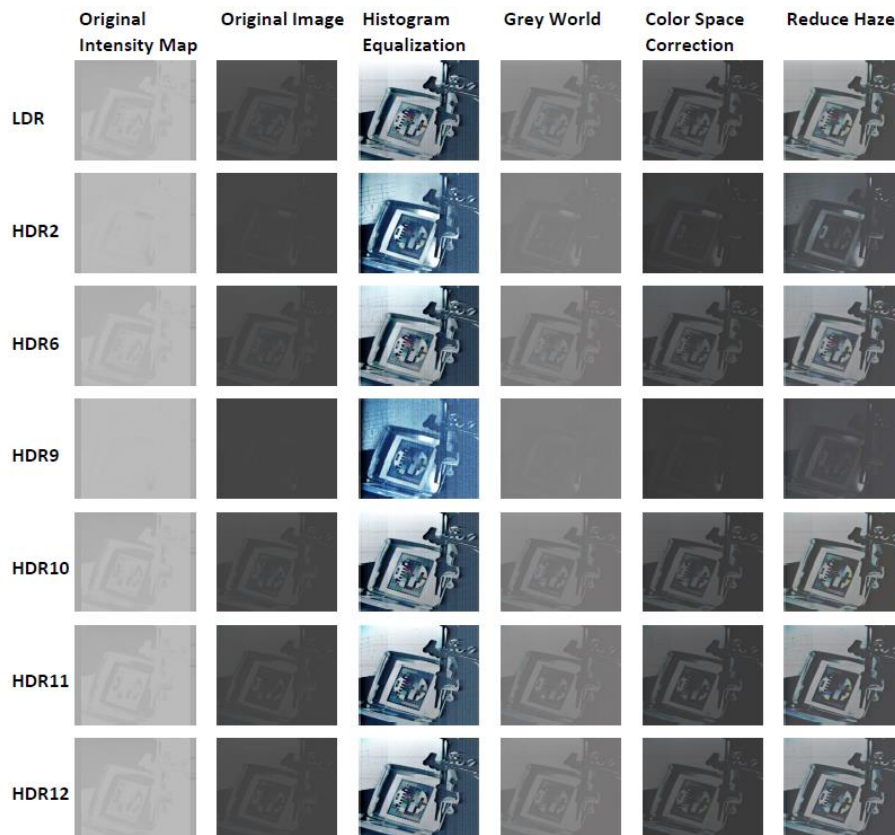

Figure 2: Comparison of the original images obtained from the various settings and the resultant images of the different methods used of target 1.

The effects of the various methods used above have been evaluated by analyzing the magnitude of the individual channels and Perception based Image Quality Evaluator (PIQE) no-reference image quality score and Naturalness Image Quality Evaluator (NIQE) no-reference image quality score (Mathworks) of the resulting image of each method. The whole set of images are shown in Figures 2 and 3 for comparison.

The PIQE scores of the original image and the processed images are shown in Tables 2 and 4 and the NIQE scores of the images in Tables 3 and 5. The image with the lowest score has the lowest noise and the one with the highest score has the highest noise. The lowlight enhancement method by haze reduction shows the lowest values in each setting. The histogram equalization method has the highest values in each setting. Visually the histogram equalized image has brighter results as compared to the reduce haze method.

	<b>Original Image</b>	<b>Histogram Equalization</b>	<b>GreyWorld</b>	<b>Color Space Correction</b>	<b>Reduce Haze</b>
LDR	27.60	53.70	23.82	38.93	16.13
HDR2	53.62	65.46	45.49	54.13	19.08
HDR6	28.23	54.65	23.49	35.03	17.88
HDR9	73.53	72.26	63.97	65.69	25.03
HDR10	29.85	54.09	28.26	42.17	19.07

HDR11	30.69	55.94	32.91	42.27	20.80
HDR12	30.17	54.44	28.63	39.87	17.56

Table 2: PIQE score of the original image compared with the scores of the resultant images of the target 1.

	Original Image	Histogram Equalization	Grey World	Color Space Correction	Reduce Haze
LDR	7.48	7.58	6.00	6.20	5.11
HDR2	5.77	7.54	5.53	5.99	5.08
HDR6	7.75	7.58	6.20	7.00	5.20
HDR9	5.76	10.65	6.12	6.79	5.61
HDR10	7.40	7.44	6.02	6.70	5.08
HDR11	7.35	7.86	6.17	7.07	5.17
HDR12	7.17	7.74	6.29	6.46	5.06

Table 3: NIQE score of the original image compared with the scores of the resultant images of the target 1.

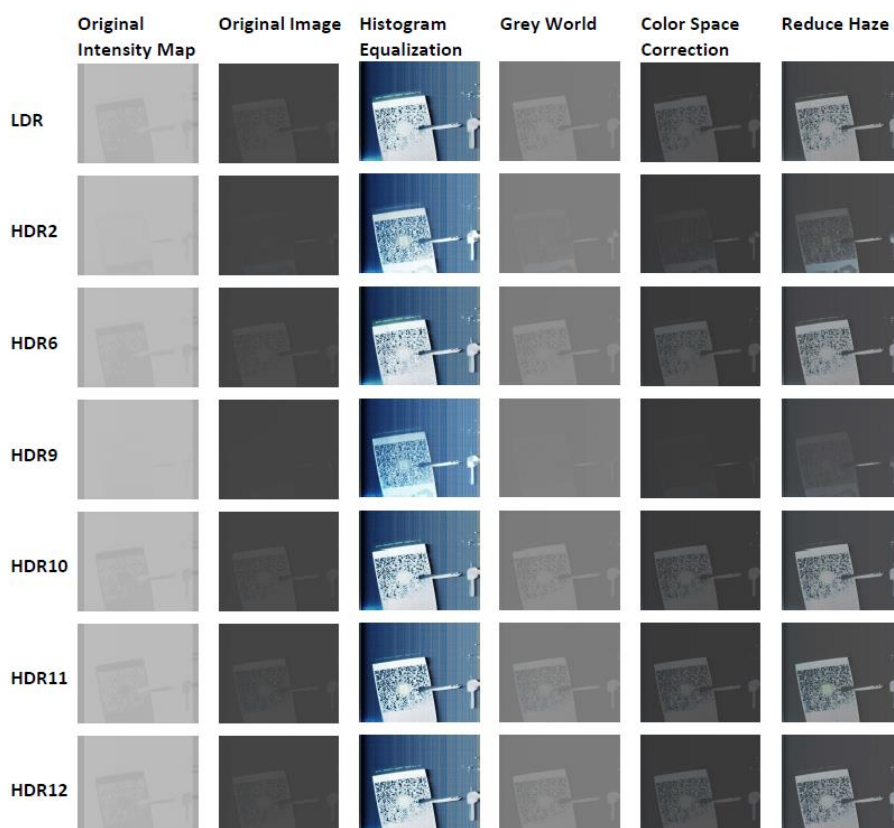

Figure 3: Comparison of the original images obtained from the various settings and the resultant images of the different methods used of target 2.

	Original Image	Histogram Equalization	GreyWorld	Color Space Correction	Reduce Haze
LDR	34.49	63.90	45.53	49.51	22.73
HDR2	46.18	60.91	53.28	39.18	22.49



HDR6	31.93	63.73	47.73	53.50	21.12
HDR9	78.43	70.96	61.64	64.23	20.09
HDR10	40.81	64.07	50.37	56.80	23.22
HDR11	44.12	63.86	52.26	63.87	23.94
HDR12	38.08	63.06	50.40	56.61	22.69

Table 4: PIQE score of the original image compared with the scores of the resultant images of second target.

	Original Image	Histogram Equalization	GreyWorld	Color Space Correction	Reduce Haze
LDR	4.70	6.68	6.40	7.39	5.17
HDR2	4.79	6.97	5.01	5.71	5.30
HDR6	4.66	6.36	6.15	7.50	5.25
HDR9	5.59	7.99	5.07	5.82	5.29
HDR10	4.63	6.62	6.07	7.13	5.33
HDR11	4.56	6.53	6.07	7.15	4.99
HDR12	4.73	6.53	6.53	7.47	5.32

Table 5: NIQE score of the original image compared with the scores of the resultant images of second target.

## CONCLUSION

In the paper, different methods of image enhancement have been used with the goal to improve image quality. From these methods reducing haze of an inverted image shows optimal reduction in noise, as it is evident from the PIQE scores. Of course, the low dynamic range have the lowest PIQE. However, it clips the data that are outside its dynamic range. Quality of the image plays a crucial role in both AI vision and human viewing in automobiles. The results of this study can form a basis for enhancement of the image quality in lowlight conditions especially in noise reduction. Further investigation can be done for better color rendering algorithm. For future work, two or more approaches used in this work can be combined to obtain better results.

## REFERENCES

- Cavallotti, C., M. Cuppone, A. Menciacchi, M. Silvestri, H.T. Tran and M. Vatteroni. 2014. CMOS Image Sensor with Tunable Dynamic Range for Catheter Based Endoluminal Applications. *Procedia Engineering*. 87. 1103-1106.
- EYE-TECH s.r.l. 2021. *Home*. <https://www.eye-tech.biz/>.
- EYE-TECH s.r.l. 2021. *EYE-TECH1080*. <https://www.eye-tech.biz/EYE-TECH1080.html>.
- Mathworks. Image Quality Metrics [https://in.mathworks.com/help/images/image-quality.html?s\\_tid=CRUX\\_lftnav](https://in.mathworks.com/help/images/image-quality.html?s_tid=CRUX_lftnav).
- Members of the IEEE P2020 Working Group. 2020. *IEEE P2020 Automotive Imaging White Paper*. New York: The Institute of Electrical and Electronics Engineers.

# Recovering Real-World Spectra from RGB Images under Radiance Mondrian-World Assumption

Yi-Tun Lin <sup>1,\*</sup> and Graham D. Finlayson <sup>1</sup>

<sup>1</sup> School of Computing Sciences, University of East Anglia; {Yi-Tun.Lin, G.Finlayson}@uea.ac.uk

\* Corresponding author: Yi-Tun.Lin@uea.ac.uk

## Abstract

In Spectral Reconstruction (SR), we recover hyperspectral information from RGB data. Recent works benchmark SR algorithms based on hyperspectral images of real-world scenes, where two dominant approaches are regression and Deep Neural Network (DNN). While the former seeks point-based RGB-to-spectrum mapping, the latter incorporates sophisticated architectures mainly to extract and utilize the image contextual information in the SR process. In this paper, we examine the relative performance of the two approaches when applied to some “unseen” and “unexpected” spectral image data. We define a subset of images complying with a real-world worst-case imaging condition namely the Radiance Mondrian-World assumption, where the image content is limited to overlapping rectangular regions, and the spectral signals are uniformly sampled from the convex closure of the real-world spectra at hand. Interestingly, for all the models considered – including many different regressions and the leading DNN – performance degrades to broadly the same level (indicating there may be little advantage for using the DNN approach in this worst-case scenario).

**Keywords:** *Spectral Reconstruction, Hyperspectral Imaging, Multispectral Imaging, Regression, Deep Learning*

## INTRODUCTION

Hyperspectral cameras are used in many industrial applications, including remote sensing (Veganzones et al. 2014; Chen et al. 2014), artwork preservation (Xu et al. 2017), medical imaging (Zhang et al. 2016) and food processing (Qin et al. 2013), where high-resolution radiance spectra are recorded at every pixel of the scene. Despite their usefulness, conventional hyperspectral technologies (Gat 2000, Green et al. 1998) are often subject to low spatial resolution, low light sensitivity and/or long integration time. Furthermore, they are often much more expensive and/or bulkier than regular RGB cameras.

Spectral Reconstruction (SR) is a computational approach to obtaining hyperspectral information, where data-driven learning algorithms are trained to recover high-resolution spectra from RGB images. Most SR algorithms fall into two classes: those based on regression (e.g., Heikkinen et al. 2008) and those based on Deep Neural Network (DNN) implementations (Arad et al. 2018, 2020). In regression, each RGB vector is individually mapped to its spectral estimate, whereas the DNN algorithms seek to extract the contextual information from large RGB image patches as part of the SR process. Research shows that leading DNN methods deliver SR that are only a little better than simple regressions (Lin and Finlayson 2020; Aeschbacher et al. 2017). This is surprising not only because it goes against the premise of using DNNs (that image context helps recovering spectra), but also because regressions are simple while DNNs often have, literally, millions of parameters.

In this paper, we are interested in understanding the relative performance of the two approaches in more detail. In the SR literature, the parameters that drive the algorithms – regressions or DNNs – are found using an image training set. Then, a testing image set is used for performance evaluation (normally the test set contains images similar to those found in the training set). Here we would like to see how well these algorithms work when used on some “unseen” and “unexpected” (U&U) testing image data i.e., images which are very different from the training set.

To make such a U&U testing image set, we take inspiration from the widely used *Mondrian image* in many color experiments (Land 1977), which refers to a flat patchwork of overlapping rectangular patches of Lambertian reflectances. Since recently most of the DNN algorithms are trained to recover radiances (reflectances multiplied by the illumination spectra) instead of reflectances, in this paper we extend the concept of Mondrian image to admitting radiance spectra at each rectangular patches, namely the Radiance Mondrian-World (RMW) setting. Additionally, for those radiances used in our RMW test set, we uniformly sample the convex closure of all spectra in the original testing images.

In effect, this setting defines a worst-case (yet still possible) imaging scenario, where meaningful image content is absent, and the radiance at each pixel is a sub-pixel mixture of selected natural radiances (real-world objects reflecting real-world lights). Our result shows a surprising result that all considered models – either simple or complex – perform nearly the same under the RMW assumption.

## BACKGROUND

At each pixel of a pair of matching RGB and hyperspectral images, the measurements are approximately related by (Wandell 1987):

$$\underline{\mathbf{x}} = [\underline{\mathbf{s}}_R, \underline{\mathbf{s}}_G, \underline{\mathbf{s}}_B]^T \underline{\mathbf{r}}, \quad (1)$$

where  $\underline{\mathbf{x}} = [R, G, B]^T$  is the 3-value RGB measurement,  $\underline{\mathbf{r}}$  is the  $k$ -value discrete hyperspectral measurement, and  $\underline{\mathbf{s}}_R$ ,  $\underline{\mathbf{s}}_G$  and  $\underline{\mathbf{s}}_B$  are respectively the spectral sensitivity functions of the R, G and B camera sensors (also discretized into  $k$ -value vectors matched with  $\underline{\mathbf{r}}$ ).

In SR, we study the inverse problem of Equation (1), where the hyperspectral measurement  $\underline{\mathbf{r}}$  is recovered given the information of  $\underline{\mathbf{x}}$ .

### Spectral Reconstruction by Regression

Most (if not all) regression-based SR algorithms have the following formulation (Heikkinen et al. 2008):

$$\underline{\mathbf{r}} \approx \mathbf{M}\varphi(\underline{\mathbf{x}}), \quad (2)$$

where  $\varphi$  is a 3-to- $p$  feature transformation function, and  $\mathbf{M}$  is a  $k \times p$  regression matrix. The goal of regression is to find the parameters in  $\mathbf{M}$  given sufficient ground-truth data pairs of  $\underline{\mathbf{r}}$  and  $\underline{\mathbf{x}}$ .

Different functions  $\varphi$  are adopted by the different regression algorithms. The simplest variant is Linear Regression, where  $\varphi(\underline{\mathbf{x}}) = \underline{\mathbf{x}}$  and  $p = 3$  (Heikkinen et al. 2008). Non-linear expansions are adopted by Connah and Hardeberg (2005), Lin and Finlayson (2019) and Nguyen et al. (2014), where  $\varphi$  is respectively the polynomial, root-polynomial and radial-basis-function transformation. More complicated regression-based sparse coding method “A+” is proposed by Aeschbacher et al. (2017), where the RGB space is sectioned into adjacent *neighborhoods* where in each neighborhood a bespoke Linear Regression SR is trained and used.

The solution of Equation (2) is classically solved via least-squares minimization, where the solution is written in closed form (Heikkinen et al. 2008):

$$\mathbf{M} = \mathbf{R}^T \Phi (\Phi^T \Phi + \gamma \mathbf{I})^{-1}. \quad (3)$$

Here,  $\mathbf{R} = [\underline{\mathbf{r}}_1, \underline{\mathbf{r}}_2, \dots, \underline{\mathbf{r}}_N]^T$  is the  $N \times k$  spectral data matrix which collects all  $N$  ground-truth training spectral data,  $\Phi = [\varphi(\underline{\mathbf{x}}_1), \varphi(\underline{\mathbf{x}}_2), \dots, \varphi(\underline{\mathbf{x}}_N)]^T$  is an  $N \times p$  data matrix of transformed RGB features,  $\gamma$  is a user-defined regularization parameter (Tikhonov et al. 2013), and  $\mathbf{I}$  is a  $p$ -by- $p$  identity matrix. In our experiment, we use a cross-validation methodology (Galatsanos and Katsaggelos 1992) to select the  $\gamma$  parameter – a wide range of magnitudes are tried as the value of  $\gamma$ , and the one that minimizes the error when recovering a *validation* image set (another set different from the

training set) is selected. Here, the MRAE error is used, which is a standard metric for measuring SR performance (Arad et al. 2018, 2020).

### **Spectral Reconstruction by Deep Neural Network**

Deep Neural Networks (DNN) are well-known for their ability to solve complex non-linear mappings. In SR, Convolutional Neural Network (CNN) and Generative Adversarial Network (GAN) are commonly used, where large RGB image patches are set as inputs and corresponding hyperspectral image patches are the outputs. The idea of mapping large image patches seems *prima facie* plausible. Indeed, as a thought experiment we may try to identify a face in an image, and then the prior knowledge of characteristic skin reflectances (Pan et al. 2003) can be used to recover the spectra in a face region more accurately. In the recent NTIRE 2018 and 2020 Spectral Reconstruction Challenge (Arad et al. 2018, Arad et al. 2020), all finalists are based on DNN implementations.

In this paper, we benchmark the CNN-based HSCNN-R (Shi et al. 2018), which is one of the top-performing models trained on our concerned spectral database (Arad et al. 2018).

## **THE RADIANCE MONDRIAN-WORLD TEST**

### **Experimental Procedure**

We use the ICVL hyperspectral image dataset (Arad and Ben-Shahar 2016, Arad et al. 2018), from which we randomly selected 100 images as the training set, 50 images as the validation set, and 50 images for testing. The size of the images is  $1300 \times 1392$ , with 31 spectral channels (i.e.,  $k = 31$  in previous discussions) referring to hyperspectral measurements within the range between 400 and 700 nanometers (nm) and with 10-nm intervals between adjacent channels.

As for the ground-truth RGB images, we calculate them using the hyperspectral images following and the CIE 1964 color matching functions (Commission Internationale de l’Eclairage 1964) as the RGB camera’s spectral sensitivity functions (see Equation (1)).

All considered SR models (introduced in the Background section) are trained using the training-set images. For regression models, the validation set is used to determine the regularization parameter  $\gamma$  in Equation (3), while for the DNN-based HSCNN-R, the validation set determines the stopping epoch of its iterative training (Shi et al. 2018).

For comparison, we benchmark on both the original 50 testing images (referred to as the “Original Test”) and 150 Radiance Mondrian-World images derived from the testing set (the “RMW Test”).

### **Generating Radiance Mondrian-World Images**

#### *Spatial Content – Patchwork Generation*

Given the example Mondrian image in Land (1977), we are to simulate images with spatial patterns resembling that in the original image.

Starting with an *empty* image of height  $H$  and width  $W$  (here we set  $H = 1300$  and  $W = 1392$ , matching the size of the original testing images), we iteratively insert rectangular patches at random locations and with random sizes – with new ones overlaying on top of the previous ones – until all image pixels are occupied.

For the top-left coordinates of each patch, we draw from uniform random distributions between  $[0, H]$  and  $[0, W]$ , respectively. Then, for the patch height and patch width we draw from the normal

distribution  $\mathcal{N}(\mu, \sigma)$  with  $\mu = \frac{H}{5}, \sigma = \frac{H}{15}$  and  $\mu = \frac{W}{5}, \sigma = \frac{W}{15}$ , respectively (here,  $\mu$  refers to the mean and  $\sigma$  is the standard deviation of the normal distribution).

An example generated RMW image (in sRGB colors) is shown on the left of Figure (1).

### *Spectral Content – Spectral Convex Hull Sampling*

Prior to the RMW image generation we are to build a “convex hull” of spectra, which is the minimal  $k$ -dimensional polytope ( $k$  is the number of spectral channels) that encloses all spectra collected from the testing hyperspectral images. This is commonly built using the Qhull implementation (Barber et al. 1998). However, for our data  $k = 31$ , which is too large for Qhull to run efficiently. Thus, we use the PCA technique (Reddy et al. 2020) to reduce the dimension of all spectral data from 31 to 8.

We use an 8-dimensional spectral representation because in the prior art many research has shown that real-world spectra can be efficiently described by a 5- to 8-dimensional linear model e.g., Parkkinen et al. (1989) and Hardeberg (2002).

For each inserted patch in the RMW image, one spectrum out of the 8-dimensional convex hull is selected (and transformed back to 31-dimensional using the PCA bases) to fill the patch. For uniform sampling (that all spectra in the convex set are equally likely), we use an acceptance-rejection sampling approach. Illustrated on the right of Figure 1 (here we show a 3D analogy), the sampled data is first selected from the “bounding hypercube” of the convex hull (red region), and then we check whether it locates inside (sample accepted) or outside (sample rejected and to be reselected) the convex hull (green region).

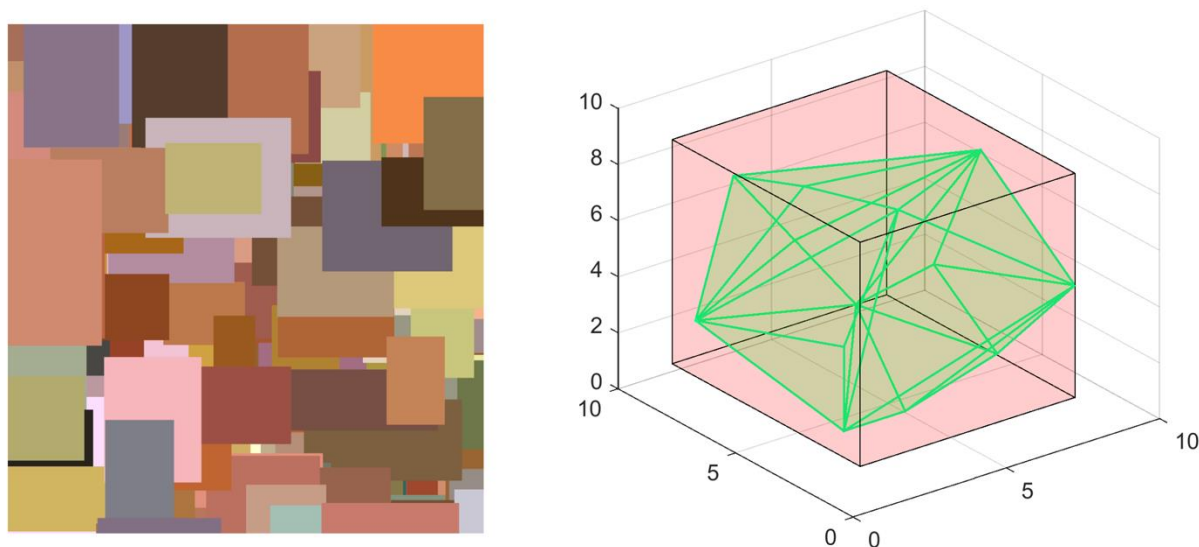

Figure 1: **(Left)** An example RMW image. For the display purpose, the image is transformed to linear sRGB colors and white-balanced. **(Right)** Example of a 3D convex hull (green) and its bounding hypercube (red).

## **RESULT AND DISCUSSION**

Mean results of the two standard evaluation metrics (Arad et al. 2018, Arad et al. 2020) are shown in Table 1. MRAE (a.k.a. Mean-Relative-Absolute Error) is the  $\ell_1$ -normed percentage error with respect to the ground-truth data, and RMSE (Root-Mean-Square Error) calculates the  $\ell_2$  norms of the spectral differences. While MRAE is not influenced by the scale or bit depth of the data (as a general trait of percentage errors), for interpreting the RMSE results we must keep in mind that the spectral data is encoded in 12 bits (that is, with a maximal value of 4095).

Under the headline “**Original Test**,” we see that when the original testing images are used, more complex models can indeed provide better SR performance. Yet as we examine the “**RMW Test**” results, all models degrade to about the same level of performance.

In terms of the performance degradation, our result reflects the fact that most learning algorithms are *domain specific*, which means that the performance of the trained models is contingent on the resemblance between the training and testing data. But, perhaps what is more interesting is that our RMW test set seems to claim an invariant performance across different models. This may suggest that more sophisticated mapping functions would not help recovering spectra under the RMW imaging assumption. The potential mathematical proof of this claim and the development of the simplest efficient SR mapping function for RMW images are for future work.

Model	Original Test		RMW Test	
	MRAE	RMSE	MRAE	RMSE
Linear Regression	0.0624	33.26	0.1354	301.5
Root-Polynomial Regression (6 <sup>th</sup> order)	0.0469	27.80	0.1561	324.1
A+ Sparse Coding	0.0387	23.97	0.1511	321.5
Radial-Basis-Function Regression	0.0206	18.30	0.1484	325.8
Polynomial Regression (6 <sup>th</sup> order)	0.0195	17.05	0.1460	383.2
HSCNN-R	0.0173	16.33	0.1259	293.4

Table 1: The hyperspectral image recovery results when tested using the original testing image set (left) and our RMW image set (right). All models except for the DNN-based HSCNN-R (last row) are based on regression. The mean performances in MRAE and RMSE are presented.

## ACKNOWLEDGEMENTS

The authors would like to thank EPSRC grant EP/S028730/1 and Apple Inc. for funding this research.

## REFERENCES

- Aeschbacher, J., J. Wu, J., and R. Timofte. 2017. In defense of shallow learned spectral reconstruction from RGB images. In: *Proceedings of the International Conference on Computer Vision*, 471-479.
- Arad, B., and O. Ben-Shahar. 2016. Sparse recovery of hyperspectral signal from natural RGB images. In: *Proceedings of the European Conference on Computer Vision*, 19-34.
- Arad, B., O. Ben-Shahar, and R. Timofte. 2018. NTIRE 2018 challenge on spectral reconstruction from RGB images. In: *Proceedings of the Conference on Computer Vision and Pattern Recognition Workshops*, 929-938.
- Arad, B., R. Timofte, O. Ben-Shahar, Y. T. Lin, and G. D. Finlayson, et al. 2020. NTIRE 2020 challenge on spectral reconstruction from an RGB Image. In: *Proceedings of the Conference on Computer Vision and Pattern Recognition Workshops*, 446-447.
- Barber, C. B., D. P. Dobkin, and H. T. Huhdanpaa. 1996. The Quickhull algorithm for convex hulls. *ACM Transactions on Mathematical Software* 22(4): 469-483. Online: <http://www.qhull.org>.
- Chen, C., W. Li, H. Su, and K. Liu. 2014. Spectral-spatial classification of hyperspectral image based on kernel extreme learning machine. *Remote Sensing* 6: 5795-5814.

- Commission Internationale de l'Éclairage. 1964. *CIE Proceedings (1964) Vienna Session, Committee Report E-1.4. Vienna, Austria: Commission Internationale de l'Éclairage.*
- Connah, D., and J. Hardeberg. 2005. Spectral recovery using polynomial models. In: *Proceedings of the Color Imaging X: Processing, Hardcopy, and Applications*, 65-75.
- Galatsanos, N., and A. Katsaggelos. 1992. Methods for choosing the regularization parameter and estimating the noise variance in image restoration and their relation. *IEEE Transactions on Image Processing* 1: 322-336.
- Gat, N. Imaging spectroscopy using tunable filters: A review. 2000. In: *Proceedings of the Wavelet Applications VII*, 50-64.
- Green, R. O., M. L. Eastwood, C. M. Sarture, T. G. Chrien, M. Aronsson, B. J. Chippendale, J. A. Faust, B. E. Pavri, C. J. Chovit, M. Solis, et al. 1998. Imaging spectroscopy and the airborne visible/infrared imaging spectrometer (AVIRIS). *Remote Sensing of Environment* 65: 227-248.
- Hardeberg, J.Y. 2002. On the spectral dimensionality of object colours. In: *Proceedings of the Conference on Colour in Graphics, Imaging, and Vision*, 480-485.
- Heikkinen, V., R. Lenz, T. Jetsu, J. Parkkinen, M. Hauta-Kasari, and T. Jääskeläinen. Evaluation and unification of some methods for estimating reflectance spectra from RGB images. *Journal of the Optical Society of America A* 25: 2444-2458.
- Land, E. H. 1977. The retinex theory of color vision. *Scientific American* 237(6): 108-129.
- Lin, Y. T., and G. D. Finlayson. 2019. Exposure Invariance in Spectral Reconstruction from RGB Images. In: *Proceedings of the Color and Imaging Conference*, 284-289.
- Lin, Y.T., and G. D. Finlayson. 2020. Physically Plausible Spectral Reconstruction. *Sensors* 20(21): 6399.
- Nguyen, R., D. Prasad, and M. Brown. 2013. Training-based spectral reconstruction from a single RGB image. In: *Proceedings of the European Conference on Computer Vision*, 186-201.
- Pan, Z., G. Healey, M. Prasad, and B. Tromberg. 2003. Face recognition in hyperspectral images. *IEEE Transactions on Pattern Analysis and Machine Intelligence* 25(12): 1552-1560.
- Parkkinen, J. P., J. Hallikainen, and T. Jaaskelainen. 1989. Characteristic spectra of Munsell colors. *Journal of the Optical Society of America A* 6: 318-322.
- Qin, J., K. Chao, M. S. Kim, R. Lu, and T. F. Burks. 2013. Hyperspectral and multispectral imaging for evaluating food safety and quality. *Journal of Food Engineering* 118: 157-171.
- Reddy, G. T., M. P. K. Reddy, K. Lakshmana, R. Kaluri, D. S. Rajput, G. Srivastava, and T. Baker. 2020. Analysis of dimensionality reduction techniques on big data. *IEEE Access* 8: 54776-54788.
- Shi, Z., C. Chen, Z. Xiong, D. Liu, and F. Wu. 2018. Hscnn+: Advanced cnn-based hyperspectral recovery from RGB images. In: *Proceedings of the Conference on Computer Vision and Pattern Recognition Workshops*, 939-947.
- Tikhonov, A., A. Goncharky, V. Stepanov, and A. Yagola. 2013. *Numerical Methods for the Solution of Ill-Posed Problems. Berlin/Heidelberg, Germany: Springer Science & Business Media.*
- Veganzones, M., G. Tochon, M. Dalla-Mura, A. Plaza, and J. Chanussot. 2014. Hyperspectral image segmentation using a new spectral unmixing-based binary partition tree representation. *IEEE Transactions on Image Processing* 23: 3574-3589.
- Wandell, B. A. The synthesis and analysis of color images. 1987. *IEEE Transactions on Pattern Analysis and Machine Intelligence* 1: 2-13.
- Xu, P., H. Xu, C. Diao, and Z. Ye. 2017. Self-training-based spectral image reconstruction for art paintings with multispectral imaging. *Applied Optics* 56: 8461-8470.
- Zhang, Y., X. Mou, G. Wang, and H. Yu. 2016. Tensor-based dictionary learning for spectral CT reconstruction. *IEEE Transactions on Medical Imaging* 36: 142-154.



# The use of LED-based illumination for Multispectral Imaging System

Pengpeng Yao<sup>1</sup>, H.C. Wu<sup>1</sup> and John H. Xin<sup>1,\*</sup>

<sup>1</sup> Institute of Textiles & Clothing, the Hong Kong Polytechnic University, pengpeng.yao@polyu.edu.hk, jackhc.wu@polyu.edu.hk, john.xin@polyu.edu.hk

\* Corresponding author: john.xin@polyu.edu.hk

## Abstract

This work investigates the use of full-spectral Light Emitting Diode (LED) as the illumination source in a multispectral imaging system for fabrics. The objective is to completely and accurately collect both spectral and spatial information of the object for subsequent applications such as colour reproduction and image retrieval. In recent years, the advancement of high intensity LEDs brings advantages such as low energy consumption (i.e., less heat), fast response time and low cost to multispectral imaging systems. In the experiment, two main issues are studied with comparisons to the traditional illumination methods, they are colour measurement accuracy and spatial uniformity, as these are the most important properties for the application in fabrics. The experiment results suggest that using LED as the illumination source in a multispectral imaging system is promising, especially for applications in textile and fashion industries.

**Keywords:** multispectral imaging, LED light source, colour measurement

## INTRODUCTION

This work investigates the use of full-spectral Light Emitting Diode (LED) as the illumination source in a multispectral imaging system for fabrics. The objective is to completely and accurately collect both spectral and spatial information of the object for subsequent applications such as colour reproduction and image retrieval. Traditional multispectral imaging system often uses tungsten halogen lamp or xenon lamp as the illumination source, the disadvantages of these lamps are their high temperature during use and long warm-up time for a stable measurement, especially for certain dyes and pigments on fabrics, which are sensitive to heat and thus causing undesired measurement error. In recent years, the advancement of high intensity LEDs brings advantages such as low energy consumption (i.e., less heat), fast response time and low cost to multispectral imaging systems. Moreover, LED can be easily controlled using computer programs. These advantages attracted the usage of LED in multispectral imaging systems in many areas (Li et al. 2012, 2019; Liu et al. 2018).

In contrast to most studies in the literature using an array of LEDs with different colours (e.g., red, green and blue) for illumination (Fu et al. 2015; Park et al. 2007), this study uses a single white LED together with a filter wheel mounted with narrow band filters for capturing monochromatic images in different wavelength ranges (i.e., from 400nm to 700nm with 20nm interval). The filter wheel is placed between the lens and the camera in order to filter the light entering the camera. The measured response of the camera is proportional to the intensity of light entering the sensor. The spectral sensitivity and bias of the system are recovered by a training dataset with known reflectance. The measurement process involves capturing the raw response (data cube) from the monochromatic camera with each of the narrow-band filters, performing white balance using pre-defined colours and white or grey board, reflectance reconstruction and whiteness estimation.

## SYSTEM DETAILS

This section describes the details of the multispectral imaging system including data collection process, LED light source design and formulation for spectral reflectance reconstruction. Figure 1 shows the

optical path of the system which consists of the light source, object (fabric in our study), lens, filter wheel (hosting of the narrow band filters) and camera (to capture the raw response).

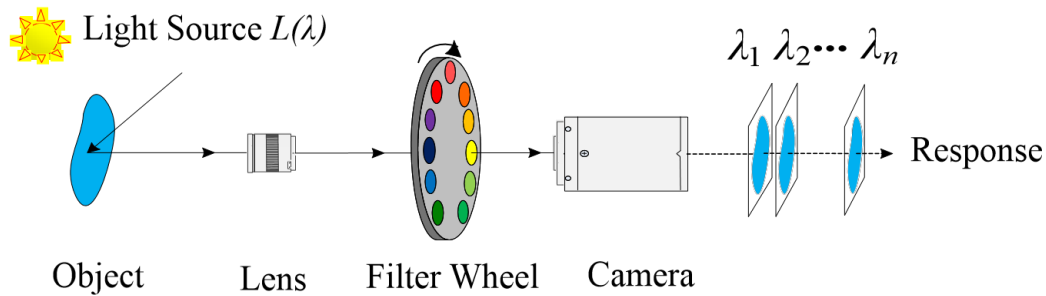

Figure 1: Optical path of the system.

### Data Collection Process

The filter wheel is turned sequentially, and a raw gray image is acquired in each channel. After the raw response is collected, white balance is performed using:

$$resp = \frac{resp(i,j) - dark(i,j)}{white(i,j) - dark(i,j)}$$

where  $i$  and  $j$  denote the location of a particular pixel in the image, *dark* refers to the dark-gray material measurement and *white* refers to the pure white board measurement.

### LED Light Source

Figure 2 shows the design of the LED light source used in this work. It is a LED ring with 2 kinds of emissions, one for white light and another for UV light. Both can be controlled independently. Figure 3 shows the physical placement of various components of the system.



Figure 2: LED ring used as the light source.

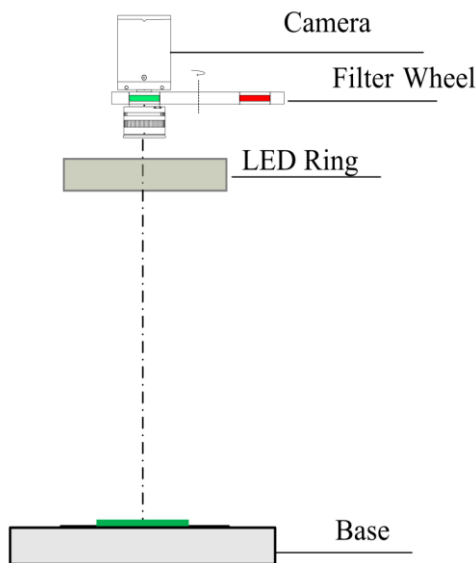

Figure 3: Placement of the system components.

### Spectral Reflectance Reconstruction

The relationship between *response* ( $resp$ ) and *reflectance* ( $refl$ ) can be formulated  $refl = f(resp)$  where  $f$  denotes a function for mapping. In a linear mapping (Barnard and Funt 2002),  $refl = M(resp) + b$  where  $M$  and  $b$  can be solved mathematically under the constraint of positive responsivity. The spectral is reconstructed by the response data using linear regression with L1 penalization method, trained by 144 cotton samples (to be discussed in Experiments section). L1 penalization has proven to be stable with good generalization capability. After the reflectance is reconstructed, tristimulus value XYZ can be obtained by standard CIE equations (Westland et al. 2012).

In multispectral imaging, spatial uniformity is an important factor for colour measurement. Spatial uniformity means that the same material in different coordinate should have the same measurement. In practical, this may not always be the case due to light reflection and the presence of fluorescent whitening agents. The radiance factor of a material can be generally described as

$$p_o(\lambda) = p_r(\lambda) + p_f(\lambda)$$

where  $p_o(\lambda)$  is the radiance factor of the material for a particular channel  $\lambda$ ,  $p_r$  and  $p_f$  are pure reflectance and fluorescence respectively. By definition,  $p_f$  is related to the illumination, absorption ratio and emission ratio. As a single light source is used in the system, the ratio of UV light to visible light is a constant. As a result, the radiance factor will be linearly related to the spectrum of incident light. By using light balance, spatial uniformity can be achieved.

### EXPERIMENTS

In the experiment, two main issues are studied with comparisons to the traditional illumination methods, they are colour measurement accuracy and spatial uniformity, as these are the most important properties for the application in fabrics.

In terms of colour measurement accuracy, reflectance reconstruction using linear regression with L1-penalization has been adopted to estimate the true reflectance. The sample set used are 144

Pantone cotton samples as show in Figure 4. The results of the measurement compared with a Xeon light based multispectral imaging system is shown in Table 1.

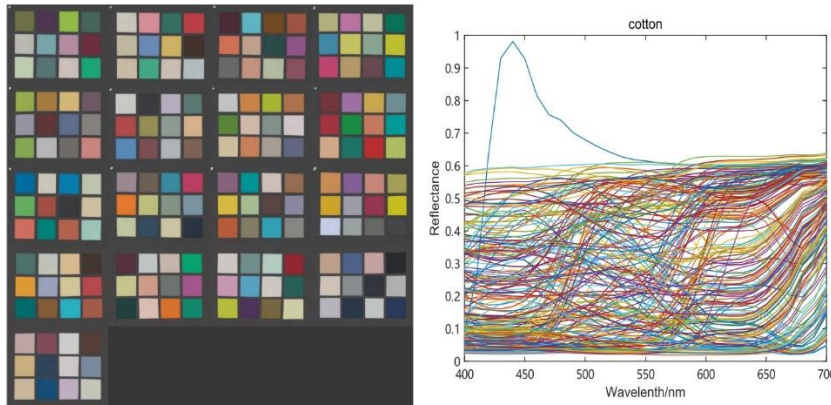

Figure 4: The 144 cotton samples used for calibration and their spectral data measured by spectrometer.

	LED light source	Xeon light source
RMSE	0.024	0.035
dE(CMC 2:1)	0.2	0.3

Table 1: Results of the proposed LED based multispectral imaging system.

In terms of spatial uniformity, a uniform white board is applied to balance the light in different positions of the capturing platform. By post-processing of the camera response, spatial uniformity can be achieved. A theoretical model is also developed and applied in the proposed multispectral imaging system which can ensure the spatial uniformity even for materials with fluorescent whitening agents added (fluorescent whitening agents absorbs light in the ultraviolet region and re-emit light in the visible blue region, which makes measuring of colour and uniformity much more difficult). Figure 5 shows the spatial uniformity result by dividing the imaging platform into 12 areas and measure their whiteness. It is observed that the spectral reflectance is nearly the same for all the 12 parts, as well as the value of whiteness. This proves that our system is indeed spatial uniform.

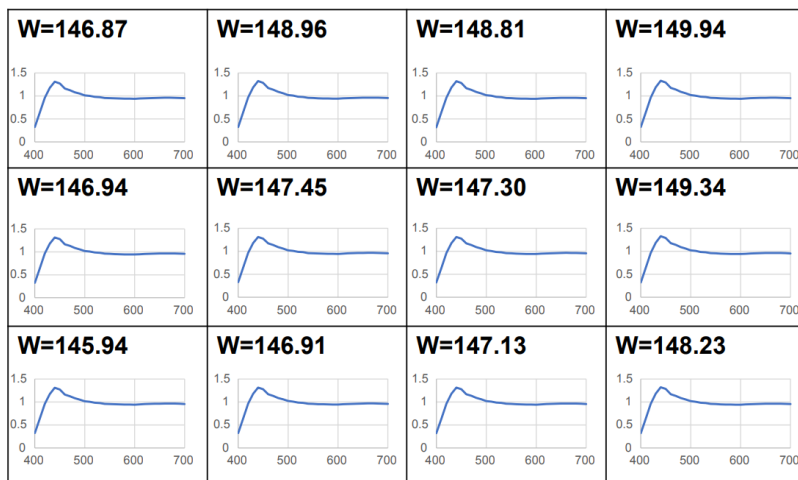

Figure 5: Spatial uniformity results.

## **CONCLUSIONS**

To conclude, a prototype of LED based multispectral imaging system is built for fabric colour measurement. The experiment results show that using LED as the illumination source can provide better colour accuracy measured by root-mean-square error (RMSE). The spatial uniformity is also enhanced due to the fact LED provides a more uniform light source. These results suggest that using LED as the illumination source in a multispectral imaging system is promising, especially for applications in textile and fashion industries.

## **ACKNOWLEDGEMENTS**

This work is supported by Lee Family Endowed Professorship Scheme and project entitled: Study of Wearable Green Smart and Health Related Textile Materials funded by the collaborative platform established between Hong Kong Polytechnic University and Wuyi University of China.

## **REFERENCES**

- Barnard, K., and B. Funt, B. 2002. *Camera characterization for color research*. Color Research & Application: Endorsed by Inter-Society Color Council, The Colour Group (Great Britain), Canadian Society for Color, Color Science Association of Japan, Dutch Society for the Study of Color, The Swedish Colour Centre Foundation, Colour Society of Australia, Centre Français de la Couleur, 27(3), 152-163.
- Fu, Y., A. Lam, I. Sato, T. Okabe, and Y. Sato. 2015. Reflectance and fluorescence spectral recovery via actively lit RGB images. *IEEE transactions on pattern analysis and machine intelligence* 38(7), 1313-1326.
- Li, H., J. Feng, W. P. Yang, L. Wang, H. B. Xu, P.F. Cao, And J. J. Duan. 2012. Multi-spectral imaging using LED illuminations. In: *2012 5th International Congress on Image and Signal Processing*.
- Li, H., G. Li, W. Yan, G. He, And L. Lin. 2019. "Synergy effect" and its application in LED-multispectral imaging for improving image quality. *Optics Communications* 438, 6-12.
- Liu, H., J. Sticklus, K. Köser, H. J. T. Hoving, H. Song, Y. Chen, J. Greinert, and T. Schoening. 2018. TuLUMIS-a tunable LED-based underwater multispectral imaging system. *Optics express* 26(6), 7811.
- Park, J.-I., M.-H. Lee, M. D. Grossberg, and S. K. Nayar. 2007. Multispectral imaging using multiplexed illumination. In: *2007 IEEE 11th International Conference on Computer Vision*.
- Westland, S., C. Ripamonti, and V. Cheung. 2012. *Computational colour science using MATLAB*. New York: John Wiley & Sons.



# Imaging colorimeters to evaluate Camera Monitor Systems

Cristian Bonanomi<sup>1,\*</sup>, Kedar Sathaye<sup>2</sup>

<sup>1</sup> Konica Minolta Sensing Europe; cristian.bonanomi@seu.konicaminolta.eu

<sup>2</sup> Konica Minolta Sensing Europe; kedar.sathaye@seu.konicaminolta.eu

\* Corresponding author: Cristian.Bonanomi@seu.konicaminolta.eu

## Abstract

Over the last few years, we have experienced a gradual increase in autonomous and driver assistance technology. Generally, we refer to systems as ADAS (Advanced driver-assistance systems). A particular aspect of ADAS is Camera Monitor Systems (CMS), a system composed of a camera, a software that performs image processing operations, and a monitor for the driver. These systems help increase the overall safety aspect of the vehicle and increase the visibility of the drivers' surroundings; therefore, the original equipment manufacturers (OEMs) must adhere to country specific regulations, necessary to test the robustness of the system. In this paper we will discuss the various test procedures for CMSs, with particular attention to the optical performance evaluation of the system. This includes lighting system, test patterns and an imaging colorimeter accompanied by a software which performs measurements according to the regulations mentioned in ISO16505:2019 (2019).

**Keywords:** *Advanced Driver-Assistance Systems, Autonomous Driving, Camera Monitor Systems, 2D Colorimeter*

## INTRODUCTION

Over the last few years, we have experienced a gradual increase in autonomous and driver assistance technology. By year 2025, we will see almost 8 million cars with autonomous or semi-autonomous level. The Society for Automotive Engineers (SAE) defines five levels of driving automation, from no automation to full driving automation when talking about vehicles. Beyond these levels, many efforts have been made to provide systems that facilitate enhanced driving situations. Generally, we refer to such systems as ADAS (Advanced driver-assistance systems) as electronic systems that assist users in driving and parking functions.

A particular case of ADAS is the Camera Monitor Systems (CMS), a system composed of a camera, a software that performs image processing operations, and a monitor to illustrate the possible dangers as well as the blind spots around the car, mainly integrated in rear view mirror or side view mirror. These systems help increase the overall safety aspect of the vehicle and increase the visibility of the drivers' surroundings; therefore, the original equipment manufacturers (OEMs) must adhere to country specific regulations, necessary to test the robustness of the system.

In this paper we will discuss about the ISO 16505: 2019 "Road vehicles — Ergonomic and performance aspects of Camera Monitor Systems — Requirements and test procedures", with particular attention to the optical performance evaluation of the system. To ensure image quality, several tests need to be performed to evaluate monitor characteristics e.g. directional uniformity, luminance, color rendering and sharpness, etc. The components (camera and display) can be measured separately, to easily discover where degradation has occurred, however sometimes it is necessary to test the complete system, a task that requires a high-resolution imaging colorimeter.

In the following, we will focus on the materials and methods necessary to test robustness of the system. This will include lighting system to simulate direct sunlight and diffuse sky exposure, test patterns to be used, imaging colorimeter accompanied by a software which performs measurements according to the standard regulations mentioned in ISO16505:2019 (2019). The state-of-the-art imaging colorimeter and the dedicated software ensures that CMS under test is correctly validated.



## **CAMERA MONITOR SYSTEMS**

A CMS is a possible technology to replace exterior mirrors, to display the rear view on a monitor inside a vehicle (see Figure 1).



Figure 1: A CMS is composed by an external camera (on the left) and a display (on the right). A software that performs image processing operations completes the system.

However, since exterior mirrors are fundamental for the safety, it is important to evaluate if a CMS can be a source of reduced safety or provide equal or more information to the driver. Generally, a CMS improves the aerodynamics of the vehicle decreasing wind resistance coefficient and noise. Furthermore, it reduces the blind zone area, improving the safety of driving.

In 2015 an extensive work by Schmidt et al. (2015) was done to evaluate CMS as replacement for exterior mirrors in cars and trucks. The authors tested technical aspects as well as human-machine interaction scenarios. Although it has only been six years since the report, many technical issues have been overcome, though some of the aspects underlined in this document are still of interest and concern. We recall some of them in the following, leaving to the reader the task of reading the complete report.

Both external mirrors and CMSs have advantages and disadvantages. Some of these are related to technical aspects, such as optical quality; for example, resolution, color and contrast rendering, or time behavior properties that happen in critical situations. Additional aspects such as exposure adjustments when entering or exiting from a tunnel, or when a road surrounded by trees creates a succession of shadows and sunny areas. These situations and aspects are improved thanks to technological advancements.

Other aspects are related to intrinsic properties of the two systems: a mirror follows the reflection law, and movements of the head can add 3D information to the driver, while these movements do not affect the vision on a display.

Furthermore, weather conditions can affect the two systems in different way: under the rain, the drops on the driver's side window as well on the mirror itself can reduce the mirror visibility, while this condition seems to affect the CMS less, if the camera is in a well-covered position and since the display is inside the vehicle. Direct sunlight, snow or night driving are other non-standard conditions that must be considered.

Finally, there are aspects related to the human-machine interaction: some experiments with human drivers have been carried out, resulting in a different perception of speed and distance when objects are viewed through a CMS. However, generally, people can adapt quite quickly to this new situation.

All these aspects need consideration when using a CMS, therefore a procedure performing a range of tests on these systems has been developed in ISO16505:2019 (2019).

In the following section we are going to describe these tests as well as considering the equipment that can be used for these various applications.

### TESTING CAMERA MONITOR SYSTEMS

Testing Camera Monitor Systems requires several items: 1) test charts to evaluate different properties of the CMS. These charts can be found in specialized stores (i.e. Imatest 2021); 2) illumination of the charts, to simulate different lighting conditions; 3) the CMS camera installed outside of the car; 4) the computer that elaborates the data of the camera; 5) the CMS monitor used by the driver; 6) a camera or a 2D colorimeter to evaluate the result of CMS monitor and 7) a light source that illuminates the monitor, to simulate i.e., direct sunlight.

An image presenting the setup and the necessary elements for evaluating the image quality of the CMS is shown in Figure 2.



Figure 2: The image shows how to evaluate a CMS. Here two different environments are represented: on the left side the CMS camera is tested. On the right side is tested the CMS display. Please note that to keep the scheme simple, additional material for specific tests is missing, i.e., light sources to illuminate the CMS display.

The evaluation of a CMSs requires several tools and a dedicated facility. Therefore, these tests usually are conducted directly by OEM (Original Equipment Manufacturer) or by specialized independent third-party laboratories. These laboratories provide technical services offering verification, inspection and certification of various products in accordance with international and national standards as well as audits for systems management certification (i.e., TUV 2021).

In the following we are going to address the previous elements, with particular attention to the evaluation of the optical characteristics of the CMS system. These tests can be divided in four sets: 1) to verify the basic characteristics of the display like luminance, contrast and uniformity; 2) to evaluate potential issues related to the driving conditions: readability of the display, lens flare due to direct light, etc.; 3) to ensure the colors are correctly reproduced, i.e., for identifying the traffic lights; and 4) to assess the resolution and sharpness of the system, in order to identify details.

### **Monitor Isotropy**

This test aims at evaluating the optical characteristics of the display according to different positions and viewing directions, using a uniform 70% gray scale image. Measurements of the directional uniformity are performed using a goniometer or a conoscope. A conoscope is a special lens that can be attached to a 2D colorimeter to measure the angular distribution of luminance, contrast and color of a display. Lateral uniformity is measured on 9 points which coordinates are specified in the standard.

### **Luminance and contrast rendering**

The evaluation of luminance and contrast rendering is done on five different ambient illumination conditions that can affect the monitor readability. These conditions simulate: direct sunlight, diffuse sky-light in day condition, night condition and sunset condition.

Generally, a test chart composed by a white and black chessboard, is illuminated by two light sources, with a defined spectral power distribution, color temperature and illuminance value.

The sunset condition is simulated using a direct light source reflected in a mirror towards the camera, to evaluate artifact like blooming, smear and flare.

### **Color rendering**

This test is used to verify the CMS capability to reproduce eight specific colors (red, green, blue, yellow, cyan, magenta, black and white, placed on a 18% neutral gray background), in an accurate way. To this purpose, a spectroradiometer or a colorimeter should be used to measure the color of the chart as well of the CMS monitor and convert them to the CIE 1976 uniform color space. The measurements done on the monitor are converted in chromatic hue angle to verify that they are in the correct range.

### **Sharpness**

Other important tests of CMS regard the sharpness and the related properties: resolution and depth of fields. Sharpness is measured evaluating the  $MTF_{50(1:1)}$  (modulation transfer function) of a chart composed by five black squares slightly tilted. In order for CMS to recognize object of interested behind the vehicle, the depth of field needs to be measured.

## ***USING A COLORIMETR FOR CMS EVALUATION***

All the mentioned tests need a specific instrument able to inspect luminance, color and fine-detail. A spot meter device (both a filter-based chroma meter or a spectro-radiometer) could be used, due to its capability of measuring the luminance and color in an accurate way. However, doing repeated measurements is time consuming and spatial measurements, like sharpness or blooming test, cannot be performed. On the other hand, a digital camera can provide high resolution images, but cannot measure accurate luminance or traceable color rendering. To follow this standard, color accuracy is an extremely important factor, and digital cameras, which are typically used in consumer photography, are designed to please the viewers, enhancing color saturation, a different concept from accurate color rendering. Furthermore, the color generation in digital cameras is achieved by a Bayer pattern, and the process of raw conversion can affect color.

An imaging colorimeter, also known as 2D colorimeter, (Figure 3) is the optimal solution to evaluate the image characteristic of the CMS, since it comprises the accuracy of a chroma meter and the flexibility of a digital camera. The color measurement is done through four filters that carefully simulate the CIE color matching functions. The fourth filter is used to simulate the small peak of the  $\tilde{x}$  CMF in the blue side of the spectrum. These filters are placed on a rotating filter wheel, so that four

different images are taken, to maximize resolution without spatial interpolation, as happen in typical digital cameras. This is a key point to consider, since for testing CMS, the 2D colorimeter needs much higher resolution than the camera and monitor that constitute the CMS.

Another significant point requested by the standard is the necessity to evaluate the directional uniformity of the monitor. Some colorimeters allow the use of a special conoscopic lens (fig 3, right), which through Fourier optics can map an emitting spot so that each pixel of the sensor corresponds to a different emission angle.



Figure 3: Bidimensional colorimer with standard lens (left) and with conoscopic lens (to measure angular uniformity).

Radiant Vision Systems provides hardware that fulfills the standard requirements and a comprehensive software suite to evaluate Camera Monitor Systems.

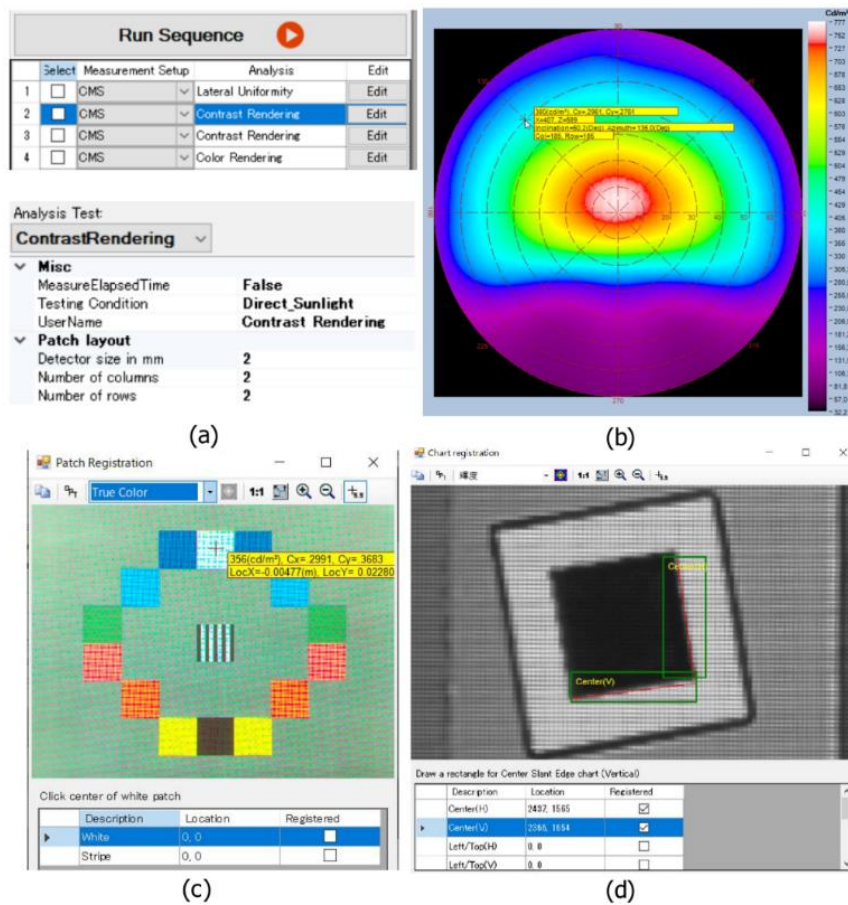

Figure 4: Images from the software for CMS evaluation. (a): interface of the software to select an analysis test and parameters to set; (b): directional uniformity, taken with conoscopic lens; (c) color rendering; (d) MTF evaluation.

In figure 4 some screenshots from the software are presented, which shown the capture of different charts according to the specific test. Figure 4a) shows the interface which allows the selection of an Analysis test (top image), and the parameters that can be set for the specific function (bottom image). In the example, the test “Contrast rendering” is selected where among all the possible lighting conditions “Direct sunlight” is used, to reflect one of the standard requirements. Figure b) shows an image taken with the conoscope. This is a false color representation of the luminance in a point, expressed in polar coordinates. For the display under test, the luminance decreases with the angular viewing. When observed perpendicularly (white area), the luminance is around 700 cd/m<sup>2</sup>. At the cursor point, with coordinates [Inclination 50°, Azimuth 135°], luminance is around 380 cd/m<sup>2</sup>. Figures c) and d) are two different acquisitions of the color rendering chart and the MTF evaluation chart respectively. The software helps the user to correctly register the patches, and after the execution of the analysis, returns a pass/fail result according to the standard requirements.

## **CONCLUSIONS**

In this paper we have seen how CMSs offers technological innovation yet create a set of new challenges for inspection that must be validated for the use in advanced levels of autonomous driving. Since replacing side and rear mirrors is a safety concern, a complete protocol to test these systems new technology platforms is necessary. The primary aim of ISO16505:2019 (2019) is to offer a guide to evaluate in an objective and critical way the quality and reliability of the CMSs. In the paper, we focused on the optical properties’ evaluation and on the necessary tools that an OEM or a third part laboratory should use to carry on these tests.

## **ACKNOWLEDGEMENTS**

The authors would like to thank Weiyu Shao (Felix) and Yusaku Kawahara for providing some of the material used in this paper, and Matt Scholtz for the constant support and guidance.

## **REFERENCES**

- Imatest – Digital Image Quality Testing, “Camera Monitor Systems”, Accessed June 2021.  
<https://www.imatest.com/solutions/camera-monitor-systems/>
- ISO 16505:2019. “Road vehicles — Ergonomic and performance aspects of Camera Monitor Systems — Requirements and test procedures”. Accessed June 2021.  
<https://www.iso.org/standard/72000.html>
- Schmidt, E. A., H. Hoffmann, R. Krautscheid, M. Bierbach, A. Frey, J. Gail and C. Lotz-Keens. 2015. Final report: camera-monitor systems as a replacement for exterior mirrors in cars and trucks. *Federal Highway Research Institute*, 91p.
- TUV, “Camera Monitor Systems for the Automotive Industry”, Accessed June 2021.  
<https://www.tuv.com/japan/en/camera-monitor-systems-for-the-automotive-industry.html>

# Analysis of Biases in Automatic White Balance Datasets

Simone Bianco <sup>1</sup>, Marco Buzzelli <sup>1,\*</sup>, Gianluigi Ciocca <sup>1</sup>, Raimondo Schettini <sup>1</sup>, Mikhail Tchobanou <sup>2</sup> and Simone Zini <sup>1</sup>

<sup>1</sup> University of Milano - Bicocca; simone.bianco@unimib.it, marco.buzzelli@unimib.it, gianluigi.ciocca@unimib.it, raimondo.schettini@unimib.it, s.zini1@campus.unimib.it

<sup>2</sup> Moscow Research Center, Huawei Technologies Co. Ltd; Mikhail.Tchobanou@huawei.com

\* Corresponding author: marco.buzzelli@unimib.it

## Abstract

Learning-based methods for Automatic White Balance (AWB) are trained on properly-annotated datasets, where each image is associated to a ground truth illuminant. The intrinsic characteristics of such datasets, therefore, play a fundamental role in the generalization capability of the resulting AWB model. In this paper we analyze the biases of commonly-used datasets for Automatic White Balance: ColorChecker, Cube+, Gray Ball, INTEL-TAU, and NUS from National University of Singapore. We describe each dataset in terms of employed cameras, distribution of the illuminants, shooting parameters, and image content. The resulting analysis highlights the individual shortcomings of each dataset, as well as the type of image that is under-represented by all analyzed datasets, such as artificial-light and low-light scenarios.

**Keywords:** *Automatic white balance, illuminant estimation, color constancy, dataset analysis.*

## INTRODUCTION

Automatic White Balance (AWB), sometimes referred to as computational color constancy, is the task of correcting a digital image as if the scene was captured under some reference illumination conditions. The development and benchmarking of AWB algorithms is based on the availability of datasets of images whose illuminant ground truth is given, or which can be easily estimated from a color target placed in the scene. In this paper we analyze the most commonly used datasets in order to verify if there is a bias in the illuminant chromaticity distributions, in shooting conditions, and in the semantic image content distribution. Image content is considered important as it is often exploited to various extents by different AWB algorithms, such as Gijsenij et al. (2010), Bianco et al. (2008) and (2012), and Buzzelli et al. (2018).

We consider our investigation necessary since the presence of a bias in the image datasets used in the AWB research not only may invalidate the evaluation of the methods available in the state of the art, but it is increasingly critical as almost all of the new methods are based on machine learning algorithms as shown by Ershov et al. (2021). The dependencies, cross-talks and deficiencies that we have found across all datasets suggest possible directions for the design of novel AWB methods and for future data collection.

## ANALYZED DATASETS

For the analysis of this paper, we focused on five datasets considered relevant in the state of the art research for Automatic White Balance. Their main characteristics are reported in Table 1.

Title	Year	Cameras	Images	Reference target
ColorChecker (Gehler et al.)	2008	2	568	24-patch Macbeth Color Checker
Cube+ (Banić et al.)	2014	1	1707	Datacolor SpyderCUBE
Gray Ball (Ciurea and Funt)	2003	1	11346	Gray sphere
INTEL-TAU (Laakom et al.)	2019	3	7022	X-Rite ColorChecker Passport chart
NUS (Cheng et al.)	2014	9	1853	24-patch Macbeth Color Checker

Table 1: Analyzed datasets for Automatic White Balance, with their main characteristics.

- ColorChecker** by Gehler et al. (2008).  
 The dataset is composed of 568 images. Of these, 86 were shot with a Canon EOS-1DS, and the remaining 482 with a Canon EOS 5D. All images include in the frame a 24-patch Macbeth Color Checker target. Multiple versions of the ground truth of this dataset have been proposed through the years, such as the ‘reprocessed’ version by Shi and Funt (2012), and the more recent ‘recommended’ version by Hemrit et al. (2018), which has been used in this work.
- Cube+** by Banić et al. (2017).  
 This dataset contains all 1365 images of previous the “Cube” dataset and additional 342 images, for a total 1707 images, shot using a Canon EOS 550D camera. In the lower right corner of each image, the SpyderCube calibration object is placed. Its two neutral 18% gray faces were used to determine the ground-truth illumination for each image, thus providing two annotations per image, with one manually selected by the original authors as better representative for the corresponding scene.
- Gray Ball** by Ciurea and Funt (2003).  
 The dataset contains 11,346 images divided into 15 sequences, with many shots acquired at close interval one from another. Many of the images depict people, and include both indoor and outdoor scenarios, the latter taken in two different locations. The dataset was collected using a Sony VX-2000 digital video camera, and every shot includes the eponymous gray ball color target for ground truth annotation in the bottom-right corner. The images are provided in non-linear 8bit RGB format.
- INTEL-TAU** by Laakom et al. (2019).  
 This dataset is a set of 7022 images in total, captured using three different camera models: Canon 5DSR, Nikon D810, and Sony IMX135. It is the updated version of INTEL-TUT, which was released and later withdrawn due to non-compliance with privacy regulations. The ground truth of each image is defined through a separate set of images, captured in the same scenes but not included in the actual database, depicting s a X-Rite ColorChecker Passport chart reflecting the main illumination source.
- NUS** by Cheng et al. (2014).  
 Collected by the National University of Singapore (NUS), this dataset is composed of a total 1853 images, shot with 9 different cameras: Canon EOS-1Ds Mark III (259 images) Canon EOS 600D (200 images) Fujifilm X-M1 (196 images) Nikon D40 (117 images) Nikon D5200 (200 images) Olympus E-PL6 (208 images) Panasonic Lumix DMC-GX1 (203 images) Samsung NX2000 (202 images) and Sony SLT-A57 (268 images). All images include a 24-patch Macbeth Color Checker target.



## ILLUMINANT CHROMATICITY DISTRIBUTIONS

In order to compare existing datasets on equal ground, it is necessary to consider the different spectral sensitivities of the sensors involved in their acquisition, i.e., to map the dataset illuminants into a device-independent color space by normalizing them to a reference white, for which we chose CIE D55. INTEL-TAU is the only dataset providing a colorimetric characterization of the employed cameras, for which we could accurately compute the corresponding reference white using the D55 spectrum from the Light Spectral Power Distribution Database by Roby and Aubé (2015). For the remaining datasets, we referred to a definition by Luo (2016), according to which “illuminant D55 can be assumed to represent the SPD for (direct) sunlight provided that the sun is not too low in the sky”. We thus handpicked for each camera an image that best-represents the adopted definition, relying on metadata such as timestamp and location to reinforce our selection, and chose the corresponding annotation as reference white in RAW-specific RGB form. These values were finally used to normalize all the datasets illuminants using a Von Kries-like transform, and were eventually plotted in the Angle-Retaining Chromaticity diagram by Buzzelli et al. (2020) to avoid any representation-specific distortion of the data. The result is presented in Figure 2, with reference whites reported in the legend as R/G and B/G chromaticity pairs, as well as non-normalized points indicated by an  $\times$  symbol.

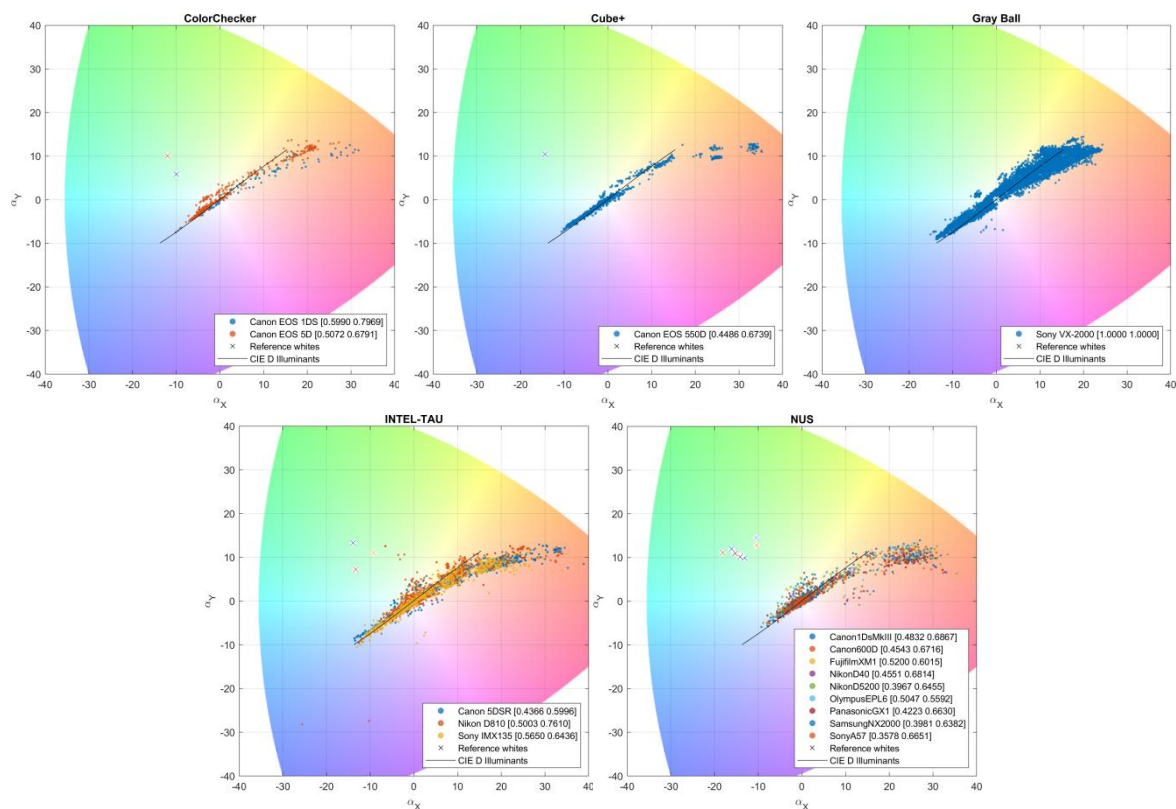

Figure 1: Illuminant distributions for five AWB datasets, normalized by sensor-specific D55 reference whites.

For further reference, CIE series D illuminants from D40 to D150 have also been reported in each plot. It is possible to observe how all analyzed datasets roughly follow the distribution of daylight illuminants, eventually contributing with additional data points at low Correlated Color Temperatures (CCT), typically found in indoor scenarios illuminated by incandescent light sources. The area of high CCTs, commonly covered by outdoor in-shadow surfaces, appears to be better represented by the Gray Ball dataset, and by the more recent INTEL-TAU dataset. Finally, the direction orthogonal to the axis

defined by CIE series D illuminants, i.e. ranging from greenish to magenta-ish lights, is poorly represented by all the analyzed datasets. Collecting data from such range of non-natural light sources could be potentially useful in conducting research on human perception.

### SHOOTING PARAMETERS AND ILLUMINATION LEVELS

We have characterized the five AWB datasets in terms of illumination levels, i.e. low-light to bright-light conditions, following two complementary approaches. With the first approach, we extracted shooting parameters from EXIF data, whose distributions are reported in Figure 2 (please, note that EXIF data are not available for the sRGB-encoded Gray Ball dataset, and that no ISO information was found for images from the Sony IMX135 camera of the INTEL-TAU dataset). Under the assumption of properly-set camera parameters, these pieces of information can be exploited to produce an estimation of the scene illumination according to Le et al. (2019):

$$I_{measure} = \log_{10} \left( \frac{aperture^2}{exposure\ time} \right) + \log_{10} \left( \frac{250}{ISO} \right). \quad (1)$$

The resulting distribution is shown in Figure 3 (left). Alternatively, the scene illumination conditions can be inferred by classifying the images into discrete labels, such as: “Highlight”, “Lowlight”, and “Sunset/Sunrise”. This information, shown in Figure 3 (right), has been obtained by training an unpublished Convolutional Neural Network (CNN) on a proprietary dataset of annotated images, and applying it to sRGB-rendered white-balanced images from the AWB datasets.

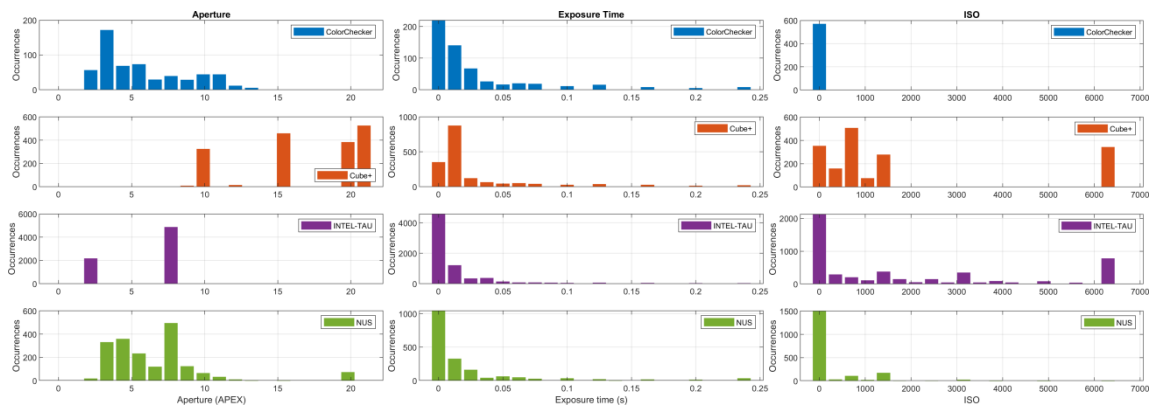

Figure 2: Shooting parameters distributions for the analyzed AWB datasets: Aperture, Exposure Time, and ISO.

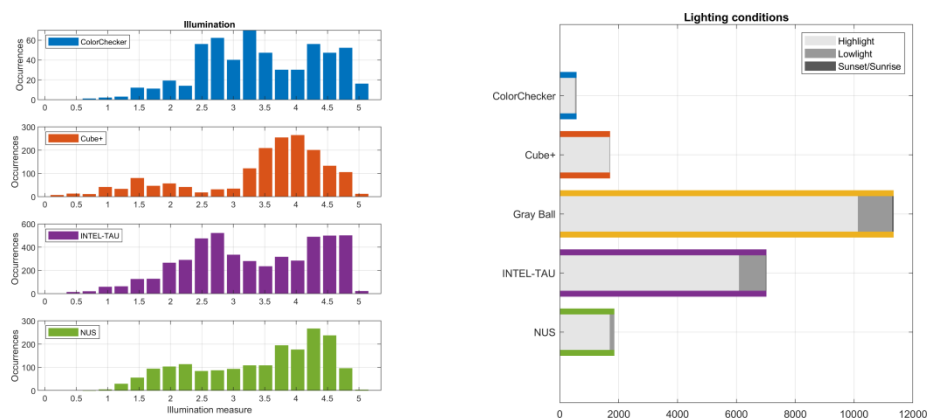

Figure 3: Illumination conditions computed by means of shooting parameters (left) and image analysis (right).

Without loss of generality, it is possible to observe that both independent analyses show a general predominance for bright light scenarios. Middle-to-low light scenes are partially represented by the INTEL-TAU dataset, by the Gray Ball dataset (only supported by classification-based analysis), and to some extent by the ColorChecker dataset, although its low number of total images must also be taken into consideration. Finally, the Sunset/Sunrise scenario is scarcely covered across all datasets. We argue that such extreme imaging conditions are particularly relevant for real-life applications, as consumer devices equipped with AWB modules are found to often produce sub-optimal results in these set-ups.

## IMAGE CONTENT

We have further analyzed the datasets in terms of image content. Following the same procedure described in the previous Section, we have trained three CNNs on a proprietary annotated dataset, and we have performed inference on white-balanced images from the five AWB datasets. The aggregated results are presented in Figure 4.

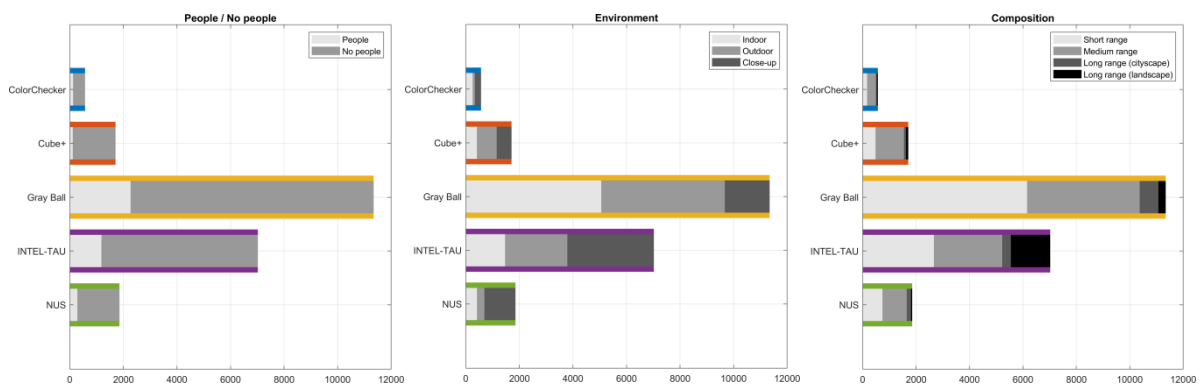

Figure 4: Image content distribution of the AWB datasets, according to three different sets of classes.

The amount of images depicting human subjects is relatively small, a problem partially related to privacy-protecting instruments such as the General Data Protection Regulation (GDPR). Note that, due to automatic annotation, some false positives (related to statues, posters, etc.) might occur, such as in the Cube+ dataset which is known not to contain any proper human subject. The INTEL-TAU dataset depicts a relevant number of people, however their faces are censored with an average-color mask, thus preventing the application of some semantic-based AWB methods, such as the one developed by Bianco et al. (2012). Finally, in terms of environments (indoor, outdoor, and close-ups) and composition (close-to-long range), all datasets appear to be well-balanced.

## CONCLUSIONS

We have compared the most popular datasets for Automatic White Balance in terms of illuminant distribution, shooting parameters, and image content. We have highlighted the individual shortcomings of each dataset, thus suggesting the opportunity to merge multiple datasets into a more-complete set of images. For sensor-dependent AWB methods, this type of fusion can only be exploited by bringing the datasets into a common representation. To this extent, a set of reference white points has been compiled for each involved sensor and shared within this manuscript.

Deficiencies have been found across all datasets, such as a lack of images illuminated with artificial light sources and/or low-light images, indicating a direction for future data collection.

An analysis on image content has also been provided. As a future development, it would be valuable to extract similar statistics on non-AWB datasets that well-represent common user photographic collections, in order to compare their content distributions.

## ACKNOWLEDGEMENTS

This work is part of a research collaboration between the Imaging and Vision Laboratory from University of Milano - Bicocca, and the Moscow Research Center from Huawei Technologies Co. Ltd.

## REFERENCES

- Banić, N., K. Koščević, and S. Lončarić. 2017. Unsupervised learning for color constancy. *arXiv preprint arXiv:1712.00436*.
- Bianco, S., G. Ciocca, C. Cusano, and R. Schettini. 2008. Classification-based color constancy. In: *International Conference on Advances in Visual Information Systems*, Springer, Berlin, Heidelberg, pp. 104-113.
- Bianco, S., and R. Schettini. 2012. Color constancy using faces. In: *2012 IEEE Conference on Computer Vision and Pattern Recognition*, IEEE, pp. 65-72.
- Buzzelli, M., J. van de Weijer, and R. Schettini. 2018. Learning illuminant estimation from object recognition. In: *2018 25th IEEE International Conference on Image Processing*, IEEE, pp.3234-3238.
- Buzzelli, M., S. Bianco, and R. Schettini. 2020. ARC: Angle-Retaining Chromaticity diagram for color constancy error analysis. *JOSA A*, 37(11), 1721-1730.
- Cheng, D., D. K. Prasad, and M. S. Brown. 2014. Illuminant estimation for color constancy: why spatial-domain methods work and the role of the color distribution. *JOSA A*, 31(5), 1049-1058.
- Ciurea, F., and B. Funt. 2003. A large image database for color constancy research. In: *Color and Imaging Conference*, Society for Imaging Science and Technology, Vol. 2003, No. 1, pp. 160-164.
- Ershov, E., A. Savchik, I. Semenov, N. Banić, K. Koščević, M. Subašić, A. Belokopytov, A. Terekhin, D. Senshina, A. Nikonov, Z. Li, Y. Qian, M. Buzzelli, R. Riva, S. Bianco, R. Schettini, J. T. Barron, S. Lončarić, and D. Nikolaev. 2021. Illumination estimation challenge: The experience of the first 2 years. *Color Research & Application*, 46(4), 705-718.
- Gehler, P. V., C. Rother, A. Blake, T. Minka, and T. Sharp. 2008. Bayesian color constancy revisited. In: *2008 IEEE Conference on Computer Vision and Pattern Recognition*, IEEE, pp. 1-8.
- Gijsenij, A., and T. Gevers. 2010. Color constancy using natural image statistics and scene semantics. *IEEE Transactions on Pattern Analysis and Machine Intelligence*, 33(4), 687-698.
- Hemrit, G., G. D. Finlayson, A. Gijsenij, P. Gehler, S. Bianco, B. Funt, M. Drew, and L. Shi. 2018. Rehabilitating the colorchecker dataset for illuminant estimation. In: *Color and Imaging Conference*, Society for Imaging Science and Technology, Vol. 2018, No. 1, pp. 350-353.
- Laakom, F., J. Raitoharju, J. Nikkanen, A. Iosifidis, and M. Gabbouj. 2021. Intel-tau: A color constancy dataset. *IEEE Access*, 9, 39560-39567.
- Le, Q. T., P. Ladret, H. T. Nguyen, and A. Caplier. 2019. Large Field/Close-Up Image Classification: From Simple to Very Complex Features. In: *International Conference on Computer Analysis of Images and Patterns*, Springer, Cham, pp. 532-543.
- Luo, M. R. (Ed.). 2016. *Encyclopedia of color science and technology*. Springer New York.
- Roby, J., and M. Aubé. 2015. *LSPDD | Light Spectral Power Distribution Database*. Online: <https://lspdd.org/app/en/lamps?lampuse=Standard%20Illuminant>. Last accessed: June 21, 2021.
- Shi, L., and B. Funt. 2012. *Shi's Re-processing of Gehler's Dataset*. Online: [https://www2.cs.sfu.ca/~colour/data/shi\\_gehler/](https://www2.cs.sfu.ca/~colour/data/shi_gehler/). Last accessed: June 23, 2021.

# Chromatic Weibull Tone Mapping for Underwater Image Enhancement

Chloe A. Game<sup>1,\*</sup>, Michael B. Thompson<sup>2</sup> and Graham D. Finlayson<sup>3</sup>

<sup>1</sup> University of East Anglia, UK; chloe.game@uea.ac.uk

<sup>2</sup> Gardline Ltd., UK; michael.thompson@gardline.com

<sup>3</sup> University of East Anglia, UK; g.finlayson@uea.ac.uk

\* Corresponding author: chloe.game@uea.ac.uk

## Abstract

Image enhancement is often used to alleviate the low contrast, blurring and colour reduction effects, common in underwater imagery. Tone Mapping, a particularly simple yet elegant enhancement technique improves image quality by modifying image histograms to a more desirable tonal distribution. In previous work, we presented our novel chromaticity-preserving algorithm, Weibull Tone Mapping (WTM), that can simplify custom tonal manipulations, to increase conspicuousness of image features. In this paper, we present a natural non-chromaticity preserving counterpart, in which the WTM tone map is applied to all colour channels (R,G,B). We demonstrate, as before, that user's prefer WTM to unenhanced images. However, contrary to prior work, our non-chromaticity preserving WTM is less preferred to custom tonal manipulations. Thus, how we map the colour aspect of images (given a brightness only tonal adjustment) has a significant impact on users' subjective preference judgements.

**Keywords:** *Underwater image enhancement, Tone mapping, Histogram Specification, Weibull Distribution*

## INTRODUCTION

Exploring underwater environments with imagery has a historic past, with the first underwater photographs taken in the 19<sup>th</sup> century (Ruppé and Barstad 2013: 22). Although a long-established tool, and technology continues to advance, imaging science still struggles with increased wavelength absorption and scattering with water depth, resulting in poor quality images, that may be dark, lacking contrast, blurry and de-saturated. Extracting biological information, by annotation and enumeration of image features (seafloor organisms), therefore remains hindered.

Improving image quality, through post-processing, can offer a solution (Schettini and Corchs 2010). Tone mapping, an intuitive and often simple enhancement method, offers a fast approach to suppress unwanted lighting effects and improve the conspicuity of image features. It involves the use of a transform function, or tone curve, that alters image pixel values to render an image more pleasing and of better quality. Certain distributions of pixel values have been linked to image quality (Zuiderveld 1994; Game et al. 2020). Information theory dictates that a flatter distribution contains more information or entropy – requiring more bits to encode (Shannon 1948). In a visual sense, this translates to increased contrast, with maximum contrast achieved when all bins in an image histogram contain equal values, as is the case with Histogram Equalization (HE). However, the slopes of tone curves – that when applied to an image, lead histograms to be uniform - are often very high or low, causing over-enhancement of contrast and contouring artefacts, and loss of details. In Contrast Limited Histogram Equalization (CLHE) (Zuiderveld 1994), the slope of the tone curve is bounded between a minimum and maximum value, thus weakening the compression and stretching of pixel values. In Figure 1a we show an input image with low image contrast. After enhancing the image by applying a HE and CLHE tone curve, we can there is a notable increase in image contrast in (b) and (c). However,

in the case of HE, the resulting image is oversaturated and noisy, whereas CLHE enhancement is more restricted, suitable and preferred.

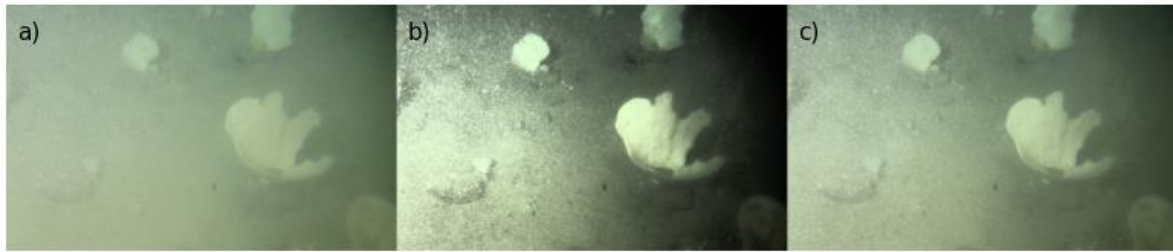

Figure 1: Comparison of an unenhanced image (a) followed by its HE (b) and CLHE (c) tone-mapped output. CLHE min and max slope thresholds were set to 2.56/256 and 0.768/256, respectively.

Underwater image histograms typically possess a bell-shaped distribution, tapering to zero at the ends. Forcing histograms in to a uniform ‘flat’ shape, may therefore be inappropriate, resulting in abnormal brightness or colour changes. Instead, tone mapping operations that preserve the natural characteristics of underwater images, such as the dark pixels, whilst enhancing details within the spot illumination would be better suited to this application. This was the motivation for using a Weibull distribution (WD) to model the brightness statistics of underwater images (Game et al. 2020).

The WD is a smooth, unimodal distribution, parameterized by two parameters that control the location of the peak and spread of the distribution. It is not unlike the Rayleigh distribution (RD), that has been used to enhance underwater images previously (Eustice et al. 2002), however it is more general and we found it was more applicable to our data.

In Game et al. (2020) we described tonal manipulations made by end-users to enhance visibility of specific seabed features for their analyses and demonstrated that they can be modelled and in fact simplified by the WD, using our Weibull Tone Mapping (WTM) algorithm. Significantly, the user and the WD approximations are carried out in the brightness domain. Thus, how a brightness adjustment can be applied to a colour image needs to be considered. In Game et al. (2020), the image brightnesses were modified such that the image chromaticities were preserved.

The starting point for this paper was our recent realization that the user manipulations themselves were not chromaticity preserving. Rather, the output images were calculated by applying the same tone map – that mapped the input brightness image to the corresponding output - to each of the R, G and B channels. Candidly, the discrepancy between how WTM images and the users own custom adjustments were colour rendered was due to our incomplete understanding of the imaging platform we used (GIMP). Thus, in this paper, we re-run our preference experiment. We now consider image preferences for an original image, the user’s own adjusted image and the WTM solution. Where, in the latter two cases the respective tone curves are calculated in a brightness channel and then applied to all three channels (non-chromaticity preserving).

## **BACKGROUND**

As defined in (Game et al. 2020), Weibull Tone Mapping (WTM) involves approximating the brightness histograms (sum normalized to 1) of an input and output (enhanced) image, with a Weibull Distribution (WD), and then solves for the curve that maps the former distribution to the latter, see (Game et al. 2020) for detailed algorithmic steps. In Figure 2 we show an example of this. An input histogram and its user-adjusted output, are presented as dashed lines in 2a. & c, with the best matching WD to these

target distributions shown as a solid line. The probability density function (PDF) of the WD is given in closed form by

$$PDF_W = \frac{k}{\lambda} \left(\frac{v}{\lambda}\right)^{k-1} e^{-(v/\lambda)^k}, \quad v \geq 0, \lambda > 0, k > 0 \quad (1)$$

where  $v$  is the brightness value,  $k$  is the shape parameter and  $\lambda$  is the scale parameter. The two parameters relate to peak position ( $k$ ) and spread ( $\lambda$ ), and can thus be ‘broadly’ understood to control contrast and brightness. Due to the high similarity of the WD to the input-output brightnesses, we can see that the target (user) tone map in 2b. - that transforms the input histogram to the enhanced output- is closely modelled by the derived WTM curve, but it is a little smoother.

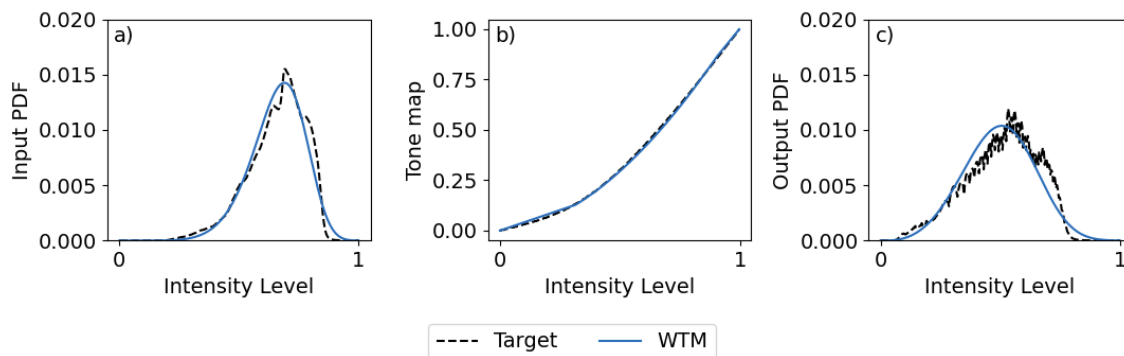

Figure 2: Example of the WTM method. WTM approximations of an input PDF and custom (output) PDF are shown in a) and c), respectively. The user tone map and derived WTM tone map are shown in b).

Given that WTM, and indeed other enhancement algorithms, are designed to improve appearance of imagery for an end-user, it is important to validate their performance in this context. A typical and effective method is to consider the preferences of end-users in a paired comparison experiment. Thurstone (1927) theorized that although paired comparisons are subjective and preference may be inconsistent across pairs, a frequent preference response often exists and can be described statistically. Frequency matrices of preference votes are simply converted to proportional values and sampled from a normal distribution, giving standard Z-scores. As demonstrated in Game et al. (2020), this allows the stimuli (image variants in this case) to be ranked and a preferred type to be identified by end-users. In this case, it was found that a WTM simplification of user tonal adjustments, is preferred for the interpretation of underwater imagery.

### **Making colour tone-mapped images**

In the original study (Game et al. 2020), after tone mapping with the WTM curve, they calculated an RGB colour image by multiplying, the red, green and blue pixel values, by the same scalar - a ratio of the output over the input brightnesses. Specifically, it is calculated as

$$L_{out}(x, y) = L_{in}(x, y) \left( \frac{L_{out}(x, y)}{L_{in}(x, y)} \right) \quad (2)$$



where  $L_{in}(x, y)$  and  $L_{out}(x, y)$  represent an input brightness image and a WTM-mapped brightness image, and  $\underline{I}_{in}(x, y)$  and  $\underline{I}_{out}(x, y)$  denote the input and output 3 channel RGB images (underscoring denotes a vector function). Note that we define brightness here as  $\max(R, G, B)$ , i.e.  $L_{in}(x, y) = \max(\underline{I}_{in}(x, y))$ . By construction, the output colour image, following Equation 2 (henceforth referred to as ‘original WTM’), will have the same chromaticities as the input.

Previously, we assessed the usefulness of tone-adjusted images in a preference experiment; comparing a user tone mapped image against the WTM simplification, finding the latter to be preferred over the former. However, in revisiting our work we realized that the user adjustments (carried out in GIMP) did not preserve chromaticity, yet we were comparing these against the WTM approximation (where the chromaticity was preserved). We found that GIMP calculated the output image as

$$\underline{I}_{out}(x, y) = t(\underline{I}_{in}(x, y)) \quad (3)$$

where the function  $t()$  represents the user tone curve, mapping input brightness to an output. In Figure 3a we see an unenhanced input image of the seabed, followed by its custom output (user tone-mapped) in b. In c), it is clear that applying the WTM tone map, as in Equation 3 (hereby referred to as ‘matched WTM’), produces a more similar image to b than the original chromaticity preserving WTM in d. Visually, we found that this trend was followed for the remaining images in the dataset i.e. matched tone renditions looked more similar to the user’s own tone-adjusted images than the original chromaticity preserved variant. Additionally, following matched WTM, the colours of the image are boosted. In this paper, we therefore evaluate whether ‘original WTM’ versus ‘matched WTM’ has a material result on user preference of tone-mapped images.

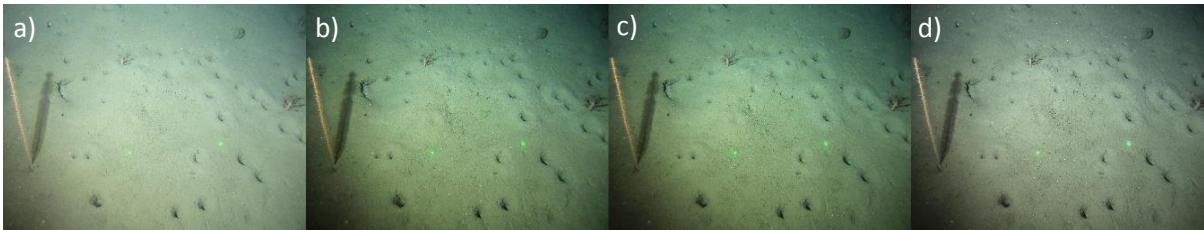

Figure 3: Comparison of an unenhanced input image (a), a custom enhanced image (b), matched WTM (c) and original WTM (d).

### PSYCHOPHYSICAL EVALUATION

Under ISO standard 3664:2009 conditions (ISO 2009), in a darkened room, 6 Gardline analysts- 3 of which created the custom enhanced dataset- were presented with uniquely randomized pairs of images. For each pair, they were asked to ‘Choose the image that best allows identification of the habitat (class) therein, or no preference if the images are equivalent’. Preference votes were assigned to 3 options; Image 1, Image 2 or No Preference. To minimize the duration of the experiment, 2 random subsets (one for each experiment repeat) of 18 images, 3 per habitat class (total=6), were selected. This kept the number of pairwise comparisons manageable, since the number of image variants,  $n = 3$ , would result in  $\frac{n}{2(n-1)} = 3$  pair-wise comparisons per image, which is then viewed twice (left-right order switched). The number of pairwise comparisons, per experimental repeat, was therefore  $18 \times 2 \times 3 = 108$ . Preference votes for each image pair were processed by awarding a score of 1 to the chosen image and 0 to the other. If no preference was selected, each image was given a score of 0.5.

Votes for each analyst, in each experimental sitting, were converted to 3x3 frequency matrices, of which the score at  $[i, j]$  represents the frequency of votes in which image variant  $i$  was preferred over variant  $j$ , across the 18 images. Thurstone's Law of Comparative Judgments, or Thurstone's Case V (Thurstone 1927), was used to convert frequency matrices to z-score (standard score) matrices.

Our results are interesting. In contradiction to the original WTM, we find for matched WTM - when chromaticity is not preserved- that users prefer their own manipulations to the WTM simplification (Figure 4). This demonstrates that how the image colour component is mapped, when based on a brightness tonal adjustment, can significantly influence the preference assessments of end-users. However, irrespective of this, both the custom and WTM adjustments are significantly preferred over doing nothing, for each WTM case. Therefore, given an unenhanced input image, end-users find a WTM enhancement useful for the extraction of biological data from imagery, regardless of the colour rendering method.

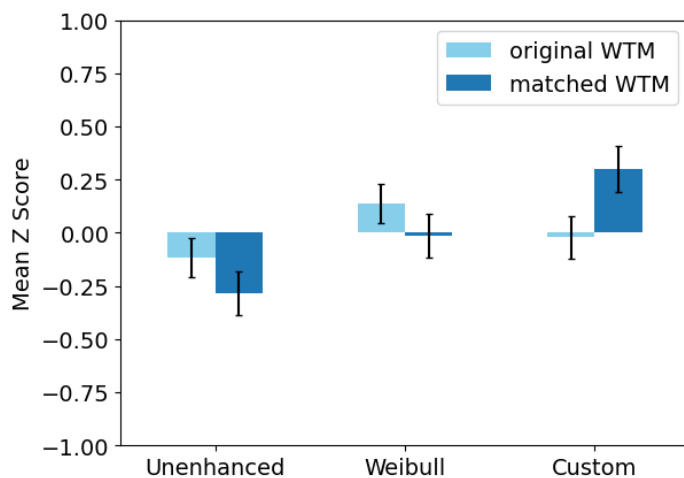

Figure 4: Preference Experiment Scores.

## CONCLUSION

In this paper, we introduced a chromatic modification of our Weibull Tone Mapping (WTM) algorithm. We find that, given an input-output image pair; application of the WTM tone map to all colour channels (R, G and B) provides a more colour-rich image and a better approximation of user tonal adjustments, than WTM in its original form. Interestingly, the method of colour mapping when using WTM – non-chromaticity preserving vs chromaticity preserving – alters the preference of end users. It therefore seems prudent to consider how colours are rendered, when developing and assessing tone-mapping algorithms, as they can have a significant influence on quality perception by end-users. For WTM specifically, an enhancement that preserves chromaticity is preferred for the identification of marine habitats in underwater images.

## ACKNOWLEDGEMENTS

This work was supported by the Natural Environment and the Engineering and Physical Sciences Research Councils [grant numbers NE/N012070/1 and EP/S028730/1]. The authors also thank the support of Gardline Limited and the Environmental Reporting team for their contribution to this research.

## REFERENCES

- Eustice, R., O. Pizarro, H. Singh, and J. Howland. 2002. UWIT: underwater image toolbox for optical image processing and mosaicking in MATLAB. *Proceedings of the 2002 International Symposium on Underwater Technology* (Cat. No.02EX556), 19-19 April 2002.
- Game, C. A., M. B. Thompson, and G. D. Finlayson. 2020. Weibull Tone Mapping for Underwater Imagery. *Color and Imaging Conference 2020* (28): 156-161.
- ISO. 2009. *Graphic technology and photography—Viewing conditions ISO3664:2009*. Geneva.
- Ruppé, C. V., and J. F. Barstad. 2013. *International handbook of underwater archaeology*. Springer Science & Business Media.
- Schettini, R., and S. Corchs. 2010. Underwater Image Processing: State of the Art of Restoration and Image Enhancement Methods. *EURASIP Journal on Advances in Signal Processing* 2010 (1): 746052.
- Shannon, C. E. 1948. A mathematical theory of communication. *The Bell System Technical Journal* 27 (3): 379-423.
- Thurstone, L. L. 1927. A law of comparative judgment. *Psychological Review* 34 (4): 273-286.
- Zuiderveld, K. 1994. Contrast limited adaptive histogram equalization. *Graphics gems*: 474-485.

# Angle-Retaining Color Space for Color Data Visualization and Analysis

Marco Buzzelli<sup>1,\*</sup>, Simone Bianco<sup>1</sup> and Raimondo Schettini<sup>1</sup>

<sup>1</sup> University of Milano - Bicocca; marco.buzzelli@unimib.it, simone.bianco@unimib.it, raimondo.schettini@unimib.it

\* Corresponding author: marco.buzzelli@unimib.it

## Abstract

The Angle-Retaining Chromaticity diagram (ARC) is used to map tristimulus values in a two-dimensional representation, so that angular distances in the original three-dimensional space are preserved as Euclidean distances in ARC. This property makes the ARC diagram particularly useful for computational color constancy, where the illuminant intensity is purposely discarded and illuminant chromaticities are compared in terms of angular distances, through either the recovery error or the reproduction error. We expand the ARC diagram by designing a full-fledged color space that adopts a cylindrical-coordinate color model. The resulting ARC space incorporates a third dimension encoding the intensity information of the initial color, while maintaining the angle-retaining properties of the ARC diagram for the first two dimensions. We formalize the equations that describe the mutual conversion between RGB and ARC space. We illustrate the emerging geometric properties of the ARC space, and its relationship with angular distances. We present a number of potential applications of the ARC space related to color constancy, texture analysis, and image enhancement.

**Keywords:** color constancy, illuminant estimation, white balance, chromaticity diagram, color space.

## INTRODUCTION

Computational color constancy, or “color constancy” for simplicity, aims at reducing the impact of the dominant illuminant source in a digital image. It is usually composed of two steps: the first one estimates the color of the scene illuminant by analyzing the image data, and the second one corrects the image itself by generating a new rendition of the scene, as if it was taken under a fixed reference light source. In order to evaluate the illuminant estimation part of computational color constancy, the error between a ground truth illuminant  $U = (u_R, u_G, u_B)$  and an estimated illuminant  $V = (v_R, v_G, v_B)$  is computed using the recovery angular error, which measures the three-dimensional angle in camera-raw RGB space between vectors  $U$  and  $V$ , thus ignoring their absolute intensity. Alternatively, Finlayson and Zakizadeh (2014) introduced the reproduction angular error as an alternative evaluation of color constancy algorithms, computing the angle between the “corrected” illuminant  $U/V$  and the neutral vector  $(1,1,1)$ .

In light of the relevance of angular distances for the field of color constancy, Buzzelli et al. (2020) designed an Angle-Retaining Chromaticity diagram (ARC) which maps, with a high level of accuracy, angular distances from the original RGB space into Euclidean distances on a plane. Here we further develop the chromaticity diagram by incorporating a third dimension which encodes the intensity information. The resulting three-dimensional color space fully characterizes the source data, while completely de-correlating the intensity information from the chromaticity information, and representing the latter in an angle-oriented interpretation that stems from the field of computational color constancy. As shown also in other fields of by Bianco et al. (2019), data representation can play a crucial role in successful computer vision, therefore we propose this alternative representation of color data with potential application to the fields of color constancy, texture analysis, enhancement, and in general all the applications in which intensity is processed independently from chrominance.

### ORIGINAL TWO-DIMENSIONAL ARC DIAGRAM

Given an input RGB vector  $P = (\rho_R, \rho_G, \rho_B)$ , ARC polar coordinates  $A = (\alpha_A, \alpha_R)$  (respectively hue-like and saturation-like) are computed as follows:

$$\alpha_A = \arctan2(\sqrt{3}(\rho_G - \rho_B), 2\rho_R - \rho_G - \rho_B), \quad (1)$$

$$\alpha_R = \arccos\left(\frac{\rho_R + \rho_G + \rho_B}{\sqrt{3}\sqrt{\rho_R^2 + \rho_G^2 + \rho_B^2}}\right). \quad (2)$$

Conversely, the inversion from ARC coordinates to RGB is described by the following relationship:

$$\frac{\rho_R}{\left|3\text{sgn}(\alpha_A)\text{sgn}(c)\sqrt{(c^2-c+1)d+(c^2-c-2)d-(c^2-c+1)}\right|} = \frac{\rho_G}{|(c^2+2c+1)d-(c^2-c+1)|} = \frac{\rho_B}{\left|3\text{sgn}(\alpha_A)\sqrt{c^2(c^2-c+1)d-(2c^2+c-1)d-(c^2-c+1)}\right|} \quad (3)$$

for brevity:

$$\frac{\rho_R}{k_R} = \frac{\rho_G}{k_G} = \frac{\rho_B}{k_B}. \quad (4)$$

This relationship describes a line in a three-dimensional space, obtained as the intersection between a cone and an half-plane, with both axes corresponding to the line of neutral grays in RGB space. The properties of such cone and half-plane relate to values  $c$  and  $d$ , computed from  $\alpha_A$  and  $\alpha_R$  as:

$$c = f_c(\alpha_A) = \frac{2\sqrt{3}}{\sqrt{3}-3\cot(\alpha_A)}, \quad (5)$$

$$d = f_d(\alpha_R) = \frac{\tan(\alpha_R)^2}{2}. \quad (6)$$

For numerical stability, the inversion Equation (3) is actualized in different ways, using either  $\rho_G$  or  $\rho_B$  as the independent variable.

### THREE-DIMENSIONAL ARC SPACE

The introduction of the intensity component can be obtained in terms of distance between the initial RGB point and the point of origin (black):

$$\alpha_z = \sqrt{\rho_R^2 + \rho_G^2 + \rho_B^2}. \quad (7)$$

Assuming RGB values in the  $0 \div 1$  range, the  $\alpha_z$  component will occupy the range between 0 and  $\sqrt{3}$ . In order to reconstruct the original RGB values from three-dimensional ARC values, we intersect the sphere defined by Equation (7) (having radius  $\alpha_z$  and center in the origin) with the line in 3D space from (4). To do so, we solve Equation (4) for  $\rho_R$  and  $\rho_B$ :

$$\rho_R = \frac{k_R}{k_G} \rho_G, \quad (8)$$

$$\rho_B = \frac{k_B}{k_G} \rho_G, \quad (9)$$

and solve Equation (7) for the remaining variable  $\rho_G$ :

$$\rho_G = \sqrt{-\rho_R^2 - \rho_B^2 + \alpha_z^2}. \quad (10)$$

By replacing the definition of  $\rho_B$  from Equation (9) into Equation (10), and subsequently replacing the resulting  $\rho_G$  in Equation (8), we make the value for  $\rho_R$  explicit. The same procedure can be applied to all variables:

$$\rho_R = \frac{k_R}{\sqrt{k_R^2 + k_G^2 + k_B^2}} \alpha_z, \quad (11)$$

$$\rho_G = \frac{k_G}{\sqrt{k_R^2 + k_G^2 + k_B^2}} \alpha_Z, \quad (12)$$

$$\rho_B = \frac{k_B}{\sqrt{k_R^2 + k_G^2 + k_B^2}} \alpha_Z. \quad (13)$$

Note that in the original formulation from Buzzelli et al. (2020), the inversion led to a line in RGB space due to the lack of the intensity component. In this case, the inversion precisely leads to one point, so all variables are independently evaluated.

A special case is required when  $\alpha_A = 0$ , corresponding to the RGB plane of pure reds. In this case, we start from a set of simplified equations describing the line in three-dimensional space:

$$\rho_R = \rho_G \frac{2\sqrt{d}+1}{1-\sqrt{d}}, \quad (14)$$

$$\rho_B = \rho_G. \quad (15)$$

Adding to the procedure for the general case, we can substitute Equation (15) in Equation (10), thus obtaining:

$$\rho_R = \sqrt{\alpha_Z^2 - 2\rho_G^2}, \quad (16)$$

$$\rho_G = \frac{\sqrt{\alpha_Z^2 - \rho_R^2}}{\sqrt{2}}. \quad (17)$$

Substituting either in Equation (14) eventually leads to:

$$\rho_R = \sqrt{\frac{4d+4\sqrt{d}+1}{2d+1}} \frac{\alpha_Z}{\sqrt{3}}, \quad (18)$$

$$\rho_G = \sqrt{\frac{d-2\sqrt{d}+1}{2d+1}} \frac{\alpha_Z}{\sqrt{3}}, \quad (19)$$

$$\rho_B = \rho_G = \sqrt{\frac{d-2\sqrt{d}+1}{2d+1}} \frac{\alpha_Z}{\sqrt{3}}. \quad (20)$$

An official implementation is made available at the project web page<sup>1</sup>.

### GEOMETRIC PROPERTIES OF ARC SPACE

The original ARC formulation is by design defined in polar coordinates  $(\alpha_A, \alpha_R)$ , although the alternative Cartesian coordinates version  $(\alpha_X, \alpha_Y)$  also formulated by Buzzelli et al. (2020) is particularly useful when manipulating data in matrix form, and when computing Euclidean distances. By extension, the three-dimensional ARC space follows a cylindrical coordinate model, thus adhering to the same rationale of Hue-Saturation-\* color spaces. The result of transforming the RGB cube gamut into ARC chromaticity and ARC color space is shown in Figure 1, with distances expressed in radians. The irregular shape of the three-dimensional solid on the right is a natural consequence of the intensity formulation expressed in Equation (7). The distance from the RGB origin is in fact different from the red green and blue group ( $\alpha_Z = 1$ ), for the cyan magenta and yellow group ( $\alpha_Z = \sqrt{2}$ ), and for the pure white ( $\alpha_Z = \sqrt{3}$ ).

<sup>1</sup> <http://www.ivl.disco.unimib.it/activities/arc/>

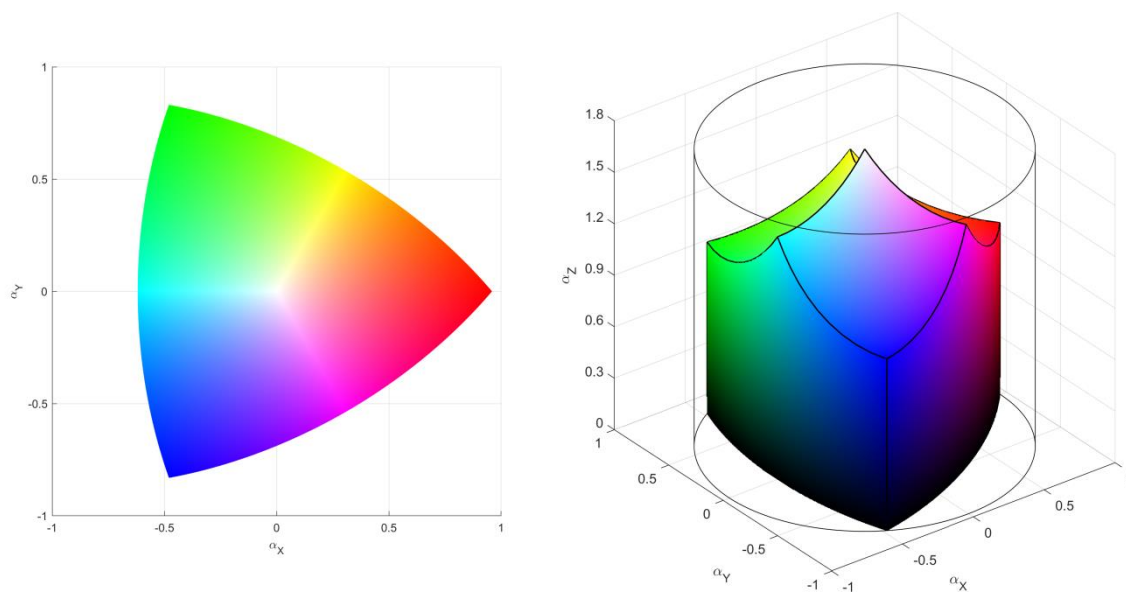

Figure 1: RGB gamut in Angle-Retaining Chromaticity diagram (left) and Angle-Retaining Color space (right).

Figure 2 offers a more clear visualization of the connection between RGB and ARC space: spheres of different radius having center in the RGB origin directly correspond to horizontal planes in ARC space, all having the same size. By design, then, rays emanating from the origin in RGB space, would map into parallel vertical lines in ARC space. Low-intensity RGB triplets get stretched out to span the same area of high-intensity ones, showing the connection with recovery angular error, according to which colors are compared by disregarding the intensity component. For the mere task of measuring color difference in ARC space, in fact, it is then sufficient to discard the newly-introduced  $\alpha_z$  value, and compute the Euclidean distance in the resulting two-dimensional space.

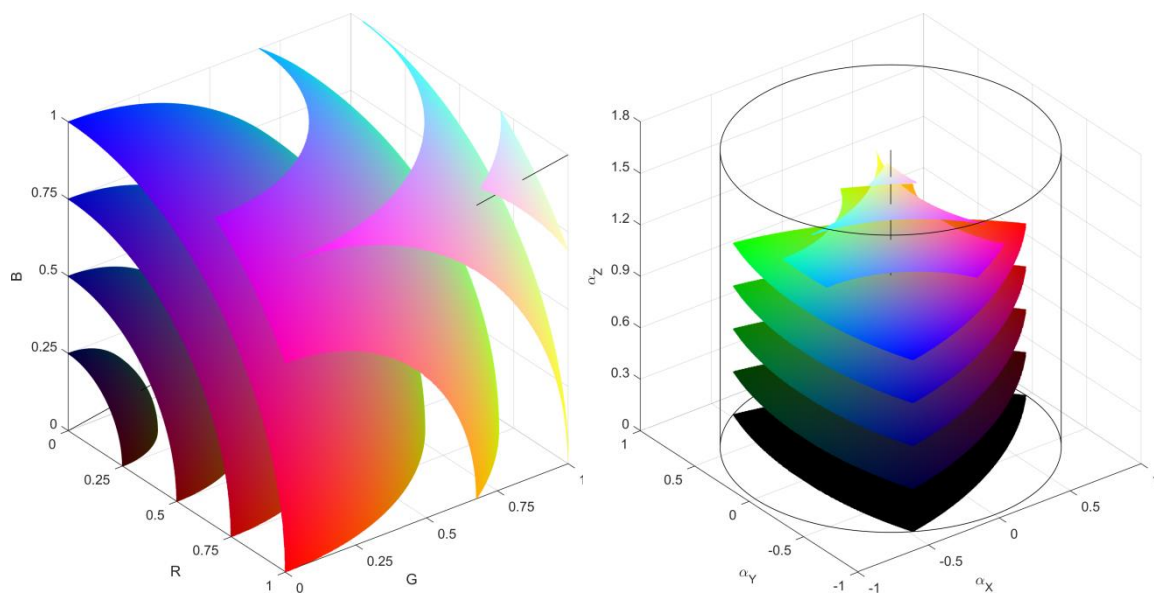

Figure 2: Concentric spheres in RGB space correspond to equal-sized horizontal parallel planes in ARC space.



## **POTENTIAL APPLICATIONS**

### **Color constancy**

The main application of two-dimensional and three-dimensional ARC is in the field of computational color constancy. In particular, the step of illuminant estimation takes as input an image in the RGB space of the specific camera (therefore, not sRGB nor any other device-independent space). This type of data is then manipulated and analyzed in order to produce an estimated RGB illuminant in the same camera-specific space, which is evaluated through the recovery and reproduction errors, both based on the assessment of angular distances. A full-fledged color space that encodes angular distances as Euclidean distances implicitly provides a sensitivity to the same angular distances that are used as target metric. As such, it could potentially facilitate an optimization process for illuminance estimation methods.

### **Texture analysis**

Angle-based errors are also employed in the field of texture analysis. For example, Cusano et al. (2014) presented a feature for color texture classification, specifically designed to be robust against changes in the illumination conditions. Their descriptor combines a histogram of the Local Binary Patterns (LBPs) by Ojala et al. (1996), with a newly-introduced feature measuring the distribution of Local Color Contrast (LCC) based on the recovery angular error. Similarly, Li and Plataniotis (2018) introduced a compact rotation-invariant texture descriptor, named Quantized Diagnostic Counter-color Pattern (QDCP) for application in digital pathology image understanding. In a combination with Local Binary Patterns, they indexed local textures on the basis of color similarity quantified by the inner product of unit-length color vectors. Both works show that the inclusion of color-aware descriptors allows to outperform the original LBP approach, its color variants, as well as several other color texture descriptors in the state of the art, in classifying images acquired under varying illuminants. This suggests that other descriptors could be effortlessly enhanced with color-invariant properties by shifting to an ARC-based representation.

Finlayson et al. (1996) presented a color-based algorithm for recognizing colorful objects and textures, which relies on color distribution angles to index and retrieve such items. This type of application suggests the possibility of extending the angular color characterization to analyze the global distribution of an image.

### **Image denoising and enhancement**

The separation of image data into color-related and intensity-related components has been successfully applied for applications of image denoising and, more generally, image enhancement. For example, Tang et al. (2001) introduced an algorithm that decomposes the input RGB into chromaticity and brightness, and then processes each component with a distinct approach. In particular, the chromaticity is transformed using a system of coupled diffusion equations adapted from the theory of harmonic maps in liquid crystals, while the brightness is enhanced by either a scalar median filter or an anisotropic diffusion flow. The impact of such decomposition-based approaches to image enhancement might benefit from the transition to ARC space in applications where the illuminant characterization should be preserved or treated in a special way.

Confirming the value of application to image enhancement, Vazquez-Corral and Bertalmio (2017) proposed a color-sensitive image decomposition to be applied before a typical denoising step. This decomposition produces multiple images in a spherical coordinate system, sharing some

commonalities with the proposed cylindrical ARC space, each having origin in a different color value, defined so as to be far away from the image dominant colors. They experimentally showed that this approach outperforms the results of directly applying different state-of-the-art denoising methods.

## **CONCLUSIONS**

We have presented ARC: a new color space based on a cylindrical model that separates intensity, hue-like and saturation-like components, these last two specifically designed to map RGB angular distances into Euclidean distances. We have provided the mathematical formulation for both RGB-to-ARC and ARC-to-RGB conversion, illustrated the geometric properties of the resulting space, as well as its potential application to color constancy, texture analysis, and image enhancement.

As future development, the fields of hyperspectral and multispectral imaging could be investigated as a further case of application of angle-based analysis and representation.

## **REFERENCES**

- Bianco, S., M. Buzzelli, and R. Schettini. 2019. A unifying representation for pixel-precise distance estimation. *Multimedia Tools and Applications*, 78(10): 13767-13786.
- Buzzelli, M., S. Bianco, and R. Schettini. 2020. ARC: Angle-Retaining Chromaticity diagram for color constancy error analysis. *JOSA A*, 37(11): 1721-1730.
- Cusano, C., P. Napoletano, and R. Schettini. 2014. Combining local binary patterns and local color contrast for texture classification under varying illumination. *JOSA A*, 31(7): 1453-1461.
- Finlayson, G. D., S. Chatterjee, and B. V. Funt. 1996. Color angular indexing. In: *European Conference on Computer Vision*, Springer, Berlin, Heidelberg, 16-27.
- Finlayson, G. D., and R. Zakizadeh. 2014. Reproduction angular error: An improved performance metric for illuminant estimation. *Perception*, 310(1): 1-26.
- Li, X., and K. N. Plataniotis. 2018. Novel chromaticity similarity based color texture descriptor for digital pathology image analysis. *Plos one*, 13(11): e0206996.
- Ojala, T., M. Pietikäinen, and D. Harwood. 1996. A comparative study of texture measures with classification based on featured distributions. *Pattern recognition*, 29(1): 51-59.
- Tang, B., G. Sapiro, V. and Caselles. 2001. Color image enhancement via chromaticity diffusion. *IEEE Transactions on Image Processing*, 10(5): 701-707.
- Vazquez-Corral, J., and M. Bertalmio. 2017. Angular-based preprocessing for image denoising. *IEEE Signal Processing Letters*, 25(2): 219-223.

# Comparison of color gamuts generated by digital printing devices under different conditions

Ana Belén López-Baldomero <sup>1,\*</sup>, Manuel Rubiño <sup>1</sup>, Carolina Ortiz <sup>1</sup> and Carlos Salas <sup>1</sup>

<sup>1</sup> Department of Optics, Faculty of Science, University of Granada, Granada 18071, Spain; analopezbaldomero@gmail.com, mrlopez@ugr.es, ortizh@ugr.es, csalas@ugr.es

\* Corresponding author: analopezbaldomero@gmail.com

## Abstract

In the color industry, it is vital to know the color gamut of a given device. The aim of this work was to compare the color gamuts generated by printing devices, showing the effects that different papers, light sources, printing technologies, and file formats have on the color obtained. For this purpose, a new software for comparing the color gamuts was developed. An automated color measurement system was also used for the printed color samples. For the comparison of the color gamuts, the software simultaneously represents them in the 3D CIELAB space and calculates their volume using two algorithms: Convex Hull and Alpha Shapes. This work allows for the optimization of color gamuts generated by printing devices by choosing the appropriate factors and settings, helping to achieve high quality color images.

**Keywords:** *color printing gamut, color gamut evaluation, color reproduction, color gamut visualization, color printing technology*

## INTRODUCTION

The color gamut is the set of colors that can be captured or reproduced by devices such as printers, scanners, or display units under certain observation conditions (Li et al. 2012). On printers, this gamut depends on the amount of CMYK (cyan, magenta, yellow, and black) used, the printing technology, ink and substrate characteristics (Balasubramanian and Dalal 1997), and default printing conditions. In the color industry, it is crucial to know the color gamut of a device (Perales et al. 2008). Gamuts have been compared to examine different paper types (Perales et al. 2009; Yang et al. 2011) or the optical properties of papers (Li et al. 2016), and printing systems (Perales et al. 2008).

When comparing color gamuts, they must be qualitatively and/or quantitatively analyzed (Perales et al. 2009), and different factors must be considered, including the color space used to represent them (Zhu et al. 2015), their 2D or 3D graphic representation, and algorithms used to determine their limits. The color gamut is a 3D volume (Tutak et al. 2018; Yang et al. 2011), and calculating the gamut volume provides important and very precise information (Perales et al. 2009). Some authors combine the 3D representation of the gamut with the calculation of its volume (Ding et al. 2019; Li et al. 2012; Perales et al. 2009; Tutak et al. 2018). This allows to perform a qualitative analysis by studying the 3D figures and a quantitative analysis by using the volume (Perales et al. 2009). In this present work we compare the color gamuts generated by printing devices, showing the effects that different papers, light sources, printing technologies, and file formats have on the color obtained.

## MATERIALS AND METHODS

### Experimental set-up: Obtaining the color gamuts

In order to obtain the color gamuts, we developed an automated color measurement system for use with samples generated by printing devices.

Data for the printer color gamuts were obtained from a printed pattern with 1,331 color samples using a spectroradiometer (PhotoResearch SpectraScan PR-670) for measuring the spectral

Comparison of color gamuts generated by digital printing devices under different conditions radiances. These samples were obtained by varying the CMY colors of the printer from 0 to 100 units in 10-unit steps and were measured in a light cabinet (VeriVide CAC 120) with diffuse/0° geometry. The sample pattern was placed at 45° on a stand mounted on a linear displacement module which, in turn, was mounted on a second module (Zaber), with a displacement axis perpendicular to the first one (Figure 1). The aforementioned displacement modules and our in-house software were used to automatically measure the color of each of the 1,331 samples.

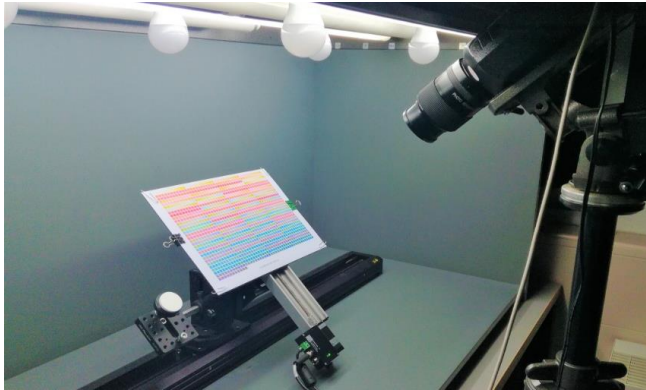

Figure 1: Experimental set-up for obtaining the color gamuts. Automated displacement modules were used inside the light cabinet; spectroradiometer and sample pattern used for these measurements.

We obtained the color gamut provided by eight brands of paper with different grammage and finishing: Epson (167 g/m<sup>2</sup>, matte, photo paper), Ice Professional (190 g/m<sup>2</sup>, matte, photo paper), HP Everyday (200 g/m<sup>2</sup>, glossy, photo paper), Canon (260 g/m<sup>2</sup>, satin, photo paper), Navigator (80 g/m<sup>2</sup>, slightly satin, office paper), HP Premium (100 g/m<sup>2</sup>, matte, office paper), HP Professional (120 g/m<sup>2</sup>, glossy, office paper) and Canson (200 g/m<sup>2</sup>, satin, drawing paper); three printing devices with two different printing technologies: two inkjet printers (Epson XP-530 and Epson Stylus Photo 1500W) and a laser printer (Canon C5235i); four light sources: simD65 (simulates the CIE standard illuminant D65), TL84, F (simulates the CIE standard illuminant A) and LED; and four file formats: CDR, PDF/X-3, JPG y PNG.

### **Method for comparing color gamuts**

Tools and techniques for the visualization of color gamuts have been under development for many years (Kalra 1994, Meyer et al. 1993, Robertson 1988), some of the most important being ColorThink (CHROMiX), GamOpt (Hewlett Packard Enterprise) (Kalra 1994), Gamutvision (Imatest LLC), Perfx 3D gamut viewer (TGLC Inc.) (TGLC Inc. 2004), and ICC3D (Interactive Color Correction in 3 Dimensions; NTNU) (Farup et al. 2002). However, most of these programs are now quite old, which generates some problems for their use. For example, GamOpt is not available for public use and ColorThink is monetized, limiting its use. Gamutvision and Perfx 3D gamut viewer only allow the visualization of gamuts from ICC profiles and so are not useful for color measurement series. ICC3D is the only program capable of representing and comparing gamuts generated by printing technologies, but it is unintuitive, the representation in CIELAB does not have numbered axes, it generates low resolution 3D figures, and its figure representation time is slow. For this reason, we have developed new software for comparing the color gamuts generated by printing devices, using MATLAB.

To thoroughly compare different gamuts, we simultaneously represented them in three dimensions in the CIELAB color space (Tutak et al. 2018, Yang et al. 2011) and calculated their

Comparison of color gamuts generated by digital printing devices under different conditions volumes (Perales et al. 2009) using our software. The input data for our program were the colorimetric coordinates  $L^*$ ,  $a^*$ , and  $b^*$  for each sample, which were calculated from the spectral radiances, and the quantities of CMY used to generate each one. We used nearest neighbour interpolation to generate the limits of the gamuts from the color measurements because this type of analysis enables 3D data interpolation and requires very little processing time (Savagave and Patil 2014). In addition, the interpolation is independent of the concavity or convexity of the figure (Braun and Fairchild 1997). The convex hull and alpha shapes algorithms were used to calculate the gamut volumes. The convex hull of a set of points is the smallest convex polyhedron that contains all the points (Yin et al. 2017), and the alpha shape is a generalization of the convex hull algorithm applicable to non-convex solids (Cholewo and Love 1999).

The standard conditions used for comparing color gamuts were: Epson photo paper (167 g/m<sup>2</sup>, matte), Epson XP-530 inkjet printer, simD65 light source and CDR file format (CorelDRAW).

## EXPERIMENTAL RESULTS AND DISCUSSION

We compared the color gamuts obtained under different printing and measuring conditions, using our software to represent the overlapping color gamuts in the CIELAB space. The volume has been expressed as a percentage to facilitate comparison, considering the highest volume of the alpha shapes and convex hull algorithms as 100% (Figure 2).

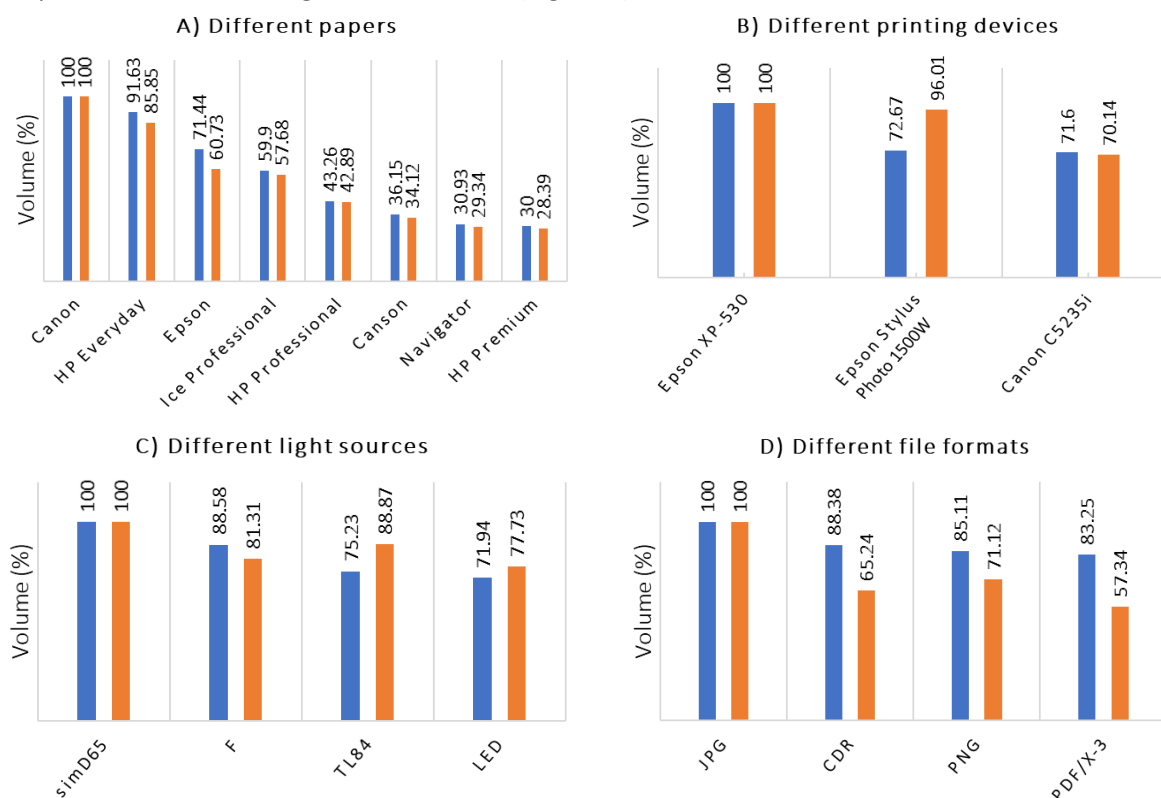

Figure 2: Comparison of volumes of color gamuts obtained with the convex hull (blue bars) and alpha shapes (orange bars) algorithms for A) each type of paper; B) different printing devices; C) different light sources; D) different file formats.

### Color gamuts generated by different papers

First, we compared color gamuts generated by different types of paper. In Figure 2.A, we present the volume obtained. As we can see, Canon, HP Everyday and Epson papers, which have different

finishing, provide the greatest gamut. In addition, the heavier the paper grammage, the greatest the color gamut obtained. If we fit our data to a line, we obtain regression coefficients of 0.6337 (convex hull) and 0.6602 (alpha shapes). Nevertheless, if we remove the data for Canson paper (the only drawing paper used), we get regression coefficients of 0.8967 (convex hull) and 0.9251 (alpha shapes).

From the 3D comparison of different gamuts we can see which colors are best represented by which type of paper. For example, the HP Everyday and HP Professional papers provide a greater gamut in the yellow and orange. If we compare the Canson and Navigator papers, we observe that the Navigator paper generates a wider color gamut for magenta and blue, while the Canson paper generates a wider gamut for the other colors.

Different authors have studied the relationship between color printing gamuts and the paper used. On the one hand, some studies have stated that there is no correlation between the use of different papers and the gamuts generated (Chovancova-Lovell and Fleming 2009; Kandi 2013; Li et al. 2016). On the other hand, Perales et al. (2009) concluded that glossy finishing and high grammage provide a wider gamut. Our results agree in terms of grammage, but not in terms of finishing. Other authors also state that the glossier the paper, the wider the color gamut it produces. However, we have obtained wide color gamuts with satin and matte papers.

### Color gamuts generated by different printing devices

Next, we compared color gamuts generated by different printing devices. As we can see in Figure 2.B, the Epson XP-530 inkjet printer provides the greatest color gamut.

In addition, when we compare the color gamuts in the CIELAB space we find that the gamut surface produced by the laser printer was rougher compared to the inkjet printers (Figure 3).

Perales et al. (2009) compared the gamuts obtained with different printing technologies and concluded that laser printer provided the widest color gamut. Their results do not agree with ours, probably due to the printer model used or the ICC profile.

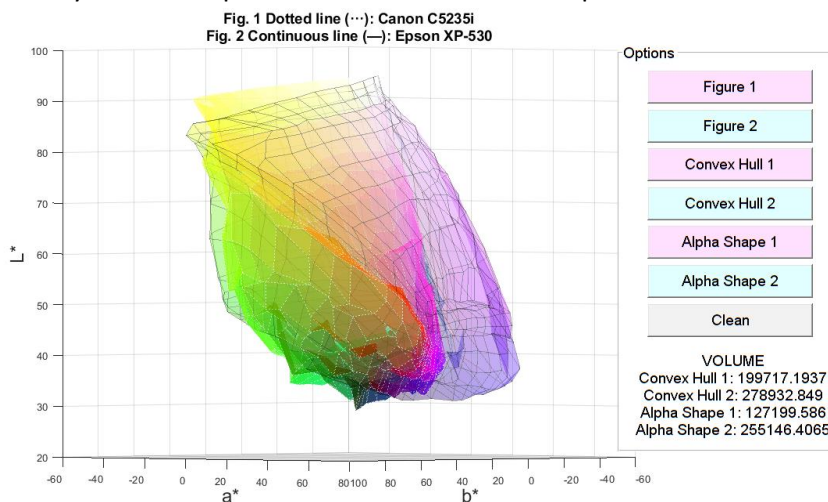

Figure 3: Comparison of two color gamuts in the CIELAB space. The dotted white line corresponds to the Canon C5235i laser printer and the continuous black line, to the Epson XP-530 inkjet printer.

### Color gamuts generated by different light sources

Then, we compared color gamuts obtained using different light sources. From the 3D representation in the CIELAB space (Figure 4) and the Figure 2.C we can see that the gamut obtained using simD65 largely encloses the gamut generated using the F, TL84 and LED light sources.

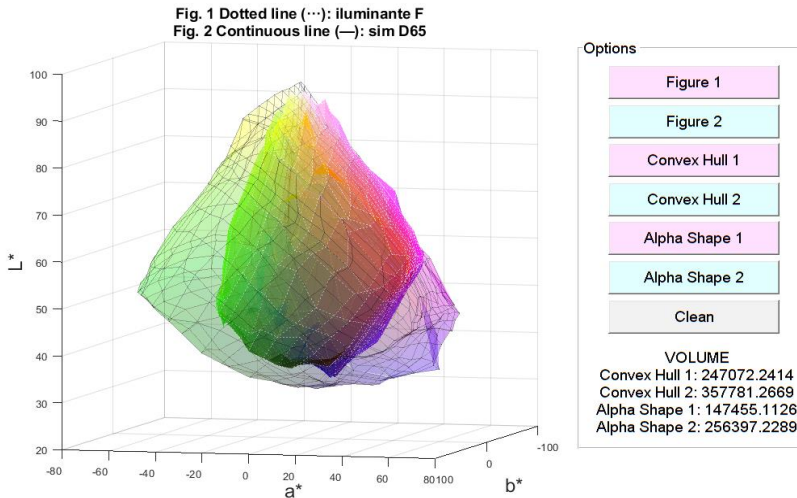

Figure 4: Comparison of two color gamuts in the CIELAB space. The dotted white line corresponds to the F light source and the continuous black line, to the simD65 light source.

### Color gamuts generated by different file formats

Finally, we studied the influence of the file format sent to print on the color gamut. As shown (Figure 2.D), JPG format provides the widest gamut. From the 3D representation we find that CDR format produces a wider gamut in yellows compared to JPG format. Comparing the CDR format with PDF/X-3 and PNG, the gamuts are very similar.

## CONCLUSIONS

Considering the results obtained for the conditions studied, to achieve the widest color gamut we should use the Epson XP-530 inkjet printer, high grammage paper, light source similar to the D65 illuminant and JPG format. Nevertheless, depending on the characteristics of the images to be printed we can use different conditions, according to the colors we are most interested in.

It is crucial to know all factors that influence the color gamut generated by a printing device, in order to have total control over the color we want to obtain. The new software developed will facilitate the study and comparison of gamuts generated by different printing technologies under different printing and measuring conditions.

The automated color measurement system and the printed pattern with 1,331 color samples can be used to obtain the color gamut and calibrate different printing devices, under different printing and measuring conditions, in order to obtain accurate color reproduction in terms of visual perception.

## ACKNOWLEDGEMENTS

Ana Belén López-Baldomero would like to thank the University of Granada for the pre-doctoral grant that she has received.



## REFERENCES

- Balasubramanian, R., and E. Dalal. 1997. Method for Quantifying the Color Gamut of an Output Device. In: *Color Imaging: Device-Independent Color, Color Hard Copy, and Graphic Arts II*.
- Braun, G. J., and M. D. Fairchild. 1997. Techniques for Gamut Surface Definition and Visualization. In: *Color and Imaging Conference*. Society for Imaging Science and Technology.
- Cholewo, T. J., and S. Love. 1999. Gamut boundary determination using alpha-shapes. In: *Color and Imaging Conference*. Society for Imaging Science and Technology.
- Chovancova-Lovell, V., and P. D. Fleming. 2009. Color gamut - A new tool for the pressroom? *Tappi Journal* 8(2): 4–11.
- Ding, Y., R. Shamey, L. Parrillo-Chapman, and H. S. Freeman. 2019. Pretreatment effects on pigment-based textile inkjet printing – colour gamut and crockfastness properties. *Coloration Technology* 135(1): 77–86.
- Farup, I., J. Y. Hardeberg, A. M. Bakke, S. Kopperud, and A. Rindal. 2002. Visualization and interactive manipulation of color gamuts. In: *Color and Imaging Conference*. Society for Imaging Science and Technology.
- Kalra, D. 1994. GamOpt : A Tool for Visualization and Optimization of Gamuts. In: *Color Hard Copy and Graphic Arts III*.
- Kandi, S. G. 2013. The effect of paper appearance on printed color of inkjet printer. *Color Research and Application* 38(4): 284–291.
- Li, C., M. R. Luo, C. Li, and G. Cui. 2012. The CRI-CAM02UCS colour rendering index. *Color Research and Application* 37(3): 160–167.
- Li, Y., X. Cui, S. Zhang, Q. Sun, and C. Liu. 2016. Effect of paper optical characteristics on tonal gradation reproduction in inkjet printing. In: *Advanced Graphic Communications, Packaging Technology and Materials* 453–459. Springer.
- Meyer, G. W., L. S. Peting, and F. Rokoczi. 1993. A Color Gamut Visualization Tool. In: *Color and Imaging Conference*. Society for Imaging Science and Technology.
- Perales, E., E. Chorro, V. Viqueira, F. Martínez-Verdú, S. Otero, and V. De Gracia. 2008. New method for comparing colour gamuts among printing technologies. *The Imaging Science Journal* 56(3): 145–152.
- Perales, E., F. M. Martínez-Verdú, V. Viqueira, J. Fernández-Reche, J. A. Díaz, and J. Uroz. 2009. Comparison of color gamuts among several types of paper with the same printing technology. *Color Research and Application* 34(4): 330–336.
- Robertson, P. K. 1988. Visualizing Color Gamuts: A User Interface For The Effective Use Of Perceptual Color Spaces In Data Displays. *IEEE Computer Graphics and Applications* 8(5): 50-64.
- Savagave, A., and A. B. Patil. 2014. Study of Image Interpolation. *International Journal of Innovative Science, Engineering & Technology* 1(10): 529–534.
- TGLC Inc. 2004. *PerfX 3D Gamut Viewer User Guide* (1–5).
- Tutak, D., H. N. Beytut, and A. Ozcan. 2018. Investigation of the effects of different ink density values on color gamut in offset printing. *Journal of Graphic Engineering and Design* 9(1): 23–28.
- Yang, Y. G., Q. Z. Gao, and F. P. Liu. 2011. Effects of paper properties on printing dot gain and color gamut. In: *Advanced Materials Research*.
- Yin, Z., J. Yongwen, and L. Maohai. 2017. A new device color gamut boundary description algorithm based on irregular segmentation. *Color Research and Application* 42(2): 173-181.
- Zhu, R., Z. Luo, H. Chen, Y. Dong, and S. T. Wu. 2015. Realizing Rec 2020 color gamut with quantum dot displays. *Optics Express* 23(18): 23680-23693.

# Perceptual calibration of color. An exploration

Alfonso de Lucas Tron <sup>1,\*</sup>

<sup>1</sup> Universidad Nacional Autónoma de México; adelucas@unam.mx, academiadelucas@yahoo.com.mx

\* Corresponding author: adelucas@unam.mx

## Abstract

We denominate the *perceptual calibration of color* as certain abilities that, precisely technicians and artists, exhibit in the use of color. We understand this property as the sensoperceptual mechanism in which, in the sensory impression of an object, the brain compares or *calibrates* this impression with the idea of color that the brain itself has forged through experience. Without the idea, the impression cannot be calibrated. In spite of the importance of calibration, there are many unknowns concerning its origin, evolution, and characteristics. The objective herein, therefore, was to put together an approximation of this phenomenon employing, for the effect, phenomenological analysis. This derives from the thesis that changes in the illumination of the surrounding environment contribute to a process of perceptual adaptability that stimulates in the individual an idea of color that, in practice, can be occupied in educative processes and for the evaluation of qualified personnel.

**Keywords:** *color, sensoperception, calibration, experience*

## INTRODUCTION

It is admirable the manner in which technicians and artists conduct a masterful management of color that, for the ordinary person, would appear complicated to even equal. This would be the case, for example, of paint-store employees who, through the use of mixtures, match the samples of a color chart; for graphic-arts technicians who equilibrate the four inks for full-color impressions, or artists who, by means of glazes, confer the effects of volume on their paintings. These are visual skills that we call *perceptual calibration of color*, which are applied to daily activities as well as to highly specialized ones. In spite of their importance, there are many unknowns associated with its origin, evolution, and characteristics. This is why this work, as an approximation, will attempt to clarify it, utilizing phenomenological analysis based on the philosophical approach of Edmundo Husserl (1997).

**THESIS.** Changes in the illumination of the surrounding environment contribute to a permanent process of perceptual adaptability that stimulates in the individual an idea of color that serves to equilibrate or to *calibrate* through the comparison of the material object and the visual object.

**OBJECTIVE.** Arrive at an approximation of the particularities of the phenomenon of perceptual calibration, engaging, for the effect, phenomenological analysis.

## DEFINITION OF THE TERM

The term *calibration* is used in physics, engineering, and mechanical engineering. *Caliber* refers to a standard of measurement that is applied by means of an instrument in order for something to comply with the norm for which it was created. In electronics, color calibration refers to programs and actions that are of use in adjusting in-put and out-put monitors and devices to chromatic standards so that colors vary to the least degree possible. The term calibration is akin to color management, a process that attempts for the tones of a graphic chain composed of multiple devices to vary to the minimal extent possible in each of the phases without it mattering whether they pass through the Cyan, Magenta, Yellow, Key/Black (CMYK) to the Red, Blue, Green (RGB) format or vice versa.

The term *calibration* was chosen as a paragon for an activity that the brain carries out through its own means and for its own purposes. Based on this, we understand *perceptual calibration of color* as the sensorperceptual mechanism in which, in the impression of a sensory object, the brain compares or *calibrates* with the idea or standard of color that the brain on its own has forged through experience. It is clear that without the idea of color, calibration cannot take place. To understand the phenomenon, we must first establish the factors that participate in it and how they interact, which we will proceed to set forth herein.

### **SENSOPERCEPTION**

The ocular systems can only be activated by the action of light within a range of wavelengths; however, the vision process initiates in the retinas, framed within what is called *sensorperception*. It is thus denominated because it takes into account two primordial phases: the sensory and the perceptual, accepting that the two are one and the same.

The **sensory phase** refers to the stimulation of the photosensitive cells on being touched by light. The external ocular organs are of utmost importance, although they do not comprise perception itself. According to Kant, the sensations solely constitute the “matter” or “prime substance” of our knowledge, which should be ordered and should conform to shaping, with this matter, an image of the external world. We do not see with the eyes, but instead through the eyes (Müeller-Freienfels 1966: 269-271).

The **perceptual phase** alludes to the treatment of the information that the eyes transmit to the brain through the optic nerve in order to transform this information into psychic matter. It is in the brain that we really see because it is there that the stimuli acquire form and content. Without the cerebral operations, the eyes would be like a television set in a room in which there is no one there to watch it. Psychologists take it as given that sensation and perception act in coordination, complementarily between themselves, by means of concepts, techniques, and information that are biological and physical in nature (Schiffman 2001: 26). They are so dependent on each other that, if one is lacking, vision simply would be unable to be effected.

### **PROXIMAL AND DISTANT COLOR PERCEPTION**

It is clear that the brain truly perceives color; however, logically speaking, this is related with the sensory impression that, although true, renders a limited vision of perception. It must be observed that the brain is an amazing organ capable of carrying out many functions simultaneously. Its dynamic nature processes a great amount of sensory matter that it transforms into psychic matter, which in turn grants to color an unimaginable range, something possible due to the interaction of the material object with the visual object.

The **material object** is the stimulus that generates, in the photosensitive cells, the reflection of light. In the sensory impression, color comprises another of the corporal attributes, such as form, texture, temperature, color and etcetera. It should be observed that reference is not only made to bodies in particular; also considered are scenes with many elements such as a landscape. In any case, it is what lies within the visual angle. In calibration, the material object, beyond the bodies, environments, or scenes, also refers to an event, occupation, or activity that the observer engages in that stimulates an idea susceptible to being calibrated.

The **visual object** is a construction of the perceiver that results from the processing supplied by the brain to the sensory matter; it is, therefore, the result of the stimulus that gave rise to the material object and is the final response of the sensorperception in which sight takes on form and content.

The perception of both objects is invariably related with two focuses on the nature of perception: the *proximal focus*, relative to the sensory impression, and the *distant focus*, such as ideas or chromatic impressions deriving from mental processes, which it is convenient for us to review.

### ***Proximal perception of color***

***Proximal perception*** is the luminous stimulus that allows us to perceive what is outside: it is the excitation that the wavelengths of the material object cause on projecting the image of the exterior world. On considering, then, that environmental illumination is variable, proximal perception is immediate, ephemeral, and fleeting: it is effected while the vision is active. In any three-dimensional object, only one aspect is visible at a sole place and at a determined time (Arnheim 2008: 141). In proximal perception, two illusory effects are expressed that appear at the moment of vision: the constancy of the color (Schiffman 2001) and the simultaneous contrast (Albers 1984)

### ***Distant perception of color***

In the retinas, light converts, in part, into signals that are electric and chemical in nature, which can no longer be described in terms of units of light (Mueller and Mae 1974: 75). This means that not everything referring to color is related with wavelengths. Although the visual sensation is interrupted, the brain does not become empty; registers remain that are not copies of the visual world but that are rather abstractions lacking in innumerable formal elements. Color in the brain acquires an ideal character that is very much superior to the whims of the environment. This is the property that we denominate *distant perception of color*, which is expressed in stable, regular and, up to a certain point, permanent coloration, which serves well for the purposes of knowledge and culture. It responds to the motivations and experiences of each individual, deriving, as it does, from that what each person sees is personal, untransferable, and is the projection of the individual's internal world.

## **PERCEPTUAL CALIBRATION OF COLOR**

Bearing in mind that proximal perception refers to the processing of sensory information at the moment of vision, we must observe here that the brain does not only focus on the interpretation of what one is looking at a given moment. *Proximal* perception can be converted into *distant* perception in order to follow various pathways and for diverse purposes. In the brain there co-exist various mental spheres that confer on color different treatments, such as symbolic, esthetic, semantic, axiologic, artistic, and, of course, perceptual calibration. Among such variants, the ordinary individual does not take note of things via the holistic property of Gestalt, which organizes brain activity within a unit. Thus, it is important to localize the origin of each function in order to establish its properties and evolution, which we will proceed to perform with perceptual calibration here. The crux of this is similar to the volubility of the exterior illumination that can be generated in the brain, that is, regular, stable and, up to a certain point, permanent coloration.

Confronted with the continuous changes in the exterior illumination, perception possesses the property of adapting the individual to the environment into which they are inserted (Wolff 1979). So that the brain is not overwhelmed in an ocean of sensory stimuli that converge upon it from all of the senses, including vision, perception stabilizes the sensory impression, filtering the information by priorities or categories that are engaged according to the motivations or interests of each individual. The brain, in any case, seeks out the simplest structure. There is, then, a filter that establishes what each person can see or be blinded from in spite of its being within the visual angle. "A few outstanding

traits not only determine the identify of a perceived object, but also make it appear as a complete or integrated outline” (Arnheim 2008: 59).

We must observe here that the relations of the organisms with their environment are not copies or replicas, although they do generate empathies due to inklings of resemblance of the material with the visual object. Perceptions are not solely data from the stimuli, they should be integrated with another continuous stimulation that is combined with prior experiences that the brain has registered; for the effect, we must consider that such data are unique products of the human organism and not copies of the universe (Bartley 1978: 194). It is clear that we are now addressing experience.

Experience compels us to accept that we are again confronting an object with which we have had previous contact, the object maintaining its properties despite the distant conditions under which it is observed. This is nourished by the permanent interaction between the physical and the psychic world, rendering the stimulus sufficiently similar to what it had formerly had been, thanks to that perception incorporates registries of the past in order to mix these with those of the present and to program future actions. Experience, therefore, is unique and personal and cannot be transmitted from one person to another if it is not through the same experience. Observed in this manner, experience has educative functions not only of the sensory, but also of the cultural order. “The so-called refinement of the senses” is in reality the refinement of the “psychic faculties” (Müller-Freienfels 1966: 274)

On considering *distant* perception, calibration can only be carried out by an educated eye that can evolve into an expert eye, a faculty not found among the ocular components, which are the same for all humans, but instead in the development of abilities of the brain for processing sensory matter. Experience, then, remains irremediably associated with cognitive development, with the nature of the reception, acquisition, assimilation, and use of knowledge (Forgus and Melamed 2003: 11). Seen thus, calibration is the result of a visual education that arises from the organization of sensory and cultural factors. For example, the classical or traditional artist, due to their practice of *mimesis*, formulates mixtures and the application of color (*proximal* perception considering the manner in which light affects the object that they paint), in order to modulate the color and to achieve chiaroscuro effects (*distant* perception). Based on this, *calibration* is a complex act of perception that results in the comparison of the external with the internal image that the brain develops through experience.

Amazingly, in calibration, *proximal* and *distant* perception become united in an operation that leaves it clear that the more experiences the individual has, the better their color calibration could be for highly specialized work. The more “seen”, the more “known”. The field of perception increases with knowledge and culture (Müller-Freienfels 1966: 286).

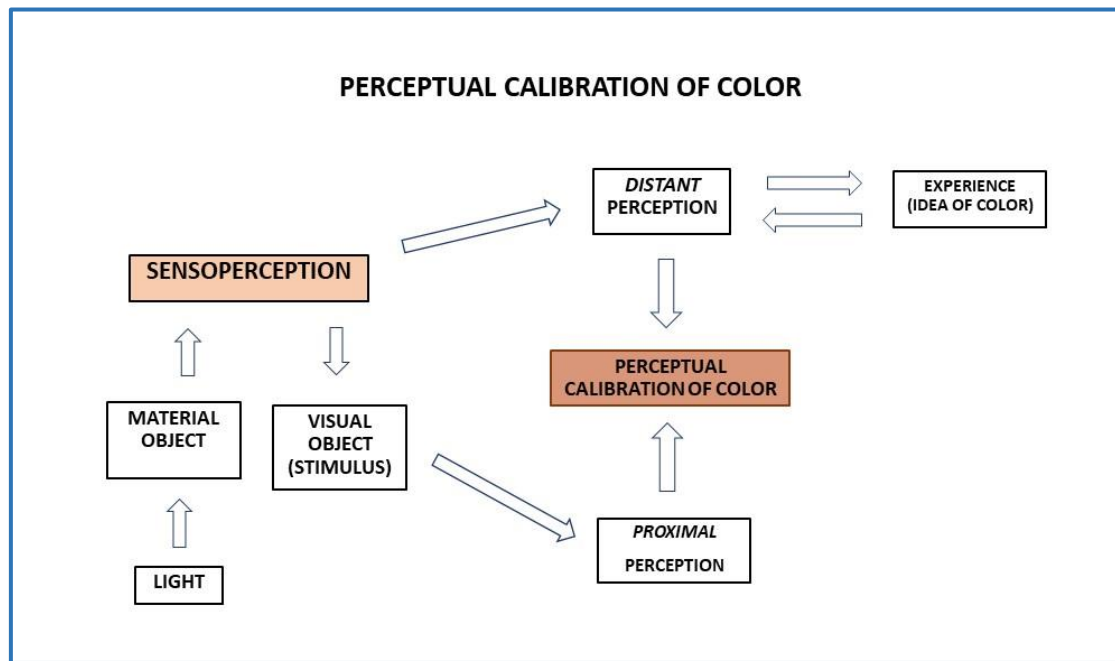

Figure 1.

## CONCLUSIONS

Notwithstanding that each person has individual motivations, the calibration of color is also a cultural expression that can be shared by specialists who entertain the same interests. Bearing in mind the educative role of experience, perceptual calibration can be employed in teaching processes or for evaluating qualified personnel. In conclusion, the title of this work states that this is an approximation; an approach to a theme that is far from being exhausted. This is solely the scaffolding for continuing to explore the properties of perception as well as of the specialized tasks that are employed in the use of color.

## REFERENCES

- Albers, J. 1984. *La interacción del color*. Madrid, España: Alianza Editorial.
- Arnheim, R. 2008. *Arte y percepción visual*. Madrid, España: Alianza Forma.
- Bartley, S. H. 1978. *Principios de percepción*. México, D.F., México: Trillas.
- Forgus, R. H., and L. E. Melamed. 2003. *Percepción. Estudio del desarrollo cognoscitivo*. México, D.F., México: Trillas.
- Husserl, E. 1997. *Ideas relativas a una fenomenología pura y una filosofía fenomenológica*. México, D.F., México: FCE.
- Mueller, C. G., and R. Mae. 1974. *Luz y visión*. Estados Unidos de Norteamérica: Time, Inc.
- Müller-Freienfels, R. 1966. *Tu alma y la ajena. Una psicología práctica para todos*. Barcelona, España: Labor.
- Schiffman, H. R. 2001. *La percepción sensorial*. México, D.F., México: Limusa.
- Wolff, W. 1979. *Introducción a la psicología*. México, D.F., México: Fondo de Cultura Económica.





# Diagnosis of Psoriasis using image segmentation and deep learning

Hao Cui<sup>1</sup> and Renzo Shamey<sup>1,\*</sup>

<sup>1</sup> Color Science and Imaging Laboratory, TECS; North Carolina State University; hcui6@ncsu.edu  
rshamey@ncsu.edu

\* Corresponding author: rshamey@ncsu.edu

## Abstract

Skin diseases such as melanoma and psoriasis often require diagnosis from professional dermatologists making self-detection challenging for patients in the early stages of the disease. Given this background, the aim of this project was to employ a suitable image classifier and an image segmentation method to extract disease relevant color information. This should facilitate early identification of the diseases by patients and assist dermatologists. To that end 2000 images of three types of skin diseases were fed into three types of deep learning algorithms including “YOLOv3, ResNet50 and VGG16. Forty images were segmented using the K-means algorithm and their colors (RGB values) were extracted from the segmented regions. The results using dermatological images indicate that deep learning-based approaches can be used to detect these skin diseases. Extracted color information from segmented images could be potentially used to facilitate accurate communication of colorimetric features among physicians and specialists and improve diagnosis.

**Keywords:** *Deep learning, image segmentation, ResNet50, VGG16*

## INTRODUCTION

According to Hay et. al (2014), various skin conditions could lead to diseases which affect 30-70% of all people globally and therefore impose a significant burden on global health. Psoriasis is a chronic inflammatory skin disease, which is very common in the US. According to Mayo Clinic, there may be more than 3 million cases of psoriasis per year in the US and the disease can last for years or be lifelong. The disease needs to be diagnosed by professional dermatologists since symptoms can vary from person to person. Melanoma is a type of skin cancer that usually needs to be diagnosed visually by a professional dermatologist. The diagnosis also involves dermoscopic analysis, a biopsy, and histopathological examination conducted in a lab environment. Early detection is crucial since timely treatment could dramatically mitigate the impact of these diseases. However, diagnosis often requires professional dermatologists, making self-detection challenging for patients in the early stages of the disease. Thus, many patients may not realize that they have developed the diseases until the later stages of the disease and therefore miss the proper early treatment.

Owing to the fast-paced improvements in machine and deep learning both from hardware and data perspectives, computer vision techniques have developed exponentially in the last decade. With the development of computer vision, deep learning algorithms have been used to detect skin diseases over the last five years. A team at Stanford University, Esteva et al. (2017), pioneered the use of a deep neural net architecture, InceptionV3, to explore the use of deep learning methods for detection of skin cancer from clinical images. Different neural net architectures were subsequently examined by Li et al. (2020, April), Roslan et al. (2020), and Zhao et al. (2020),

There are several challenges in image processing, segmentation and detection of skin lesion images. First, these images contain a lot of noise (i.e., human hair, marks, varicose veins, etc.), which increase their complexity. For image segmentation, edge detectors, K-means and fuzzy c-means have been utilized (Nida et al. 2019; Ajala Funmilola et al. 2012). Although spatial filters, morphological operation, and multiscale curvilinear match filtering can be used to reduce the noise, issues such as blurring, and checkerboard patterns reduce the robustness of these techniques. In addition, there is no universal method for processing all skin images since most methods are designed to target certain types of skin

lesions. Finally, most methods and filters are developed to remove human hairs and blood vessels, while very few are used to remove image marks, which are left by the dermatologist to indicate the diseased area.

## **OBJECTIVES**

The aim of this study was to develop an image classifier to facilitate the early detection of certain skin diseases. Specifically, users would be able to upload an image and use the system's embedded deep learning technology to receive a basic diagnosis. Following the identification of the disease, a suitable image segmentation method is used to extract the relevant colorimetric information of each disease. This aims to facilitate the understanding and the communication of these diseases among the patients, dermatologists and expert practitioners.

To reach these objectives, the existing methods in the domain are explored using the available literature and the methods are replicated using the images/data collected for this study. All the data-images of skin diseases containing psoriasis and melanoma - were scraped from the internet as open-source data. This included a total of 189 images containing five different types of psoriasis mentioned earlier. These images did not contain any ground truth labels from expert dermatologists, however, they contained footnotes in the source websites that identified them as the type of disease under consideration.

These psoriasis images, however, were not sufficient to train an image classifier since a training process requires more than five hundred images that contain ground truth labels. Regarding melanoma images, the "ISIC archive" which is an open source for machine learning purposes was utilized. This database incorporates more than 20,000 high-resolution skin lesion images and was accessed through the API (application programming interface). Although this database contains no psoriasis images it incorporates 20 types of skin lesion images, including melanoma, nevus, and keratosis. In order to create an image classifier, 2000 images including their meta data (ground truth labels) were downloaded containing three types of diseases: melanoma, nevus, and dermatofibroma (fibrous nodule).

The literature was examined to identify suitable methods for building an image classifier as well as an image segmentation system. Based on the stated objectives the prior art was categorized into four different sets: 1) generally insightful, 2) image processing, 3) image classifying, and 4) image segmentation. Each category was used to select appropriate methods and techniques for this project.

## **METHODOLOGY**

The images were preprocessed for noise reduction and data augmentation. The processed images were then fed into the image classifiers, and the detected images were segmented using the image clustering and segmentation techniques. In this project, the images were separated into two batches: 40 were used for image segmentation (20 for psoriasis and 20 for melanoma) and 2000 melanoma images were used to build an image classifier. Methods such as morphological operation, canny edge detection and spatial filters were employed to reduce the noise for the first batch of 40 images before segmenting them, while data augmentation techniques were applied to the second batch before using them to train the image classifier. The user could take a picture and feed it into the image diagnosis system. The information processed by the imaging system could be translated into the results of the diseases classification and color information (RGB values-extracted from segmented images).

### **Data augmentation, edge detection, spatial filtering and morphological operation**

The performance of deep learning neural networks often improves with the amount of data available. Data augmentation is a technique in which new training data is artificially created from existing training data. Aggarwal (2019) demonstrated the effectiveness of adopting data augmentation techniques to improve the performance of image classifiers in detecting skin lesions. Techniques including flipping, rotating, and randomly changing the brightness of the image have been used by using Pytorch data augmentation library. Schmid (1999) and Kang et al (2018) mentioned the use of edge detectors to find the edges of the noise and then remove them from images. Here, Canny edge detector library, a multistage edge detection operator, from OpenCV, was used to detect the edges of noise. Schmid (2019) also showed the potential for adopting spatial filters such as Gaussian and median filters to reduce the noise in medical images. Median, bilateral and Gaussian filters were applied to the images in this study through OpenCV. Morphological operation has been stated to be a promising way to remove the noise such as human hairs and blood vessels from medical images (Lee et al. 1997; Abbas et al. 2011; Huang et al. 2013). Here, the application of morphological operation was found to remove the hairs/vessels/noises, but it also resulted in blurring images and caused a checkerboard pattern problem.

### **Image classifier: YOLO, CNN (ResNet50 and VGG16)**

Redmon et al. (2016) proposed the YOLO (You Only Look Once) model to detect objects and demonstrated its processing capability of 45 frames per second in real time and showed that it learns very general representations of objects and outperforms other detection methods such as R-CNN. Nie et al. (2019) showed the potential use of YOLO for detection of skin lesion diseases. Thus, in this study a YOLO model was built to detect skin diseases based on pytorch-YOLOv3. First, 1000 images (500 nevus and 500 melanoma) were randomly selected from the 2000 skin lesion images downloaded from ISIC-archive. Next, a YOLO model was built up based on a pre-trained model (weights) downloaded from Darknet2. After developing the model architecture 2 separate trainings were used. In the first set, 300 images (200 melanoma and 100 nevus) were used for training and 80 dermoscopic images were used for testing. To improve the generalization of the model, 250 images (150 melanoma and 100 nevus) were also used to train and 80 dermoscopic and clinical images were used for testing the same model. The training was done on a PC running Intel® Core™ i7-10510U CPU @ 1.80GHz 2.30 GHz and 16 GB RAM. A total of 1341 colored images (480×600) were randomly selected from 2000 skin lesion images. Considering the computational power and available RAM the images were resized to (224×224). The data was also split into 70% for training and 30% for validation purposes.

Transfer learning was attempted by applying other pre-trained models instead of building a convolution neural net from scratch. The pre-trained models (VGG16 and ResNet50) from torchvision were used and applied in the last layer of our model. VGG16 is a very deep convolutional network, used for image recognition by Simonyan and Zisserman (2014). The output layer is similar to other deep neural networks such as Alexnet. Inspired by VGG16, He et al. (2016) proposed an architecture of the network “Resnet” by adopting the residual learning to every stacked layer and claimed this structure could improve the model performance. Resnet50 was employed which generated superior results compared to other structures. Each training was run through 25 epochs with a learning rate of 0.001. Figures 1 shows the training and validation loss and accuracy for VGG16 and ResNet50 models.

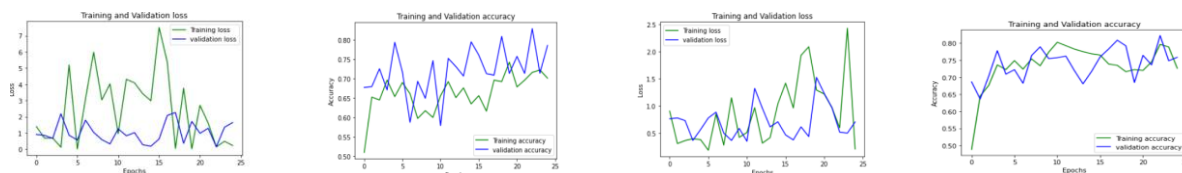

Figure 1: Training/validation loss and accuracy for VGG16 (left) and Resnet 50 (right).

K-means was used for segmentation due to resource and time considerations. Most of the medical images were found to have 3 segments, 1) noise -human hair and blood vessels, 2) skin lesion, and 3) normal skin. Most of the psoriasis and melanoma images were segmented well at k=3. A library from OpenCV was used to conduct image segmentation for all 40 images.

### RESULTS

A total of 160 images were used to evaluate the performance of the model. These images were separated into 2 datasets with 80 images each (50 melanoma and 30 nevus). The YOLO model was trained using two attempts. Given the results of testing, three types of metrics were used to evaluate the model’s performance: precision, recall and F1 score. Precision reflects the model’s capability to detect the true positive cases out of all positive cases diagnosed by the model. Recall indicates the true positive rate or sensitivity since it calculates the ratio of the true positive instances with the total number of positive cases from the samples. The F1 score shows a measure that combines and represents the harmonic mean of precision and recall.

The test images were detected by the YOLO models (models trained from the 1<sup>st</sup> and 2<sup>nd</sup> attempts). Figure 2 shows the detected images with the anchor box tagged around the disease area. Based on the prediction results for the test images, the precision, recall, and F1 scores were calculated for two types of skin lesions under 2 attempts as shown in Table 1.

	Precision	Recall	F1 Score
<b>Melanoma (1<sup>st</sup> trial)</b>	<b>0.52</b>	<b>0.63</b>	<b>0.57</b>
<b>Nevus (1<sup>st</sup> trial)</b>	<b>0.55</b>	<b>0.52</b>	<b>0.53</b>
<b>Melanoma (2<sup>nd</sup> trial)</b>	<b>0.67</b>	<b>0.72</b>	<b>0.69</b>
<b>Nevus (2<sup>nd</sup> trial)</b>	<b>0.69</b>	<b>0.59</b>	<b>0.64</b>

Table 1 Performance metrics for the YOLO models\*

\*Values rounded to the nearest hundredth.

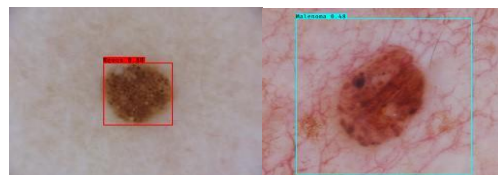

Figure 2: Sample results from the test batches.

A total of 241 images, including 124 melanoma, 76 nevus, and 41 dermatofibroma were used for testing. The precision, recall, and F1 score were calculated for three types of skin lesions. Table 2 shows the performance of the VGG16 and ResNet50 models.

VGG16	TP**	FP**	FN**	Precision	Recall	F1 Score
0-Melanoma	113	29	11	0.80	0.91	0.85
1-Nevus	46	12	30	0.79	0.61	0.69
2-Dermatofibroma	34	7	7	0.83	0.83	0.83
Resnet 50						
0-Melanoma	118	15	6	0.89	0.95	0.92
1-Nevus	61	3	15	0.95	0.80	0.87
2-Dermatofibroma	39	5	2	0.88	0.95	0.91

Table 2 Performance of the models\*.

\*values rounded to the nearest hundredth

\*\*TP, FP and FN refer to the true positive, false positive and false negative instances

The results show good performance for classification of the skin diseases. The ResNet50 model outperforms the VGG16 model for this dataset. Figure 3 shows image segments with a green mask for both original and processed images involving psoriasis. Results indicate that K-means does not perfectly separate the diseased area even after applying the morphological operation.

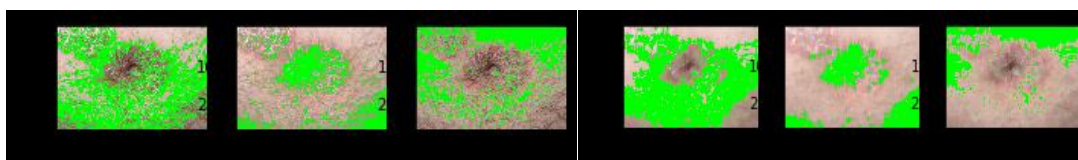

Figure 3: Segmentation without (left) and with (right) morphological operation.

Similarly, k-means algorithms were used to segment the melanoma images from the ISIC-archive. To test the impact of noise, k-means was used for both original and morphologically operated images. In this case since the images had high resolution and good quality hairs had little impact on the process and the diseased area was clearly separated (Figure 4).

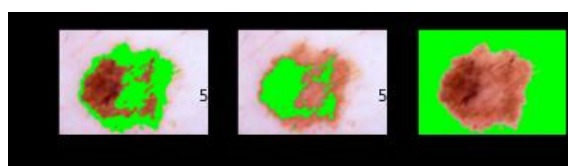

Figure 4: Segmented melanoma image after applying the morphological operation.

## CONCLUSIONS

The results of the transfer learning model indicate that deep learning-based approaches have the potential for detection of certain skin diseases. However, some limitations were also identified. High false-negative cases were noted for nevus which can impact the recall-sensitivity. The hyperparameter of the models was not tuned and image segmentation was done using k-means in the RGB color space. Other algorithms such as Fuzzy C-means, Fully Convolutional Networks, and maximally stable extremal regions (MSER)) could be attempted to improve the process. In addition, the impact of noise can be significant especially for psoriasis images since filtering can blur psoriasis images, and some areas containing high hair density areas may not be easily removed.

**REFERENCES**

- Abbas, Q., et al (2011). Hair removal methods: a comparative study for dermoscopy images. *Biomedical Signal Processing and Control*, 6(4), 395-404.
- Aggarwal, L. P. (2019). Data augmentation in dermatology image recognition using machine learning. *Skin Research and Technology*, 25(6), 815-820.
- Ajala Funmilola, A., et al (2012). Fuzzy kc-means clustering algorithm for medical image segmentation. *Journal of Information Engineering and Applications*, 2(6), 21-32.
- Esteva, A., et al (2017). Dermatologist-level classification of skin cancer with deep neural networks. *Nature*, 542(7639), 115-118.
- Hay, R. J., et al (2014). The global burden of skin disease in 2010: an analysis of the prevalence and impact of skin conditions. *Journal of Investigative Dermatology*, 134(6), 1527-1534.
- He, K., et al (2016). Deep residual learning for image recognition. In *Proceedings of the IEEE conference on computer vision and pattern recognition* (pp. 770-778).
- Huang, A., et al (2013, July). A robust hair segmentation and removal approach for clinical images of skin lesions. In *35th Annual International Conference of the IEEE Engineering in Medicine and Biology Society (EMBC)* (pp. 3315-3318). IEEE.
- Kang, D., Kim, S., and Park, S. (2018). Flow-guided hair removal for automated skin lesion identification. *Multimedia Tools and Applications*, 77(8), 9897-9908.
- Lee, T., et al (1997). Dullrazor®: A software approach to hair removal from images. *Computers in biology and medicine*, 27(6), 533-543.
- Li, Y., et al (2020, April). PSENet: Psoriasis Severity Evaluation Network. In *Proceedings of the AAAI Conference on Artificial Intelligence* (Vol. 34, No. 01, pp. 800-807).
- Mayo Clinic: <https://www.mayoclinic.org/diseases-conditions/psoriasis/symptoms-causes/>
- Nida, N., et al (2019). Melanoma lesion detection and segmentation using deep region based convolutional neural network and fuzzy C-means clustering. *International journal of medical informatics*, 124, 37-48.
- Nie, Y., et al (2019). Automatic Detection of Melanoma with Yolo Deep Convolutional Neural Networks. In *IEEE International Conference on e-Health and Bioengineering 2019*.
- Redmon, J., et al (2016). You only look once: Unified, real-time object detection. In *Proceedings of the IEEE conference on computer vision and pattern recognition* (pp. 779-788).
- Roslan, et al (2020). Evaluation of psoriasis skin disease classification using convolutional neural network. *IAES International Journal of Artificial Intelligence*, 9(2), 349.
- Schmid, P. (1999). Segmentation of digitized dermatoscopic images by two-dimensional color clustering. *IEEE Transactions on Medical Imaging*, 18(2), 164-171.
- Simonyan, K. and A. Zisserman. 2014. Very deep convolutional networks for large-scale image recognition. *arXiv preprint arXiv:1409.1556*.
- Zhao, S., et al (2020). Smart identification of psoriasis by images using convolutional neural networks: a case study in China. *Journal of the European Academy of Dermatology and Venereology*, 34(3), 518-524.

# Designing a Single Pre-filter for Making a Group of Cameras more Colorimetric

Yuteng Zhu <sup>1, \*</sup> and Graham D. Finlayson <sup>1</sup>

<sup>1</sup> Colour and Imaging Lab, University of East Anglia, Norwich Research Park, Norwich, United Kingdom; {yuteng.zhu, g.finlayson}@uea.ac.uk

\* Corresponding author: yuteng.zhu@uea.ac.uk

## Abstract

A recent study (Finlayson and Zhu 2020a) proposed a method for designing a color filter that when placed in front of a given camera makes the camera more colorimetric. However, in the previous work, a specific filter needs to be designed and manufactured for each individual camera. In this paper, we extend the prefiltering idea by solving for a single optimal filter that works best for a collection of digital cameras. The starting point for this study is the observation that many digital cameras have very similar sensitivity functions, and that this is especially true for cameras made by the same manufacturer. We show that a single prefilter can be found that improves the colorimetric ability for a collection of cameras, i.e. to record color information more truthfully to the stimulus responses by the human eye.

**Keywords:** *Color filter, Digital camera, Colorimetry, Color Correction*

## INTRODUCTION

Digital cameras record the color information of the real-world scenes by using three color channels, commonly known as Red, Green and Blue according to their specific color sensitivities. The camera sensors record a color image in a way that is analogous to how the cone receptors of the human visual system respond to light. However, the actual color responses recorded by a camera are somewhat different from those recorded by the cones and, moreover, they cannot be linearly corrected to these responses. As such we say that a camera is not colorimetric.

A camera is perfectly colorimetric if it satisfies the Luther condition (Horn 1984): the camera spectral sensitivities are a linear transform from the CIE XYZ color matching functions of a standard observer (Schanda 2007). In practice, however, digital cameras are designed to satisfy many engineering objectives including manufacturability and noise control. As a result, digital cameras usually deviate from the ideal Luther condition.

Recent studies by Finlayson et al. (2018) have proposed a method of finding a color filter that when placed in front of a camera makes the camera more colorimetric. See the left panel in Figure 1 for the illustration of a color filter added to a camera. For all the cameras tested, it was shown there exists a physically realizable prefilter that makes the camera much more colorimetric. Indeed, for many cameras the recorded RGBs are almost precisely linearly related to the corresponding cone responses (which in turn means the RGBs are linearly related to XYZs, the standard color space used in color measurement that is a linear transform from the cone sensitivities). The best filters, however, can at some wavelengths absorb much of the incident light and this has raised the question of signal-to-noise ratio. In recent work, the noise issue in the prefilter design has been studied by Vrhel (2020). In Vrhel's formalism, the colorimetric measurement potential of a camera is traded off against the amount of noise that is present in captured images (for a given intensity of light). In a separate study by Finlayson Zhu (2020b), it was shown that highly transmissive filters can make cameras much more colorimetric.



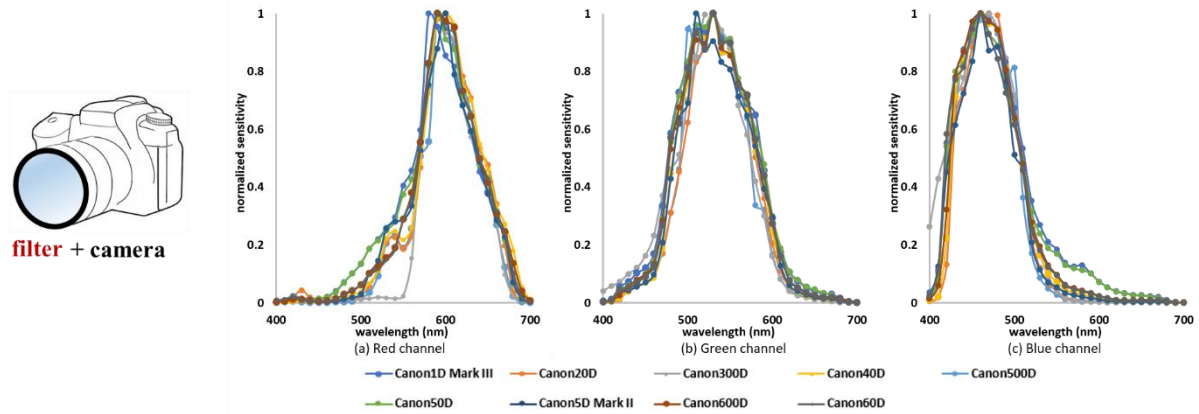

Figure 1: Left: Illustration of a color filter placed in front of a camera. Right: The normalized spectral sensitivity curves of 9 Canon cameras of their Red, Green and Blue channels, respectively.

In this paper, we extend the idea of designing color filters. Rather than designing a filter for a single target camera, we seek for a filter that will make a range of cameras more colorimetric. From plotting the sensitivity functions of a group of cameras (Jiang et al. 2013) shown on the right panel of Figure 1, we observe that, in each color channel, cameras present similar curve shape and share a large overlap. Accordingly, we reformulate the filter design problem as an optimization that can best make a set of cameras simultaneously satisfy the Luther condition. As for the single camera optimization, our new method is formulated as an Alternating Least-Squares (ALS) minimization. To quantify the improvement in color measurement, we calculate the statistics of the color measuring metrics - in terms of CIELAB color difference (Wyszecki and Stiles 1967) - between the ground truth values and those measured by the cameras with and without the use of the optimal filter. We show that the experimental results validate the idea of finding and using a single prefilter that results in significant improvement in color measurement accuracy for a group of cameras.

## Method

In this section, we present the development of the mathematical formulation and algorithm for designing a single prefilter that makes multiple cameras best satisfy the Luther condition, i.e. makes all the cameras more colorimetric.

Let  $Q$  denote an  $n \times 3$  matrix with each column representing a discretely sampled spectral sensitivity curve of a given camera over the wavelength spectrum in the visible range, e.g.  $n=31$  when we sample the sensitivity response between 400 nm and 700 nm using a 10 nm sampling interval. Similarly, let  $X$  an  $n \times 3$  matrix denote the 1931 CIE XYZ color matching functions of a standard observer. Let  $F$  denote an  $n \times n$  diagonal matrix with the element in its main diagonal representing the transmittance values at each sampled wavelength.

When we place a color filter in front of a camera, the effect of 'filter+camera' can be modeled by the multiplication of the filter transmittance and the camera spectral sensitivities on a per wavelength basis. Mathematically, it is expressed as  $FQ$ . If we use the same filter for a group of  $k$  cameras,  $Q_1, Q_2, \dots, Q_k$ , by stacking them in rows, we can have

$$Q = \begin{bmatrix} FQ_1M_1 \\ FQ_2M_2 \\ \vdots \\ FQ_kM_k \end{bmatrix} \quad (1)$$

with a linear transform for each camera where  $M_1, M_2, \dots, M_k$  are full-rank  $3 \times 3$  matrices representing per-camera linear transforms. The matrix  $Q$  is in the size of  $nk \times 3$  with columns denoting the Red, Green and Blue channels. Similarly, for the reference XYZ color matching function matrix, we can construct an  $nk \times 3$  matrix,  $X$ , with  $k$  rows of  $X$  matrices (we vertically stack the  $n \times 3$  matrix – each column is the X, Y and Z CMFs – by  $k$  times).

$$x = \begin{bmatrix} X \\ X \\ \vdots \\ X \end{bmatrix} \quad (2)$$

We solve the Luther condition filter design problem for multiple cameras by minimizing:

$$\min_{F, M_j} \|Q - X\|_{Frob}^2, \quad j \in \{1, 2, \dots, k\} \quad (3)$$

where  $\| \cdot \|_{Frob}^2$  denotes the Frobenius norm.

There is no closed-form solution to the objective function given in Equation (2). However, we can solve for the filter and the linear transform matrices using a technique called Alternating Least-Squares (ALS). By seeding the algorithm with a 100% transmissive filter as an initial guess, we solve for the per-camera  $3 \times 3$  matrix taking each set of filtered camera spectral sensitivities to the XYZ CMFs using the least-squares regression. We now solve for the best filter given these corrected sensitivities. We proceed in this way until convergence. Interested reader can refer to Finlayson and Zhu (2020a) for details of the ALS algorithm used for solving the optimal filter for the single camera optimization. The minimization needed here follows the same structure. Importantly, this Alternating Least-Squares method has known convergence properties and it can be extended to allow constraints to be added to the shape and transmittance of the filter (an important property that we will apply in the future study for better control of the filter shape and transmissivity).

## RESULTS

The spectral transmittance of the optimal filter solved for a group of 9 Canon cameras that makes them best satisfy the Luther condition is shown in Figure 2. The transmittance values are between 0 and 100% with its maximum value normalized at 100%. From the figure, we see that the filter is in the good shape with reasonable transmissivity across the spectrum (about 50% on average) and transmits slightly more light of bluish range (short wavelength) than that of the reddish range (long wavelength).

The effectiveness of the optimal filter is examined in a color measurement experiment where we evaluate, for each camera, how RGBs measured by the camera are best corrected to match the reference XYZ tristimulus values when the optimized filter is placed in front of the camera. For each camera, we calculate the RGBs -- both native (unfiltered) and filter corrected -- of a collection of 1995 reflectance spectra under an ensemble of 102 illuminants (Barnard et al., 2002). Then the optimal least-squares linear correction is found to best predict the ground-truth XYZ values. The color differences between the camera measured and the reference color values are calculated in the CIELAB color space (a perceptually uniform color space). A single color correction experiment is to calculate these error measures for a collection of surface reflectances under one light (of the 102 lights). Thus, we calculate the mean of the statistic (i.e. the mean of the mean, of the median, of the 95-percentile, and of the maximum) over the 102 lights. Table 1 summarizes the color accuracy per camera - both for the native camera (without a filter) using linear color correction and that with the optimal filter and linear color correction in terms of the statistics of the mean, median, 95-percentile and maximum color errors.

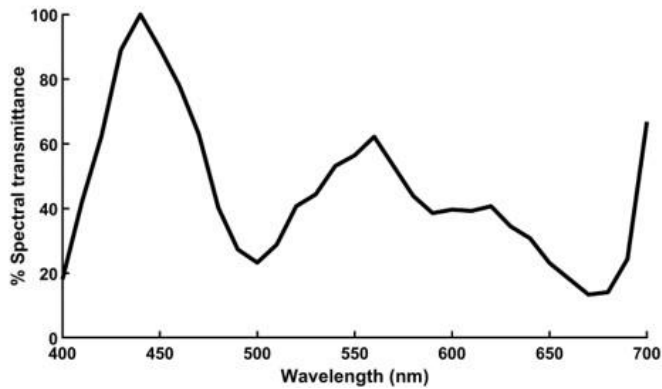

Figure 2: The spectral transmittance of the optimal filter solved for a group of cameras.

	Native camera without a filter				Camera with a prefilter			
	Mean	median	95%	max	Mean	median	95%	max
Canon 1D	1.45	0.76	4.74	32.03	0.67	0.40	2.22	7.50
Canon 20D	2.08	1.15	6.71	36.12	1.02	0.62	3.26	11.46
Canon 300D	1.48	0.77	4.80	35.09	0.91	0.59	2.81	11.88
Canon 40D	1.72	1.03	5.12	28.39	0.56	0.34	1.79	9.32
Canon 500D	1.22	0.68	3.60	25.22	0.58	0.33	1.91	17.87
Canon 50D	1.11	0.64	3.24	22.32	0.50	0.28	1.61	16.00
Canon 5D	1.42	0.84	4.26	29.39	0.34	0.18	1.16	8.23
Canon 600D	1.40	0.80	4.15	27.14	0.43	0.24	1.34	12.46
Canon 60D	1.21	0.68	3.59	25.27	0.48	0.28	1.52	14.27
<b>Average</b>	1.45	0.82	4.47	29.00	0.61	0.36	1.96	12.11

Table 1: Performance of cameras with the optimal filter versus the native cameras in terms of CIELAB color error statistics.

It is evident that the optimized filter improves significant in color accuracy for every camera in the group, with a reduction of mean color error by a third to three-quarters depending on the individual camera in the group. On average, a prefilter can help reduce more than 50% across the error statistics. Additionally, we have found that the color measurement performance of a single filter is similar to that obtained when a per-camera filter is used (Finlayson and Zhu 2020).

## CONCLUSION

In this paper, we set forth a filter design method such that a single optimal filter can be used for a collection of cameras that make them best satisfy the Luther condition. Consequently, cameras after filtering can ‘see’ the color in the real world more colorimetrically. That is, with the addition of a filter placed in front, cameras can measure colors more accurately in the sense that colors recorded by a camera can much better predict or linearly related to the ground-truth XYZ tristimulus values. Experiments validate our method.

In the future study, we will work on how to make the designed filter better meets the feasibility in manufacture and once the filter is fabricated, the color measurement experiment will be performed by digital cameras for real-world scenes.

### **ACKNOWLEDGEMENTS**

This research is partly funded by EPSRC Grant EP/S028730/1.

### **REFERENCES**

- Barnard, K., L. Martin, B. Funt, and A. Coath. 2002. A data set for color research. *Color Research & Application* 27(3): 147-151.
- Finlayson, G. D., Y. Zhu, and H. Gong. 2018. Using a simple colour pre-filter to make cameras more colorimetric. In: *Color and Imaging Conference*, 182-186. Society for Imaging Science and Technology.
- Finlayson, G. D. and Y. Zhu. 2020. Designing color filters that make cameras more colorimetric. *IEEE Transactions on Image Processing* 30: 853-867.
- Finlayson, G. D. Y. and Zhu. 2020. An improved optimization method for finding a color filter to make a camera more colorimetric. In: *Electronic Imaging* 15, 163-1. SPIE.
- Horn, B. K. 1984. Exact reproduction of colored images. *Computer Vision, Graphics, and Image Processing* 26(2): 135-167.
- Jiang, J., D. Liu, J. Gu, and S. Süsstrunk. 2013. What is the space of spectral sensitivity functions for digital color cameras?. In: *IEEE Workshop on Applications of Computer Vision*, 168-179. IEEE.
- Schanda, J. 2007. *Colorimetry: understanding the CIE system*. New York: John Wiley & Sons.
- Vrhel, M. J. 2020. Improved camera color accuracy in the presence of noise with a color prefilter. In: *Color and Imaging Conference*, 28, 187-192. Society for Imaging Science and Technology.
- Wyszecki, G., and W. S. Stiles. 1967. *Color science, concepts and methods, quantitative data and formulae*. New York: John Wiley and Sons.



# Fast and Optimal Contrast Limited Tone Mapping

Jake McVey<sup>1</sup> and Graham Finlayson<sup>2</sup>

<sup>1</sup> University of East Anglia; J.McVey@uea.ac.uk

<sup>2</sup> University of East Anglia; G.Finlayson@uea.ac.uk

\* Corresponding author: j.mcvvey@uea.ac.uk

## Abstract

Image enhancement is often formulated as a tone mapping operation, where input pixel intensities in an image are mapped – by a strictly increasing one-to-one function – to output intensities. One of the most widely deployed tone mapping algorithms is Contrast Limited Histogram Equalization (CLHE). In CLHE the input image is tone mapped such that the histogram of the output image is most-uniform, subject to the constraints that the slopes of the tone curve are neither too steep nor too shallow. In CLHE the tone map is the integral of a derived histogram that by construction is both close to the histogram of the input image but also where the integral (the tone map) meets the slope constraints. However, recent work showed that the CLHE derived histogram is not optimal. By recasting CLHE in a quadratic programming framework, one can find a derived histogram that meets the slope constraints and is even closer to the input histogram. Of course, quadratic programming is a search-based algorithm, and to find the optimal derived histogram it needs hundreds of iterations to fully converge. In this paper we show, empirically, that convergence is achieved much more quickly (always <5 iterations) if the goal is to achieve a tone mapped image that is visually indistinguishable from the tone mapped image generated after full convergence. Experiments validate our method.

**Keywords:** Contrast Enhancement, Tone Mapping, Image Processing, Histogram Equalization

## INTRODUCTION

When an image appears to be too dark, or indeed too bright, the quality of the image can often be improved by brightening (or darkening) some of the pixels or by altering the image contrast. An enhanced image generally makes image detail more apparent compared to the original image. Often image enhancement is formulated as a tone mapping operation, where input pixel intensities in an image are mapped - by a strictly increasing one-to-one function (that can be implemented as a lookup table) - to output pixel intensities. For example, suppose that image brightnesses lie in the interval  $[0, 1]$  and that a given image appears too dark. By raising the brightnesses in this image to the power of 0.5 we will lighten the image. The ‘to the power of 0.5’ is an example of a tone mapping function (equally, of a tone curve).

Perhaps, the most well-known tone mapping algorithm is Histogram Equalization (HE). Here, we have an input image that has an associated (and arbitrary) brightness histogram. For a standard greyscale image with  $2^8 = 256$  pixel values we can think of the histogram,  $\mathbf{h}$ , as vector with 256 bins, where each bin  $\mathbf{h}_k$  counts the occurrences of pixel intensity  $k$  in the image. This histogram is then normalized so it sums to 1 (it is the probability density function, PDF) before the CDF (cumulative density function) is calculated. This CDF is called the HE tone curve.

The HE tone curve maps the brightnesses of the input image to new values in the output image such that the histogram of the output image is uniform (or close to uniform, Gonzales and Woods 2002). Unfortunately, the shape of the HE tone curve is unrestricted and can have very large and very small slopes, and this can result in unnatural contrast (too much or too little) in the tone mapped output image.

Contrast Limited Histogram Equalisation (CLHE, Pizer et al. 1987) avoids unnatural contrast in the output image by ensuring that the tone curve neither has a slope that is too large nor too small. In effect, CLHE maps an input to an output image where the histogram of the latter is ‘most’ uniform

subject to the slope constraints. In CLHE, this idea of ‘most’ uniform is formulated as an optimization objective which is solved iteratively. Significantly, in McVey and Finlayson (2019) it was shown that CLHE may actually return a solution that is not optimal (is not the best solution to the optimization). In the same paper a Quadratic Programming variant, QPCLHE, was developed which does return the global optimal solution.

In Figure 1, left, we show a greyscale image from the well-known Kodak database (Kodak 1999). In the middle we show the same image enhanced with Histogram Equalization. Clearly the image has too much contrast. On the right we show the enhanced image found by CLHE. The details in this image have been increased, but the image retains a natural appearance and still looks improved compared to the original.



Figure 1: A greyscale image (left) enhanced with Histogram Equalization (middle) and Contrast Limited Histogram Equalization (right).

The CLHE and QPCLHE algorithms are discussed more in section 2. In section 3 we define a lightweight implementation of QPCLHE through constraints on the allowed number of iterations. In section 4 we detail the results of experiments, and the paper concludes in section 5.

## **BACKGROUND**

In Figure 2, we show two histograms (left) and their related tone curves (right). The input histogram (dashed lines) has a large spike on a narrow interval and so the HE tone curve (also a dashed line) has a very steep slope on that same interval. The height of the input histogram defines the slope of the corresponding tone-curve (defined to be the integral of the input histogram). Similarly, some of the histogram bins are empty and so the tone curve is very flat in those places. These high and low slopes can cause excessive contrast and loss of details respectively (as seen in the HE image of Figure 1). The CLHE histogram (solid red line, left) has bin values that are neither too large nor too small, and so the tone curve is much more ‘reasonable’. The CLHE histogram is derived from the input histogram.

CLHE iteratively modifies the input histogram bin counts using two distinct steps that repeat until convergence. The first step bounds the values in the histogram that lie above or below some threshold. The specific threshold values correspond directly to slope values in the tone curve (see McVey and Finlayson 2019 for review). This is sometimes referred to as the ‘clipping’ step. Once we clip to the bounds the resulting clipped histogram may not sum to one (a necessary condition if we wish to use the integral to compute the tone curve). So, in the second step we either add or remove a small amount evenly across all histogram bins so the result is a histogram that sums to 1. This second step is referred to as the ‘redistribution’ step.

While it was shown in [McVey and Finlayson 2019] that CLHE does not find the overall optimal histogram, the individual clipping and redistribution steps that are themselves ‘least squares optimal.’

For the clipping step, consider an arbitrary  $N$ -bin histogram,  $\mathbf{h}^i$ , containing random values that sum to 1. Suppose we would like to constrain the values of  $\mathbf{h}^i$  such that none of the bins violate some upper ( $U$ ) and lower ( $L$ ) bounding values. Clearly,  $\mathbf{h}^c = \max(\min(\mathbf{h}^i, U), L)$  is the closest histogram to  $\mathbf{h}^i$  that meets the bounding constraints.

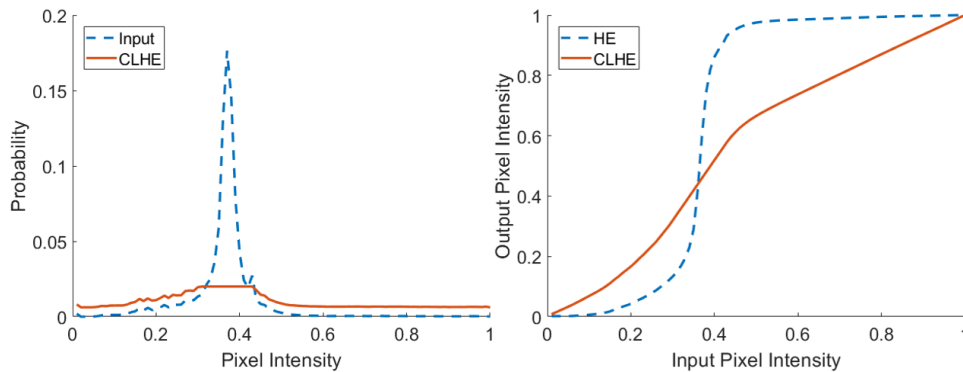

Figure 2: Histograms and associated tone curves of a greyscale image. Left, normalized (and modified) histogram of pixel intensities. (Image PDFs). Right, tone curves that are cumulative sum (CDFs) of the histograms.

In the redistribution step, the clipped histogram  $\mathbf{h}^c$ , sums to less than one. By incrementing each bin of the histogram evenly by some amount (in this case by  $(1 - \sum \mathbf{h}^c)/N$ ) – that is the sum of  $\mathbf{h}^c$  subtracted from one - we find a new histogram  $\mathbf{h}'$  that sums to 1. Actually, over all choices of histograms that sum 1,  $\mathbf{h}'$  is closest to  $\mathbf{h}^c$  in a least-squares sense. However, these two steps that clip then redistribute, while individually optimal, do not find a derived histogram that is optimal (i.e. the histogram that is close to the original histogram and meets the slope constraints).

Below, in Equation 1 we see the formulate that is the expression of a derived histogram as a Quadratic Program. Here we find a histogram  $\mathbf{h}$  that is as close as possible to the input histogram  $\mathbf{h}^i$  where the histogram counts sum to one and each bin of  $\mathbf{h}$  satisfies the bound constraints.

$$\min_{\mathbf{h}} \|\mathbf{h}^i - \mathbf{h}\|_2^2$$

$$s. t. \begin{cases} \sum_{k=1}^N \mathbf{h}_k = 1 \\ \mathbf{h}_k \geq L \\ \mathbf{h}_k \leq U \end{cases}$$

## METHOD

Quadratic Programming (QP) is a search-based framework for solving quadratic optimization problems with linear equality and inequality constraints, e.g. Marguerite and Wolfe (1956). Generally, and for the formulation in Equation 1, a QP solver takes 100s of iterations to reach convergence. Thus, while we can optimally solve for a derived histogram doing so is a much more laborious computation than CLHE (which typically converges in 10 iterations).

In this paper we investigate the QPCLHE solution that is found when the number of iterations is a priori limited. Our hypothesis is that the derived histogram after a small number of iterations will induce a tone curve that will produce a tone mapped image that is visually indistinguishable from the tone curve found after full iteration to convergence.



## EXPERIMENTS

First, let us find the optimal number of iterations in QPCLHE that generates good images. Here, optimality is considered as the tradeoff between the quality of the enhanced images and the computation time. To find this number of iterations required, we run the full iteration-to-convergence QPCLHE algorithm to generate the ground truth tone-mapped images. Next, we generate alternative tone curve by stopping the QP search after a fixed number of iterations. For each max number of iterations,  $M$ , we compare the generated outputs to the ground truth images. For our error measure we use the mean CIE LAB Delta E\* [Robertson (1976)] between the images. Research has shown that for complex images (such as the photographic pictures used in this work) an average Delta E of between 3 (Stokes et al. 1992) and 5 (Meyer 1989) is visually not noticeable.

For our experiments, we use three test datasets: the well-known Kodak dataset (Kodak 1999) that contains 24 RGB images. A randomly sampled set of 20,000 RGB images from the ImageNet dataset (ImageNet 2019), and 20,000 RGB images from the MIT Places database (Places 2021). In each case the ground truth images are the tone mapped outputs found by allowing QPCLHE to iterate to convergence and applying the calculated tone curves (from the derived histograms found from Q). The test images are found by fixing the number of iterations in QP (to 1, 2, 3, 4 and 5). For each of these max iterations and each image we calculate the Mean Delta E for each test and ground truth image (per data set).

	$M = 1$	$M = 2$	$M = 3$	$M = 4$	$M = 5$
<b>Kodak</b>	5.37 ( $\pm 1.55$ )	4.58 ( $\pm 1.21$ )	1.57 ( $\pm 0.41$ )	0.29 ( $\pm 0.08$ )	0.03 ( $\pm 0.00$ )
<b>ImageNet</b>	4.68 ( $\pm 1.31$ )	3.92 ( $\pm 0.97$ )	1.33 ( $\pm 0.53$ )	0.3 ( $\pm 0.05$ )	0.05 ( $\pm 0.00$ )
<b>Places</b>	4.79 ( $\pm 1.22$ )	4.01 ( $\pm 0.63$ )	1.76 ( $\pm 0.51$ )	0.33 ( $\pm 0.04$ )	0.05 ( $\pm 0.00$ )

Table 1: Mean ( $\pm$  standard deviation) of the mean Delta E\* for enhanced images, averaged over each image in the datasets.

In Table 1 we show the Delta E error statistics for QPCLHE compared to limited-QPCLHE when the maximum iterations are constrained to be between 1 and 5. Clearly, for the 3 image sets the error is very close to zero as the number of iterations approaches 5. It appears that constraining the number of iterations to a maximum of 3 is a sensible choice for minimizing computation and still generating good quality images. In Figure 3 we show an image (a) that has been enhanced with QPCLHE (>100 iterations) (b), CLHE (c), and QPCLHE limited to 3 iterations (d). Notice that the CLHE image differs from the other enhanced images (CLHE an QPCLHE by definition can produce different answers). Also, that the limited-iteration QPCLHE image is indistinguishable from the QPCLHE image even under close observation.

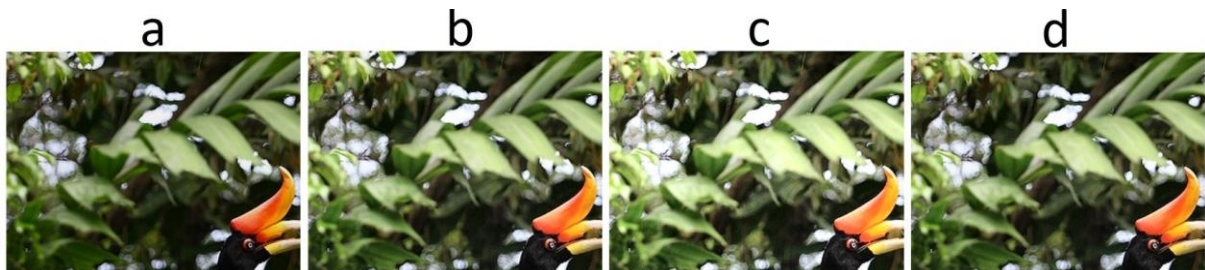

Figure 3: An input image, **a**, enhanced with each algorithm. **b**) Fully converged QPCLHE. **c**) CLHE. **d**) QPCHLE after 3 iterations.

## **CONCLUSION**

Contrast Limited Histogram Equalization (CLHE, Pizer et al. 1987) attempts to modify a histogram such that the values are bounded to upper and lower values, and the histogram remains as close to the original as possible in a least-squares sense. It was shown in McVey and Finlayson (2019) that CLHE falls short of this goal, but optimality could be achieved when the CLHE formalism is recast as an optimization problem and solved with a Quadratic Programming solver.

QPCLHE does converge to the optimal histogram but is a significantly more computationally intensive algorithm than CLHE. While numerical convergence of QPCLHE often takes over 100 iterations to achieve, we show in the paper that convergence in the sense of visual perception is attainable when the iterations are severely limited (to 3 or 4 iterations). Experiments validate our method.

## **ACKNOWLEDGEMENTS**

The authors are grateful for funding from EPSRC grant EP/S028730/1.

## **REFERENCES**

- Gonzalez, R. C. and R. E. Woods. 2002. Digital image processing. ...
- ImageNet Image Database. 2019. <http://image-net.org/index>. Accessed 1-6-19.
- Kodak lossless true color image suite. 1999. <http://r0k.us/graphics/kodak/>. Accessed 1-6-19.
- Marguerite, F. and P. Wolfe. 1956. An algorithm for quadratic programming. *Naval research logistics quarterly* 3, no. 1-2: 95-110.
- McVey, J. and G. Finlayson. 2019. Least-Squares Optimal Contrast Limited Histogram Equalisation. *Color and Imaging Conference*. Vol. 2019. No. 1. Society for Imaging Science and Technology.
- Meyer, G. W. 1989. Reproducing and synthesizing colour in computer graphics. *Displays* 10, no. 3, 161-170.
- Pizer, Stephen M., E. Philip Amburn, J. D. Austin, R. Cromartie, A. Geselowitz, T. Greer, B. Haar Romeny, J. B. Zimmerman and K. Zuiderveld. 1987. Adaptive histogram equalization and its variations. *Computer vision, graphics, and image processing* 39, no. 3, 355-368.
- Places, The Scene Recognition Database. 2021. <http://places2.csail.mit.edu/>. Accessed 2-1-21.
- Robertson, A. R. 1977. The CIE 1976 color-difference formulae. *Color Research & Application* 2, no. 1, 7-11.
- Stokes, M., M.D. Fairchild and R.S. Berns. 1922. Precision requirements for digital color reproduction. *ACM Transactions on Graphics (TOG)* 11, no. 4, 406-422.



# Deriving representative color palettes from mood board images

Arjan Gijsenij<sup>1,\*</sup>, Peter Spiers<sup>2</sup>, Stephen Westland<sup>3</sup> and Pim Koeckhoven<sup>1</sup>

<sup>1</sup> AkzoNobel Color Technology; Rijksstraatweg 31, 2171 TJ Sassenheim, The Netherlands; Arjan.Gijsenij@akzonobel.com, Pim.Koeckhoven@akzonobel.com

<sup>2</sup> AkzoNobel Color Technology; Wexham Road, SL2 5DS Berkshire, Slough, United Kingdom; Peter.Spiers@akzonobel.com

<sup>3</sup> School of Design, University of Leeds, Leeds LS2 9T, United Kingdom; s.westland@leeds.ac.uk

\* Corresponding author: arjan.gijsenij@akzonobel.com

## Abstract

Designing a mood board is a creative first step one can take to help in exploring ideas before getting the project off the ground. The colors of a mood board represent important information about the envisioned designs. In this article, we will focus on *digital* mood boards and we will describe methods to extract a representative color palette from a digital mood board (image). We propose the iterative dE-means algorithm, which includes a fixed initialization to overcome the non-deterministic nature of traditional k-means, and a merging step to ensure all colors in the calculated palette are at least a dE-threshold apart. Results show that the proposed algorithm outperforms existing methods when comparing the calculated color palettes to human-extracted color themes.

**Keywords:** Color palettes, color design, mood board images, color theme, clustering

## INTRODUCTION

In interior design, a mood board is a creative tool that enables the designer in exploring ideas before getting the project off the ground. The colors of a mood board represent important information about the envisioned (interior) designs. Although traditionally mood boards are created from foam board and decorated with various physical objects such as stickers, tape, art, photographs, magazine cutouts and fabrics, in this article we will focus on *digital* mood boards in the form of collages of pictures and colored patches. In order to effectively make use of a digital mood board, we need to extract representative colors from an image, which can be a challenging task for beginners and experts alike.

A color palette of an image, sometimes also called a color theme or color scheme, is a set of colors that characterizes the image in some way or the other. In this article, we focus on color palettes that capture the most representative colors of an image from a design perspective, according to human assessments. We will first describe related work to extract color palettes from images, and after that we will describe our proposed method. Finally, we will evaluate the proposed method and compare the results to various other (state-of-the-art) methods on three different data sets.

## RELATED WORK

Several tools exist online to extract color palettes (or “themes”) from one image, e.g., Adobe Color<sup>1</sup>, Canva<sup>2</sup> or ColourLovers<sup>3</sup>. Most of these tools, however, are not transparent about *how* colors are extracted, often only a fixed, limited number of colors are extracted, and sometimes they require manual interaction. In literature, various types of algorithms to extract a color palette from an image are described; the simplest type is based on color histograms, e.g., Morse et al. (2007). Such methods typically search for dominant colors in the image by looking at the distribution of pixels across color space through 3D color histograms. Slightly more complex methods are clustering-based methods,

---

<sup>1</sup> <https://color.adobe.com/create/image> (Accessed March 22<sup>nd</sup> 2021)

<sup>2</sup> <https://www.canva.com/colors/color-palette-generator/> (Accessed March 22<sup>nd</sup> 2021)

<sup>3</sup> <https://www.colourlovers.com/photocopa> (Accessed March 22<sup>nd</sup> 2021)

such as k-means, e.g., Weeks and Hague (1997), and mean-shift, e.g., Cheng (1995). Even more complex methods include supervised learning-based methods, such as Lin and Hanrahan (2013).

In a recent overview by Ciocca et al. (2019), **the k-means method**, despite its simplicity and drawbacks, was found to perform surprisingly effective in extracting representative color palettes from images. This algorithm works by first selecting  $k$  random colors from the image, denoted the *initial centroids*, then assigning all pixels in the image to its closest centroid to form clusters, and finally re-calculating the centroids by averaging all pixels in each cluster. These steps are repeated until convergence, i.e., until new centroids are not significantly different from the old centroids anymore.

One of the known drawbacks of the k-means algorithm is that the outcome is highly sensitive to the selection of the initial centroids. Indeed, different initial cluster centers could, in theory and in practice, result in completely different clustering results. Since the initialization is typically done using some form of randomness, the outcome of the algorithm is non-deterministic, i.e., multiple runs with the same input image can result in varying color palettes. Fixing the initialization will solve this issue, but we are then left with a subsequent challenge of determining *how* to fix the initialization. Ciocca et al. (2019) proposed to sample the initial centroids uniformly on a line running from the darkest to the brightest pixel. Unfortunately, this solution did not result in more representative color palettes, intuitively caused by the fact that the initial centroids are all shades of grey, so the colors of the final palette will be slightly biased towards neutral.

## **METHOD**

In this article, we propose a new algorithm to calculate color palettes, called **dE-means**. The proposed algorithm deviates from the k-means clustering algorithm in two important aspects. First, the initialization is fixed in a pre-defined pattern to avoid the initialization problem of the k-means algorithm. Contrary to the method of Ciocca et al. (2019), who propose uniformly sampling  $k$  grey points on a line running from bright to dark, we propose to sample points in all major chromatic directions to cover a wide range of chromaticities which includes the chromatic extremes of the RGB-space. Second, we introduce a merging step in the clustering algorithm to ensure that the calculated colors are at least a pre-defined dE-threshold apart.

The first contribution of our proposed method is a fixed initialization, irrespective of the contents of the image. By using this initialization, we consider a wide initial gamut that ensures all colors in the image are represented in the initial centroids. If a centroid ends up without any associated pixels (“empty clusters”), we delete the respective centroid from further consideration. The second contribution of our proposed method is a merging step in the algorithm: In each iteration, we calculate the color difference between all centroids (only centroids with associated pixels are considered), and we remove one of the centroids if two centroids are closer than  $dE$  color difference apart, where  $dE$  is the input parameter of the proposed dE-means algorithm. In this article, we decided to remove the least chromatic centroid, but any other criterion could be used to determine which centroid should be removed, e.g., the (least) brightest centroid or the centroid which the lowest (/highest) number of associated pixels.

Our proposed dE-means algorithm will not result in a predefined number of clusters. The exact number of colors in the final palette will be dependent on the input image and on the parameter  $dE$ . As an extension, we also introduce an iterative version, called **iterative dE-means**, which allows us to calculate color palettes with a pre-defined number of colors. It works by iteratively adapting the value for  $dE$  until we end up with a color palette with the desired number of colors. Starting with an initial value for  $dE$ , we can increase the number of colors by decreasing the value for  $dE$ . Likewise, we can

decrease the number of colors by increasing the value for  $dE$ . Hence, iteratively adjusting  $dE$  to increase or decrease the number of colors accordingly will eventually (typically less than 10 iterations) result in a color palette with the desired number of colors.

## EXPERIMENTS

To evaluate the performance of the proposed method, we perform three experiment: We quantitatively compare methods using two different test data sets, and we qualitatively show how the proposed method performs on a series of digital mood boards. In this section, we will first describe the data sets we used, then go into detail about the evaluation methods and finally show and discuss the results of the experiments.

### Data sets

We use three different data sets to evaluate the performance of the proposed method. The first data set was presented by Lin and Hanrahan (2013) and was created by selecting 20 paintings (of different artistic styles) and 20 photographs (of different categories). We follow the procedure by Ciocca et al. (2019) by using the test-set for our evaluation. This test-set consists of 10 images (5 paintings and 5 photographs), which are shown to art-students who hand-picked color themes for each image, consisting of 5 colors that best represent that image. For each image, an *oracle* was determined by calculating the average color palette that has the lowest distance to the human-extracted color themes.

The second set that we use for our evaluation was created by Yang et al. (2019) by asking 30 different students with design background to each select 5 key colors per image for 30 different landscape images. To obtain a ground truth, we use a similar approach as Lin and Hanrahan (2013), by calculating an average palette that has the lowest average distance to the observers. In this case, we obtain the oracle by clustering all 150 responses per image (30 observers each selected 5 colors) with simple k-means to obtain 5 colors per image; k-means is repeated 20 times and the result with the lowest distance to the observers is maintained as the final oracle.

The third set we use consists of four digital mood boards, created by putting together a series of images and color patches with an overarching theme, e.g., living rooms or bedrooms. For this set we don't have a ground truth available; these mood board images will be used for qualitative comparison between the k-means and the proposed iterative dE-means algorithm.

### Evaluation

To compare color palettes, Ciocca et al. (2019) employ the earth mover's distance (EMD) applied to the CIELAB-values of the calculated color palettes. A different method to compare color palettes was proposed by Pan and Westland (2018), where they introduced a metric based on the minimum color difference model using dE-CIELAB color difference. Later work by Yang et al. (2020) improved this color palette difference metric by using the dE2000 instead of the dE-CIELAB color difference equation. In this article, we will evaluate the color palettes both using the EMD and the palette difference methods ( $dP_{ab}$  and  $dP_{00}$  for the palette difference metric using dE-CIELAB and dE2000, respectively).

### Quantitative results

In Table 1, we show results of the five different methods: Random, Regression, Adobe Color, k-means, and iterative dE-means. The *Random* method is added as baseline-method, and the reported results are the average over 40 different randomly selected palettes. The *Regression* method, i.e., the method proposed by Lin and Hanrahan (2013), was trained on a superset of Data set 1 but with a

different ground truth (the online-based ground truth instead of one based on the art-students); the trained method is then used to test both Data set 1 and Data set 2. Results of both the Random and the Regression method are obtained using the software made available by Lin and Hanrahan (2013)<sup>4</sup>. The results of *Adobe Color* are obtained by uploading each test image and copying the calculated palette RGB-codes for further evaluation of its performance. Adobe Color allows calculation of color palettes with five different “moods”: Colorful, Bright, Muted, Deep and Dark, and we show the results of the best-performing mood (Deep and Muted, for Data set 1 and 2, respectively). The results of the *k-means* method are averaged over 10 different runs. Finally, it should be noted that the proposed *iterative dE-means* required at most 7 iterations to end up with 5-color color palettes, i.e., starting with a high value for  $dE$  (25), we had to adjust the value for  $dE$  at most 7 times (on average, 3.9 iterations for Data set 1 and 4.2 iterations for Data set 2). Hence, the complexity of this method is comparable to the *k-means* algorithm.

Method	Data set 1, Lin and Hanrahan (2013)			Data set 2, Yang et al. (2019)		
	EMD	$dP_{ab}$	$dP_{00}$	EMD	$dP_{ab}$	$dP_{00}$
Random <sup>4</sup>	26.6 (37.2)	21.5 (29.6)	14.0 (16.7)	27.7 (38.9)	21.7 (30.8)	14.6 (17.9)
Regression <sup>4</sup>	<b>17.6 (25.0)</b>	16.0 (23.4)	10.9 (16.7)	20.9 (39.5)	16.0 (25.6)	10.9 (17.1)
Adobe Color <sup>5</sup>	22.6 (30.4)	17.1 ( <b>22.5</b> )	11.4 (15.6)	22.6 ( <b>36.2</b> )	15.6 ( <b>24.1</b> )	10.5 (15.9)
k-means	20.8 (29.9)	16.8 (22.8)	10.9 (15.1)	22.0 (44.0)	14.8 (30.1)	9.7 (16.0)
<b>Iterative dE-means</b>	18.2 (28.2)	<b>15.9 (23.3)</b>	<b>10.3 (14.5)</b>	<b>18.9 (38.4)</b>	<b>13.7 (25.1)</b>	<b>9.2 (14.1)</b>

Table 1: Performance metrics of the various methods on two data sets. The values reported are average values, and between brackets the maximum values over all images are shown (10 images for Data set 1, 30 images for Data set 2). The EMD is the earth movers’ distance, the  $dP_{ab}$  is the palette difference method based on  $dE$ -CIELAB and the  $dP_{00}$  is the palette difference method based on  $dE2000$ . Values in bold indicate the best performances per data set and per performance metric.

Overall, we can see that the proposed iterative  $dE$ -means algorithm performs on par with or better than all other methods. On Data set 1, the average palette difference  $dP_{ab}$  and  $dP_{00}$  are the lowest of all methods, only the average EMD of the Regression method is slightly lower. On Data set 2, the proposed method outperforms all other methods in terms of average EMD,  $dP_{ab}$  and  $dP_{00}$ . The regression method has the lowest EMD on Data set 1, but performs slightly worse on Data set 2 (relative to other methods). This can largely be explained by the training phase of this method; as noted, it was trained on a superset of Data set 1 but with a different ground truth.

The palettes calculated by the Adobe Color-tool differ slightly depending on which “mood” is used. For Data set 1, the best performing setting is the “Deep”-mood, with an average  $dP_{00}$  of 11.4. The other settings resulted in average  $dP_{00}$  of 11.4, 13.1, 11.6 and 14.0 for the Colorful, Bright, Muted and Dark moods, respectively. For Data set 2, the best performing mood is “Muted”: The average  $dP_{00}$  of the various settings are 10.8, 10.5, 10.5, 11.8 and 14.9 for Colorful, Bright, Muted, Deep and Dark, respectively. Arguably, the “Colorful”-mood results in the most stable performance *overall*.

Finally, since the output of the *k-means* algorithm is dependent on the (random) initialization, we calculated and show in Table 1 the average performance over 10 different runs. For Data set 1, the average EMD varies between 19.4 – 22.4, the average  $dP_{ab}$  varies between 16.3 – 17.1 and the average

<sup>4</sup> Results are obtained using the software provided by Lin and Hanrahan (2013) via <http://vis.stanford.edu/papers/color-themes>.

<sup>5</sup> <https://color.adobe.com/create/image> (Accessed March 22<sup>nd</sup> 2021), we show the performance of the best-performing setting (“Deep” and “Muted”, respectively for Data set 1 and 2).

$dP_{00}$  varies between 10.6 – 11.1. For Data set 2, we see slightly lower variations, i.e. the EMD varies between 21.4 – 22.6, the  $dP_{ab}$  between 14.5 – 15.1 and the  $dP_{00}$  varies between 9.6 – 9.9.



Figure 1: Four digital mood boards and color palettes of varying size (5 colors, 9 and 16) that are calculated using either the proposed iterative dE-means (top row per image) or the k-means algorithm (bottom row per image).

### Qualitative results

The final experiment is performed using four digital mood boards and has a more qualitative nature. In Figure 1 we show color palettes of varying sizes, with 5 colors, 9 colors and 16 colors, calculated using the proposed iterative dE-means and the k-means algorithm. It should be noted that the palettes of the k-means algorithm, due to its non-deterministic nature, were selected out of 10 runs per image by picking the color palette that on average has the closest resembles to all other palettes.

Overall, we can see that the palettes of the proposed method are more chromatic and slightly darker, and arguably better represent the mood board images in terms of representative colors. The k-means palettes are quite neutral, especially noticeable in the 5-color palettes but also the 9-color and 16-color palettes are less chromatic than the proposed method. For instance, the first mood board



image is represented by 5 greys in the k-means palette (the RMS Chroma of these 5 colors is 7.3), while the colors in the palette of the proposed method are more oriented towards the orange of the mood board (the RMS Chroma is 28.4). Similarly, for the second mood board image, we can see that the yellow tones are already picked up by the proposed method in the 5-color palette, with an RMS chroma of 25.4 (compared to 6.3 for the k-means). For the k-means palettes, some yellow tones are picked up when increasing the number of colors, but even for 16-colors palettes the difference in Chroma is considerable (a RMS of 31.5 for the proposed method versus 18.3 for the k-means algorithm).

It should be noted, though, that more chromatic palettes are not always *better*. For instance, considering the 16-color palette of the fourth mood board, which contains one dark red color. This color can be attributed to the dark red decoration on the table in the center right of the mood board, and partially contributes to the RMS chroma of 25.7 for the 16-color palette versus only 13.3 for the 16-color k-means palette, but this red color is arguably not a representative color for this image. Hence, a high chroma should not be a goal in itself.

## CONCLUSIONS

In this article we described a novel method to extract representative color palettes from (digital mood board) images. The method, denoted dE-means, is inspired by the well-known k-means algorithm but deviates in two important aspects: First, the initialization is fixed in a pre-defined pattern to avoid the initialization problem of the k-means algorithm. This prevents the calculated color palettes to vary when the same input is used to calculate color palettes multiple times, which is one of the known drawbacks of the k-means algorithm due to its random initialization. Second, the proposed method includes a merging step to ensure that the calculated colors are at least a pre-defined dE-threshold apart. The color palettes that are calculated by this proposed method are deterministic, typically more chromatic than the k-means algorithm, and more representative for the corresponding images than existing state-of-the-art methods when comparing the palettes to human-extracted color palettes from the same images.

## REFERENCES

- Cheng, Y. 1995. Mean shift, mode seeking, and clustering. *IEEE Transactions on Pattern Analysis and Machine Intelligence* 17(8): 790-799.
- Ciocca, G., P. Napoletano, and R. Schettini. 2019. Evaluation of Automatic Image Color Theme Extraction Methods. In: *Computational Color Imaging (CCIW 2019)*. Lecture Notes in Computer Science, vol. 11418, Springer, Cham, 165-179.
- Lin, S., and P. Hanrahan. 2013. Modeling How People Extract Color Themes from Images. In: *Proceedings of the SIGCHI Conference on Human Factors in Computing Systems*, ACM, p. 3101-3110.
- Morse, B. S., D. Thornton, Q. Xia, and J. Uibel. 2007. Image-Based Color Schemes. In: *IEEE International Conference on Image Processing*, IEEE, III-497-III-500.
- Pan, Q., and S. Westland. 2018. Comparative Evaluation of Color Differences between Color Palettes. In: *Color Imaging Conference*, IS&T, 110-115.
- Weeks, A., and Hague, G. 1997. Color segmentation in the HSI color space using the k-means algorithm. In: *Proceedings of the SPIE 3026 – Nonlinear Image Processing VIII*, 143-154.
- Yang, J., S. Westland, and K. Xiao. 2019. Deriving Colour Palettes from Images of Natural Landscapes. In: *Proceedings of the AIC Midterm Meeting Color and Landscape*, 351-356.
- Yang, J., Y. Chen, S. Westland, and K. Xiao. 2020. Predicting visual similarity between colour palettes. *Color Research and Application* 45(3): 401-408.

# Impact of the training data in IIS optimization for faithful scene-specific color correction of RAW images

Emilie Robert<sup>1,\*</sup>, Magali Estribeau<sup>1</sup>, Rémi Barbier<sup>1</sup>, Gregory Swiathy<sup>2</sup>, Justin Plantier<sup>3</sup> and Pierre Magnan<sup>1</sup>

<sup>1</sup> Institut Supérieur de l'Aéronautique et de l'Espace, Toulouse, France ; pierre.magnan@isae.fr

<sup>2</sup> DGA-TA, Balma, France ; gregory.swiathy@intra.def.gouv.fr

<sup>3</sup> IRBA, Brétigny sur Orge, France ; justin.plantier@intra.def.fr

\* Corresponding author: emilie.robert@isae-superaero.fr

## Abstract

This paper compares two different methods for computation of a Color Correction Matrix (CCM) through Linear Least Square Optimization (LLSO). The first method uses a Macbeth ColorChecker<sup>®</sup> comprising 24 patches whereas the second uses the ISO/CIE 11664-3 standard for X, Y and Z computation. The last is done through un-resolved reflectance data such as available from calibrated multispectral images. Results highlight that the general method can be restricted to the use of 12 patches with no drastic impact on the overall color correction confirming the results in Akkaynak et al. (2014) and Alsam and Finlayson (2008). Moreover, it has been shown that the ISO/CIE 11664-3 standard based method can be preferred to the general method to enable scene specific CCM optimization using a single calibrated multispectral image. This method is therefore particularly interesting for scientific applications which include visible multispectral systems in addition to the context DIS.

**Keywords:** color image reconstruction pipeline, color correction matrix, raw images

## INTRODUCTION

In the reconstruction pipeline of raw images, color correction stage aims to transform the image's colors from the device-dependent RGB color space to a device-independent XYZ color space based on Human Visual System (HVS). The HVS and the Digital Imaging System (DIS) colors perceptions differ one from another due to the difference between the Color Matching Functions (CMFs) and the spectral responses of the considered DIS pixels. This is mainly due to practical reasons (Gaurav 2017) and leads to non-compliance with the Maxwell Ives Luther criterion. For many computer vision applications, the color transformation is essential to optimize the color perception as well as the interpretation of the images.

The motivation of this work is based on applications such as surveillance, spatial imaging (Maki et al. 2020), or under-water imaging (Akkaynak et al. 2014) for which the scenes present colors from a restricted part of the visible spectrum: hues of green for military camouflage in a forest, hues of orange on Martian soil, or hues of blue under water with natural light... Such scenes result either from the incident illuminant which constraints the perception of the objects colors (under-water), either because the objects actually present reflectances arising as minor variations of a single hue (camouflage), or a mix of both last cases (Mars).

The study investigates the efficiency of color transformations computed through Linear Least Square Optimization (LLSO) using two different methodologies: (i) the general method imaging the MacBeth Color Checker<sup>®</sup> and (ii) the proposed method which computes X,Y,Z values through un-resolved reflectance data such as available from calibrated multispectral images. The first part of this paper describes the two different methods resulting in the computation of the Color Correction Matrix (CCM). Results and comparison of these methods are discussed in a second section.

## EXPERIMENTAL DETAILS

### Image acquisition

The raw images used for this study are obtained with a custom CMOS Image Sensor (CIS) designed at ISAE-SUPAERO on standard imaging technology (180nm). It is composed of 512x512, 7 $\mu$ m-pitch pixels mounted with a Bayer Color Filter Array (CFA) and micro lenses. The imaging system is composed of: the CIS, an imaging lens, and an IR-cut filter at 750nm. The considered scene is a Macbeth ColorChecker<sup>®</sup> Classic placed inside a lightSTUDIO<sup>®</sup> from Image Engineering which delivers a D65 illuminant.

### General method for color correction of raw images: Macbeth ColorChecker<sup>®</sup>

The general method for computing the color transformation (CT) required in the Image Reconstruction Pipeline (IRP) of raw color images is considered as the reference method for our study. This method consists in computing and applying a Color Correction Matrix (CCM) allowing to minimize the gap between X,Y,Z values supplied with the ColorChecker<sup>®</sup> datasheet and R,G,B values defining colors as sensed by the DSI. R,G,B correspond respectively to the raw responses of the pixels covered by the red, green and blue filters and subsequently demosaicked in order to obtain three coordinates on each pixel. The CT stage is expressed as follow:

$$\mathbf{T} = \mathbf{WB} \cdot \mathbf{CCM} \cdot (\mathbf{S} - \mathbf{off}) \quad (1)$$

with

$$\mathbf{S} = \begin{bmatrix} R_1 & \cdots & R_n \\ G_1 & \ddots & G_n \\ B_1 & \cdots & B_n \end{bmatrix} \text{ and } \mathbf{T} = \begin{bmatrix} X_1 & \cdots & X_n \\ Y_1 & \ddots & Y_n \\ Z_1 & \cdots & Z_n \end{bmatrix}$$

Matrices are expressed in bold characters. WB corresponds to the 3x3 White Balance diagonal matrix, CCM is the 3x3 Color Correction Matrix and off, the 1x3 offset vector composed of the values to withdraw from each color plane of the image. S and T are 3xn matrices with n equal to the number of color patches used for the Linear Least Squared Optimization (LLSO). The Macbeth ColorChecker<sup>®</sup> when fully used induces n=24. Equation (1) is resolved through an LLSO following the method used in Mornet (2011:117). The efficiency of this method is estimated through the  $\Delta E_{2000}$  color errors remaining, for each of the twenty-four colors patches, between the colors as seen by the CIE XYZ 1931 standard observer and the colors of the corrected image.

### Proposed approach: Use of reflectances as available from calibrated multispectral images

The paper proposes to compare the general Macbeth ColorChecker<sup>®</sup>-based method to the method using the ISO/CIE 11664-3 standard. This standard describes how to compute the X,Y,Z values of reflective stimuli as seen by an observer from its CMFs  $\bar{x}(\lambda)$ ,  $\bar{y}(\lambda)$  and  $\bar{z}(\lambda)$ , the spectral reflectance factors  $R(\lambda)$  of the stimulus, and the illuminant relative spectral power distribution  $I(\lambda)$ . The equation is as follow, with k a normalizing constant:

$$\begin{bmatrix} X \\ Y \\ Z \end{bmatrix} = k \cdot \int_{400nm}^{780nm} R(\lambda) \cdot I(\lambda) \cdot \begin{bmatrix} \bar{x}(\lambda) \\ \bar{y}(\lambda) \\ \bar{z}(\lambda) \end{bmatrix} d\lambda \quad (2)$$

$$k = \frac{100}{\int_{400nm}^{780nm} I(\lambda) \cdot \bar{y}(\lambda) d\lambda} \quad (3)$$

Contrary to the general method which fills T with fixed values given in the MacBeth ColorChecker<sup>®</sup> datasheet, this method uses the computation of the n triplets of the T matrix. Therefore, the general method limits the length n of this matrix to the number of patches of the

Impact of the training data used in IIs optimization for faithful scene-specific color correction of RAW images color chart used but also to standard CMFs and standard illuminants. Using ISO/CIE 11664-3 method for calculating the values of the T matrix gives the major opportunity to adapt the n triplets to the scene and to consider different illuminants and/or individual CMFs.

The proposed approach uses the spectral reflectance factors  $R(\lambda)$  with 50nm-resolution in the full visible spectral range. The hypothesis conducting this paper is that if the X, Y and Z computation is not too altered by the low resolution, then a calibrated multispectral image could be used for in-situ characterization of the scene in order to perform scene-specific color correction. Each pixels of the calibrated multispectral image gives a spectral reflectance factor, therefore the benefit of this method lies in the fact that T and S are filled with color information specific to the scene to be imaged. This also has the advantage of convenience and speed since it uses only a multispectral acquisition of the scene instead of the usual point-by-point characterization of the scene when in situ color calibration is undertaken (Akkaynak et al. 2014). In this paper the multispectral RedFish dataset from Clouet, et al. (2020) is used, and a linear interpolation is made on the reflectance data from the multispectral image in order to process equation (2).

### **Data processing**

For both methods, the numerical processes are performed on MATLAB (LLSO and image processing). Raw images acquired for the experiments are first de-mosaicked through *demosaic* MATLAB function following (Malvar et al. 2004) linear interpolation method. Then the WB matrix, the CCM matrix and the off vector are computed and applied.

## **RESULTS AND DISCUSSION**

Figures fig.1, fig.2(b) and fig.3 show the  $\Delta E_{2000}$  error per patch and fig.2(a) shows the global error averaged over all 24 patches of the Macbeth ColorChecker®. In addition the results are compared to the rule of thumb giving the limits of 3  $\Delta E_{ab}$  units (green line) and 6  $\Delta E_{ab}$  units (orange line) considered in Hardeberg (2004:22) respectively as the limits for “hardly perceptible” and “not acceptable” color differences.

### **General method for color correction of raw images: Macbeth ColorChecker®**

Figure 1(a) illustrates the color errors between X,Y,Z values from Macbeth ColorChecker® datasheet and R,G,B the raw values of the used Digital Imaging System (DIS) pixels. The averaged color error over all 24 patches of the Macbeth ColorChecker® is 17.03  $\Delta E_{2000}$  units which highlights how necessary is the Color Transformation (CT) step in the image reconstruction pipeline of raw images. Using the general method for CT allows the initial color error to be reduced from 17.03  $\Delta E_{2000}$  to 3.82  $\Delta E_{2000}$  with all values except for brown and black patches, under the limit of 6. This value is consistent with other works presented in the color correction literature (Hubel et al. 1997; Vazquez-Corral, Connah, et Bertalmío 2014).

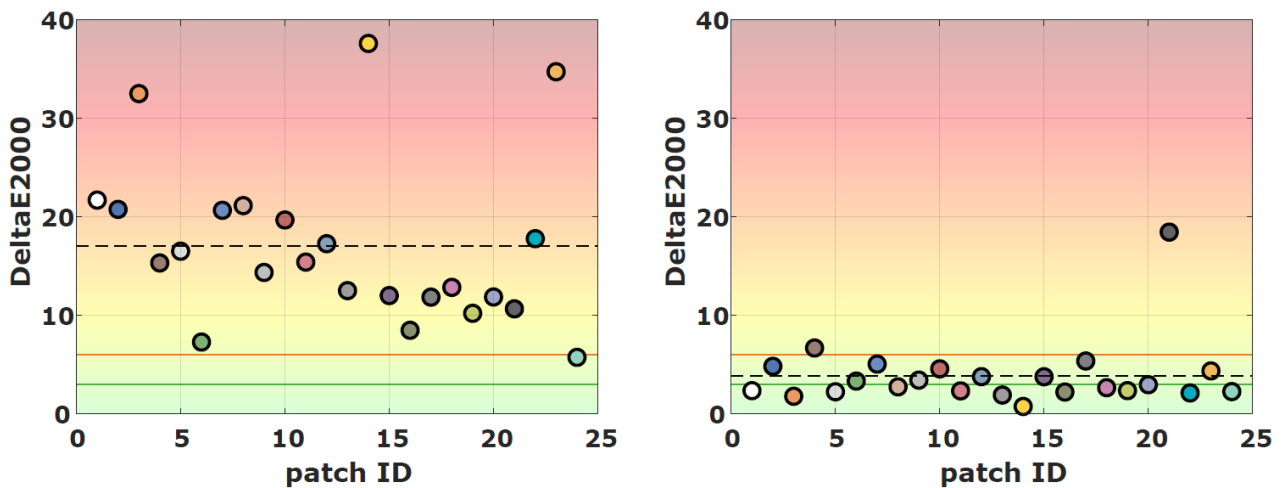

Figure 1: (a)  $\Delta E_{2000}$  color error between X,Y,Z values from Macbeth ColorChecker<sup>®</sup> datasheet and R,G,B the raw values of the used digital imaging system pixels. The error averaged over all 24 colors is 17.03  $\Delta E_{2000}$  units (black dashed line), well above 3  $\Delta E_{2000}$  units (green line) and 6  $\Delta E_{2000}$  units (orange line) considered in Hardeberg (2004:22) respectively as the limits for “hardly perceptible” and “not acceptable” color errors. (b) After the correction optimized according to the general method, the global error averaged over all 24 colors is 3.82  $\Delta E_{2000}$  units (black dashed line).

Figure 2(a) shows that the general method can be restricted to the use of 12 patches, whatever the filling order of T. Although  $24! = 6.2045 \times 10^{23}$  orders exist with the Macbeth ColorChecker<sup>®</sup>, here, only 50 different orders are studied (black dashed lines). Akkaynak et al. (2014) and Alsam et Finlayson (2008) showed such a restriction to 13 patches. A reduction of the color chart is often necessary in scientific missions where the payloads are limited such as spatial applications. Hence, the last Martian rovers color camera calibration targets are equipped with 6 patches: green, yellow, blue, red, white and light grey (Kinch et al. 2020). Figure 2(b) shows how efficient is a color correction computed on those 6 patches. The global color error is 4.56  $\Delta E_{2000}$  units also with the darkest hues near the limit of 6.

#### Proposed approach: Use of reflectances as available from calibrated multispectral images

Figure 3(a) shows the  $\Delta E_{2000}$  color errors between X,Y,Z from the Macbeth ColorChecker<sup>®</sup> datasheet and X,Y,Z values computed through the approach presented in this paper. As observed, the global difference is 3.25  $\Delta E_{2000}$  units and is critical ( $> 6$ ) only for the yellow patch. X,Y,Z computed through equation (2) with  $R(\lambda)$  unresolved, and X,Y,Z from the Macbeth ColorChecker<sup>®</sup> datasheet are equivalent. This suggests that this approach may be preferred to the general method, giving the major advantage to enable scene-specific CCM optimization. This method is particularly interesting for scientific applications which already involve visible multispectral systems in addition to their context DIS. Moreover, this method is better adapted for these applications in comparison to the other scene-specific methods requiring a complete spectral characterization of the scene (measure point by point of the different spectral data of the scene). Figure 3(b) verifies that the colors on the corrected image through the proposed approach are improved (4.45  $\Delta E_{2000}$  units) and presents similar results to the general method (3.82  $\Delta E_{2000}$  units).

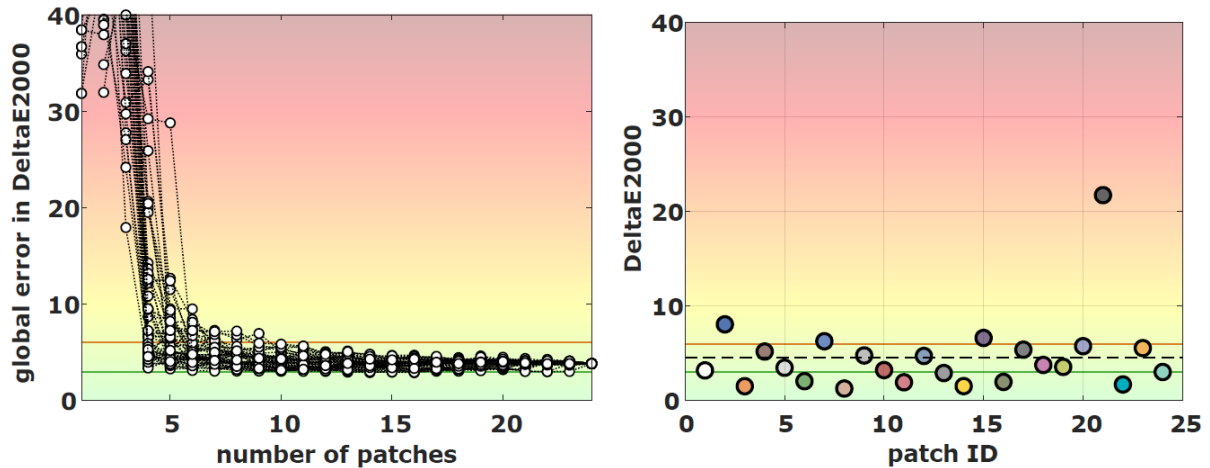

Figure 2: (a) The global  $\Delta E_{2000}$  error averaged over the ColorChecker® 24 patches decreases with  $n$  increasing, and stabilizes from  $n=12$  whatever the order of selection of the patches to fill  $T$ . Each black dashed line is a different order of filling of  $T$ . (b)  $\Delta E_{2000}$  color errors between X,Y,Z values from the ColorChecker® datasheet and the color-corrected R,G,B raw values of the used DIS pixels. For  $n=6$  (red, blue, yellow, green, white and light grey Macbeth ColorChecker® patches), after the correction optimized according to the general method, the global error (black dashed line) is  $4.56 \Delta E_{2000}$  units.

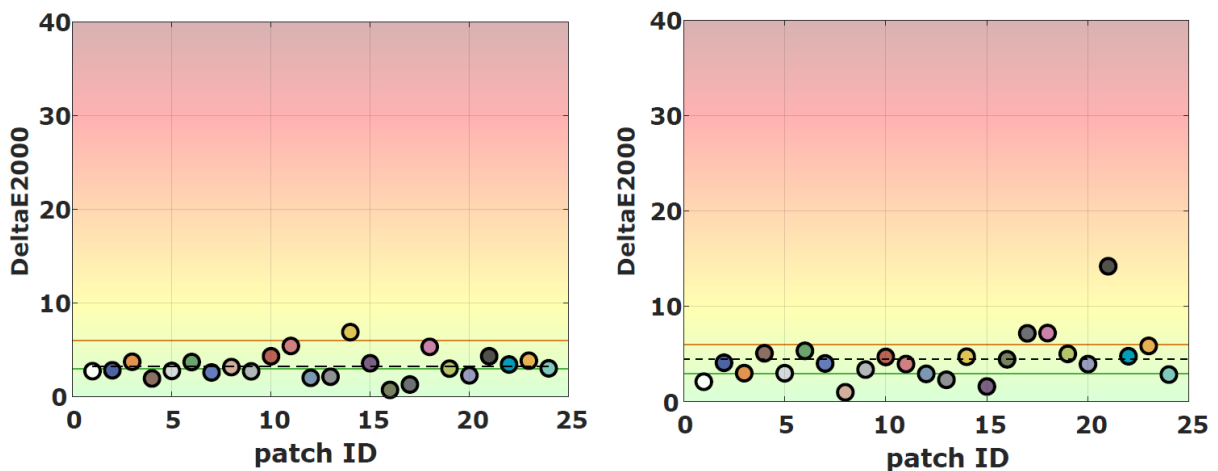

Figure 3: (a)  $\Delta E_{2000}$  color errors between X,Y,Z values from Macbeth ColorChecker® datasheet and X,Y,Z values computed through unresolved reflectance data. The global error (black dashed line) is  $3.25 \Delta E_{2000}$  units. (b) After the correction optimized according to the approach presented in this paper, the global error (black dashed line) is  $4.45 \Delta E_{2000}$  units.

## CONCLUSION

This paper compares the general method (color charts) to the proposed approach using unresolved reflectance data from a single calibrated multispectral image to compute the CCM. It shows first that the number of patches used for the LLSO computing the color correction through the general method may be reduced to any 12 patches. However if a reduced 6 patches - red, green, blue, yellow, white, grey - optimization is made, the global and particular color errors are equivalent to the  $n=24$  general method. Finally, it shows that the proposed approach is globally and particularly equivalent to the general method which suggests its utilization in order to improve fidelity of the “colorimetric color reproduction” pipeline (Hunt, 1970) of specific scenes. This method is particularly

Impact of the training data used in IIS optimization for faithful scene-specific color correction of RAW images interesting for scientific applications which include visible multispectral systems in addition to their context DIS enabling scene specific CCM optimization using a single calibrated multispectral image.

## REFERENCES

- Akkaynak, D., T. Treibitz, B. Xiao, U. A. Gürkan, J. J. Allen, U. Demirci, and R. T. Hanlon. 2014. Use of Commercial Off-the-Shelf Digital Cameras for Scientific Data Acquisition and Scene-Specific Color Calibration. *JOSA A* 31 (2): 312-21.
- Alsam, A., and G. Finlayson. 2008. Integer Programming for Optimal Reduction of Calibration Targets. *Color Research & Application* 33 (3): 212-20.
- Clouet, A., C. Viola, and J. Vaillant. 2020. Visible to Near-Infrared Multispectral Images Dataset for Image Sensors Design. *Electronic Imaging 2020* (5): 106-1-106-7.
- Gaurav, S., éd. 2017. *Digital Color Imaging Handbook*. Boca Raton: CRC Press.
- Hardeberg, J. 2004. Acquisition and Reproduction d'images Couleur: Approches Colorimétrique and Multispectrale, 253.
- Hubel, P. M., J. Holm, HP Laboratories, Hewlett-Packard Company, G.D. Finlayson, and M. S. Drew. 1997. Matrix Calculations for Digital Photography. *The Fifth Color Imaging Conference: Color Science, Systems, and Applications*, 7.
- Hunt, R. W. G. 1970. Objectives in Colour Reproduction. *The Journal of Photographic Science* 18 (6): 205-15.
- Kinch, K. M., M. B. Madsen, J. F. Bell, J. N. Maki, Z. J. Bailey, A. G. Hayes, O. B. Jensen, M. Merusi, M. H. Bernt, and A. N. Sørensen. 2020. Radiometric Calibration Targets for the Mastcam-Z Camera on the Mars 2020 Rover Mission. *Space Science Reviews* 216 (8): 1-51.
- Maki, J. N., M. Golombek, W. Banerdt, S. Smrekar, R. Deen, H. Abarca, S. Lu, and J. Hall. 2020. Color Properties at the Mars InSight Landing Site. *Earth and Space Science*
- Malvar, H.S., Li-wei He, and R. Cutler. 2004. High-quality linear interpolation for demosaicing of Bayer-patterned color images. In *2004 IEEE International Conference on Acoustics, Speech, and Signal Processing*, 3:iii-485-88.
- Mornet, C. 2011. Reconstruction couleur sous faible éclairnement pour des capteurs d'images en technologie CMOS. Phdthesis, Université de Grenoble.
- Vazquez-Corral, J., D. Connah, and M. Bertalmío. 2014. Perceptual Color Characterization of Cameras. *Sensors* 14 (12): 23205-29.

# Fastness of black dye-based ink-jet printing inks in aqueous solution in the presence and absence of oxygen

Barbara Blaznik <sup>1</sup>, Franci Kovač <sup>2</sup>, Grega Bizjak <sup>3</sup> and Sabina Bračko <sup>1,\*</sup>

<sup>1</sup> University of Ljubljana, Faculty of Natural Sciences and Engineering; barbara.blaznik@ntf.uni-lj.si, sabina.bracko@ntf.uni-lj.si

<sup>2</sup> University of Ljubljana, Faculty of Chemistry and Chemical Technology; franci.kovac@gmail.com

<sup>3</sup> University of Ljubljana, Faculty of Electrical Engineering; grega.bizjak@fe.uni-lj.si

\* Corresponding author: sabina.bracko@ntf.uni-lj.si

## Abstract

Photodegradation of the ink-jet prints is a complex process in which many external and internal factors are involved. Internal factors such as the presence of optical brighteners in the paper, ink as a complex mixture of colorants and various accompanying substances are often overlooked.

The aim of our research work was the determination of fastness of water-based black ink-jet inks in aqueous solutions as black prints are considered to be more long-lasting. However, to achieve a perfect black colour and a suitable fastness of the print, a water-based printing ink often contains a complex mixture of colourants. We investigated the stability of the ink under the influence of UVC light in the presence of oxygen as well as in an inert environment.

According to the results, black inks consist of several colourants that differ in colour as well as in polarity. The results of the spectrophotometric analysis have shown that the presence of oxygen has an extremely negative effect on the stability of black inks.

**Keywords:** dyes, fastness, aqueous solutions, presence of oxygen, UVC

## INTRODUCTION

Due to many advantages, the importance of ink-jet printing technology significantly increased over the last decades. However, the quality and durability of the print should be ensured.

The print quality is determined by colour range, sharpness of the image and ultimately, the durability of the print. Therefore, the quality of prints depends on the penetration of ink into the paper and the binding of ink to the paper surface. Moreover, the quality of prints is primarily related to the properties of the ink and the paper as well as their interactions (Kandi 2013; Vikman 2004; Vogt 2001). In terms of print identification and analysis, prints produced by an ink-jet printer represent an almost infinite number of combinations (Jürgens 1999), as the durability of prints is influenced by several interrelated internal and external factors (Bugner 2002; Menart et al. 2011; Wypych 2008).

In terms of recommendations for preserving and archiving documents, it is necessary to evaluate the impact of specific external factors. In this way, it is easier to ensure appropriate storage and preservation conditions (Vikman 2004). Despite extensive researches on the light fastness of materials, the process of photodegradation is still not fully understood (Blaznik et al. 2013; Černič 2008: 299; Giles 1965; Zollinger 2003). Photodegradation is induced by absorption of the ultraviolet and visible parts of the spectrum. Moreover, the degradation mechanism is also determined by other factors (temperature, humidity, chemical structure of the printing material and ink, and many others) (Blaznik et al. 2013; Cristea and Vilarem 2006; Feller 1994; Herbst and Hunger 2004; Mecklenburg and Hoyo-Meléndez 2012; Provost and Lavery 2009). The presence of oxygen is also one of the fundamental factors in the degradation of organic materials. It leads to the formation of peroxides, which, under the influence of heat and light, form free radicals that cause an inevitable chain reaction of accelerating degradation (Feller 1994).

Ink-jet printing inks can be described as dilute solutions containing one or more colourants. The primary function of the printing ink is to transfer the colourant to the printing material. Therefore, ink-



The fastness of an aqueous solution of black ink-jet ink in the presence and absence of oxygen jet printing inks are composed of several components; such as colourant, deionised water and/or organic solvents, dispersants, buffers, anti-foaming agents, biocides and binders); each with its own specific function (Jürgens 1999; Sharama et al. 2014; Vnek et al. 2002).

The aim of our study was a systematic analysis of two commercial dye-based black ink-jet inks in the aqueous solution. The aqueous solutions of black dyes were exposed to UV radiation in the presence and absence of oxygen. Moreover, we carried out some fundamental analyses to determine the presence of different dyes in the black inks. Based on the measurements, we calculated the ink amount and half-life of the black inks in a water solution.

## EXPERIMENTS

For the experimental part, we have chosen two ink-jet printers (Canon Pixma iP7250 (T1) and Epson L130 (T2)). Both printers use water-based ink-jet inks. First printer (T1) uses four primary colour cartridges with dye-based ink and the second one (T2) uses five cartridges with four primary colour and the fifth black cartridge with pigment-based ink.

Solutions of black dye-based inks in water and methanol in ratio 1:3000 were prepared.

For irradiation of water solutions of ink, we have used a high-pressure mercury lamp. The irradiation ( $E_e$ ) of the lamp was previously measured between 180 and 1100 nm. Assuming that the lamp radiates evenly in all directions, we calculated the radiant intensity ( $I_e = 1.36 \text{ W/sr}$ ) and the total radiant flux ( $\Phi_e = 20.43 \text{ W}$ ). A particular reactor was used, which enables the water cooling of the lamp between operation. The reactor was made of two parts: the first part was a water cooling refrigerator with a reactor, and the second part was a high-pressure mercury lamp (Figure 1). That approach enabled to maintain the samples' temperature between 16 and 20 °C, which were only 2 cm away from the lamp.

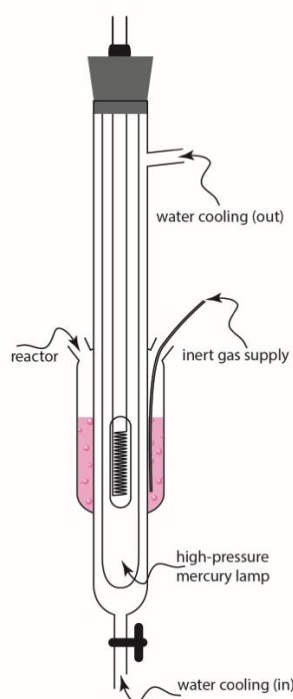

Figure 1: Scheme of reactor during operation of the high-pressure mercury lamp.

The fastness of an aqueous solution of black ink-jet ink in the presence and absence of oxygen

30 ml of dye solution was poured into the reactor and exposed for 15 minutes to the radiation of the lamp. Two repetitions in the presence of oxygen or inert gas (Ar) were performed.

After irradiation, the transmission measurements in the range between 220 in 900 nm irradiation were performed. UV/VIS spectrophotometer Cary 1E (Varian, USA) was used. TLC chromatography was performed with the silica-coated aluminium plates (Sigma-Aldrich, DE) as a stationary phase and a solution of ethyl acetate, ethanol and water (70:35:30) as a mobile phase. The retention factor (Rf) was calculated. We have also monitored the kinetics of photodegradation after 5, 10 and 15 minutes of irradiation, and based on measurements, the ink amount (IA) after 15 minutes of irradiation was calculated according to equation 1,

$$IA [\%] = \frac{A_i}{A_0} \times 100 \% \quad [1]$$

where IA is the calculated ink amount,  $A_i$  represents the absorption value after and  $A_0$  represents the absorption value before irradiation.

## RESULTS AND DISCUSSION

Figure 2 shows TLC analysis of black colour inks before (STD) and after 15 minutes of irradiation in an inert (Ar) and oxygen-enriched ( $O_2$ ) environment. It can be concluded that black dye-based inks are combined from at least three coloured components. Separation of those colour components was seldomly successful. In chromatogram after 15 minutes of irradiation, it can not be observed any difference. Except for sample T2 in an oxygen-enriched environment, it can be observed that one colour component is missing. However, with TLC analysis, it can be concluded that black dye-based ink-jet printing inks are a mixture of yellow, blue, violet, and black dye. According to the literature (Blease and Weinstein 2008, Rengaswamy et al. 2008) it is very likely that those dyes are a mixture of C.I. RB31 and C.I. DB168 combined with direct yellow dye C.I. DY86 or C.I. DY132. Consequently, by mixing different dyes, manufacturers can achieve the appropriate hue, and the addition of black pigment and cyan dye is often used to improve the colourfastness of prints (Blease and Weinstein 2008).

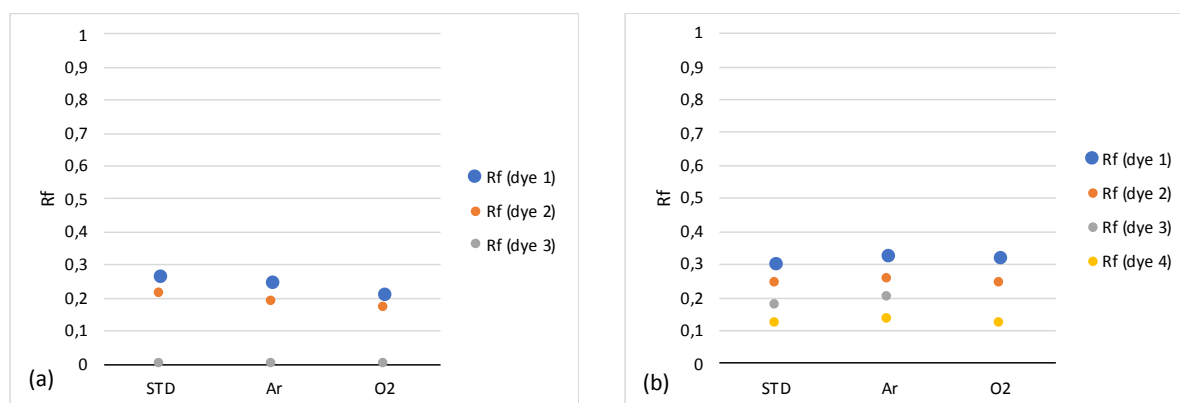

Figure 2: TLC analysis of black colour inks (a) T1 and (b) T2 before (STD) and after 15 minutes of radiation in an inert (Ar) and oxygen-enriched ( $O_2$ ) environment.

Figure 3 shows the absorption spectra of black dye-based ink-jet printing inks in aqueous solution (T1 and T2). Under the influence of irradiation with a high-pressure mercury lamp, we observe

The fastness of an aqueous solution of black ink-jet ink in the presence and absence of oxygen significant influence of oxygen (O<sub>2</sub>) on both black samples, as colour change, which is primarily manifested in the visible part of the spectrum. In addition (Figure 3b), we also notice a shift in the absorption maximum in the direction of shorter wavelengths. The negative effect of oxygen is most notable for the T2 sample, as the intensity of the absorption spectrum decreases by 24% in 15 minutes. The absorption maximum of this sample (T2) has a noticeable shift towards short-wavelengths (from 567 to 546 nm).

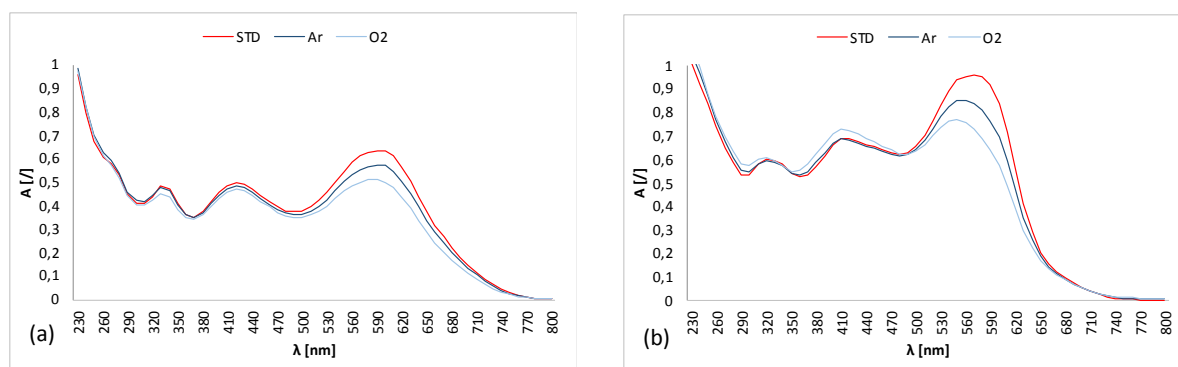

Figure 3: Absorption spectra of black colour inks (a) T1 and (b) T2 before (STD) and after 15 minutes of radiation in an inert (Ar) and oxygen-enriched (O<sub>2</sub>) environment.

The negative effect of oxygen on the aqueous solutions of black ink-jet inks is also reflected in the calculated IA values (Table 1), which are significantly lower compared to the IA values of samples irradiated to 15-minute with mercury lamp in an inert atmosphere.

		IA [%]
<b>T1</b>	<b>Ar</b>	90
	<b>O<sub>2</sub></b>	80
<b>T2</b>	<b>Ar</b>	87
	<b>O<sub>2</sub></b>	76

Table 1: Ink amount (IA) for aqueous solution of black colour inks T1 and T2 after 15 minutes of radiation in an inert (Ar) and oxygen-enriched (O<sub>2</sub>) environment.

According to the results the reaction of photodegradation very likely follows the pseudo-first-order kinetic model for best fit. Figure 4 shows the parameters which can describe the rate of degradation of the black samples (T1 and T2) under the influence of a high-pressure mercury lamp in an inert atmosphere and in an atmosphere enriched with oxygen. From the slope (k) of the line, the degradation rate and half-life ( $t_{1/2}$ ) can be determined (Table2). Thus, we can conclude that the presence of oxygen largely influences the stability of colour solutions and that the inert atmosphere prolongs the durability of ink.

### The fastness of an aqueous solution of black ink-jet ink in the presence and absence of oxygen

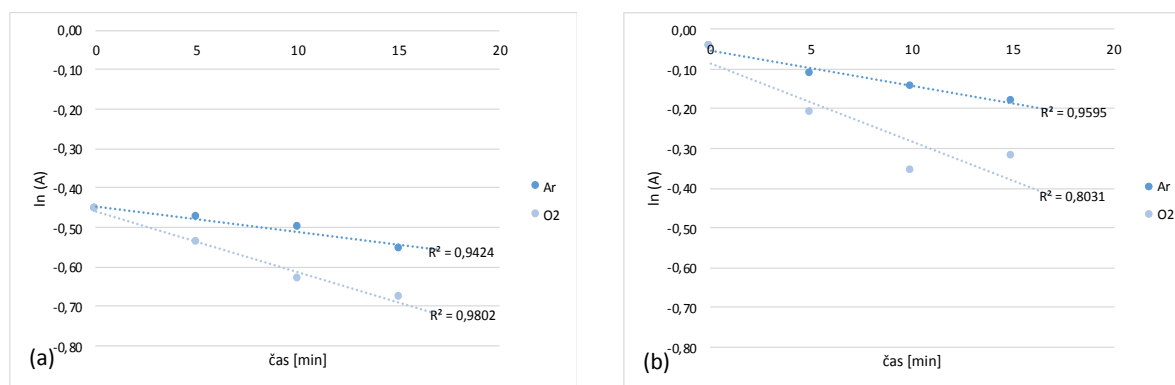

Figure 4: Rate of degradation of the black samples T1 (a) and T2 (b) under the influence of a high-pressure mercury lamp in an inert (Ar) and oxygen-enriched (O<sub>2</sub>) environment.

		$k [s^{-1}]$	$t_{1/2} [min]$
<b>T1</b>	<b>Ar</b>	-0.0067	103
	<b>O<sub>2</sub></b>	-0.0153	45
<b>T2</b>	<b>Ar</b>	-0.0089	78
	<b>O<sub>2</sub></b>	-0.0196	35

Table 2: Coefficient ( $k$ ) of and half-life ( $t_{1/2}$ ) for the black samples T1 and T2 under the influence of a high-pressure mercury lamp in an inert (Ar) and oxygen-enriched (O<sub>2</sub>) environment.

## CONCLUSION

With these relatively simple analytical methods, the fastness of printing inks and the influence of external factors on solutions of printing ink can be determined. From the obtained results, we found that black ink-jet printing inks consist of several different colourants. The UV-C radiation has negative effects on the stability of the ink in an aqueous solution especially in the presence of oxygen. With a relatively high probability, we can determine the degree of photodegradation and the half-life of the ink in an aqueous solution.

## REFERENCES

- Blaznik, B., K. Možina, and S. Bračko. 2013. Stability of ink-jet prints under influence of light. *Nordic pulp & paper research journal* 28(1): 111-118.
- Blease, J. W., and L. K. Weinstein. 2008. *Ink jet ink set* (Patent No. US7056373B2).
- Bugner, D. E. 2002. Papers and films for ink jet printing. In: *Handbook of imaging materials*. Second Edition. New York: Marcel Dekker, Inc. 603–627.
- Čerňič, M. 2008. Permanence and durability of paper for documents and publications: Doctoral dissertation. University of Ljubljana.
- Cristea, D., and G. Vilarem. 2006. Improving light fastness of natural dyes on cotton yarn. *Dyes and pigments* 70: 238-245.
- Feller, R. L. 1994. *Accelerated aging: photochemical and thermal aspects*. Los Angeles: Getty Conservation Institute.

- Giles, C. H. 1965. The fading of colouring matters. *Journal of applied chemistry* 15(12): 541-550.
- Herbst, W., and K. Hunger. 2004. *Industrial organic pigments : production, properties, applications*. 3rd ed. Weinheim: Wiley-VCH 87-98.
- Jürgens, M. C. 1999. *Preservation of ink jet hardcopies*. Rochester: Capstone Project, Cross-Disciplinary Studies, Rochester Institute of Technology.
- Kandi, S. G. 2013. The effect of paper appearance on printed color of inkjet printer. *Color research and application* 38(4): 284-291.
- Mecklenburg, M. F. and Del Hoyo-Meléndez, J. M. 2021. Development and application of a mathematical model to explain fading rate inconsistencies observed in light-sensitive materials. *Coloration technology* 128: 139-146.
- Menart, E., G. De Bruin, and M. Strlič. 2011. Dose–response functions for historic paper. *Polymer degradation and stability* 96: 2029-2039.
- Provost, J., and A. Lavery. 2009. *Interactions of digital inks with textile and paper substrates in ink jet printing*. Provost ink jet consulting Ltd.
- Rengaswamy, S., Z. U. Rehman, and M. E. Austin. 2008. *Dye-based black ink formulations and ink-jet ink sets* (Patent No. US20080257206A1).
- Sharama, N., A. Agarwal, Y. S. Negi, and H. J. Bhardwaj. 2014. History and chemistry of ink – A review. *World journal of pharmaceutical research* 3(4): 2096-2105.
- Vikman, K. 2004. *Studies on fastness properties of ink jet prints on coated papers*. Helsinki: Helsinki university of technology.
- Vogt, B. 2001. *Stability issues and test methods for ink jet materials*. Cologne, University of applied science, Department of image engineering.
- Wnek, W. J., M. A. Andreottola, P. F. Doll, and S. M. Kelly. 2002. Ink jet ink technology. In: *Handbook of imaging materials, Second Edition*. Edited by A.S. Diamond, D. S. Weiss. New York: Marcel Dekker, Inc. 531-602.
- Wypych, G. 2008. *Handbook of material weathering, 4th ed*. Toronto: ChemTec Publishing.
- Zollinger, H. 2003. *Color Chemistry: Syntheses, properties and applications of organic dyes and pigments*. 3rd ed. Weinheim: Verlag Helvetica Chimica Acta.

# Improving image registration using colour transfer methods in remote sensing applications

Brandon Hobley <sup>1,\*</sup>, Graham Finlayson <sup>1</sup>, Michal Mackiewicz <sup>1</sup>, Julie Bremner <sup>2,3</sup>, Tony Dolphin <sup>2,3</sup> and Riccardo Arosio <sup>2,3</sup>

<sup>1</sup> School of Computing Sciences, University of East Anglia, Norwich NR4 7TJ; m.mackiewicz@uea.ac.uk; g.finlayson@uea.ac.uk;

<sup>2</sup> Collaborative Centre for Sustainable Use of the Seas, School of Environmental Sciences, University of East Anglia, Norwich NR4 7TJ, UK; julie.bremner@cefas.co.uk; tony.dolphin@cefas.co.uk; riccardo.arosio@cefas.co.uk

<sup>3</sup> Centre for Environment, Fisheries and Aquaculture Science, Pakefield Road, Lowestoft NR33 0HT, UK; julie.bremner@cefas.co.uk; tony.dolphin@cefas.co.uk; riccardo.arosio@cefas.co.uk

\* Corresponding author: b.hobley@uea.ac.uk

## Abstract

Image registration is described as aligning several images into a common image coordinate system. For remote sensing, registration is often a key pre-processing step as aerial imagery can be captured by multiple sensors at different spatial and spectral resolutions. A common approach for registering images from different cameras involves using bilinear interpolation to upsample a lower resolution image and computing robust features to find corresponding points in pairs of images. These correspondences provide the basis to compute geometrical linear transforms that align both images together. However, the main drawback to these methods are that colour information in images is ignored and the multimodal nature of this process can cause sub-par linear transforms to be computed. In this work, we show that multimodal aspect can be circumvented entirely using the Linear Monge-Kantorovitch colour transform and that the subsequent registration is improved.

**Keywords:** *Colour Transfer, Linear Monge-Kantorovitch, Image Registration, Remote Sensing*

## INTRODUCTION

Remote sensing and coastal monitoring are rapidly evolving fields that often require multiple cameras during data acquisition of aerial imagery. Advances in both software and hardware can deliver successful applications of supervised segmentation algorithms (Hobley et al. 2021) in order to map and quantify the spatial distribution of features pertinent to the site being remotely sensed. Part of the advances in hardware include regular use of multiple cameras to survey sites, and as such image registration has been a common task for pre-processing photographed aerial imagery from multiple sources. Multispectral sensors are often characterized as having high spectral resolution and narrow spectral bandwidth while also having larger Instantaneous Field of View (IFoV) than commercially available cameras with lower spectral resolution and higher spatial resolution. This poses a challenge as images captured by multispectral cameras require equal spatial resolution to panchromatic images in order to be in co-registration.

A standard approach to automatic registration is to upsample the multispectral image to match the resolution of the corresponding high-resolution image using interpolation; find correspondences in pairs of images and compute an optimal geometric transformation based on matching correspondences (Bown and Lowe 2003). However, errors in registration distort images by blurring the edges of objects and affect any subsequent fusion methods (Ghassemian 2016), with errors being caused either by a subpar transformation model or distortions due to interpolation.

Subpar transformation models can be caused by the underlying covariance shift in colour responses from multiple cameras. Therefore, to circumvent this, each image can be modelled as a continuous probability density function (pdf) with each pixel value as a realization of a colour random variable.

The goal then is to transfer statistical moments between resulting pdfs using the linear Monge-Kantorovitch (MK) solution (Olkin and Pukelsheim 1982), which can be used to map the colours from the high-resolution reference image to match those in a multispectral target image. As a result, the covariance of the transformed image and the target are the same and, simultaneously, the shift in colours is minimized. The MK method has already been shown to be effective in media production applications (Pitié and Kokaram 2007).

This method will be evaluated using two Very High-Resolution cameras (VHR) that were used to monitor Budle Bay; a wide bay extending approximately 2 km<sup>2</sup> on the North Sea in Northumberland, England. These cameras include a wide-band commercial camera (SONY ILCE-6000) which captured images at a 3cm sampling distance and a narrow-band multispectral camera (MicaSense RedEdge3) with an 8cm sampling distance. In Figure 1, the reference image from the SONY camera and the multispectral corresponding capture using the MicaSense camera are displayed respectively in images (C) and (D). Using the MK transform we map the reference image to the target, with the MK-transformed (B) image looking like the target, even though it is not registered.

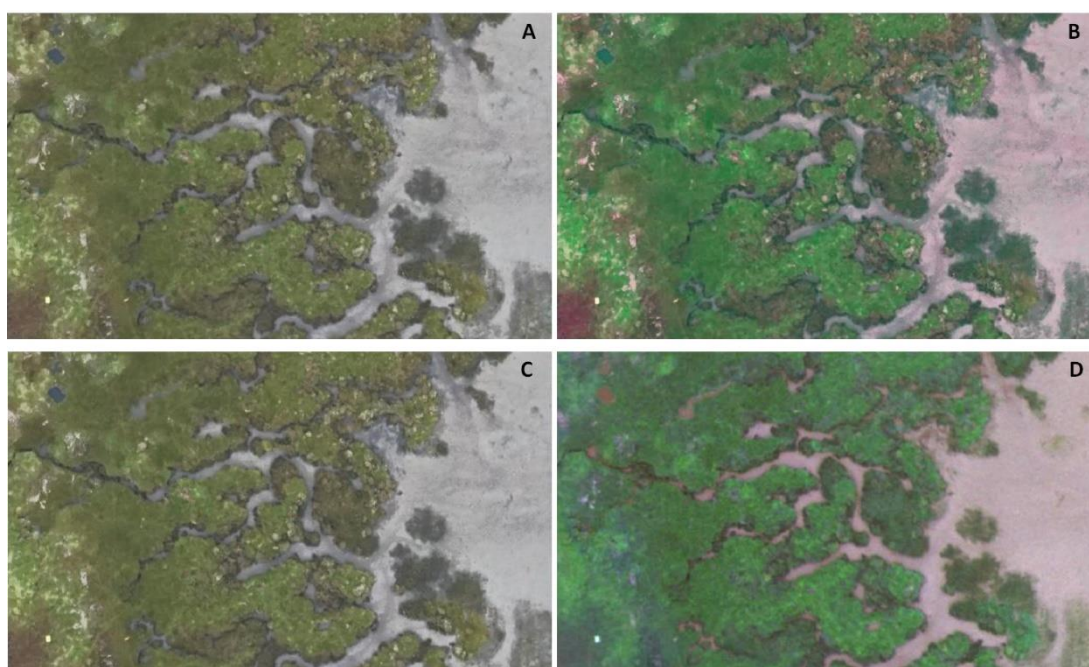

Figure 1: **A** and **C** are the same reference image with corresponding target image (**D**) and the application of the linear MK transform (**B**) mapping the colours in the reference image (**A**) to match those within the target image (**D**).

By minimizing the shift in colour responses resulting from multiple cameras we show that the subsequent registration process is improved. A brief background in colour transfer and registration methods is presented in section 2; section 3 describes the linear MK transform applied to images and section 4 details the results of our experiments.

## **BACKGROUND**

### **Image registration**

Literature describes many different registration methods that can be applied to remote sensing. A review of image registration methods can be found in Zitová and Flusser (2003). For this work, we



consider the pipeline based on (Brown and Lowe 2003): initially, images of corresponding captures with respect to the real-world are brought to the same spatial resolution by interpolating pixel values in the multispectral image. For each image pair, SIFT (Lowe 2004) features are extracted. SIFT features describe local features within an image that are invariant to translation, rotation and scaling, and partially invariant to changes in illumination, and therefore are a suitable candidate for finding correspondences in image pairs. Given several matching points, the parameters for an affine transform are found in a linear least squares sense, and finally each transform is scored and accepted/rejected using RANSAC (Derpanis 2010). The best scoring transform warps pixels from both images into a common coordinate system.

### Colour transfer

In Figure 1, we show the goal of applying a linear transform based on the colour statistics of the reference and target images. This linear mapping is achieved by representing each image as a set of RGB colour samples, where in a probabilistic sense, each colour sample is a realization of a 3-dimensional colour variable. The distributions of colour samples for each image are denoted as  $\mathbf{u}$  and  $\mathbf{v}$ , with the assumption that both distributions have a continuous probability density function (pdf)  $\mathbf{f}$  and  $\mathbf{g}$ , respectively for reference and target images. The goal then is to find a continuous mapping  $\mathbf{u} \rightarrow \mathbf{t}(\mathbf{u})$ , such that the new colour distribution  $\mathbf{t}(\mathbf{u})$  matches the target distribution  $\mathbf{g}$  (Pitié and Kokaram 2007). Figure 2 illustrates this problem, also known as the mass preserving transport problem, to which the goal of the MK-transform is to find the minimal displacement mapping.

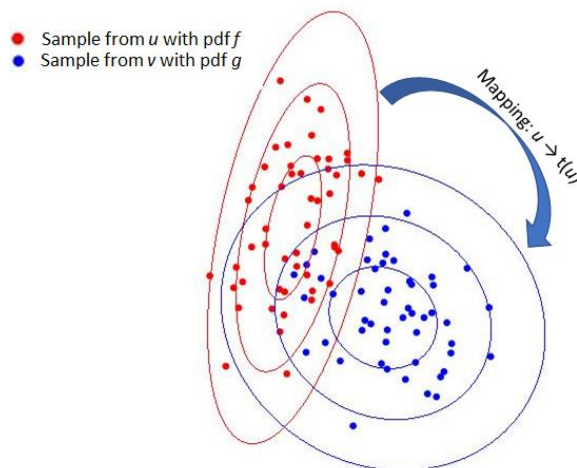

Figure 2: An example illustrating the mapping of multivariate gaussian distributions for colour distributions  $\mathbf{u}$  and  $\mathbf{v}$ .

### Method

In Pitié and Kokaram (2007) the goal is to transfer the statistical moments of two images represented as pdfs such that the displacement caused by a continuous mapping function is minimal. In the general case in mathematics this is known as Monge's optimal transportation problem (Evans 1997).

Consider two images to be registered,  $X \in \mathbb{R}^{H_1 \times W_1 \times 3}$  and  $Y \in \mathbb{R}^{H_2 \times W_2 \times 3}$ , respectively as a reference and a target image, where  $(H_1, W_1)$  and  $(H_2, W_2)$  are the height and width respectively for the reference and target images. Before computing the linear MK-transform the brightness of  $X$  is matched with  $Y$  by converting both images to CIELAB colour space and histogram matching the lightness channel before converting both images back to the RGB colour space. Then, each image band is flattened and concatenated column-wise so that each row represents an R, G and B colour sample.



The covariance matrices  $\Sigma_X$  and  $\Sigma_Y$  are computed, respectively from  $X$  and  $Y$ , with Equation 1 detailing the linear MK transform. In colour grading, the MK solution is desirable for two reasons: firstly, the solution always exists for continuous pdfs and is unique, meaning that there is no room left for ambiguity; secondly, the solution uses the gradient of a convex function that is the equivalent of monotonicity for one dimensional functions in  $\mathbb{R}$ . This implies that the brightest areas of a picture remain the brightest areas after mapping.

$$T = \Sigma_X^{-1/2} \left( \Sigma_X^{1/2} \Sigma_Y \Sigma_X^{1/2} \right)^{1/2} \Sigma_X^{-1/2} \quad (1)$$

Given the MK-transformed image, two pairs of images are used to compute geometrical linear transforms, as per (Brown and Lowe 2003). The first pair is the high-resolution original reference image with the low-resolution multispectral image (Figure 1, (C) and (D)), and the second pair is the high-resolution MK-transformed with the low-resolution multispectral image (Figure 1, (B) and (D)). Each image-pair will result in a linear geometrical transform that warp pixel values from the target image to the same image coordinate system as the reference image.

## Results

Our method was evaluated on two very high resolution orthomosaics of Budle Bay. The sensors used to survey the site were – a SONY ILCE-6000 camera with 3 wide band filters for Red, Green and Blue channels and a ground sampling distance of approximately 3 cm and a MicaSense RedEdge3 camera with 3 narrow band filters for Red (655–680 nms), Green (540–580 nms) and Blue (459–490 nms) channels and a ground sampling distance of approximately 8 cm.

Each orthomosaic was orthorectified using ground markers that were spread out across the site. This process ensures that both mosaics are well aligned with respect to each other, and with ecological features present within the coastal site. For this work, ground control markers will be used to mark control points in images in order to evaluate the pixel location accuracy in registration. Table 1 reports the mean Euclidean distance between control points for pairs of images after registration, as well as the number of SIFT matches and percentage of inlier matches after RANSAC.

	# SIFT matches	% inlier SIFT matches	Euclidean distance
<b>MK-transform/Target</b>	630 ( $\pm$ 798)	77.15% ( $\pm$ 17.4 %)	<b>1.2 (<math>\pm</math> 0.86)</b>
<b>Original/Target</b>	725 ( $\pm$ 940)	78.85% ( $\pm$ 14.7 %)	1.86 ( $\pm$ 1.27)

Table 1: Mean ( $\pm$  standard deviation) of the number of SIFT matches, percentage of inlier SIFT matches and Euclidean distance between control points in pairs of registered images.

The results in Table 1 show that using MK-transform high-resolution image to compute a geometrical linear transform improves on registration pixel accuracy. The mean Euclidean distance between control points in pairs of registered images is lower for images pre-processed using the MK colour transfer than for images using the original reference image. This tells us that distortions caused by errors in registration, e.g. blur, will be more noticeable for registered images where the reference image is not pre-processed using the MK-transform. Furthermore, the number of features matches, and the percentage of inlier matches after RANSAC are on average greater between pairs of original reference and target images than with reference images pre-processed with MK-transform, although the percentage of inlier matches does not differ greatly. Figure 3 shows the results of registration for

pairs of images, where each fused image is converted to grey scale. The left image is the registration result where the linear MK transform is used to map the colours from the target image to the reference image and the right image is the registration result using the original reference image. Figure 3 subtly confirms the results we could see in Table 1 - the left image is sharper around the edges of vegetation and soil as opposed to the right image.

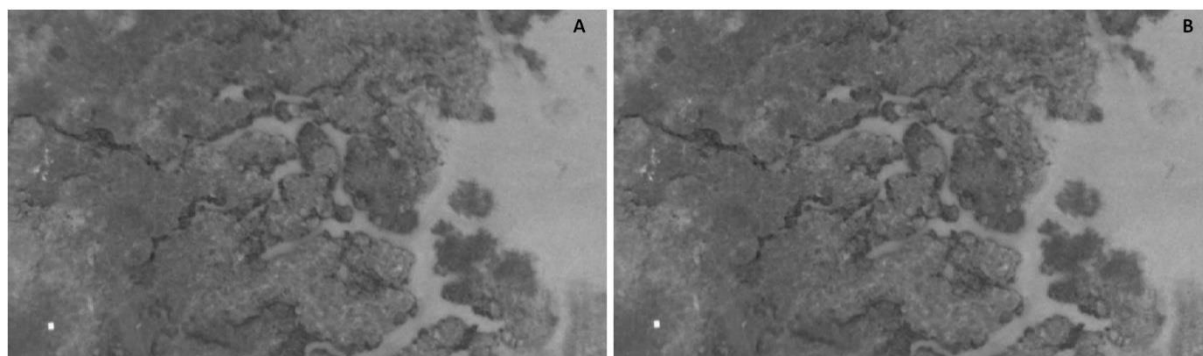

Figure 3: Registered images from both cameras after conversion to grey scale. **A** - pre-processed with the MK colour transfer and **B** – registered using the original reference.

## **CONCLUSIONS**

Image registration is a key-processing step in remote sensing applications that can be performed in various manners, with more complex methods existing in literature (Zitová and Flusser 2003). However, the method used and described in Brown and Lowe (2003), where corresponding SIFT features in images are used to compute a linear transform is a common approach for automatic registration. In this work we have shown that using a simple colour transfer (Pitié and Kokaram 2007) pre-registration reduces subsequent image registration errors.

## **ACKNOWLEDGEMENTS**

The authors are grateful for funding from the Natural Environmental Research Council and from Cefas through the iCASE grant NE/R007888/1.

## **REFERENCES**

- Brown, M., and D. G. Lowe. 2003. Recognising panoramas. *ICCV* 3: 1218.
- Derpanis, K. G. 2010. Overview of the RANSAC algorithm. *Image Rochester NY* 4(1): 2-3.
- Ghassemian, H. 2016. A review of remote sensing image fusion. *Information Fusion* 32: 75-89.
- Hobley, B., R. Arosio, G. French, J. Bremner, T. Dolphin, and M. Mackiewicz. 2021. Semi-supervised segmentation for coastal monitoring seagrass using RPA imagery. *Remote Sensing* 13(9): 1741.
- Lowe, D. G. 2004. Distinctive image features from scale-invariant keypoints. *International Journal of Computer Vision* 60(2): 91-110.
- Olkin, I. and F. Pukelsheim. 1982. The distance between two random vectors with given dispersion matrices. *Linear Algebra and its Applications* 48: 257-263.
- Pitié, F. and A. Kokaram. 2007. The linear Monge-Kantorovich colour mapping for example-based colour transfer. *European Conference on Visual Media Production* 27: 1-9.
- Zitová, B. and J. Flusser. 2003. Image registration methods: a survey. *Image and Vision Computing* 21(11): 977-1000.



# Color Constancy in virtual reality scenes. A first step toward a color appearance model in virtual reality

Pedro J. Pardo <sup>1,\*</sup>, Francisco Diaz-Barrancas <sup>1</sup> and Halina Cwierz <sup>1</sup>

<sup>1</sup> University of Extremadura; Centro Universitario de Mérida, Spain; pjpardo@unex.es, frdiaz@unex.es, hccwierz@unex.es

\* Corresponding author: pjpardo@unex.es

## Abstract

Due to the increase in the use of virtual reality systems, the requirement for quality in it has also increased. The most important factor may be the quality of the visual appearance of the scenes shown in it. One of the aspects that affects the visual appearance, among other things, is the color constancy or the ability of an object to be perceived with the same color under different types of illuminant. This means that even if the illuminant varies, the user can perceive the same color. In this paper we will prospectively discuss whether chromatic adaptation and color constancy should be considered different for a virtual reality device comparing with a 2D image shown in a display and comparing with real life. It could be a great first step toward establishing a color appearance model that can be applicable to devices in virtual scenarios.

**Keywords:** *Virtual reality, Head-mounted Display, Color constancy, Color Appearance*

## INTRODUCTION

Classic colorimetry allows us to specify the color of a simple visual stimulus, using only three mathematical values. This is a huge dimensional reduction, from the infinite dimensions of the power spectral distribution of a physical stimulus to the tridimensional definition of a visual stimulus. This transformation is based on the trivariance of the human visual system. The validity of these tristimulus values is conditioned by its obtention conditions (luminance level, size of stimulus, surrounding field, adaptation degree) and by the validity of certain mathematical properties required for a Euclidean vectorial space (additivity, linearity, etc.). A detailed description of how color matching functions were obtained can be found at Wyszecki and Stiles (1967). However, the need of measure and represent mathematically a color in different branches of science, engineering and industry, has led to the recent development of fields such as color differences measurement (García et al. 2007; Oleari et al. 2009), applied colorimetry (Johnston 2009, Weatherall & Coombs 1992) or color management (Sharma 2018, Fraser et al. 2004) and more.

Color management in digital environments has been developing since the 1990s, sponsored by the leading companies of the computer sector (Has 1995). Color Management Systems (CMS) are based on color management modules (CMM) and the chromatic characterization of each digital device through an International Color Consortium (ICC) color profile. This system allows to obtain a reliable reproduction of the color between diverse digital media and to be able to manage it correctly. An example of usefulness of color management is color gamut mapping between different devices (Morovič 2008). In all cases, color management technics are applied to two-dimensional static images. Digital video has its own color management system based on several standards that must be followed by all video management stages (Poynton 2012).

However, the expansion and popularization of the 3D digital environments have brought new challenges in terms of color management and applied colorimetry. Previous solved problems such as, defining the RGB digital value of a light source from its power spectral distribution or computing the effect of the chromatic adaptation state of an observer when the illuminant is changed may have different solutions when we use virtual reality glasses. The mentioned change in the light source

Color Constancy in virtual reality scenes. A first step toward a color appearance model in virtual reality becomes even more critical for augmented reality because the virtual light source must match the real one in color, intensity and direction for the best experience. In this work we start a discussion if it is necessary or not to study known visual phenomenon like color adaptation and color constancy between others.

### ***REAL-TIME 3D RENDERING IMAGES FOR VIRTUAL REALITY***

There exist many differences between a digital image obtained from photographic techniques and a digital image obtained rendering of a 3D scene. In the first case, the image is captured by a sensor, typically CCD or CMOS, located at the image plane of the optical system of a photographic camera.

In the case of a digital image obtained by rendering a 3D scene, a ray tracing process is carried out based on the geometric definition of 3D objects, their position, the position of the camera and the position of the light sources (Glassner 1989). This ray tracing is done in reverse to the traditional optical systems, i.e. from the eye or camera to objects forming the scene. In this way, it is done for all rays that pass through a matrix of points that correspond to the future pixels of the final image

With the reversal in the ray tracing, it is possible to save computation time since the rays are only traced to the position in which they find an object that appears on the screen considering the location of the camera. It is made selecting objects in the scene from back to front to contemplate the possible interaction of rays bouncing off more than one opaque surface in the scene. Then, in order to handle the lighting and shading conditions, the graphic engine apply different mathematical models.

One of the most extended models of 3D rendering is the Physically-Based Rendering model (PBR) that apply a bidirectional reflectance distribution function (BRDF) as physical-law governing the interaction between light and matter (Pharr et al. 2016). The result of applying this model of rendering can be photo-realistic reproductions of real scenes.

This type of 3D rendering method enables the possibility of defining the spectral power distributions of light sources. In the same way, basic colorimetric calculations can be done and applied to the image in term of CIE 1931 XYZ tristimulus values. However, this type of 3D rendering needs long time of processing (typically hours) to produce one image. The problem arises when we need to apply these physical-law-based rendering techniques in virtual reality environments where human interaction with the environment is required in an active way, adapting the image shown to the position of the observer in a very short time.

For the immersion experience to be satisfactory in a virtual reality environment, it is necessary to generate at least 90 images per second, although the current trend is to achieve 120 images per second. In addition, it is necessary to generate two different images, one for each eye, in order to achieve the effect of stereoscopic vision. On the other hand, the response of the sensors of the virtual reality system to the movements of the head and body of the user must have a minimum latency to obtain a fluid image movement and a suitable feeling of immersion. This reduces the computation time per frame to about 10 ms or less (Pardo et al. 2018). With these restrictions it is not possible to apply a classical 3D physical-rendering method and it is necessary to apply more restrictions.

Currently, there are two main software platforms for developing virtual reality content: Unreal Engine (Epic Games Inc., USA) and Unity Game Engine (Unity Technologies, USA). In both platforms, new Graphics Processing Units (GPU) with high computing capabilities are employed to reflect in a greater or lesser extent the real world through physical laws. The geometry of the scene is supplied to the graphic card and this hardware projects the geometry and breaks it down into vertices. Then,

Color Constancy in virtual reality scenes. A first step toward a color appearance model in virtual reality the vertices are transformed and splitted into pixels, which get the final rendering treatment before they are passed to the screen using the frame buffer.

Specifically, Unity Game Engine applies inside this graphical pipeline a reduced BRDF model through the Standard Shader: a Physically Based Shading and Lighting engine based on four main components (diffuse, specular, normal, smoothness). These components are applied through bitmaps as texture files. The diffuse component corresponds to material color with a perfect Lambertian behavior following the Disney model (Burley 2018), the specular component including Smith Joint GGX visibility term (Walter et al. 2007) and Schlick Fresnel approximation (Heitz 2014), and normal and smoothness components correspond to surface texture. It is therefore possible to obtain rendered scenes with a high degree of visual appearance fidelity when treating the light-matter interaction this way. Figure 1 shows a comparison between a real and a virtual scenario employed in this work.

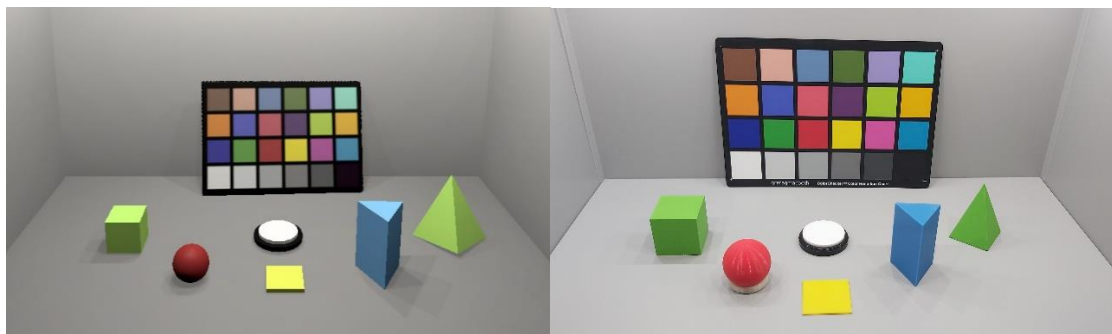

Figure 1: Synthetic image of a real scene shown in VR (left) and real image of a real scene (right).

However, the virtual reality scenes generated in this way has left out any color management technique, since color is processed from the beginning to the end in RGB values (8-bit digital values per channel). The only color correction that has been carried out is the calibration of the display setting up to a standard configuration (typically sRGB). Therefore, one of the challenges ahead for color scientists is to enable a color management system compatible with this type of Virtual Reality (VR) systems.

### ***COLOR MANAGEMENT IN VR SYSTEMS***

Several different levels of color management can be established on virtual reality devices. The first would refer to the processing of photographic images shown in VR systems in the same way that is done through Color Management Modules in a 2D environment. A second level would be to apply a color management system in VR not only to photographic images but also to the 3D objects that are part of the scene. A third possibility would be the spectral computation of both light source emission and surface reflection of 3D objects. Finally, there exists the possibility of applying color appearance models to the complete rendering of the scene. Each of these different proposals are described below.

#### **Photographic color management inside VR**

Virtual Reality environments can show all kinds of images. One type of images are photographic images. On this type of images, it is possible to apply a color correction using a Color Management System (CMS) in the same way as it is done in a two-dimensional environment, since the image is

Color Constancy in virtual reality scenes. A first step toward a color appearance model in virtual reality loaded on the scene and its RGB values do not change as long as the conditions of lighting do not change. In this way, it is only necessary to characterize chromatically the Head-Mounted Display (HMD) employed in the VR system, generating its ICC color profile. After this, it is necessary to incorporate a CMS that performs color management on that image when required by the VR system. Our research group has successfully conducted tests in this regard (Diaz-Barrancas 2018, Diaz-Barrancas et al. 2018).

### **Textured 3D Objects**

The design of scenes in 3D environments requires the use of 3D objects. These 3D objects can define their external appearance by a texture file in the form of an RGB image that corresponds to the part of diffuse color or material color in the PBR model. This type of texture files can be obtained from the capture of a real object using a 3D scanner. The light used to capture the geometry and color of the object is usually a LED 5000K light source. On the contrary, the white point that is usually employed in displays corresponds to a D65 illuminant. Therefore, the default light source used in 3D design environments with 8-bit per channel RGB digital values = (255, 255, 255) would correspond to a D65 illuminant. With this premise, for a correct color reproduction of the scanned 3D object, it is necessary to perform a transformation to the digital RGB values of the texture captured with D50 to transform them to D65. We must consider that 3D graphics engines used in virtual reality only uses RGB values, and interaction between the light source and the object is calculated in real time. In order for this color transformation of the object's texture to be manageable at runtime, this transformation must be done prior to program execution or at time of loading (Díaz-Barrancas et al. 2020a).

### **Spectral computation of light and textures**

The next step in the challenge of obtaining reliable color reproduction in virtual reality systems would be to apply spectral calculation to the entire scene in real time. This is not feasible today due to the large number of frames per second required to obtain a good feeling of immersion despite the great computing power of the nowadays GPUs. However, our research group is working to obtain a reliable reproduction of color in this type of environment by performing a spectral pre-computation of the light sources and the textures of the 3D objects. In this case it is necessary to have the hyperspectral texture of the 3D object, something that today is complex in objects with volume. In flat objects we have achieved the hyperspectral texture of the object using a hyperspectral camera and we have performed the spectral calculations of both the color of the source and the color of the texture with that source (Diaz-Barrancas et al. 2019, 2020b). It should be noted that the difficulty is to do it in such a way that the rendering of the scene corresponding to different positions of the HMD is sufficiently fluid and compatible with the PBR system based on 8-bit RGB values.

### **Color appearance models applied to rendered scenes**

Finally, and from the point of view of basic research the most important point, it remains to check whether virtual reality systems based on physical rendering models need to integrate a color appearance model that improves the appearance of rendered scenes in 3D. All these types of models such as CIECAM (CIE 2004) or iCAM (Fairchild et al. 2004; Kuang et al. 2007) include a color adaptation stage to respond to changes in lighting. They also consider, in different way, the effect of the environment and a non-linear compression stage. In the case of iCAM, it also analyzes the details of the scene using a Contrast Sensitivity Function (CSF) and performing a contrast enhancement at

Color Constancy in virtual reality scenes. A first step toward a color appearance model in virtual reality certain points coinciding with the edges of the objects. The scientific question is to know if the stereoscopic 3D scenes generated for VR systems need to use the improvements provided by color appearance models or not. Last generation HMDs have a wide Field-Of-View (FOV), between 100° - 120°, that simulates quite well the natural FOV. Considering this wide FOV, the high frequency refresh and high-definition image rendered, it is necessary to check the behavior of human visual system in such conditions. Specifically, if light level and color adaptation occurs in the same way than in natural viewing conditions. We must study whether the spatial effects collected by appearance models such as iCAM are already generated by our own visual system when using a stereoscopic image system or, conversely, improve the appearance of the image. Another question to check is the compatibility with PBR rendering with any appearance correction.

## **RESULTS AND CONCLUSIONS**

This is a prospective work, and its results can be analyzed as usual. Our research group is working in this research line and some quantitative results have been obtained related with the linearity of visual perception in HMDs (Díaz-Barrancas et al. 2021). Related with color adaptation and color constancy, preliminary qualitative results indicate that color adaptation could occur in the same way than in natural viewing conditions. In terms of Fairchild et al. (1995), there are a short-term and a long-term color adaptation effects. The short-term is close to instantaneous and the long-term depends on the light source spectrum but needs around 1 minute to be significative.

There are many scientific challenges related with VR systems that color scientists must solve in the next future. Nowadays, we are designing a new experiment that let us to measure the time and the degree of adaptation for each simulate light source. In the current times in which the global pandemic of COVID 2019 has forced large numbers of people to telework, it is more urgent to know if this evolution in visual appearance is possible.

## **ACKNOWLEDGEMENTS**

Thanks are due to Prof. João Linhares from University of Minho (Portugal) for his support. This work was supported by grants GR21148 and IB20094 of the Regional Government of the Junta de Extremadura and was partially financed by the European Regional Development Fund.

## **REFERENCES**

- Burley, B., and W. D. A. Studios. 2012. Physically-based shading at Disney. In: *ACM SIGGRAPH, 2012*, 1-7.
- CIE TC 8-01. 2004. *A Color appearance model for color management systems*. Publication 159. Vienna: CIE Central Bureau.
- Díaz-Barrancas, F. 2018a. *Estudio de la fidelidad de la reproducción cromática en dispositivos de realidad virtual* (Master's thesis). Mérida: University of Extremadura.
- Díaz-Barrancas, F., P. J. Pardo, M. I. Suero, and A. L. Pérez. 2018b. Is it possible to apply colour management technics in Virtual Reality devices? In: *Proceedings of XIV Conferenza del Colore*. Associazione Italiana del Colore: Firenze.
- Díaz-Barrancas, F., H. Cwierz, P. J. Pardo, A. L. Pérez, and M.I. Suero. 2019. Hyperspectral textures for a better colour reproduction in virtual reality. In: *Proceedings of XV Conferenza del Colore* Associazione Italiana del Colore: Macerata.



- Díaz-Barrancas, F., H.C. Cwierz, P.J. Pardo, A.L. Pérez, and M.I. Suero. 2020a. Spectral Color Management in Virtual Reality Scenes. *Sensors* 19: 5658.
- Díaz-Barrancas, F., H.C. Cwierz, P.J. Pardo, A.L. Pérez, and M.I. Suero.. 2020b. Visual fidelity improvement in virtual reality through spectral textures applied to lighting simulations. *Electronic Imaging* 15:259-1
- Díaz-Barrancas, F., H.C. Cwierz, and P.J. Pardo. 2021. A study of physical and perceived linearity in a virtual reality environment. In: *Proceedings of the International Colour Association (AIC) Conference 2021*. AIC: Milan.
- Fairchild, M. D., and L. Reniff. 1995. Time Course of Chromatic Adaptation for Color-Appearance Judgments. *Journal of the Optical Society of America A* 12: 824.
- Fairchild, M. D., and G.M. Johnson. 2004. iCAM framework for image appearance, differences, and quality. *Journal of Electronic Imaging*, 13: 126-139.
- Fraser, B., C. Murphy, and F. Bunting. 2004. *Real world color management*. United States of America: Peachpit press.
- Garcia, P. A., R. Huertas, M. Melgosa, and G. Cui. 2007. Measurement of the relationship between perceived and computed color differences. *Journal of the Optical Society of America A* 24: 1823-1829.
- Glassner, A. S. (Ed.). 1989. *An introduction to ray tracing*. Academic Press: London.
- Has, M. 1995. Color Management-Current Practice and The Adoption of a New Standard. In: *TAGA 2*: 748-771.
- Heitz, E. 2014. Understanding the masking-shadowing function in microfacet-based BRDFs. *Journal of Computer Graphics Techniques* 3: 32-91.
- Johnston, W. M. 2009. Color measurement in dentistry. *Journal of dentistry*, 37: e2-e6.
- Kuang, J., G.M. Johnson, and M.D. Fairchild. 2007. iCAM06: A refined image appearance model for HDR image rendering. *Journal of Visual Communication and Image Representation* 18: 406-414.
- Morovič, J. 2008. *Color gamut mapping*. New York: John Wiley and Sons.
- Oleari, C., M. Melgosa, and R. Huertas. 2009. Euclidean color-difference formula for small-medium color differences in log-compressed OSA-UCS space. *JOSA A*, 26(1), 121-134.
- Pardo, P. J., M.I. Suero, and A. Perez. 2018. Correlation between perception of color, shadows, and surface textures and the realism of a scene in virtual reality. *Journal of the Optical Society of America A* 35: B130-B135.
- Pharr, M., W. Jakob, and G. Humphreys. 2016. *Physically based rendering: From theory to implementation*. Burlington, Massachusetts: Morgan Kaufmann.
- Poynton, C. 2012. *Digital video and HD: Algorithms and Interfaces*. Amsterdam: Elsevier.
- Sharma, A. 2018. *Understanding color management*. New York: John Wiley and Sons.
- Walter, B., S. R. Marschner, H. Li, and K.E. Torrance. 2007. Microfacet Models for Refraction through Rough Surfaces. In: *Eurographics Symposium on Rendering*. ed. Geneva: The Eurographics Association, 1-12.
- Weatherall, I. L., and B.D. Coombs. 1992. Skin color measurements in terms of CIELAB color space values. *Journal of investigative dermatology*, 99: 468-473.
- Wyszecki, G., and W. S. Stiles. 1967. *Color science, concepts and methods, quantitative data and formulae*. New York: John Wiley and Sons.

# Band selection for different dehazing algorithms in the visible

Soledad Fernández-Calvero <sup>1</sup>, Miguel Ángel Martínez-Domingo <sup>1</sup>, Eva M. Valero <sup>1</sup>, Juan L. Nieves <sup>1</sup>, Javier Romero <sup>1</sup> and Javier Hernández-Andrés <sup>1,\*</sup>

<sup>1</sup> Color Imaging Lab, Optics Department, Faculty of Sciences, University of Granada, Granada 18071, Spain; msolfcarvelo@gmail.com, martinezm@ugr.es, valerob@ugr.es, jnieves@ugr.es, jromero@ugr.es, javierha@ugr.es

\* Corresponding author: javierha@ugr.es

## Abstract

In adverse weather conditions, images degrade (poor contrast, low visibility and color distortions), depending on distance, atmospheric particle density and wavelength. Five single-image dehazing algorithms have been analyzed on a database of hazy spectral images in the visible range, finding the three optimal wavelengths according to a new combined image quality metric. The optimal triplet of bands depends on the algorithm used and, in some cases, the different bands are quite close to each other. According to our proposed combined metric, the best method is the artificial fusion of multiple exposure images proposed by Galdran (2018), although this is not always supported by the visual appearance of the rendered images.

**Keywords:** *Dehazing, hyperspectral imaging, band selection, image quality metrics, visible range*

## INTRODUCTION

Images captured outdoors are affected by the absorption and scattering of particles in the atmosphere, which reduces the contrast and visibility of objects and modifies their color. This degradation, which depends on distance, atmospheric particle density and wavelength, makes it difficult to identify the main characteristics of the objects recorded in the image, especially in distant scenes with high haze and/or fog density, which impedes subsequent image processing tasks.

Dehazing techniques aim to eliminate or reduce this degradation and improve the visual quality of images for computer-aided applications and human interpretation. Their goal is to obtain an image as free as possible from haze or fog. Dehazing is an essential process in many applications, such as air and sea transportation, surveillance, driver assistance systems, remote sensing, agronomy, archaeology, astronomy, medical sciences and environmental studies. A large number of dehazing algorithms have been proposed in the last decade. Depending on the proposed paradigm, dehazing methods can be classified in different ways (Wang and Yuan 2017). The most recent dehazing techniques mainly focus on the single-image strategy.

The interest in multispectral and hyperspectral imaging systems has increased in the recent years and the range of application fields has widened considerably (Martínez-Domingo et al. 2020). However, there is a great scarcity of hyperspectral imaging databases in the domain of image dehazing, especially in uncontrolled conditions.

Since most of the existing dehazing methods work with three-channel color images as input, in this study we have taken a step forward by searching for the optimal triplet of bands to be used as input for a given algorithm. The selection of the optimal three bands has been done using a brute force search strategy by imposing several initial constraints for better optimization. The performance evaluation has been performed using a new combined metric of image quality evaluation from three commonly used metrics in dehazing.

## SPECTRAL HAZY IMAGE DATABASE

To the best of our knowledge, there is only one database for dehazing that contains spectral images (captured under controlled conditions), called SHIA (Spectral Hazy Image Database) (El Khoury et al., 2020). It is composed of pairs of real images captured with and without various haze densities under the same conditions. All images are 1,312 x 1,082 pixels in size. The SHIA database has two scenes and ten levels of artificially generated haze density. We selected scene M1 from the SHIA database, which has 28 channels between 450 nm and 720 nm with a spectral resolution of 10 nm, and a medium haze density level (level 7). The integration time is the same for all wavelengths, leading to increased noise for short wavelengths due to the low spectral response to the irradiance incident on the sensor.

## **DEHAZING METHODS**

We have selected five state-of-the-art single-image dehazing algorithms: Dark Channel Prior (DCP) (He et al. 2010), DehazeNet (Cai et al. 2016), Berman (Berman and Avidan 2016), Contrast Limited Adaptive Histogram Equalization (CLAHE) (Xu et al. 2009) and Artificial Multiple Exposure image Fusion (AMEF) (Galdran 2018), representative of different strategies which address the dehazing objective.

## **IMAGE QUALITY METRICS**

Image quality assessment methods have been used to evaluate dehazing algorithms and can be classified into three categories according to the criterion of the need for a reference haze-free image: full reference metrics that require the haze-free image as reference, reduced reference metrics that use the image with haze as reference, and no reference metrics. Since we have used a database containing reference haze-free images, we have chosen a subset of full reference metrics for the analysis of our results. The selected metrics are multiscale structural similarity (MS-SSIM) (Wang et al. 2003), visual information fidelity (VIF) (Sheik and Vovik 2006), and multiscale enhanced color image difference (MS-iCID) (Preiss et al. 2014).

In this study, we have introduced a new metric for the evaluation of the quality of dehazing images, known as combined metric for dehazing image evaluation (CM-DIE), which is a combination of the MS-SSIM, VIF and MS-iCID metrics. This combined metric, CM-DIE, yields a single value for image quality evaluation, which allows performing the brute force optimization method to select the three best bands for each dehazing algorithm. The combined metric is defined as

$$CM - DIE = |1 - VIF| + MSiCID + (1 - MSSSIM)$$

where VIF represents the VIF value, MSiCID the MS-iCID value, MSSSIM the MS-SSIM value for the image pair, and the straight bars represent the absolute value function. As defined, the closer the value of the metric is to zero, the more similar the two images compared will be. All three metrics have equal weight in the calculation of the combined metric, as the complement of VIF and MS-SSIM is used directly added to the MS-iCID value. This is considered appropriate given the range of different metrics and complements of metric values that we have encountered in our experiments.

## **ALGORITHM PARAMETER SELECTION AND BRUTE FORCE OPTIMIZATION**

### **Algorithm parameters**

Most of the dehazing methods selected for this study have been designed to work with three-channel images (and some specifically for color images). Most of them are also parametric. We have decided to use the same parameters as in a previous study (Martínez-Domingo et al. 2020), since part of the method and the image database are the same in this study as in the previous one.

### Brute-force band optimization

We have imposed several constraints on the brute-force optimization to initially reduce the number of possible combinations. We only considered three-band combinations with the following constraints 1) minimum distance of 40 nm between each pair of bands; and 2) bands ordered from longest to shortest wavelength, emulating the RGB sorting of channels in a conventional color image. With these constraints, the possible combinations were greatly reduced, which allowed us to perform the optimization by brute force and thus test all possible combinations. This method allows us to find the optimal combination within the restricted set of three-band images. The optimal combination was the one corresponding to the minimum value of the proposed combined metric.

### RESULTS AND DISCUSSION

Here we evaluate the results obtained by the different dehazing methods tested using the quantitative data of the quality metrics. We also show the original haze-free, hazy and dehazed images in grayscale corresponding to the optimal three bands selected for each algorithm. To generate this grayscale image, we averaged the intensity values of the three bands, to allow a better comparison between methods with different optimal triplet bands.

#### Quality metrics for the optimum triplet band for each dehazing algorithm

Table 1 shows the values of the four different quality metrics, mean values and standard deviations, for the 1,540 triplets tested and for each of the dehazing algorithms, as well as the wavelength triplet bands selected by the brute-force approach.

method	mean value	best value	mean value (std)		
	(std)	triplet (nm)	MS-SSIM	VIF	MS-iCiD
	CM-DIE	R-G-B			
DCP	0.678 (0.162)	720-600-540	0.856 (0.043)	1.370 (0.106)	0.165 (0.033)
DehazeNet	0.925 (0.061)	530-490-450	0.896 (0.020)	0.387 (0.026)	0.207 (0.036)
Berman	0.368 (0.113)	560-510-450	0.924 (0.014)	0.887 (0.136)	0.140 (0.028)
CLAHE	0.324 (0.053)	710-650-610	0.929 (0.003)	1.116 (0.047)	0.137 (0.031)
AMEF	0.291 (0.057)	550-490-450	0.931 (0.010)	0.895 (0.045)	0.115 (0.018)

Table 1: Distribution of the quality metrics (average & standard deviation). The third column shows the wavelengths of the optimum bands selected by brute force.

Each metric shown in Table 1 produces a slightly different ranking of the algorithms, which is not surprising considering that they are sensitive to different changes in the image, or quantify these changes (artifacts or distortions) in different ways. Nevertheless, they all rank AMEF as the best performing method and CLAHE as the second best on average for the 1,540 images. The VIF values are higher than unity for DCP and CLAHE, showing that the changes introduced by dehazing algorithms could be consistent with image improvement in some features such as contrast. MS-SSIM shows a lower discriminative ability (the best and worst performing algorithms are closer in value for this metric

than for the others), and the worst result corresponds to the DCP method. In the case of MS-iCID the worst values correspond to the DehazeNet method, perhaps reflecting some alteration in the distribution of intensity values within bands as a consequence of dehazing. We have focused our analysis mainly on the values of the combined metric (CM-DIE), since the optimization was performed based on the distribution of values of this metric. The lower value of the standard deviation corresponds also to AMEF, which is related not only to a lower dispersion of the values of the metric, but also to a lower mean value. The difference between AMEF and CLAHE is not very large for the mean value of CM-DIE, standard deviation or range. The worst performing method is DehazeNet where it is likely that the amount of haze in the images is too high for its performance to be acceptable, a trend that we also found in our previous study with single-band images (Martinez-Domingo et al. 2020).

Regarding the optimal bands selected for each algorithm (i.e. the minimum values of the metric range shown in Table 1), there is considerable variability in the distribution of peak positions among algorithms. The method giving spectral positions close to typical conventional camera RGB peak positions is DCP, which is not among the top ranked. However, the triplet selected for DCP has two wavelengths in the red range and one in the blue-green range. The shortest wavelength selected for the DCP is also the shortest in the spectral range of the SHIA database, which is 450 nm. The narrow spectral range is one of the limitations of this database. The CLAHE method has selected bands within the long wavelength range, where the contrast of the haze-free images is higher, while the DehazeNet, Berman and AMEF methods use wavelengths above 450 nm and below 560 nm. The two shortest wavelengths in the triplets selected by DehazeNet and AMEF are common (450 nm and 490 nm). This could be related to the fact that haze-free and dehazed images of relatively low quality tend to be intrinsically more similar, and the quality is low even for haze-free images near the short end of the spectral range in SHIA database.

### Grayscale visualization of the optimum triplets

Starting from the optimal triplet for the best value of the combined metric, we generated the grayscale images by the mean value of the three channels with each of the methods (Fig. 1). The first image in each case corresponds to the original image without haze. Next, the image affected with haze is shown. And third, the image restored with each of the methods is shown. At first glance, the first thing that is striking is the difference between the DCP and the other methods. The recovered image has a high contrast, although it has some artifacts in the corners. This is probably due to a contrast stretching step included in the original algorithm. This post-processing step could also be performed in other methods, obtaining similar looking results. However, we have decided not to add such a post-processing step, and we show the results obtained using the original algorithms without any additional enhancement step. Coinciding with the quantitative analysis, the DehazeNet method shows the worst results, removing very little amount of haze and resulting in an almost impossible identification of the objects contained in the scene.

The Berman method is at an intermediate level of performance. In the case of the CLAHE and AMEF methods, the superiority of CLAHE over AMEF is visually very clear. The CLAHE method appears to display a sharper image and is able to better identify the edges of the scene despite having a clearer, haze-free original image. Contrary to the results obtained by the metrics, it is not easy, from a visual point of view, to be able to select AMEF as the best method. The fact that, in visual appearance, some methods appear better than others is closely related to the quality of the haze-free image

corresponding to the optimal bands selected in each case. This is influenced by the limitations of the database at short wavelengths, discussed above.

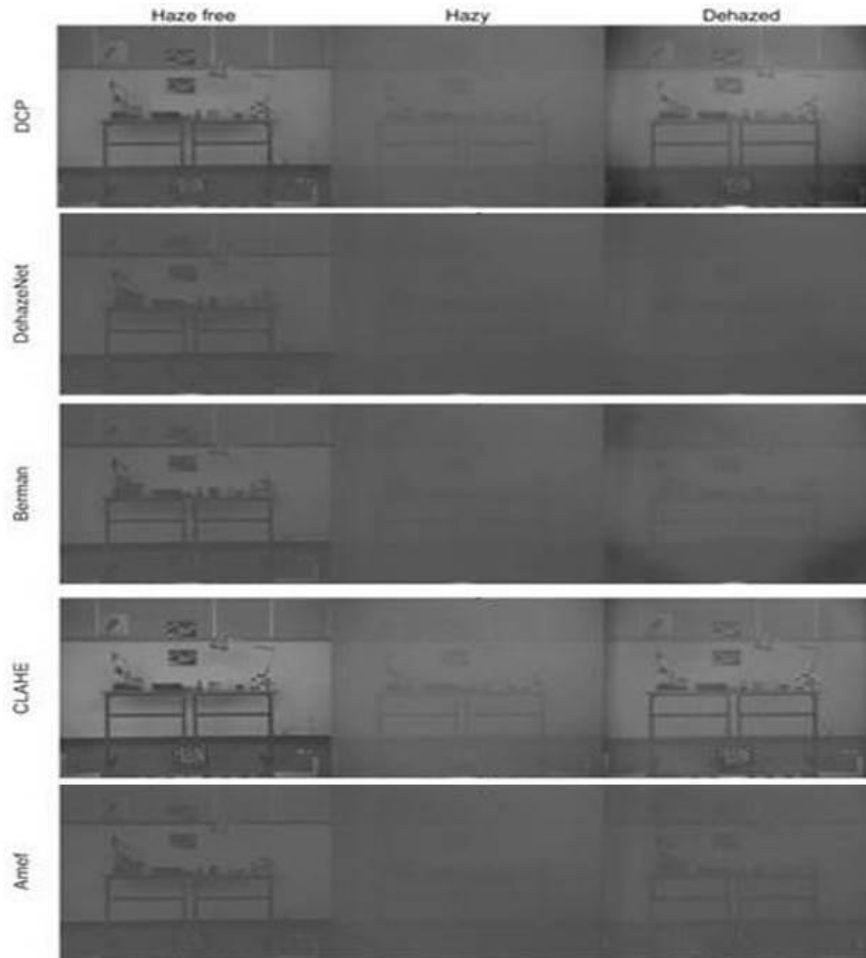

Figure 1: Original haze-free images (left), haze images (next) and restored images (right). The images correspond to grayscale images generated from the average intensity of the three channels of the optimum triplets for each selected dehazing method.

Despite having chosen three image quality metrics that evaluate different aspects of the recovered image, it is important to note that the existing image quality evaluation metrics do not provide us with information that can be matched to the observed visual appearance.

## CONCLUSIONS

Our results suggest that algorithms that generate a more haze-free and low-artifact image also provide better similarity metrics (AMEF, CLAHE). However, algorithms that tend to generate larger image variations, or that are sensitive to the contrast quality of the original image (DCP), tend to obtain better results with bands around long wavelengths, which have higher image quality in both the original haze-free and dehazed image. Not being able to have image data of uniform quality at all wavelengths has been a major limitation in our study. The optimal wavelengths selected within the constraints imposed in this study depend on the algorithm used, and this fact makes it difficult to obtain a fair visual assessment of the results, even using grayscale images to display the original and dedifferentiated images. Methods based on image processing techniques (such as CLAHE) obtain better results than

those based on physical methods (e.g., DCP), although this fact could be related to the use of artificially created fog in the database, which might not be as well described by physical models as natural fog.

## **FUNDING**

The Spanish Ministry of Science Innovation and Universities (MICINN, grant RTI2018-094738-B-I00) and the Junta de Andalucía (grant A-TIC-050-UGR18), both financed with FEDER Funds.

## **REFERENCES**

- Berman D., and S. Avidan. 2016. Non-local image dehazing. In: Proceedings of the IEEE Conference on Computer Vision and Pattern Recognition, 1674–1682.
- Cai, B, X. Xu, K. Jia, C. Qing, and D. Tao. 2016. Dehazenet: An end-to-end system for single image haze removal, *IEEE Transactions on Image Processing* 25, 5187–5198.
- El Khoury, J., J.-B. Thomas, and A. Mansouri. 2020. A Spectral Hazy Image Database. In: International Conference on Image and Signal Processing, 44–53.
- Galdran, A. 2018. Image dehazing by artificial multiple-exposure image fusion, *Signal Processing* 149: 135–147.
- He, K., J. Sun, and X. Tang. 2010. Single image haze removal using dark channel prior. *IEEE Transactions on Pattern Analysis and Machine Intelligence* 33, 2341–2353.
- Martínez-Domingo M.A, E. M. Valero, J. L. Nieves, P. J. Molina-Fuentes, J. Romero, and J. Hernández-Andrés. 2020. Single Image Dehazing Algorithm Analysis with Hyperspectral Images in the Visible Range, *Sensors* 20:6690.
- Preiss, J., F. Fernandes, and P. Urban. 2014. Color-image quality assessment: From prediction to optimization. *IEEE Transactions on Image Processing* 23, 1366–1378.
- Sheikh H.R. and A. C. Bovik. 2006. Image information and visual quality. *IEEE Transactions on Image Processing* 15, 430–444.
- Wang, Z., E. P. Simoncelli, and A. C. Bovik. 2003. Multiscale structural similarity for image quality assessment. In: Thirty-Seventh Asilomar Conference on Signals, Systems & Computers, 1398–1402
- Wang, W., and X. Yuan. 2017. Recent advances in image dehazing. *IEEE CAA J. Autom. Sinica* 4: 410-436.
- Xu, Z., X. Liu, and X. Chen. 2009. Fog removal from video sequences using contrast limited adaptive histogram equalization. In: IEEE International Conference on Computational Intelligence and Software Engineering, 1-4.

1 COLOR AND MEASUREMENT INSTRUMENTATION	2 COLOR AND DIGITAL	3 COLOR AND LIGHTING	4 COLOR AND PHYSIOLOGY
5 COLOR AND PSYCHOLOGY	6 COLOR AND PRODUCTION	7 COLOR AND RESTORATION	8 COLOR AND BUILT ENVIRONMENT
9 COLOR AND DESIGN	10 COLOR AND CULTURE	11 COLOR AND EDUCATION	12 COLOR AND COMMUNICATION MARKETING

## 3 COLOR AND LIGHTING

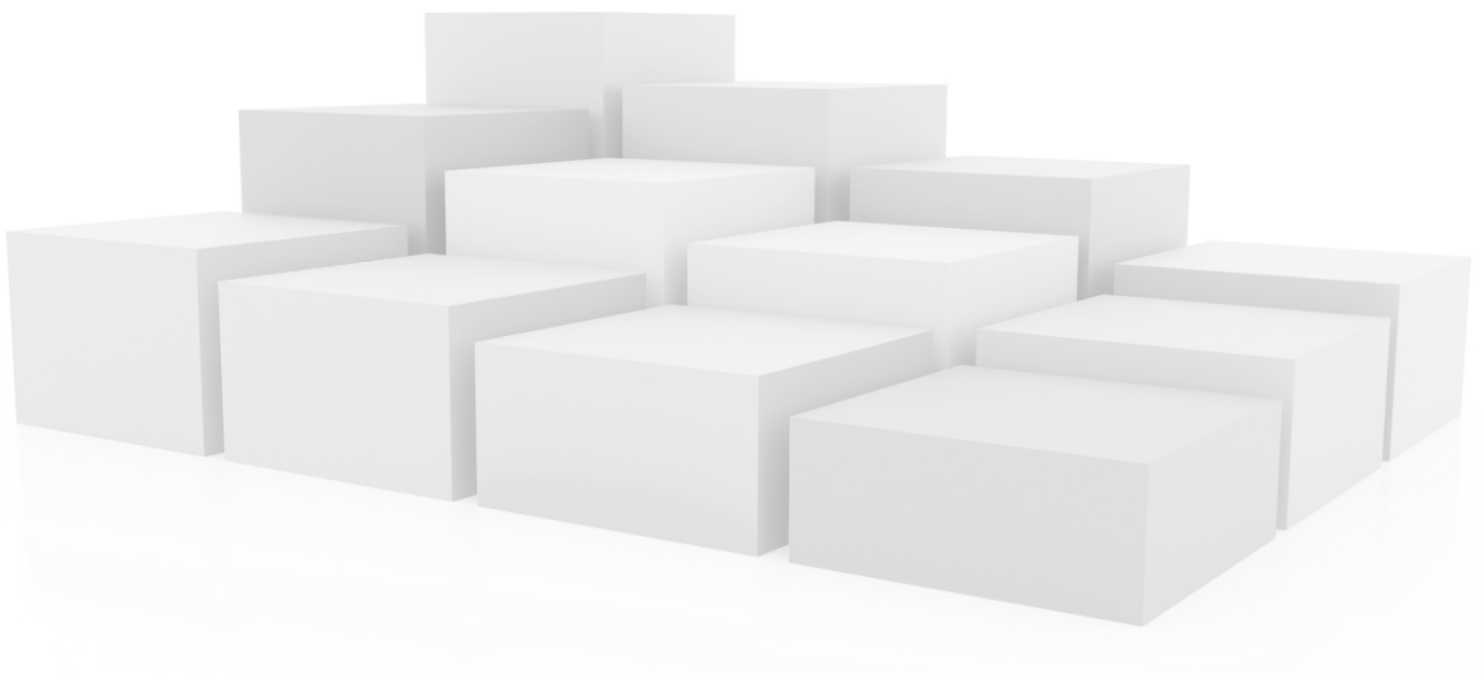

AIC 14<sup>th</sup> Congress Milano 2021 - August 30<sup>th</sup>– September 3<sup>rd</sup> 2021





# A proposal for the definition of colored light sources in lighting CAD

**Maurizio Rossi**

<sup>1</sup> Politecnico di Milano – Design Department; maurizio.rossi@polimi.it

\* Corresponding author: maurizio.rossi@polimi.it

## **Abstract**

In the last ten years, the introduction of LED lighting sources has brought elements of innovation to interior lighting design. Besides the new tunable white LED source, light is no longer exclusively white; indeed, colored lighting has wholly entered the design practice thanks to the positive effects on people's health and mood. Unfortunately, these elements of innovation cannot be computed correctly in commercial Lighting CADs. These are based on the assumption that light is only white or defined in terms of RGB triplets in the relative color space of the computer graphics, which does not have a physically correct relationship with the actual spectral power distribution (SPD) of light sources. In this paper, the attention is focused on describing the light sources for practical lighting design that also consider the SPD. The focus is on information available to lighting designers who cannot have a laboratory to measure light sources and luminaires. This information is nowadays available in online datasheets from luminaires and light sources manufacturers. Following this idea, a set of functions is proposed to be easily implemented in Lighting CAD software to improve light sources' color management.

**Keywords:** *Lighting design, CAD, SPD, color*

## **INTRODUCTION**

Research describing light-matter interaction in the pipeline from luminaires to lighting analysis and rendering has a long history of exciting developments that collide with the need to represent images on output devices such as RGB monitors and CMYK printers. One of the key points of multispectral research is: how many samples are necessary to correctly describe the simulated spectral physical phenomenon? A first attempt to determine a reasonable sampling of the wavelengths has been introduced by Meyer (1988). In his method, the choice of the wavelengths is made to minimize the computational errors regarding the selected tristimulus values. Meyer defined the  $AC_1C_2$  color space to determine how many samples and what wavelengths to use. This technique has been successfully used to generate image synthesis colorimetrically more correctly, knowing the spectral reflectance of materials. As far as the description of the materials is concerned other researchers have tried to explore how many chromatic dimensions are necessary to carefully describe the reflectance (Hardeberg 2001). Some argued that the reflectance of most natural materials doesn't contain high-frequency information (Cohen 1964); therefore, it should be enough to use a limited number of dimensions.

Nevertheless, the spectral distribution of light originates from light sources, so it's not only an issue regarding material spectral reflectance. As shown by Deville et al. (1994), using a few SPD samples is applicable without errors only for light sources with continuous linear SPD. We know that discharge lamps and some white and colored LEDs have SPD with spikes and discontinuities. In the adaptive method proposed by Deville, the wavelengths domain is partitioned in intervals. The intervals depend upon the reflectance specter of the materials and the light sources SPD analyzed in a pre-processing phase. The partitions are determined algorithmically to satisfy two conditions: every interval must contain only continuous portions of the specter, and possible specter peaks are placed in single intervals of at least 5nm width. Then the single partitions are numerically integrated with the trapezoids method only for 5nm intervals or with the Gaussian method in the other cases. The choice of wavelengths depends on all those selected for the numerical integrations in the various

integration intervals. In the following years, many studies focused on the sampling methods for multispectral rendering (Johnson and Fairchild 1999; Iehl and Péroche 2003; Chern and Wang 2005; Wilkie et al. 2014; Petitjean et al. 2018; Peters et al. 2019). The goal was to determine the minimum number of samples needed to contain calculation errors. Nevertheless, the results of these researches have not been implemented in Lighting CADs.

In the modern lighting design methodology, lighting CAD software has supported the designer's experience for some time. However, these software have some limitations when the chromatic component is also evaluated in the lighting project. Although there has been software for some time capable of calculating lighting with physically based rendering (Next Limit 2004; Ward and Shakespeare 2004), also considering the spectral quantities, these calculation methods are not applied in Lighting CAD used worldwide for Lighting Design. In commercially available software, the color of light and illuminated surfaces is approximated by RGB triplets, which at best respect the sRGB standard (Guarini and Rossi 2021) and do not have a physically correct relationship with the spectral, radiometric quantities defined in the context of radiometry. This simplification of the spectral and chromatic aspects in Lighting CAD is due to the difficulty, or almost impossibility, for lighting designers to find the spectral information concerning light sources and materials in design practice (Cazier et al. 1994). For the multispectral calculation, the idea followed in this paper is not to focus on the SPD sampling method, instead to propose a practical approach that allows Lighting designers and Lighting CAD developers to obtain the SPD of light sources, starting from the measured data available in the manufacturers' online datasheets. In very few cases, spectral data is available online, as a file, in the recent North American standard TM-27-20 (ANSI/IES, 2020).

### AVAILABLE DATA

In the following, we distinguish the radiometric (e subscript) and photometric (v subscript), and total values to spectral functions where the dependence by wavelength  $\lambda$  is always explicit.

What is usually available online by the manufacturers is the Light Intensity Distribution (LID)  $I_v(\theta, \phi)$  of the Luminaires. Other data available are the luminaire  $\Phi_{v, \text{luminaire}}$ , and/or lamp  $\Phi_{v, \text{lamp}}$  luminous flux and the efficiency  $\eta_a$  of the luminaire. Within the LID, the luminous intensity  $I_v$  has SI candles [cd] as tabular functions of polar angles  $(\theta, \phi)$  (in the C- $\gamma$  or V-H format). The manufacturers generally bring the LID normalized to the conventional luminous flux of 1000 lumens:

$$I_{v, 1Klm}(\theta, \phi) = 1000 \cdot I_v(\theta, \phi) / \Phi_{v, \text{lamp}} \quad [\text{cd} \cdot \text{Klm}^{-1}] \quad (1)$$

The relation between the luminous flux of the lamp and the fixture is :

$$\Phi_{v, \text{lamp}} = \Phi_{v, \text{luminaire}} / \eta_a \quad [\text{lm}] \quad (2)$$

Also available is the relative SPD:  $S_e(\lambda)$ . This is given by the ratio between the SPD,  $\Phi_{e, \lambda}$  and the SPD value for  $\lambda=560\text{nm}$  percent:

$$S_e(\lambda) = 100 \cdot \Phi_{e, \lambda} / \Phi_{e, 560 \cdot 10^{-9}} \quad [\text{m}^{-1}] \quad (3)$$

The recommendations (ISO/CIE 2007) on the definitions of standard illuminants use, for this definition, the normalization to  $\lambda=560\text{nm}$ . Other texts report this for  $\lambda=555\text{nm}$ , the wavelength the photopic luminous function  $V(\lambda)$  reaches its maximum. The increasing use of sources with discontinuous SPD has brought to use other kinds of normalization. For example, compared to the maximum value of the SPD,  $\Phi_{e, \text{max}} = \Phi_{e, \lambda_m}$  at a generic wavelength  $\lambda_m \neq 560\text{nm}$ . This way, the graph of the relative SPD reaches its maximum with unitary value for  $\lambda = \lambda_m$ :

$$\Phi_{e,\lambda,\bar{l}} = \Phi_{e,\lambda} / \Phi_{e,\lambda_m} \quad [\text{m}^{-1}] \quad (4)$$

Another normalization uses the SPD to produce a total luminous flux of 1lm or 1Klm. Given  $\Phi_v$ , the luminous flux of a lamp and  $\Phi_{e,\lambda}$  its spectral radiant power:

$$\Phi_{e,\lambda,\bar{l}lm} = \Phi_{e,\lambda} / \Phi_v \quad [\text{W}\cdot\text{lm}^{-1}\cdot\text{m}^{-1}]; \quad \Phi_{e,\lambda,\bar{l}Klm} = 1000 \cdot \Phi_{e,\lambda} / \Phi_v \quad [\text{W}\cdot\text{Klm}^{-1}\cdot\text{m}^{-1}] \quad (5)$$

The sampling step of this relative SPD, usually available as a table, should never be smaller than 5nm. Often the only data available is a Cartesian graph in which the units of measurement are not specified. Of this graphic representation, we are interested in the shape of the spectrum. Fortunately, in these cases, the Lighting designer can use free software such as Engauge Digitizer (Mitchell 2015) to quickly obtain the table of  $S_e(\lambda)$  from the graph. As a last chance, if the source is white incandescent light, the only information available is usually the correlated color temperature (CCT). In these cases, we may compute the spectral radiant exitance by Plank's law:

$$M_{e,\lambda} = [\varepsilon(\lambda) \cdot 2\pi \cdot h \cdot c^2] / [\lambda^5 (e^{hc/\lambda kT} - 1)] \quad [\text{W}\cdot\text{m}^{-2}\cdot\text{m}^{-1}] \quad (6)$$

Where T is the CCT in Kelvin degree,  $h = 6,6262 \cdot 10^{-34}$  is the Plank's constant,  $k=1,3805 \cdot 10^{-23}$  is the Boltzmann's constant, and  $c$  is the light speed. The function  $\varepsilon(\lambda)$  is the spectral emissivity characteristic of the material. Materials with constant emissivity for every wavelength are called grey bodies. For tungsten filament lamps ( $\varepsilon=0.3$ ), the T of these lamps can vary from 2800K to 3100K. For halogen lamps, the T is from 3000K to 3400K.

## COMPUTING THE SID

In Lighting CAD software, the key information for computing illuminance  $E_v$  on the surfaces is the LID,  $I_v(C, \gamma)$ , of luminaires, usually downloadable as .IES (IESNA) or .LDT (EULUMDAT) file format. In a desirable future multispectral Lighting CAD, the data we need for the light sources is the Spectral Intensity Distribution (SID)  $I_{e,\lambda}(C, \gamma)$  with SI units  $[\text{W}\cdot\text{sr}^{-1}\cdot\text{m}^{-1}]$ . This is the spectral Radiant Intensity emitted by the luminaire in its surrounding space as a function of three variables, the two polar angles  $C, \gamma$  and the wavelength  $\lambda$ . We need to obtain this from the manufacturers' available data:  $I_v(C, \gamma)$  and  $S_e(\lambda)$ . If it is known the normalized photometric LID  $I_{v,1Klm}(C, \gamma)$ , the absolute photometric LID can be determined recalling eq. (1):

$$I_v(C, \gamma) = 10^{-3} \cdot I_{v,1Klm}(C, \gamma) \cdot \Phi_{v,lamp} \quad (7)$$

The problem is that the LID contains only information on directional photometric intensities. Instead, the relative SPD  $S_e(\lambda)$  contains normalized information of radiant spectre. However, it doesn't have a total energy value, and it has SI unit  $[\text{m}^{-1}]$ . To get the SID one cannot simply multiply  $I_v(C, \gamma)$  and  $S_e(\lambda)$  since the product has dimensional value  $[\text{cd}] \cdot [\text{m}^{-1}] \neq [\text{W}\cdot\text{sr}^{-1}\cdot\text{m}^{-1}]$  that is physically not compatible with  $I_{e,\lambda}(C, \gamma)$ . For the calculation of  $I_{e,\lambda}(C, \gamma)$ , it should also be considered the human photopic spectral efficacy function  $K(\lambda)=V(\lambda) \cdot 683.003$ , that has SI unity  $[\text{lm}\cdot\text{W}^{-1}]$ . We want to find how to analytically justify this affirmation. Remembering the definition of spectral radiant intensity  $I_{e,\lambda}$ , the definition (3) can be rewritten in the following way:

$$S_e(\lambda) = 100 \cdot \frac{d\Phi_\lambda}{d\omega} \bigg/ \frac{d\Phi_{560 \cdot 10^{-9}}}{d\omega} = 100 \frac{I_{e,\lambda}(C, \gamma)}{I_{e,560 \cdot 10^{-9}}(C, \gamma)} \quad (8)$$

where the differential solid angle  $d\omega$  is identified along the direction identified by the polar angles  $(C, \gamma)$ . We know, from the photometric definition of luminous intensity:

$$I_v = \int_{\lambda} I_{e,\lambda} K(\lambda) d\lambda \quad (9)$$

so if we define:

$$I_{v,\lambda} = I_{e,\lambda} \cdot K(\lambda) \quad (10)$$

eq. (8) could be written the following way:

$$S_e(\lambda) = 100 \frac{I_{v,\lambda}(C,\gamma)}{K(\lambda)} \frac{K(560 \cdot 10^{-9})}{I_{v,560 \cdot 10^{-9}}(C,\gamma)} \quad (11)$$

In eq. (11)  $K(560 \cdot 10^{-9}) = 679,585$  [lm/W] however the value  $I_{v,\lambda}(C,\gamma)$  is not known for  $\lambda = 560 \cdot 10^{-9}$ . Nevertheless, if from eq. (11) we get  $I_{v,\lambda}(C,\gamma)$  it results:

$$I_{v,\lambda}(C,\gamma) = \left[ \frac{I_{v,560 \cdot 10^{-9}}(C,\gamma)}{100 \cdot K(560 \cdot 10^{-9})} \right] \cdot [S_e(\lambda) \cdot K(\lambda)] \quad (12)$$

in eq. (12),  $I_{v,\lambda}(C,\gamma)$  is given by the product of two factors: the first, unknown, is a function of the polar angles  $C,\gamma$ , while the second is the product of two known spectral functions and depends only on wavelength. To determine the first factor, we can integrate eq. (12) with respect to wavelength:

$$\int_{\lambda} I_{v,\lambda}(C,\gamma) d\lambda = \xi(C,\gamma) \cdot S_v \quad (13)$$

where  $S_v = \int_{\lambda} S_e(\lambda) \cdot K(\lambda) d\lambda$  and  $\xi(C,\gamma) = \frac{I_{v,560 \cdot 10^{-9}}(C,\gamma)}{100 \cdot K(560 \cdot 10^{-9})}$  could be computed:

$$\xi(C,\gamma) = I_v(C,\gamma) / S_v \quad (14)$$

where  $I_v(C,\gamma)$  is known by the manufactures and defined in eq. (9). From the eq. (12) we could obtain  $I_{v,\lambda}(C,\gamma)$ :

$$I_{v,\lambda}(C,\gamma) = \xi(C,\gamma) \cdot S_e(\lambda) \cdot K(\lambda) \quad (15)$$

and from eq. (10), (14) and (15) we finally obtain the SID:

$$I_{e,\lambda}(C,\gamma) = S_e(\lambda) \cdot I_v(C,\gamma) / S_v \quad [\text{W} \cdot \text{sr}^{-1} \cdot \text{m}^{-1}] \quad (16)$$

from the point of view of the SI units, the result is correct:

$$[\text{m}^{-1}] \cdot [\text{cd}] / [\text{m}^{-1} \cdot \text{lm} \cdot \text{W}^{-1} \cdot \text{m}] = [\text{m}^{-1}] \cdot [\text{lm} \cdot \text{sr}^{-1}] / [\text{lm} \cdot \text{W}^{-1}] = [\text{W} \cdot \text{sr}^{-1} \cdot \text{m}^{-1}] \quad (17)$$

This definition for the SID is calculated through the data provided by the manufacturers. For Lighting CAD computing, we observe that eq. (16) is the product of a function that depends only on the wavelength  $\lambda$  with a function that depends only on the polar angles  $(C,\gamma)$ . Therefore, it is easier to integrate using numerical methods with respect to the wavelength (to get weighted multispectral values or tristimulus values XYZ) or with respect to the angles to compute the irradiance on surfaces. The value  $S_v$  must be determined with numerical integration since the two spectral functions  $S_e(\lambda)$  and  $K(\lambda)$  are tables not available analytically. Therefore the integration method on the wavelength domain by Meyer (1988) must be excluded because of the possible presence of spectral discontinuities. For this kind of integration, the method of Deville et al. (1994) may be used. Alternatively, thanks to the computational power reached by today's PC, it is possible to use the more straightforward approach of uniform quadrature with a fixed footstep of 5nm width for a total of 81 samples. In practice, such calculation must be done only one time for every light source present within the virtual scene:

$$S_v = \int_{380}^{780} S_e(\lambda) \cdot K(\lambda) d\lambda = 5 \cdot 10^{-9} \sum_{i=0}^{80} S_e((380 + 5 \cdot i) \cdot 10^{-9}) \cdot K((380 + 5 \cdot i) \cdot 10^{-9}) \quad (18)$$

To use the light source defined by the eq. (16) within a multispectral computation model, it is possible to use only 3 dimensions, the tristimulus values XYZ:

$$\begin{aligned}
 I_X(C, \gamma) &= \xi(C, \gamma) \int_{\lambda} S_e(\lambda) \bar{x}(\lambda) d\lambda \\
 I_Y(C, \gamma) &= \xi(C, \gamma) \int_{\lambda} S_e(\lambda) \bar{y}(\lambda) d\lambda \quad . \\
 I_Z(C, \gamma) &= \xi(C, \gamma) \int_{\lambda} S_e(\lambda) \bar{z}(\lambda) d\lambda
 \end{aligned}
 \tag{19}$$

## CONCLUSIONS AND FUTURE OUTLOOK

The proposed method for determining the SID has a main limitation: it can be applied only to luminaires where the  $S_e(\lambda)$  function does not vary with the polar angles  $(C, \gamma)$ . This is true for many products used in general lighting, but it is not "always" confirmed with the advent of LEDs for lighting. In the limited instances, where  $S_e(\lambda)$  changes with the direction as a design choice of the lighting product, the only possibility to obtain the SID is to measure it using the newly available gonioradiometers for luminaires measurement and, also, to be able to represent it in 3D at the benefit of the Lighting Designer to help understand the color performance of the luminaire (Rossi and Musante 2015). Another limitation is when  $S_e(\lambda)$  is determined through a reverse data construction process from the spectrum graph, this manual operation could generate errors.

The solid-state lighting revolution has changed the practice of lighting designers. Lighting design is no longer based only on the choice of luminaires taken from manufacturers' catalogs but also on semi-finished light sources products. The availability of LED modules and LED strips allows other professional roles such as makers and interior designers to dematerialize the luminaires with custom installations hidden into the architectural niches or behind large transparent diffusing surfaces. Having large surfaces emitting light generates another problem. The classical method to measure the LID, known as far-field photometry, uses the goniophotometer. This instrument measures the luminous intensity exiting in all directions around the luminaire. The photometer is placed at a distance of some meters to measure the luminous intensities relative to the center of light exitance. If the emitting surface is small, that's fine. When we have larger luminaires, the center is a conventional point placed in the center of the principal luminous exitance surface of the luminaire, considering it a point source. However, within this last statement resides the nature of the known near-field problem. If a light source is geometrically extended, the LID measure allows to correctly use the LID to calculate the illuminance only at the same distance the measures have been done. New products and custom installations based on LEDs can have an emitting surface on which the color of the light emitted also varies according to the position. This means that a complete definition of the SID presupposes a more complex function for the geometrically extended light sources,  $I_{e,\lambda}(C, \gamma, u, v)$  in which the emitted spectrum also varies as a function of the parametric position on the surface  $(u, v)$ . The problem, therefore, arises of how to measure and describe the light field surrounding these luminaries. If solutions to this further problem have already been studied from a theoretical point of view (Paul et al. 1995; Ashdown and Eng 1998; Goesele et al. 2003), there is still a long way to go for their implementation by manufacturers and Lighting CAD.

## REFERENCES

ANSI/IES. 2020. TM-27-20 - Standard Format for the Electronic Transfer of Spectral Data.

- Ashdown, I. 1995. Near-Field Photometry: Measuring and Modeling Complex 3-D Light Sources. In SIGGRAPH 1995 Course Notes.
- Cazier, D., D. Chamont, P. Deville, and J. C. Paul. 1994. Modeling Characteristics of Light a Method Based on Measured Data. In *Fundamentals of Computer Graphics*, 113-27. WORLD SCIENTIFIC.
- Chern, J-R., and C-M. Wang. 2005. A Novel Progressive Refinement Algorithm for Full Spectral Rendering. *Real-Time Imaging, Spectral Imaging II*, 11 (2): 117-27.
- Cohen, J. 1964. Dependency of the Spectral Reflectance Curves of the Munsell Color Chips. *Psychonomic Science* 1 (1): 369-70.
- Deville, P. M., S. Merzouk, D. Cazier, and J. C. Paul. 1994. Spectral Data Modeling for a Lighting Application. *Computer Graphics Forum* 13 (3): 97-106.
- Goesele, M., X. Granier, W. Heidrich, and H-P. Seidel. 2003. Accurate Light Source Acquisition and Rendering. *ACM Transactions on Graphics* 22 (3): 621-30.
- Guarini, G., and M. Rossi. 2021. A Practical Procedure for Obtaining Calibrated Material Colors for CAD Systems. In: M43:196-201. Smolensk, RU: Smolensk State University Press.
- Hardeberg, J. Y. 2001. Acquisition and Reproduction of Color Images: Colorimetric and Multispectral Approaches. Illustrated edition. s.l.: Dissertation.Com.
- lehl, J. C., and B. Péroche. 2003. Towards Perceptual Control of Physically Based Spectral Rendering. *Computers & Graphics* 27 (5): 747-62.
- ISO/CIE. 2007. ISO 11664-2:2007(E)/CIE S 014-2/E:2006 Colorimetry - Part 2: CIE Standard Illuminants.
- Johnson, G.M., and M.D. Fairchild. 1999. Full-Spectral Color Calculations in Realistic Image Synthesis. *IEEE Computer Graphics and Applications* 19 (4): 47-53.
- Meyer, G. W. 1988. Wavelength Selection for Synthetic Image Generation. *Computer Vision, Graphics, and Image Processing* 41 (1): 57-79.
- Mitchell, M.. 2015. Engauge Digitizer. C++. <https://github.com/markummitchell/engauge-digitizer>.
- Next Limit. 2004. Maxwell Render | CPU, GPU & Cloud Photorealistic Render Engine (version 5.2).
- Paul, J. C., P. M. Deville, and C. Winkler. 1995. Modeling Radiative Properties of Light Sources and Surfaces. *The Journal of Visualization and Computer Animation*.
- Peters, C., S. Merzbach, J. Hanika, and C. Dachsbacher. 2019. Using Moments to Represent Bounded Signals for Spectral Rendering. *ACM Transactions on Graphics* 38 (4): 136:1-136:14.
- Petitjean, V, P. Bauszat, and E. Eisemann. 2018. Spectral Gradient Sampling for Path Tracing. *Computer Graphics Forum* 37 (4): 45-53.
- Rossi, M., and F. Musante. 2015. Representation of Chromatic Distribution for Lighting System: A Case Study. In *Color Imaging XX: Displaying, Processing, Hardcopy, and Applications*, 9395:939518. International Society for Optics and Photonics.
- Ward, G., and R. Shakespeare. 2004. *Rendering With Radiance: The Art And Science Of Lighting Visualization*. Revised edition. Davis, Calif.: Booksurge Llc.
- Wilkie, A., S. Nawaz, M. Droske, A. Weidlich, and J. Hanika. 2014. Hero Wavelength Spectral Sampling. *Computer Graphics Forum* 33 (4): 123-31.

# Lighting quality for home-working spaces: a survey

Laura Bellia<sup>1,\*</sup>, Francesca Diglio<sup>1</sup> and Francesca Fragliasso<sup>1</sup>

<sup>1</sup> Department of Industrial Engineering of the University of Naples Federico II, Naples, Italy;  
fr.diglio@studenti.unina.it; francesca.fragliasso@unina.it

\* Corresponding author: bellia@unina.it

## Abstract

The paper presents a survey to investigate the typical characteristics of the luminous environment of workstations organized in private houses and to test people's average awareness about their choices regarding lighting conditions settings. The research has been carried out on a survey sample made up of home workers and students who were forced to work at home because of the pandemic constraints. Daylight and electric light characteristics in home working spaces are inquired: their description, control systems and overall evaluation are shown. Results are presented and discussed.

**Keywords:** Covid-19, home-working, residential lighting, lighting quality

## INTRODUCTION

After the breakout of Covid-19, the home working phenomenon has widespread more than it could have been imagined before the pandemic. The idea to work outside the standard workplaces became popular in the United States in the '80s and then expanded worldwide (Toscano and Zappalà 2020). Specially in recent years, governments have issued promotion policies on this topic (e.g. the "Flexibility for Working Family Act" or the "Schedules That Work Act" in the USA, the "Flexible Working Regulation" in the United Kingdom, the "Loi du Travail" in France, the Law n°81 of May 22 in Italy). However, when on March 11<sup>th</sup>, 2020, Covid-19 was declared a pandemic by the World Health Organization, physical distancing, lockdowns, stay at home orders, travel restrictions, office and school closures were ordered all over the world (Cohen 2020). So, working from home, which was previously optional, became an obligation, spreading quickly around the world.

According to findings of the Bureau of Labour Statistics, in the USA the percentage of employed citizen working from home increased from the 23,7% in 2019 to the 35,4% in May 2020 (U.S. Bureau of Labor Statistics webpage). In Europe, according to an Eurofound research, in 2020 the 37% of all European employed persons worked from home, while in 2019 their percentage was 5,5% only (Eurofound 2020).

This event has changed the way people conceive work: some employees are inclined to continue this arrangement (Gosling, Coppola and McCarthy, no date), moreover some employers consider working from home as a possible option to reduce costs linked to physical space (Caligiuri and De Cieri 2021). Therefore, the home working phenomenon seems destined to continue its development after the pandemic.

Because of the spread of the home working phenomenon, we wonder if people's houses are adequate to host workstations in a way to guarantee comfort conditions. Indeed, the design of comfortable workspaces involve issues regarding both the ergonomics and appropriate environmental conditions (e.g. a proper microclimate or an adequate soundproofing to promote concentration). Among all the space characteristics, lighting has a crucial role determining workers' wellbeing, because it influences our physiological and psychological health in many direct and indirect ways, in addition to enable us to see and perform activities, to sense and perceive what surrounds us.

For traditional workplaces, there are standards containing indications to design adequate lighting systems. In Europe currently, this role is played by the EN 12464-1 (CEN, 2011). Conversely, for home



environments, there are not specific prescriptions for residential lighting. Moreover, the homeowners make their choices in the definition of lighting conditions basing on their personal tastes and knowledge. Of course, it is not possible to oblige people to modify the characteristics of their private spaces, however, raise awareness to the themes connected to the light effects on people's wellness is fundamental.

In this sense, the first step is to get an overview about the typical characteristics of the luminous environment in private houses and about people's average awareness about their choices regarding lighting conditions setting. For this reason, a research has been carried out in Italy, an exemplary case about the recent spread of home working, considering that more than 40% of people worked at home in 2020, compared with a percentage lower than 5% in 2019.

## **METHOD**

The research has been realized on a survey sample made up of home workers and students. A questionnaire, made with Microsoft Office Forms, was diffused online between April 2020 to January 2021 covering different seasons. Consequently, various weather conditions alternated, so answers with different natural light scenarios were collected. The questionnaire inquiries about both the daylight and electric light features of home environments, the interviewees' habits managing the incoming daylight and using electric light, and, especially, people's lighting perception. In more detail, the questionnaire consists of 7 parts. Part 1 is about interviewees' personal information (age, sex, space occupied). The next three parts regard daylight and specifically part 2 is about natural light's characterization (e.g. number and type of windows in the room, their dimension and orientation, the desk's position relative to windows external view); part 3 concerns daylight control (e.g. what kind of shield and/or screen windows are equipped with, how often they are used and if they are used for solar shading or because of privacy); part 4 contains an overall evaluation about daylight pleasantness, distribution and sufficiency during the day. The last three parts, 5, 6, and 7 concern electric light's characterization (e.g. number and type of luminaires, distance from the worktop, number and type of electric light sources inside each luminaire and their characteristics), control systems (e.g. presence of automatic control devices or flux and colour variation systems) and an overall evaluation respectively. In part 7 it is also inquired about energy costs related to electric light and about people's opinion in preferring visual comfort or energetic and economic savings. After these 7 parts a final question was asked to estimate people's interest in lighting-connected themes.

For each question, multiple choices were presented to interviewees or they could give a free answer, sometimes short comments were requested. All the questions were expressed using terms knowable by people, instead of technical terms. 351 people joined the questionnaire, but 5 participants were excluded (2 of them because of their age - younger than 20 or older than 67 - and 3 because the answers were conflicting and/or inadequate). So, 346 tests have been analysed.

## **RESULTS**

The survey sample is made up of 346 people, 182 female and 164 males, aged between 20 and 67, and in all the age ranges the presence of men and women is balanced. The most populated age range is the 20-30 one, since a very high number of students joined the survey. However, the survey sample's partition into students and home workers is representative of the Italian population. Indeed, the ratio of the total number of Italian home workers and university students is equal to 0.48, those of home workers and students interviewed is equal to 0.41 (*USTAT MIUR webpage*;

ISTAT, 2020). Considering the home spaces occupied, only 16.8% of people has the possibility to work in a study, while bedroom/study has the highest percentage (57% of the sample) probably because young people’s rooms (i.e. students) are conceived for both rest and study.

The rooms described are divided in rooms without windows (1.7%), rooms with one window (79.2%), rooms with two windows (15.0%) and rooms with three windows (4.1%). In the following pages only the case of rooms equipped with one window will be described since it is the most recurrent (almost the 80% of the data). A similar approach was adopted for the electric light: all the rooms are divided in rooms with one, two and three electric lighting devices. In this case the percentages referred to one and two devices in a room are almost the same (46% and 46.5% respectively). So, the results will be shown for these two cases. Results will be discussed in sections according to the survey’s structure.

Daylight description (Results in Figure 1) - In rooms with only one opening, two (or more) doors French windows and two (or more) doors windows are the most common typologies, followed by one door French windows and one door windows. The most common frame is wooden frame, followed by PVC, metal and mixed frame. Windowed area for each opening varies between 2 m<sup>2</sup> and 4 m<sup>2</sup>. In Italy, a minimum floor area is prescribed according to the different house spaces and the windowed area should be at least 1/8 of the floor area. This minimum windowed area, indicated in Figure 1c with a dark dash, is respected, moreover for most cases it is significantly higher. As for the exposure, it doesn’t emerge a predominant one, even according to rooms’ type. Generally, people place the desk in such way to receive daylight most from the front or by the side, and to see both the external environment and the sky through the window (or the external environment at least, only sometimes it isn’t possible to see the external environment or the sky).

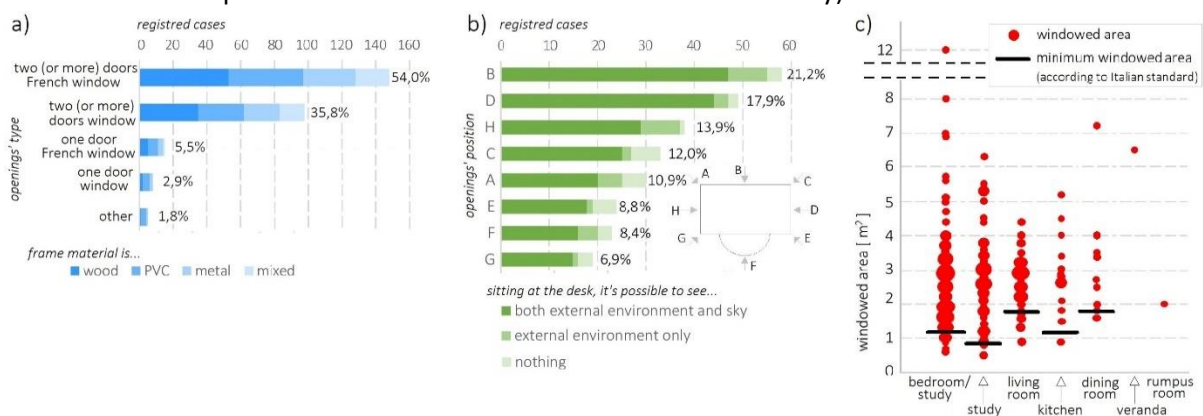

Figure 1: Type and frame (a), position (b) and dimensions (c) of the openings in rooms with one opening.

Daylight control (Results in Figure 2) – As shielding systems are assumed those that filter or redirect light, while screening systems are those that completely exclude incoming daylight. Fabric curtains and roller shutters are the most common shielding and screening systems, respectively. Note that the use of shielding systems is more frequent than the use of the screening ones. Shielding and screening systems are used mostly to control daylight, in few cases they are used for privacy issues and often they are never used.

## Lighting quality for home-working spaces: a survey

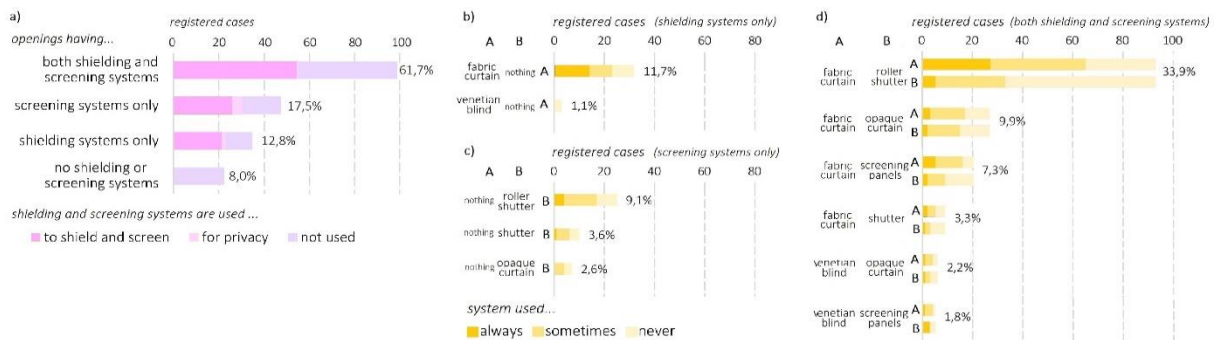

Figure 2: Type and use of shielding and screening systems.

Daylight overall evaluation - Almost all interviewees express positive evaluation about daylight, considering it as sufficient, pleasant, and well distributed; in three cases people refer about excessive daylight levels, but, considering the windowed area and the screening and shielding systems, a lack of shielding systems and a very wide windowed area (4.0 m<sup>2</sup> and 7.2 m<sup>2</sup> for two of them) emerged in these cases. Analysing answers given by people who judged daylight as insufficient, it was verified that some of them use always screening or shading systems not only for shading excessive daylight but for privacy issues too. So, since in this section, people could freely describe problems connected with daylight, a difficult in managing the incoming light emerged. However, very frequently interviewees complain about nearby buildings or protruding upper balconies which screen daylight, sometimes they complain about openings' inadequate exposure too.

Electric light description (Results in Figure 3) - In rooms equipped with only one device, suspended chandeliers and ceiling-mounted luminaires are the most common electric lighting devices (representing the 76.1% of all data), while in rooms equipped with two devices the combinations of the aforesaid luminaires with desk lamps represent the 62.1% of all cases. Generally, devices providing light at the workplace and those providing indirect light in the room are combined. Also, interviewees indicated as glaring those devices that are closer to them. As for the used lamps, most of devices are equipped with LED (52.5% and 53.4% in rooms equipped with one and two devices respectively), conversely halogen and fluorescent sources are less used; moreover, most of the devices are equipped with one electric lighting source, sometimes more sources in each device are present. Few people indicate the electric sources' colour tone and even fewer people indicate their colour rendering index, luminous flux and power, so an unawareness about the technical characteristics of the sources emerged. However, when the information is given, a prevalence of warm lights and of CRI higher than 80 is reported, while various luminous fluxes and powers are indicated.

Electric light control (Results in Figure 4) - Electric lighting devices are used most in the evening, since electric light is used when daylight is insufficient, but often they are always used during daytime too. Generally, when desk lamps are used to provide light at the workplace in the evening, another device providing indirect light in the room is used, rarely two devices providing indirect light are both used at the same time. Inquiring about the presence of automatic control systems or flux and colour variation systems, in very few cases they are reported; moreover, quite all of interviewees clearly misunderstand what an automatic control system is, confusing it with the possibility of switch on/off the light or use screening and shading systems. Only one interviewee describes an automatic control system functioning according to the time. Conversely, more people are conscious about dimming luminous flux and colour variation systems.

## Lighting quality for home-working spaces: a survey

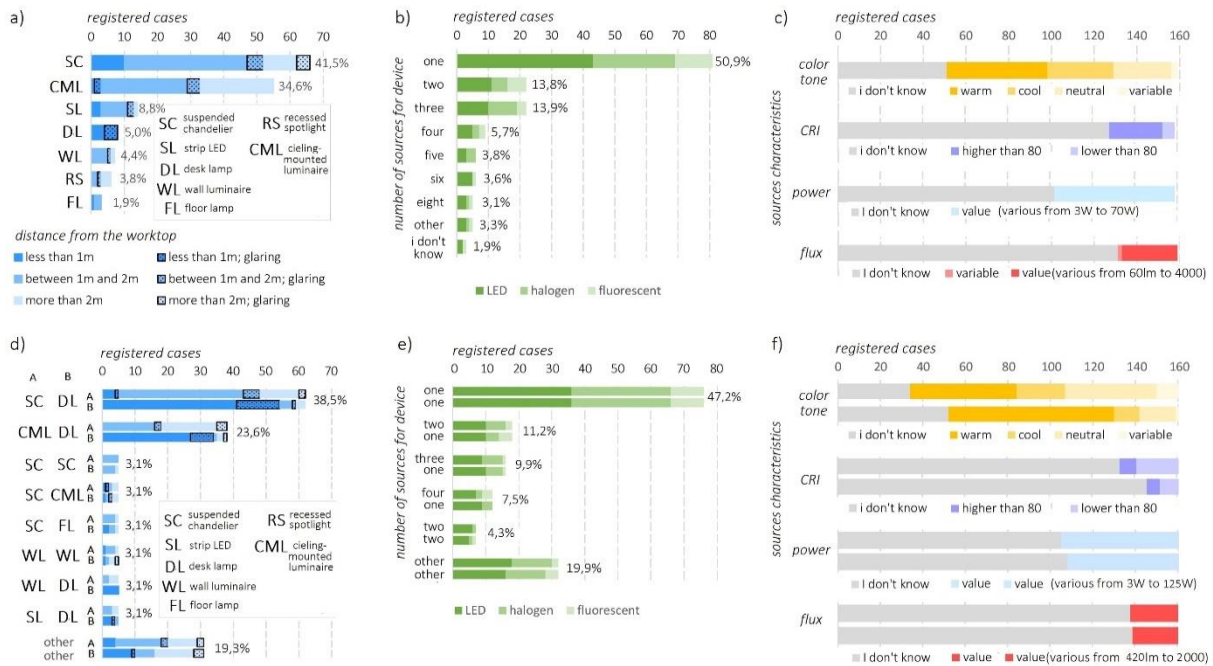

Figure 3: Types of devices (a, d), number of sources for each device (b, e) and sources' characteristics (c, f) in rooms with one and two devices.

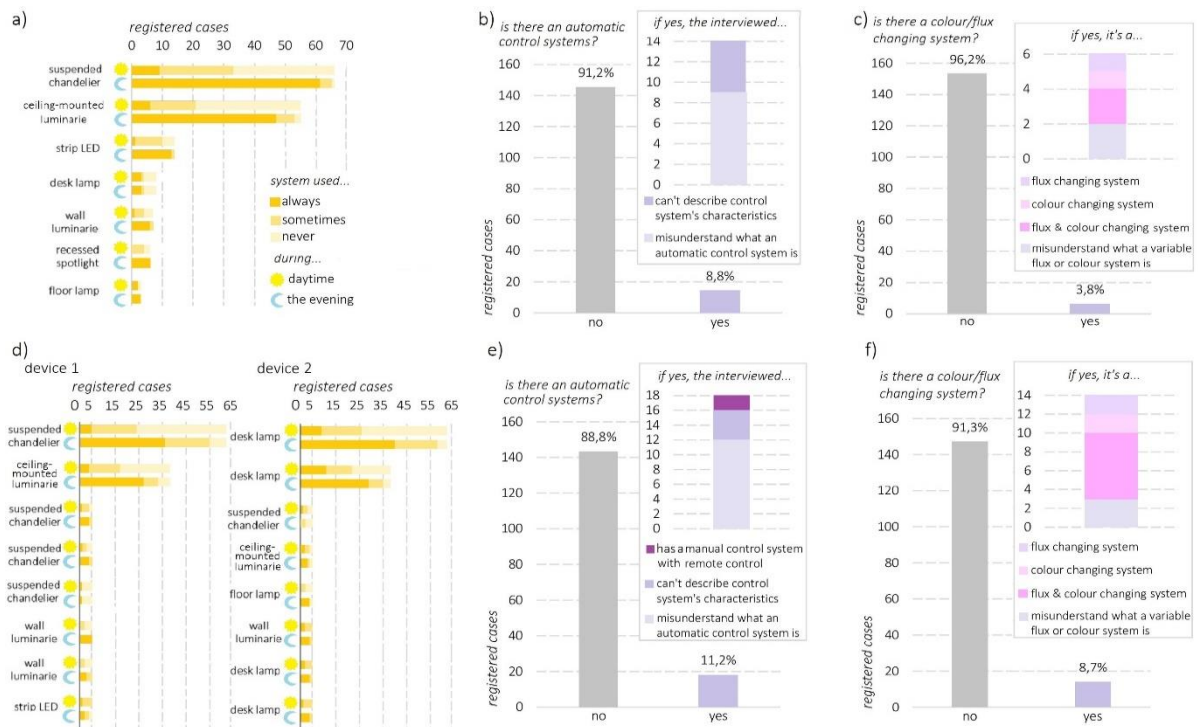

Figure 4: use of electric light (a,d), presence of automatic control systems (b,e) and color/flux changing systems (c, f) in rooms with one and two devices.

Electric light overall evaluation - The majority of the interviewees are satisfied about the electric light system, but there are unsatisfied too (their percentages are around 10% in the cases of rooms with one and two devices and around 15% with three devices). Someone proposes solutions to improve the electric light system. For example, the most common suggestions are to increase the number of electric light sources or their flux, especially at the workplace or to change their position

relative to the desk. As for the opinion about the energy costs, they are generally considered not excessive (69.2% of positive answers with one source and 67.7% with two sources), whereas people considering costs too high are 15.7% and 13.7% with one source and two sources, respectively. Finally, most of the people declare comfort issues more important than economic savings.

## **CONCLUSIONS**

The paper deals with the property of lighting in homeworking spaces, inquired through an online survey. In traditional workplaces, this would be solved by specific standard, but lighting standardization in residential contexts is impossible. Indeed, many different scenarios have been described: despite some similarities (e.g. the majority presence of one opening in each room, the majority use of two or more doors French windows, two or more doors windows, one door French windows and one door windows as opening typologies, the majority use of fabric curtains and roller shutters as shielding and screening systems, the equal presence of one or two lighting devices for each room), each interviewee has a particular home scenario different from all the others. Moreover, as emerged from the survey, people aren't completely aware of the right actions to take to improve their workplaces' lighting quality. Indeed, referring to daylight, a carelessness in positioning the workplace and difficulties in managing the incoming daylight have emerged; moreover, referring to the electric light, a complete lack of knowledge about sources' characteristics and a carelessness in choosing which type of device to buy have been observed (many interviewees refer about devices whose design don't meet their lighting needs). This demonstrates the need to make homeworkers aware about the themes connected with lighting. Given that it will be interesting to have an applicable document to solve the most common lighting issues in homeworking spaces and to spread it among people. These guidelines should be addressed to the end users and be expressed using terms and situations experienced every day, instead of technical prescription as used in standards.

## **REFERENCES**

- Caligiuri, P. M. and H. De Cieri. 2021. Predictors of Employees' Preference for Working from Home Post-Pandemic. *Business and Economic Research* 11(2): 1.
- CEN. 2011. *EN 12464-1:2011. Light and lighting - Lighting of work places - Part 1: Indoor work places*.
- Cohen, J. 2020. Mass testing, school closings, lockdowns: Countries pick tactics in "war" against coronavirus. *Science*. Online: <https://www.sciencemag.org/news/2020/03/mass-testing-school-closings-lockdowns-countries-pick-tactics-war-against-coronavirus>.
- Eurofound. 2020. *Living, working and COVID-19. COVID-19 series*. Publications Office of the European Union. Online: <https://www.eurofound.europa.eu/publications/report/2020/living-working-and-covid-19>.
- Gosling, W., M. Coppola, and K. McCarthy. 2020. *May the workforce be with you: The voice of the European workforce 2020*. Deloitte Insights. Online: <https://www2.deloitte.com/uk/en/pages/consulting/articles/voice-of-the-european-workforce-2020.html>.
- ISTAT. 2020. *Rapporto annuale 2020 - La situazione del Paese. Capitolo 3 - Mobilità sociale, diseguaglianze e lavoro*. Online: <https://www.istat.it/storage/rapporto-annuale/2020/Rapporto-annuale2020.pdf>
- Toscano, F. and S. Zappalà. 2020. Smart working in Italia: origine, diffusione e possibili esiti. *Psicologia Sociale* 15(2): 203–223.
- U.S. Bureau of Labor Statistics webpage. Online: <https://www.bls.gov/news.release/atus.t06.htm>.
- USTAT MIUR webpage. Online: <http://ustat.miur.it/>.

# The colors of light in indoor environments: Mixing daylight and electric light spectra to define a proper match

Laura Bellia<sup>1,\*</sup>, Urszula Blaszczyk<sup>2</sup>, Francesca Diglio<sup>1</sup>, Francesca Fragliasso<sup>1</sup> and Lukasz Gryko<sup>2</sup>

<sup>1</sup> Department of Industrial Engineering of the University of Naples Federico II, Naples, Italy; fr.diglio@studenti.unina.it; francesca.fragliasso@unina.it

<sup>2</sup> Department of Photonics, Electronics and Lighting Technology, Bialystok University of Technology, Bialystok, Poland; u.blaszczyk@pb.edu.pl; l.gryko@pb.edu.pl

\* Corresponding author: bellia@unina.it

## Abstract

The paper presents a simplified method to evaluate the spectral distribution of the light reaching an observer's eye in indoor environments, when daylight and electric light are integrated. The method considers both the direct component of light and that reflected by the environment, starting from the actual spectral power distribution of the sources and the spectral reflectance of the indoor surfaces. The spectral irradiances at the eye level for a simple office located in two European cities (Naples and Bialystok) were analyzed considering different mixing conditions of electric light and daylight. Then Correlated Color Temperature (CCT), distance of the chromatic point from the Planckian locus (Duv), Circadian Stimulus (CS) and Equivalent Melanopic Lux (EML) values were obtained, in order to evaluate the quality of light incident at the eye level.

**Keywords:** *color of light, daylight SPD, electric light SPD, interactions between light and materials, non-visual effects of light*

## INTRODUCTION

The color of light in indoor environments is fundamental, since it affects space perception. Moreover, the spectral distribution of light reaching an observer's eye influences not only his visual performance, but is responsible for the so-called non-visual effects: stimulation of alertness states (Lockley et al. 2006), definition of focus degree (Farley and Veitch 2001), regulation of circadian rhythms (Duffy and Czeisler 2009), modification of thermal sensations (Kulve et al. 2016), etc.

In case of electric sources, the spectral distribution, determining the color of light, can be controlled in a more or less sophisticated way based on the source technology, but, in any case, it is chosen by the designer and can be managed according to personal preferences. On the contrary, daylight spectral distribution changes continuously according to daily and seasonal cycles and depending on specific weather conditions (Bellia et al. 2020). This variability constitutes one of the quality aspects of daylight, the dynamism of which guarantees a connection with outdoor environment, beneficial for people considering various aspects.

Therefore, the integration between daylight and electric light is crucial not only from a quantitative point of view to reduce energy consumptions, but also from a spectral point of view. LED technology offers many options in this sense. Of course, to identify the proper integration strategies, the first step is to understand in which way daylight and electric light can be integrated, starting from the complex analysis of available daylight and its changeable spectral characteristics.

Another aspect to consider is that spectral distribution of light at the eye level is due not only to the primary sources (daylight and electric light) but is the result of light interactions with surfaces limiting the space. Indeed, the environment can change the spectrum of incident light in a more or less significant way, depending on the optical characteristics of surfaces. Even though some software



The colors of light in indoor environments: Mixing daylight and electric light spectra to define a proper match able to simulate the spectral interaction between light and materials are beginning to spread (Balakrishnan and Jakubiec 2019), their use is not very common, so this aspect is often neglected.

The paper deals with this complex topic, presenting a simplified method to simulate the light spectrum at the eye level determined by the interaction of daylight and electric light, considering both their direct and reflected component by using a software typically used for lighting simulations, DIALux Evo, and spectral data referred both to materials and sources.

## METHOD

The simulated case study is a simple square room, 4.0 m·4.0 m wide and 3.0 m high (see Figures 1a and 1b) in which a desk is placed. It is located alternately in two cities: Naples and Bialystok.

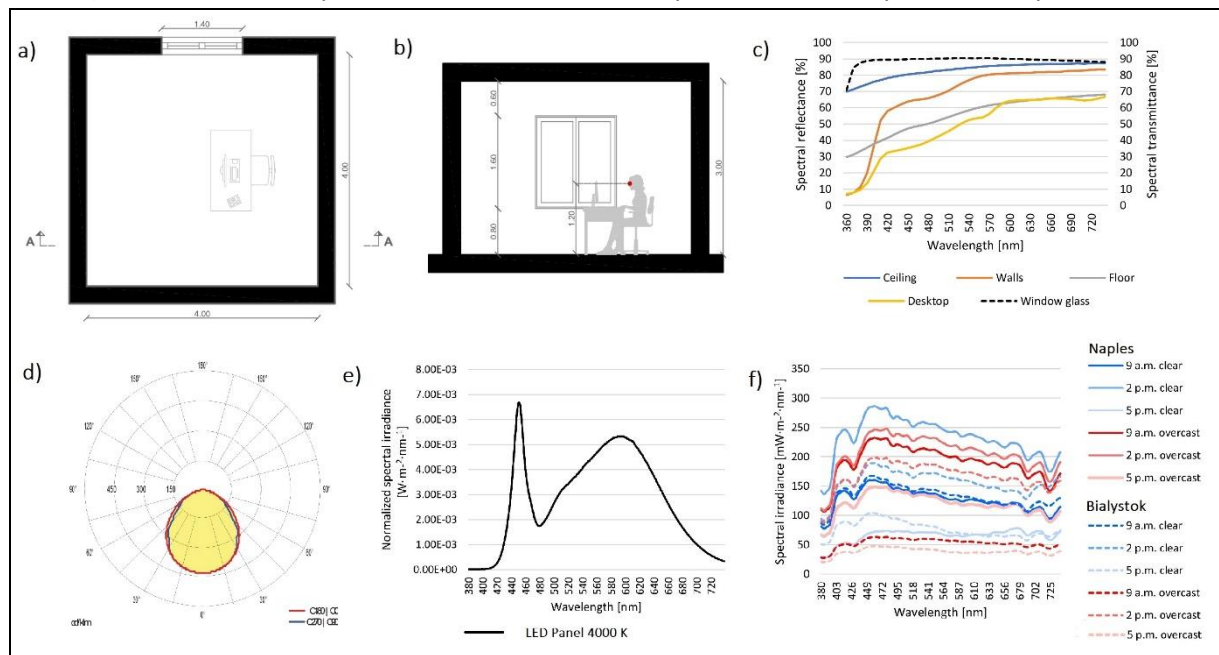

Figure 1: Plan (a) and section (b) of the room; spectral reflectance and transmittance of the surfaces (c); photometry of the LED panel (d); normalized spectral irradiance of the LED panel (e); measured daylight spectral irradiances (f).

The room is equipped with one north-oriented window 1.4m·1.6m wide. The north orientation was selected to exclude the direct sunlight, that would have made more complex the daylight evaluation. To model the optical characteristics of the space typical materials were used. Specifically, the total reflectance values (D65) attributed to the room surfaces were 55.31%, 76.37%, 84.61% and 53.36% for the floor, the walls, the ceiling and the desktop respectively. The total transmittance (D65) of the window glass was 89.19%. The correspondent spectral reflectance and transmittance values are reported in Figure 1c. The room was equipped with 2 LED panels characterized by a 4000 K CCT, a 4280 lm luminous flux, the photometry represented in Figure 1d and the normalized spectral power distribution represented in Figure 1e. The space was modeled in DIALux Evo, in which a horizontal calculation surface corresponding to the desktop and a calculation point at the eye level were set. As for daylight, it was decided to model the space on the 25<sup>th</sup> of March (a date around the spring equinox), in three different moments of the day (10:00, 14:00 and 17:00 as typical working hours) both under overcast and clear sky, in order to obtain different mixes of daylight and electric light. To simulate daylight from a spectral point of view, a specific spectrum was needed for each simulated condition. The used spectra were inferred from a database acquired by authors in a previous

The colors of light in indoor environments: Mixing daylight and electric light spectra to define a proper match research (Bellia et al. 2020), aiming at evaluating the spectral variations of daylight in two European locations (Bialystok in Poland and Naples in Italy). The cited study presented results of a measurements campaign of spectral irradiances. Measurements were performed open-air from March 2019 to September 2019, related to the horizontal plane and to four vertical planes oriented according to the main cardinal points, and they were repeated in different moments of the day from 8:30 up till 18:30, under several weather conditions. For this specific application, spectral data measured around the 25<sup>th</sup> of March and referred to the two cities, the north vertical plane, the previously mentioned times of day and overcast and clear sky conditions were selected. The daylight spectra correspond to CCTs ranging from 5479 K to 6335 K in Naples and from 4568 K to 6234 K in Bialystok. They are represented in Figure 1f.

Starting from all the mentioned characteristics of light and space, the spectrum of the light reaching the eyes of a person seating at the desk was obtained as it follows.

Step 1- Direct and reflected components of the illuminance at the eye level due to daylight were calculated. To do that, daylight simulations were repeated, for both cities in the mentioned times of day, with clear and overcast sky. The average illuminance at the work-plane ( $E_{wp,dl,tot}$ ) and the illuminance at the eye level ( $E_{eye,dl,tot}$ ) were calculated assigning specific optical characteristics to all materials. In this way the contribution of both the direct daylight coming from the window and the component reflected by the room surfaces was considered. Then the simulations were repeated by modelling all the surfaces as completely absorbent, to evaluate exclusively the direct component due to daylight both at the work-plane ( $E_{wp,dl,dir}$ ) and at the eye ( $E_{eye,dl,dir}$ ). The difference between the global and the direct component of illuminance provides the reflected one, due to the interaction between daylight and surfaces calculated at the work-plane ( $E_{wp,dl,refl}$ ) and at the eye ( $E_{eye,dl,refl}$ ).

Step 2 – The same procedure was applied to electric light. Starting from  $E_{wp,dl,tot}$  values, the electric light output necessary to integrate daylight to obtain a task illuminance equal to 500 lx (average illuminance prescribed by the European Standard for offices (CEN/TC 169, 2011)) was calculated for each simulated daylight condition. Then for each light output the electric light simulations were performed twice: once attributing to the surfaces their specific reflectance values and then considering the space as completely absorbent to obtain the direct and reflected component of the illuminance both at the work-plane and at the eye level ( $E_{wp,el,dir}$ ,  $E_{wp,el,refl}$ ,  $E_{eye,el,dir}$  and  $E_{eye,el,refl}$  respectively).

Step 3 – We assumed that the reflected component of illuminance at the eye due to daylight ( $E_{eye,dl,dir}$ ) was the sum of 4 components due to the reflection from the ceiling, walls, floor and desk ( $E_{eye,dl,refl,i}$ ). To understand the incidence of each element in determining the reflected component of the illuminance, a camera was set in Dialux Evo at the same position of the observer's eye and the corresponding view was obtained. Through a CAD software the percentage areas occupied by each element of the space (ceiling, walls, floor and desk) in the field of view ( $A_{\%,i}$ ) was inferred. The  $E_{eye,dl,refl,i}$  values were obtained as a product of the reflected component of daylight ( $E_{eye,dl,dir}$ ) and the  $A_{\%,i}$ , for each daylight condition. The same process was repeated for electric light.

Step 4 - The spectrum referred to the direct and reflected components of daylight was obtained. As for the direct one, for each time of day and sky condition, the measured spectra were multiplied by the spectral transmittance of the window glass, and then scaled according to the  $E_{eye,dl,dir}$  in order to obtain the spectral irradiance at the eye level corresponding to the illuminance values calculated in DIALux Evo. As for the reflected component, the measured spectra were multiplied for the spectral transmittance of the glass, for the spectral reflectance of each element of the space in turn (ceiling, walls, floor and desk) and then scaled according to the  $E_{eye,dl,refl,i}$ .



The colors of light in indoor environments: Mixing daylight and electric light spectra to define a proper match

Step 6 –The same procedure as for daylight, excluding the effect of window, was applied for electric light.

Step 7 - Finally, the global spectrum at the eye was evaluated by summing the 10 previously obtained spectra (one direct and 4 reflected components for both electric and natural light).

Starting from the spectral irradiance at the eye level the following values were calculated: CCT, Duv, Circadian Stimulus (CS) evaluated according to the model of Rea et al. (Rea et al. 2005) and the Equivalent Melanopic Lux (EML) evaluated according to the Well Building Protocol 2018 v1 (International WELL Building Institute, 2019).

## RESULTS

Figure 2 reports daylight and electric light illuminance values at the work-plane calculated for both Naples (Figure 2a) and Bialystok (Figure 2b). To maintain the global illuminance at work-plane almost steady and around 500 lx, the balance between daylight and electric light is varying since daylight availability changes depending on the time of day, the sky condition and the geographical location. This determines the corresponding contribution of light at the eye level that can be observed in Figure 3. The global illuminance at the eye generally follows a decreasing trend during the day, changing the ratio between the vertical and the horizontal illuminance, due to the different daylight distribution in the space. Moreover, it must be noticed that for this specific space configuration, the direct and reflected components of daylight can be comparable, whereas the reflected electric light component is always higher than the direct one. This demonstrates the huge impact of the space in determining the quality of light reaching an observer’s eye.

Data reported in Figure 3 find confirmation in Figure 4, in which the spectral irradiance at the eye level obtained according to the described method are represented. In general, a slightly different shape of the spectrum can be observed for the two cities, since in Bialystok the peak around 440 nm due to electric light incidence is more stressed, whereas for Naples from around 480 nm on, the daylight trend is more recognizable. This depends both on the different daylight spectra and the different percentage contribution of electric light. Of course, in both cities under overcast sky conditions and especially at 5 p.m., it can be seen that the shape of the spectrum is more influenced by the presence of electric light.

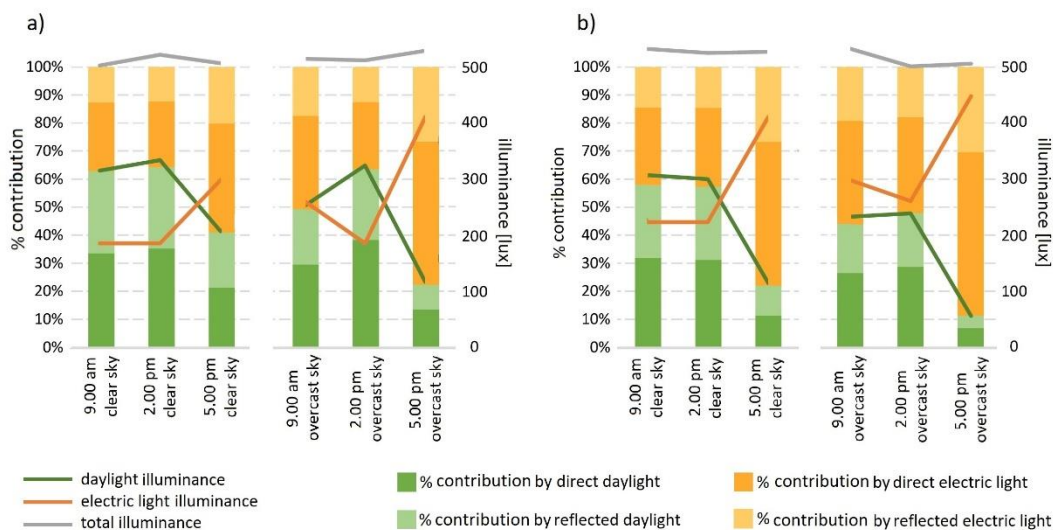

Figure 2: Illuminance values and percentage contribution of direct and reflected components of daylight and electric light illuminances at the work-plane in Naples (a) and Bialystok (b).

The colors of light in indoor environments: Mixing daylight and electric light spectra to define a proper match

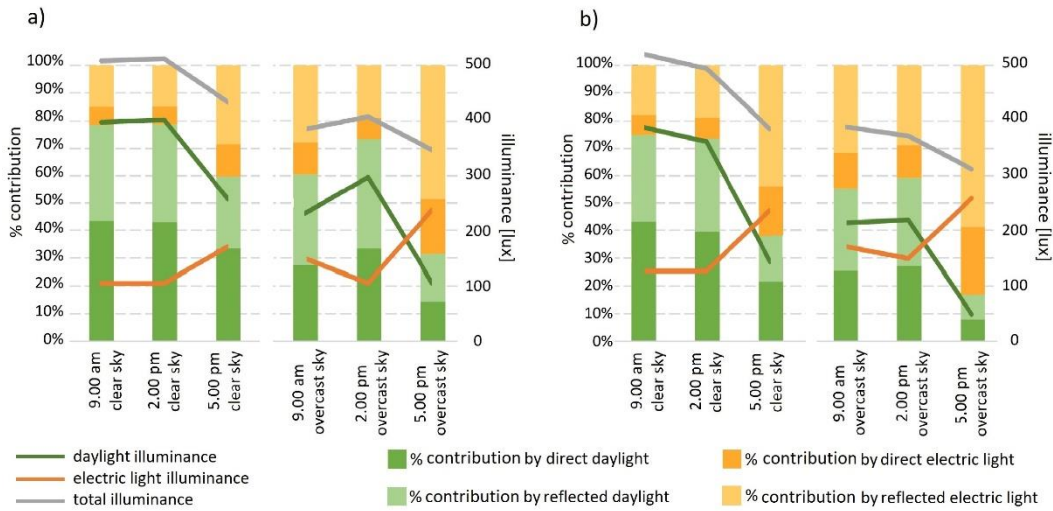

Figure 3: Illuminance values and percentage contribution of direct and reflected components of daylight and electric light illuminances at the eye level in Naples (a) and Bialystok (b).

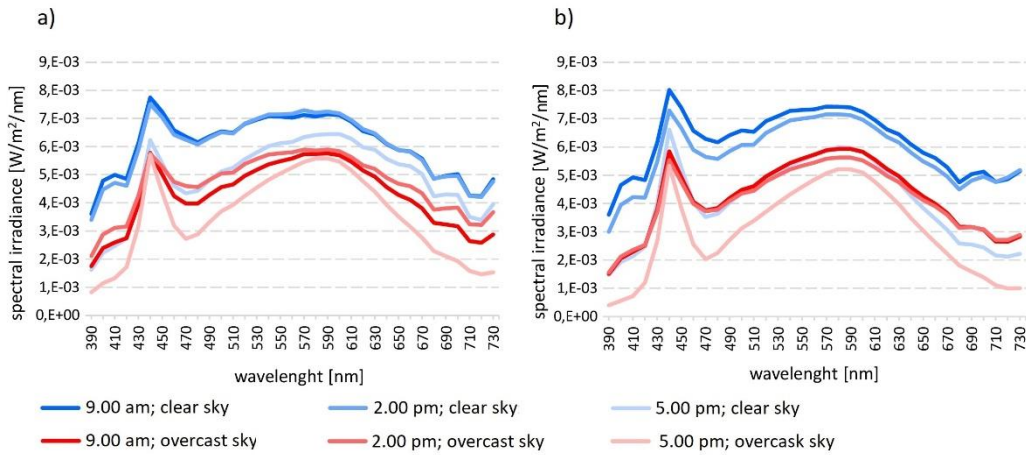

Figure 4: Spectral irradiances at the eye level in Naples (a) and Bialystok (b).

Sky	Time	CCT		Duv		CS		EML	
		N.	B.	N.	B.	N.	B.	N.	B.
Cl.	9 a.m.	5205	5150	-0.002	-0.002	45	45	477	482
	2 p.m.	5070	4694	-0.001	-0.002	45	42	471	436
	5 p.m.	4456	4551	-0.001	-0.003	37	36	357	317
Ov.	9 a.m.	4619	4480	-0.002	-0.001	36	35	326	318
	2 p.m.	4802	4546	0.000	-0.001	38	35	358	310
	5 p.m.	4190	3965	-0.002	-0.003	30	26	263	221

Table 1: CCT, Duv, CL<sub>A</sub>, CS and EML values calculated for clear (Cl.) and Overcast (Ov.) sky conditions in Naples (N.) and Bialystok (B.).

Table 1 reports CCT, Duv, CS and EML values referred to spectra in Figure 4 for both cities. It can be observed that CCT at the eye level - as forecasted - is always between those of electric light and daylight and generally slightly lower for Bialystok than for Naples. It decreases as a function of the time of day for both cities. The Duv is always comprised between -0.003 and 0.000. Finally, as for the values referred to circadian effects of light, it can be noticed that they are always slightly lower for Bialystok and decrease during the day for both cities.

## CONCLUSIONS

The paper presented a method to evaluate the spectral distribution of light incident at an observer's eye in indoor environments considering both direct and reflected components of daylight and electric light. It was presented how complex the correct simulations of spectral characteristics of light are, even when simplified calculation approaches are adopted. We also showed that variable influence of daylight and electric light is fundamental in integrated evaluation of its quality. The future steps of the research will be the following 1) the validation of the simplified method through the comparison with more complex calculation software and on field measured data; 2) the repetition of simulations by changing the characteristics of the case study (spectral reflectance of materials, luminaires photometry, luminaires SPD) and for other daylight conditions. That will allow on the one hand to understand the reliability degree of the method and, on the other hand, to obtain a database useful to understand if the method can be furtherly simplified. For example, it could be verified if in the case of neutral environments, the effect of the surfaces in reflecting light can be neglected since the variation in terms of spectrum shape could be not very relevant. Based on this concept, a simplified calculation method could be applied, even with a satisfying accuracy of results.

## REFERENCES

- Balakrishnan, P. and J. A. Jakubiec. 2019. Spectral Rendering with Daylight: A Comparison of Two Spectral Daylight Simulation Platforms. In *BS2019*. Rome, Italy, 2019: 2-4.
- Bellia, L, U. Błaszczak, F. Fragliasso and L. Gryko. 2020. Matching CIE Illuminants to Measured Spectral Power Distributions: A Method to Evaluate Non-Visual Potential of Daylight in Two European Cities. *Solar Energy* 208: 830–58.
- Duffy, J. F. and C. A. Czeisler. 2009. Effect of Light on Human Circadian Physiology. *Sleep Medicine Clinics* 4 (2): 165–77.
- Farley, K. M. J. and J. A. Veitch. 2001. *A Room with a View: A Review of the Effects of Windows on Work and Well-Being*. Institute for Research in Construction, National Research Council Canada.
- I.W.B.I. International WELL Building Institute. Circadian Lighting Design. 2019. Online: <https://standard.wellcertified.com/light/circadian-lighting-design>.
- Kulve, M. T., L. Schellen, L. J. M. Schlangen and W. D. van Marken Lichtenbelt. 2016. The Influence of Light on Thermal Responses. *Acta Physiologica* 216 (2): 163–85.
- Lockley, S. W., E. Evans, F. A. J. L. Scheer, G. C. Brainard, C. A. Czeisler and D. Aeschbach. 2006. Short-Wavelength Sensitivity for the Direct Effects of Light on Alertness, Vigilance, and the Waking Electroencephalogram in Humans. *Sleep* 29 (2): 161–68.
- Rea, M. S., M. G. Figueiro, J. D. Bullough and A. Bierman. 2005. A Model of Phototransduction by the Human Circadian System. *Brain Research Reviews*. 2005, 50.2: 213-228.
- CEN/TC 169. 2011. Light and Lighting - Lighting of Work Places - Part 1 : Indoor Work Places.

# Design Guidelines for Light Interfaces of Home Appliances

Hyeonju Park <sup>1</sup> and Hyeon-Jeong Suk <sup>2</sup>

<sup>1</sup> Department of Industrial Design, KAIST; hopedt2@kaist.ac.kr

<sup>2</sup> Department of Industrial Design, KAIST; color@kaist.ac.kr

\* Corresponding author: color@kaist.ac.kr

## Abstract

Home appliances can cause light pollution disturbing people's night life or sleep in the house. Indoor light pollution has not been in attention, even though outdoor light pollution has been regulated through numerous restrictions. In this paper, we carried out a video-based survey to explore the light interfaces surrounding people in their homes at night and collected their opinions to develop design guidelines for designing light interfaces. We recruited 22 participants and collected 117 videos. Each participant recorded 1-minute videos for light interfaces in their living spaces at night. While recording the video, they spoke their opinion about the light interface. Throughout the collected videos, we conducted a thematic analysis and derived design guidelines for light interfaces. We hope that the home appliance manufacturers and industrial designers consider these five design guidelines, thereby serving users to enjoy their night life without any lighting disturbance and understand information from light interfaces.

**Keywords:** *Light Interface, Indoor Light Pollution, Home Appliances, Design Guidelines*

## INTRODUCTION

As we all are surrounded by lights anywhere all the time, light pollution can occur along with our life. Given attention by astronomers and ecologists, outdoor light pollution has been regulated through several restrictions. At first, The Czech Republic outlawed prohibiting light pollution in an exterior field in 2002 (Clarke 2002). According to the law, all light fixtures are shielded to ensure light goes only in the intended direction for reducing bothersome glare. Whereas indoor light pollution has not been addressed yet.

A light interface is composed of small lights which are applied as the interaction medium between the products and users (Park and Suk 2020). Small point lights are widely used for communication purposes in the design of home appliances (Harrison et al. 2012). Since the majority of home appliances embed light interfaces, we can find numerous lights which cause indoor light pollution in our living space.

Bright lights cause visual discomfort resulting in disturbance of people's night life. Moreover, they affect human circadian rhythm and disrupt sound sleep (Burgess and Molina 2014). Harvard Health Publishing (2020) stated that blue light powerfully suppresses the secretion of melatonin more than other lights. Hence, for pleasant and healthy nights, research to control indoor light pollution must be conducted.

Recently studies have been conducted on exploring creative ways to convey the product's information to users intuitively. For example, Harrison et al. (2012) focused on light behaviors and gathered richer expressions for effective communication. As a cornerstone for studies on indoor light pollution, Park and Suk (2020) carried out an online survey and investigated existing light interfaces of the premium products. However, the study did not come up with practical design guidelines to prevent indoor light pollution. This research aimed to develop design guidelines for light interfaces. We gathered the user experience data through a video-based survey and figured out design elements that affect user experience with light interfaces. As the result, we derived five design guidelines that designers can consider when they embed light interfaces in their products.

## **METHOD**

### **Video-based Survey**

To observe the light interfaces surrounding users and collect their opinions about the light interfaces, a video-based survey was conducted with 22 participants in November 2020. All participants were Korean and 12 of them were women. We recruited participants in a wide range of ages from 19 to 51 (mean=33.24, SD=11.92) not to consider the effect of aging on the responses. Each participant submitted 2, 4, or 8 of 1-minute videos about the light interfaces in his home. All were rewarded with KRW 5000, 10000, or 20000 depending on the number of videos they submitted.

We asked participants to record the scene of a light interface in their living space while speaking the answers to the below questions (see Figure 1).

- What is the purpose of the light interface?
- Are you satisfied/unsatisfied with the light interface?
- What part of the light interface do you want to improve?

In addition, we produced three sample videos and showed participants to help them understand the protocol. The videos included various contents for participants not to have a bias against the video theme.

Compared to an ordinary survey or interview, a video-based survey allowed us to recognize what light interfaces exist in people's living space through the scene of the videos. Survey questions guided participants to talk about their experience with light interfaces. Hence, a video-based survey was the optimal way to collect the information about light interfaces surrounding users and user's opinions about the experience with the light interfaces.

### **Thematic Analysis**

After participants completed the survey, we reviewed all videos, captured the scene of each light interface, and took a script of the participant's words. Then, we figured out the product, purpose of the light interface, and color of the light interface. For a thorough analysis about participant's opinions in light interfaces, we conducted a thematic analysis as shown in Figure 2. Each video had been coded by the following features.

- Reason for dissatisfaction
- Reason for satisfaction
- Demand to manufacturers
- User's solution

For the thematic analysis, one of the researchers conducted open coding and developed an initial code scheme. The initial code scheme was revised to avoid overlap between codes and make explicit boundaries (Attride-Stirling 2001). After all researchers consented to the revised code scheme, we conducted closed coding. The final codes were clustered by themes, reviewing the whole data. The themes helped us to understand what design elements affect the user experience. And we adopted them in deriving five design guidelines about light interfaces.

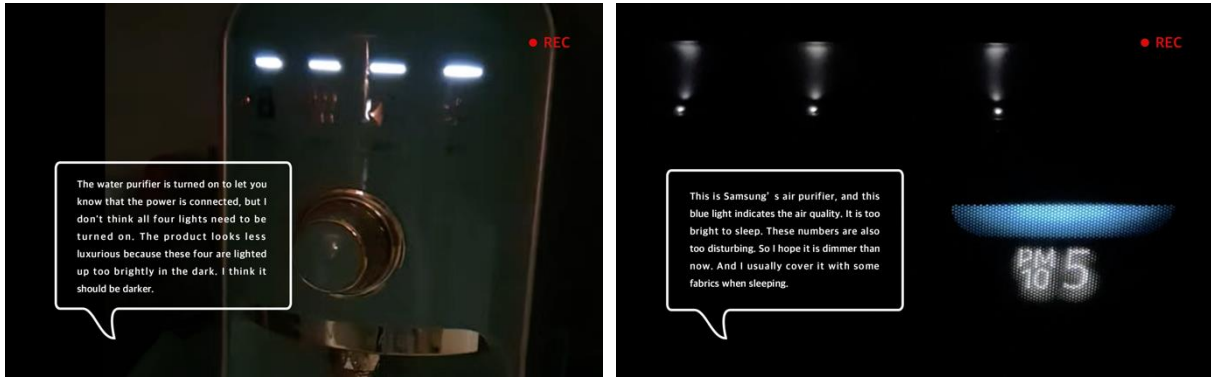

Figure 1: Participants submitted videos with the scene of light interfaces, and the answer to survey questions.

Video No.	Scene	Product Category	Product	Script	Purpose of the light interface	Color of the light interface	Reason for unsatisfaction	Reason for satisfaction	Demand to manufacturers	User's solution
P2_4		Consumer Electronics	TV	It's a light that tells whether the TV is off or on. It's currently red because the TV is off. I hope the luminance drops a bit when it's dark. But it doesn't bother me that much actually.	On	Red			Reduce the brightness	
P2_5		Major Appliances	Air Conditioner	It's like a display that shows the current temperature of the air conditioner. When I sleep, the light is reflected up or the other side of the room. So I hope it turns off completely in the dark room.	Operating Mode	White	Glow / Glare		Turn off in dark	
P2_6		Electronic Gadget	Power Strip	It's a signal that the power strip is on. I hid it behind my bed because I thought it would bother me when I was sleeping. I think it would be better if the light is off at all.	On	Blue			Turn off	Block
P2_7		Electronic Gadget	Power Strip	This light shows that the power strip under the desk is currently on. When I lie on the bed, the light is actually blocked by many chargers. So, I'm not disrupted by it much.	On	Red				Block
P3_1		Major Appliances	Water Purifier	The water purifier is turned on to let you know that the power is connected, but I don't think all four lights need to be turned on. The product looks less luxurious because these four are lighted up too brightly in the dark. I think it should be darker.	Menu	White	High brightness, Many numbers of the lights		Reduce the number of lights, Reduce the brightness	

Figure 2: We figured out the basic information of the light interfaces. And the participant's opinions were coded into four features.

## RESULTS

Through the video-based survey, 117 videos about light interfaces were gathered. According to the scenes and scripts of the videos, we grasped how users understand the purpose of light interfaces, how they feel about light interfaces, what components drive that emotion, and what is needed improvements for an adorable experience in using light interfaces.

The collected videos included diverse products regardless of major appliances, small appliances, consumer electronics, controllers, or electronic gadgets. Since we asked participants to record the video in their living space, we were able to observe products that existed in their homes at night. A temperature controller, an electronic blanket, a power strip, a Wi-Fi router, and an air purifier were

mainly reported. The most frequently reported products were a temperature controller and an electronic blanket because they were usually arranged near participants in winter when we conducted the study.

Following the scripts of participants, the purpose of a light interface was divided into three categories. 1) It showed the current state of the products. Light interface indicated whether the product was on or off, what the mode was operating, and how well it was connected to other products. 2) It displayed information about the external environments such as time and sensor measuring data. 3) Light interface indicated a menu or it was a button which users made an input. But a few light interfaces were not understood by users. *P5* mentioned that he could not catch the purpose and meaning of the light interfaces on the temperature controller in his home.

We conducted a thematic analysis through coding the scripts into four features. Table 1 shows the final code scheme for the thematic analysis. All codes were clustered by themes like luminance level, hue, or communication. Then, the five design guidelines were derived from the themes.

Feature	Code	
<b>Reason for dissatisfaction</b>	High brightness	Glow / Glare
	Located near	Vivid color
	Too many lights	Always on
	Large size	No settings for customizing
	Aggressive light animation	
<b>Reason for satisfaction</b>	Acceptable brightness	Nuanced white color
	Located far	Possible to get information
	Not direct exposure	Possible to find in the dark
	Small size	Settings for customizing
	Turn on when it needed	
<b>Demand to manufacturers</b>	Reduce the brightness	Remove light animation
	Change the position of the light	Change light animation
	Reduce the number of lights	Remove glare
	Reduce the size	Change to undertone color
	Turn off	Always turn on
	Turn off in the dark	Enlarge the size
	Turn on when it needed	Add settings for customizing
<b>User's Solution</b>	Change the direction	Suppress
	Block	Unplug
	Not glance	

Table 1: We developed a code scheme into four features after coding all scripts. Those codes were clustered by themes that were applied to the design guidelines for light interfaces.

### **The luminance of the light interfaces should be in proportion to the ambient brightness**

Numerous participants mentioned that they were disturbed at night because of excessively bright light interfaces. *P8* said that he could not sleep at night because the light interface of the air purifier was extremely bright in his bedroom at night. Thus, *P8* asked manufacturers to reduce the brightness of the light. In addition, we found that users blocked light interfaces to avoid annoyance by their high brightness. *P21* clogged the light interfaces of his electric fan for his sound sleep. For a similar reason, *P12* rotated his Bluetooth speaker so that its light radiated toward the wall. Meanwhile, an acceptable brightness was stated as the reason why participants were satisfied with light interfaces. Hence, the luminance of the light interfaces is the critical element for a better user experience with light interfaces. It should be restricted according to the ambient brightness.

### **The light interface should convey information intuitively**

Since light interfaces are a medium of communication between users and products, a few participants expressed satisfaction with information that was available from the light interfaces. *P13* was contented with his air purifier because the color of the light interface indicated the air quality of the room. Also, *P18* said that the light interface of a wall pad was valuable because it let him find the emergency button even in the dark. The light interfaces are useful in the dark as a communication channel. As the most important role of interfaces is conveying product information to users, designers must explore the effective way for communication.

### **Light's hue should be neutral and be harmonized with the product's CMF**

Many light interfaces used vivid colors such as red, blue, or yellow-green. Numerous participants reported that they hated light interfaces with vivid color because its color had disrupted their night life. *P3* disliked the red light of a cutting board sterilizer because it created a terrifying atmosphere in his house. Whereas he liked the nuanced white color of his audio speaker because it was balanced with the product's CMF (Color, Material, and Finishing). Moreover, *P7* wanted to change the color of his microwave oven from yellow-green to an undertone color. Thus, designers should apply a neutral light not to disrupt the user's attention.

### **The glare should be avoided**

When the light spreads to unintended areas, it causes glare or glow issues. *P2* said that the light switch was lit in acceptable brightness but it had a glow around the target shape of the interface. So, he could not figure out the shape of the light interface. *P16* also mentioned that the light interface of the rice cooker had a glare. He asked to turn the light off on the area where is not the lock button. Considering the shape and the area of light interfaces, designers should remove glare or glow for users to recognize the light interfaces.

### **In the event of inevitable technical issues, users should be able to turn off the light interfaces**

Even though designers consider guidelines thoroughly, the implementation is not easy because of practical issues such as technical limitations or cost increase. Fortunately, even though the light interface did not meet all the conditions for an adorable user experience, users had been contented with the light interfaces which had a night mode or settings for customizing. For example, *P10* was satisfied with his excessively bright air purifier, because it allowed him to turn it off through the night mode.



## **DISCUSSION**

In this study, we explored light interfaces through a video-based survey and collected user's opinions about the experience with light interfaces in their living space. To understand the data thoroughly, we conducted a thematic analysis to extract codes and themes. As a result, we derived five design guidelines for light interfaces.

The design guidelines would help home appliance manufacturers and designers to consider a user experience rigorously when they embed light interfaces in their products. When light interfaces are harmonized with the external environment and perform their role of communication channels completely, users can both lead their night life and understand the information of light interfaces intuitively.

Even though five design guidelines indicate critical design components for an adorable user experience about light interfaces, adaptation in the design process can be concerned because the borderline of each guideline might be varied by designers. Hence, further researches should be conducted in estimating a threshold that can be applied to assess the design of light interfaces in terms of user experience.

## **ACKNOWLEDGMENTS**

This work was supported by the National Research Foundation of Korea (NRF-2018R1A1A3A04078934) and the BK21 plus program through the National Research Foundation (NRF) funded by the Ministry of Education of Korea (NO.4120200913638).

## **REFERENCES**

- Attride-Stirling, J. 2001. Thematic networks: an analytic tool for qualitative research. *Qualitative research* 1(3): 385-405.
- Clarke, T. 2002. Day one for light pollution law. *Nature*. May 31. <https://doi.org/10.1038/news020527-14> (accessed July 29, 2021).
- Harrison, C., J. Horstman, G. Hsieh, and S. Hudson. 2012. Unlocking the expressivity of point lights. In: *Proceedings of the SIGCHI Conference on Human Factors in Computing Systems*: 1683-1692.
- Harvard Health Publishing. 2020. Blue light has a dark side. *Harvard Medical School*. July 7. <https://www.health.harvard.edu/staying-healthy/blue-light-has-a-dark-side> (accessed July 29, 2021).
- Park, H., and H. J. Suk. 2020. Thoughts and Approaches toward the Guideline of Light Interface of Home Appliances. In: *2020 17th China International Forum on Solid State Lighting and 2020 International Forum on Wide Bandgap Semiconductors, China (SSLChina: IFWS)*: 174-179. IEEE.

# Colour Performance Evaluation for LED Simulator Technology

Jinyi Lin<sup>1</sup>, Keyu Shi<sup>1</sup>, and Ming Ronnier Luo<sup>1,\*</sup>

<sup>1</sup> State Key Laboratory of Modern Optical Instrumentation, Zhejiang University; Hangzhou, China

\* Corresponding author: m.r.luo@zju.edu.cn

## Abstract

A computer system to achieve appearance reproduction for supply chain was introduced in the last AIC conference. It is named LED Simulator. The present paper introduced the hardware of the system, colour management workflow and the development of the key component on display characterisation, and stray light colour correction. Finally, a series tests were conducted to show the system performance in terms of precision and accuracy.

**Keywords:** *Total appearance, spectral tunable LED lighting, LED Simulator,*

## INTRODUCTION

Currently, LED Simulator is applied in the textile industry as an appearance communication tool in the supply chain including 3 stages: colour exploration, product design and development and manufacturing (He et al. 2020; Luo et al. 2021). A brief account of each stage is given below. The journey starts in exploration when designers research trends that translate into fashion concepts. The outcome is colour palette, a collection of colours used for all garments. Colours identified are documented by referencing physical specification systems such as Pantone. Stage 2 is product design and development. Digital images generated in CAD software were used to create garment designs as choices for merchandise plans. As part of an editing process, merchandisers review these images either on displays or on digital prints to determine which designs will be included in the final product line. The final stage is manufacturing. It requires to produce small size colour standard from dye lab at the mill together with a production dyeing recipe. Many factors can confound the colour matching process. The biggest barrier to perform colour matching involves “Total Appearance.”

Many issues are raised in the above cycle. In the exploration stage, designers can only focus on colour appearance, excluding attributes such as texture, gloss, and translucency that make up the “Total Appearance” of a colour. In the second stage, specifiers matching a colour on a fabric with significant texture to a colour standard with no texture requires subjective decisions by the product developers and colour engineers. Finally, the manufacturers involve cross-media colour reproduction to match the colours in the palette on the fabrics on a display screen to be used in the garments. There is a great need to have experienced work force.

The above cycle between the mill and the product developer might involve many iterations before an approval is issued. With the above in mind, LED Simulator is specially designed to overcome the problems by offering total appearance in different stages. An introduction is given below in terms of hardware and colour technology.

### **System Hardware**

Figures 1a and 1b show the hardware of the system for a real system and a top view respectively.



(a) From view of the system

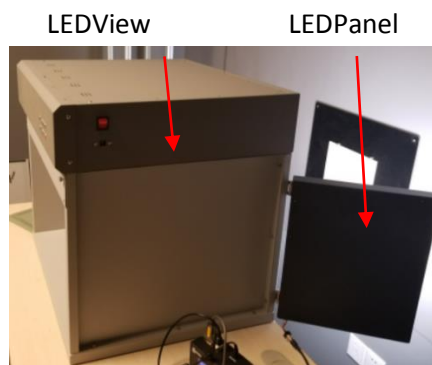

(b) Side view of the system

It includes a viewing cabinet (LEDView) in front (Figure 1a), and two light panels (LEDPanel) in the back (Figure 1b). Both are spectral tunable multiple-LEDs lighting systems. The former provides a standard viewing conditions like typical viewing in a lab (capable of accurately simulating CIE daylight and A illuminants) and the latter forms a display system, for which two LED Panels including red, green and blue lights illuminate a piece of white substrate such as textile, coating, plastic, etc., having a 45°/0° geometry). Hence, the coloured object (or virtual sample) viewed from a window in the back of the LEDView truthfully presented not only the colour but also the texture of a desired product. There is also a dark chamber in the back to avoid the interference of ambient lighting. The display system is based upon the colour mixing theories of additive (mixing coloured lights) and subtractive (reflecting colours from surfaces). The system supplied a wide range of desired uncoloured substrates, and windows.

The system was designed not only to fulfill the three-stages of colour applications in the supply chain but also to be used for academic research to investigate the total appearance perceptions, including colour, texture, gloss and translucency.

**COLOR MANAGEMENT WORKFLOW**

The colour management workflow is shown in Figure 2 including four stages. The data input and output are based on CIE Colorimetry (CIE 2018), including spectral power distribution (SPD), colorimetric observer, XYZ, CIELAB, CAM02-UCS (Luo et al. 2006).

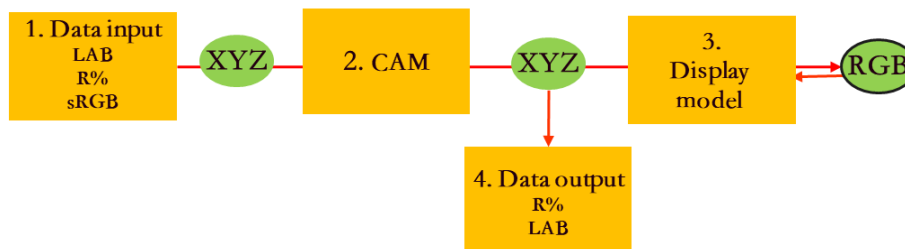

Figure 2: The colour management workflow of the system.

Step 1 is colour data input including CIELAB coordinates, reflectance data (400-700 nm with 10 nm interval). All of them are first transformed to the XYZ values under a particular illuminant/observer condition. At the same time, LEDView will illuminate corresponding illuminant at a specified illuminance (say 800 lux unit) for observing. Step 2 relies on a reliable colour appearance model such

as CAM02-UCS to transform data between different illuminants. In step 4, the final XYZ values will be converted to the RGB signal to produce virtual samples. If the colour is unsatisfactory by the designers, the colour can be adjusted via the colour selection software 'ColourWay' (see later). Finally, the final colour will be stored in terms of CIELAB, or R%, which should ensure they can be manufactured.

Step 3 requires a characterization model to transform XYZ to LED Panel's RGB values, or vice versa. The conventional look-up-table (LUT) model [5] was used to display the virtual colours. A 9x9x9 LUT with equal interval in  $L^*$  space for each channel is used. Figures 3a and 3b show the 729 colours used in the LUT of the display in  $a^*b^*$  and  $L^*C^*_{ab}$  planes (see the black dots). It can be seen that the samples from Munsell (Kang 1997), NCS (Khuni 2002), DIN (Hård 1996) atlases are well within the boundary of colour gamut. These samples were measured by a single spectrophotometer at about the same period at the specular excluded measuring condition.

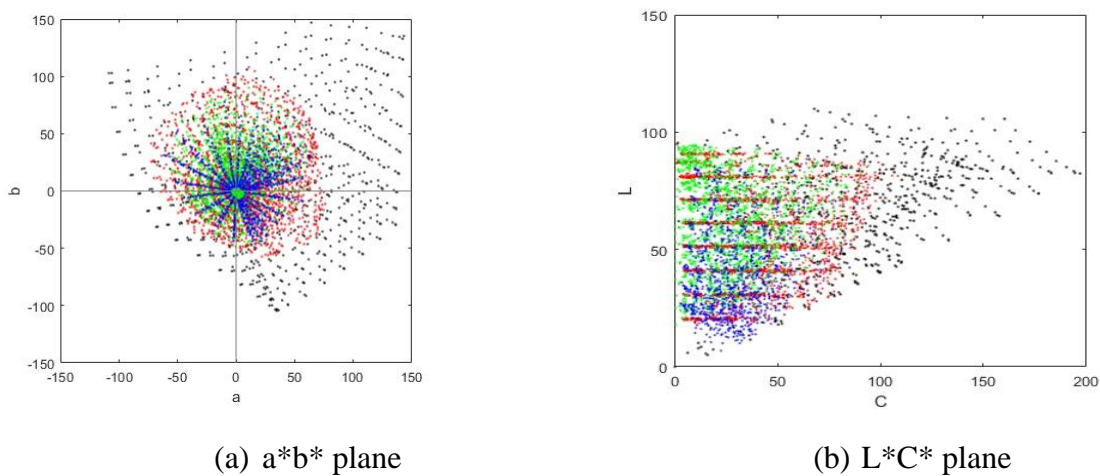

Figure 3: The colour gamut (black dots) of the virtual display in a)  $a^*b^*$  and b)  $L^*C^*_{ab}$  planes. The red, green and blue dots represent the data in Munsell, NCS and DIN atlas, respectively.

Figure 4 shows the 'ColourWay' software. There are three parts. The left colour wheel shows a hue circle arranged like a NCS hue circle [8]. Once the hue is selected by mouse clicking, it moves to the middle part arranged similar to Munsell Value/Chroma (Kang 1997). When a colour is selected, it is located in the centre within a range of CIELAB  $a^*b^*$  region (CIE 2018). There is a scroll bar on the right side to adjust lightness ( $L^*$ ). There are control buttons to increase or reduce the colour region, to move colour in  $L^*$ ,  $a^*$ ,  $b^*$  directions.

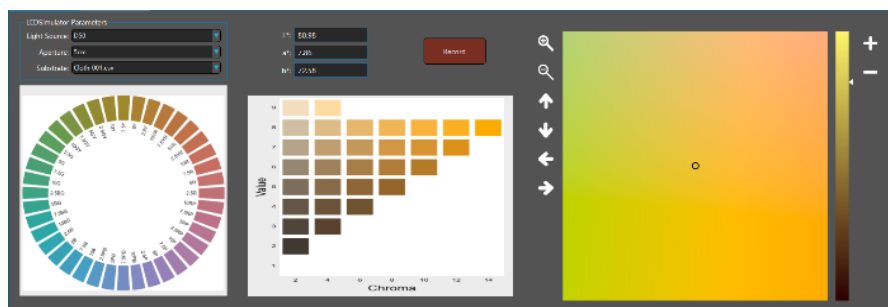

Figure 3: The 'ColourWay' software for colour selection.

*Verification experiments*

Some practical samples were prepared, including 48 samples of 8 textures were selected to give a reasonable coverage of colour gamut. Each texture had an undyed substrate.

*Accuracy test*

In order to evaluate the accuracy of the color of the sample reproduced by the system, a Datacolor SF600 spectrophotometer was used to measure the color of each sample. Their CIELAB values were input into the system, and the display characterisation model introduced earlier were used to display colour on the corresponding undyed substrate. The colours were then measured by a Jet 1211UV Spectroradiometer. Note that the SF600 and Jeti are two completely different instruments. However, they had a mean of 0.84 ranged from 0.11 to 2.03 CIEDE2000 ( $\Delta E_{00}$ ) units (Luo et al. 2001).

*Repeatability test*

In order to understand the repeatability of the same system used at different times, the above CIELAB data were measured repeatedly in a five-hours period. By comparing the data of the two groups, they had a mean of 0.45 ranged from 0.09 to 2.33  $\Delta E_{00}$  units.

*Color matching experiment*

A separate experiment was conducted to reveal the colour matching performance for a typical observer. The goal was to understand the discrepancies for designers or dyers to perform a colour matching task. Observers sit in front of the system (Figure 1a) illuminated by D65 illuminant at 800 Lux level and observed two samples with hairline division. The target sample was fixed to cover half of the window. The other half was the undyed substrate illuminated by the LED Panels (see Figure 2). Observers were asked to adjust the colour via ColourWay software (see Figure 3) to produce a visual match. Twenty observers took part the experiment. Each matched colour was measured by the Jeti spectroradiometer.

A total of 960 groups of 20x48 color matching data were measured in the experiment. Inter-observer variation of the 20 subjects was measured by MCDM (mean color difference from mean) (Cho et al. 2019), and intra-observer variation represented the accuracy of the experiment. The results showed the mean inter-observer variation was 4.92 ranged from 3.76 to 8.56, and the mean intra-observer variation was 4.97 ranged from 2.48 to 8.20, which was significantly larger comparing with the repeatability and accuracy of the system. Note different observers to have different colour vision represented by the colour matching functions. The results here represent the typical observer variation similar to those found by (Cho et al. 2019; Oicherman et al. 2008). This implies that the typical variation could be about 5.0 DE00 units to match a desired colour by a designer

**CONCLUSION**

A computerized system to achieve appearance reproduction for supply chain is developed. The system hardware, colour management workflow, colour selection, and virtual display characterization were first introduced. Finally, a series of tests was conducted to show the system performance in terms of precision and accuracy. The results are satisfactory to achieve the requirement for such system.

**REFERENCES**

- He C., J. Zhang, M. R. Luo. 2020. A Design Tool: Appearance simulator based on spectrum tunable LED lightings, AIC2020 proceedings, Avignon, France
- Luo M. R., K. Hoover, T. Huang, C. He, X. Zhang, J. Feng and J. Zhang. 2021. A total appearance reproduction for supply chain colour management, *J. Textile Eng. & Fash. Tech.*, 3(2021)46-48.
- CIE 015:2018, Colorimetry, 4<sup>th</sup> Edition, Vienna.
- Luo M. R., G. Cui, C. Li. 2006. Uniform Colour Spaces Based on CIECAM02 Colour Appearance Model, *Color Res. Appl.* 31: 320-330.
- Kang H. R. 1997. Color Technology for electronic imaging devices, SPIE Press Monographs, Washington.
- Kuhni R. G. The early development of the Munsell system, *Color Res. and Appl.* 27(2002)20-27.
- Hård A., L. Sivik, and G. Tonnquist 1996. NCS, Natural Color System: From concept to research and applications: Part 1. *Color Res. and Appl.* 21: 180–205.
- Richter M., K. Witt. 1986. The story of the DIN color system, *Color Res. and Appl.* 11:138-145.
- Luo M. R., G. Cui and B. Rigg. 2009. The development of the CIE 2000 colour difference formula, *Color Res. and Appl.* 26: 340-350.
- Cho Y. J., G. Cui, M. R. Luo, *et al.* 2019. The impact of viewing conditions on observer variability for cross-media colour reproduction. *Coloration Technology*, 135(3):234-243.
- Oicherman B., M. R. Luo, B. Rigg and A. R. Robertson, Effect of observer metamerism on colour matching of display and surface colours, *Color Res. Appl.* 33 (2008) 346-359.



# Moving in Colour Illuminated Space: An Exploration of Analyses

Stine Louring Nielsen <sup>1\*</sup>, Emma-Sofie Hestbech <sup>2</sup>, Nanna Hasle Bak <sup>3</sup> and Michael Mullins<sup>1</sup>

<sup>1</sup> Aalborg University, Department of Architecture, Design and Media Technology; stm@create.aau.dk

<sup>2</sup> Aalborg University, Department of Electronic Systems; ehestb18@student.aau.dk

<sup>3</sup> University of Copenhagen, Department of Psychology; nhs@psy.ku.dk

\* Corresponding author: stm@create.aau.dk

## Abstract

This paper presents statistical results of an experiment investigating how the body moves in four different colour spectra of light across a blindfolded and non-blindfolded condition. In a light lab, 26 participants were immersed in white, blue, amber and red illumination, and asked to move around while blindfolded and non-blindfolded. Video-data of their movements were retrieved and coded by two independent researchers into eight binary movement categories of: fast/slow, up/down, hard/soft, coherent/incoherent. Intercoder reliability analysis shows satisfactory (41%), slight to fair (47%) and no (12%) agreements between the encodings. The coding chosen for further statistical analysis shows that participants moved in significantly different manners within the four lighting scenarios. No significant differences between the two conditions of blindfolding and non-blindfolding were found. These findings are in line with an earlier analysis of this study and generally appear to support the hypothesis that visual spectra of light are perceived beyond vision.

**Keywords:** *Light, Colour, Perception, Blindfold, Body Movement*

## INTRODUCTION

Contemporary technologies of programmable LED lighting open up new ways to integrate light as a multifunctional design element in our built environment. Now the spectral quality of so-called 'white' electrical light can be adjusted from a warm amber appearance (2200K), to a more neutral (3000-4000K), or a cool blue-white appearance (6500K) and beyond. Consequently, these new lighting technologies have enabled more saturated colours to enter our built public, urban and private spaces.

With the development of new lighting technologies, research on their effects on perception and well-being is expanding. Relatedly, studies show how different spectra of light have visual effects on our perception of space and non-visual effects on our psychophysiology such as circadian rhythm and mood (Besenecker et al. 2018; Boyce 2014; Li et al. 2017). Traditionally, these studies are based in the dominating belief that light is only to be perceived by the body via vision, where light is passing through the cornea of the eye to the retina, and photoreceptors process information to the visual cortex at the back of the brain (Boyce 2014: 43–57). However, recent studies within social science, neuroscience and biology point to that light within the visual spectrum is perceived beyond vision.

Within social science, a preliminary explorative study indicated that people experience different colour spectrums of light even when blindfolded, by for example describing experiences of floating in an infinite space (blue) or getting a soft hug (amber) both when being blindfolded and when having their eyes uncovered and open (Nielsen, Friberg and Hansen 2018). Moreover, a neuroscientific EEG-study detected distinctly different neurological variations in the brain of blindfolded subjects in response to three studied spectra of light (red, green and blue) (Wulff-Abramsson et al. 2019). Essentially, these results could be further supported by biological discoveries of photosensitive opsin proteins in the cells in the outer layer of our skin (epidermis), indicating that the retina is not the only bodily organ to detect visible radiation of light (Bennet et al. 2017; Haltaufderhyde et al. 2015; Tsutsumi et al. 2009).



**EXPERIMENT AND INITIAL CODING**

To further investigate the possible perceptual effects of different spectra of light beyond vision, an experiment was set up in a light lab, where 26 participants were immersed in four different colour spectra of light (white, blue, amber and red) and asked to move around in a blindfolded and non-blindfolded condition. The lighting scenarios and procedure of the experiment is shown in Figure 1.

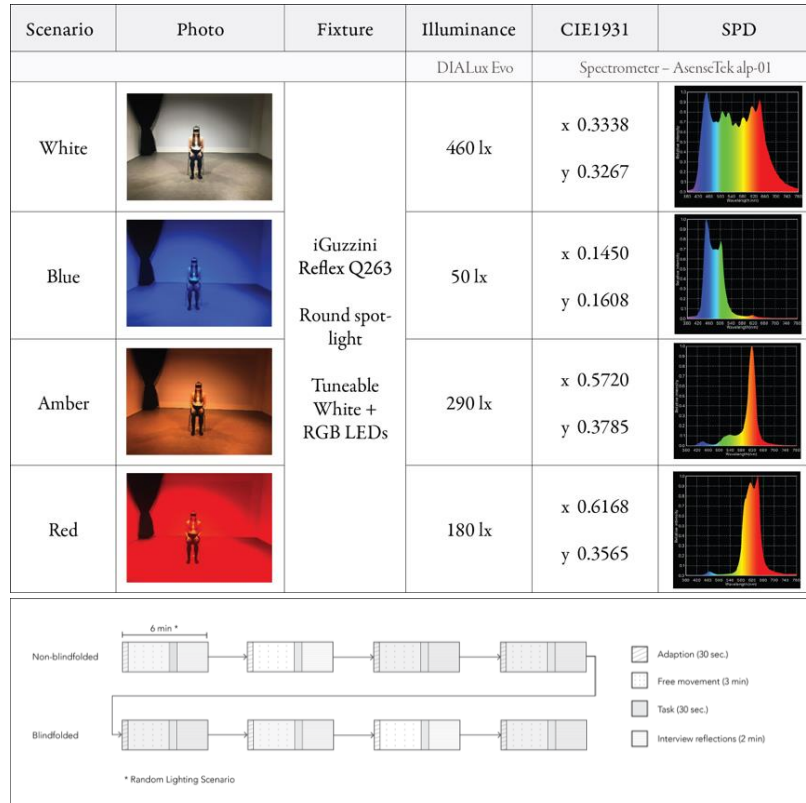

Figure 1: Lighting Scenarios and Procedure of Experiment.

Building on studies of the atmospheric potential of light to attune sensory experiences and body movements in space (Nielsen et al. 2018; Nielsen et al. 2020), the movements of the participants were observed and video recorded.

A qualitative, thematic and statistical analysis of the entire dataset was then carried out by the 1<sup>st</sup> and 3<sup>rd</sup> author of this paper (Nielsen et al. 2021). This analysis found that participants moved in significantly different manners in accordance with the surrounding hue of light. Moreover, statistical analyses generally showed no significant differences between the two conditions of blindfolding and non-blindfolding (ibid.).

**SCOPE AND AIM**

In the following section, we present the statistical results of an additional coding of the video-data on movement, subsequently carried out by two independent researchers, one of which is the 2<sup>nd</sup> author of this paper. This paper thus presents new results that qualify the validity and reliability of the initial analysis (Nielsen et al. 2021). As a means to this, the paper explores the following research questions:

1. How do four chosen light spectra illuminating a space affect observed body movements?
2. Are these observed effects apparent only when the light is visible to the eye, or also when people are blindfolded?

**METHODS**

**Thematic Analysis**

Transferring the coding strategy of the initial coding, the additional encodings of video-data were informed by an overall methodological framework to grasp body movement – that of Laban Movement Analysis (Bartenieff 2002). This framework enables detailed findings by allowing for an in-depth coding of body movements from categories of, for example, **pace**, **position** and **dynamics**, plus the body’s location or **level** in space (ibid.). Accordingly, all video-data on movement was coded into eight binary movement categories of: fast/slow (pace), coherent/incoherent (position), hard/soft (dynamics) and up/down (level), as shown in Figure 2. The one of the two movements that occurred most frequently was coded (e.g. fast), whereas the initial encoding was based on detection of both (Nielsen et al. 2021).

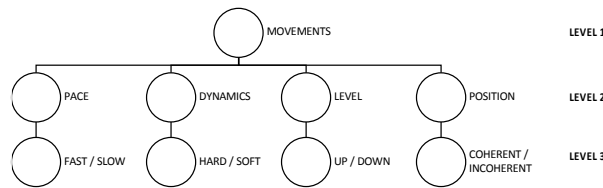

Figure 2: Levels and Categories of Encoding.

**Descriptive Statistical Analysis**

Based on the two coders’ encodings, a descriptive analysis was conducted, with the purpose of getting an overview of frequency of movements for each colour. Figure 3 shows a visualization of the 1st and 2nd coders’ encodings sorted by movement category, lighting scenario and condition.

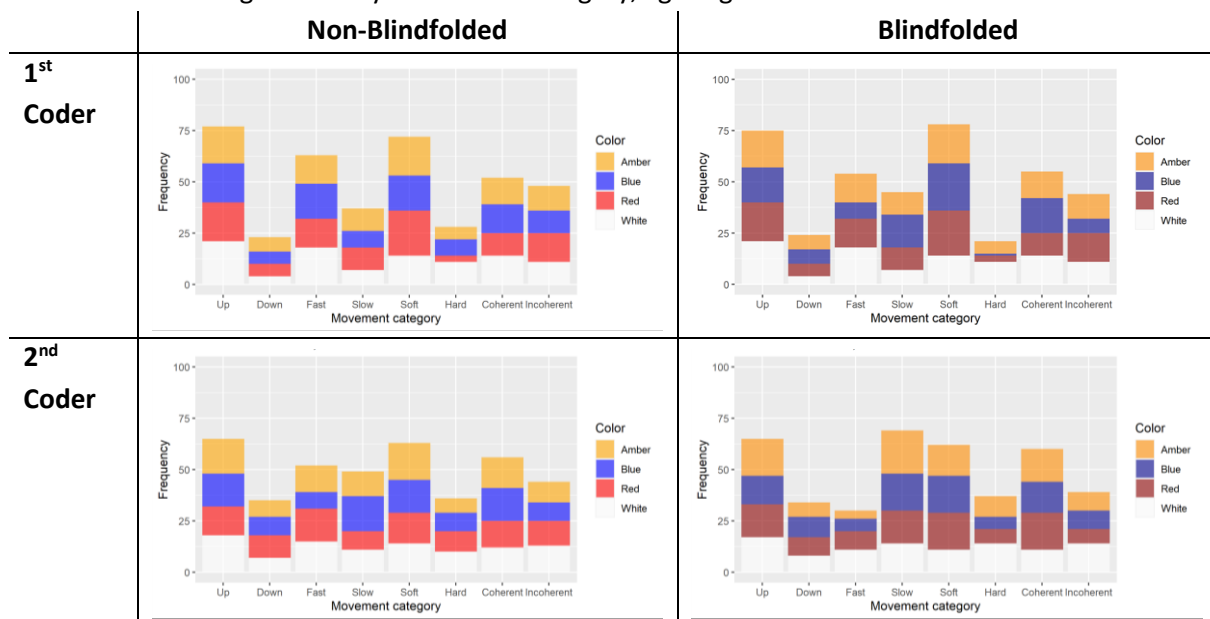

Figure 3: Descriptive Statistical Analyses.

**Intercoder Reliability**

In order to qualify the validity and reliability of the analyses (MacPhail et al. 2015), intercoder reliability was calculated using Cohen’s Kappa for each of the general movement categories (8) across lighting scenarios (4) and conditions (2) for the two encodings – hence 32 kappa values in total. These ranged between -.325 and .905, of which 13 (41%) were above .40, which are considered as satisfactory

agreement between the coders (*ibid.*). Except for four of the kappa values (12%), primarily within the coherence category, the rest (47%) showed slight to fair agreement (.0-.039) (Landis and Koch 1977).

Hence, despite the 88% satisfactory and slight to fair agreements between the encodings, the diversities of the two encodings generally point to the complexity of coding qualitative data, based on subjective interpretation and evaluation of data and codes. As such, personal, cultural and professional bias of the two coders inevitably affect the coding of data (Agar 1996). For contextual reference, both coders were females, around 30 years old and from Denmark. They were given the same explanatory introduction to the movement categories. However, only the 2<sup>nd</sup> coder held a background in academia and was a trained coder of qualitative data. In addition, the 1<sup>st</sup> coder carried out her encodings over 1½ months, compared to the 2<sup>nd</sup> coder spending two weeks, which assumedly heighten the consistency of data. On this basis, we have chosen to only address the encoding of the 2<sup>nd</sup> coder in further analyses.

### **Statistical analysis**

To examine the first research question, i.e. whether there are differences in the movements within the four lighting scenarios, a Friedman's Two-Way Analysis of Variance (ANOVA) was conducted for each of the four movement categories in SPSS, as was done for the initial encoding, as described by Nielsen et al. (2021). Similarly, Wilcoxon Signed Rank Tests were repeated to answer the second research question of potential differences between the two conditions: non-blindfolded and blindfolded. To further explore the two research questions combined, Repeated Measures ANOVA were conducted, based on eight scales derived from adding the binary encodings from the four movement categories together. The scales ranged from 0-4, where a maximum score of 4 indicated expressive movements, as the participant had shown both upward, fast, hard and incoherent movements in the lighting scenario and condition in question. Contrarily, lower scores indicated that the participant had moved more calmly, by showing downward, slow, soft and/or coherent movements, with a minimum score of 0 representing the reverse pattern. Lastly, binomial tests were conducted to test whether one of the movements in the binary movement categories was chosen more than a change of 50%. All p-values were evaluated based on a 5% significance level.

### **ANALYSIS**

The Repeated Measures ANOVA based on the 2<sup>nd</sup> coder's encodings showed significant differences between the four lighting scenarios ( $F(3) = 4.282, p < .008$ ), indicating that participants moved differently depending on the colour of the light. The non-blindfolded and blindfolded conditions revealed no significant differences ( $F(1) = 3.380, p < .080$ ), which indicates that the participants moved in the same way whether they could see or not. No interaction effects were found.

As seen in Figure 4, Wilcoxon's test showed, however, significant differences as regards fast/slow ( $p = .004$ ). These results suggest that participants moved faster when non-blindfolded and slower when blindfolded but had similar movements across the two conditions when moving upward, hard or incoherently. Similarly, Friedman's ANOVA only revealed significant differences between the four lighting scenarios for the category of fast/slow movements ( $p = .009$ ). Especially, participants seemed to move faster in the white light compared to blue and amber light ( $p_{\text{blue}} = .012, p_{\text{amber}} = .039$ ).

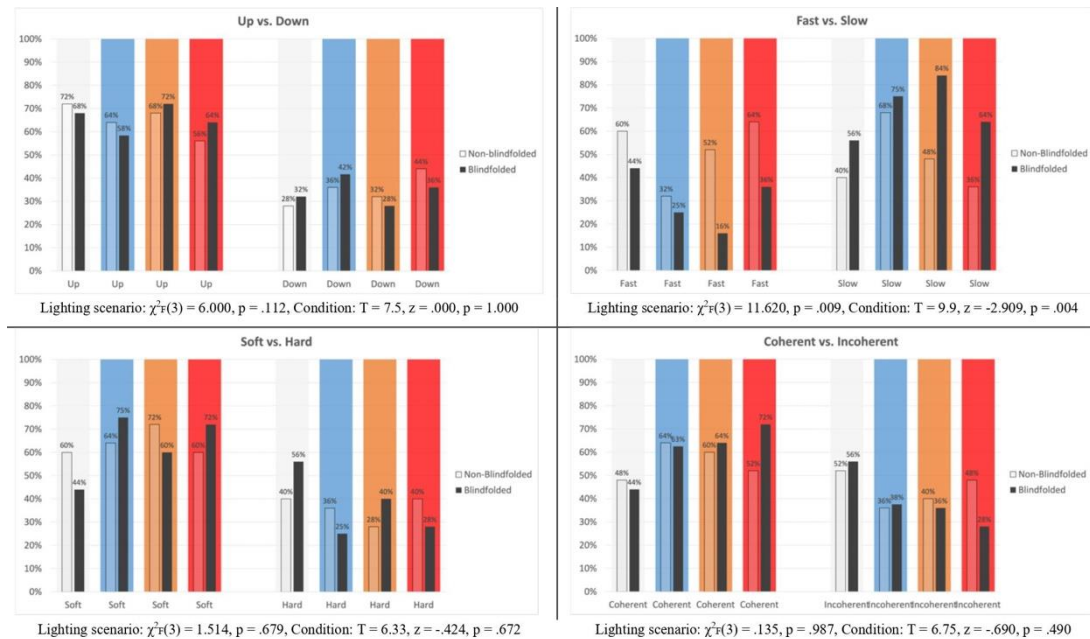

Figure 4: Distribution of assigned movement codes within each lighting scenario and condition.

The binomial tests showed that, when non-blindfolded, participants' movements were significantly more upwards in white light ( $p = .043$ ), and more often fast soft in amber light ( $p = .043$ ). Most of the significant p-values were, however, found in the blindfolded conditions. When blindfolded in amber light, participants were both moving more upward ( $p = .043$ ) and slowly ( $p < .001$ ). Conversely, blindfolded participants more often moved softly ( $p = .043$ ) and coherently ( $p = .043$ ) when exposed to red light. Also, when blindfolded in blue light, participants more often moved softly ( $p = .023$ ).

## DISCUSSION

In line with the general findings of the initial analysis presented in the original paper on the experiment (Nielsen et al. 2021), this study replicated significant differences in movements between the four lighting scenarios, but no significant differences between the two conditions of blindfolding and non-blindfolding. As such, our analyses generally appear to back up recent research, supporting the hypothesis that visual spectra of light are perceived beyond vision by the human skin (cf. Bennet et al. 2017; Haltaufderhyde et al. 2015; Tsutsumi et al. 2009).

Moreover, across our two analyses, participants were rated as moving faster in white light, compared to blue and amber light. Also, both analyses found that participants moved significantly slower in the blindfolded condition, compared to the non-blindfolded, possibly due to an assessment of caution (Nielsen et al. 2021). Despite similarities between the analyses, fewer significant differences were found in the present study. This may be due to the binary "either-or" encoding of the present study, which may be more subjective compared to the "both-and" encoding initially conducted.

In relation to participants rated by the 2<sup>nd</sup> coder, a binomial test showed that participants moved significantly more coherently than by chance in red light while blindfolded. Conversely, in the initial encoding, participants moved significantly more coherently in blue light across the conditions (ibid.). This discrepancy possibly points to the significance of bias when coding qualitative data, such as video-footage on body movements. As too reflected in the varying Kappa values between the two coders (cf. Method section). In this regard, it should be noted that the lowest intercoder reliability was primarily found within the coherence category.

## CONCLUSION

This paper has shown that participants generally moved in significantly different manners within four different lighting scenarios in addition to finding no significant differences between the two conditions of blindfolding and non-blindfolding. Despite some differences, the results of this statistical analysis generally show in line with our initial analysis (Nielsen et al. 2021), which appear to back up recent research, supporting the hypothesis that visual spectra of light are perceived beyond vision.

## ACKNOWLEDGEMENTS

Thanks to the 26 participants and to Laura Navndrup Black, Morten Klinkvort and Birgitte Rasmussen for helping recruitment. Gratitude goes to iGuzzini for providing fixtures and to Eva Aalbæk Nielsen for informing the analytical framework. A big thanks goes to Mia Valhøj Ebdahl for her encoding of video-data and to Margriet Kalsbeek for visualizing Figure 1. The study was funded by Aalborg University.

## REFERENCES

- Agar, M. 1996. "Who Are You to Do This?" In *The Professional Stranger: An Informal Introduction to Ethnography*, 92–111. San Diego: Academic Press.
- Bartenieff, I. 2002. *Body Movement: Coping with the Environment*. Routledge.
- Bennet, D., B. Viswanath, S. Kim, and J. An. 2017. "An Ultrasensitive Biophysical Risk Assessment of Light Effect on Skin Cells." *Oncotarget* 8 (29): 47861–75.
- Besenecker, U., T. Krueger, J. Bullough, Z. Pearson, and R. Gerlach. 2018. "The Experience of Equivalent Luminous Colors at Architectural Scale." *Color Culture and Science Journal* 10: 23–30.
- Boyce, P. 2014. *Human Factors in Lighting*. New York: CRC Press - Taylor & Francis Group.
- Haltaufderhyde, K., R. Ozdeslik, N. Wicks, J. Najera, and E. Oancea. 2015. "Opsin Expression in Human Epidermal Skin." *Photochemistry and Photobiology* 91 (1): 117–23.
- Landis, R. and G. Koch. 1977. "The Measurement of Observer Agreement for Categorical Data." *Biometrics* 33 (1): 159.
- Li, B, Q. Zhai, J. Hutchings, M. Lou, and F. Ying. 2017. "Atmosphere Perception of Dynamic LED Lighting over Different Hue Ranges." *Lighting Res. Technology*, 1–22.
- MacPhail, C., N. Khoza, L. Abler, and M. Ranganathan. 2015. "Process Guidelines for Establishing Intercoder Reliability in Qualitative Studies." *Qualitative Research*, 1468794115577012.
- Nielsen, S., U. Besenecker, N. Bak, and E. Hansen. 2021. "Beyond Vision: Moving and Feeling in Colour Illuminated Space." *Nordic Journal of Architectural Research* 33 (2).
- Nielsen, S., M. Bille, and A. Barfoed. 2020. "Illuminating Bodily Presences in Midwifery Practices." *Emotion, Space and Society* 37 (November): 9.
- Nielsen, S., C. Friberg, and E. Hansen. 2018. "The Ambience Potential of Coloured Illuminations in Architecture." *Ambiances*. no. 4: 0–27.
- Tsutsumi, M., K. Ikeyama, S. Denda, J. Nakanishi, S. Fuziwara, H. Aoki, and M. Denda. 2009. "Expressions of Rod and Cone Photoreceptorlike Proteins in Human Epidermis." *Experimental Dermatology* 18 (6): 567–70.
- Wulff-Abramsson, A., M. Lind, S. Nielsen, G. Palamas, L. Bruni, and G. Triantafylidis. 2019. "Experiencing the Light Through Our Skin - An EEG Study of Colored Light on Blindfolded Subjects." *Proceedings - BIBE 2019*: 609–16.

# OLED Lighting and Human Circadian System: A Review

Ayşe Nihan Avci <sup>1,\*</sup> and Saadet Akbay <sup>1</sup>

<sup>1</sup> Department of Interior Architecture, Faculty of Architecture, Çankaya University, Ankara, Turkey; nihanavci@cankaya.edu.tr, akbay@cankaya.edu.tr

\* Corresponding author: nihanavci@cankaya.edu.tr

## Abstract

Light is a form of energy that affects the human sleep cycle, working hours, alertness, productivity, and well-being. As one of the most essential environmental factors, lighting requires extensive research to understand the human-environment interaction. Earlier studies reveal that various artificial lighting technologies are utilised to investigate the human circadian system; experiments employing solid state lighting (SSL) sources are still being conducted to determine how the human circadian system is affected. Due to the advantages of OLED lighting, there is a need to enhance the use of this form of artificial lighting in an indoor environment. This paper focuses on a literature review on artificial lighting sources, particularly OLED lighting, which has been used from the past to the present. This paper also discusses how OLED lighting can be utilised to alter the human circadian system in an indoor environment.

**Keywords:** OLED lighting, human circadian system, lighting technologies, human-environment relationship

## INTRODUCTION

Light is radiant energy that ranges from gamma rays to radio waves to which the human eye responds to this energy within the limits of the visible spectrum from ultraviolet to infrared. Lighting technologies act as substitutes for natural light. Lighting history might be defined as the evolution of efficient technologies for producing visible light in the required spectral area.

Several lighting fixtures have been produced over the centuries. They have been manufactured to meet the needs, by modifying their characteristics such as shape, colour, temperature, intensity, and rendering of light. They are used to provide general illumination and are classified into three groups: incandescent, discharge, and solid-state lighting (SSL). Figure 1 shows the evolution of artificial lighting technology. Incandescent lamps produce light by heating a tungsten filament to incandescence. Discharge lamps produce light through an electric discharge in a gas and require control gear between the lamp and the power supply.

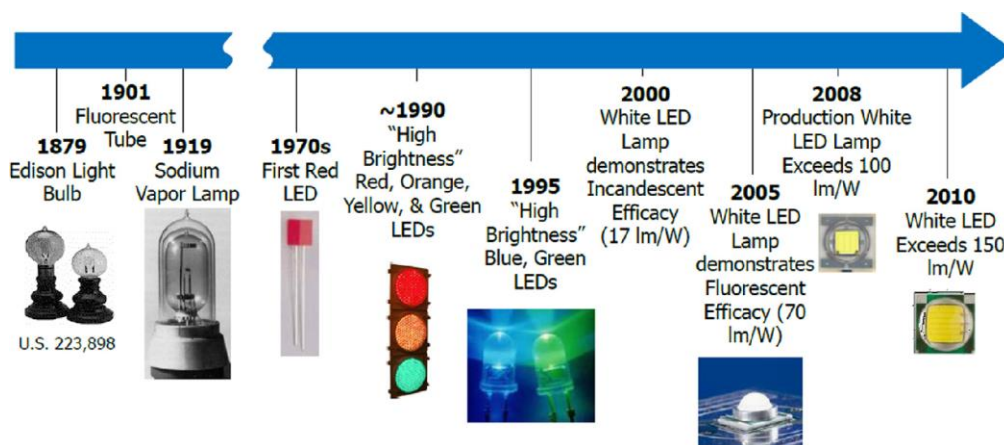

Figure 1: Evolution of artificial lighting technology (De Almeida et al. 2014: 32).

The term ‘solid-state lighting’ is also referred to as ‘electroluminescent lighting’ since it produces electromagnetic radiation in response to power current; this process does not require heat and electric discharge via gas. As a result, they are both cooler and smaller than other types of lighting sources (Innes 2012). With the advent of new green SSL technology, the general concepts of artificial lighting sources have been changing (Kar and Kar 2014). Due to task performances, human comfort and production of high-quality lighting, researchers have focused on high-tech lighting sources that use SSL devices that are more efficient, have very long lifetime, resulting in lower maintenance costs, and have good physical robustness and compactness compared to other lighting sources (De Almeida et al. 2014).

Earlier studies indicate that various artificial lighting technologies are used to explore the human circadian system; experiments employing SSL sources (i.e. LED) are still being undertaken to understand how the human circadian system is affected. However, due to the advantages of OLED lighting, there is a need to use of this form of artificial lighting in an indoor environment. This paper focuses on a literature review on artificial lighting sources, particularly OLED lighting, which also discusses how OLED lighting can be utilised to alter the human circadian system in an indoor environment.

### ***ORGANIC LIGHT-EMITTING DIODES (OLEDs): THE FUTURE OF LIGHTING TECHNOLOGIES***

Organic Light Emitting Diodes (OLEDs), one of the most significant advancements in the lighting industry, are unique and revolutionary solid-state lighting (SSL) sources. OLEDs are a type of SSL source; however, they differ from other SSL sources in that they contain electroluminescence in organic compounds (Kunić and Šego 2012). Following Bernanose and his colleagues’ initial innovation, in 1985, Eastman Kodak Company explored many materials to improve this technique, and in 1987, the first OLED devices were introduced. They were later developed by companies including Samsung, LG, Panasonic, and Sony. Nowadays, OLEDs are currently used in a variety of electronic products such as televisions, mobile phones, and automobiles. OLEDs are composed of multiple organic sandwiched between the cathode and the anode. They are semi-conductive, emit light, and are manufactured on a substrate. The colour of the light emitted is determined by the content of the organic layer. Multiple layers (e.g. red, green and blue) are mixed together to produce any colour, including white. OLEDs differ in structure, material, and emission type. OLEDs are classified into seven types: passive-matrix OLED (PMOLED), active-matrix OLED (AMOLED), transparent OLED, top-emitting OLED, bottom-emitting OLED, foldable or flexible OLED, and white OLED (WOLED).

OLED lighting offers an entirely new realm of light interaction possibilities. OLED is an SSL technology with numerous advantages over traditional alternatives. Along with its design (i.e. being ultra-thin, featherweight, flexible, cool-to-touch, long-life span, and 90+ colour rendering index), health and well-being (no blue light risk, no UV, circadian system friendly, no flicker, naturally diffuse, and glare-free), and sustainability (recyclable, 85% organic and glass materials, does not contain toxic materials, no thermal heat sink, reduced manufacturing footprint, and low power consumption) are among the benefits of OLEDs (Thejokalyani and Dhoble 2014; Hawes et al. 2012; Why OLED 2020).

### ***LIGHTING AND HUMAN CIRCADIAN SYSTEM***

In the 18<sup>th</sup> century, the term ‘circadian’ was investigated by a French scientist Jean Jacques d’Ortous de Mairan (Rossi 2019). He notices that during the day the movements of the flowers of plants continue, although they are placed in an indoor environment and not exposed to sunlight. This finding indicates that the movements of the plants are controlled by an internal clock (Vitaterna et al. 2001).



Plants, animals, fungi, and cyanobacteria all have circadian systems (Edgar et al. 2012). It is a 24-hour cycle that is internally created and influenced by external factors such as light and temperature. The circadian system has a daily cycle that is linked to brain wave activity, hormone production, core body temperature, cell regeneration, and other biological activities. These are all coordinates in the 24-hour cycle of living beings. In addition, the human circadian system influences primary physiological factors such as sleep cycle, changes in body temperature and blood pressure, immune system activities (Rossi 2019), hormone system, and other psychological factors such as alertness level (Cajochen 2007), mood, behaviour (LeGates et al. 2014), and well-being.

Light is the most essential factor that influences the human circadian system, which is accomplished through vision. Being one of the most complicated senses, vision is the primary mechanism by which humans perceive their surroundings. The first thing to understand about the visual system is that it is comprised of more than just the eye. The interaction between the eye and the brain results in vision, which is how humans experience lights their environment. Understanding this process leads to the establishment of such environment. Understanding the biological context that led to vision requires considering the eye and brain as a unit. The eye governs the physiological effects of light in humans. When light enters the eye, it activates retinal photoreceptors, which convert photic information into neural impulses that are then transmitted to various parts of the brain via ganglion cells. For many years, it was considered that the human retina included just two types of photoreceptors: rods and cones; nevertheless, roughly two decades ago, another distinct photoreceptor type was discovered in the mammalian eye. These retinal photoreceptors are specialised ganglion cells that contain the photopigment melanopsin and are inherently photosensitive, hence being dubbed intrinsically photosensitive retinal ganglion cells (ipRGCs) (Berson et al. 2002; Hattar et al. 2002; Provencio et al. 1998, 2000). When light falls on the retina, photoreceptors and cells transfer the light to the suprachiasmatic nucleus (SCN) of the brain, which regulates our daily circadian systems. SCN serves as an organizer for the recurrence of our daily physiological functions and psychological states like hormone secretion, body temperature, mood, well-being, and alertness (Tähhämö et al. 2019). Figure 2 shows the schematic illustration of the neuroanatomical underpinnings of physiological effects of light.

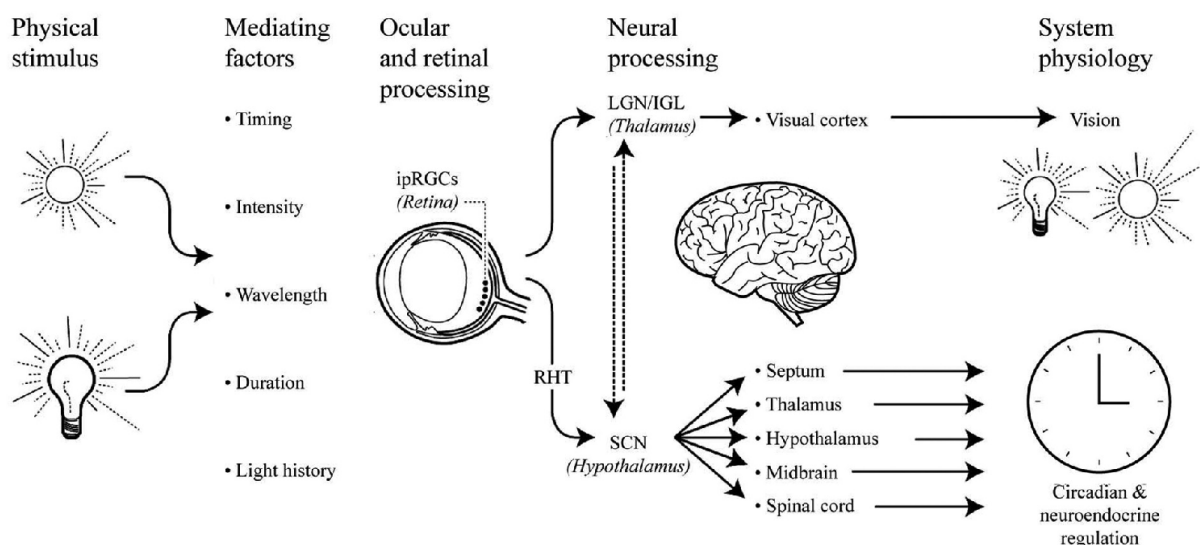

Figure 2: Schematic illustration of the neuroanatomical underpinnings of physiological effects of light (Vetter et al. 2021: 2).



## **DISCUSSION AND CONCLUSION**

Since the millennium's turn, new lighting solutions and advances have focused on research themes such as light and health, user comfort and circadian system. Many studies have been conducted to determine how LED lighting conditions affect the visual comfort under different illuminance levels (Avci and Memikoglu 2017; Fortunati and Vincent 2014). Light has been demonstrated to have significant non-visual impacts on a variety biological functions, including the regulation of the human circadian system. In any case, technological advances can provide useful tools for designing circadian lighting. In this respect, LEDs provide crucial characteristics for manufacturing lighting solutions that prior light sources did not allow for, or only allowed for partially, due to low efficiency and high costs (Rossi 2019). In the literature, there are many studies related to the effects of LED lighting on the human circadian system from different viewpoints (Cajochen et al. 2011; Chaopu et al. 2018; Figueiro et al. 2018; Nie et al. 2020). However, OLEDs, which emit less blue light than regular LEDs, are considered a low-energy and medically friendly type of artificial lighting. A study by Avci and Memikoglu (2021) found that OLED lighting exposure is more comfortable than LED lighting exposure in term of visual comfort criteria in indoor environments. Furthermore, Jo et al. (2021) conducted a study to assess the influence OLED lighting exposure on sleep quality and the circadian system, which investigates the effects of LED and OLED lighting conditions on the human circadian system at night. Jo et al. (2021) suggest that OLED can be a good replacement for LED since its spectrum contains less blue light, which has the greatest impact on melanopsin in intrinsically photosensitive retinal ganglion cells. In addition, the effects of OLED lighting conditions on the human circadian system, visual comfort and well-being in an indoor office environment have been an interest for the authors of this paper where they have been investigated as part of a scientific research project (Project No: MF.20.007). In contrast to earlier studies on the human circadian system, this current ongoing project is based on measuring the human daytime circadian system to evaluate the OLED lighting conditions in an indoor environment. The circadian rhythmicity activity during the daytime is monitored using wrist actigraphy (Actiwatch Spectrum/Philips Respironics). This study is intended to contribute to the field of interior architecture by examining the application of OLED lighting in indoor environments.

To conclude, the major goal should be to establish a healthy environment that addresses health, comfort, well-being, and quality. User friendly lighting systems should be adapted to be used in architecture/interior architecture. The influence of the circadian system should be included to lighting settings. Since OLED lighting technologies are more advantageous than other lighting technologies, their use should be expanded considering the impact on the user's circadian system and other environmental factors.

## **ACKNOWLEDGEMENTS**

This paper is a part of a scientific research project granted by Scientific Research Council of Çankaya University, Ankara, Turkey (Project No: MF.20.007).

## **REFERENCES**

- Avci, A. N. and I. Memikoglu. 2017. Effects of LED lighting on visual comfort with respect to the reading task. *International Journal of Electrical and Computer Engineering* 11(8): 974-978.
- Avci, A. N., and I. Memikoglu. 2021. Evaluating effectiveness of LED and OLED lights on user visual comfort and reading performance. *A|Z ITU Journal of the Faculty of Architecture* (in press).
- Berson, D. M., F. A. Dunn, and M. Takao. 2002. Phototransduction by retinal ganglion cells that set the circadian clock. *Science* 295(5557): 1070-1073.

- Chaopu, Y., F. Wenqing, T. Jiancheng, Y. Fan, L. Yanfeng, and L. Chun. 2018. Change of blue light hazard and circadian effect of LED backlight displayer with color temperature and age. *Optics Express* 26(21): 27021.
- Cajochen, C. 2007. Alerting effects of light. *Sleep Medicine Reviews* 11(6): 453-464.
- Cajochen, C., S. Frey, D. Anders, J. Späti, M. Bues, A. Pross, R. Mager, A. Wirz-Justice, and O. Stefani. 2011. Evening Exposure to A Light-Emitting Diodes (LED)-Backlit Computer Screen Affects Circadian Physiology and Cognitive Performance. *Journal of Applied Physiology* 110(5): 1432-1438.
- De Almeida, A., B. Santos, B. Paolo, and M. Quicheron. 2014. Solid state lighting review—Potential and challenges in Europe. *Renewable and Sustainable Energy Reviews* 34: 30-48.
- Edgar, R. S., E. W. Green, Y. Zhao, G. V. Ooijen, M. Olmedo, X. Qin, and Y. Xu et al. 2012. Peroxiredoxins Are Conserved Markers of Circadian Rhythms. *Nature* 485(7399): 459-464.
- Figueiro, M. G., M. Kalsher, B. C. Steverson, J. Heerwagen, K. Kampschroer, and M. S. Rea. 2018. Circadian-Effective Light and Its Impact on Alertness in Office Workers. *Lighting Research and Technology* 51(2): 171-183.
- Fortunati, L., and J. Vincent. 2014. Sociological insights on the comparison of writing/reading on paper with writing/reading digitally. *Telematics and Informatics* 31(1): 39-51.
- Hattar, S., H. W. Liao, M. Takao, D. M. Berson, K. W. Yau. 2002. Melanopsin-containing retinal ganglion cells: architecture, projections, and intrinsic photosensitivity. *Science* 295(5557): 1065-1070.
- Hawes, B. K., T. T. Brunye, C. R. Mahoney, J. M. Sullivan, and C. D. Aal. 2012. Effects of four workplace lighting technologies on perception, cognition and affective state. *International Journal of Industrial Ergonomics* 42: 122-128.
- Innes, M. 2012. *Lighting for interior design*. London: Laurence King Publishing.
- Jo, H., H. R. Park, S. J. Choi, S. Y. Lee, S. J. Kim, and E. Y. Joo. 2021. Effects of Organic Light-Emitting Diodes on Circadian Rhythm and Sleep. *Psychiatry Investigation* 18(5): 471-477.
- Kar, A., and A. Kar. 2014. Advancements in solid state lighting technology for smart and energy efficient illumination system design. *International Conference on Green Computing Communication and Electrical Engineering*, 1-6.
- Kunić, S., and Z. Šego. 2012. OLED technology and displays. In *Proceedings ELMAR-2012*: 31-35.
- LeGates, T. A., D. C. Fernandez, and S. Hattar. 2014. Light as a central modulator of circadian rhythms, sleep and affect. *Nature Reviews Neuroscience* 15(7): 443–454.
- Nie, J., T. Zhou, Z. Chen, W. Dang, F. Jiao, J. Zhan, ..., and B. Shen. 2020. Investigation on entraining and enhancing human circadian rhythm in closed environments using daylight-like LED mixed lighting. *Science of The Total Environment* 732, 139334.
- Provencio, I., G. Jiang, J. Willem, W. P. Hayes, and M. D. Rollag. 1998. Melanopsin: An opsin in melanophores, brain, and eye. *Proceedings of the National Academy of Sciences* 95(1): 340-345.
- Provencio, I., I. R. Rodriguez, G. Jiang, W. P. Hayes, E. F. Moreira, and M. D. Rollag. 2000. A novel human opsin in the inner retina. *Journal of Neuroscience* 20(2): 600-605.
- Rossi, M. 2019. *Circadian Lighting Design in the LED Era*. Cham, Switzerland: Springer Nature Switzerland.
- Tähkämö, L., T. Partonen, and A. K. Pesonen. 2019. Systematic review of light exposure impact on human circadian rhythm. *Chronobiology international* 36(2): 151-170.
- Thejokalyani, N., and S. J. Dhoble. 2014. Novel Approaches for Energy Efficient Solid-State Lighting by RGB Organic Light Emitting Diodes – A Review. *Renewable and Sustainable Energy Reviews* 32: 448-467.

Vetter, C., P. M. Pattison, K. Houser, M. Herf, A. J. Phillips, K. P. Wright, ..., and G. Glickman. 2021. A Review of Human Physiological Responses to Light: Implications for the Development of Integrative Lighting Solutions. *LEUKOS* 1-28.

Vitaterna, M. H., J. S. Takahashi, and F. W. Turek. 2001. Overview of circadian rhythms. *Alcohol Research and Health* 25(2): 85-93.

“Why OLED”, Accessed June 29, 2021. <https://www.oledworks.com/inspiration/#why-oled>.

# Colours, light and well-being: characterisation of chromatic phenomena in collective housing

Lorrain Caumon <sup>1,2,3,\*</sup>, Georges Zissis <sup>1</sup>, Céline Caumon <sup>2</sup>, Élodie Bécheras <sup>2</sup>, Estelle Guerry <sup>1,2</sup> and Christelle Infantes <sup>3</sup>

<sup>1</sup> LAPLACE, UMR5213 (CNRS, INPT, UT3), Toulouse University, France; [firstname.lastname@laplace.univ-tlse.fr](mailto:firstname.lastname@laplace.univ-tlse.fr)

<sup>2</sup> LARA SEPIA, EA 4154 (UT2J), Toulouse University, France ; [firstname.lastname@univ-tlse2.fr](mailto:firstname.lastname@univ-tlse2.fr)

<sup>3</sup> SOBRIM Company - HARANAM concept, Bayonne, France; [contact@sobrim.fr](mailto:contact@sobrim.fr)

\* Corresponding author: [lorrain.caumon@laplace.univ-tlse.fr](mailto:lorrain.caumon@laplace.univ-tlse.fr)

## Abstract

The objective of the study presented is to demonstrate the value of a chromatic and luminous analysis of a place in the pre-design phase. This analysis protocol is part of a designer's ethic which is to anticipate and respond to the conscious and unconscious needs of users, thus participating in the construction of a quality approach. Using the case study of the “Bonamour” project (Capbreton, France), we question the value and interest of promoting a protocol that favours a benevolent and differentiated design approach. This will allow us to evaluate the relevance of the devices applied. Ultimately, the data collected and the recommendations applied to the project will enable property developers to gradually turn towards a more inclusive and sensitive design of lighting and colour applied in the residential sector.

**Keywords:** *Light design, Color design, Visual comfort, Protocol, Accompaniment*

## INTRODUCTION

### Health and housing threats

The actual pandemic is the sixth one that has hit humanity since the Spanish flu of 1918. According to a ONU report, the frequency and severity of these global epidemics could accelerate in the coming years, due to our lifestyles and the incredible adaptive capacities of viruses (IPBES. 2020). In this exceptional health context, we have seen that housing conditions have more than ever impacted our daily lives. As a result, we have become aware that the problems related to the quality and sharing of collective living spaces during a pandemic will be major issues in the future and must require the full attention of real estate professionals.

All the more so as for many reasons, keeping people at home can be accompanied by multiple and varied disabilities, thus affecting the quality of life (Eideliman and Gojard 2008: 89-111; Piccoli et al. 2020; ONU 2020). In France, approximately 12 million people are affected by a disability, including 1.5 million with a visual impairment and 850,000 with reduced mobility, (INSEE. 1999-2001). Also, age is a factor to be taken into consideration, because in 2050, metropolitan France will have approximately 70 million inhabitants, more than a third of whom will be 60 years old, (INSEE. 2002). For all these people, the positive and secure perception of the daily environment must become an important issue. Therefore, it becomes necessary to adapt the environment of collective housing to people with different pathologies and their potential consequences on their habits.

### Chromatic effects and methods of approach.

With this study, we want to provide reflections on design issues such as designing built, sensitive and inclusive spaces. To do this, we have focused on what inclusiveness means in the creation of the atmosphere of a place through its colour and light factors. For this purpose, we defined that an inclusive atmosphere translates into situations of sensitive and accessible interactions understood as

the plural and singular experience that one has of a given place at a given time, influencing our sensations and quality of life. For many years, designers and authorities have been placing people and their plurality at the heart of architectural projects, but if we stick to strict compliance with standards, as people do not respond to any average, many gaps remain.

For example, in the French standards (EN 12464-1 completed by NF X35-103), the only indications are that the age of people must be taken into account to define the lighting levels on work surfaces. In collective dwellings, article 10 of the order of 24 December 2015 imposes minimum characteristics to ensure average horizontal illuminance values measured on the floor along a usual circulation route, taking into account transition zones. It goes without saying then that strict compliance with these standards does not allow us to guarantee the success of an architectural project in the perception of these users (Mudri. 2002).

### **Color-Light: a factor of identity and orientation.**

In the literature of cognitive sciences and psychology, there is little research on the role of colour in its relationship to space and in particular in the spatial orientation of people. However, we know that a visual environment adapted to the pathologies of people suffering from disabilities has positive effects, but must respect a certain number of criteria such as a quantity of light, contrasts and an appropriate spatial distribution (Damelincourt et al. 2010). We therefore hypothesised that colour in the architectural environment of collective dwellings could support spatial location and orientation, particularly for people with disorientation, who are less receptive to conventional signage systems (Bay et al. 2021: 97-103).

In doing so, this empirical approach will hopefully instil thoughts around colour in communal housing environments. Inherited from hygienic and standardised norms, we note, even today, that few works integrating colour are the object of a voluntary approach. The selection of colours and materials often depends on the tastes of the project manager and the customary validation of the client, but what appears to be a secondary issue is in reality a key point in the assessment of the success of an architectural project. The results of this study will enable the implementation of a creative protocol that will assist property developers in designing visual environments adapted to the needs of all its inhabitants. The main results expected from this study are :

- Improve the analysis and interpretation protocol to define comfortable visual environments.
- Develop tools for simulating lighting ambience in the programme design phase.
- Facilitate the integration of the results of this study by professionals.

## **MATERIALS AND METHODS**

### **Color-matter, color-light**

The protocol presented is based on a combination of chromatic expertise (colour matching) concerning the choice of materials, textures and finishes, favouring colour for its plastic character; and lighting (light characterisation) concerning the quantity and colourful character of the light, giving particular importance to the different colour temperatures. This study focuses mainly on the common spaces and the interior horizontal circulations. This is because the visual ambience of these areas should create a sense of welcome, visual comfort and safety for all users, at all ages, during the day and at night. Therefore, the method used will serve to create coherence and harmony between the exterior landscape treatments and the interior chromatic and lighting treatments in order to create an intuitive and inclusive chain of movement. The method was divided into two stages:

**Step 1: Captures**

The surveys presented were carried out on 26 June 2019 in Capbreton (Landes, France) over a period of 8 consecutive hours at the site of the future "Bonamour" residence built by the property developer SOBRIM (Basque Country, France).

The first phase consisted of collecting photographs of the site, as the survey of the existing site is an essential phase before any project. Equipped with cameras, this preliminary chromatic analysis was accompanied by a walk around the site. Photographs cannot be used to faithfully reproduce colours on a palette. However, they are indispensable graphic documents for memorising, visualising and disseminating information (Lenclos et al. 1982: 65). Most chromatic studies employ photographic investigations to support the colour surveys. In our case, photography was used in two approaches, one aimed at establishing an inventory of the surrounding urban colours and forms, and the other at colour and light diagnosis in order to judge the appearance of the site under cyclical conditions. This stage was a means of transcribing and analysing the experience of a space.

The second phase consisted of referencing the colours of the site with the help of countertypes. In our study, the colour survey consisted of observing the colours that made up the environment and the architectural elements surrounding the project in order to compare them to reference colour samples. Here, we used the colours of the NCS colour chart. The Natural Color System, is a universal system used for standardised colour communication, based on an intuitive codification designed on human vision. This reference system allows us to communicate about colours in a universal way in various fields of application. This representation also allowed us to retranscribe these chromatic readings in values thanks to the L. a. b system from the CIE XYZ, taking into account the logarithmic response of the eye, but also by the specific characteristics of the coloured surfaces with their luminance index.

The third phase was to carry out a series of measurements to characterise the lighting environment of the site. The evaluation was carried out at three different times of the day (morning at 10:00, early afternoon at 14:00, late afternoon at 17:30) to measure the light amplitude. Also, in order to analyse the light distribution of the space, it was divided into several areas of the site. This series of measurements was carried out with the IRC CL-70F chromaticity meter, allowing us to collect all the values of the light. A video-luminance meter was also used to identify areas that may be sensitive to glare and shadows caused by the future buildings.

**Step 2: Creations**

The first phase consisted of a study of the existing light, environment, chromatic and architectural identity of the site (see Figure 1).



Figure 1: Environment Study.

Each environment has a unique identity, of which colour and light are part. The mission of the colour designer must necessarily include a diagnosis of the existing environment. This stage defines how we will approach the existing environment and certain elements in relation to the project, but also to the promoter's wishes in terms of the expected aesthetic and functional ambitions. In this phase, we took into account the so-called "permanent" and "cyclical" colours. The "permanent" colours are the basis of any chromatic study. They constitute the stable elements of the place, having a durable character, such as the building materials. They are opposed to "cyclic" colours, which are unstable and subject to innumerable temporal, meteorological and luminous variations, such as the colour of patinas, plants and the sky (etc.).

The second phase consisted of recommending atmospheres adapted to the place, using chromatic ranges, materials and lighting systems that would favour the safety and visual comfort of all the inhabitants. This method consisted of experimentally constructing chromatic ranges by means of the view, proceeding by variation and multiplication of optical combinations until a visual impression was obtained that conformed to the aesthetic expectations of the project. In order to conceive these chromatic ranges, we used the NCS colours previously surveyed on the site, which we then matched with the colour charts of the paint and plaster manufacturers used for this project. Thus, an atmospheric work was conceived around the spirit of the place, the chosen shades are sublimated by the contribution of contrast around several soft and affirmed tonalities inspired by nature and harmonizing perfectly with the vegetal contribution present on the site. These prescriptions led to the creation of three chromatic palettes specific to each building in the project (see Figure 2).

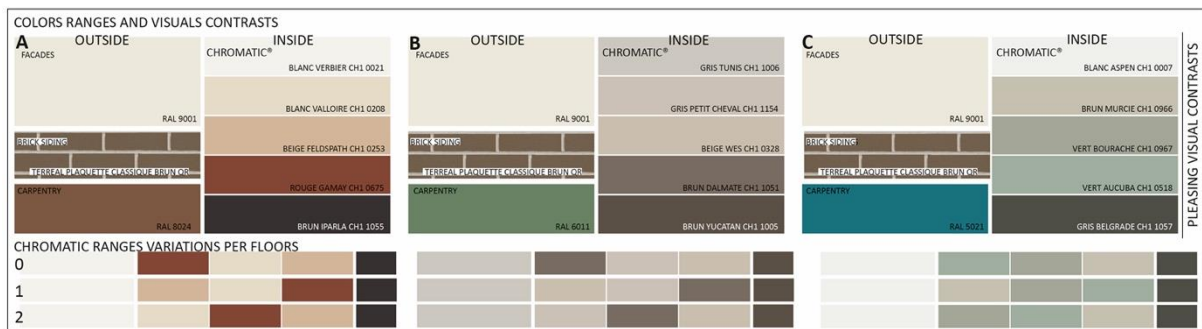

Figure 2: Chromatic environment creation.

Inside, the chromatic combinations are composed of five shades, but established on a dominant trichromatic (Déribéré. 1968), varying on each level, thus avoiding all visual disturbances caused by a discordant polychromy, and relieving the space of a certain visual monotony recurrent in this type of place. Particular attention was paid to chromatic contrast and luminance values, as contrast sensitivity generally decreases with age and can be even more disturbed when visual pathology is added. Thus, the luminance indices of each recommended colour are between 0.6 and 0.9 for light colours and between 0.2 and 0.45 for dark colours, and finally, a contrast of 70% has been respected between different important supports so that they can be perceived by a visually impaired person, whose sensitivity to contrasts is still operating. Here, light colours are used for large surfaces and dark colours for smaller surfaces or accessories to allow better discrimination of spatial elements. Some of the contrast values are not equal to 70%, but they have been accepted due to a negligible margin of error. The creation of these differentiated harmonies has therefore allowed us to design circulation spaces with chromatic variations for each level, favouring intuitive orientation as well as efficient and comfortable reading of the chain of movement for all inhabitants.

Finally, these harmonies were also accompanied by a lighting design. This was studied so that the quantity and quality of light would meet the needs of all the inhabitants, because at 55 years of age the quantities of light required are 300% higher than at 25 years of age, and this for an equivalent level of visual performance, (AFE. 2020). For this reason, we recommended an average of 300 lux at the floor level, homogeneous throughout the buildings, using direct and indirect LED lighting with a colour temperature of 3000 Kelvin. Finally, the choice of materials was studied in order to recommend finishes ranging from matt to satin in the entrance halls according to their natural light contribution in order to adapt to each exposure and thus not generate any glare or darkness.

To conclude, the third phase was the creation of a technical execution file for the project management. This file is based on and complements the documents provided by the project architect and includes normative descriptions as well as graphic documents such as colouring diagrams on plans, lighting system layout diagrams, cross-sections, a book of details and signage, as well as a material library to ensure the proper implementation and monitoring of the project.

## **RESULTS**

The different phases of surveys and analyses contributed to demonstrate in a quantitative and normative way how the place could be perceived by the inhabitants, (INSEE. 2017). The interpretation of these results allowed us to start prescribing efficient lumino-chromatic atmospheres, taking into account the constraints linked to circadian lighting and the location of the buildings. This creation phase, beyond taking into account the standards in force, called upon an experimental construction method (Pfeiffer. 1966), taking into account several factors intrinsic to the project:

- The analysis of the characterisation of the colour and light on the site.
- The spirit and visual coherence of the place where the project will be located.
- An efficient chain of movement.
- Comfort of use and appreciation of the spaces for all inhabitants.

The outcome of this protocol was the creation of a construction file and a detail booklet, intended for the project owner in order to transcribe the information collected into technical prescriptions, colouring principles and efficient lighting in the future building. We hypothesise that this expertise in chromatic and luminous characterisation within its future circulation spaces will generate more visual reference points and comfort of use thanks to this protocol..

## **DISCUSSION**

The issue of lighting and colour in collective housing is quite complex, as designers' preferences vary greatly according to both objective and quantifiable conditions (economy, standardisation of practices, specific needs related to people with disabilities, etc.) and socio-cultural and subjective conditions (preference for a particular colour scheme, type of luminaire, type of covering, etc.).

As a result, and in the absence of standards directly related to these semi-private spaces, architects tend to use very neutral, even monotonous, colours and materials, and struggle to install lighting that is sufficiently effective, comfortable and aesthetic in common areas. With the help of this study, we are beginning to awaken designers to the challenges of colour and light. Because together, beyond their simple aesthetic contribution, they make it possible to secure and make efficient the circulations while allowing the inhabitants to plunge into singular universes where the atmosphere becomes a factor of wellbeing and cohesion.



## **CONCLUSION**

In the next ten years, a comparative study will complete the research-creation protocol studied in this article. This comparative study will take into account the values obtained in the old residences and those designed from this protocol, this study will be completed by an interview with the inhabitants questioning them on the perception of the place and basing ourselves on a scale of sensations and anhedonia. This study will enable property developers to adjust and design in a systematic and sustainable way visual ambiances better adapted to human physiological needs and to prove the validity of qualitative approaches in terms of light and colour design within new property programmes.

## **ACKNOWLEDGEMENTS**

I thank the LAPLACE Laboratory of the Paul Sabatier University in Toulouse, France for making the experiment possible by providing tools. I also thank the company SOBRIM for allowing me to carry out this study and for the interest shown in these results. Finally, I would like to thank them for their willingness to promote and develop their university research within their future real estate programmes thanks to the HARANAM approach.

## **REFERENCES**

- AFE (Association française de l'éclairage). 2020. *Fiches pratiques éclairages dans les collectivités*. Online data.
- Bay, B., C. Coirié, and M. Fayolle. 2021. *Couleur et soin. Le facteur d'identité et d'orientation dans un service de soins du GHU Paris Psychiatrie & Neurosciences*. Edition Les presses du réel.
- Damelin court, J. J., C. Corbé, B. Paule, and G. Zissis. 2010. *Éclairage d'intérieur et ambiances visuelles. Collection Optique et Vision*. Edition Lavoisier.
- Déribéré, M. 1968. *La couleur dans les activités humaines*. Paris: Edition Dunod.
- Eideliman, J. S., and S. Gojard. 2008. La vie à domicile des personnes handicapées ou dépendantes: du besoin d'aide aux arrangements pratiques. *Retraite et société* 53: 89-111.
- INSEE (Institut national de la statistique et des études économiques).  
2001. L'enquête HID (Handicaps, incapacités, dépendance). Online data.  
2002. La population de la France métropolitaine en 2050 : un vieillissement inéluctable. Online data.  
2017. Propriétaires occupants. Online data.
- IPBES (Plateforme intergouvernementale scientifique et politique sur la biodiversité et les services écosystémiques). 2020. Communiqué de presse - *Échapper à l'«ère des pandémies» : Les experts mettent en garde contre de pires crises à venir ; Options proposées pour réduire les risques*. Online data
- Lenclos, D., J. P. Lenclos, and G. H. Riviere. 1982. *Couleurs de la France: géographie de la couleur*. Paris : Edition Le Moniteur.
- Mudri, L. 2002. *Luminous ambience, quantitative/qualitative data and subjective response*. First International Workshop on Architectural and Urban Ambient Environment. Nantes. Online data.
- ONU (Organisation des Nations unies). 2020. *Note de synthèse, Inclusion du handicap dans la riposte à la COVID-19*. Online data.
- Pfeiffer, H. 1966. *L'harmonie des couleurs, cours théorique et pratique*. Paris : Edition Dunod
- Piccoli, M., I. Hernandez, S. Koeberle, and T. Tannou. 2020. Ethical approach to the issue of confinement of the elderly in the context of the COVID-19 pandemic: Prevention of frailty versus risk of vulnerability. *Ethics, Medicine and Public Health* 14. Online data.

# A design approach to lighting and color rendering in indoor sets

Andrea Siniscalco <sup>1,\*</sup>

<sup>1</sup> Politecnico di Milano; andrea.siniscalco@polimi.it

\* Corresponding author: andrea.siniscalco@polimi.it

## Abstract

Indoor lighting and color design practice for television set and movie industries evolved in the decades because the real-time observer is the camera instead of the human being. Nevertheless, even modern cameras do not have the dynamic, adaptation, and cognitive correction of the human visual system. Although technology evolutions of cameras allow regulatory actions to control the parameters related to color, there are still open issues in this sector. Solid-State lighting has greatly enriched the color creativity for directors of photography, and numerous ways of standardizing color coordinates have been proposed to have a common vocabulary. However, this has also led to the emergence of new technical and organizational issues. Different cameras capture colors illuminated by LED sources, slightly different from each other. The purpose of this paper is not to cover all the scientific aspects for the lighting of indoor sets but to collect the right amount of information relating to the operations design on light and its chromaticity under a design method approach.

**Keywords:** *lighting design, color rendering, television set*

## INTRODUCTION

Lighting technology nowadays is at a level that allows us to use color without limits or sacrifices. If it's true that color concerning architectural lighting still encounters some resistance, it is also true that colored light can transform space, reshaping the way it is perceived. Of the various lighting areas, the more oriented on the use of color are those related to entertainment such as television and cinema. Even with some significant overlap, the approach to lighting for televisions and cinema sets differs a lot from the more general architectural lighting. There are many differences in the tools and technologies used, the organization of the workgroup, the design process, the objectives to be expressed with lighting and the strategies to achieve them, and most of all, the color control of the illuminated set. A common approach is that the project starts to form in the designer's mind early, a "painting without colors" that gives more importance to the scene's compartments, the spotlights' orientation, and the fillings done with wash-type lights so on. In this phase, the use of color is only a draft; it is possible to get an idea of what colors could be used, but the information available is still not enough. When everything goes into production, at the time of staging, it is possible to really give color to the event; work upwards, and observe the "substance."

Lighting for indoor sets has a one century history. The use of artificial light in indoor studios instead of outdoor theaters, around the 1920, led to a revolution of light in scenography, giving the great masters of photography a whole new ground to experiment. One of the most notable masterpieces that made this experiment the key to his success was Fritz Lang's *Metropolis*. In this movie, light assumes a semiotic value. In the management of light and shadow, in the dynamic projections, using electric discharges and luminous objects as scenographic communication tools to amplify the scenes' affect human emotions (Roth 1978). Lang drew his inspirations from Art Deco, Bauhaus, and Futurism (Rutsky 1993; Wolfe 2020), applying them to light. As a scientific and technological subject, the lighting design went to a communicative, scenographic expression (Pooky 2016). The emotional influence of lighting when an event is staged has been known since the days of classical theater. The advent of electricity made it possible to bring the impact of light to levels never reached before. A striking example of the use of electric light in a scenic context of propaganda was

the well-known “Cathedral of light.” In 1934, at the Zeppelintribune in Nuremberg on the occasion of the Reichsparteitag, Albert Speer used 152 searchlights with a diameter of 150 cm, loaned by the Luftwaffe to outline the frame of the immense stadium capable of host over 340.000 people. The effect obtained left the ambassadors of other states astonished (Speer et al. 1997), and the joint use of Richard Wagner’s music was what consecrated the power expressed in that event (Moller 1980). More than the political content of the parade, it was the synesthesia between light and sound that forged the message of hegemonic power that would soon become sadly known to the whole world. Later, the introduction of color in lighting in entertainment events is already documented in the postwar period in British theaters (Applebee 1950). It even hypothesizes using these experiences to evaluate the quantity and chromaticity of light for the commoners (Strange and Hewitt 1956). The study of the relationship between illumination and stage show intensifies until it is finally formalized by Reid (1970). Time passed, and technology evolved. In 1980 the moving lights were introduced to the market by Vari-Lite (2021). The use of color becomes more and more important in live performances until, in 1988, the concerts *The Wall* by Pink Floyd, designed by Mark Brickman, traced a milestone for the lighting of shows (Williams 1988). Since then, technology has made great strides in live performance, and manufacturers have incredibly evolved the luminaires from those that were once used in the ’80s in discos. However, issues must be taken into consideration for color rendering.

## **LIGHTING AND COLOR**

The first and foremost difference between sets lighting and general lighting is that the illumination must meet the requirements for the cameras and not for the human observer (Box 2020). Even if sophisticated, these devices do not have the typical processes of the visual system, such as color constancy. Some technologies may attempt to mimic some visual system features; however, the complexity of human perception cannot be easily replicated, and some corrections are necessary.

Concerning color, the immediate attention that the lighting teams, usually composed of the director of photography and the gaffer, must have is to apply all the necessary technical procedures to balance the color temperature of all the sources on stage. It is fundamental to carry these procedures following the white balance for digital cameras or stock of film chosen.

A fundamental task consists of introducing colored light for aesthetic reasons or simulating specific light sources in the scene to support the narrative and the set design. The choice of colors is almost always the result of a personal interpretation to catch the idea of the director and the set designer. In TV setes it is also essential to know the soundtrack to build its chromaticity, passing from framework to framework. The freedom to do all this then depends on the factors seen before and on the luminaires available and the designer’s competence to use them. Entering into the heart of the choice of colors, the approaches that can be adopted are practically infinite and mostly depend on the designer’s sensibility. One can play on warm tones on warm, cold on cold, complementary colors, and in contrast, what is essential is that these choices accompany the concert narrative. Another element that can significantly influence the Lighting Designer’s color choices is the light deriving from other technical equipment: LED-wall elements, which put in scene digital contents.

Nowadays CCT control, tunable white, is known and used in general lighting. This aspect, in the TV-lighting field, is considered from a different point of view. When lighting sources with multiple CCT are present simultaneously in an environment, the human visual system tends to mitigate the dominant colors by attenuating the perception of different tones; the light will appear warmer or colder but still white. This HVS phenomenon does not apply to equipment such as cameras. They might have attenuation algorithms, but they will never be at the level of our HSV. This means that

when there are whites with different color temperatures simultaneously in a scene, the camera can only have a single white point as a reference; the others whites will all appear more or less yellowish or bluish. This situation is not acceptable for video recordings, and therefore, once the reference white has been established, some correction operations on the sources must be adopted. On non-dynamic light sources, it is possible to operate additively by summing other sources with different color temperatures to balance. Alternatively, it is possible to use subtraction, reducing the power of some components of the spectrum. This result is usually obtained employing gels correction filters named CTO (Color Temperature Orange) or CTB (Color Temperature Blue). Filters have different intensity levels (full, half, quarter, one-eighth) and are designed to shift the hue of light along with the Planckian locus. LED light sources can modify the shade of white and colored light with multi-chip sources or luminaires with interchangeable phosphor panels. However, it is not uncommon to use filters even on solid-state sources; lighting designers sometimes use this technique in specific fields such as the exhibition area (Murano 2017). When correcting light with gel filters the result is not linear. Using a 1/8 CTO filter on a cold source, you can get a color temperature shift of about 200K. If you apply the same filter on a warmer light source, the shift can even reach 600K. The color temperature corrections applied via hardware on LED luminaires follow what was set by the operator. However, a consolidated methodology deriving from gel filters has resulted in a particular approach to color temperature corrections. To not be constrained by the lack of linearity described above, filter manufacturers consider units called MIREDS (Micro REciprocal Degree) instead of using the CCT scale (Priest 1933). The MIREDS then also entered the interfaces of the control systems of LED luminaires; although not strictly necessary, they provide a more comprehensive selection range that considers the technician's preferences. The MIREDS are calculated by dividing 1 million by the color temperature to be converted; therefore, a MIREDD shift is obtained by subtracting the starting value from the target one. For example, a daylight type source (6500K) is equal to about 154 MIREDD. In order to convert it to an incandescent type warm light source, a shift of 158 MIREDD is required, obtainable with a full CTO gel filter.

### ***COLOR RENDERING ISSUES***

The most common method of determining the color rendering of a light source is to use it on specific sample colors and evaluate how much it differs in rendering these samples compared to a reference source. Around the mid-1900s, the advent of fluorescent sources and their early way of rendering colors raised the need to invent a method for determining the chromatic quality of sources. The CIE proposed a comparison method of color rendering evaluation, the CRI (Color Rendering Index). Today the CRI presents numerous issues that cause criticism and requests for revision (Davis and Ohno 2009; Fumagalli et al. 2015). First of all, the system is based only on 8 color samples of low saturated colors taken from the Munsell atlas. However, these 8 colors are not suited to discontinuous spectrum light sources, like metal halides or LEDs.

Alternative methods have been proposed to determine the colour rendering. Judd (1967) and Thornton (1974) proposed a subjective preference criteria for colours. Smet et al. (2010) have proposed a method based on psychophysical tests of visual similarity based on chromatic memory. Bodrogi et al. (2011) method is based on psychophysical tests regarding the perception of the difference of 17 colour samples, illuminated with both the test and the reference sources. The CQS index proposed by Davis and Ohno (2010) is based on 15 colour samples, chosen with high saturation, and uses a mathematical method different from the CRI. The method proposed by Hashimoto (et al. 2007) considers that a light source that provides an increase in the saturation of

the objects, or an increase in the ability of colour discrimination, has a positive impact on the perception of colour quality. The same principle is also used in the Freyssinier and Rea (2010) method, in which a colour gamut index is proposed alongside the CRI. A further and more recent color rendering index is the TM-30-20 (IES 2020), which uses a color gamut and a color fidelity index. Without debating on which index is the most appropriate, there is one thing in common: all these indexes have been designed to evaluate color rendering by the HVS. However, in the indoor sets, the observer is the camera. This crucial difference makes all classic color rendering indexes inadequate for television and cinema purposes. It was, therefore, necessary to study specific indexes for this sector.

In an attempt to remove the well-known problems of the CRI, the European Broadcasting Union (EBU), based on some preliminary studies (Sproson and Taylor 1971), developed two indexes for the television sector (EBU 2016), the Television Lighting Consistency Index (TLCI-2012) and the Television Luminaire Matching Factor in (TLMF-2013). TLCI-2012 removes the human observer regarding color discrimination, entrusting the evaluation to spectroradiometric measurement samples, the first 18 patches of the Macbeth ColorChecker (excluded the greyscale), compared with a reference sample. The chromaticity of the reference source used can be on the Planckian locus if the test source is below 3400K, the Daylight is above 5000K, or a linear interpolation between the two if the test light source is between 3400K and 5000K. The measured values are then processed by a specific software that simulates the typical characteristics of the cameras and displays where the image will be played. The considered parameters are responsivity curves, linear matrix, and optoelectronic transfer function or gamma-correction for cameras. As for the displays, instead, the parameters are the non-linearity or electro-optical transfer function, the chromaticity's of the set of primaries, and the white balance point. Once the calculations have been performed, the software returns a unique value (Qa) from 0 to 100, which indicates how feasible it is to attempt a chromatic correction on the source. The results must be interpreted according to the type of production; for example, film-type shots have a much more restrictive reading than live shots with different cameras.

The TLMF-2013 is very similar to the previous one. The main difference is that instead of an ideal reference source, a real one is used, which can be chosen according to the type of test source and specified in the results. The aim is to be more direct than TLCI in the evaluation of the mix between different sources. While TLCI is helpful for equipment manufacturers, TLFM is aimed at practitioners to predict a combination of sources before arriving on the set, where it is usually too late to intervene (Wood 2013).

A further index is the Spectral Similarity Index (SSI), developed in 2016 by experts from the Academy of Motion Picture Arts and Sciences (Holm et al. 2016). In the SSI, to avoid the excess of variability given by the human evaluation or numerous and different cameras, which may have spectral sensitivities that reach out of the visible spectrum, the variance of the test source related to the reference source is taken into account. Therefore, the spectral sensitivities of the various devices are not considered. It is evaluated how much, in certain regions of the spectrum, the test source spectrum differs from that of the reference source: Tungsten incandescent or Daylight. The purpose was to create a so-called "confidence factor". The result is an index (0 to 100) on the probabilities of the test source to render the colors in the same way as the reference.

## **CONCLUSIONS**

Solid-state light sources have now taken root in the entertainment lighting sector too. The efficiency of these sources is undoubtedly a plus for anyone. However, one of the main reasons why LED

technology is particularly desirable is the possibility of controlling numerous parameters of every single luminaire remotely. Indeed, some aspects will take some time to be accepted, such as comparing LEDs with high-power HMI sources. The latter are more available and less expensive for the same luminous flux. Still talking about economic aspects, the productions are often reluctant to invest in something that provides the same visual achievement obtained with traditional sources, looking only at the final result and not at man/hours and better management control processes. Finally, the irruption of electronics in a field historically dominated by electrical engineering leads to the need for staff improvement, introducing skills that were not widespread before; this requires a lengthy training process that often slows down production in a sector where timing is essential. In addition to the difficulties described above, there are other aspects to take into consideration. The advent of LEDs has enriched the color palettes of directors of photography. Numerous ways of standardizing color coordinates have been studied to have a common vocabulary. However, this made it even more evident that different cameras capture color in a slightly different way from each other. In addition to this, the reproduction of captured colors is done on devices, the user TV screens, that often have inadequate color gamuts. The light color can be created by adding different types of LEDs or by conversion using phosphors. In order to complicate things, these two approaches can include several methodologies and other elements. In the various steps necessary for video reproduction, metameric matches can frequently happen that were less common with the classic sources. In some aspects of the production, a high color rendering is desirable: make-up, wardrobe, brand identity, commercial products, logos. Their reproduction must not be distorted by light sources that are inadequate from a spectral point of view. Numerous efforts have been made to find a way to describe the ability of a light source to render color; the color rendering indexes of general lighting have existed for several years. However, they present some fundamental problems that make them unsuitable for the television and cinema lighting sector.

In this field, solutions usually do not derive from a scientific approach but rather from the experience of the professionals involved. At present, it is not yet conceivable that automatic processes can replace the specialized figures of technicians, even if some studies in this direction are already underway (Hsiao et al. 2017). The artistic nuances of the entertainment world are so varied that even those who have a good skill set, such as architectural lighting designers, may not deal with show projects on a professional level without first having accumulated experience.

## **REFERENCES**

- Applebee, L. G. 1950. Stage Lighting in the Post-War Theatre in Great Britain. *Lighting Research and Technology* 15 (8 IEStrans): 265-84.
- Bodrogi, P., S. Brückner, and T. Q. Khanh. 2011. Ordinal Scale Based Description of Colour Rendering. *Color Research & Application* 36 (4): 272-85.
- Box, H. C. 2020. *Set Lighting Technician's Handbook: Film Lighting Equipment, Practice, and Electrical Distribution*. Fifth edition. London ; New York: Routledge/Taylor & Francis Group.
- Davis, W., and Y. Ohno. 2009. Approaches to Color Rendering Measurement. *Journal of Modern Optics* 56 (13): 1412-19.
- Davis, W., and Y. Ohno. 2010. Color Quality Scale. *Optical Engineering* 49 (3): 033602.
- EBU. 2016. *TV Lighting Consistency Index 2012 & TV Luminaire Matching Factor 2013*. Geneva, CH: European Broadcasting Union. <https://tech.ebu.ch/publications/r137>.

- Freyssinier, J. P., and M. Rea. 2010. A Two-Metric Proposal to Specify the Color-Rendering Properties of Light Sources for Retail Lighting. In: *Tenth International Conference on Solid State Lighting*, 7784:77840V. International Society for Optics and Photonics.
- Fumagalli, S., C. Bonanomi, and A. Rizzi. 2015. Experimental Assessment of Color-Rendering Indices and Color Appearance under Varying Setups. *Journal of Modern Optics* 62 (1): 56-66.
- Hashimoto, K., T. Yano, M. Shimizu, and Y. Nayatani. 2007. New Method for Specifying Color-Rendering Properties of Light Sources Based on Feeling of Contrast. *Color Research & Application* 32 (5): 361-71.
- Holm, J., T. Maier, P. Debevec, C. LeGendre, J. Pines, J. Erland, G. Joblove, et al. 2016. A Cinematographic Spectral Similarity Index. In: *SMPTE 2016 Annual Technical Conference and Exhibition*, 1-36.
- Hsiao, S.-W., S.-K. Chen, and C.-H. Lee. 2017. Methodology for Stage Lighting Control Based on Music Emotions. *Information Sciences* 412-413 (October): 14-35.
- IES. 2020. IES Method for Evaluating Light Source Color Rendition. IES.
- Judd, D. B. 1967. A Flattery Index for Artificial Illuminants. *Illuminating Engineering* 58.
- Moller, L. E. 1980. Music in Germany During the Third Reich: The Use of Music for Propaganda. *Music Educators Journal* 67 (3): 40-44.
- Murano, F. 2017. *L'illuminazione Delle Opere Nelle Mostre d'arte*. Maggioli Editore.
- Pooky. 2016. 'Industrial Meets Art Deco – How Metropolis Helped Design the Future'. Blog. Light and Shade (blog). 3 April 2016.
- Priest, I. G. 1933. A Proposed Scale for Use in Specifying the Chromaticity of Incandescent Illuminants and Various Phases of Daylight\*. *JOSA* 23 (2): 41-45.
- Reid, F. 1970. Techniques of Stage Lighting. *Lighting Research & Technology* 2 (3): 125-34.
- Roth, L. 1978. "'Metropolis", The Lights Fantastic: Semiotic Analysis of Lighting Codes in Relation to Character and Theme'. *Literature/Film Quarterly* 6 (4): 342-46.
- Rutsky, R. L. 1993. The Mediation of Technology and Gender: Metropolis, Nazism, Modernism. *New German Critique*, 60: 3.
- Smet, K. A. G., W. R. Ryckaert, M. R. Pointer, G. Deconinck, and P. Hanselaer. 2010. Memory Colours and Colour Quality Evaluation of Conventional and Solid-State Lamps. *Optics Express* 18 (25): 26229–44. <https://doi.org/10.1364/OE.18.026229>.
- Speer, A., R. Winston, C. Winston, and E. Davidson. 1997. *Inside the Third Reich: Memoirs*. New York: Touchstone.
- Sproson, W. N., and E. W. Taylor. 1971. A Color Television Illuminant Consistency Index, BBC Research Department Report 1971-45. BBC.
- Strange, J. W., and H. Hewitt. 1956. Light and Colour in Daily Life. *Lighting Research and Technology* 21 (10 IEStrans): 255-76.
- Thornton, W. A. 1974. A Validation of the Color-Preference Index. *Journal of the Illuminating Engineering Society* 4 (1): 48-52.
- Vari-Lite. 2021. 'Vari-Lite'. Commercial. Vari-Lite. 2021. <https://www.vari-lite.com/global>.
- Williams, M. 1988. 'Pink Floyd and Company - Interview to Marc Brickman'. Pink Floyd and Company. 1988. [https://pfco.neptunepinkfloyd.co.uk/band/interviews/other/other\\_frame.html](https://pfco.neptunepinkfloyd.co.uk/band/interviews/other/other_frame.html).
- Wolfe, S. 2020. Fritz Lang's Metropolis. How the Iconic Silent Film Took Inspiration from Art Movements. *Artland Magazine* (blog). 11 December 2020.
- Wood, M. 2013. 'Television Lighting Consistency Index – TLCI'. Mike Wood - <https://www.mikewoodconsulting.com/articles/Protocol%20Fall%202013%20-%20TLCI.pdf>.

# User acceptance of innovative blue light therapy to treat seasonal affective disorder

Mengyuan Chen <sup>1,\*</sup> and Stephen Westland <sup>1</sup>

<sup>1</sup> University of Leeds, UK; sd19m2c@leeds.ac.uk, s.westland@leeds.ac.uk

\* Corresponding author: sd19m2c@leeds.ac.uk

## Abstract

Lack of exposure to light in the morning, and subsequent inactivation of non-imaging light-sensitive cells in the retina, is linked to a type of depression known as seasonal affective disorder (SAD). Many studies have confirmed the positive effect of early morning light therapy on patients with SAD. Studies have shown that blue-green light in particular (but light generally) can inhibit or promote the secretion of hormones such as melatonin and serotonin. This study investigates a new light therapy method where the light is used either as the person goes to sleep or just before they wake up, implemented with a light-emitting mask which is worn during sleep. This first part of the study evaluates user experience and user acceptance of using such a mask. A group of participants who have previously used traditional light therapy completed a survey about how likely they would be to use a light-emitting sleep mask; 80% of these participants expressed considerable interest. The benefits of such a treatment were identified in terms of reducing patients' awareness of the treatment and minimising the impact of the treatment on patients' families.

**Keywords:** Seasonal Affective Disorder, Sleep, Product Design, Light Therapy

## INTRODUCTION

Seasonal affective disorder (SAD) is a psychological disorder characterised by depression related to specific seasons (usually winter) (Thompson et al. 1996). Incurable sleep problems often accompany

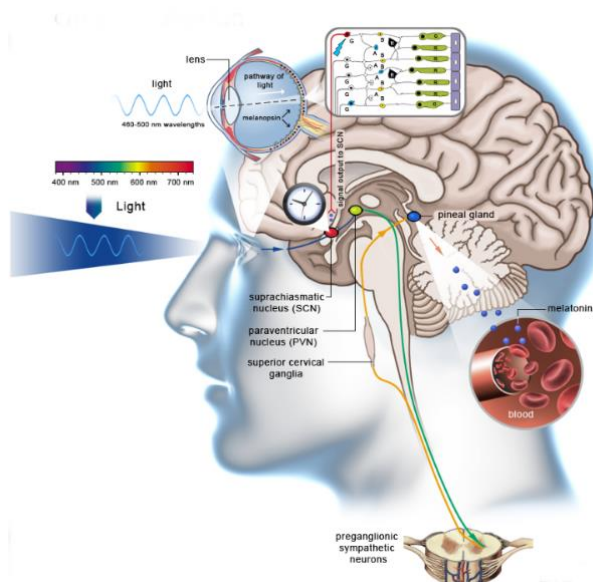

Figure 1: Circadian Rhythm (Neus and Roig 2014).

patients with seasonal affective disorder. This kind of depression is related to the length of the day or the brightness of the environment (Rohan et al. 2016). SAD is associated with limited exposure to light during the winter months in the Northern Hemisphere in particular. Light has many effects on the human body through non-image-forming (NIF) vision (Westland et al. 2017). Even with our eyes closed, the retinal cells can respond to light because the eyelids are translucent. Certain light-sensing cells in the retina, known as ipRGC, do not contribute to visual processes but their activation impacts the



release of some hormones and coordinate our circadian rhythm. Patterns of external light and dark conditions are transmitted to the pineal gland of the brain via the ipRGC cells. The pineal gland is associated with controlling several body functions, including the secretion of hormones (such as melatonin and serotonin), body temperature, and sleep cycles (Figure 1). At present, the primary methods for treating patients with SAD are light therapy and antidepressant medicines (Timonen et al. 2012). Compared with antidepressants, light therapy is less expensive and has no anticholinergic side effects (Byerley et al. 1987). Studies have shown that exposure to blue-green light with wavelengths of 470, 495 and 525nm at certain times of the day can inhibit melatonin secretion during the day and delay the secretion of melatonin in the late evening (Nussbaumer-Streit et al. 2020). For light sources with different spectral energy distributions, the effect on melatonin can be different under the same illuminance level. Bispectral bioclock glasses (see Figure 2) stimulate the retina with a specific wavelength of green light to inhibit the secretion of melatonin and a specific wavelength of red light at night to promote the secretion of melatonin (and induce the wearer to fall asleep). However, the current use of light therapy equipment is not without difficulty. For example, using light therapy products such as bioclock glasses can cause inconvenience and discomfort when doing housework or sports. In addition, some patients worry about affecting their family's daily rest or activities, so they do not comply with the recommended time that they should be exposed to bright light therapy in the morning (Figure 2). Psychologically, these may subconsciously enhance the patient's resistance to disease. This psychological resistance is not conducive to the treatment of the disease to a certain extent. From the patient's perspective, there is a need to reduce the psychological burden, understand the patient's subjective experience of the light therapy product and treatment methods and acceptance.

When we enter a sleep state, our brain activity has four stages (Clement et al. 2008). Each cycle of these stages takes about 60 to 90 minutes, and then from deep to light sleep, we enter the third and second stages again. This constitutes a cycle in the overall sleep pattern. Moreover, there will be five cycles in overall sleep (in the last three cycles, there will not be four complete sleep stages). The first stage is the falling asleep stage, mostly low-frequency, slightly larger brain waves-alpha brain waves, and theta brain waves. Alpha brain waves are also called awake brain waves, and the brain is still awake (Figure 3). During this stage, which lasts for more than 10 minutes, we can be easily awakened by external stimuli. The second stage, which typically lasts about 20 minutes, is the light sleep stage, during which we can still easily be awakened. There are occasional brief bursts of brain waves with high frequency and large amplitude-sleep spindles and K-Complexes (Caporro et al. 2011). REM sleep generally refers to rapid eye movement sleep, which is the last stage of sleep (Karni et al. 1994). The physiological electrical activity of the brain changes rapidly, and the delta waves disappear. There are high-frequency and low-amplitude brain waves, which are very similar to individuals in a waking state.



Figure 2: Biological Clock Glasses and Bright Light Therapy Box.

It has always been believed that brain activity will be significantly reduced or even disappear in the early stages of sleep. However, studies have shown that REM sleep accounts for 20% of the entire sleep process (Corsi-Cabrera et al. 2006). This fact overturns the generally accepted view that sleep is caused by the cessation of brain activity. Although consciousness is relatively slow, the brain is still about 80% active, and it also has refined information processing capabilities. A brief guided light during the light sleep phase seems to be a better choice.

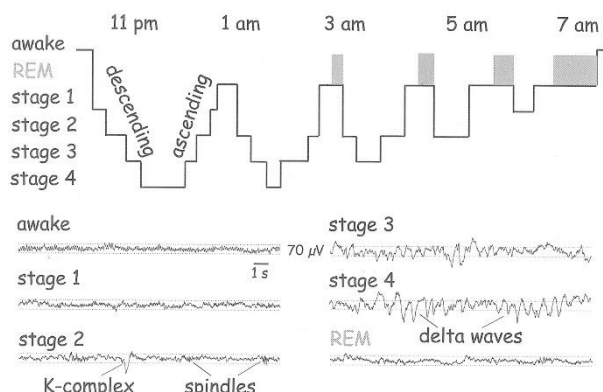

Figure 3: Non-rapid eye movement sleep (non-NEM).

## DESIGN SOLUTION AND DEVELOPMENT

Public acceptance and use experience of light therapy products in humans has received little attention, and more attention is paid to the efficacy of light therapy. Nevertheless, it is essential to pay attention to the patients' experience and well-being for light therapy products that treat mental illnesses like SAD. This work focuses on exploring whether innovative forms of lighting can increase the acceptance and well-being of patients with seasonal affective disorder. Specifically, the current direction of innovation is to study the use of guided light therapy eye masks during sleep.

Solving problems through innovative thinking is relatively easy, but Contradiction is the core. Contradiction refers to the observation that harmful behaviours usually increase when effective behaviours are increased. When increasing the comfort of light therapy products, does it reduce their therapeutic effects as sleep aids? To overcome the corresponding contradictions and design a new solution, an innovative sleep eye mask was designed. Product design is an iterative process from analysis to synthesis, mainly composed of three phases: demand analysis, conceptual design and detailed design (Prats et al. 2006). The confirmation of the early design direction is to accumulate data and obtain user personal information through two-process questionnaire surveys. Three aspects have been taken into account; first of all, the relevant facial wearable light therapy equipment will affect the patient's daily life to a certain extent. Second, although bright light therapy has a positive effect, it usually affects other family members when used in the morning and may cause glare to elderly users. The final innovative idea is to design a light therapy eye mask for patients to use during sleep. Grasp the treatment time during the sleep phase and the awake moment. In order to alleviate the resistance of patients in using therapeutic products, reduce the inconvenience that may be caused by daily use of therapeutic products. Improve the utilization of therapeutic products. Try to reduce the impact on life while ensuring the effect. In addition, the choice of lighting parameters is also significant.

Illumination is the primary function of sleep eye masks, and the role and selection of lights need to be more cautious. In 2004, Australian professors Wright and Lack's research results showed that

User acceptance of innovative blue light therapy to treat seasonal affective disorder shorter wavelengths of 470, 495 and 525 nm led to the earliest melatonin secretion (Lack et al. 2007). The above cases show that red light can promote melatonin secretion, while blue-green light can delay melatonin secretion until night. Irradiating the retina with red light can promote melatonin secretion and make the human body quickly enter a state of sleep; irradiating the retina with green light can inhibit the secretion of melatonin and make the brain wake up quickly thereby regulating the body's biological clock rhythm. This is the healthiest and most effective way.

## EVALUATION

It is determined that this innovative product is guiding lighting during sleep. The innovative product requires users to make simple settings before going to bed. The specific lighting time setting (see Figure 4) can be adjusted according to the individual's sleep time.

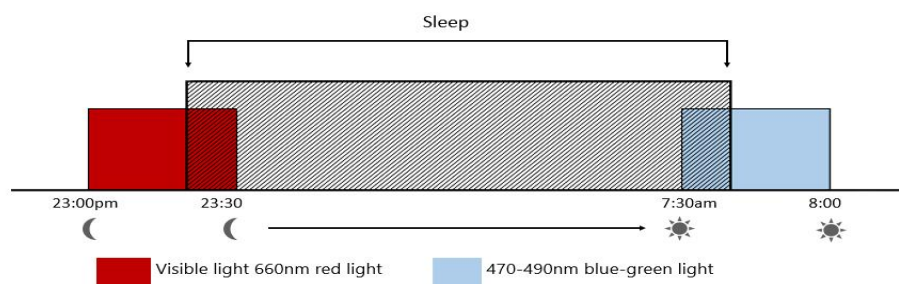

Figure 4: Use process design.



Figure 5: Eye Mask Design.

The recommended use time is half an hour for each stage. After finishing the setting of two stages, patients could wear it and go to bed, and the light will automatically turn on and off at the set time. The first stage of the light therapy duration is preset for half an hour before bed with dim-red light modes of a specific wavelength. This lighting stage will cover the awake period, the first stage of sleep and part of the second sleep stage. Then, after the first stage of illumination ends, the human body enters a stable sleep state, and the eye mask is used as a light-shielding eye mask at this time. The second stage of the light therapy duration is preset for half an hour before waking up, and blue-green light modes of a specific wavelength are used for waking up (Figure 5). The light at this stage is mainly for awakening and will cover part of the first stage of sleep and REM sleep stage in the last cycle of overall sleep and part of the awake period.

In the final A/B Test, the control group was set to two circadian colour glasses. The online simulation test of the innovative light therapy eye mask is also performed on patients who have used this group of bioclock glasses. The final A/B test can only be completed through a questionnaire survey. A total of 25 people completed the test, and the participants were randomly assigned to the control group (biological clock glasses) or the innovative product group (sleeping eye mask). The A/B Test data analysis method is used in the project evaluation stage. The acceptance and evaluation of participants

were collected through four aspects: appearance, charging method, use process, and family satisfaction (Table 1). Through the A/B Test, the study found that the sleep eye mask has less impact on a patient's daily life, and the overall comfort is 80% higher. ANOVA was performed on the existing circadian glasses and the newly designed sleep mask to analyze the significant differences between the two products to seek the reliability of the data. It can be seen that "Using process",  $F=6.989$ ,  $SIG=0.011$  ( $p<0.05$ ). Therefore, the evaluation of the using process between the two products is also significantly different.

		ANOVA				
		Sum of Squares	df	Mean Square	F	Sig.
Appearance	Between Groups	32.267	1	32.267	19.162	.000
	Within Groups	97.667	58	1.684		
	Total	129.933	59			
ChargingMethod	Between Groups	28.017	1	28.017	21.792	.000
	Within Groups	74.567	58	1.286		
	Total	102.583	59			
UsageProcess	Between Groups	12.150	1	12.150	6.989	.011
	Within Groups	100.833	58	1.739		
	Total	112.983	59			
NotImpactonFamily	Between Groups	77.067	1	77.067	75.420	.000
	Within Groups	59.267	58	1.022		
	Total	136.333	59			

Table 1: Appearance, charging method, use process, family satisfaction, the acceptance of these four aspects.

Research results show that the new sleep eye mask design provides patients with a better experience and can better meet the potential needs of patients. There are breakthroughs in use and wearing comfort. This research strives to explore and promote innovative forms of light therapy programs. And in the process of researching product interaction, minimizes the patient's rejection of disease treatment. The virtual model firstly provides a new form of therapy, which enables treatment and sleep to proceed simultaneously, and reduces the impact on the life of the patient and his family. The eye mask form also reduces the patient's suggestive effect on their disease, but the evaluation of the final test results is relatively simple. There are still some limitations in the research of this project. The design method mentioned in the article also needs further improvement to determine that this treatment is not just a placebo effect. However, studies have confirmed that even in sleep, the brain still maintains a certain degree of activity. But there is no detailed research on this point of view.

## CONCLUSIONS

An unresolved problem in previous studies is that all aspects of the human experience will affect people's understanding of product usability. This research also puts patient-product interaction in an important position. Because this is a new method, it needs to be continuously improved and improved in real applications. Its theoretical system needs to be supplemented (for example, the idea of parallel design, etc.). It also requires the support of mature cases in its application.

## REFERENCES

- Byerley, W. F., J. A. Brown, and B. Lebeque. 1987. Treatment of seasonal affective disorder with morning light. *The Journal of clinical psychiatry*.
- Caporro, M., Z. Haneef, H. J. Yeh, A. Lenartowicz, C. Buttinelli, J. Parvizi, and J. M. Stern. 2012. Functional MRI of sleep spindles and K-complexes. *Clinical neurophysiology* 123(2): 303-309.
- Clement, E. A., A. Richard, M. Thwaites, J. Ailon, S. Peters, and C. T. Dickson. 2008. Cyclic and sleep-like spontaneous alternations of brain state under urethane anaesthesia. *PloS one* 3(4): e2004.
- Corsi-Cabrera, M., Z. Munoz-Torres, Y. del Río-Portilla, and M. A. Guevara. 2006. Power and coherent oscillations distinguish REM sleep, stage 1 and wakefulness. *International Journal of Psychophysiology* 60(1): 59-66.
- Karni, A., D. Tanne, B. S. Rubenstein, J. J. Askenasy, and D. Sagi. 1994. Dependence on REM sleep of overnight improvement of a perceptual skill. *Science* 265(5172): 679-682.
- Lack, L., T. Bramwell, H. Wright, and K. Kemp. 2007. Morning blue light can advance the melatonin rhythm in mild delayed sleep phase syndrome. *Sleep and Biological Rhythms* 5(1): 78-80.
- Nussbaumer-Streit, B., A. Greenblatt, A. Kaminski-Hartenthaler, M. G. Van Noord, C. A. Forneris, L. C. Morgan, B. N. Gaynes et al. 2019. Melatonin and agomelatine for preventing seasonal affective disorder. *Cochrane Database of Systematic Reviews* 6.
- Prats, M.I., C. Earl, S. Garner, and I. Jowers. 2006. Shape exploration of designs in a style: Toward generation of product designs. *AI EDAM* 20(3): 201-215.
- Rohan, K. J., J. Meyerhoff, S.-Y. Ho, M. Evans, T. T. Postolache, and P. M. Vacek. 2016. Outcomes one and two winters following cognitive-behavioral therapy or light therapy for seasonal affective disorder. *American Journal of Psychiatry* 173(3): 244-251.
- Thompson, C., P. Childs, I. Rodin, and N. Martin. 1996. The biology of seasonal affective disorder: Are there winter summer differences?. *European Psychiatry* 11(S4): 165s-165s.
- Timonen, M., J. Nissilä, A. Liettu, J. Jokelainen, H. Jurvelin, A. Aunio, P. Räsänen, and T. Takala. 2012. Can transcranial brain-targeted bright light treatment via ear canals be effective in relieving symptoms in seasonal affective disorder?—A pilot study. *Medical hypotheses* 78(4): 511-515.
- Westland, S., Q. Pan, and S. Lee. 2017. A review of the effects of colour and light on non-image function in humans. *Coloration Technology* 133(5): 349-361.

# Colored light shapes. Protect and enhance the colors of artworks

Oscar Santilli <sup>1,\*</sup>

<sup>1</sup> Lighting Designer; o.santilli@archiworld.it

\* Corresponding author: o.santilli@archiworld.it

## Abstract

In the lighting of works of art a part of the composite light that invests the same artworks is absorbed and a part is reflected. The colors of the absorbed light are the complementary colors of the reflected light. For many objects of the enlightened world the absorbed light plays a physiological function (plants, photoluminescent materials, photovoltaic panels, etc.). But the works of art are generally inert. Absorbed light causes chemical and mechanical damage. For this reason, the rules impose limits. In order to avoid or limit absorptions, it was decided, therefore, to offer the artwork only the light that it will be able to reflect and not the light that it would be forced to absorb. Technically, it was a question of projecting an imprint onto the artwork with the shape and colors of the artwork itself. The experimentation verified the results: improvement of the effectiveness of illuminances with enhancement of luminances, plus other positive effects due to the serendipity of the technique adopted with improvements in vision and enrichment of the possible imaginary.

**Keywords:** *lighting design, lighting artworks, video projector, museum lighting*

## INTRODUCTION

For some years the writer has curated the illuminations of the artworks of also important artists (Giotto, Cezanne, Mondrian and others) as part of temporary exhibitions. It was a rewarding and evocative experience, both emotionally and professionally. The suggestions, understood as intrigue and suggestion, asked some questions whose answers matured slowly with a gradual process and still in progress. Some questions were logistically organizational and others qualitative concerning the light of the sources. The preparation times of temporary exhibitions are quite long, years, but the time of material preparation is quite short, a week or ten days. For the design and construction of the lighting system it is necessary to quickly compose the multiplicity of occurrences: examination of the design of the works to be exhibited, layout and supports (oil, tempera, maps, photos, scrolls, etc.), light sources, luminaires, optical equipment, wiring scheme and controls, placement of the luminaires, points, lighting measurements, balances of the luminaries of the scene, corrections of direct and indirect reflections, almost instantaneous adjustments according to the new indications of the curators and organizers. Finally: the magic of light, shapes and colors. A show!

Regulations relating to the lighting of works of art place limits on illuminations (values and duration) concerning to the photosensitivity of the supports. The illumination values of 150-200 lux for relatively insensitive materials (e.g. oil and tempera paintings, frescoes), of 50 lux for sensitive materials (e.g. watercolors, crayons, silk, color prints). The sources used are white light, i.e. composite light.

## ILLUMINANCES AND LUMINANCES

The light seen from the artwork is the light it receives from the source (illuminance), the light seen by the observer subject is that reflected by the artwork (luminance). Objects invested by light, i.e. illuminated objects, operate a discretion of light, making its components visible and/or intelligible: the colors. Some colors are reflected or transmitted (visible) others are absorbed (intelligible). The reflected part is perceived by observers and the absorbed part is "perceived" by the surfaces. Some types of lighting are aimed at physiological absorption. For example, magenta lighting (complementary color of green, absorbed radiation) of plants. This color activates the precious process of

photosynthesis, necessary for the autotrophy of the plant and the production of oxygen. It is an active response, such as photoluminescence or photovoltaic surfaces. Reflections, on the other hand, are experientially perceptible by the eye-brain system, through a sophisticated process in both hardware and software.

But the polychrome works are not able to metabolize the amounts of absorbed light, they are passive. Absorbed light causes chemical and mechanical damage. For these reasons the limits already described have been set.

### THE PROJECT

To avoid or limit absorption, it was decided to offer the work of art only the light that it will be able to reflect and not the light that it would be forced to absorb. Red light to red areas, blue to blue areas, so on. Technically it was a question of projecting an imprint on the work with the shape and colors of the work itself (Figure 1).

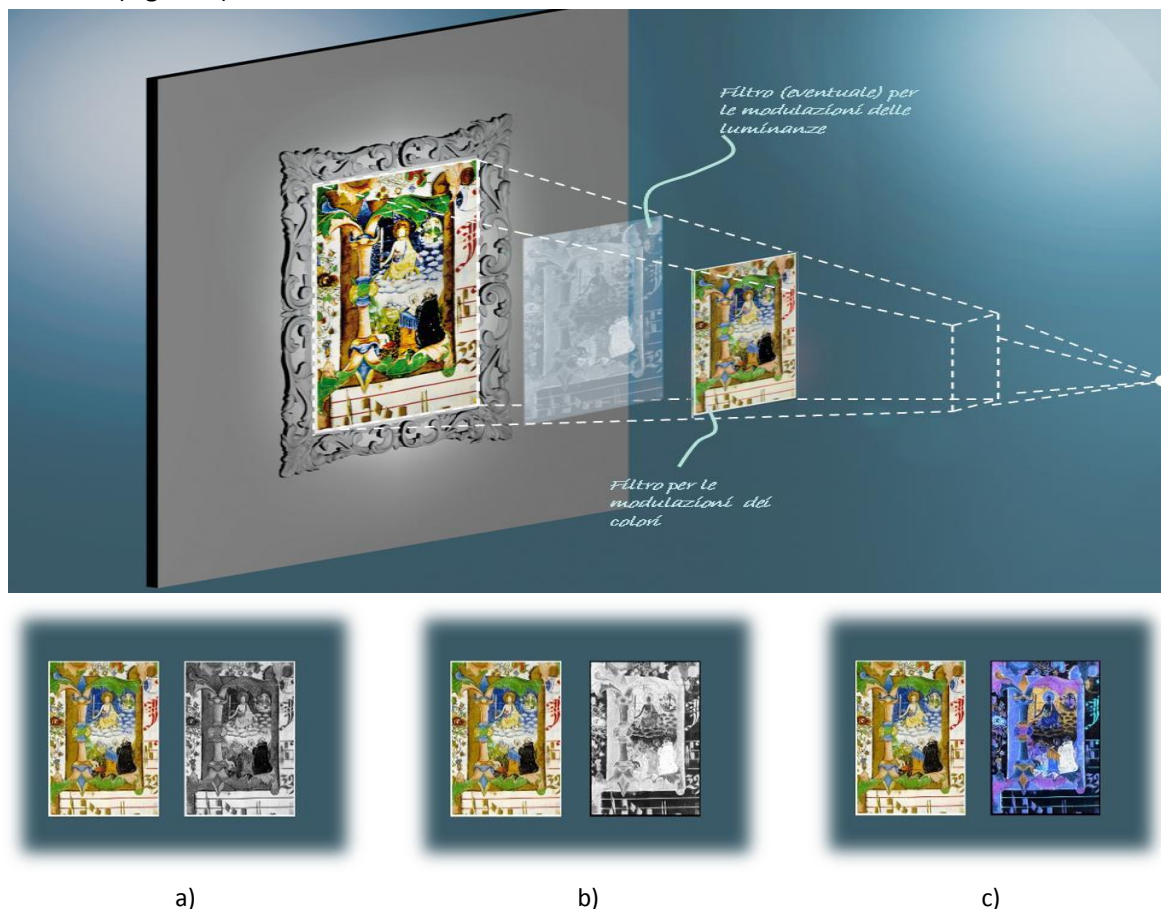

Figure 1: At the top the projection schema of the image of the artwork on the artwork itself. The projection is articulated with a mask for color modulation and a mask (if necessary) for modulation of intensity. Some masks are represented in a), b) and c).

In 2012 a research was carried out at the Faculty of Physics of the State University of Milan aimed at verifying the two hypotheses (reduction of absorptions and improvement of luminances). The research, within the resources available, verified both. The results were presented at the AIC 2013 Conference in Florence (Gargano et al. 2013). This idea combined with the adoption of new video projector technologies with their hardware equipment and new software applications (video mapping), during the stay at home due to lockdown, allowed experimentation.



## **VIDEO PROJECTORS**

Video projectors are generally equipped with a white light source filtered by RGB filters, which through modulations of light with gray masks, from black to white, one for each color channel, manage to project colored images. The technology for creating masks is very sophisticated. LCD transmission matrices or DLP reflection matrices are adopted. Matrices are in fact made up of micro windows that can be opened or closed. The opening or closing time modulated with 256 steps produces 256 corresponding shades of gray. In short, each small window behaves like a micro projector of light that can be modulated both in intensity and chromaticity. The video projection will then be able to project the bright and colored footprints. The image projected onto surfaces as in the case of any light projector, is defined as an imprint. Footprints consist of shapes and colors. In the case of ordinary conical projections, the imprints will be defined by the classic figures of the conical sections: circle, parabola, ellipse, hyperbola, etc. In the case of video projectors, imprints can be prepackaged or packaged live with digital video and mapping painting techniques.

## **LIGHT IMPRINTS**

The video projector, as mentioned, can offer any light defined in shape and color. So, according to the method already described, also the image of the artwork to be illuminated. The image has been defined through the programs and devices of acquisition, editing and digital painting. Different solutions have been adopted in relation to the colors present on the artwork. In addition to the projection of the pure RGB mask alone (previously acquired in an image format) it was possible to compose negative masks with positive masks, colored or in shades of gray. The masks could have any shape, even traditional, because they were prepackaged with the computer. As mentioned, the experiment was fully developed inside the home (with devices and software already available or acquired in the network) and therefore the artworks on which the experiments were carried out were those already hanging on the walls. Here we report the results on two artworks: an acrylic on paper (reproduction of an artwork) (Figure 2) and an oil painting (a bust of a woman) on canvas (Figure 3).

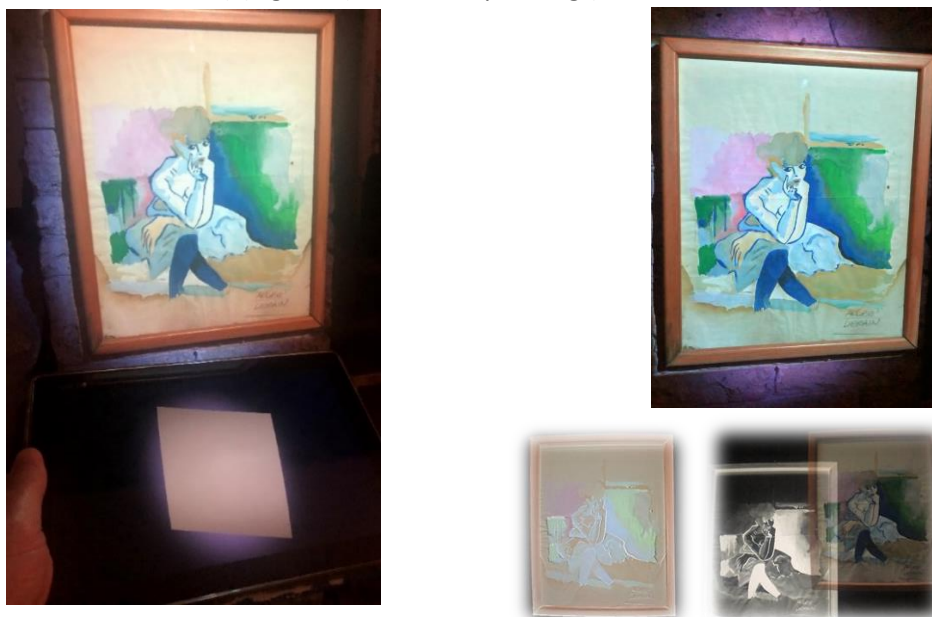

Figure 2: On the left - Paper illuminated with a monochromatic imprint. On the right – The same artwork illuminated with positive mask on negative gray mask.





Figure 3: Left column (illuminated artwork with simulation of ordinary light) and right column (artwork illuminated with the use of color maps and black and white). From top to bottom: illuminated artwork, maps and representation of the values of the illuminances and luminances.

Colored light shapes. Protect and enhance the colors of artworks

More relevant results: lower illuminances, reduced to what is necessary, with increased effectiveness in the production of luminances (with the same luminous flux), modularity of color parameters (saturation and tint) through the combination of masks (colored or in shades of gray, positive or negative), modulation of intensities and illuminances with the opacity or transparency of masks, improvement of contrasts with a strong reduction of veiling parasitic reflections.

Here are some macro data (see Figure 3 - images with values): the ratio of the two average illuminances (mask lighting and simulated ordinary lighting) is 0.377 while the ratio of the average luminances is 0.625.

In addition, the techniques and methods adopted have been suggestive. They suggested the creation of new scenes with the enrichment of the creativity of the domestic designer and the imaginary of the inhabitants of the house (example see Figure 4).



Figure 4: High - lighting of a niche. Below - Map of the projected shapes and colors. Enjoyable even independently.

## **CONCLUSIONS**

The methods described can combine the needs of the protection of artworks (reduce absorptions) with the best valorization (increase luminances with the same illuminance value) and know how to offer creative and therefore perceptual ideas. To give expression also to emotion, the visual process in its complexity is substantiated by the "visual body" described by Plato. The elements that make up this body, are the radiant source, the luminous effluvium (image) released by the object (immissionist theory), called "eidolon" by presocratic researchers, and the one released by the eye of the observer (emissionist theory) (Jori et al. 2020). We know that the subsequent scientific research and discernments, up to us, have deepened and extended the identities and functions of these actors, but basically the protagonists of the magical process of vision have remained those described by Plato. The proposed lighting method allows a conscious conversation between the perceived object and the percipient subject with the exchange of roles. The process (entry and emission) is cleaned by flows harmful to the artwork (reduction of absorbed light quotas) and to percipient subjects (glare patches and veils, smoothing of contrasts). Parasitic flows are intercepted already at the source (they become heat) and the artworks are not forced to absorb or reflect them (the reflection is not only due to the chromatic characteristics of the surfaces). The projectors are equipped with cooling fans because a good part of the light emitted is not projected and therefore becomes heat. They are not energy-saving lighting sources. They are distillers of the quality of the light. But they must produce the best light as rich as possible, so that they can choose the colors that the artwork needs, those that the artwork likes. Likewise, in the visual process the eye physiologically prepares to see white (producing, even energetically, what is necessary) and depending on the "eidolon" it receives, it builds the integral sensations necessary to complete the perceptual process. Returning his light to the artwork establishes an empathic relationship between the percipient subject and the artwork itself. The ratio is resonant, analogous to the ratio of the diapason to the sound wave, connoted in the identity of the frequency, able to excite it and make it vibrate. It's a conversation between subjects, at the speed of light (in the truest sense of words), to verify that what you want to show has actually been seen and what has been seen is actually what you wanted to show. A process consistent with natural processes (loved by presocratic researchers and their epigones, for example Lucretius) where the elements manifest their vocation to return to their place of origin (water to water, fire to fire, earth to earth and air to air). "From You I was born to You now I go!" (Cit). Natural processes are energetically supported by our sole energy supplier, the Sun. The methods described also need energy, the one generated by the source but, as already mentioned, energy is used in a selective qualitative way. A process that impulsive sensors could condemn but forget that good economics is not about consuming little but about consuming well. I find it hard to think that for the exhibition of works of art the energy factor is predominant over the enjoyment of the same artworks.

## **REFERENCES**

- Gargano, M., S. Scotuzzi, E.M. Angelin, O. Santilli, and N. Ludwig. 2013. Nuovi metodi d'illuminazione per la conservazione e la valorizzazione di opere pittoriche: uno studio preliminare. In: *Colore e colorimetria. Contributi multidisciplinari*, Associazione Italiana del Colore, M.Rossi e A. Siniscalco, ed. Sant'Arcangelo di Romagna (RN) Italy: Maggioli, 193-202.
- Jori, A. 2020. Aristotle's theory of colors between physics and physiology. In: *Medicina nei secoli Vol. 32/2, Journal of History of Medicine and Medical Humanities*, ed. Rome: University "La Sapienza", 491-452

1 COLOR AND MEASUREMENT INSTRUMENTATION	2 COLOR AND DIGITAL	3 COLOR AND LIGHTING	4 COLOR AND PHYSIOLOGY
5 COLOR AND PSYCHOLOGY	6 COLOR AND PRODUCTION	7 COLOR AND RESTORATION	8 COLOR AND BUILT ENVIRONMENT
9 COLOR AND DESIGN	10 COLOR AND CULTURE	11 COLOR AND EDUCATION	12 COLOR AND COMMUNICATION MARKETING

## 4 COLOR AND PHYSIOLOGY

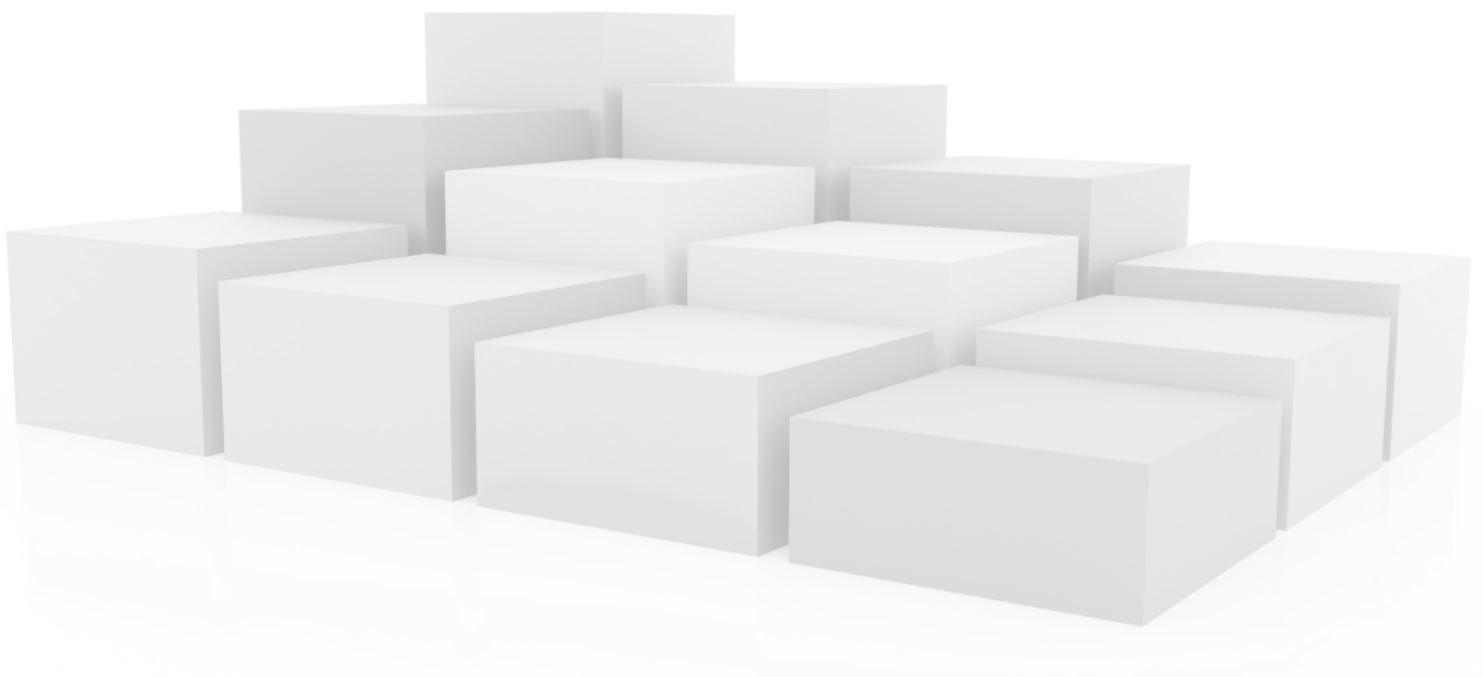



# Effect of ipRGC on Colour Perception of Display Device under Various Illuminants

Kota Akiba <sup>1</sup>, Midori Tanaka <sup>2</sup> and Takahiko Horiuchi <sup>1,\*</sup>

<sup>1</sup> Graduate School of Science and Engineering, Chiba University, Japan; kohta8@chiba-u.jp, horiuchi@faculty.chiba-u.jp

<sup>2</sup> Graduate School of Global and Transdisciplinary Studies, Chiba University, Japan; midori@chiba-u.jp

\* Corresponding author: horiuchi@faculty.chiba-u.jp

## Abstract

In current displays, colour reproduction is performed colorimetrically based on the perception amount of the LMS cones in photopic vision. However, previous studies have suggested that ipRGCs may affect visual perception. If ipRGCs influence colour perception, in addition to what is perceived by the LMS cones, it is necessary to consider the effect of ipRGCs on the colour reproduction of display devices. The aim of this study is to verify the effect of ipRGCs on displays under various illuminants in an experimental environment. In the experiment, colour matching was performed between a colour patch and a reproduced image on a high-luminance display under LED illuminants. The results indicate that ipRGCs may also contribute to the colour vision pathway regardless of the colour temperature of the illuminant. We derive the correction formula of CIE XYZ by correcting XYZ values with the ipRGC absorption rate.

**Keywords:** *ipRGC, colour reproduction, colour perception, display*

## INTRODUCTION

At the beginning of this century, cones, and photoreceptors other than rods were discovered in the retina of mammals and were named “intrinsically photosensitive retinal ganglion cells” (ipRGCs; Berson et al. 2002). The ipRGC is a special ganglion cell containing the visual substance melanopsin, whose spectral sensitivity function was defined by the Commission Internationale de l’Eclairage (CIE 2018) with a peak at approximately 490 nm. In earlier research, it was believed that ipRGCs influence non-image forming functions, such as regulation of circadian rhythm and the pupil light reflex (Hattar et al. 2002). However, recent studies have increasingly revealed influences on visual perception such as brightness perception (Brown et al. 2012). These experiments were performed in a tightly controlled environment.

In current displays, colour reproduction is performed colorimetrically based on the amount of LMS cones involved in perception in photopic vision. However, as mentioned above, previous studies have suggested that ipRGCs may affect visual perception. If ipRGCs influence colour perception in addition to what is perceived by LMS cones, it is necessary to consider the effect of ipRGC on the colour reproduction of display devices. Akiba et al. (2019) attempted to analyse a fundamental colour matching experiment in which patches and display reproduction colours were visually juxtaposed. Akiba et al. (2020) also verified the effect of ipRGCs on displays in binocular vision in an experimental environment in which patches and display reproduction colours were physically juxtaposed. However, the illuminant condition was maintained at 6000 K. The aim of this study is to verify the effect of ipRGCs on displays in an experimental environment under various illuminants.

## EXPERIMENTS

In this experiment, colour matching was performed between a colour patch and a reproduced image on a high-luminance display under 5000 K, 4000 K, and 3000 K LED illuminants in addition to 6000 K, as studied by Akiba et al. (2020). As the spectral distributions of these colours are different, it was



hypothesised that if ipRGC affects colour perception, the colour difference will not always be minimal. To control the influence of the rods, we used a high-luminance liquid crystal display (SHARP PN-A601) with  $1850 \text{ cd/m}^2$  after colour calibration. Pieces of drawing papers toned by Japan Colour Enterprise Co., Ltd. to the colour of the X-Rite ColorChecker were used as the real colour patches. Seven colours (red, blue, moderate red, blue sky, magenta, cyan, and white) with comparatively high reproducibility from 24 colour patches were used as the colour stimuli in this experiment. In addition to confirming the effect at approximately 490 nm, that is, the peak visibility of ipRGCs, many short- and long-wavelength components of various colours were selected. The CIE1976  $\Delta E$  colour difference was an average of 1.41, under the four types of LED illuminants.

The experimental environment is illustrated in Fig. 1. The viewing distance from the observer to the display and colour patch was set at 150 cm, and the experimental environment was designed such that both stimuli could be physically juxtaposed and observed with both eyes. The viewing angle for each colour stimulus was  $3.4^\circ$ . It was shielded from light by black paper, except for the part showing the colour of the display. The colorimetric reproduction colour with the smallest colour difference was displayed for each stimulus as the initial colour. The experiment was performed after the training to accustom them to toning. The observer repeated the same experiment twice to evaluate the stability of the results. The colour-matching procedure was performed by independently adjusting the hue, saturation, and brightness. The adjusted colour on the display device was measured using a spectroradiometer (KONICA MINOLTA CS-2000) after the colour matching experiment. These were 11 observers (9 men and 2 women) with normal colour vision.



Figure 1: Experimental environment.

## **RESULTS AND DISCUSSION**

The CIE 1976 Delta E colour difference between the reproduced colour and the colour patch was calculated after colour matching based on the CIE1931XYZ and CIE2015XYZ colour-matching functions. However, because the results were almost the same, the results using CIE1931XYZ are shown below. The outliers for each colour of the experimental results were determined using the Smirnov–Grubbs test. Figure 2 illustrates the average statistical results of three types of illuminant conditions in the tests of the 11 observers for each colour stimulus, together with the colour difference of the colorimetric colour reproduction (initial colour). The deviation in the figure indicates the standard deviation. As shown in Figure 2, the average colour difference of the seven colours of the colorimetric colour reproductions was 1.4, with the values 4.3, 5.7, and 6.2 after colour matching under 5000 K, 4000 K, and 3000 K LED illuminants, respectively.

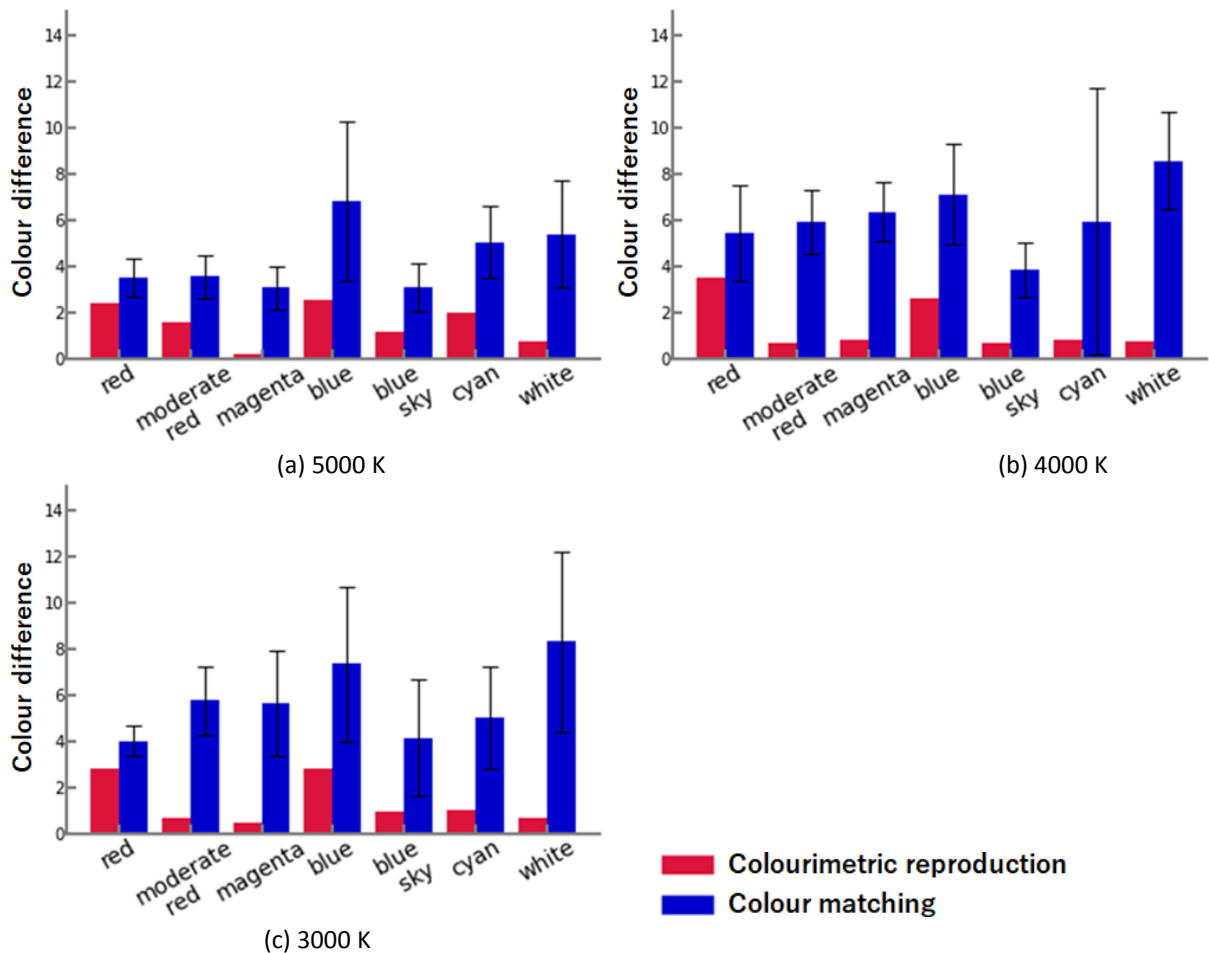

Figure 2: Average colour difference among the eleven observers.

The ratios of the colour differences, i.e.  $\Delta L^*:\Delta a^*:\Delta b^*$ , were 0.03:0.28:0.69, 0.09:0.25:0.66, and 0.10:0.28:0.62, respectively. The colour difference of  $b^*$  was large for all illuminant conditions. This result indicates that ipRGCs may also contribute to the colour vision pathway, regardless of the colour temperature of the illuminant. In addition, as shown in Figure 3, there was a large variation in the matching results of observers for the blue patch, which has a high ipRGCs absorption rate. This also suggests that there are individual differences in the ipRGCs.

The RGB colour-matching function for CIE1931 was derived from colour matching experiments using Guild and Light. Because this colour-matching function includes negative terms, the CIE1931 XYZ colour matching function was derived by basis transformation, which assumes that the LMS-cone signals are independent. However, we hypothesised that the LMS-cone signal would reach the ganglion cells and be biased by ipRGCs in the ganglion cells. Therefore, the correction formula for CIE XYZ obtained by correcting each value of CIE XYZ with the ipRGC absorption rate was derived by regression with the dependent variable as 'CIE XYZ of a real colour patch' and the independent variables as 'ipRGC absorption rate' and 'CIE XYZ of the reproduced colour on the display after colour matching.' In this regression, 154 datasets were observed, 22 times for each of the seven colour stimuli. The ipRGC absorption rate was calculated using the spectral sensitivity of ipRGCs (CIE 2018) and the spectral distribution of the reproduced colours on the display.



Effect of ipRGC on Colour Perception of Display Device under Various Illuminants

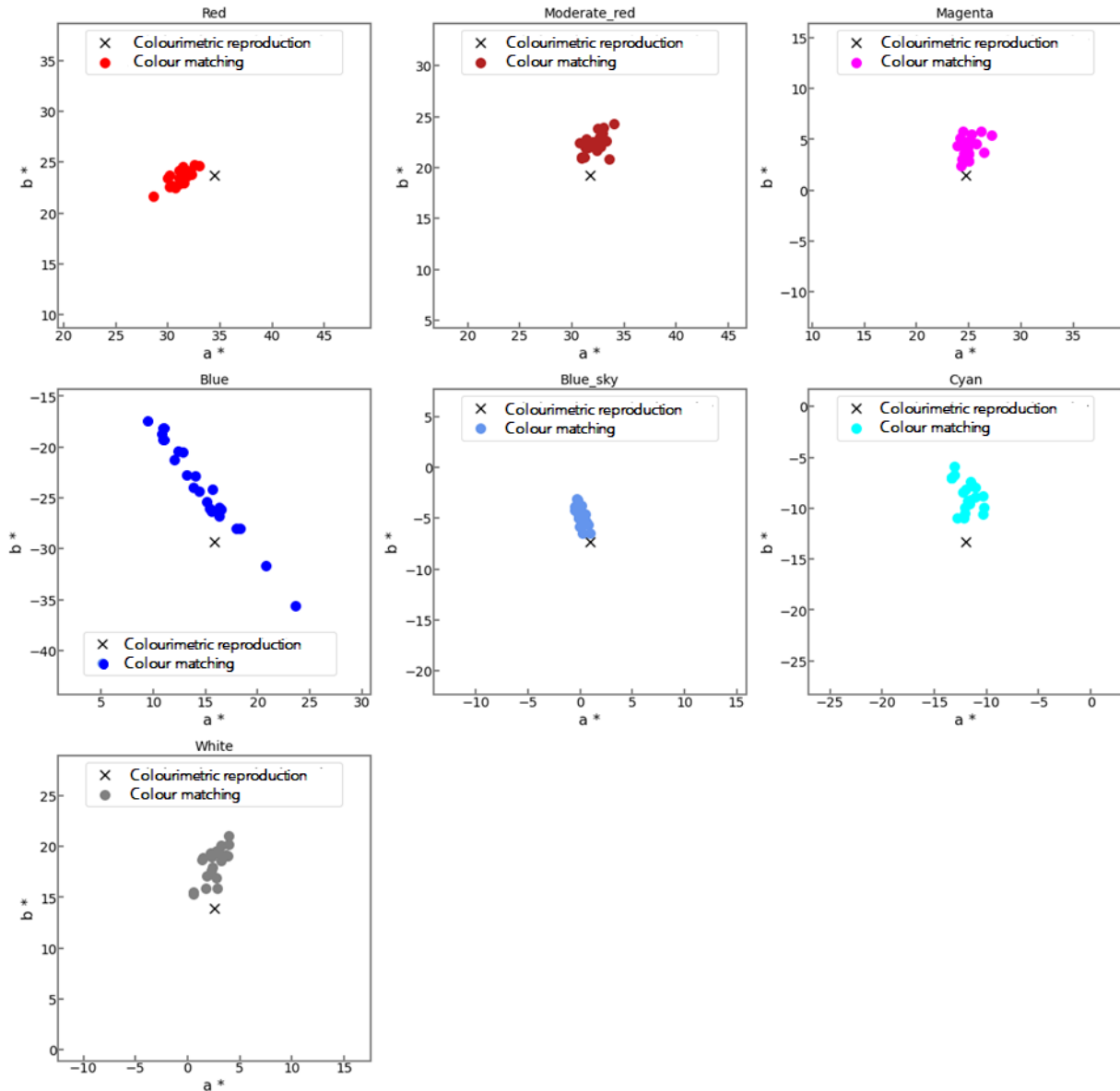

Figure 3: Matching results of all trials on the a\*-b\* plane (5000K).

We examined the following two types of correction formulas.

(Linear)

$$XYZ_{ipRGC} = a + b \times ipRGC + c \times XYZ_m,$$

(Non-linear)

$$XYZ_{ipRGC} = a + b \times ipRGC + c \times ipRGC^{1/3} + d \times XYZ_m + e \times XYZ_m^{1/3},$$

where  $XYZ_{ipRGC}$  and  $XYZ_m$  represents the corrected XYZ values and the CIE XYZ values of the reproduced colour on the display device after colour matching, respectively. The variable  $ipRGC$  is the ipRGC absorption rate of the reproduced colour. Table 1 illustrates the CIE1976 colour differences using each correction formula. As demonstrated in the table, by using the correction formula, the colour difference improved, suggesting the necessity of ipRGCs in colour perception of displays. The accuracy was slightly better when the nonlinear correction formula was used.

	CIE1931XYZ	Corrected XYZ	
		Linear	Non-linear
5000K	4.3	3.4	2.9
4000K	5.7	3.3	2.4
3000K	6.2	3.4	2.7

Table 1: CIE1976 colour difference by adopting each XYZ formula.

## CONCLUSIONS

In the colour-matching experiment using a high-luminance display, colour perception of the display was influenced by ipRGCs. This effect was observed even when colour matching was performed under various illuminant conditions in the same way as in the previous study that included illuminant condition fixed at 6000 K. We assumed that the LMS-cone signals were biased by ipRGCs in the ganglion cells. In this study, we also derived the correction formulas of CIE XYZ acquired by correcting XYZ values with the ipRGC absorption rate. For all illuminant conditions, the colour difference improved, suggesting the necessity of ipRGCs in the colour perception of displays.

Further analysis is required to derive a more appropriate correction formula while considering the effect of ipRGCs on the perceptual model. In general, it is expected that the sensitivity of ipRGCs and cone sensitivity depends on the observer; therefore, we need to consider an experimental design that takes this into consideration.

## ACKNOWLEDGEMENTS

This work was supported by Grant-in-Aid of JSPS KAKENHI Grant Numbers 19K12038 and 20H05957.

## REFERENCES

- Akiba K., M. Tanaka, and T. Horiuchi. 2019. Experimental consideration on the effect of ipRGC for color reproduction on display device. In: *Proc. Midterm Meeting of the International Color Association*, Buenos Aires.
- Akiba K., M. Tanaka, and T. Horiuchi. 2020. Color matching consideration on the effect of ipRGC for color reproduction on display device. In: *Proc. 5th CIE Expert Symposium on Colour and Visual Appearance*, Hong Kong.
- Berson, D. M., F. A. Dunn, and M. Takao. 2002. Phototransduction by retinal ganglion cells that set the circadian clock. *Science* 295: 1070-1073.
- Brown, T. M., S. Tsujimura, A. E. Allen, J. Wynne, R. Bedford, G. Vickery, A. Vugler, and R. J. Lucas. 2012. Melanopsin-based brightness discrimination in mice and humans. *Current Biology* 22: 1134-1141.
- CIE (Commission Internationale de l'Éclairage). 2018. CIE system for metrology of optical radiation for ipRGC-influenced responses to light, CIE S 026/E:2018.
- Hattar, S., H. W. Liao, M. Takao, D. M. Berson, and K. W. Yau. 2002. Melanopsin-containing retinal ganglion cells: Architecture, projections, and intrinsic photosensitivity. *Science* 295: 1065-1070.



# Difference Scaling and Color Naming of Red-Green Color Deficiencies

Miyoshi Ayama <sup>1,\*</sup>, Minoru Ohkoba <sup>2</sup>, Tomoharu Ishikawa <sup>3</sup>, Shoko Hira <sup>4</sup> and Sakuichi Ohtsuka <sup>5</sup>

<sup>1</sup> CORE, Utsunomiya University, miyoshi@is.utsunomiya-u.ac.jp, miyoshi.ayama@gmail.com

<sup>2</sup> Graduate School of Engineering, Utsunomiya University; dt187102@cc.utsunomiya-u.ac.jp

<sup>3</sup> School of Engineering, Utsunomiya University; ishikawa@is.utsunomiya-u.ac.jp

<sup>4</sup> Graduate School of Science and Engineering, Kagoshima University; hira@eng.kagoshima-u.ac.jp

<sup>5</sup> International College of Technology, Kanazawa; otsuka@neptune.kanazawa-it.ac.jp

\* Corresponding author: miyoshi@is.utsunomiya-u.ac.jp, miyoshi.ayama@gmail.com

## Abstract

In Exp.1, internal color representations of congenital red-green color deficient observers (CDOs) and color normal observers (CNOs) were estimated using differential scaling method for the three types of stimuli, pairs of high-chroma color chips (Exp.1-1), pairs of medium-chroma color chips (Exp.1-2), and pairs of color names on a sheet (Exp.1-3). In Exp.1-1 and 1-2, significant difference was found between the results of CDOs and CNOs. In contrast to that, no significant difference between CDOs and CNOs was found in Exp.1-3. In Exp.2, color naming using free color terms and constrained to 11 basic color terms were conducted. Color representations for CDOs estimated from the constrained naming task are in between the results of color cards and color names. It is suggested that CDOs' internal color representations formed through visual perception and color names only are different, and they seem to integrate them when they assign color names to surface colors.

**Keywords:** Congenital color deficiency, difference scaling, MDS, color naming, internal color space

## INTRODUCTION

Several studies have reported that congenital red-green color deficient observers show color naming ability comparable to those of color normal observers (Jameson and Hurvich 1978; Paramei 1996; Bonnardel 2006; Lillo, et al. 2014). However, few studies have been done on the relation between recognition of color names and color perception of CDOs. Shepard and Cooper (1992) carried out the similarity judgement using pairs of color charts and color names for CDOs and CNOs. They also did color name experiments for monochromats and blind observers. They concluded that CDOs have the internal representation of color names similar to that of CNOs, while their color representation based on color charts differs from CNOs' reflecting their color vision deficiency. Number of CDO observers were seven protan and four deutan, and only the group data of different vision types were indicated in their study.

In this study, we employed ten observers for each of CNO, and two types of CDO, protan and deutan groups. We aim to investigate the relation between internal color representation formed by color names and that based on visual perception. Furthermore, to examine how color names and color perception interact when they assign color names to color chips, color naming experiment were carried out.

## EXPERIMENT

### Stimuli and experimental set-up

In Experiment 1, difference scaling was done, using the color cards consisted of pair of high chroma chips [Exp.1-1], the color cards consisted of pair of medium chroma chips [Exp.1-2], and the list of pair of color names written on a sheet [Exp.1-3]. Ten Munsell color chips (Table 1) were employed for each.

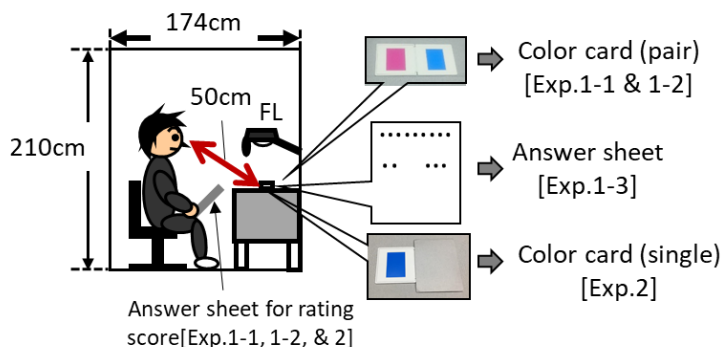

Figure 1: Experimental set-up and the stimulus of the Exp.1-1, 1-2, 1-3, and Exp.2.

Label	High-chroma	Medium-chroma
R	5R4/14	5R4/4
YR	5YR6.5/14	5YR6.5/4
Y	5Y8/14	5Y8/4
GY	5GY6.5/10	5GY6.5/4
G	5G4.5/10	5G4.5/4
BG	5BG/4/9	5BG/4/3
B	5B4/8	5B4/3
PB	5PB/4/12	5PB/4/4
P	5P4/11	5P4/3
PR	5PR/4/12	5PR/4/4

Table 1 Label and Munsell notation of the color chips

All combinations of 10 hues, i.e., color cards of 45 pairs were prepared for each of high and medium chroma groups. Two color chips were put in a light gray enclosure as shown in Figure 1. For Exp.1-3, 10 color names indicated in Table 2 that correspond to 10 high-chroma color chips for most of color normals were employed. Forty-five pairs of color names were written in the answer sheet in a random order.

Japanese color names in the answer sheet	English correspondence
赤, 橙, 黄, 黄緑, 緑, 青緑, 青, 青紫, 紫, 赤紫	Red, Orange, Yellow, Yellow-Green, Green, Blue-Green, Blue, Blue-Purple, Purple, Red-Purple

Table 2: Color names employed in the answer sheet of EXP.1-3

In Exp. 2, one side of the color card was covered by a gray envelope, and a single color chip was presented to the observer. Figure 1 shows the experimental set-up.

A color card was placed on nearly the center of the desk which was covered by a gray cloth (about N6.5) and illuminated by a fluorescent light (CCT:5000K). Horizontal illuminance at the color card was 560lx. Visual distance in the observation was about 50cm.

### Procedure

In Exps.1-1 and Exp.1-2, after a 10 minutes light adaptation to the visual environment, an observer was instructed to rate the perceptual distance between the two colors on a given color card using a scale of 1 (=Very close), 2 (=Rather close), 3 (=Neither close nor far), 4 (=Rather far), and 5 (=Very far). The observer wrote his rating score on the answer sheet that was given in advance. Forty-five color cards were presented in a random order. After a brief rest, the same 45 color cards were presented in different random order after inverting the left and right. Procedure in Exp.1-3 was similar to that of Exp.1-1 and Exp.1-2 except the answer sheet on which the combination of two color names and the numbers for rating score were written was placed on the desk instead of color card. The observer was asked to check the number that corresponds to his feeling of difference for a given color name pair. Therefore, observers did not see any color cards in Exp.1-3.

Several practice trials were done before the data collection. The order of the experiment was Exp.1-1, Exp.1-2, and Exp.1-3 for all observers, because of 1) difference scaling for high chroma cards appeared easier than that for medium chroma cards in the pre-experiment, 2) to avoid any effect of color names on difference scaling based on visual perception.

In Exp.2, a color chip was presented in a random order, and an observer was asked to give a single color name from 11 basic color terms of red, yellow, green, blue, orange, pink, purple, brown, white, gray, and black (Berlin and Kay, 1969). Ten high or medium chroma color chips were presented in a

random order, and presented again in a different order. This was repeated twice for each of high and medium chroma chips. In a session, either high-chroma, or medium-chroma chips were examined. The order of high- and medium-chroma sessions was randomized among observers. In addition to that, free color naming allowing any kind of color names and adjective were conducted, although the results are not shown in this paper due to the space limitation.

### Observers

Ten protans (5 protanomalous and 5 protanopes), 10 deutans (2 deuteranomalous and 8 deuteranopes), and 10 CNOs participated Exp.1-1 and Exp.1-3. Nine protans (4 protanomalous and 5 protanopes), 7 deutans (2 deuteranomalous and 5 deuteranopes), and 9 CNOs participated Exp.1-2.

Five protans (2 protanomalous and 3 protanopes), 5 deuteranopes, and 5 CNOs participated Exp.2. The age of observers ranged from 18 to 52, with more than half of the observers in each color vision type were in their twenties or thirties. All observers were examined for their color vision using Ishihara charts, panel D-15, and anomaloscope. Either anomalous trichromat or dichromat was based on the results of anomaloscope. Observers were all Japanese.

### RESULTS

Results of differential scaling in Exp.1-1(high-chroma), Exp.1-2(medium-chroma), and Exp.1-3(color name) were analysed by the MDS (Multidimensional scaling), and the resulted configurations on the plane of the 1<sup>st</sup> and 2<sup>nd</sup> dimensions are indicated in Figure 2 for representative observers in each color vision group. Results of the N20 (CNO) became circular arrangement similar to Munsell hue circle for high- and medium-chroma cards as well as the color names only (Figure 2 (a), (d), and (g)). On the other hand, concaved shape bending at 5Y and 5PB were found in the results of P14 (protanope) and D17 (deuteranope) in Exp.1-1 and Exp.1-2 (Figure 2 (b), (c), (e), and (f)). Most of other CDOs resulted more or less similar concaved shape in Exp.1-1 and Exp1-2. Only two protans, both protanomalous, and two deutans, one deuteranomalous and one deuteranope, showed circular shape in the results of Exp.1-1 and Exp.1-2. In contrast to these, shape differences between different color vision types are small in the results of Exp.1-3 shown in Figure 2 (g), (h), and (i).

To indicate the degree of shape distortion from a circle, we proposed the Distortion Index (*DI*) expressed equation (1) below (Ohkoba et al. 2020),

$$DI = \frac{\pi \cdot d_{max}^2}{4 \cdot S} \quad (1)$$

where  $d_{max}$  is the maximum distance in the MDS configuration in the 2D plane and  $S$  is the size of the area enclosed by the lines that connect 10 color chips, respectively. It has a unit value when it is a circle and increases as it deviates from rounded shape. *DI* values are indicated in each picture of Figure 2. Those of P14 and D17 in Exp.1-1 and Exp.1-2 (Figure 2 (b),(c), (e), and (f)) are particularly larger than 1 indicating marked shape distortion from circle. On the other hand, in the results of Exp.1-3, *DI* values of these observers are close to that of N20 indicating that their MDS results does not differ so much from that of CNO. Average values of *DI* for high-chroma, medium-chroma, and color name conditions are (1.52, 5.97, 6.91), (1.30, 8.45, 9.76), and (1.35, 1.90, 1.94) for CNOs, protans, and deutans, respectively. To examine the difference among color vision types, one way ANOVA was carried out for Exp.1-1, Exp.1-2, and Exp1-3, separately. Significant difference was found in Exp.1-1 ( $P=0.0064$ ) and Exp.1-2( $0.00032$ ), where sub effect test showed *DI* values of protan and deutan groups are significantly larger than CNO value. On the other hand, no significant difference was indicated among color vision types in the results of Exp.1-3 ( $P=0.104$ ).

We also examined intra-observer correlation among the results of the sub-experiments (Exp.1-1, 1-2, and 1-3). Distances of 45 pairs in the 1<sup>st</sup> vs 2<sup>nd</sup> dimension plane obtained by the MDS analysis were calculated and correlation between the sub-experiments were examined. Values of correlation coefficient are indicated below each column in Figure 2. For N20,  $R > 0.7$  was obtained for all three combinations indicating that the difference scaling in Exp.1-1, 1-2, and 1-3 is based on nearly the same criteria. On the other hand, observers P14 and D17 show  $R > 0.7$  between Exp.1-1 and 1-2, while their Rs are lower in the combinations with Exp.1-3, suggesting that their judgement using color name only was based on different criteria than those via color perception.

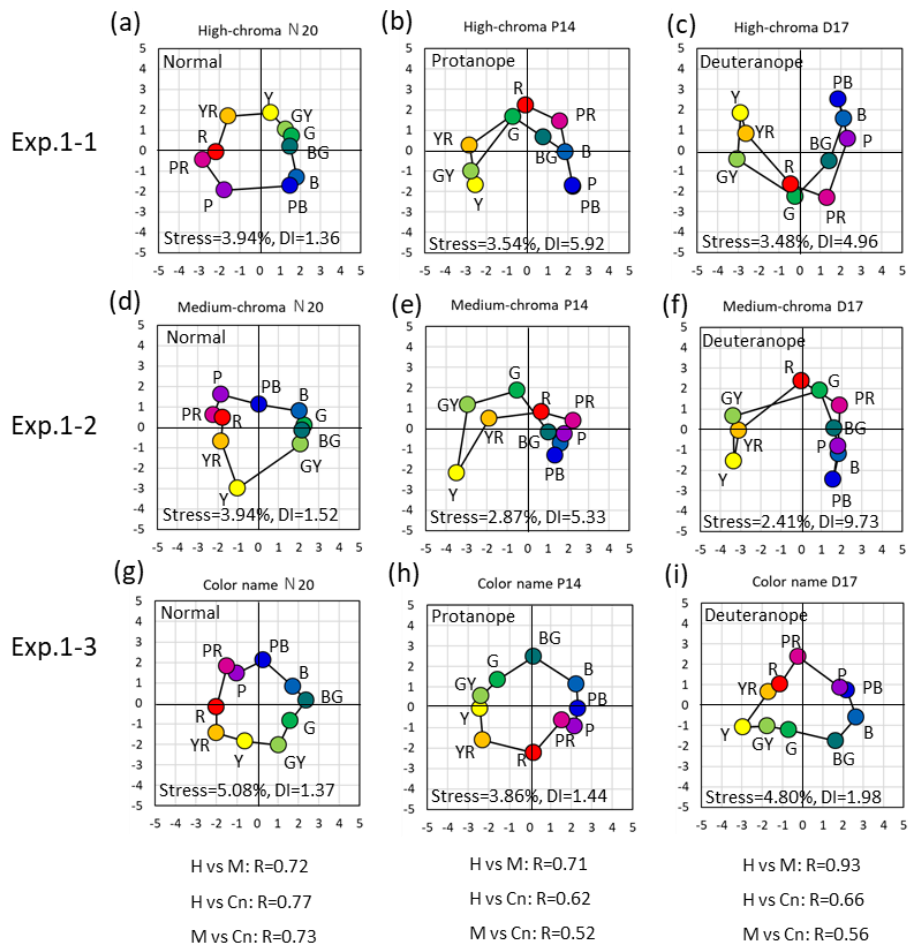

Figure 2: Color representations for CNO, protanope, and deuteranope observers. Results in Exp.1-1 (high-chroma cards), Exp.1-2 (medium-chroma cards), and Exp.1-3 (color names) are shown in the upper, middle, and lower rows, respectively.

In Exp.2, four elementary color chips (R, Y, G, and PB) with high-chroma were named as “red”, “yellow”, “green”, and “blue”, respectively, by all observers except two protans responded “brown”, and one deutan answered “orange” once for R. For other high-chroma color chips, difference among different color vision types were rather small, and thus the results are not shown here.

On the other hand, large variation appeared in the results of medium-chroma chips especially for CDOs as shown in Figure 3, where all responses (2 times x 5 obs.) were summed up and plotted for each color chip. In the results of CNO (Figure 3(a)), the same color name was commonly given to each color chip among different observers except R which was the only one chip named three different terms, “red”, “brown” and “purple”. Compared with less variant data for CNOs, most chips were named more than three color names in the results of CDOs. In protan results (Figure 3(b)), “gray”

appears frequently for R and RP, and BG and B, and “orange” was given to GY as well as YR. In deutan results (Figure 3(c)), “green” is assigned to a wide range of chips, and YR was mostly called “pink”. These tendencies are similar to those reported in previous studies (Bonnardel, 2006, Lillo, et al., 2014).

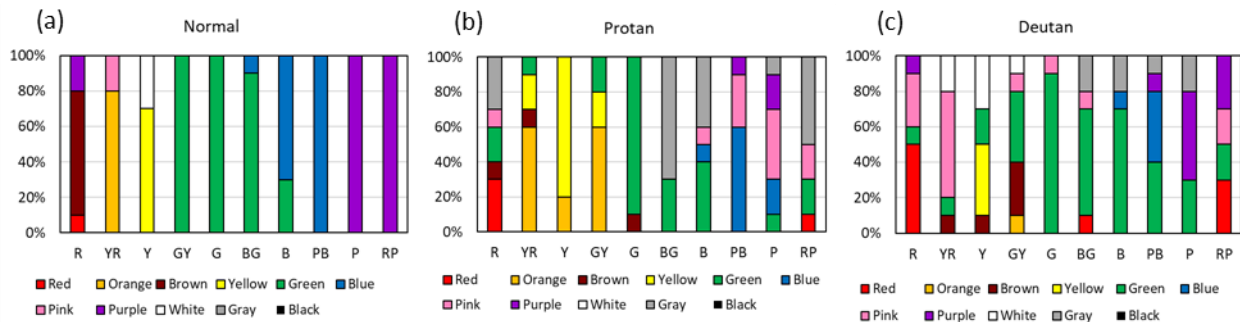

Figure 3: Results for medium-chroma chips using constrained color naming of color normal, protan, and deutan observers. Horizontal axis denotes the label of color chip indicated in Table 1.

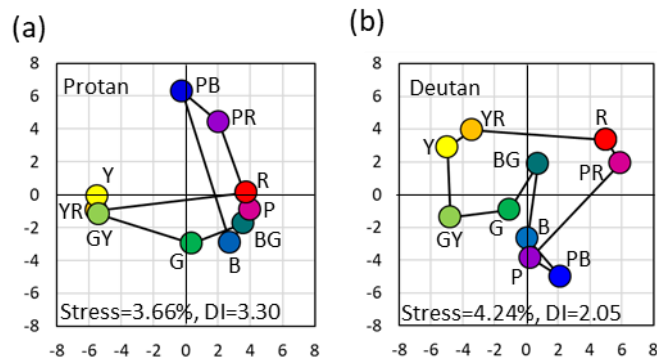

Figure 4: Color representations protan and deutan observers based on the constrained color naming results for medium-chroma chips.

To estimate the color representation based on color naming results, difference matrix for all pairs among the ten chips is needed. To obtain the matrix, we employed the method in which if a pair of stimuli, e.g. R and YR, was assigned different terms, say “red” and “orange”, by one observer, then it was counted 1, otherwise, the same terms, for example both were assigned “orange”, it was counted 0. This is similar to Bonnardel’s method (Bonnardel 2006). Each of 45 pairs has 10 data (2 repetitions x 5 obs.), and the counts were summed up. However, this procedure has a problem that the count is the same regardless of the kind of color term combination. For example, combination of “orange” and “red” is counted the same as that of “green” and “red”, generally the latter seems to be more distant than the former. In spite of this imperfection, if the same names occasionally appear in the neighbors being mixed with different names, estimated color representation would reflect a property inherent in a dataset to some degree. In that sense, the results of high-chroma chips for all groups and that of medium-chroma chips for CNO shown in Figure 3(a) did not match the present method. We conducted the MDS analysis, but the stress values were large, and thus they are not shown here. On the other hand, results in Figure 3 (b) and (c) for CDOs show a rich variation fit to the present method.

Figure 4 shows the color representations of medium-chroma chip for protans and deutans based on constrained color naming task. Result of protans became concaved shape similar to the results of color cards shown in Figure 2(b), (c), (e), and (f). However, the degree of concavity is rather mild with



DI value of 3.30 which is smaller than 8.45, the average of the medium-chroma cards for protans, but larger than 1.90, the average of color name for protans. Result of deutans shows partial concavity. DI value 2.05 is also in between 9.76, the average of the medium-chroma cards, and 1.94, the average of color name for deutans.

### **SUMMARY AND CONCLUSION**

It is shown that CNOs have one type of color representation, similar to hue circle, either formed by visual perception or color names only. In contrast to that, perceptually obtained CDOs' color representation reflects their color deficiency, whereas their color name space is close to that of CNOs', whatever the strength of color deficiency. Color name space in CDOs' brain is not influenced by visual perception, probably formed by their individual knowledge and experiences relating to color names and expressions of colors in literature. When CDOs assign basic color terms to surface colors, they seem to integrate their perceptually based color space and color name based color space to make a final decision. It should be noted that the same color names as those used in CNOs seem to be assigned without severe hesitation for high-chroma chips by the CDOs except YR and GY. We do not know what kind of cues were utilized by the CDOs at the present. In the color design of presentations, signage, or place directions, high-chroma colors should be used, and a careful usage is required for YR and GY even for the cases of high-chroma stimuli.

### **ACKNOWLEDGEMENTS**

The authors would like to thank Color Universal Design Organization to their collaboration to carry out the experiment.

### **REFERENCES**

- Jameson, D., and L. M. Hurvich. 1978. Dichromatic color language: "Reds" and "Greens" don't look alike but their colors do. *Sensory Processes 2*: 146-155.
- Paramei, G. V. 1996. Color space of normally sighted and color-deficient observer reconstructed from color naming. *American Psychological Society 7*: 311-317.
- Bonnardel, V. 2006. Color naming and categorization in inherited color vision deficiencies. *Visual Neuroscience 23*: 637-643.
- Shepard, R. N., and L. A. Cooper. 1992. Representation of colors in the blind, color-blind, and normally sighted. *Psychological Science 3*: 97-104.
- Ohkoba, M., T. Ishikawa, S. Hira, S. Ohtsuka, and M. Ayama. 2020. Analysis of hue circle perception of congenital red-green color deficiencies based on color vision model. *Proceedings of the 28th Color and Imaging Conference*. Society for Imaging Science and Technology. 105-108.
- Lillo, J., H. Moreira, L. Alvaro, and I. Davis. 2014. Use of basic color terms by red-green dichromats: 1. General description. *Color Res. Appl.* 39: 360-371.
- Berlin, B., and P. Kay. 1969. *Universality and evolution of basic color terms*. Berkeley: University of California Press.

# Effects of Colour on the Sense of Immersion in Virtual Interior Environments

Firdevs Gökmenoğlu<sup>1,\*</sup> and Saadet Akbay<sup>1</sup>

<sup>1</sup> Department of Interior Architecture, Faculty of Architecture, Çankaya University, Ankara, Turkey; iyibilginfirdevs@gmail.com, akbay@cankaya.edu.tr

\* Corresponding author: iyibilginfirdevs@gmail.com

## Abstract

This paper investigates the effects of colour on the sense of immersion in virtual interior environments. Since colour in interior environments is vital for the perception of place, the three dimensions of colour, namely hue, saturation, and lightness (HSL), were evaluated as elements for transferring colour to virtual environments (VEs). In this context, this study aims to investigate how the sense of immersion in virtual interior environments differs depending on hue, saturation, and lightness and examines the extent to which colour dimensions influence the sense of immersion in VEs. For this, the HSL colour space was utilised to establish varying degrees of colours. An online survey was conducted to understand the people's sense of immersion in different virtual interior settings. The study's results suggest that perception of colour influences the sense of immersion in virtual environments.

**Keywords:** *colour perception, colour experience, virtual environment, sense of immersion*

## INTRODUCTION

Virtual reality (VR) is a technology that enables users an immersive experience in virtual environments (VEs) through the stimulation of senses in virtual spaces. VR technology has been developed rapidly, particularly in computer graphics. A wide variety of new VR equipment has been used as a tool to measure the sense of immersion in VEs (Feisst 2011; Cadet and Chainay 2020). Immersion is studied as a concept in video games to create a compelling VE for drawing the player's attention. A set of design criteria to improve the VR design of 3D video games are considered in terms of the degree of immersion, engagement, and presence (McMahan 2003). Nowadays, VR technology is not only popular in video games but also in many areas. Immersion allows users to experience various sensations in the VEs, enhancing their spatial perception and sense of presence using one-to-one modelling and 3D visualisation technologies (Murray 1997).

Many studies have investigated the immersion in various forms of media, emphasising the significance of colour and light in virtual environments (Wästberg and Billger 2006). Brown and MacLeod (1997) found that colours in different nuances evoke several senses; hence, the sense of immersion in the virtual environment varies according to these colour divergences. Although the colour perception is considered one of the factors that influence the sense of immersion in a VE, few studies focus on colour as the main subject matter of investigating the immersion in spatial contexts (Stahre et al. 2009). This paper examines the effects of colour on the sense of immersion in virtual interior environments. This study aims to investigate how the sense of immersion in virtual interior environments differs depending on hue, saturation, and lightness and examines the extent to which colour dimensions influence the sense of immersion in VEs. For this, the HSL colour space was utilised to establish varying degrees of colours. This study can illustrate how colour perception in virtual interior environments influences our sense of immersion in a technical and practical approach to interior architecture using emerging technologies.

## THE STUDY

### Participants

A total of 228 participants voluntarily take part in the study. There were 165 females and 63 males among the participants, with 14 under the age of 18, 62 between the ages of 18 and 24, 84 between the ages of 25 and 34, 38 between the ages of 35 and 44, 28 between the ages of 45 and 64, and two over the age of 65. Participants were all of Turkish nationality.

### Stimuli

For the study, four different interior images were used, which were retrieved from the website of interior architect Kelly Wearstler (<https://www.kellywearstler.com/>). The HSL colour space of Adobe Photoshop CS6 was used to modify the degree of hue, saturation, and lightness of the selected images. While the degree of hue in each image was reduced to minus 10%, making the images warmer, the degree of saturation was reduced to minus 35%, making the images duller. The degree of lightness was reduced to minus 35% and increased to plus 35%, causing the images to appear darker and lighter (Figure 1).

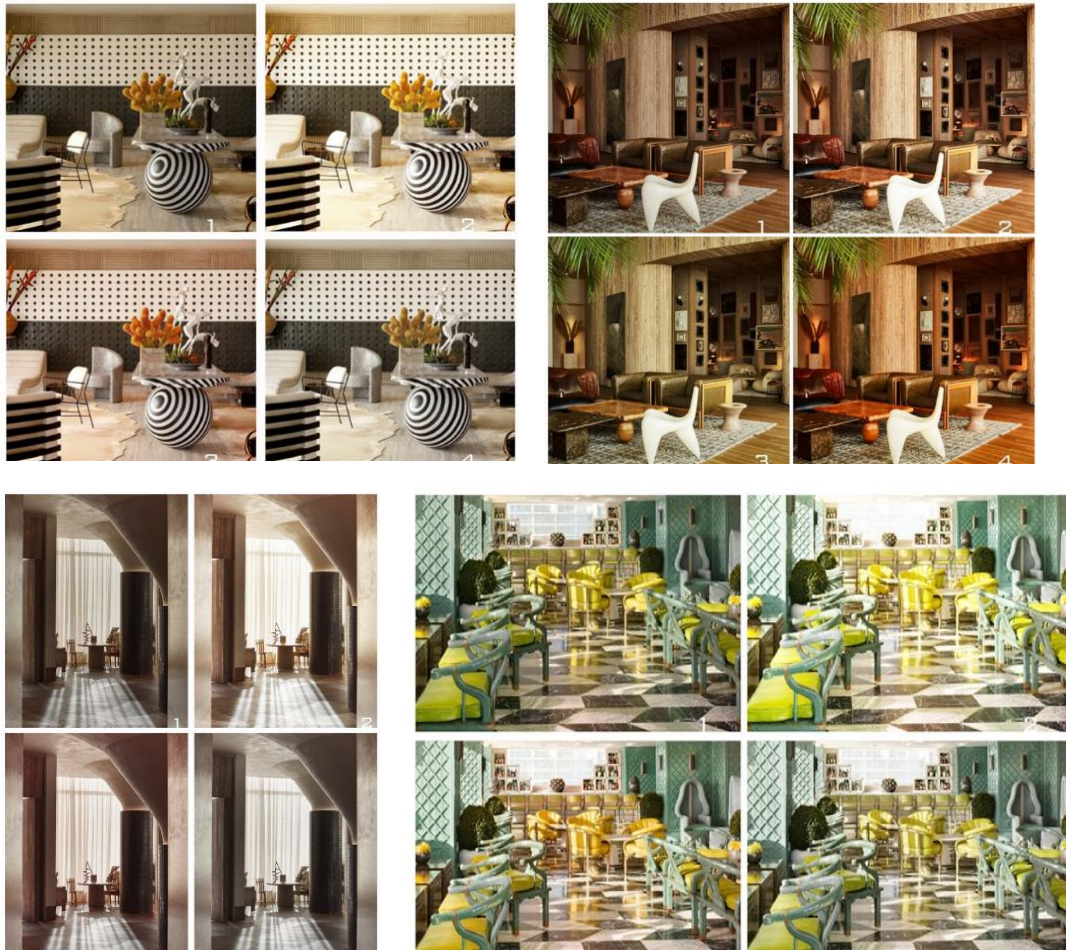

Figure 1: The interior images used in the study; in each image: 1) lightness -35%, 2) lightness +35%, 3) hue -10%, 4) saturation -35%

## Measures and Procedure

Due to the COVID-19 pandemic, we conducted an online survey to understand the sense of immersion in virtual interior environments. The questionnaire was divided into three sections. The first section focused on the demographic features of the participants, asking the questions such as age, gender, nationality, etc. The second section included the questions based on Ishahara's colour deficiency test. After completing the colour test, all participants were assured that their colour vision was normal. In the third section, participants were asked 'Which of the images gives you a sense of immersion in that virtual interior environment? Participants were then asked to select one of four sets of images with varying degrees of hue, saturation and lightness that best matched the question from a total of four different interior images.

## RESULTS AND DISCUSSION

Following the data collection via an online survey, the statistical analysis was carried out using IBM SPSS Statistics 23. The frequency distribution of the data was analysed, and the results are discussed in terms of each image in Figure 1.

In terms of the results of the first set of images (see Figure 1a), 31.1% of participants considered the image with a -35% degree of lightness (referring to #1) provided the most immersive virtual interior environment when compared to the other images. For instance, 24.1% of participants thought the image with a -10% decrease in hue (referring to #3) was immersive, whereas 23.2% thought the image had a -35% decrease in saturation (referring to #4) was immersive. The results indicate that 18.9% of participants found the image with a +35% increase in lightness (referring to #2) to be immersive. Regarding the results of the second set of images (see Figure 1b), 32.9% of participants considered the image with a -35% degree of lightness (referring to #1) provided the most immersive virtual interior environment when compared to the other images. However, 26.3% of participants considered the next immersive virtual environment with a +35% increase in lightness (referring to #2) and followed by the image with a -35% decrease in saturation (referring to #4), which was referred to by 23.2% of participants. According to the results, 14.5% of participants considered the image with a -10% decrease in hue (referring to #3) to be immersive.

Regarding the results of the third set of images (see Figure 1c), 33.3% of participants found the image with a +35% increase in lightness (referring to #2) to be immersive, followed by the image with a -35% decrease in saturation (referring to #4), which was referred to by 27.2% of participants. While 22.4% of participants thought the image with a -35% decrease in lightness (referring to #1) was immersive, 14.9% of participants thought the image with a -10% decrease in hue (referring to #3) was immersive. In terms of the results of the final set of images (see Figure 1d), 55.7% of participants considered the image with a +35% increase in lightness (referring to #2), provided the most immersive virtual interior environment when compared to the other images. 21.9% of participants considered the next immersive virtual environment with a -10% decrease in hue (referring to #3). These were followed by the image with a -35% decrease in lightness (referring to #1) and the image with a -35% decrease in saturation (referring to #4), referred to by 14.5% and 4.8% of participants, respectively.

As a result, the study's findings suggest that decreasing the degree of lightness of colours in a virtual interior environment improves the sense of immersion in that environment. In addition, whether in a virtual interior setting with natural or artificial lighting, increasing the degree of lightness of colours heightens the sense of immersion in that perceived environment. This paper explored the sense of immersion in virtual interior environments based on hue, saturation, and lightness and examined how these colour attributes influenced the sense of immersion in virtual environments. The use of images

of non-immersive 2D virtual interior environments in this study might be a limitation. Due to the COVID-19 pandemic, the study was carried out via an online survey. Therefore, the findings might be regarded as a preliminary study, which will serve as the basis for an idea on colour perception and experience for further studies on immersive 3D virtual environments.

### **ACKNOWLEDGMENTS**

The authors thank the participants who have voluntarily took part in this study.

### **REFERENCES**

- Brown, R. O., D. I. A. MacLeod. 1997. Color appearance depends on the variance of surround colors. *Current Biology* 7(11): 844-849.
- Cadet, L. B., H. Chainay. 2020. Memory of virtual experiences: Role of immersion, emotion and sense of presence. *International Journal of Human-Computer Studies* 144: 102506
- Feisst, M. E. 2011. Enabling virtual reality on mobile devices: Enhancing students' learning experience. In: *SPIE Eco-Photonics 2011: Sustainable Design, Manufacturing, and Engineering Workforce Education for a Green Future*, International Society for Optics and Photonics, Vol: 8065, 80650P.
- McMahan, A. 2003. *The Video Game, Theory Reader: Immersion, Engagement and Presence, a Method for Analyzing 3-D Video Games*. New York: Routledge.
- Murray, J. 1997. *Hamlet on the Holodeck: The Future of Narrative in Cyberspace*. Cambridge: The MIT Press.
- Stahre, B., M. Billger, K. F. Anter. 2009. To Colour the Virtual World-Difficulties in Visualizing Spatial Colour Appearance in Virtual Environments. *International Journal of Architectural Computing* 7(2): 289-308.
- Wästberg, B. S., M. Billger. 2006. Physical measurements vs visual perception: Comparing colour appearance in reality to virtual reality. In: *Conference on Colour in Graphics, Imaging, and Vision*, Society for Imaging Science and Technology, 146-151.

# Brightness evaluation under the closed-eye condition: Measurement of optical transmittance of eyelid

Hideki Sakai <sup>1,\*</sup>

<sup>1</sup> Graduate School of Human Life Science, Osaka City University; hsakai@life.osaka-cu.ac.jp

\* Corresponding author: hsakai@life.osaka-cu.ac.jp

## Abstract

In order to properly describe the light environment during sleep, it is necessary to know the light transmittance of the eyelids and how to feel the brightness when the eyes are closed. For that purpose, we measured the light transmittance of the eyelids from the condition that the feelings of brightness when the eyes were open and when the eyes were closed are the same in photopic vision. The light source used were monochromatic LEDs of red (peak wavelength 630 nm), yellow (593 nm), green (515 nm), blue (460 nm), and a white LED (T<sub>cp</sub> = 4188K, Ra 93). The average light transmittances of totally 33 subjects were 52.4% for red, 26.2% for yellow, 21.6% for green, 4.5% for blue, and 42.7% for white.

**Keywords:** *brightness, light environment, eyelid, sleep*

## INTRODUCTION

Sleep deprivation and sleep disorders can cause serious health problems, thus various factors that affect sleep are being elucidated with the goal of eliminating them. One of them is the light environment, and it has been reported that the light exposed during the daytime, night-time, and during sleep affects the circadian rhythm and the quality of sleep (Engwall et al. 2015; Quinn et al. 1999). Here, correlated color temperatures and illuminance values are used to describe the light environment in such studies, even when discussing the light environment during sleep. They are, however, based on the visual characteristics of photopic vision when the eyes are open. The eyes are closed during sleep, and the light that reaches the retina changes its spectral distribution (affects color temperature) and luminous flux (affects illuminance) by passing through the eyelids. Therefore, in order to properly describe the light environment during sleep (when the eyes are closed), it is necessary to know the light transmittance of the eyelids and how to feel the brightness when the eyes are closed.

Therefore, in this study, we measured the light transmittance of the eyelids from the condition that the feelings of brightness when the eyes were open and when the eyes were closed are the same, using a lighting device that increases or decreases the illuminance according to the opening and closing of both eyes.

In previous studies, the results of optical measurement using a contact method that pinches the eyelid (Robinson et al. 1991; Bierman et al. 2011), and the results calculated from the threshold of visual sensation in monocular vision when one eye is open and when the eye is closed (Ando and Kripke 1996) have been reported. In this study, the experiment was conducted in binocular and photopic vision.

## METHODS

The setup of the experiment is shown in Figure 1. A subject sat in a chair in front of the light source at a position where the facial illuminance was 100 lx. The illuminance of the light source could be switched in two levels, and the illuminance when the eyes were closed was always constant (100 lx) regardless of the colors of light. Then, the illuminance when the eyes were open was variable, and its illuminance could be freely controlled by subjects by using the light volume at hand.

In the experiment, first, with the eyes closed, the subject was adapted to 100 lx facial illuminance for 1 minute, and the brightness at that time was memorized. Next, at the signal of the experimenter, the eyes were opened, and the volume was adjusted so that the brightness felt at that time was the same as the brightness when the eyes were closed. The number of times the eyes were opened and closed was not particularly limited, and the evaluation was repeated until the subjects felt that they were in good agreement. Then, the transmittance of the eyelids was calculated from the illuminance ratio when the eyes were open and when the eyes were closed, which felt the same brightness. For example, the illuminance of 20 lx when the eyes were open is the same brightness of the illuminance of 100 lx when the eyes were closed, the transmittance of the eyelids was  $20 \text{ lx} / 100 \text{ lx} = 0.2$ , i.e., 20%.

As shown in Figure 1, since the eyes were out of focus when the eyes were closed, a diffusing sheet covering the entire eyes was put so that the brightness could be evaluated under the same conditions (out of focus) even when the eyes were open. The subjects also wore a black apron so that the light would not be reflected by their clothes.

The light sources used were monochromatic LEDs of red (peak wavelength  $\lambda_{\text{peak}} = 630 \text{ nm}$ ), yellow (593 nm), green (515 nm), blue (460 nm), and a white LED ( $T_{\text{cp}} = 4188\text{K}$ ,  $R_a = 93$ ), for a total of five colors. They are all PEACE CORPORATION's 5050 line-shaped LEDs and the color names depend on the manufacturer. Figure 2 shows the spectral distributions measured at the position of the subject's eye after passing through the diffusing sheet with the Konica Minolta spectroilluminance meter CL-500A. The above-mentioned peak wavelength, correlated color temperature, and general color rendering index were calculated from the measured values.

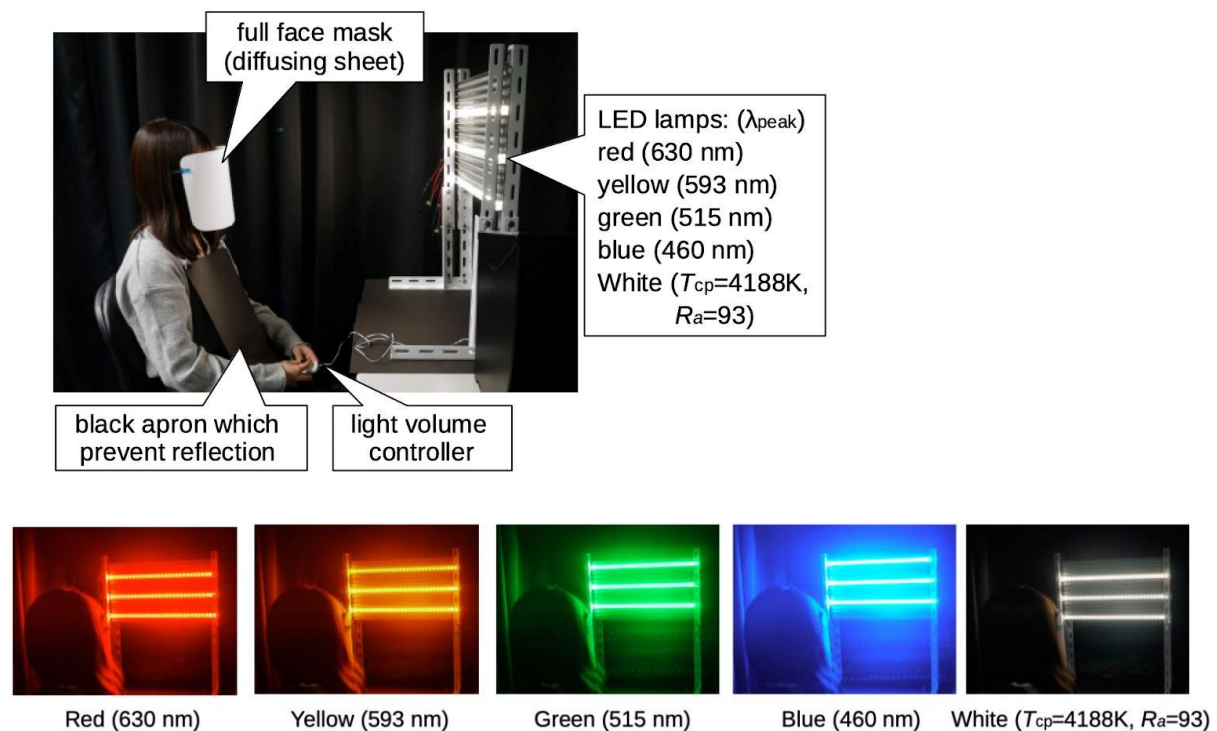

Figure 1: Setup of the experiment.



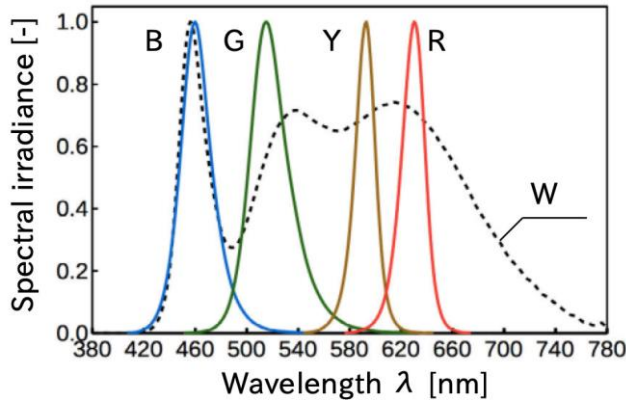

Figure 2: Spectral distributions of four monochromatic LEDs and white LED (Normalize the peak value to 1.0)

The order of evaluation of the five colors was random for each subject in consideration of the order effect, and the evaluations were performed three times for each color for each subject. However, if there was a large variation such as a difference of more than double, the evaluation was added once or twice.

The subjects were 10 males and 13 females aged 21 to 24 years. In addition to the condition with makeup for 13 females, the experiment was conducted with 10 females without makeup. All male subjects were without makeup. Thus, we obtained the results for a total of 33 subjects. All were Japanese college students. At end of the experiment, the skin colors of the eyelids were visually measured using the NCS color charts.

### RESULTS AND DISCUSSIONS

Table 1 shows the light transmittances of the eyelids calculated from the experimental results of the illuminance when the eyes were opened, which feels the same brightness as the illuminance when the eyes were closed at 100 lx. The average light transmittances of 33 subjects were 52.4% for red, 26.2% for yellow, 21.6% for green, 4.5% for blue, and 42.7% for white. The colors of the eyelids were distributed from S1010 to S4020 with an average of S2218 in NCS nuance, and from Y30R to Y90R with an average of Y53R in NCS hue. Since the subjects were all Japanese, there was no significant difference in eyelid color, and no clear correlation was found between eyelid color and transmittance.

color of LED	Red	Yellow	Green	Blue	White
$\lambda_{\text{peak}} / T_{\text{cp}}$	630 nm	593 nm	515 nm	460 nm	4188 K
Max. [%]	106.9	76.7	68.3	15.5	101.4
Min. [%]	6.0	5.0	4.8	0.9	11.1
Average [%]	52.4	26.2	21.6	4.5	42.7
Standard dev.	31.5	18.2	16.7	3.9	24.8

Table 1: Results of light transmittance of eyelid.

In previous studies, Robinson et al. (1991) reported 3% for short wavelength (up to 580 nm), 14.5% for long wavelength (700 nm) by optical measurement; Ando and Kripke (1996) reported 0.3% for blue LED (peak wavelength 470 nm), 0.3% for green LED (555 nm) and 3.4% for red LED (630 nm) from the threshold of visual sensation. Compared with these reports, the results in this experiment were several to 10 times higher in transmittance. Since the experimental conditions are very different, it is not



necessary to agree, and there is a difference of about 10 times between previous studies. However, there were large individual differences in all five colors, and in particular, there were some subjects whose transmittances exceeded 100% for red and white.

Exceeding 100% means that the light that has passed through the eyelids with the eyes closed is brighter than the light with eyes open, so it is essentially impossible. Therefore, there is a possibility that some subjects might misunderstand the instruction. However, Figure 3 shows a line graph in which the results of the subjects are sorted in descending order of transmittance for each color. Although some discontinuous declines are seen around the 5th to 10th subjects, the transmittance gradually decreased toward the lowest subject results. Furthermore, in Figure 3, the ranks of the subjects are sorted by color, and the subject with high transmittance for one color did not answer the high transmittance for another color.

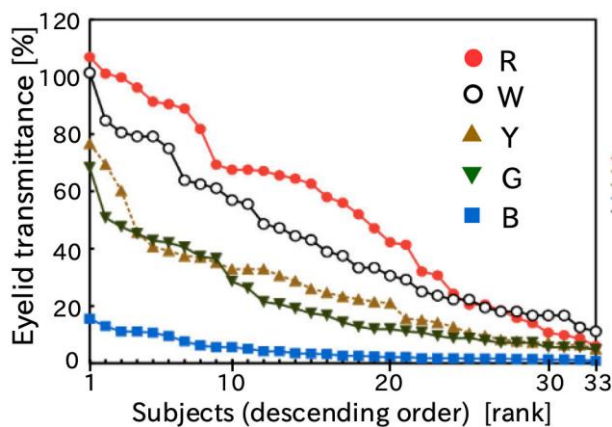

Figure 3: Eyelid light transmittance distributions for five colors.

In hearings during and after the experiment, some subjects reported that the hues looked different when the eyes were opened and when the eyes were closed. For example, the red LED could be recognized as red with the eyes closed for most subjects, but other colors were often mistaken. For the yellow LED, most subjects did not recognize the any color. The important point is there were large individual differences in recognition of hues. It is said that hue affects the sense of brightness, known as the Helmholtz-Kohlrausch effect (Ikeda and Ashizawa, 1991; Nayatani and Sobagaki, 2003). Therefore, there is a possibility that individual differences in recognition of hues may have been a factor. These are phenomena that cannot be explained by the spectral transmittance of eyelids and should be investigated in the future.

## CONCLUSIONS

We measured the light transmittance of the eyelids from the condition that the feelings of brightness when the eyes were open and when the eyes were closed are the same in photopic vision. The average light transmittances of totally 33 subjects were 52.4% for red, 26.2% for yellow, 21.6% for green, 4.5% for blue, and 42.7% for white. Compared with previous studies, the results in this experiment were several to 10 times higher in transmittance. Since the experimental conditions are very different, it is not necessary to agree. However, there were large individual differences in all five colors. This may be caused by the fact that some subjects reported that the hues looked different when the eyes were opened and when the eyes were closed. These are phenomena that cannot be explained by the spectral transmittance of eyelids and should be investigated in the future.

## **REFERENCES**

- Ando, K., D.F. Kripke. 1996. Light attenuation by the human eyelid. *Biological Psychiatry* 39: 22-25.
- Bierman, A., M.G. Figueiro, and M.S. Rea. 2011. Measuring and predicting eyelid spectral transmittance. *Journal of the Biomedical Optics* 16: 067011-1-8.
- Engwall, M., I. Fridh, L. Johansson, I. Bergbom, and B. Lindahl. 2015. Lighting, sleep and circadian rhythm: An intervention study in the intensive care unit. *Intensive and Critical Care Nursing* 31: 325-335.
- Ikeda, M., and S. Ashizawa. 1991. Equivalent Lightness of Colored Objects of Equal Munsell Chroma and of Equal Munsell Value at Various Illuminances. *Color Research and Application* 16: 72-80.
- Nayatani, Y., and H. Sobagaki. 2003. Causes of Individual Differences on Brightness / Luminance (B/L) Ratios. *Journal of Light and Visual Environment* 27: 160-164.
- Quinn, G.E., C.H. Shin, M.G. Maguire, and R.A. Stone. 1999. Myopia and ambient lighting at night. *Nature* 399: 113-114.
- Robinson, J., S.C. Bayliss, and A.R. Fielder. 1991. Transmission of light across the adult and neonatal eyelid in vivo. *Vision Research* 31: 1837-1840.



# EEG Responses to In-Car Dynamic Cluster Light

Taesu Kim<sup>1</sup> and Hyeon-Jeong Suk<sup>1,\*</sup>

<sup>1</sup> Department of Industrial Design, Korea Advanced Institute of Science and Technology, Daejeon, South Korea; tskind77@kaist.ac.kr

<sup>1</sup> Department of Industrial Design, Korea Advanced Institute of Science and Technology, Daejeon, South Korea; color@kaist.ac.kr

\* Corresponding author: color@kaist.ac.kr

## Abstract

We investigated the effect of light on drivers' brain activity depending on the chromatic and dynamic characteristics of the in-car light conditions. We installed a total of 25 lights through the combinations of 5 chromatic variations, including Red, Green, Blue, Warm white, and Cool white, and 5 dynamics, including Blink, Dim, FastBlink, FastDim, and On. Twenty-nine college students participated in the experiment. We measured the high beta wavelength (20 ~ 30 Hz) and alpha wavelength (8 ~ 13 Hz) from the electroencephalography (EEG) responses of each participant. We calculated the Tension index, a ratio of high beta wavelength to alpha wavelength, to indicate the driver's alertness. We found out that the light color influenced the tension index ( $p < .05$ ), and in particular, drivers felt more alert under green and warm-white. Also, the dynamics influenced the tension index ( $p < .05$ ). Subjects showed high alertness on fast-changing lights (FastBlink, FastDim). The empirical results provide evidence that automobile manufacturers may utilize the light patterns to modulate driver's tension.

**Keywords:** Light pattern, In-car light, EEG, Dynamic light

## INTRODUCTION

Over the last few decades, car manufacturers have only focused on driver-aid solutions to increase drivers' driving quality. According to the car technology improvement, car manufacturers start to consider the driver as the user. Then, they produce the user-centered design in their car. To improve the user experience, manufacturers are increasing the in-car emotional experiences. They get attention to attach sensory attributes like odor, sound, and lights to their cars. The lighting is considered an efficient solution, which delivers the driving information and creates the in-car mood by using just one attribute.

Manufacturers provide lighting color concepts to improve the aesthetic quality of the car interior. Caberletti and his colleagues examined the influence of ambient lighting in a vehicle interior on the driver perceptions by conducting the self-assessment test of twelve lighting scenarios with eighteen emotions (Caberletti et al. 2010). Also, Kia K900 collaborates with Pantone to provide seven emotional ambient lightings to users. They named the light color with its emotional effect like 'Peaceful Forest' to help drivers select the lighting color based on their emotional demands.

Manufacturers now start to design dynamic lighting in their cars also. The lighting pattern gets commonly researched for use as the ambient display for delivering road information to drivers or revealing the drivers' emotional status. The concept car of Mercedes Benz AVTR shows the co-driving concepts supported by the lighting. The lighting pattern dimming according to the drivers' heartbeat. Kim and his research team conducted a self-assessment test to figure out the in-car dynamic light can control the drivers' arousal by controlling the dimming animation (Kim et al. 2021).

Confirming the effect of the lighting should be proved by users' biofeedback also. Researchers measure brain activity, heart variability, and circadian rhythm to figure out the lighting effects. Mariam and his colleagues figured out red light can increase beta wavelength compared to blue light by measuring the electroencephalography (EEG) in the car (Mariam et al. 2019). Canazei and his research team mimics the daylight to provide alert effect and confirmed by their in-car lighting can decrease

alpha wavelength (Canazei et al. 2021). However, recent researches focus on the colors or brightness effects of the lighting only. So, in this research, we design a dynamic cluster light with five colors and five dynamics to assist driver alertness. Then, collect the EEG data to confirm the alertness effect of light color and animation.

**DESIGNING CLUSTER LIGHTING**

Lighting was attached to the cluster for providing its effect directly to drivers. According to the safety issues in the car, the lighting attached behind the steering wheel composed indirect lighting with low illuminant. Neopixel LEDs have R, G, B, and W channels installed for providing lighting scenarios comfortably.

Twenty-Five light scenarios were provided that combine five colors and five light dynamics. For five colors, three primary light colors (red, green, blue) and two nuanced white colors (warm white - 4,000K, cool white - 10,000K) were selected. For five dynamics, two types of light dimming styles (smooth dimming, sudden dimming) combine with two animation speeds (fast, slow) are provided. Additionally, not animated light, which constantly turns on also considered (Figure 1). All light colors are controlled to 50 nits when it is fully turned on. Then, lights provide around 0.5 lux on the driver’s eye level when installed in the car.

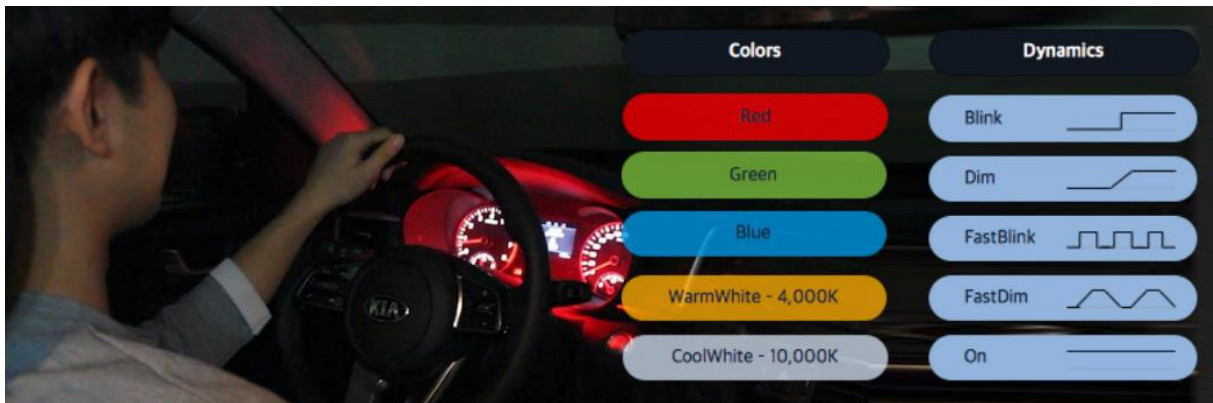

Figure 1: Final design of cluster indirect lighting. Twenty-Five Lighting modes were provided composed of five colors (Red, Green, Blue, Warm, Cool) and five dynamics (Blink, Dim, FastBlink, FastDim, On).

**EXPERIMENT**

The experiment lasted a total of 35 minutes per subject. For figuring out the effect of light in the actual car, Kia K5 was used for the experiment. The vehicle parked in the parking lot under 6 lx. For mimicking the road driving, night driving clips were projected in the front wall (Figure 2).

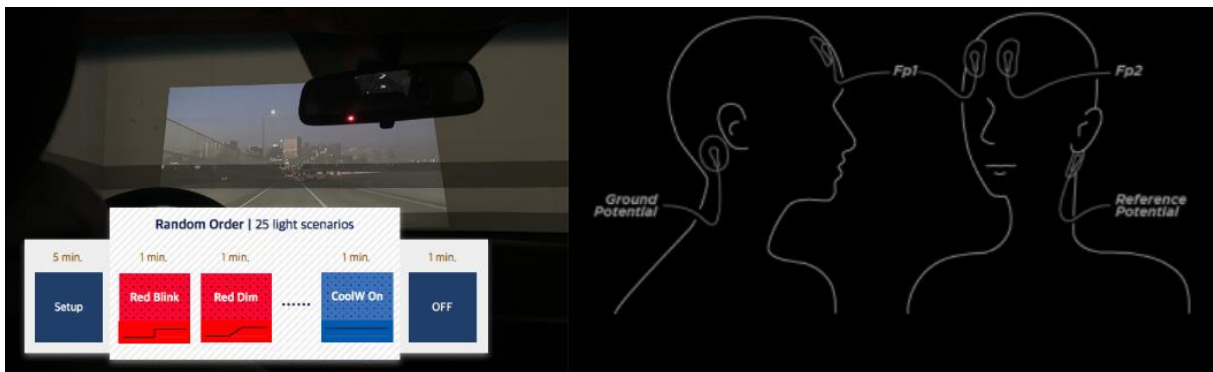

Figure 2: Experiment setup. Four electrodes were attached to measure EEG (Fp1, Fp2, Ground potential, Reference potential) and we collect 25 light exposure signals according to each light scenario and 1 ground signal. All lighting scenarios were provided in random order.

A total of 29 college students (17 male, 12 female) participated in this study. Their average age was 23.60 years. Participants were asked to test the Ishihara test before the experiment to rule out the color-blind. The participants were asked to avoid caffeine drinks such as coffee two hours before the experiment.

For measuring an EEG, the electrodes were attached to 4 spots – Fp1, Fp2, ground potential, and reference potential according to international 10-20 EEG plots. Subjects were exposed to 25 kinds of lighting environments per minute. EEG signal was collected during the exposure time. After the exposure, the baseline was measured during 1 minute of rest without any lights. Then, we gather 26 kinds of 1 minute EEG records per subject. The experiment lasted a total of 45 minutes per subject.

## RESULTS

In this study, alpha (8–13 Hz) and high beta (20–30 Hz) frequency bands were used for the EEG analysis. Each band was extracted from each left (Fp1) and right (Fp2) cortex, averaging two values for analysis. For calculating the alertness effect of the lighting, we define the tension index inspired from Cowan and Allen's research, which is the ratio of alpha to high beta (RAHB) (Cowan and Allen, 2010).

Repeated measures two-way ANOVA was conducted that examined the effect of color and dynamics on the Tension index (Figure 3). In the case of light colors, differences were observed between light colors ( $F(4, 116) = 16.57, p < 0.01$ ). In particular, the post-hoc analysis shows drivers get high alertness under green and warm-white lights. And the red light shows the lowest tension index. Also the effects of light patterns shows the significant differences ( $F(4, 116) = 11.63, p < 0.01$ ). Subjects show a higher tension index on fast-changing lights (FastBlink, FaseDim) than constantly turned on lights (On).

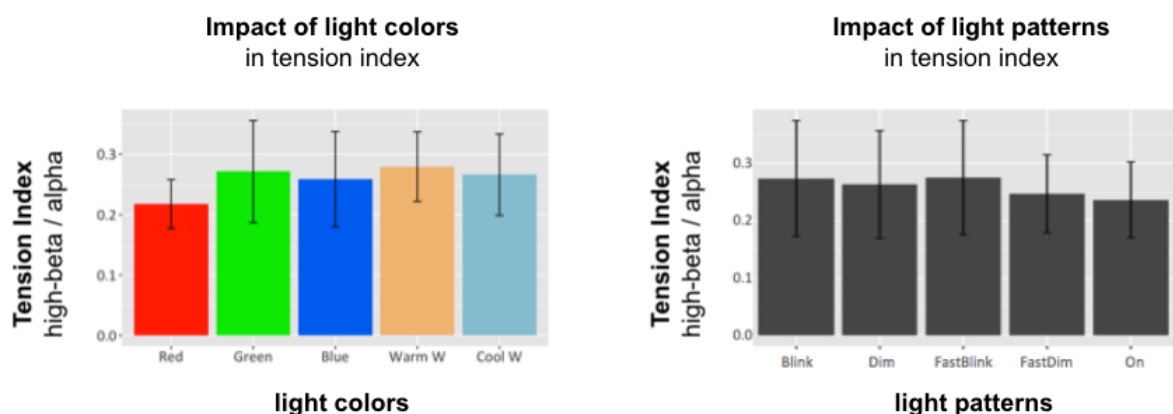

Figure 3: Tension index (ratio of high-beta and alpha) according to light colors (Left) and patterns (Right). Light colors show the significant differences on tension index ( $F(4, 116) = 16.57, p < 0.01$ ), and light patterns also show the significant differences on tension index ( $F(4, 116) = 11.63, p < 0.01$ ).

Also, there was a statistically significant interaction between the effects of color and animation on Tension index ( $F(16,116) = 10.17, p < 0.01$ ). According to the green light, subjects show higher Tension

index on FastBlink pattern. However, for the cool white light, subjects show higher Tension index on the Blink pattern.

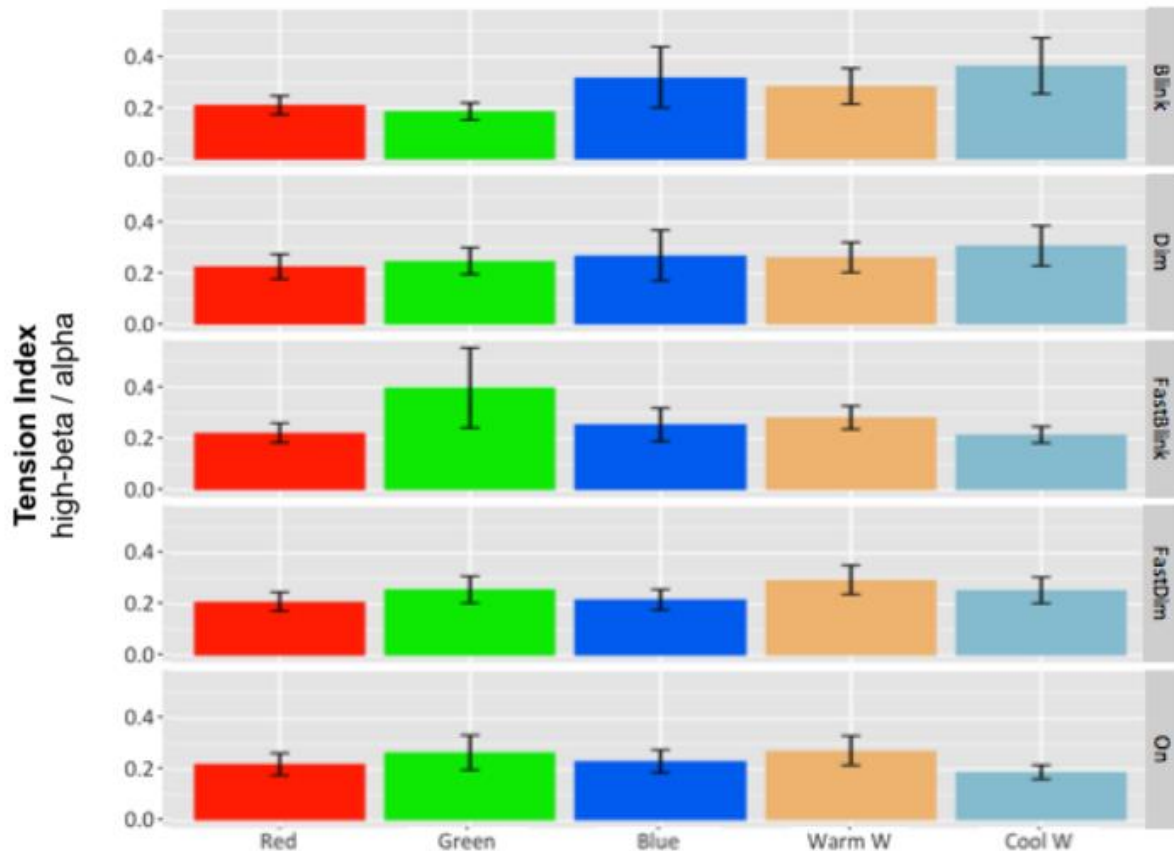

Figure 4: Tension index (ratio of high-beta and alpha) according to light colors and patterns. The interaction effect was founded on colors and animations ( $F(16,116) = 10.17, p < 0.01$ ).

## DISCUSSION AND CONCLUSION

In this experiment, we suggest indirect dynamic cluster lighting compose of five colors with five patterns increase the tension of drivers. We measure the EEG from subjects under 25 lighting scenarios. We extract the alpha and high-beta bands from the frontal cortex and calculate the Tension index, the ratio of high-beta over alpha. This tension index showed statistically significant differences depending on the color of the light. In particular, Tension Index increased in Green and Warm White lights, against the result in some previous studies. Next, lighting pattern differences yielded statistically significant differences as well. Moreover, the Tension Index increased to dynamic patterns compared to the constantly on. Besides, sudden high-frequency light shows the highest tension index. Compared to Kim and his colleagues' self-assessment results for dynamic lighting in the car, the results show the same results with the subjective measurements of tension (Kim et al. 2021). Based on the empirical results, we expect automobile manufacturers to utilize empirical data to control light patterns optimized toward driver's tension, thereby providing safer driving experiences.

**ACKNOWLEDGEMENTS**

1) The National Research Foundation of Korea(NRF) grant funded by the Korea government(MSIP) (No. 2018R1A1A3A04078934); 2) the BK21 PLUS through the National Research Foundation of Korea(NRF) funded by the Ministry of Education(MOE) (NO:21B20130011097).

**REFERENCES**

- Caberletti, L., Elfmann, K., Kummel, M., and Schierz, C. 2010. Influence of ambient lighting in a vehicle interior on the driver's perceptions. *Lighting Research & Technology*, 42(3): 297-311.
- Canazei, M., S. Staggli, W. Pohl, S. Schüler, D. Betz, J. Ottersbach, and R. Popp. 2020. Feasibility and acute alerting effects of a daylight-supplementing in-vehicle lighting system—Results from two randomised controlled field studies during dawn and dusk. *Lighting Research & Technology*. 2020 (0): 1-19.
- Cowan, J., and T. Allen. 2000. Using brainwave biofeedback to train the sequence of concentration and relaxation in athletic activities. In: *Proceedings of 15th Association for the Advancement of Applied Sport Psychology*, 95.
- Hassib, M., M. Braun, B. Pfleging, and F. Alt. 2019. Detecting and influencing driver emotions using psycho-physiological sensors and ambient light. In: *IFIP Conference on Human-Computer Interaction*. Springer, Cham: 721-742.
- Kim T., Y. Kim, H. Jeon, C.-S. Choi, and H.-J. Suk. 2021. Emotional Response to In-Car Dynamic Lighting. *International Journal of Automotive Technology*. 22(4): 1035 - 1043.





# A study of physical and perceived linearity in a virtual reality environment

Francisco Díaz-Barrancas <sup>1,\*</sup>, Halina Cwierz <sup>1</sup> and Pedro J. Pardo <sup>1</sup>

<sup>1</sup> University of Extremadura, Spain; frdiaz@unex.es, hcwierz@unex.es, pjparado@unex.es

\* Corresponding author: frdiaz@unex.es

## Abstract

Virtual reality has become a great multimedia tool in which it is possible to represent 3D content. It can be used for many applications such as video games, telemedicine, teleworking or airplane simulators. However, visual appearance is an aspect that needs to be further improved if virtual reality wants to take on a much more professional use. Should color be reproduced in the same way in the real world as in the virtual world? We observed that although the chromaticity coordinates were matched, the visual appearance meant that the user did not perceive the colors in the same way. Then, it is necessary to establish a correction in the virtual reality scenario that corrects the user's perception. In this work, we have measured target linearity in a 3D environment. By measuring the different achromatic spectra, we found that the Head Mounted Display linearly behaved if we applied spectral and chromatic characterization techniques.

**Keywords:** *virtual reality, color appearance, Head Mounted Display*

## INTRODUCTION

The rapid emergence of virtual reality has led to numerous areas using these devices to help professionals perform their tasks. These tasks can be simulations of real environments in which they have to be pre-tested outside the real world given their high danger. Some examples can be medicine, flight simulation or tests that require high professionalism. However, in the improvement of these devices, the fidelity of color rendering and the required adaptation of the user to the environment is often forgotten. In this work we will use HTC's Head Mounted Display on their HTC Vive model with AMOLED display. It is necessary to emphasize that the behavior that these screens offer is not the same as that of a computer monitor or a mobile screen. These devices are composed of display and lenses which makes their representation specific. Therefore, it is necessary a study of their colorimetric calibration before any study and behavior of the same. This Head Mounted Display (HMD) renders the objects with the graphic card of the computer since it must be connected to it. Unlike other HMDs, we do not use a mobile screen to represent the 3D images. In previous work, we measured colorimetric x, y values reproduced by reflectances within the virtual reality system. We compared these samples with the same samples measured in a physical lighting booth and obtained close values in CIEDE2000 color difference. However, we obtained diffuse responses from users regarding the appearance of these samples (Garcia et al. 2007). Although the x, y coordinates matched that of the physical samples, the appearance perceived by the users was different. Other works demonstrated the influence of colors within the scene and advised to treat the scene as a complex scenario with different color samples (McCann et al. 2014). We decided to focus on achromatic values to take a first step towards what could be a future color constancy work in virtual reality. To do this, we removed all color noise from the scene and treated only achromatic values in a first step. Therefore, the objective of this work is to test the relationship between values measured through the HMD and values perceived by users. In this way, we will be able to conclude if it is necessary to establish any corrections on the virtual reality system to solve this.

## METHODOLOGY

In this section we will explain the different steps followed for the development of the research work. We have organized this section into 3 subsections: Colorimetric calibration of Head Mounted Display, Physical measurements on the HMD, Virtual environment developed

### Colorimetric calibration of Head Mounted Display

The first step performed in this work was the colorimetric calibration of the HMD device. For this purpose, we measured RGB values from 0 to 255 for all channels. In addition, we include some RGB random values. Full procedure can be seen in detail in previous work (Díaz-Barrancas et al., 2020). We have also applied these techniques in other works in which a virtual scene was developed to detect visual deficiencies (Cwierz et al. 2020).

The measurement instrument employed in this work was a Konica-Minolta CS-2000 tele-spectroradiometer with a spectral resolution of 1 nm between 380 and 780 nm, a <2% radiance measurement error and CIE 1931  $x = 0.0015$ ;  $y = 0.0010$  color error for an illuminant A. In order to make the measurements, we have followed the recommendations of other works about color measurements in Near-eye displays (NEDs) (Hong 2021; Penczek et al. 2020; Varshneya et al. 2020). Figure 1 shows the measurement procedure in the HMD. We have obtained a CIEDE2000 color difference error of 1.8 in HMD calibration. To check that the calibration was performed correctly, we measured other random samples introduced by their reflectance. The error obtained on these samples were between 2-3 according to the CIEDE2000 color difference.

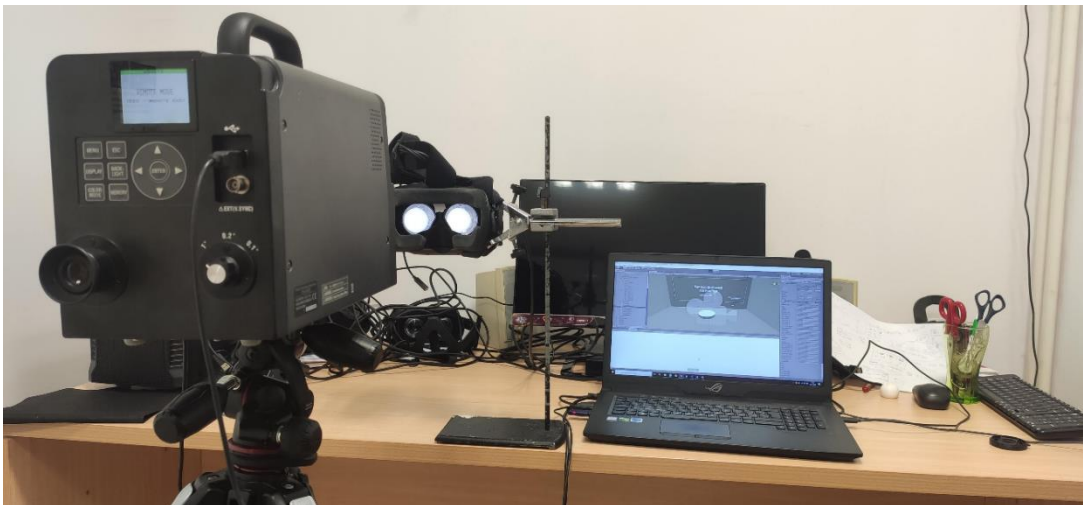

Figure 1: Scenario set up for the chromatic characterization of the HMD.

### Graphics settings Unity rendering

To get the best visual appearance and the most realistic graphical representation possible, we have chosen the high quality options. In addition, options such as reflections have been activated to give a more natural look to the virtual scenery. Also, we have to know that the High Definition Render Pipeline (HDRP) allows us to render Lit Materials using Forward or Deferred rendering. Unity allows us to configure your Unity project to use only one of these modes, or allow you to use both and switch at runtime on a per-camera basis. When we use a Forward HDRP, Unity calculates the lighting in a single pass when rendering each individual Material. However, if we use Deferred HDRP, Unity processes the lighting for each GameObject in the Scene. With this definition, based on giving the best possible image of the virtual scenery, we have considered using a Deferred rendering pipeline.

### Physical measurements on the HMD

In order to know the real values obtained from the achromatic samples in values from 0% white to 100% with differences of 20%, we have measured with the Konica-Minolta CS-2000 spectroradiometer on the HMD. The procedure followed to perform these measurements is similar to that used in the colorimetric calibration set up in the previous section. Table 1 shows the luminance (Y) values obtained for each percentage of white measured.

White measurement (%)	Y (Luminance)
100 %	144.86
80 %	114.89
60 %	87.64
40 %	62.28
20 %	31.71
0%	0.4

Table 1: Luminance values (Y) corresponding to different percentages of white.

### Virtual environment developed

We have developed a virtual reality environment consisting of a lighting booth under the D65 illuminant. Furthermore, inside this light booth, we have placed two fixed capsules: One of them with an absolute white (reflectance values of 1 over 1 in its entire spectrum) and another one with an absolute black (reflectance values of 0 over 1 in its entire spectrum). In the middle of the two capsules, we represent another capsule with changing values. Figure 2 shows the scene represented in virtual reality for this work.

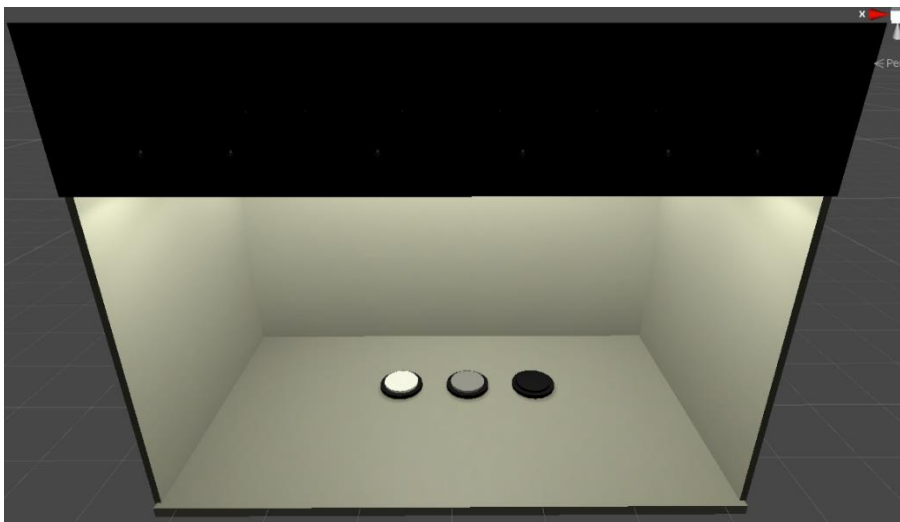

Figure 2: Virtual environment developed to measure both the physical linearity of the Head Mounted Display and its appearance.

## **OBSERVERS AND PROCEDURE**

In this section, we will explain the procedure followed with the users to measure the appearance in terms of white linearity within the virtual reality system.

We have chosen 5 users between 24 and 45 years of age. Once the users have been chosen, each one will pass 5 complete tests of 20 samples each. In other words, each user will generate 100 responses at the end of the full test. Therefore, with 5 users we will be generating 500 answers to achromatic appearance values.

The procedure followed is as follows: First of all, the user stays with the HMD for 60 seconds to adapt to the scenario and its illuminant. Once these 60 seconds have expired, we start with the test. The two fixed capsules (black and white) always appear in the virtual reality scenario. However, the user has a maximum of 20 seconds to decide the level of white he/she observes in the capsule that appears in the middle. These values range from 0% to 100% with differences of 10%. Between samples, the sample is hidden, leaving only the two fixed capsules on the scenario for 5 seconds. Once this time has elapsed, another capsule will appear with a different value of white in which the user will have to decide again the appearance of the capsule. Figure 3 shows the procedure for a capsule that would result in 80% of the white.

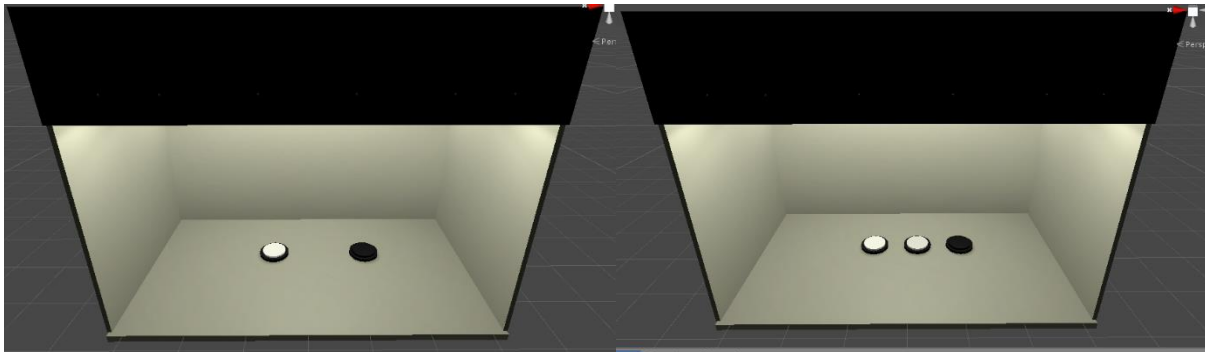

Figure 3: Sample of one of the tests performed on a user. The middle capsule shows 80% of the value of the left capsule and 20% of the right capsule.

## **RESULTS**

After performing physical measurements on the HMD and appearance tests on users, we have seen that the white linearity produced is not the same as that perceived by the users. This means that if we want to represent certain colorimetric values in a virtual reality scenario, it will not correspond to the appearance perceived by the user. Therefore, it is necessary to make a correction so that users can perceive within the HMD the color values that we want to represent. Figure 4 shows this difference between physical measurement and perceived user appearance.

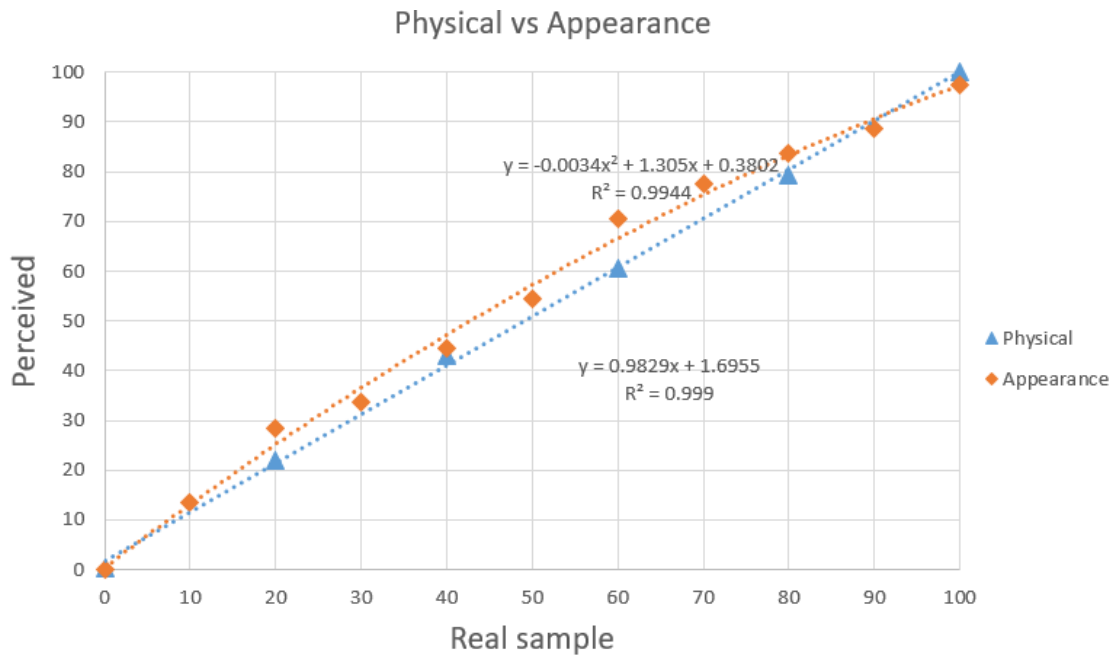

Figure 4: Virtual environment developed to measure both the physical linearity of the Head Mounted Display and its appearance.

## CONCLUSIONS

In the results we have been able to verify that after measuring directly with the spectroradiometer on achromatic samples and then asking observers about their appearance, both have a significant difference. Therefore, we can introduce new techniques to simulate a better image reproduction. In future work, we want to study the influence of color constancy within a virtual reality system. Is it possible to treat virtual reality as the real world in terms of adaptation to the environment? In this first work, we have managed to take a first step towards this goal.

## ACKNOWLEDGEMENTS

This work was supported by grants GR18131, IB16004 and IB20094 of the Regional Government of the Junta de Extremadura and was partially financed by the European Regional Development Fund.

## REFERENCES

- Cwierz, H. C., F. Diaz-Barrancas, P. J. Pardo, A. L. Perez, and M. I. Suero. 2020. Application of spectral computing technics for color vision testing using virtual reality devices. In: *Electronic Imaging 2020*, (15) 260-1.
- Díaz-Barrancas, F., H. Cwierz, P. J. Pardo, Á. L. Pérez, and M. I. Suero. 2020. Spectral Color Management in Virtual Reality Scenes. *Sensors* 20(19): 5658.
- Garcia, P. A., R. Huertas, M. Melgosa, and G. Cui. 2007. Measurement of the relationship between perceived and computed color differences. *Journal of the Optical Society of America*, 24(7): 1823-1829.
- Hong, H. 2021. A measurement method of the focal distance of the virtual image in an augmented reality or virtual reality device. *Journal of the Society for Information Display*, 29(4): 230-236.
- McCann, J. J., C. Parraman, and A. Rizzi. 2014. Reflectance, illumination, and appearance in color constancy. *Frontiers in psychology* 5:5.

- Penczek, J., R. L. Austin, S. Obheroi, M. Hasan, G.J Cook, and P. A. Boynton. 2020. 54-5: Measuring Direct Retinal Projection Displays. In: *SID Symposium Digest of Technical Papers 2020*, 807-810.
- Varshneya, R., R. S. Draper, J. Penczek, B. M. Pixton, T .F. Nicholas, and P. A. Boynton. 2020. 50-4: Standardizing Fundamental Criteria for Near Eye Display Optical Measurements: Determining the Eye-box. In: *SID Symposium Digest of Technical Papers 2020*: 742-745.

# How accurate is an on-line test for colour vision deficiency?

Kari Bjerke Gjørde <sup>1</sup>, Anne Kristin Kvitle <sup>1,\*</sup>, Phil Green <sup>1</sup> and Peter Nussbaum <sup>1</sup>

<sup>1</sup> Norwegian University of Science and Technology; kari.gjarde@ntnu.no; anne.kvitle@ntnu.no; phil.green@ntnu.no; peter.nussbaum@ntnu.no

\* Corresponding author: anne.kvitle@ntnu.no

## Abstract

This study explores the accuracy and specificity of an on-line version of a standardized colour vision deficiency test – the Hardy-Rand-Rittler test (HRR) performed in an uncontrolled environment.

A group of 25 observers (18 with a colour vision deficiency and 7 with normal colour vision) that had previously been tested in a controlled setting participated, and the results from the on-line test was compared with previous results.

The on-line test successfully predicted the main results of the physical test of all 25 observers. The test also predicted the deuterans with an accuracy of 92 %.

**Keywords:** colour vision, colour vision deficiency (CVD), colour vision test

## INTRODUCTION

### Background

Colour vision deficiency (CVD) is a common phenomenon, affecting as many as one in twelve males (8%) and one in 200 females (0.5 %) according to Birch (2012). Studies reported by Cole (2007) claim that as many as 20 to 30 percent of adults with abnormal colour vision are not aware of their condition. This suggests that colour vision is not tested as often as it should be.

Colour vision deficiency is detected and classified by visual tests, including pseudoisochromatic plates (PIP), sorting or arrangement tests, and colour matching tests. The latter includes the anomaloscope, which is considered the most accurate and the only existing test capable of reliably distinguishing anomalous trichromacy from dichromacy. One of the most widely used tests is the Ishihara PIP test, as proposed by Shinobu Ishihara in 1917 (Ishihara (1972)). Other PIP tests include the HRR test and the Waggoner tests (Waggoner 2021). Digital tests include the Cambridge Color Test (CCT) (Mollon and Regan 2000) and the Colour Assessment and Diagnosis (CAD) (Seshadri et al. 2005) test that are designed for display, in addition to the digital versions of the Waggoner tests (both PIP and sorting) as described and evaluated by Ng et al. (2015). According to Murphy (2015), digital tests are close to being the ideal colour vision test as they are easy to administer, quick to conduct and accurate, and often cheaper to produce and maintain. However, the digital tests are device dependent and a colour-calibrated display is required to guarantee accuracy of a physical test (Tsai et al. 2003), Ng et al. 2015). On-line tests include variations of the Ishihara and the Farnsworth D-15, but a review by Zarazaga et al. (2019) questions the scientific validity of published studies of such tests and Murphy (2015) suggest that a specific on-line version of the Farnsworth-Munsell 100-Hue is an acceptable alternative to prove excellent colour vision rather than a tool to diagnose CVD subjects. The Ishihara test has some limitations in determining the type and severity of CVD, which can also be caused by the examiner mis-interpreting the results. According to Cole (2007), common mistakes include using the wrong fail criterion and the assumption that a high number of errors indicate a severe CVD. Cole et al. (2006) find the Richmond HRR better than the Ishihara test, which is supported by Aldewachi (2013). Both studies conclude that HRR is as good as the Ishihara in detecting CVD, and that HRR has an advantage over Ishihara in grading the severity of the defect. Cole et al. (2006) suggest that the HRR test could be the test of choice for clinicians who wish to use a single test for colour vision.



The study presented in this paper explore to what extent a digital version of the HRR test conducted on-line in an uncontrolled setting could verify a colour vision deficiency on subjects with a confirmed and categorized condition. Specifically, asked:

- How do the results from the on-line test compare to the physical results?
  - Will the test detect a colour vision deficiency among the CVD subjects? (i.e. what is the sensitivity of the test)
  - Will the test confirm normal colour vision for colour normal observer (CNO)? (i.e. what is the specificity of the test)
- For persons with CVD: Is the outcome the same as the physical test with respect to deutan and protan deficiencies?

## **METHOD**

The on-line test was designed as an uncontrolled web-based test, where the subjects performed the test at their choice of display (laptop display, external display mobile phone, external display) and environment. The chosen test was the HRR, where the plates of the physical HRR test (add reference) were scanned and prepared in Adobe Photoshop and exported for web at 600 px and embedded sRGBIEC61966-21 colour profile. The results were then compared with those for the same observers on the physical HRR test.

### **HRR test**

According to the HRR test instructions (Good-Lite.com 2021), the HRR test is required to be conducted in CIE standard Illuminant C or a close approximation of it, where the examiner shows the HRR booklet about 30 inches from the eyes of the subject. The booklet contains 24 plates, of which the first four plates are demonstration plates to explain and train the subject. These four plates show the subjects what, where and how many symbols can be included. After the demonstration, there is a screening series of six plates, where the examiner asks the subject how many and what symbols they see, and where they are. If the subject sees all symbols, their color vision is considered to be normal and the test ends here. If there are any errors (i.e. symbols not seen) the test will continue based on which of the screening plates the subject made error(s) on. The number of visible symbols in each category is listed in table 1.

<b>Number of symbols</b>		
<b>Plate 5 – 10 (Screening)</b>	<b>Plate 11 – 20 (protan/deutan)</b>	<b>Plate 21 – 24 (Tritan)</b>
10	18	8

Table 1: Number of symbols in screening and diagnostic plates.

The type of CVD is analyzed based on the count of the number of symbols that the subject detects, and the severity is determined according to the last group of plates in which the error occurs. If the subject make errors in the screening, but passes the rest of the test, the screening plates should be repeated with the booklet rotated 90 or 180 degrees to give the symbols a different location on the page.

### Digital test

Typeform (Typeform 2021) was used as the on-line data acquisition platform, as it has a good adaptation for mobile devices and allows the display of a large image area of the plates.

The subjects received an individual ID code and a link to the test. Before performing the HRR test, demographic data (age and gender) and viewing conditions (display type, display size and illumination) were collected by self-reports from the subjects.

In order to explore the subjects' physical environment (size and quality of display and illumination), different grey scales were made to obtain feedback on the user's display settings (contrast, brightness etc.); one bright, one mid tone and one in the darker area. Adjustments were made in the L\* lightness, with 2 levels difference in the three versions. Also, a grey scale with greater differences (and easier to separate and quantify) was used in the introduction, as a "training" part to the grey scales. An example of a grey scale is illustrated in Figure 1.

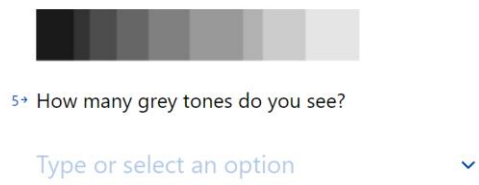

Figure 1: Grey scale.

### HRR – conducting the test

With the physical HRR test, the examiner sits together with the patient, and explains the parts of the test, symbols on plates etc. For the digital version, a "translation" of the examiner's explanation was shortened and given as an introduction text, followed together with an illustration as shown in Figure 2. The first four plates of a HRR test are for demonstration, and the result on this part shows that almost everyone understood this and answered correctly on these four, non-scored, plates. In contrary to the original HRR test, all subjects scored all the plates in the digital test, regardless of the screening results.

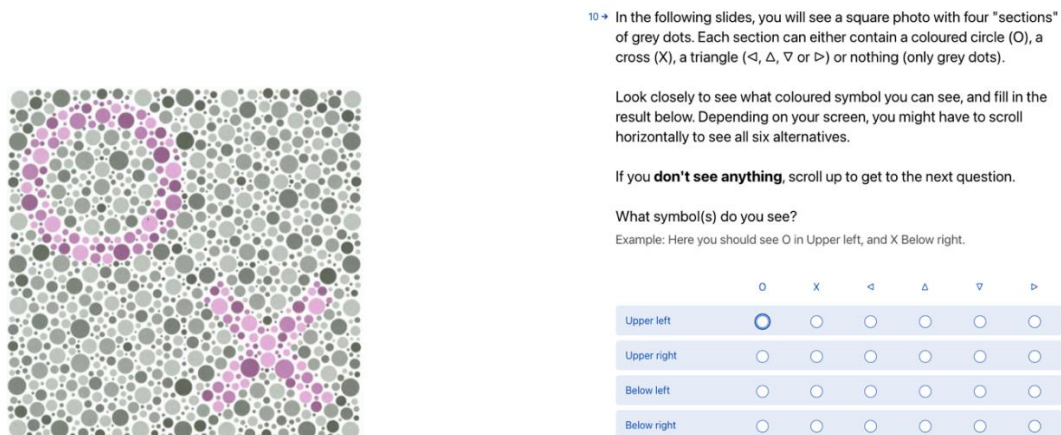

Figure 2: Screenshot of instructions before demonstration plates.

## Observers

This experiment involved two groups of observers: a group of previously tested colour vision deficient observers (CVDs) and a reference group of people with previously tested normal colour vision (Colour Normal Observers (CNOs)). The CVD observers were recruited among participants from previous experiments and had previously been tested in a controlled setting (Kvitte et al. 2018), performing the HRR test followed by the Farnsworth D-15 and Lanthony D-15. The CNO observers were recruited from students at NTNU that had been tested during lab practice.

## RESULTS AND DISCUSSION

A total of 25 observers conducted the uncontrolled on-line test, with 18 previously confirmed CVD (13 deuterans and 5 protans) and 7 previously confirmed CNO by the physical HRR test. Their age range spans from twenty-two to 63. Of these 25, 18 had been found to have a colour vision deficiency by the test, and a further 7 participants were found to have normal colour vision.

### How are the results compared to the physical results?

The following categorization is based on the previous test results from the physical tests in the lab. If a subject does not recognize one or more symbols in plate 5–10, the subject is categorized as a CVD and continues to the plates 11–24 (protan and deutan) or 21–24 (tritan) for diagnostic categorization and severeness (Good-Lite.com 2021). In this on-line test, all of the subjects assessed all plates.

#### CVDs

All observers previously categorized as CVD obtained results that categorized them as CVDs in the on-line test, as they did not detect symbols in the screening plates 5 - 10 and in the diagnostic plates 11 – 20. The average number of errors in each category is shown in table 2. For more details on the diagnostic series (plate 11–20), please see below regarding deuterans and protans.

Average number of symbols not detected (CVD)		
Plate 5 – 10	Plate 11 – 20	Plate 21 - 24
5.50	7.61	0

Table 2: Average number of symbols not detected by CVD observer group in screening and diagnostic plates.

#### CNOs

All the CNOs clearly confirmed that they have normal colour vision. All observers saw all the symbols in plates 5 – 10 after two of them were asked to redo the test. In plates 11 – 20, three persons missed out on one symbol, which was corrected to one after a second test. The average number of symbols not detected is listed in table 3.

Average number of symbols not detected (CNO)					
First trial			Second trial		
Plate 5 – 10	Plate 11 – 20	Plate 21 - 24	Plate 5 – 10	Plate 11 – 20	Plate 21 - 24
0.50	0.50	0	0	0.17	0

Table 3: Average number of symbols not detected by CNO observers in two trials.

Given that the CNOs should see all the symbols all the time, this gives an uncertainty of 5.3 % the first time of testing, and 0.8 % after retesting.

### *Specificity and sensitivity*

The results show that all the participants in the in each group scored according to expected results according to their performance on previous CV test. This gives the test 100 % sensitivity, with regards to the previous categorization of physical testing. The specificity of the test is also 100 %.

### **How accurate is the test regarding categorization of CVD?**

All the CVDs were confirmed CVD in the digital test. Based on the HRR Score sheet, the on-line test distinguished 12 deutans, 1 protan and 5 uncertain results. Here, the term “uncertain” refers to an equal number of errors in each category (protan or deutan). The results from the on-line HRR test and the previous results are listed in table 4.

	<b>Protan</b>	<b>Deutan</b>	<b>Uncertain</b>
On-line HRR	1	12	5
Physical tests	5	13	0

Table 4 : Results on protan/deutan from on-line and physical test.

This indicates that the on-line test predicts a deutan with an accuracy of 92 %. Among the CVDs the overall uncertainty is 28 % when it comes to categorize the type of CVD. 5 subjects could not be clearly categorized, whereas 4 previously categorized as protans and one categorized as deutan. It has to be noted that the deutan subject is categorized as nearly normal CV based on previous tests.

Only five persons had previously tested as protan, so the results cannot be used to draw firm conclusions about the performance of the test. One of the reasons for the limited number of protan subjects are the frequency of this category in the general population, which is also reflected in similar studies in the literature. Based on the scores for diagnostics in plates 11 – 20, where the scores for protan and deutan can be eight in each category (8P – 8D), the confirmed deutans are more clear (1P–7D, 3P–8D, 2P–5D etc.), whereas the score for the confirmed protans are unclear where three of the uncertain scoring equal in each category (8Protan(P)–8Deutan(D), 2P–2D, 3P–3D). However, when examining the severity of the condition (mild, medium or strong) which is recognized by the last group of plates in which the errors occur, the errors for the protan group occurs in the protan category. This is an interesting finding, which should be further examined.

### **CONCLUSION AND FUTURE WORK**

Our study showed that an uncontrolled on-line version of the acknowledged HRR test can detect and confirm both CVD and normal colour vision among the group of observers. This is promising, as such test can be implemented as a tool for CV screening test in uncontrolled psychophysical experiments where either a normal colour vision is required, or a CVD is requested. However, based on our results, the test does not appear able to clearly differentiate the categories of CVD which is often required in colour vision experiments involving CVD simulation or daltonization methods. To verify, or reject this, more observations are needed.

## **ACKNOWLEDGEMENT**

The authors express our gratitude to the Good-Lite Company for giving permission to use the HRR test in this experiment. We would also thank our observers for their patience and time. This research was funded by the Research Council of Norway, through project no. 221073 "HyPerCept – Colour and quality in higher dimensions".

## **REFERENCES**

- Aldewachi, A. 2013. Comparison of two colour vision tests used in current ophthalmic practice. *Tikrit Medical Journal* 19:255-268.
- Birch, J. 2012. Worldwide prevalence of red-green color deficiency. *Journal of the Optical Society of America A* 29: 313-320.
- Cole, B. L. 2007. Assessment of inherited colour vision defects in clinical practice. *Clinical & experimental optometry* 90:157–175.
- Cole, B. L., Lian, K. Y., & Lakkis, C. 2006. The new Richmond HRR pseudoisochromatic test for colour vision is better than the Ishihara test. *Clinical & experimental optometry* 89: 73–80.
- Dain, S.J., Clinical colour vision tests, *Clinical and Experimental Optometry* 87: 276-293.
- Farnsworth, D. 1947. The Farnsworth Dichotomous Test for Color Blindness: Panel D-15, ed: Psychological Corporation.
- Good-Lite.com. "HRR Test Guide". Available at <https://www.good-lite.com/collections/color-vision-tests/products/730005>. Accessed July 30, 2021.
- Hardy-Rand-Rittler (HRR) pseudoisochromatic test for colour vision, 4th Ed., Test plates and instruction book, Richmond Products
- Ishihara, S. 1972. Tests for Colour-Blindness – 24 Plates (24 Plates ed.), Kanehara Shuppan Co., Ltd.
- Lanthony, P. 1978. The desaturated panel D-15. *Documenta Ophthalmologica* 46: 185.
- Mollon JD, Regan, BC. 2000. Cambridge colour test handbook. Cambridge: Cambridge Research Systems.
- Ng, J.S., Self, E., Vanston, J.E., Nguyen, A. L., Crognale, M. A. 2015. Evaluation of the Waggoner Computerized Color Vision Test. *Optometry and Vision Science* 92:480-486.
- Kvitle, A. K., H. Oddløyken, P. Green, and P. Nussbaum. 2018. Methods for psychophysical assessment of colour difference by observers with a colour vision deficiency. In: *2018 Colour and Visual Computing Symposium (CVCS), Proceedings of the Colour and Visual Computing Symposium*.
- Murphy, R.A. 2015. *Comparing color vision testing using the Farnsworth-Munsell 100-Hue, Ishihara compatible, and digital TCV software*. Master's thesis. Pacific University Oregon College of Optometry.
- Seshadri J., Christensen J.O., Lakshminarayanan V.F., Bassi C.J. 2005. Evaluation of the New Web-Based "Colour Assessment and Diagnosis" Test. *Optometry & Vision Science* 82:882-5.
- Simunovic, M. 2010. Colour vision deficiency. *Eye* 24: 747-755.
- Tsai, Y.-C., Chen, H.-S., Luo, M. 2016. Screen-based color vision test for digital quantification of deutan color defects using a color-calibrated monitor. *Journal of the Society of Information Display* 24:487 – 500.
- Typeform. 2021. Available at [www.typeform.com](http://www.typeform.com). Accessed July 30, 2021.
- Zarazaga, A.F., Vásquez, A.J., and Royo, V.P. 2019. Review of the main colour vision clinical assessment tests. *Archivos de la Sociedad Española de Oftalmología* 94: 25-32.
- Waggoner diagnostics. 2021. Available at <https://waggonerdiagnostics.com/pages/information>. Accessed July 30, 2021.

# Evaluation of Confocal Microscopy as a Diagnosis Tool on Red Blood Cell Diseases

Laura Rey-Barroso <sup>1,\*</sup>, Mónica Roldán <sup>2,5</sup>, Francisco J. Burgos-Fernández <sup>1</sup>, Susanna Gassiot <sup>3,5</sup>, Anna Ruiz Llobet <sup>4</sup>, Ignacio Isola <sup>3,5</sup> and Meritxell Vilaseca <sup>1</sup>

<sup>1</sup> Centre for Sensors, Instruments and Systems Development, Technical University of Catalonia; laura.rey.barroso@upc.edu, francisco.javier.burgos@upc.edu, meritxell.vilaseca@upc.edu

<sup>2</sup> Unit of Confocal Microscopy, Service of Pathological Anatomy, Hospital Sant Joan de Déu; mroldanm@sjdhospitalbarcelona.org

<sup>3</sup> Laboratory of Hematology, Service of Laboratory Diagnosis, Hospital Sant Joan de Déu; sgassiot@sjdhospitalbarcelona.org, imisola@sjdhospitalbarcelona.org

<sup>4</sup> Service of Pediatric Hematology, Hospital Sant Joan de Déu; aruizl@sjdhospitalbarcelona.org

<sup>5</sup> Institute of Pediatric Research, Hospital Sant Joan de Déu; mroldanm@sjdhospitalbarcelona.org, sgassiot@sjdhospitalbarcelona.org, imisola@sjdhospitalbarcelona.org

\* Corresponding author: laura.rey.barroso@upc.edu

## Abstract

In hereditary spherocytosis, mutations in red blood cell membrane proteins result in an overly rigid, misshapen cell whose deformability when traveling through the blood vessels is lost, causing severe anemia and splenomegaly, jaundice, and gallstones. In thalassemia, mutations in the globin genes can cause also severe anemia, skeletal and growth deficits and iron overload. Diagnosing these entities can be difficult due to the coexistence of other causes of anemia and blood transfusions, so complex molecular tests are required. In order to avoid these, we explored the possibility of using spectral confocal microscopy as a diagnostic tool for hereditary spherocytosis and thalassemia in pediatric patients. The red blood cell membrane was stained with different color dyes and immunolabels, to identify possible membrane defects expressed as differences in color and shape under a Leica TCS SP8. Staining the membrane and nuclei with lipophilic fluorescent dyes permitted the precise assessment of cell shape.

**Keywords:** *hereditary spherocytosis, confocal microscopy, spectral imaging, cell morphology, membrane stains*

## INTRODUCTION

Diagnosing blood diseases during childhood is crucial since they can cause very severe syndromes, affecting the correct development of several organs. Some of such diseases are hereditary spherocytosis (HS) and thalassemia.

HS is caused by mutations in at least five genes that code red blood cells (RBCs) membrane proteins, according to Eber and Lux (2004). These proteins transport molecules into and out of cells, attach to other proteins, and in general, they maintain cell structure. The misshapen RBCs in HS, called spherocytes, have a characteristic spherical shape and they are too stiff to circulate through capillaries, so they are removed from circulation and taken to the spleen, where they undergo hemolysis. The shortage of RBCs in circulation and the abundance of cells in the spleen are responsible for the signs and symptoms of HS. There are four forms of HS, which are distinguished by the severity of signs and symptoms. They are known as the mild form (20-30% prevalence), the moderate form (60-70% prevalence), the moderate/severe form (10% prevalence), and the severe form (3-5% prevalence). People with the mild form may have very mild anemia or sometimes have no symptoms. Moderate HS usually appear in childhood and causes anemia, jaundice, splenomegaly, and gallstones. Individuals with the moderate/severe form have all the of the moderate form but the anemia becomes severe. The severe form causes life-threatening anemia that requires frequent blood transfusions to replenish their red blood cell supply, splenomegaly, jaundice, and a high risk for developing gallstones. Some

individuals with the severe form have short stature, delayed sexual development, and skeletal abnormalities, according to Mariani et al. (2008).

Usually, the diagnosis of HS is based upon identifying the abnormal RBCs by their round shape and darker color under a conventional optical microscope; the darker color is caused by a greater amount of hemoglobin on a smaller cell volume. Also upon indices of a blood test that include a complete blood cell count (CBC), reticulocyte count and mean corpuscular hemoglobin concentration (MCHC) which is usually elevated. Other kinds of common indicators are the lactate dehydrogenase (LDH) level and the fractionated bilirubin level. In order to rule in or out other diseases that may be a cause of abnormal RBCs, a bone marrow biopsy can be also carried out. Despite these resources, sometimes these entities are not easy to diagnose. For very much equivocal cases, more complex studies of membrane proteins or even genetic studies need to be undergone, as stated by de Oliveira and Saldanha (2010).

In thalassemia, mutations result in a quantitative reduction in the rate of synthesis of the globin chains which form hemoglobin (alpha or beta-globin chains), referencing Desousky et al. (2009). Clinical manifestations of thalassemia syndromes range from no symptoms in asymptomatic carriers to serious abnormalities that include severe anemia, extramedullary hematopoiesis, skeletal and growth deficits and iron overload. The severity of the clinical features correlates with the number of functioning globin genes that are lost, according to Provan et al. (2015). Thalassemia is diagnosed by means of traditional techniques such as conventional microscopy and complete blood count analysis and, similarly to HS, sometimes genetic studies are needed to diagnose carriers and moderate forms of the disease.

Currently, confocal spectral microscopy is an imaging modality that is widely used for spectral, color and morphological analysis of any biological sample. It captures the light on a sample volume from a specific plane of focus with nanometric precision and from a wide spectral range, then by collecting several axial cuts, tridimensional (3D) color maps of the functional information of the cell can be build. Therefore, this imaging modality allows the sequential study of the cell structure and molecular components, arising from reflectance, autofluorescence, or even fluorescence by staining different cellular components with the use of extrinsic fluorescent probes.

Some related works stain the plasma membrane uniformly with lipophilic plasma membrane dyes not specific for any protein, for the assessment of cellular shape, not stablishing any differences in color or spectral content. Khairy et al. (2008) analyzed the 3D shapes of RBCs using the fluorescent color dyes Calcein and Vybrant Dil to label the cytoplasm and plasma membrane, respectively. These RBCs where collected from a healthy subject and chemically induced to acquire the characteristic shapes from pathologies such as spherocytosis. By means of mathematical simulations, authors were able to relate each shape with the amount of shear energy in the membrane associated cytoskeleton. Rappaz et al. (2008) compared the morphological values of RBCs, such as the mean cell volume and the RBC distribution width, obtained from different imaging techniques including spectral confocal microscopy. To perform volume assessment of RBCs using this technique, cells were labeled with the Vybrant Dil dye and excited at 561 nm, collecting the emission from 580 nm to 700 nm. They concluded that among all methods, digital holographic microscopy and spectral confocal microscopy, where the ones that led to a more precise volume estimation. In this context, and following our previous study in patients with thalassemia, referenced in Rey-Barroso et al. (2020), we have conducted experimental assays to analyze healthy and diseased RBCs in HS patients by means of spectral confocal microscopy, for the future development of simpler and more effective protocols of diagnosis.

## MATERIALS AND METHODS

### Subjects

Blood samples from 9 pediatric patients were evaluated, 5 males and 4 females between 1 and 18 years old, including patients with different forms of HS and also 3 healthy children as controls. Also the samples of 2 progenitors with HS were collected. Two parallel assays were conducted: a first, more complex immunostaining protocol by which certain proteins in the cell membrane were specifically targeted by means of antibodies (Ab) with different fluorescent probes attached; and a second study preserving the living cell and adding lipophilic membrane stains as done in the state of the art. The first study sought to reveal spectral/color variations in the Ab fluorescence intensity along the membrane; the second sought to label the membrane uniformly on fresh samples to be able to preserve the morphology of RBCs for its analysis. RBC indices (Table 1) for each sample were obtained using an ADVIA 2120i hematology analyzer (Siemens Healthcare Diagnostics Inc., Erlangen, Germany) within 2 hours after blood collection. Pediatric patients with HS are labeled as HS<sub>1-6</sub>, the progenitors that were also included in the study are labeled as HS<sub>P1</sub> and HS<sub>P2</sub>. Healthy children used as control subjects are labeled as HS<sub>C1-3</sub>. Subjects HS<sub>5</sub> and HS<sub>P1</sub> suffered from severe forms of HS and had to be splenectomized to ensure the disease best evolution and to improve their quality of life.

HS severity	Hb (g/dL)	MCV (fl)	MCHC (pg)	%RETI	%HPR	%MICRO
Severe	7.2	70.5	34.8	15.28	8.7	29.6
Moderate	11.4	88	34.9	9.03	9.2	2
Mild	14.5 ±1.50	82.8 ±8.35	36.0 ±0.81	3.3 ±1.49	9.5 ±7.59	3.9 ±5.11
Control	13.7 ±0.71	85.4 ±4.87	34.1 ±0.57	1.9 ±0.21	0.7 ±0.61	1.0 ±0.67

Table 1: Mean and standard deviation of severe (HS<sub>1</sub>), moderate (HS<sub>3</sub>), mild (HS<sub>2</sub>, HS<sub>4-6</sub>, HS<sub>P1-2</sub>) and control (HS<sub>C1-3</sub>) subjects for hemoglobin (Hb) in grams per deciliter (g/dL); medium corpuscular volume (MCV) in femtoliters (fL); medium corpuscular hemoglobin (MCHC) in picograms (pg) and percentage of reticulocytes (RETI), hyperchromic cells (HPR) and microcytic cells (MICRO).

HS is inherited in an autosomal dominant pattern for about 75% of cases, so one usual criteria for diagnosis of a child is that one of the progenitors is also affected by HS, according to Iolascon and Avvisati (2008). In general, the degree of severity of the disease is related with the degree of hemolysis, with parameters like hemoglobin in blood and reticulocytes count. A subject with severe HS is expected to have Hb (g/dL) < 8, reticulocyte count (%) > 10. In addition, the number of spherocytes present in the blood sample related with the hyperchromic cell count (%HPR) is an indicator of the severity of HS. Mutations in proteins responsible for HS occur predominantly in ankyrin, band 3, and beta-spectrin, and almost every family has a unique mutation. In this work, the genetic studies that were carried out on a few subjects did not reveal any differences over known mutation places.

### Sample preparation

Whole blood of patients with lithium heparin as an anticoagulant agent to avoid sample corruption was used to conduct both assays; for the immunostaining protocol, band 3 was the target protein to label. Cells had to be fixated with paraformaldehyde 2%, and then blocked with PBS-BSA 1%. Then,



they were incubated with a primary monoclonal mouse Ab, BRIC 200 specific for binding the extracellular domain of band 3. The fluorochrome molecule attached to the Ab was iFluor488 (International Blood Group Reference Laboratory, Bristol, UK) with a fluorescent green emission at 525 nm. Finally, samples were mounted over slides with cover slips to acquire 3D stacks of the fluorescence distribution of the Ab over the membrane.

For the study of the cells in-vivo, blood samples were used in fresh without the addition of solvents or any other kind of saline solution. Samples were loaded into cell culture dishes CELLview™ (Greiner Bio One GmbH, Courtaboeuf, France), which incorporate a cell-adhesion layer which is critical to prevent cellular movement when capturing an image stack of living RBCs. The cell membrane and nuclei were stained respectively with fluorescent color dyes CellMask™ Deep Red with a fluorescent red emission at 666 nm, and Hoechst 33342, which is a fluorescent staining with blue emission wavelength at 461 nm (Thermo Fisher Scientific Inc., Waltham, MA USA). With temperature and CO<sub>2</sub> control inside the microscope cabin, the 3D stacks of the samples were acquired to evaluate the number of spherocytes in the blood samples of the aforementioned patients.

### **Spectral confocal microscopy evaluation**

The samples were analyzed under a Leica TCS SP8 confocal microscope with stimulated emission depletion (STED) 3× super resolution (Leica Microsystems GmbH, Mannheim, Germany). It incorporates hybrid detectors capable of detecting signals with high sensitivity coming from RBCs from 400 nm to 790 nm. The microscope incorporates two lasers for excitation: a diode laser with an emission of 405 nm and a white laser that emits from 470 nm to 670 nm, combined with an acoustic-optic tunable filter (AOTF).

To collect the spectral emission of the stained RBCs, a 63× (NA 1.4, oil) plan-apochromatic objective was used and a 1 airy unit (AU) pinhole was set. For the case of the immunostained cells, BRIC 200 whose fluorescent probe was iFluor488 was excited with the white laser (488 nm) and detected in the 505–580 nm range. For the case of the in-vivo analysis, Hoechst 33342 DNA label was excited with a blue diode (405 nm) and detected in the 420–470 nm range. The CellMask™ dye was excited with a white laser (633 nm) and detected in the 645–775 nm range. An image acquisition sequence  $xy\lambda z$  to acquire the 3D stacks of the fluorescence distribution of the color dyes was performed, using hybrid detection. Finally, images were deconvoluted using software Huygens Professional Software v17.10.0p8 (SVI, Leiden, The Netherlands) in order to improve image quality. Images of both assays were generated using the Leica LAS X software (Leica Microsystems, Wetzlar, Germany).

## **RESULTS AND DISCUSSION**

For the first immunostaining assay, the fluorescent 3D image stacks with labeled band 3 were recovered. From 5 to 10 fields were acquired over the whole blood samples of each subject. The membranes were stained with a bright green color and the projection sum of the images of each stack was calculated to retrieve the mean fluorescence of the samples. In Figure 1, we represented some of the acquired fields for four of the subjects, but all of them led to very similar values of mean fluorescence. This means that there are no spectral/color variations for this particular protein among different HS forms or healthy patients in the 505–580 nm range. Nevertheless, a more complex immunostaining protocol could be established to enhance the cellular structures and get a greater detail over the membrane for the analysis of the Ab distribution. On the contrary, in the experimental assays conducted on thalassemia, in which we studied the autofluorescence of the samples, living RBCs were excited at 405 nm and their emission was collected in the spectral range from 425 nm to 790 nm.

Differences at 628 nm and 649 nm emission peaks, mainly, were found due to the porphyrin presence in blood due to heme group degradation, Rey-Barroso et al. (2020).

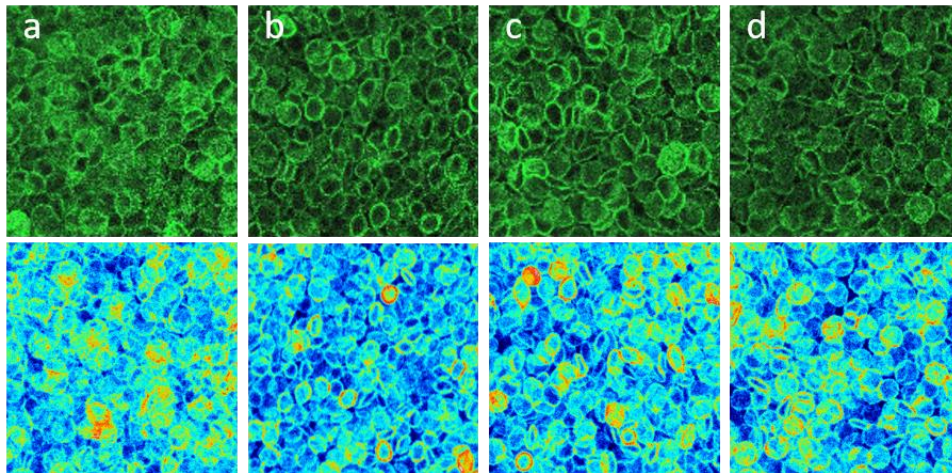

Figure 1: A confocal spectral image from the 3D stack acquired at 505-580 nm of images for a field (top) and its projection sum image (bottom) of subjects (a) HS<sub>c2</sub>, image of field 03 and projection sum, (b) HS<sub>2</sub>, image of field 04 and projection sum (c) HS<sub>6</sub>, image of field 02 and projection sum, (d) HS<sub>p2</sub>, image of field 03 and projection sum.

For the in-vivo assay, a set of high-quality 3D image stacks were acquired for 5 to 10 fields over the whole blood samples of each subject. The membranes were stained with a bright red color that permitted the precise assessment of cellular shapes when evaluating the fluorescence of the CellMask™ dye in the 645–775 nm range (Figure 2). Among them, healthy RBCs presented the characteristic biconcave shape and a central pallor region. Spherocytes, smaller and rounder RBCs, were also present in the samples from diseased individuals. They are hyperchromic RBCs since they contain more hemoglobin than those normal in relation to cell volume, which is  $< 80 \mu\text{m}^3$ . Neutrophils were distinguished from RBCs for its bright blue stained nuclei as a consequence of the Hoechst 33342 fluorescent color dye. From the image stacks in Figure 2, we can identify all the aforementioned cellular types and relate data in Table 1 regarding the percentage of hyperchromic cells with the number of spherocytes population for each subject. That is why a higher hyperchromic cell count is related to HS. Unlike conventional optical microscopy, confocal spectral microscopy allows the precise and unequivocal 3D assessment of cell shape.

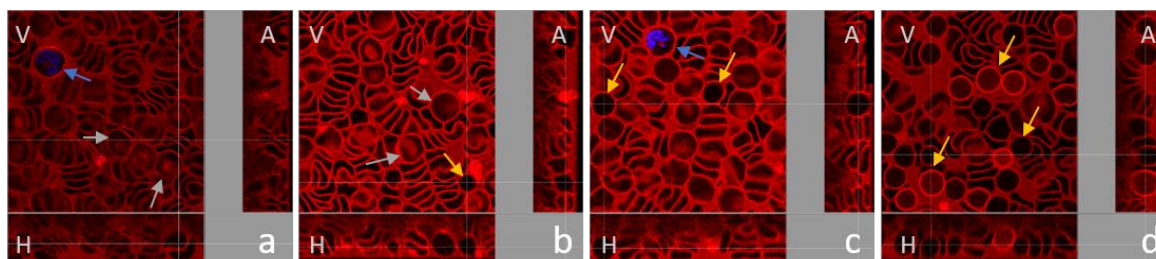

Figure 2: Confocal spectral image stacks of one field on which a vertical (V), a horizontal (H) and an axial (A) section has been selected in (a) HS<sub>c2</sub>, where no spherocytes are visible and %HPR = 0.4, in (b) HS<sub>4</sub>, where just some few spherocytes (yellow arrows) are visible and %HPR = 5.3, in (c) HS<sub>6</sub> where some more spherocytes are visible and %HPR = 9.2, in (d) HS<sub>p2</sub>, where there is a high number of spherocytes present and %HPR = 22.9. Neutrophils are those cells with blue nuclei (blue arrows). Normal RBCs are labeled with gray arrows.

## CONCLUSIONS

A 3D image-based method for the evaluation of HS has been presented. Spectral confocal imaging has been shown to be a direct way to precisely identify the number of spherocytes on patient's samples, instead of making an estimate with the hyperchromic cell count. In this work, we have proven that simply color labeling the membrane and nuclei of blood cell types, patients' samples with some degree of HS are clearly different from healthy patients' samples when evaluating the morphology of RBCs.

Research efforts are now focused on trying to label the more specific proteins in the membrane of RBCs that are known to be affected in HS and find spectral signatures to better discriminate between healthy RBCs and those suffering from HS. For this purpose, protocols on color labeling and preservation of this kind of samples, which are corrupted in a very short time window, are being investigated.

## ACKNOWLEDGEMENTS

This research was funded by the Ministerio de Economía, Industria y Competitividad (MINECO), the Agencia Estatal de Investigación (AEI) and the European Regional Development Fund (ERDF), grant number DPI2017-89414-R.

## REFERENCES

- De Oliveira, S. and C. Saldanha. 2010. An overview about erythrocyte membrane. *Clin. Hemorheol. Microcirc.* 44: 63-74.
- Desouky, O.S., N.S. Selim, E.M. El-Bakrawy, and S.M. El-Marakby. 2009. Biophysical characterization of  $\beta$ -thalassemic red blood cells. *Cell Biochem. Biophys.* 55: 45–53.
- Eber, S. and Lux, S. 2004. Hereditary Spherocytosis - Defects in Proteins That Connect the Membrane Skeleton to the Lipid Bilayer. *Seminars in hematology* 41. 118-41.
- Iolascon, A. and Avvisati, R.A. 2008. Genotype/phenotype correlation in hereditary spherocytosis. *Haematologica* 93: 1283-1288.
- Khairy, K., J. Foo, and J. Howard. 2008. Shapes of Red Blood Cells: Comparison of 3D Confocal Images with the Bilayer-Couple Model. *Cell. Mol. Bioeng.* 1: 173–181.
- Mariani, M., W. Barcellini, C. Vercellati, A.P. Marcello, E. Fermo, P. Pedotti, C. Boschetti, and A. Zanella. 2008. Clinical and hematologic features of 300 patients affected by hereditary spherocytosis grouped according to the type of the membrane protein defect. *Haematologica* 93(9): 1310-1317.
- Provan, D., T. Baglin, I. Dokal, and J. de Vos. 2015. *Oxford Handbook of Clinical Haematology*. Oxford: Oxford University Press.
- Rappaz, B., A. Barbul, Y. Emery, R. Korenstein, C. Depeursinge, P.J. Magistretti, and P. Marquet. 2008. Comparative study of human erythrocytes by digital holographic microscopy, confocal microscopy, and impedance volume analyzer. *Cytom. Part A* 73: 895–903.
- Rey-Barroso, L., M. Roldán, F.J. Burgos-Fernández, S. Gassiot, A. Ruiz Llobet, I. Isola, and M. Vilaseca. 2020. Spectroscopic Evaluation of Red Blood Cells of Thalassemia Patients with Confocal Microscopy: A Pilot Study. *Sensors* 20: 4039.

# A specific use of colour and dyes: “Vital dyes in ophthalmology”

Kazim Hilmi Or <sup>1,\*</sup>

<sup>1</sup> Private Office of Ophthalmology. Hamburg. Germany; hilmi.or@gmail.com

\* Corresponding author: hilmi.or@gmail.com

## Abstract

The human eye is a very unique organ like a living camera. with many translucent tissues and cells. During eye examinations and operations it may be necessary to differentiate between these structures which are in microscopic scales. Vital dyes have to be non-toxic to the human body and to the external and/or internal tissues of the human eye. The adherence properties at the eye tissues make them usable for the visibility and discrimination of similar looking physiological and pathological eye tissues. Especially the use of state of art 3D heads up surgery operating microscope technology make the use of low illumination at operating sites possible. So nanotechnology using liquid crystals and plasmonic colour sources which make use of environmental illumination without the need of extra illumination can be the basics of the innovation for new vital dyes.

**Keywords:** *Vital dyes, translucent tissues, discrimination of tissues, 3D heads up surgery, liquid crystals*

## INTRODUCTION and AIM

The diversity of different dye and colour characteristics of vital dyes in ophthalmology is explained. The state of art of vital dyes in ophthalmology achieved through innovations in nanotechnology is a high one. It is probable improvement in the near future with the use of nanotechnology, plasmonic colours and liquid crystals is explained according to new operating microscope technologies in ophthalmology.

## THE EYE'S TISSUE PROPERTIES IN REGARD OF VITAL DYES

The eye is like a living camera. It has translucent and opaque tissues to make an optical image of the environment on the retina. Light perception information is transferred from the photoreceptors and neurons in the retina to the brain as electrical signals. As a living and non-stop functioning organ with multiples tissues it is important that during (and after) medical examination, therapy or surgery of the eye all the tissues are kept healthy, functional and -if it is its physiological feature of the affected tissue- translucent. On the other hand, the anatomically, physiologically and pathologically different translucent tissues should be marked efficiently, to be evaluated and / or treated and / or operated only at the targeted tissue or cells (Forrester et al. 2016; Levin et al. 2011).

All these considerations have to be made on microscopic and sometimes even on molecular scales. Another consideration is vital dyes have to be non-toxic to the human body and to the external and/or internal tissues of the human eye where they are applied. The diffusion and adherence properties of special vital dyes through or at the tissues of the eye make them usable for special purposes. The colours of different dyes can be advantageous for the visibility and discrimination between similar looking physiological and pathological eye tissues. Another consideration is that the dyes in ophthalmology should not have to be covering, because simultaneous inspection of other adjacent tissues is needed mostly in ophthalmology.

### **VITAL DYES IN REGARD OF APPLIED TISSUES**

For the conjunctiva bengal rose and lissamine green dyes may be used to give colour to the dead conjunctival or mucus cells on the surface of the eye. These dyes are absorbed only by dead cells, which are still in the tissue. So some specific diagnosis can be made using these dyes (Badaro et al. 2014).

The epithelial cell defects of the translucent tissues of the conjunctiva and cornea may be seen through the fluorescent colour of the dye fluorescein much easier. The orange dye dissolved in water causes fluorescence under blue light and is seen green. Because the dye isn't absorbed by the eye surface tissues one can see the fluorescence in the defects of these tissues (Badaro et al. 2014)

Trypan blue may be used to color the normally translucent anterior capsule of the lens in cataract operations to be seen and being handled (capsulorhexis) easier in eyes with white cataracts. The dye remains in the capsule. The central circle (about 5,5 mm in diameter) of the anterior lens capsule is removed after the capsulorhexis, so that the optical axis of the eye remains optically clear during and after surgery (Badaro et al. 2014).

Eye is the only organ in the human body in which the blood vessels can be observed directly. Normal human blood vessels are watertight. In some diseases this may be interrupted and there may be fluid leakage from vessels to the surrounding tissues. Fluorescein given intravenously may give fluorescent images when made black and white photos are shot with blue flashlight (fundus fluorescein angiography) during the passage through blood vessels of the retina. Through this phenomenon the blood vessels of the fundus of the eye can be evaluated for fluid leakage and other vessel properties (Agarwal 2008; Badaro et al. 2014).

There are many dyes in different colours and adherence properties (sometimes even combined) used for the vitreoretinal surgery, which can be given into the vitreous body or cavity. The peeling operation of the internal limiting membrane or ELM of the retina can be made easier with special vital dyes which adhere to some tissues and not to some others. Triamcinolone acetonide, bromophenol blue, patent blue, brilliant blue can be used in certain concentrations intravitreally without being toxic (or being little toxic) to the retina. These dyes are used to see and mostly remove the tissues easier during the operation. Because the dye specifically adheres to the target tissue it is removed from the eye together with the tissue. So it does not remain in the eye (Badaro et al. 2014; Farah et al. 2016).

In conclusion; the use of dyes with different colours, with different adherence properties to different translucent tissues and different colour generating properties may be helpful for eye surgeons in eye examinations and surgeries differentiating between similar looking tissues.

### **INNOVATIONAL CONSIDERATIONS ABOUT VITAL DYES**

It needs long periods of time and efforts of research in many stages that new vital dyes are made as an innovation and are allowed through authorities to be used in the human body. Nanotechnology combined with software and biological gene technology may change this.

The specific receptors to be used by dyes in the target tissues in the eye can be determined. With nanotechnology binding bridge molecules and /or proteins to that receptors can be produced. Specific liquid crystals and plasmonic colours can be produced to be used as colour producer, which aren't like dyes which may have toxic and other unwanted characteristics. An advantage of them is that they do not need any special light source. They use the existing light in their environment to "produce" colour. They can be put in a translucent shell, which is inert to the human body and/or eye. Not-needing an

extra light source for colour is important, because the technology in the anterior and posterior segment surgery in ophthalmology is changing. With the use of 3D heads up surgery surgeons don't look into the oculars of surgical microscopes. They look at big 4K screens where the image from the operating microscope is transmitted with software. Because of the light modulation in the digital system all ophthalmic surgeries can be made with much less illumination levels in new models (Matsumoto et al. 2019). Innovational vital dyes which need only the light of its surrounding and don't need extra illuminance may be advantageous in 3D heads up surgeries.

## **RESULTS**

The use of vital dyes is important for eye examinations, therapies and surgeries. Their characteristics depend on the target tissue and/or cells. So, dyes with different characteristics are needed and used in ophthalmology. The innovational change of ocular surgery with use of 3D heads up surgery may ease innovational use of liquid crystals and plasmonic colours as vital dyes.

## **REFERENCES**

- Agarwal, A. 2008. *Fundus Fluorescein and Indocyanine Green Angiography: A Textbook and Atlas*. United States of America. Slack.
- Badaro, E., E.A. Novais, F.M Penha. , M. Maia, M.E. Farah and E.B. Rodrigues. 2014. Vital dyes in ophthalmology: a chemical perspective. *Curr Eye Res*. 39(7):649-58.
- Farah, M.E., M. Maia, F.M. Penha, E.B. Rodrigues (2016) The Use of Vital Dyes during Vitreoretinal Surgery - Chromovitrectomy. *Dev Ophthalmol*. 55:365-75.
- Forrester, J.V., A.D. Dick, P.G. McMenemy, F. Roberts and E. Pearlman. 2016. *The Eye. Basic Sciences in Practice*. Edinburgh, London, New York, Oxford, Philadelphia, St Louis, Sydney, Toronto. Elsevier.
- Levin, L.A., S.F. Nilsson, J. Ver Hoeve and S.M. Wu. 2011. *Adler's Physiology of the Eye*. St Louis, London, Philadelphia, Sydney, Toronto. Mosby.
- Matsumoto, C.S., M. Shibuya, J. Makita, T. Shoji, H. Ohno, K. Shinoda, and H. Matsumoto. 2019. Heads-Up 3D Surgery under Low Light Intensity Conditions: New High-Sensitivity HD Camera for Ophthalmological Microscopes. *J. Ophthalmol*. 2019:5013463.



# Assessing colour vision using single and multi test protocols

Marisa Rodriguez-Carmona<sup>1\*</sup>, Benjamin E.W. Evans<sup>1</sup> and John L. Barbur<sup>1</sup>

<sup>1</sup> Centre for Applied Vision Research, School of Health Sciences, City, University of London, UK;  
marisa@city.ac.uk; Benjamin.Evans@city.ac.uk; J.L.Barbur@city.ac.uk

\* Corresponding author: marisa@city.ac.uk

## Abstract

The purpose of this study was to produce reliable predictions of colour assessment outcomes and to examine the extent to which existing single- and multi-test protocols meet current occupational requirements. The statistical outcomes of commonly used colour assessment tests have been investigated in this study. All subjects also carried out Colour Assessment and Diagnosis (CAD) and Nagel anomaloscope tests. The sample included 1827 subjects with normal and congenital colour deficiency (age  $31.1 \pm 12.4$ , range 10-65 years). The single test protocols pass all normals and almost 50% of subjects with colour vision deficiency. The multi-test protocols, designed to identify protans and to pass only subjects with mild colour loss, pass over 50% of protans and deuterans. Many of the subjects who fail exhibit less severe loss of colour vision than others who pass. When high sensitivity for detection of congenital deficiency is achieved, single-test protocols fail many normal trichromats. Multi-test protocols produce large variability and fail to achieve desired aims.

**Keywords:** Colour tests, Colour protocols, Ishihara, Farnsworth D-15, CAD test.

## INTRODUCTION

The detection of small changes in chromatic sensitivity in early stage diseases of the eye and accurate assessment of the type and severity of colour vision (CV) loss have recently become more important, both within the clinic and for setting minimum requirements within visually-demanding occupations. This has encouraged the development of novel tests which isolate fully the use of red-green (RG) and yellow-blue (YB) colour signals and quantify more reliably the severity of CV loss (Barbur and Rodriguez-Carmona 2017; Reffin et al. 1991; Barbur et al. 1994; Rabin et al. 2011; Fernandes et al. 2020). The purpose of this study was to produce reliable predictions of colour assessment outcomes and to examine the extent to which existing single- and multi-test protocols meet current occupational requirements. The use of such protocols relies mostly on conventional tests to assess the applicant's class of CV and severity of loss. Commonly used tests include the Ishihara (IH) pseudoisochromatic test plates, colour arrangement tests such as the Farnsworth Munsell D-15 and City University (CU) and lantern tests such as the Holmes-Wright type-A lantern (HW-A) employed in the UK.

The IH test (Kanohara and Co. Ltd., Tokyo, Japan) is the most widely accepted screening test for congenital protan and deutan defects. Since its publication in 1917 it has been reprinted in various editions, including a full, abbreviated and concise version which contain 38, 24 and 14 plates respectively. The full version has been recommended for routine clinical use (Birch and McKeever 1993). Both the D-15 (Farnsworth 1947) and CU (Fletcher 1972) tests screen for 'moderate and severe' CV loss (Margrain et al. 1996; Birch 2001). The D-15 panel contains 15 movable colour samples judged to have approximately equal hue steps when illuminated with daylight. The CU (2nd ed.) test consists of a series of ten plates. Each plate displays five coloured discs selected from the Munsell series mounted on a black matt background: one central and four peripheral colours of equal size. The first six plates contain large circles and the last four smaller circles. The HW-A lantern test (Wright 1982) presents one of nine pairs of vertical colour combinations (Birch 2008); two reds, two greens and one white. The lights have (x, y) - chromaticity co-ordinates within the limits for signal lights agreed



internationally by the CIE (CIE 2001). The IH, D-15 and CU tests are commonly used in clinics and in occupational environments, whilst the HW-A is mainly an occupational test.

Protocols based on multiple tests have been produced to screen for normal trichromatic CV as required in the most visually demanding occupations (such as air traffic control) or to pass all normal trichromats and colour deficient subjects with mild loss of RG chromatic sensitivity (as practiced in the electrotechnical industry). Protocols have also been designed to pass subjects with a pre-determined level of RG loss and to exclude all protans (e.g., UK fire fighters and special duties police officers). The efficiency of these protocols have not been examined thoroughly before, largely because conventional colour assessment tests often fail to isolate RG and YB colour signals and to diagnose accurately the applicant's type of CV. Equally important, until very recently it has not been possible to assess accurately the strength of RG colour loss in applicants who pass and those who fail a given protocol.

Protocol	Initial Screening	Secondary Testing
A	Ishihara 24-plate ed. no errors on plates 1-15	Holmes-Wright (A) lantern (no errors)
B	Ishihara 38-plate ed. ≤ 4 errors on plates 1-21	Farnsworth D-15 (accept ≤ 1 major crossing) and City University test 2nd ed. (overall ≤ 4 errors and ≤ 1 error on 'large plates')*
C	Ishihara 24-plate ed. ≤ 2 errors on plates 1-17	Farnsworth D-15 (accept ≤ 2 adjacent transpositions) and Nagel anomaloscope (only deuteranomaly)

Table 1: Summary of three multi-test protocols developed to assess minimum colour vision requirements in visually demanding and safety-critical occupations such as aviation, police and fire services \*Protocol B also excludes all applicants diagnosed with protan deficiency based on 2/3 of the tests employed and number of allowed adjacent transpositions is not specified (adapted from Rodriguez-Carmona, 2021).

## METHODS

The statistical outcomes of the tests mentioned above have been investigated in this study. All subjects also carried out the Colour Assessment and Diagnosis (CAD) and Nagel anomaloscope tests. The sample included 350 normal trichromats, 1012 deutans and 465 protans (age  $31.1 \pm 12.4$ , range 10-65 years). The results of these tests were used to examine the level of CV loss in those applicants who pass/fail.

Three multi-test protocols selected for examination in this study are shown in Table 1. The initial screening is carried out by the IH test and this varies in edition and plates used. When the initial screening is failed, secondary testing takes place. Protocols A and B aim to pass only subjects with normal CV. In addition, protocol B is failed if an applicant is diagnosed as having protan deficiency on 2 of the 3 tests carried out. Protocol C aims to pass all normal trichromats and deutan subjects with mild deficiency and to exclude all protans. If the applicant passes the D-15 test, an anomaloscope test is required to identify and exclude protans.

## RESULTS

### Single colour assessment tests

Table 2a shows the percentage of normals, deutan and protans who pass four, commonly used IH test protocols. Table 2b and c show similar results for the D-15 and the CU tests. The maximum CAD RG thresholds for normal, deutan and protan subjects who pass each protocol are shown in the grey columns. The results are based on 1827 subjects (N=350, D=1012 and P=465) and show that when no errors are allowed on the first 25 plates of the 38 plates ed., the test fails ~ 19% of normal trichromats and almost all protans and deutan. This high sensitivity is achieved at the expense of specificity. Results of other popular protocols based on zero errors or two or fewer errors on the 24 plates ed. yield similar results with a tradeoff between specificity and sensitivity. Table 2b is based on 674 subjects (N=75, D=395 and P=205) and reveals the large percentages of deutan and protans who pass the D-15 test, some with RG thresholds approaching 25 CAD units. Table 2c is based on 636 subjects (N=133, D=353 and P=150) and shows the percentage of subjects within each class who pass the CU test. When no errors are allowed, almost all normal trichromats pass, but ~46% of deutan and ~39% of protans also pass. Protocols based on this test often allow 4 or fewer errors on the small dot plates and a maximum of one error on the large dot plates. The net result is to increase further the percentage of deutan and protans who pass, some with severe loss of CV (Rodriguez-Carmona et al. 2021).

<b>(a) Ishihara</b>		<b>38-plate ed</b>		<b>38-plate ed</b>		<b>24-plate ed</b>		<b>24-plate ed</b>	
Pass criteria	no errors on plates 1-25	MAX RG	≤ 4 errors on plates 1-21	MAX RG	no errors on plates 1-15	MAX RG	≤ 2 errors on plates 1-17	Max RG	
N (350)	80.6%	2.5	99.4%	3.0	88.9%	2.5	98.9%	3.0	
D (1012)	0.7%	9.1	5.3%	14.7	0.9%	4.84	3.8%	13.0	
P (465)	0.2%	9.4	0.9%	13.3	0.2%	9.44	0.9%	13.3	

<b>(b) Farnsworth D-15</b>						
Pass criteria	≤ 0 major crossings & ≤ 2 adj transpositions		MAX RG	≤ 1 major crossing & ≤ 2 adj transpositions		MAX RG
N (75)	100%		2.1	100%		2.1
D (395)	54.2%		25.8	59.5%		25.8
P (205)	42.9%		24.7	46.3%		24.7

<b>(c) City University 2<sup>nd</sup> ed.</b>						
Pass criteria	no errors		MAX RG	overall ≤ 4 errors or ≤ 1 error on 'large plates'		MAX RG
N (133)	99.3%		2.1	100%		2.1
D (353)	45.6%		15.0	66.0%		21.8
P (150)	38.7%		23.9	56.0%		23.9

Table 2: The statistical outcomes of four, most common protocols based on the Ishihara test are shown in (a). Two common pass criteria used on the Farnsworth D-15 and City University (2nd Ed.) tests are shown in (b) and (c), respectively. The percentage of subjects who pass each protocol is shown for each class of colour vision (N for normals, D for deutan and P for protans) together with the maximum RG CAD threshold observed within each class (adapted from Rodriguez-Carmona, 2021).

### Multi-test protocols

A summary of the pass rates for each multi-test protocol is shown in Table 3. Protocol A, based on Ishihara 24 (or 38) plates ed. with zero errors followed by HW-type A lantern test passes all normal

trichromats, ~22% of deuterans and ~1% of protans. Protocol B, based on Ishihara followed by D-15 and CU (2nd ed.) tests passes all normal trichromats, ~56% of deuterans and ~47% of protans. The protocol passes more than half of all subjects with congenital RG deficiency. Protocol C is based on IH (with two or fewer errors on the first 17 plates of the 24-plates ed.), followed by D-15 (with 2 or fewer major crossings accepted as a pass). Those who pass are then further tested on the Nagel anomaloscope to ensure applicant is deutan and not protan like. All normal trichromats, ~55% of deuterans and just below 2% of protans pass this protocol.

Protocol A			Protocol B			Protocol C		
No. subjects	Pass rate (%)	MAX RG	No. subjects	Pass rate (%)	MAX RG	No. subjects	Pass rate (%)	MAX RG
N (41)	100	2.2	N (57)	100	2.2	N (57)	100	2.2
D (226)	22.1	12.0	D (261)	55.6	21.8	D (261)	54.8	17.7
P (92)	1.2	9.4	P (109)	46.8	23.9	P (109)	1.8	13.3

Table 3: Statistical outcomes of protocols A, B and C showing the percentage of applicants within each colour vision class who pass each protocol. The grey columns list the highest RG colour threshold within each class. The upper RG limit for young, normal trichromats is ~ 1.85 CAD units (adapted from Rodriguez-Carmona, 2021).

## DISCUSSION

The results reveal how well each test and protocol accomplishes its objectives, whether these require applicants to have normal CV, mild loss or to exclude all those with a specific type of deficiency. Table 2(a) shows that the IH test can achieve high sensitivity when screening, however this is at the cost of failing up to 19% of normals (38-plate ed.). Due to its simplicity and availability, the IH is relatively easy to learn, making use of cues other than colour to carry out the test (Chorley 2015).

The D-15 and CU tests are unsuitable because of the large number of congenital colour deficient who pass, in spite of severe loss of RG (see Table 2b, c). It is of interest to examine why the D-15 and CU tests are still in current use, either as single tests or part of multi-test protocols. The justification for the continued use of these tests is based on the desire to pass colour deficient subjects with mild to moderate loss of RG chromatic sensitivity and to facilitate the identification of protans who are considered unsafe to work in certain environments where protans may be disadvantaged (Cole 2004). The D-15 and CU tests, when used in isolation, fail to achieve either of these objectives (Evans et al 2021; Almunstanyir et al. 2020). Table 3 lists the outcome of the three multi-test protocols investigated in this study. Protocol A was designed for use in aviation and other transport related occupations. Although the initial screening component fails 11-19% of normals (depending upon the version of IH test employed), secondary testing using the HW-A lantern ensures that all normal trichromats and 22% of deuterans pass and are indistinguishable from the normals who pass. One protan subject with a RG threshold of 9.4 passes protocol A, with zero errors on the IH and HW-A lantern test. It is worth noting that protocol A performs much better than protocol B in passing less severe colour deficient subjects and excluding protans. The results reveal a large variability in RG CV loss in the deuterans who pass (range ~2 to 12 units) and those who fail (range ~2 to 28 units) protocol A.

Protocol B is the most complex in current use and is arguably the least effective of the three protocols in achieving its stated aims. The protocol aims to pass all normal trichromats whilst excluding those with either severe loss of RG and / or those with a protan deficiency. The protocol employs IH (38-plate ed.) with  $\leq 4$  errors on plates 1 to 21 followed by D-15 and CU tests for all subjects who fail

the IH test. All subjects diagnosed as protan in at least two of the three tests also fail the protocol (Table 1). In spite of its intricacy, the protocol produces poor results; 56% of deuterans and 47% of protans pass, some with severe loss of RG (Table 3). There is also a spread in the severity of RG loss of those who pass and those who fail protocol B. This exposes the unjust potential outcomes of this protocol with many less severe deutan and protan applicants who fail and many others who pass with significantly more severe loss of RG chromatic sensitivity.

Protocol C relies on the use of IH with  $\leq 2$  errors on the first 17 plates of the 24 plates ed. followed by D-15 and the anomaloscope in those who fail. The protocol excludes protans by using the anomaloscope test which requires an experienced clinician. The protocol produces significant overlap in the deuterans who pass and those who fail. Protocol C excludes all protan subjects except for two with RG thresholds of 13.3 and 9.4 CAD units who pass the protocol C's criteria for the IH and, under the normal protocol conditions, would not be required to take the anomaloscope test.

The results presented in this short paper show that current tests and protocols fail to achieve their stated aims for various reasons. None of the tests employed in the multi-test protocols account for the expected changes in chromatic sensitivity as a result of normal aging (Barbur and Rodriguez-Carmona 2015). The tests fail to exclude the potential use of other cues and may also fail to achieve adequate isolation of only RG or only YB colour signals. As a result, the tests do not achieve high sensitivity and specificity and fail to quantify reliably the extent of RG and YB loss. The CAD test isolates the use of RG and YB colour signals using dynamic luminance contrast noise (Barbur et al. 2002) to mask the detection of luminance contrast signals and uses several colour directions to allow for potential variation in the orientation of colour confusion lines. The CAD test has relatively small within subject variability (Barbur et al 2021) and the test quantifies severity of CV loss based on thresholds which are directly proportional to the cone contrasts generated by the coloured stimulus and classifies the subject's type of CV with the same accuracy that can be achieved using the anomaloscope. This is important in some occupations when it is desired to exclude protan subjects or to set differential pass / fail limits for deutan and protans, as has been done in commercial aviation (Barbur and Rodriguez-Carmona 2017). The high sensitivity of the CAD test and assessment of both RG and YB thresholds makes the test particularly useful in the clinic. The disadvantages of the CAD test include the high cost of fully calibrated equipment and the relatively long time needed for full RG and YB colour assessment ( $\sim 12$  to 15 minutes). A new, 'two-test' protocol (Barbur et al. 2021) based on the initial use of a rapid Colour Vision Screener with close to 100% sensitivity, reduces to 6% the number of applicants required to take the full CAD test. Technological advances in visual displays and improved understanding of the limits of colour assessment in human vision can be used to overcome many of the limitations of conventional colour assessment tests and lead to safer and fairer colour assessment protocols for use both in occupations and in the clinic.

## **CONCLUSION**

Single and multi-test protocols based on conventional colour tests fail to meet current colour assessment requirements. The IH test has the highest sensitivity for detection of subjects with RG congenital deficiency, but the test has poor specificity and fails to identify accurately the subject's type of colour deficiency and severity of loss. The D-15 and the CU (2nd ed.) tests are inappropriate for occupational use since they fail to diagnose reliably the subject's type of colour deficiency and to estimate the severity of CV loss. The use of secondary tests with equally poor sensitivity and specificity fails to solve the problem, particularly when the aim of the protocol is to exclude protan applicants and to pass only those with CV loss below a specified level.

## ACKNOWLEDGEMENTS

We acknowledge the UK Civil Aviation Authority, the Colt Foundation and City, University of London for financial support with this study.

## REFERENCES

- Almustanyir, A., J. Hovis and M.G. Glaholt. 2020. *Predicting the Farnsworth-Munsell D15 and Holmes-Wright-A lantern outcomes with computer-based color vision tests*. *J Opt Soc Am A*. 37:A1-A10.
- Barbur, J.L., J.A. Harlow and G.T. Plant. 1994. Insights into the different exploits of colour in the visual cortex. *Proc R Soc Lond B*. 258:327-334.
- Barbur, J.L. and M. Rodriguez-Carmona. 2017. Colour vision requirements in visually demanding occupations. *British Medical Bulletin* 122: 51-77.
- Barbur, J.L. and M. Rodriguez-Carmona. *Color vision changes in normal aging*. In: A.J. E, M.D. F, A. F (eds), *Handbook of Color Psychology*. Cambridge, UK: Cambridge University Press. 180-196.
- Barbur, J.L., M. Rodriguez-Carmona and M. J. Morgan. 2002. Double-Blindsight in Human Vision. *Investig Ophthalmol Vis Sci*. 43:3909.
- Birch, J. and L.M. McKeever. 1993. Survey of the accuracy of new pseudoisochromatic plates. *Ophthalmic Physiol Opt*. 13:35-40.
- Birch, J. 2001. *Diagnosis of defective colour vision*. 2nd Ed. ed. Oxford: Butterworth-Heinemann.
- Birch, J. 2008. *Performance of colour-deficient people on the Holmes-Wright lantern (type A): consistency of occupational colour vision standards in aviation*. *Ophthalmic Physiol Opt*. 28:253-258
- Chorley, A.C. 2015. *A modified protocol for color vision screening using Ishihara*. *Aerosp Med Hum Perform*. 86 747-751.
- CIE. 2001. Colours of signal lights. Vienna Austria., Standard: S004/E-2001: Bureau Central de la CIE.
- Cole, B.L. 2004. *The handicap of abnormal colour vision*. *Clin Exp Optom*. 87:258-275.
- Evans, B.E.W, M. Rodriguez-Carmona and J. L. Barbur. 2021. Assessment of chromatic sensitivity: 1. Visual signals that affect the outcome of color screening tests with emphasis on the Farnsworth D-15. *Color Res Appl*. 46:7-20.
- Farnsworth, D. 1947. *The Farnsworth dichotomous test for color blindness - Panel D-15*. New York: Psychological Corporation.
- Fernandes, T.P., N.A. Santos and G.V. Paramei. 2020. Cambridge Colour Test: reproducibility in normal trichromats. *J Opt Soc Am A Opt*. 37:A70-A80.
- Fletcher, R. 1972. Methods of examination of macular colour vision. A modified D-15 test. *Mod Probl Ophthalmol*. 11:22-24.
- Margrain, T.H., J. Birch, J. and C.G. Owen. 1996. Colour vision requirements of firefighters. *Occup Med (Lond)*.46(2):114-24.
- Rabin, J., J. Gooch and D. Ivan. 2011. Rapid quantification of color vision: the cone contrast test. *Invest Ophthalmol Vis Sci*. 52:816-820.
- Reffin, J.P, Astell. S. and J.D. Mollon. 1991. Trials of a computer-controlled colour vision test that preserves the advantages of pseudoisochromatic plates. Dordrecht, Netherlands: Kluwer Academic Publishers; 69-76.
- Rodriguez-Carmona, M., B.E.W. Evans and J.L. Barbur. 2021. Color vision assessment-2: Color assessment outcomes using single and multi-test protocols. *Color Res Appl*. 46:21-32.
- Wright, W.D. and J.G. Holmes. 1982. A New Colour Perception Lantern. *Color Res Appl*. 7:82-88.

# The Construction of Color by The Congenitally Blind

Flávia Mayer <sup>1,\*</sup>

<sup>1</sup> Federal University of Paraíba, Brazil; flavia.mayer@academico.ufpb.br

\* Corresponding author: flavia.mayer@academico.ufpb.br

## Abstract

This study investigates how people with congenital blindness configure cognitive scenarios involving colors. We use Cognitive Linguistics as a theoretical basis to approach human creative capacity to build these mental scenarios and embody experiences. An experiment was carried out with congenitally blind participants on a mediated visit to a museum gallery. From the data collected, it was possible to verify a robust occurrence of metaphorical and synesthetic constructions in the participants' experience of color, confirming the study hypothesis.

**Keywords:** *Visual impairment, Color, Inner Vision, Meaning Processes*

## INTRODUCTION

The present study starts from a concern raised in the audio description production process. More specifically, it was possible to see the struggles audio describers face in referencing colors in their scripts and the resistance of people with visual impairment to approach the issue. In Brazil, which has an expressive prejudice and stigma on these individuals, the social representation for them is based on the notion of “absence” (of the eye vision) and “inability” (to deal with visual information) – affecting the perception on their abilities. Nevertheless, human beings have an immense creative capacity, which makes us unique. We can (re)create the means of self-organization in our bio-social-cultural environment through the way we perceive and categorize the world, through language and our imagination. Furthermore, we (co)create “our world” in the interaction with other beings, changing our thought patterns, solving problems throughout our social interactions. In this way, this research seeks to understand the operations and dynamics involved in our process of “conceptualizing” (creating cognitive scenarios that involve) colors.

## THEORETICAL APPROACH AND HYPOTHESIS

From a Cognitive Linguistics perspective, the human being does not “represent” meaning in language (Fauconnier 1997). Instead, we perform signification operations in specific contexts based on certain cultural models and cognitive resources. This way of framing cognition is highlighted by Shapiro (2011) in two aspects: first, that cognition depends on the types of experience arising from a body with several sensorimotor capabilities. Second, that these sensorimotor abilities are related to a broader perspective, which includes the psychological and cultural contexts. Edelman (2004: 156) goes further and adds the interaction between mind, body, and environment. From this perspective, a landscape with a human being is no longer just a landscape: it is also the egocentric construction of a human being, who interacts with a landscape establishing a viewpoint from its creative capacity.

Sweetser (2010) proposes that we not only structure our meaning processes from our viewpoint perspective, but we are also able to project and access multiple viewpoints. As Sweetser highlights, in the presence of other human beings, we are, in fact, incapable of maintaining a single viewpoint about space or a particular issue. In this sense, the construction of meaning is creatively intersubjective, instantiated in a process in which subjects use their previous experiences and social, psychological, and cultural motivations. Regarding the outline of this research, as color meanings are negotiated in social interactions, for the congenitally blind, it has a more determinant role, as they do not have a visual experience of color.

Based on the discussions of Shapiro and Edelman regarding cognition, even if the congenitally blind do not have visual representations of color, they experience this concept in an embodied way. In this sense, we hypothesize that these concepts are creatively embodied in metaphorization operations involving synesthetic experiences.

In synesthetic metaphors, the concept of a base domain and a target domain are perceptual concepts (Petersen et al. 2008: 2) — such as “velvety red” — configured with the projection of a tactile over a visual concept. Some authors (Mills et al. 1999; Whollen 1983), however, point out that not all forms of synesthesia cover the sensitive experience of distinct sensory modalities, as some forms of synesthetic operations involve conceptual activators (Alford 1918; Calkins 1895; Guilford 1926). In this perspective, the experience/construction of concepts is projected in terms of sensory experiences, leading to what the authors call synesthetic conceptions. The operations of synesthetic metaphors can also have as input the activation of a conceptual construct. In this framework, a sense of awareness attributed to a particular sensory experience is projected to another domain, containing elements of another perceptual modality. In the meaning process, these domains are integrated by the subject, from which a new (metaphorical) relationship emerges, a new meaning. It does not mean that congenitally blind experience the sun's heat, for example, to approach yellow. They experience something else: metaphorically, yellow is not *like* the sun's heat — in a synesthetic metaphorical projection, yellow *is* the sun's heat. Emerging in the natural and daily semiosis of our meaning processes, synesthetic conception metaphors are based on our capacity to build mental scenarios — in which is possible to project and manipulate whatever we think.

## **METHODOLOGY**

Approaching the investigation in a phenomenological perspective, the present study carried out an experiment at the Instituto Inhotim, a contemporary art museum located in Brumadinho (Brazil). In the experiment, congenitally blind participants visited and interacted with artwork in which color was inevitable in their meaning process. The interactions were mediated mainly by the Museum Education team and by audio describers trained for this research, who made the museum experience accessible for the experiment participants. This format aimed to provide a more natural visitation to Inhotim, as the Museum Education team is prepared to carry out such mediations with different groups. In this sense, the only recommendation made to the Museum Education team was to talk about colors as they usually do during mediated tours.

Four participants joined the research, one woman and three men, aged between 21 and 29 years. All of them had completely lost their sight before 12 months of age and had no other type of disability. In addition, they were residents of the metropolitan area of Belo Horizonte (Brazil). All of them were attending university in the period in which the experiment was held. The experiment was audio-recorded with the consent of the Ethics Committee both of Inhotim Museum and of the Pontifícia Universidade Católica de Minas Gerais, as well as the congenitally blind participants (by signing the consent form). The recorded interactions were transcribed, and the relevant interaction moments were and analyzed.

## **EXPERIMENT AND DISCUSSION**

The focus of the experiment was the visit to the installation *Desvio para o Vermelho: Impregnação, Entorno, Desvio*<sup>1</sup>, by the artist Cildo Meireles. Such emphasis was due to the crucial role the red has in

---

<sup>1</sup> In English, Detour to the Red: impregnation, Surrounding, deviation.

the meaning process of this artwork. The installation comprises three environments. In *Impregnação*, its interpretation implies the agency of a wide range of information about red, as the color “impregnates” furniture, objects, and artworks. The second environment, *Entorno*, is formed by a corridor with a black floor, with a small bottle lying on it, through which runs a high relief representation of a red puddle. Following the corridor, we reach *Desvio*, where a single illumination lights a white sink, whose faucet is pouring red liquid.



Figure 1: DESVIOS PARA O VERMELHO: IMPREGNAÇÃO, ENTORNO, DESVIO. Source: website Instituto Inhotim, Blog Aqui Vai Uma Dica and Blog RVB.

At the beginning of the experiment, in *Impregnação*, Participant 4 had the following statement:

Participant 4: We know that red colors mark the symbols of anti-militarism revolutions. Scythe and red colors. Does this have anything to do with the theme of the room? Because of this “red fight”.

From a referential viewpoint, Participant 4's constructions take place from a metaphorical perspective: red is anti-militarism revolution, red is fight. These constructions can also be considered metonymic, insofar as leftist political movements use red to represent themselves, mainly in Communism (“Scythe and red colors”). Still in *Impregnação*, there was the following dialogue between Audio describer A and Participant 3.

Audio describer A: The books on the shelves are red, the fan, the telephone, the chandelier, the bird's cage.

Participant 3: Holly cow! (laughs) (...)

Audio describer A: Why did you say “holly cow”? (...)

Participant 3: Because, amazingly, everything is red. (...) The Museum Educator explained why, but it would be weird to be in a place with just one color.

At first glance, this strangeness regarding an environment where “everything is red” seems unexpected for those who have never seen colors. From the perspective of the human creative capacity, such emergence shows a natural reaction. In Participant 3's meaning process, red appears as an essential element for his environment construction, or better said, an aesthetic category on space organization. In his meaning process of the artwork, the massive presence of red emerges as something aesthetically unusual within his repertoire — “Because it is amazing that everything is red”, “it would be weird to be in a place with just one color”.

Moving on to *Entorno* environment, participants were able to touch the small bottle on the floor and the synthetic material representing a red puddle. After that, they went to *Desvio*.



Participant 4: To me, this represents death. It starts with a small bottle and gets bigger and bigger until it portrays the death of a population. (...) You start bleeding little by little in those situations that oppress a particular society. It is a wound, another wound, another wound to the point where you managed to kill society. That is why here [*Desvio*] is dark and black. Usually, black represents death. (...) They are shedding blood. It started by shedding a little blood, and now... (...)

Museum Educator: Even if it is a super dark place, there is a little light above the white sink, stained red.

Participant 4: It is the light at the end of the tunnel. That is, people are dying, shedding blood trying to change the social situation. It is the last light.

In this dialogue, it is possible to see how the interaction process involving the interpretation of colors is complex and presupposes many possible integrations. In the meaning process of Participant 4 – who in *Impregnação* constructed the idea of red linked to the struggles of leftist movements and anti-militarism – in *Desvio* he associates the red liquid in the sink and in the bottle with blood, wounds, and “situations that oppress a certain society”. In this construction, the sink and the bottle become society itself, which bleeds through the dark environment that represents death in Participant 4's meaning process. When informed about the light that illuminates the sink, Participant 4 seems to recursively return to the notion of leftist protest and struggles and points to it as the “last light at the end of the tunnel” – that is, the social movements which are “trying to change the social situation” of oppression. This statement shows how rich and creative Participant 4's meaning process is, as he uses his own experiences and background to signify the work of Cildo Meireles. When asked about what it's like to be in a red-colored environment, Participant 4 answers:

Participant 4: We get the symbolism. We do not have this notion of color, but with the audio description, we end up understanding the moment. (...) and seek to understand what that color reflects. Colors have different heat — warmth in the subjective sense, of different values and expressions.

Participant 4 performs a metaphorization operation involving a synesthetic conception by explaining his relationship with colors: he integrates his concept of color with another type of sensory experience he experiences: heat. Although he knows that color is not heated, he approximates those experiences in terms of categorization/discrimination/valuation operations — that is, he carries out a process of metaphorization by synesthetic conception.

Participant 2 highlights two different types of red constructions in *Impregnação* and *Desvios*:

Participant 2: (...) for me, it is not just the red that moved us. It was the red with its content together. (...) for example, the cozy content of a home in the living room. Now, the red in the sink, dripping there, brought anguish, a desire to leave the environment. So, it is not the red alone that implied one emotion and the other. It is red with a set of things.

The explicit mention of the context relevance in the artwork experience shows a difference in the emergence of meaning processes involving red in each environment. In *Impregnação*, Red is predicated by Participant 2 as harmonic and cozy, while in *Desvio*, it is confusing and distressing. As

well discussed by Brandt and Brandt (2005) and Brandt (2004), the interactional context has central relevance in the meaning process of the participants. From the interactional context and the participant's repertoire, frames of relevance are activated, calibrating his meaning processes. If “it is not just the red that moved us. It is red with its content together”, we have that this set is formed by the interactional context, by the elements activated in the participants' repertoire, and by the interactions he performed during the visitation. In *Impregnação*, Participant's 2 environment construction presupposes the interpretation of red, taking place from the touch and audio description of objects and furniture typically found in a house. In his meaning process, these objects seem to be calibrated based on affectionate relationships. Thus, in *Impregnação*, Participant 2 metaphorically constructs red in terms of coziness and harmony.

In *Desvio*, however, the “red content” is described by Participant 2 as different from the “red content” in *Impregnação*, in an explicit mention of changing contexts. If in *Impregnação* the red is instantiated in a house, in *Desvio*, it “spurts” incessantly through the faucet. Furthermore, it is integrated with the echo in the environment and the description of the darkness around the sink. Thus, red metaphorically emerges as distress and anguish.

### **FINAL CONSIDERATIONS**

Although congenital blindness imposes restrictions on visual interactions, it was possible to observe in the data analyzed the occurrence of different and complex processes of meaning involving color. As human experience is embodied, the congenitally blind's color experiences are based on a “feeling of awareness” about color, projected metaphorically in another sensitive experience. In this sense, the data collected highlights the creative potential of our species in our meaning processes, confirming the hypothesis that people with congenital blindness build cognitive scenarios involving colors through synesthetic metaphorical conception. In other words, if the inputs of our five senses are symbolized by us in experience and culture, in the impossibility of using one or more of our senses, that perceptually absent experience (such as eye vision, in the case of the congenital blind), continues to be (re)signified in the interaction/language and is embodied by us.

### **REFERENCES**

- Alford, L. B. 1918. A report on two cases of synesthesia. *Journal of abnormal psychology* 1313: 1-11.
- Brandt, P. 2004. *Spaces, domains, and meaning. Essays in cognitive semiotics*. Bern: Peter Lang Verlag. European Semiotics Series, 4.
- Brandt, L., and P. Brandt. 2005. Making sense of a blend: A cognitive-semiotic approach to metaphor. In: *Annual Review of Cognitive Linguistics* 3(1): 216-249.
- Calkins, M. W. Synaesthesia. 1895. *American Journal of Psychology* 7, 90:107.
- Edelman, G. M. 2004. *Wider Than the Sky: The Phenomenal Gift of Consciousness*. New Haven, Yale: Yale University Press.
- Fauconnier, G. 1997. *Mappings in thought and language*. Cambridge: Cambridge University Press.
- Ferreira, A. 2011. *Desvio para o vermelho*. Online: <<http://www.aquivaiumadica.com/2011/05/desvio-para-o-vermelho.html>>.
- Guilford, J. P. 1926. Spatial symbols in the apprehension of time. *The American Journal of Psychology* 37: 420-423.
- Instituto Inhotim. Online <<http://www.inhotim.org.br>>.
- Mills, C., E. Boteler, and G. Oliver. 1999. *Digit synaesthesia: a case study using a Stroop- type test. Cognit. Neuropsychol* 181-191.

- Petersen, W., H. B. Fleischhauer, and P. Bücken. 2008. *A frame-based analysis of synaesthetic metaphors*. In: The Baltic International Yearbook of Cognition, Logic and Communication. v. 3, A figure of speech. Kansas: Kansas State University, 1-22. Online: <<http://newprairiepress.org/biyclc/vol3/iss1/>>.
- Rvb Malhas. *A crítica social de Cildo Meireles*. Online: <<http://www.rvbmilhas.com.br/blog/a-critica-social-de-cildo-meireles/>>.
- Shapiro, L. 2011. *Embodied Cognition*. New York: Routledge.
- Sweetser, E. 2012. *Introduction: viewpoint and perspective in language and gesture, from the Ground down*. In: DANCYGIER, B.; SWEETSER, E. (Eds.). *Viewpoint in language: a multimodal perspective*. Cambridge: Cambridge University Press.
- Wollen, K. A., and F. Ruggiero. 1983. *Colored-letter synesthesia*. *Journal of Mental Imagery* 7: 83-86.

# Colorimetric analysis of eye fundus structures with multispectral retinography

Francisco J. Burgos-Fernández <sup>1,\*</sup>, Tommaso Alterini <sup>1</sup>, Fernando Díaz-Doutón <sup>1</sup> and Meritxell Vilaseca <sup>1</sup>

<sup>1</sup> Centre for Sensors, Instruments and Systems Development, Universitat Politècnica de Catalunya, Rambla Sant Nebridi 10, 08222 Terrassa, Spain; francisco.javier.burgos@upc.edu, tommaso.alterini@upc.edu, fernando.diaz-douton@upc.edu, meritxell.vilaseca@upc.edu

\* Corresponding author: francisco.javier.burgos@upc.edu

## Abstract

The analysis of the eye fundus is critical to prevent retinal and choroidal diseases since most of them cause no symptoms at early stages. Treating them when the very first signs appear is crucial to avoid vision losses. To this end, the color of eye fundus structures of healthy and diseased patients was assessed from images acquired with a novel multispectral fundus camera (400 nm – 1300 nm) with high spectral and spatial resolution. Characteristic color traits were found: in healthy eyes, large CIEDE2000 color differences were reported between arteries and veins due to different blood oxygenation; the contrast of nerve fibers/fovea was enhanced, giving rise to relevant color differences; in eyes with age related macular degeneration, lesions such as drusen could be better distinguished than with traditional color retinography; alterations of the optic disk in patients with glaucoma were also assessed, showing remarkable CIEDE2000 values when compared to healthy patients.

**Keywords:** *eye fundus, colorimetric analysis, multispectral imaging, spectral reflectance.*

## INTRODUCTION

Retinography is one of the most frequently used techniques to evaluate the eye fundus when the presence of an alteration is suspected since it provides fast and comprehensive color information of retinal structures in a wide field of view. Depending on the pathology, different structures and substances are present and it is important for them to be clearly visualized, especially at early stages, to make a proper diagnosis. Some of the most frequent diseases affecting the eye fundus are age related macular degeneration (ARMD) and glaucoma.

ARMD often causes central vision loss (Coleman et al. 2008); a high concentration of lipofuscin, a yellow-brown lipid residual from phagocytosis of photoreceptors, may contribute to this. Lipofuscin leads to soft drusen, which can vary from pale white to bright yellow, have no defined boundaries and can be larger than 1000  $\mu\text{m}$ ; they are the first clinical sign of ARMD and are associated to a higher risk of vision loss. On the other hand, hard drusen have sharper edges than soft drusen, are smaller and less likely to progress to a greater atrophy (Abdelsalam et al. 1999). Glaucoma is a pathology associated with high intraocular pressure. It mainly affects the retinal nerve fiber layer (NFL) and can be diagnosed by observing the optic disk from fundus and/or optical coherence tomography images (Yanoff and Sassani 2015). As found in the literature, the degeneration of the NFL causes reflectance and color changes at the center and periphery of the optic disk that can be used for the early detection of this pathology (Huang et al. 2012).

The accurate spectral and colorimetric characterization of healthy fundus structures is also crucial when looking for possible alterations. The NFL is especially visible at short-intermediate visible wavelengths while the optic disc is clearly observable up to 1000 nm, mainly due to the myelin covering the nerve fibers (Yanoff and Sassani 2015). Retinal vessels are seen brighter for long visible wavelengths (>580nm) since they absorb the shorter ones and can be easily discriminated up to 800 nm because veins (deoxygenated blood) present higher light absorption than arteries (oxygenated

blood) in this range (Berendschot et al. 2003). Macular pigment acts as a blue filter with a maximum absorption at 460 nm, while those structures containing melanin - retinal pigmented epithelium (RPE) and choroid - also absorb intermediate visible wavelengths up to 600 nm (Bone et al. 2003).

All these spectral and colorimetric features of diseased and healthy fundus structures may go unnoticed by traditional fundus cameras since they show limitations related to metamerism caused by their intrinsic colorimetric nature, as they use RGB cameras with only three broadband channels in the visible range. Multispectral imaging offers a compromise solution between spectroscopic systems and RGB imaging, joining the strengths of these two approaches: the spectral sampling and the pixel-wise evaluation. In this context, the goal of this work is to study the colorimetric and spectral features of diseased and healthy eye fundus structures by means of a fast visible and infrared multispectral fundus camera (400 nm – 1300 nm) with high spectral and spatial resolution (Alterini et al. 2019).

## **MATERIALS AND METHODS**

### **Subjects**

This study was conducted on diseased and healthy subjects at the Institute of Ocular Microsurgery (Barcelona, Spain) and at the University Vision Center of the Universitat Politècnica de Catalunya (Terrassa, Spain). Table 1 provides some demographic data of the diseased and healthy patients. The inclusion criteria for the diseased patients were presenting any eye fundus pathology such as ARMD and glaucoma. Exclusion criteria were the diagnosis of any other ocular or systemic disease affecting the eye different from the previous ones, especially those that notably alter the transparency of the ocular media such as mature cataracts. Inclusion criteria for healthy patients were stricter: best-corrected visual acuity equal to or higher than 0.9 in decimal units, intraocular pressure equal to or lower than 21 mmHg, and no history of any ocular pathology or trauma. Additionally, all patients presented a subjective spherical refraction comprised between  $\pm 15D$  and astigmatism  $\leq 2D$  due to the operating range of the prototype. Ethical committee approval was obtained and all patients provided written informed consent before any examination. The Declaration of Helsinki tenets of 1975 (as revised in Tokyo in 2004) were followed throughout the study.

<b>Condition</b>	<b>Eyes</b>	<b>Patients</b>	<b>Females (%)</b>	<b>Males (%)</b>	<b>Age (mean <math>\pm</math> SD [range]; years)</b>
Diseased	194	97	61.3	38.7	64.2 $\pm$ 17.1 [19, 95]
Healthy	126	81	54.4	45.6	47.9 $\pm$ 17.4 [19, 81]

Table 1: Number of eyes, patients, gender distribution and age for the diseased and healthy patients (SD = standard deviation).

### **Multispectral fundus camera**

The multispectral fundus camera prototype consists of two detection arms, one from the visible to the near infrared (VIS-NIR: 400 - 950 nm) and another for the NIR range (960 - 1300 nm) (Alterini et al. 2019). Three light emitting diode rings integrate the illumination system, covering 15 spectral bands with peak wavelengths of 416 nm, 450 nm, 471 nm, 494 nm, 524 nm, 595 nm, 598 nm, 624 nm, 660 nm, 732 nm, 865 nm, 955 nm, 1025 nm, 1096 nm, and 1213 nm. The system is non-mydratiac (no need for pupil dilation) with 30-degree angular field of view. As mentioned before, the prototype has a spherical compensation range of  $\pm 15D$ . Despite the large spectral range covered, the acquisition of

the 15 images, one for each spectral band, only lasts 613 ms (220 ms for the VIS-NIR spectral bands and 393 ms for the NIR ones). Although it is above the acquisition time of traditional fundus cameras ( $\approx 250$  ms), Carl Zeiss Meditec AG (2021) and Institute of Ocular Microsurgery (2021), which only takes one color image, it can be considered a fast acquisition, thus avoiding imaging problems caused by eye movements and blinking, while causing similar inconvenience to the patient as in traditional retinography.

### **Image processing and colorimetric analysis**

Firstly, raw images were preprocessed to remove reflections and non-uniformities caused by the optics and the illumination source of the system. Afterwards, spectral reflectance values were retrieved from multispectral images when dividing them by a calibrated reference white (BN-R98-SQC, Gigahertz-Optik GmbH, Germany). CIELAB parameters were then computed using D65 illuminant for diseased and healthy eyes. Since the transmittance of the ocular media preceding the retina might slightly differ from one subject to another, CIEDE2000 color differences were computed between different fundus structures within each eye. This is a similar approach to that used by ophthalmologists, as they identify eye fundus structures for the chromatic and luminous differences with respect to the general appearance of the eye fundus.

## **RESULTS AND DISCUSSION**

Beyond the study of chromatic coordinates, the high spectral sampling obtained with the multispectral fundus camera offered great discrimination among fundus structures, highlighting details that may remain hidden using traditional color fundus cameras.

Mean  $\pm$  SD CIEDE2000 color differences between fundus structures were computed for all healthy patients evaluated. The different absorption properties of arteries and veins due to oxy- and deoxyhemoglobin were translated into  $6.0 \pm 3.0$  CIEDE2000 units; the difference in absorption between both structures caused by different oxygen concentration in blood was especially noticeable around 600 nm (Figure 1 left). Nerve fibers are hardly observable in traditional RGB retinographies but using the multispectral prototype they are linked to  $6.6 \pm 4.6$  CIEDE2000 units with respect to the fundus. Figure 1 center displays how the NFL is highlighted at short visible wavelengths as they are very superficial and short wavelengths are reflected superficially whereas longer ones penetrate deeper into the retinal tissue. Likewise, the fovea has no defined boundaries in color fundus images but, taking advantage of its blue filter behavior, the spectral evaluation performed with the multispectral camera led to  $6.2 \pm 3.9$  CIEDE2000 units when compared to the fundus; this phenomenon was also observed at short visible wavelengths (Figure 1 right).

Some representative cases for specific diseases and structures are reported next: CIEDE2000 values of 3.5 units were obtained between hard and soft drusen for a patient with exudative ARMD (Figure 2 left). This color difference was mainly caused by the higher  $L^*$  of hard drusen, which could be attributed to a decrease in melanin absorption since they are usually associated to cell loss in the RPE. In another eye, a degeneration of the RPE caused by a dry ARMD reported a CIEDE2000 value of 4.9 units when compared to the eye fundus (i.e., without structures). As shown in Figure 2 center, the most remarkable finding in this case was that the lesion could not be detected in the RGB image acquired with a traditional fundus camera due to metamerism, which proves the importance of the spectral sampling on the detection of subtle lesions and for the early diagnosis of retinal diseases.

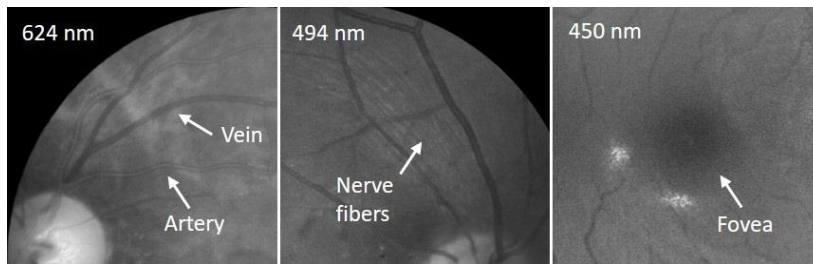

Figure 1: Zoomed spectral images at different wavelengths from healthy patients. Left: arteries and veins are clearly differentiable at 624 nm, being brighter the formers. Center: nerve fibers are highlighted at short visible wavelengths. Right: fovea appears darker at short visible wavelengths, being more distinguishable from the fundus.

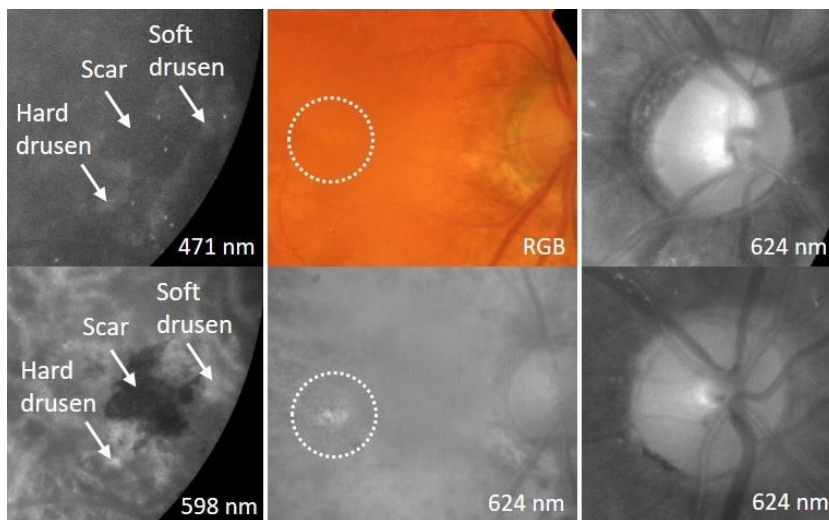

Figure 2: Zoomed spectral images at different wavelengths for eyes affected by exudative (left) and dry ARMD (center), glaucoma (right-top) and a healthy eye (right-bottom). Left: lesions are more distinguishable at longer visible wavelengths. Center: a subtle lesion is detected by the developed multispectral fundus camera while unnoticed when using traditional RGB retinography. Right: It can be observed how the reflectance is higher for the central part of the optic disc in the glaucomatous eye (top) than in the healthy one (bottom), also covering a larger area in the former.

An eye fundus affected by glaucoma was colorimetrically analyzed by comparing the center and periphery of the optic disk. A CIEDE2000 color difference of 13.9 units was found, being well above the mean CIEDE2000 values for healthy patients ( $9.5 \pm 3.4$  units). As it is summarized in Table 2, the higher color difference for the glaucomatous eye was mainly attributable to an increase of luminance in the central part of the optic disk (Figure 2 right-top). One hypothesis of this behavior may be that, as glaucoma causes a degeneration of optic disk layers, the lamina cribrosa and the myelinated fibers exiting the eye ball are more exposed taking to a higher reflectivity. Additionally, the eye with glaucoma presented a purer yellow appearance since  $a^*$  was very close to 0, which corresponds to what has been found by other authors (Huang et al. 2012), who reported flatter spectra with a reduced contribution of short visible wavelengths in eyes suffering this disease.

Condition	Optic disk zone	L*	a*	b*	CIEDE2000
Glaucomatous eye	Periphery	76.0	3.5	5.2	13.9
	Center	91.6	0.5	16.3	
Healthy eyes	Periphery	72.6 ± 5.7	9.7 ± 7.3	12.0 ± 8.1	9.5 ± 3.4
	Center	83.6 ± 5.4	12.1 ± 6.9	17.9 ± 8.7	

Table 2: CIELab color coordinates and CIEDE2000 color differences for the center and periphery of the optic disk in the glaucomatous eye and in the healthy dataset.

## CONCLUSIONS

The colorimetric and spectral analysis based on the images acquired by the multispectral fundus camera offers precise information and quantitative metrics than can improve the discrimination between healthy and diseased structures. The colorimetric data retrieved from the spectrally sampled reflectance curves allows a better differentiation between arteries and veins due to different blood oxygenation. The proposed evaluation might also contribute to a better detection of structures that are commonly difficult to see using color fundus images, such as the NFL and the fovea. When applied to fundus pathologies such as ARMD and glaucoma, diseased structures can be precisely located, even lesions that may remain hidden in traditional retinography. Future work will focus on increasing the dataset of diseased eyes.

## ACKNOWLEDGEMENTS

This project has received funding from the European Union's Horizon 2020 research and innovation programme under Marie Skłodowska-Curie grant agreement No. 801342 (Tecniospring INDUSTRY) and the Government of Catalonia's Agency for Business Competitiveness (ACCIÓ). This research was also supported by the Ministerio de Economía, Industria y Competitividad (MINECO), the Agencia Estatal de Investigación (AEI) and the European Regional Development Fund (FEDER) under the grant DPI2017-89414-R.

## DISCLAIMER

This work only expresses the opinion of the authors and neither the European Union nor ACCIÓ are liable for the use made of the information provided.

## REFERENCES

- Abdelsalam, A., L. Del Priore, and M. A. Zarbin. 1999. Drusen in age-related macular degeneration: pathogenesis, natural course, and laser photocoagulation-induced regression. *Survey of Ophthalmology* 44(1): 1–29.
- Alterini, T., F. Díaz-Doutón, F. J. Burgos-Fernández, L. González, C. Mateo, and M. Vilaseca. 2019. Fast visible and extended near-infrared multispectral fundus camera. *Journal of Biomedical Optics* 24(9): 096007-1–096007-7.
- Berendschot, T. J. M., P. J. DeLintb, and D. V Norren. 2003. Fundus reflectance—historical and present ideas. *Progress in Retinal and Eye Research* 22(2): 171–200.



- Bone, R. A., J. T. Landrum, L. H. Guerra, and C. A. Ruiz. 2003. Lutein and Zeaxanthin Dietary Supplements Raise Macular Pigment Density and Serum Concentrations of these Carotenoids in Humans. *The Journal of Nutrition* 133(4): 992–998.
- Carl Zeiss Meditec AG (Jena, Germany). Accessed June 16, 2021. ZEISS CLARUS 500. <https://www.zeiss.com/meditec/int/product-portfolio/retinal-cameras/clarus-500.html#specifications>
- Coleman, H. R., C.-C. Chan, F. L. 3rd Ferris, and E. Y. Chew. 2008. Age-related macular degeneration. *Lancet* 372(9652): 1835–1845.
- Huang, X. R., Y. Zhou, R. W. Knighton, W. Kong, and W. J. Feuer. 2012. Wavelength-dependent change of retinal nerve fiber layer reflectance in glaucomatous retinas. *Investigative Ophthalmology & Visual Science* 53(9): 5869–5876.
- Institute of Ocular Microsurgery (Barcelona, Spain). Accessed June 16, 2021. Retinography. <https://www.imo.es/en/pruebas-diagnosticas/retinography>
- Yanoff, M., and J. W. Sassani. 2015. *Optic Nerve* in Ocular Pathology (7th ed.). London: W.B. Saunders.

1 COLOR AND MEASUREMENT INSTRUMENTATION	2 COLOR AND DIGITAL	3 COLOR AND LIGHTING	4 COLOR AND PHYSIOLOGY
<b>5 COLOR AND PSYCHOLOGY</b>	6 COLOR AND PRODUCTION	7 COLOR AND RESTORATION	8 COLOR AND BUILT ENVIRONMENT
9 COLOR AND DESIGN	10 COLOR AND CULTURE	11 COLOR AND EDUCATION	12 COLOR AND COMMUNICATION MARKETING

## 5 COLOR AND PSYCHOLOGY

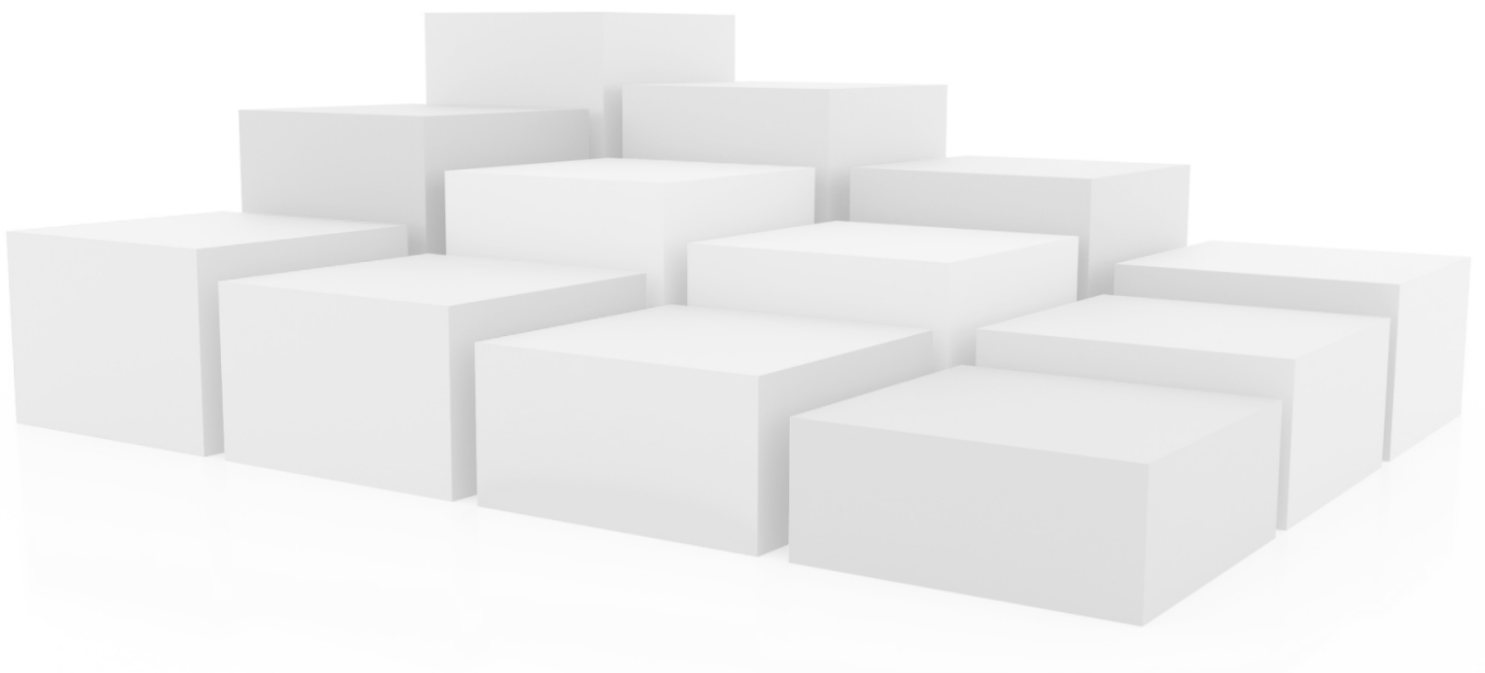

AIC 14<sup>th</sup> Congress Milano 2021 - August 30<sup>th</sup>– September 3<sup>rd</sup> 2021



# What color is your mood? The association between moods and colors

Mahshid Baniani <sup>1,\*</sup>

1 University of Tsukuba; mahshid@geijutsu.tsukuba.ac.jp

\* Corresponding author: 1 mahshid@geijutsu.tsukuba.ac.jp.

## Abstract

The purpose of this study was to identify how people associate their mood with color. Like other studies, angry was associated with red. However, although in other studies happy is associated with yellow and sad with blue, in this study female participants associated happy with light pink and sad with dull purple. In addition, the clear influence of culture on color was observed. For example, light pink was associated with Sakura (cherry blossoms), saturated pink with Ume flowers, and light orange with Kyoto. In sum, it was observed that the associations between colors and current moods in parts resembled other color-emotion association studies.

**Keywords:** *Color, moods, emotions, preferences*

## INTRODUCTION

The majority of research studies in the color psychology field are focused on how color conceptually related to emotions and less is known whether the same color affects associations hold when color is matched to current moods (Jonaskaite et al. 2019). The purpose of this study is to identify how people associate their mood with color.

## METHODOLOGY

### Participants

331 (F=197, M=134) Japanese university students participated in the study. They were between 20 and 30 years old with the mean age of 24.2.

### Procedure

To reach the purpose of this study, a questionnaire and a color sample consisted of 32 colors were prepared. The color sample consisted of yellow, orange, red, pink, purple, blue, and green in saturated, light, dark, and dull variations. Aside from these colors, there were white, black, light gray, and dark gray. Munsell notations of these color can be seen in Table 1.

The experiment was conducted in Japanese in the following order:

First the participants were asked about their mood. They were given a list of moods (tired, happy, sad, stressed, bored, calm, excited, energetic, feeling creative, nervous, feeling loved, focused, angry, relaxed, worried, frustrated, lonely, sleepy) where they could choose from. They were free to write any other emotion in case their mood was not listed.

Next, they had to associate their mood with one of the colors from the color sample.

After associating their mood with a color, they were asked to look at the chosen color and write down the first word that comes to their mind. They were further asked to associate the color with an adjective from a list of 32 (16 positive and 16 negative) adjectives. They were also free to write any other adjectives they wanted.

Finally, they were asked to choose their most and least favorite color from the color sample.

Color name	Hue	Value	Chroma	Color name	Hue	Value	Chroma
Yellow (sat)	5Y	8.5	12	Purple (sat)	5P	5	12
Yellow (light)	5Y	9	6.5	Purple (light)	5P	7	7
Yellow (dark)	5Y	7	6.5	Purple (dark)	5P	3	7
Yellow (dull)	5Y	5	6.5	Purple (dull)	5P	5	2
Orange (sat)	5YR	7	13	Blue (sat)	10B	6	11
Orange (light)	5YR	8	6	Blue (light)	10B	7.5	5.5
Orange (dark)	5YR	6	6	Blue (dark)	10B	5.5	5.5
Orange (dull)	5YR	3.5	6	Blue (dull)	10B	3.5	5.5
Red (sat)	5R	5	15	Green (sat)	2.5G	6	12
Red (light)	5R	7	8	Green (light)	2.5G	8	6
Red (dark)	5R	5	8	Green (dark)	2.5G	4	6
Red (dull)	5R	3	8	Green (dull)	2.5G	6	4
Pink (sat)	5PR	5	12	Gray (light)	N8.5	-	-
Pink (light)	5PR	8	6	Gray (dark)	N3.5	-	-
Pink (dark)	5PR	3	6	White	N10	-	-
Pink (dull)	5PR	5	4	Black	N2	-	-

Table 1: Color samples specified according to the Munsell system of color notation (Munsell, 1988).

## RESULTS

### Association between moods and colors

In this section, participants were asked about their moods. Then they had to associate their mood with one of the colors from the color sample. The results for negative moods are shown in Figure 1, while Figure 2 shows the results for positive moods. Negative moods are associated with dark and dull colors while positive moods are mainly associated with light and saturated colors ( $P < 0.05$ ).

Negative moods are associated with blue the most ( $P < 0.01$ ), followed by purple and gray. For example, tired, sleepy, and bored are associated with blue hues; sad with blue and gray among male participants, while female participants associate it with dull purple; and angry is associated with saturated red.

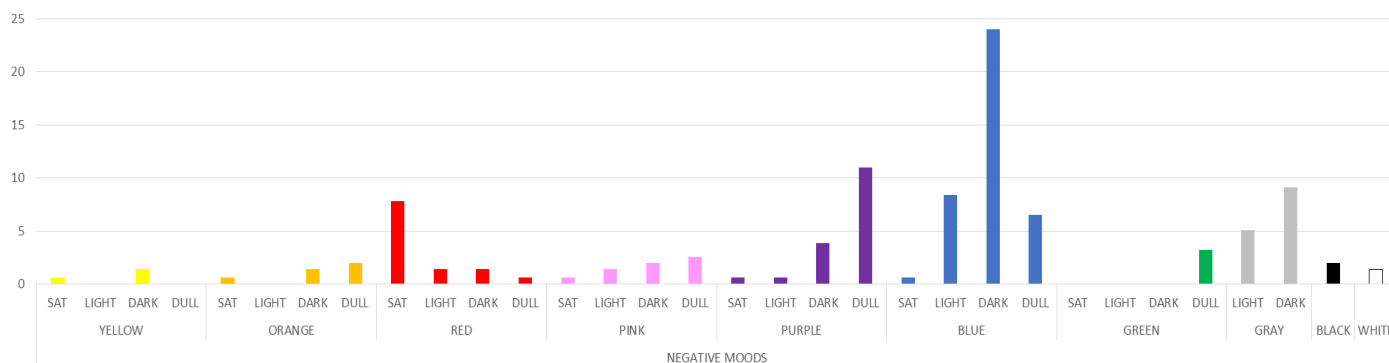

Figure 1: Association between negative moods and colors.

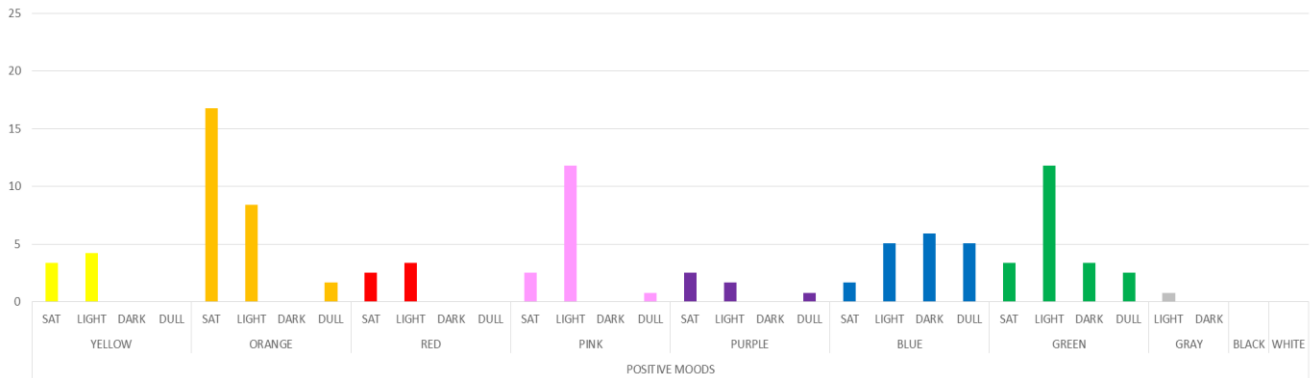

Figure 2: Association between positive moods and colors,

On the other hand, positive moods are associated with light and saturated colors. For example, focused is associated with saturated orange; relaxed is associated with light orange among female, and with light green among male participants; happy is associated with yellow among male participants, while female participants associate happy with light pink.

### Colors and word associations

After associating their mood with a color, the participants had to further associate the chosen color with an adjective from a list of adjectives. The association between color variations and adjectives can be seen in Table 2. As can be observed, saturated and light colors are mainly associated with positive adjectives such as pleasant, warm, and peaceful, while dark and dull colors are associated with negative adjectives such as depressing and cold.

Aside from associating the chosen color with an adjective, the participants were further required to write the first word that comes to their mind when looking at the color. Based on the replies from the participants, similar words were grouped into categories such as: man-made objects, plants, food, places, seasons, animals and others. Interestingly, more than half of the participants associate the colors with things related to or popular in Japan. For example, light pink is associated with Sakura (cherry blossoms), saturated pink with Ume flowers, light orange with Kyoto, and dull and dark pink with Azuki beans.

## What color is your mood? The associations between moods and colors

		Pleasant	Refreshing	Powerful	Beautiful	Impressive	Cheerful	Warm	Peaceful	Modern	Formal	Unique	Vivid	Bright	Soft	Comforting	Elegant
SATURATED (%)	F	15.5	5.7	9.6	3.9	5.7	3.8	9.7	1.9	1.9	0	3.8	9.7	11.6	1.9	1.9	1.9
	M	17.9	3.6	3.6	3.6	7.1	3.6	21.3	0	0	0	0	3.6	14.3	7.1	0	0
LIGHT (%)	F	1.8	12.9	0	4.3	0.6	5.6	6.2	14.2	0	0	0	0.6	2.5	14.8	4.9	3.1
	M	3.5	13.7	0	0	0	0	3.5	24.1	0	0	0	3.5	3.5	10.2	0	0
DARK (%)	F	0	0	0	1.6	2.4	0	0	2.4	0.8	0.8	0.8	0	0	0	0.8	4
	M	0	1.9	5.8	0	0	1.9	0	3.8	3.8	0	0	0	0	0	0	1.9
DULL (%)	F	0.9	0	0	0	0	1.8	0.9	11.1	0.9	0	0.9	0	0	4.6	0.9	0
	M	0	2.9	0	0	0	5.9	0	11.9	0	0	0	0	0	2.9	5.9	2.9
		Unpleasant	Boring	Weak	Ugly	Unimpressive	Depressing	Cold	Harsh	Oldfashioned	Casual	Ordinary	Dull	Dark	Hard	Disturbing	Unsophisticated
SATURATED (%)	F	0	0	0	0	0	0	1.9	5.7	0	0	0	0	0	0	3.9	0
	M	0	0	0	0	0	0		7.1	0	3.6	0	0	0	0	3.6	0
LIGHT (%)	F	0	3.9	0.6	0	4.3	4.3	6.8	0	1.2	1.2	0.6	2.5	0.6	0	1.9	0.6
	M	0	0	3.5	0	3.5	0	17.1	0	0	3.5	0	3.5	0	3.5	3.5	0
DARK (%)	F	4.8	7.1	0.8	1.6	1.6	15.1	8.7	0	3.2	0.8	1.6	11.9	15.7	0.8	11.9	0.8
	M	5.8	3.8	0	5.8	1.9	15.4	13.4	0	0	0	0	5.8	17.3	5.8	5.8	0
DULL (%)	F	6.5	6.5	0.9	0.9	5.5	17.7	4.7	0	6.5	0.9	2.8	15.9	1.8	0.9	6.5	0
	M	0	2.9	0	0	2.9	23.6	5.9	0	2.9	0	2.9	14.8	2.9	2.9	5.9	0

Table 2: Color variations and adjectives.

### Color preferences

Participants had to select their most and least favorite color from the color samples. These results can be seen in Figure 3.

From Figure 3, it is observed that light colors are preferred the most while dark and dull colors are preferred the least. Light green and light red are the most preferred colors. Their reason was that these colors are peaceful and calm. Moreover, nobody chose dark yellow, dull red, or dark gray as their favorite color. Additionally, it is only male participants who chose black as their favorite color.

Dark yellow and saturated green are the least favorite colors of the participants. Their reason for choosing these colors was “being unpleasant, disturbing, or too bright”.

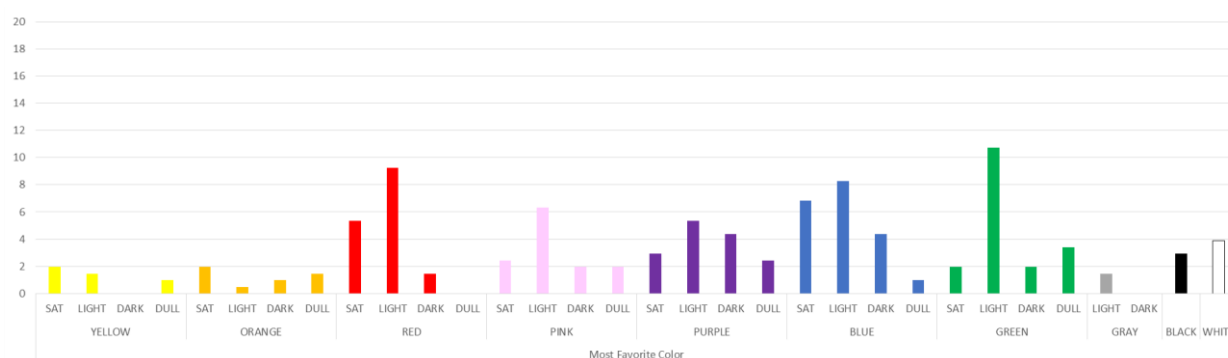
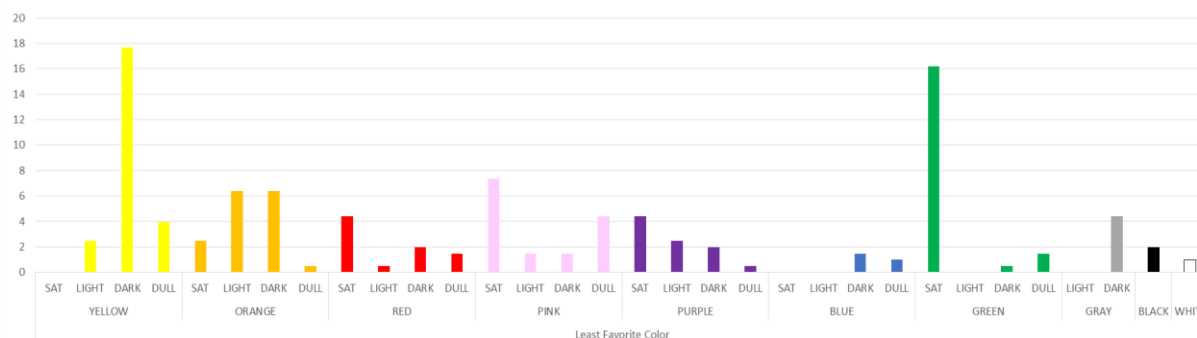

Figure 3: Most and least favorite colors.

## DISCUSSION AND CONCLUSIONS

The purpose of this study was to identify how people associate their mood with colors. Negative moods were associated with dark and dull colors, while positive moods were associated with light and saturated colors ( $P < 0.05$ ). It was further observed that light and saturated colors are associated with positive adjectives, while dark and dull colors are associated with negative adjectives.

Like other studies (e.g. Takahashi et al. 2018; Palmer et al. 2013; Karp et al. 1988; Zentner 2001), angry was associated with red. However, although in these studies happy is associated with yellow and sad with blue, in this study female participants associated happy with light pink and sad with dull purple.



Light colors were preferred the most while dark and dull colors were preferred the least, although dark blue was the most preferred color among the male participants. Dark blue was mainly associated with winter among female respondents while male participants associated it with sea and ocean. Saturated green and dark yellow were the least favorite colors. The participants chose these as their least favorite because they were either too unpleasant, disturbing, or too bright.

In addition, the clear influence of culture on color was observed in the color-word associations. For example, light pink was associated with Sakura (cherry blossoms), saturated pink with Ume flowers, light orange with Kyoto, dull and dark pink with Azuki beans, and saturated purple with Heian Aristocrats or Kimono. Therefore, it would be interesting to do this research among other nationalities and cultures as well.

In sum, the associations between colors and moods were observed and it was observed that the associations between colors and current moods in parts resembled other color-emotion association studies (e.g. anger).

## REFERENCES

- Jonauskaitė, D., B. Althaus, N. Dael, E. Dan-Glauser, and C. Mohr. 2019. What color do you feel? Color choices are driven by mood. *Color Research and Application* 44: 272-284.
- Karp, E.M., and H.P. Karp. 1988. Colour associations of male and female fourth-grade school children. *Journal of Psychology* 122: 383-388.
- Palmer, S.E., K.B. Schloss, Z. Xu, L.R. Prado-Leon. Music-color associations are mediated by emotion. In: *2013 Proceedings of the National Academics of Sciences* 110: 8836-8841.
- Takahashi, F., and Y. Kawabata. 2018. The association between colors and emotions for emotional words and facial expressions. *Color Research and Application* 43: 247-257.



What color is your mood? The associations between moods and colors

Zentner, M.R. 2001. Preferences for colours and colour-emotion combinations in early childhood.  
*Developmental Science* 4: 389-397.

# Why are common nature colors (soil, sand, trees, sky, stones, etc.) useful? Why does it go well with all colors?

JinYoung Kim <sup>1</sup>, JiYeon Lee <sup>2</sup> and YungKyung Park <sup>3,\*</sup>

<sup>1</sup> Ewha Womans University; jjiny1130@gmail.com

<sup>2</sup> Ewha Womans University; jy00771155@gmail.com

<sup>3</sup> Ewha Womans University; yungkyung.park@ewha.ac.kr

\* Corresponding author: yungkyung.park@ewha.ac.kr

## Abstract

Nature colors are being used consistently in all industrial fields, and are considered as trend colors every year. Then, why are nature colors so useful in all industries? In this study, we defined an unclear color that is not classified as a single color because it is not on the color wheel as a nature color, and tried to investigate the characteristics of the nature color that people generally perceive. The range of samples was specified through preliminary experiments, and 60 samples out of 228 samples were classified as nature colors through main experiment. It was found that nature colors are affected more by chroma rather than lightness, and it was found that green and blue were not recognized as nature colors when low saturation.

**Keywords:** *nature color, neutral color, color perception*

## INTRODUCTION

Could it be the impact of COVID-19? Colors that come from nature, which are not artificial and comfortable, will continue to be fashionable in 2021. From the moment we are born, we experience the natural and artificial environments at the same time. Nature is the background of the artificial environment and is the largest category of color experience. Whether consciously or unconsciously, it is to experience all the colors of nature that we see with our eyes before learning to write. Although these colors from nature are colorful, they are not flashy or stimulating like artificial colors, and they do not feel objectionable. Nature is the mother of all designs, and the colors of nature constantly create diversity and change through time and space, giving us a sense of beauty and giving us psychological comfort (Park and Lee, 1998). Nature color is not artificial and is often displayed as a tertiary color. A tertiary color is a color in which a single hue is not evident, but contains all possible color elements. A tertiary color is also called an achromatic neutral, but more accurately a colored neutral. Neutral colors are less saturated and are not on the color wheel, but beautiful tones often appear in nature and can have a soothing effect (Mollica et al. 2017). In this study, nature color is defined as a color that cannot be named with Munsell's basic color terms (red, yellow, green, blue, purple) and achromatic colors (black, gray, white), and an experiment to investigate the characteristics of such nature color proceeded.

Nature color is being used consistently in all industrial fields and is considered as a trend color every year. Following 2020, the trend of "Earthy color" and "Earthy tone" is expected to continue in 2021. "Earthy color" can be expressed as "natural colors" (colors found in nature) such as soil, sand, leaves, and sky, and more generally, which are muted and flat in an emulation of natural colors. Leatrice Eiseman (2006) says that people feel comfortable because the colors of neutral earth tones are reminiscent of nature. We can also see the use of natural colors in various fields such as fashion, interior design, and architecture. In fashion, there are basic colors that are often used regardless of fashion, and natural colors are used for basic colors in fashion. Natural colors used in fashion are low-lightness and low-chroma colors like beige, khaki, brown, and navy. Architects have also created a system of architectural colors that reflects the colors and textures of nature as well as shapes that are

Why are common nature colors (soil, sand, trees, sky, stones, etc.) useful? Why does it go well with all colors?

consistent with the natural order. Natural colors can be translated into honest colors, pure colors, and lasting colors. Natural color, the essence of everything, is an unprocessed color, and the colors of architecture have been trying to maintain natural colors from the past until now (Lee 2017). In addition, natural color is being used continuously in the interior space. A study of nearly 1000 workspaces in four countries found that room colors were significantly important to the psychological mood of those working in those spaces, with most environments using subdued or neutral colors (Küller et al. 2006). Then, why is this nature color so useful in all industrial fields? What are the characteristics of nature color? In this study, we intend to investigate the color characteristics of these nature colors.

We present samples of varying hue, value, and chroma in this study. All stimuli were presented at random, and the following evaluation will be performed. Subjects look at a single sample and determine if it can be named as Munsell's basic color terms or achromatic color. Identify the characteristics of colors that cannot be named as primary or achromatic colors.

## EXPERIMENTAL

The experiment was conducted as a preliminary experiment and a main experiment. We first took 80 samples (18 RP, 21 R, 14 Y, 11 GY, 11 G, 3 BG, 2 PB) from Munsell's nature color book (Soil color book and Munsell Rock color book) was selected and a preliminary experiment was conducted. Value was composed of 2.5~8, Chroma was composed of 1~3, and the CIE LAB measurement value of the sample is shown in Table 1. In the Munsell nature color book, BG and PB hues were less than other hue groups, so there was a limit to extracting evenly distributed hues. Also, since the overall chroma was limited, the experiment was conducted with various value.

Munsell Hue	L*	a*	b*	C*
R	25.10~80.6	3.90~15.20	1.92~10.50	5.04~16.00
YR	20.10~85.30	1.04~9.25	4.30~14.00	5.53~15.47
Y	25.10~80.80	-2.64~0.65	5.73~15.40	5.91~15.42
GY	25.40~80.50	-7.87~-3.86	2.70~13.30	5.09~15.45
G	25.40~80.60	-13.00~-4.79	1.28~5.20	5.10~14.00
BG	61.00~80.70	-5.06~-4.75	-1.67~-0.54	5.03~5.15
PB	25.30~30.50	0.27~0.70	-5.34~-5.32	5.33~5.39

Table 1: CIE LAB measurements of preliminary experimental samples.

Based on the results of the preliminary experiment, in main experiment, to examine the characteristics of nature colors in more detail, samples from the basic Munsell color chip were added to make the intervals between Hue, Value, and Chroma denser. Hue consists of 9 (R, YR, Y, GY, G, BG, B, PB, P), and values are selected from 2.5 to 8.5, because values below 2 and above 9 are too low or Due to the high value, there is a tendency to perceive as black or white, so it was excluded from the sample. The chroma was composed of 1 to 3, and as a result of the preliminary experiment, when chroma was 3, there was a tendency to use the basic color term to designate the color name, so chroma was not added greater than 3. A total of 228 samples selected based on these criteria (23 RP, 21 R, 24 YR, 19 Y, 27 GY, 21 G, 26 BG, 24 B, 23 PB, 20 P), and the CIELAB measurements of the samples are shown in Table 2.

Munsell Hue	L*	a*	b*	C*
R	13.21~82.80	4.97~17.27	1.57~8.01	5.64~18.22
YR	15.99~87.68	-3.67~13.17	4.15~21.12	5.68~21.43
Y	14.99~87.13	-5.34~6.66	5~26.76	5.01~27.04
GY	14.97~89.46	-16.47~7.82	5.2~22.67	8.17~25.74
G	12.76~80.66	-20.35~-5.47	2.21~10.60	6.33~22.22
BG	7.12~83.69	-20.07~-5.43	-3.29~7.22	5.50~20.54
B	13.23~79.13	-15.48~3.74	-6.14~2.18	1.49~15.74
PB	19.36~85.31	-6.06~7.39	-10.11~1.27	1.12~10.16
P	10.38~86.49	2.59~16.16	2.59~15.42	2.84~16.16
RP	16.23~80.03	4.41~16.05	-0.75~18.92	4.57~20.56

Table 2: CIE LAB measurements of main experimental sample.

The preliminary experiment subjects were 34 males and females in their 20s and 40s (average age 28), and they were people of various majors. The subjects of main experiment were 28 women in their 20s and 40s (average age 28) with normal color vision through a color vision test, and they were people of various majors. Data from 24 people excluding 4 who were not sincere in the questionnaire were used for the analysis of the results.

The experimental method of the preliminary experiment and main experiment was the same. After viewing a single sample, it was an experiment to determine whether the sample could be assigned a color name using the basic color term or achromatic colors. After providing the experimental sample, experiments were conducted to select one response from the option, and the composition of the option consisted of seven options: red, yellow, green, blue, purple, and achromatic (black, white), and not all. In main experiment, a total of 8 options were composed by adding gray to the achromatic options. All experimental stimuli were presented at random.

The preliminary test took 15 minutes. Preliminary experiments were conducted on-line surveys and required the brightness of the display to be adjusted to 100%. Preliminary experiments had limitations that the subjects proceeded with different displays, resulting in the size of the sample presented, light sources, and the quality of the display being uncontrolled. An error may appear in discriminating sensitive colors depending on the color gamut of the display, so main experiment was conducted after compensating for the limitations of the preliminary experiment, configuring the sample composition in various ways, and controlling the experimental environment to be the same. This experiment took about 20 minutes per person. The experiment was conducted sitting in front of a 16-inch display in an indoor space where constant illumination was maintained, and the distance from the display was 50cm.

## RESULTS AND DISCUSSION

The survey analysis method is as follows. Among the options, if the subjects who selected 'not all' exceeded 50% of the total number of subjects, they were classified as nature color. Choosing 'Not all' is because it can be said that color samples cannot be named basic color terms and achromatic color. In the preliminary experiment, the tendency of color characteristics perceived as nature colors was

Why are common nature colors (soil, sand, trees, sky, stones, etc.) useful? Why does it go well with all colors?

identified and the hue, value, and chroma of this experimental sample were specified. As a result of the preliminary experiment, 46 samples out of 80 samples were classified as nature colors, and their color characteristics are as follows. Hue was most recognized as nature color in the order of YR(22.5%), R(21%), and Y(13.75%), and it was difficult to classify it as nature color in the order of BG(1.92%), G(3.85%), and GY(5.77%). In the  $a^*-b^*$  graph, it can be seen that a lot of nature color is distributed toward  $+a^*$  and  $+b^*$ , and almost no nature color is distributed toward  $-a^*$  and  $-b^*$ . In addition, the values were distributed in various ways, but in the case of chroma, when Munsell chroma was 1 to 2, it was often recognized as a nature color, so main experimental sample was able to set the standard as not exceeding Munsell chroma 3.

Based on this, the sample of main experiment was reconfigured and the experimental environment was supplemented. The results of main experiment are as follows. Of the 228 samples, 60 samples were classified as nature colors, and the color characteristics of the samples were as follows. Hue had the most R(31.67%) and YR(31.67%), followed by RP(23.33%). Nature color was also derived from the P(8.33%), B(3.33%), and Y(1.67) color series, but it was significantly less than that of R, YR, and RP, and there was no color recognized as a nature color in G, GY, and PB. As shown in Figure 1, nature colors are biased toward  $+a^*$ ,  $+b^*$ , and R and YR series such as brown with low lightness and chroma and beige with high lightness and low chroma appear the most.

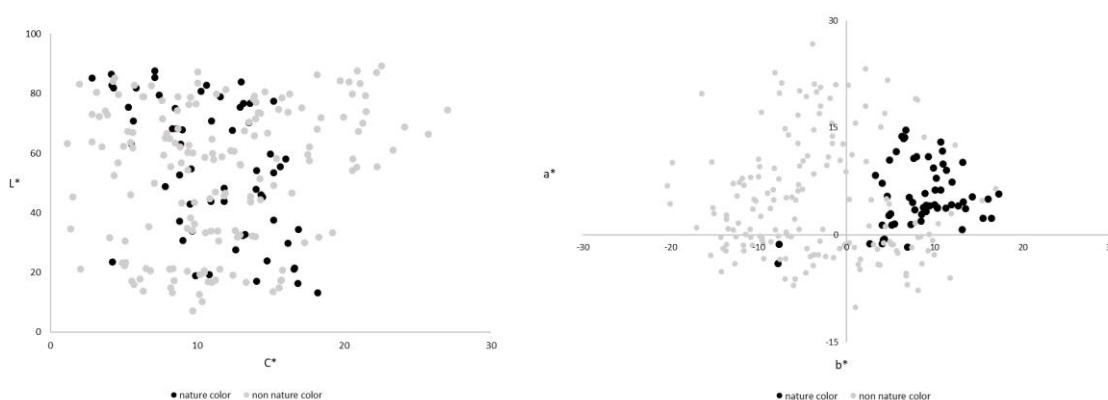

Figure 1: CIE LAB  $L^*-C^*$ ,  $a^*-b^*$  distribution of natural colors in main experiment.

Heller (2002) argued that yellow and purple, red and green, and blue and orange also produce brown when mixed, and that, technically, brown is a mixture of colors. In the study of Quinn, Rosano, & Wooten (1988), brown is also yellow and orange. It can be explained by the compound of black, and it was confirmed that it is a non-elemental color. Beige, which belongs to neutral color, is a neutral color that is seen as a mixture of complementary colors or a mixture of several colors, and is distributed centered on light gray tone and pale tone, which are high-lightness and low-medium chroma in YR color (Seo and Kim 2012). On the other hand, the G color and B hue series did not fall within the range that people perceive as nature colors, even if the chroma is low and the lightness is high or low. When we perceive colors, we remember them as categories of color names such as red, yellow, green, and blue, which is a basic process of color perception. (Davidoff and Ostergaard 1988). In the case of colors and mixed colors of various lightness and chroma of R and Y hue series, there are accurate color names such as Orange, Beige, and Brown. However, the colors and mixed colors of various lightness and chroma of the G and B hue series are expressed using modifiers such as light blue, light bluish green, and dark green rather than exact color names. Therefore, we can see that the range of colors that can be named green and blue in the G and B color series is wide. In addition, in the study of Roca Vilà (2013), blue and green said that the categories were larger and more extensive than other color names

Why are common nature colors (soil, sand, trees, sky, stones, etc.) useful? Why does it go well with all colors?

(red, yellow, orange, purple, pink) showed a wider range of colors to be expressed. Referring to previous studies, brown and beige, which can be distinguished even with separate color names in the R and Y hue series, are mixed colors, which also meet the definition of nature color defined in this study, and represent the nature colors that people generally perceive. It was confirmed that the color was also included in the range. G and B hue series cannot be distinguished by separate color names even if they are dark or bright, and they tend to be named elemental colors, so they do not conform to the definition of nature colors defined in this study and are also in the range of nature colors that people generally perceive. It was confirmed that the color was not included. Table 3 shows the color chip of the finally derived nature color.

Munsell Hue	Color chip	Munsell Hue	Color chip	Munsell Hue	Color chip	Munsell Hue	Color chip
10R 2.5/2		10RP 2.5/2		7.5RP 3/2		10R 3/1	
5R 3/1		7.5R 3/2		2.5YR 3/2		5RP 3/1	
7.5YR 3/2		7.5RP 4/2		2.5Y 4/2		10YR 4/1	
5RP 4/2		2.5R 4/2		10RP 4/1		5YR 4/2	
10B 4/2		10R 4/2		10R 5/1		5R 5/2	
10RP 5/2		2.5YR 5/2		7.5YR 5/2		7.5R 5/2	
7.5RP 5/2		5B 5/1		2.5R 6/2		10YR 6/2	
10R 6/2		10RP 6/1.5		5R 6/3		5YR 6/2	
10YR 6.5/2.5		5YR 7/1		10RP 7/1		10R 7/2	
7.5RP 7/2		10YR 7/1		5R 7/2		7.5YR 7/2	
10R 7/1		10R 7.5/2		10RP 8/1.5		2.5R 8/2	
5RP 8/1		2.5YR 7/2		5YR 8/2		10YR 8/2	
10YR 8/1		2.5RP 8/2		2.5YR 8/2		5P 7.5/2	
10R 8/1		7.5R 8/2		10P 8/1		10YR 8.5/1.5	
5P 8/2		7.5P 8/2		2.5P 8/2		5YR 8.5/1	

Table 3: Nature color.

## CONCLUSION

In this study, an ambiguous color that is not classified as a single color because it does not exist on the color wheel is defined as a natural color, and an experiment was conducted to investigate the characteristics of the natural color that people generally perceive. The tendency of nature colors identified in this study was investigated in the CIELAB space, and it was found that green and blue were not recognized as nature colors when low chroma. Through this, it was found that nature color is affected more by chroma than by lightness. The distinguishing point of this study is to investigate the tendencies and characteristics of natural colors based on the colors of nature materials in order to investigate the characteristics of nature colors that are widely used in the overall industrial field. Based on the results of this study, in the future research on the characteristics of nature colors, it is necessary to find out how much chroma level green and blue colors are perceived as nature colors.

Why are common nature colors (soil, sand, trees, sky, stones, etc.) useful? Why does it go well with all colors?

## REFERENCES

- Davidoff, J. B., and A.L. Ostergaard. 1988. The role of colour in categorial judgements. *The Quarterly Journal of Experimental Psychology Section A*, 40(3): 533-544.
- Eiseman, L. 2006. Color-messages and meanings: A PANTONE color resource. In:
- Heller, E. 2002. *A color lure*, North Light Books, Yedam.
- Küller, R., S. Ballal, T. Laike, B. Mikellides, and G. Tonello,. 2006. The impact of light and colour on psychological mood: a cross-cultural study of indoor work environments. *Ergonomics*, 49(14): 1496-1507.
- Lee, S. M. 2017. *Color of Architecture*, Mimesis.
- Mollica, P., J. Murphy, J. Stoddard, M. Aaseng, and D.L. Glover. 2017. *Color: A Practical Guide to Color and Its Uses in Art*. Laguna Hills.
- Park, Y. S., and H.J. Lee. 1998. *Color and Design*, Seoul: Gyomoon.
- Quinn, P. C., J.L. Rosano, and B.R. Wooten. 1988. Evidence that brown is not an elemental color. *Perception and psychophysics*, 43(2):156-164.
- Roca Vilà, J. (2013). Constancy and inconstancy in categorial colour perception.
- Seo, I. K., and Y.I. Kim. 2012. The image and color characteristic of fashion tinged with Beige. *Journal of the Korean Society of Costume*, 62(6):19-37
- Sturges, J., and T. W. A. Whitfield. 1995. Locating basic colours in the Munsell space. *Color Research and Application*, 20(6): 364-376.

# Comfortable Brightness for Watching Television in the Dark

Byeonjin Kim <sup>1</sup>, Taesu Kim <sup>1</sup> and Hyeon-Jeong Suk <sup>1,\*</sup>

<sup>1</sup> Department of Industrial Design, KAIST, Daejeon, Republic of Korea; kimbyeongjin@kaist.ac.kr, tskind77@kaist.ac.kr, color@kaist.ac.kr

\* Corresponding author: color@kaist.ac.kr

## Abstract

This study investigated the visually comfortable brightness range of viewing television content in a dark environment. We prepared 8-second-long six types of videos for the experiment, and their luminance level was adjusted along with the 15 luminance levels, ranging from 20 nit to 500 nit. Thirty-one participants joined the experiment, and each watched the videos in a dark room. Then, the participants made subjective judgments of the visual comforts of the displayed videos using 5-point Likert scales ranging between -2 (too dark) and +2 (too bright). The television luminance around 129.82 nit was found to be acceptable in a dark environment. In particular, the participants preferred higher luminance when viewing the dark videos, and lower luminance videos when viewing dynamic videos. The results provide empirical evidence that display manufacturers may offer users a more comfortable television viewing experience in a dark environment.

**Keywords:** *visual comfort, dark environment, display luminance, television display, display brightness*

## INTRODUCTION

The human vision system has been evolved to automatically adapt to the range of ambient brightness. Known as light adaptation, our vision system continuously tries to define a proper range between black and white. Our vision system applies varying ranges of black and white simultaneously within one field of view (FOV) when it is necessary. Imaging processing technique has attempted to learn from our vision adaptation to successfully render what camera lenses initially captured.

Called the Auto-Brightness Control (ABC hereinafter) (Merrifield and Silverstein 1988), it is one of the basic adjustments of display devices, and it changes the luminance of a display in response to our visual perception. A great effort has been made to advance the ABC of portable devices with displays, especially because we are watching displays almost everywhere and at any time. In this foregoing, studies have provided empirical data about the optimal brightness of portable displays because they are exposed to a wide range of illumination levels. For instance, a luminance of 40 nit was proposed as an optimal scenario of display luminance in the dark (Rempel et al. 2009).

Then it was later more elaborated involving time dynamics, and Na and Suk (2015) proposed a gradual increase from 10 nit to 40 nit when a person starts to watch one's smartphone display in dark. The study claimed that having the time dynamics could prevent dazzling at first, and the luminance increases gradually to serve users' light adaptation. In the study, the optimal range also considered the perceptual quality of aesthetics of color reproduction. Indeed, according to the official website of Apple iPhone X and Samsung Galaxy Note 9, each reduces its luminance to 44 nit and 23 nit, respectively. However, despite the portable devices, little attention has been paid to defining the optimal brightness of a large display such as a television. Some TV panels offer an energy-saving mode to reduce energy consumption by reducing the backlight luminance to a low level. For example, Samsung offers three levels of energy-saving mode in the television. However, these modes are aimed at saving energy, so the brightness was set apart from the users' preferences.

In 2019, a painting-like television was introduced on the market, trying to mimic a reflective surface when the television is in picture mode. When it is set as a picture mode, its display does not appear as a luminous surface anymore. It varies the back-light luminance more dynamically, pretending a flat



object that reflects the surrounding light source. In sum, a search for an optimal brightness of a television panel has been mainly focused either on energy saving or natural appearance. In a direction toward a high brightness, it is often aligned with technical advancement.

The ABC function of mobile displays is more aware of lower brightness in dark to avoid sleep disorder due to the excessive exposure to the high luminance or eye fatigue caused by the glare. We pay attention to the considerable amount of time we spend watching television particularly in the dark before falling asleep. In this study, we aimed to find an optimal level of brightness of the television display in the dark to support visual comfort while still satisfying users' aesthetic viewing experience.

**VIDEO STIMULI**

For the experiment, six types of 8-second-long video stimuli were prepared. The stimuli consisted of four deliberate video stimuli and two conventional television contents. The four stimuli were collected considering their brightness and dynamics in a dichotomous manner, high or low luminance with dynamic or static change, respectively. Two conventional TV contents include video captured parts of an entertainment show and news. Details of the video stimuli used in the experiment are described in Table 1. And the brightest pixel of each original video clip was at RGB values of 255, 255, 255.







Group	Luminance	Image (0s – 4s – 8s)	Reference
Particular video stimuli	High/Static		<i>Ant-man (2015)</i>  <i>Aquaman (2018)</i>  <i>Iron man (2008)</i>
	High/Dynamic		
	Low/Static		
	Low/Dynamic		
Conventional TV contents			<i>I live alone (2020)</i>
			<i>MBC Newstoday (2020)</i>

Table 1: Details of the video stimuli.

Each video clip was processed to have different illuminances. First, the RGB values of the television according to target illuminances (20 nit, 30 nit, 40 nit, 50 nit, 75 nit, 100 nit, 125 nit, 150 nit, 175 nit, 200 nit, 250 nit, 300 nit, 350 nit, 400 nit, 500 nit) were adjusted with the same color temperature 6500K, which is widely used as a standard in the broadcast system. All values were measured with the spectroradiometer, CS-2000 by Konica Minolta.

Next, we changed the illuminance by manipulating the RGB value of whole pixels. In the process, we calculated the gain value between the target illuminance value of XYZ compared to the original value of XYZ on every pixel of the video clips. Then, we estimated X'Y'Z' applied target illuminance and

converted it back into the R'G'B' for each pixel by the reverse colorimetric characterization. The example result of the manipulation is shown in Figure 1.



Figure 1: Example image that captured the brightness adjusted stimulus.

## **EXPERIMENT**

### **METHOD**

#### *Subjects*

A total of 31 college students made up of 17 men and 14 women were recruited for the assessments. The average age of the participants was 24.24 years and a standard deviation of 3.52 years. All students had normal or corrected-to-normal visual acuity. All participants gave written informed consent and were paid for their participation.

#### *Procedure*

Each prepared video stimuli was shown to the participants with the 15 luminance levels in a random order to minimize the sequential effect. Accordingly, a total of 90 (15 luminance levels  $\times$  6 stimuli) ratings were made by each participant. On average, it took approximately 30 minutes to go through the entire assessment. During the assessments, observers were asked to evaluate how properly bright the television display was and to check one among five- (1) too dark, (2) dark, but okay, (3) good, (4) bright, but okay, and (5) too bright. To collect their assessment based on their immediate judgment, they were asked to check their evaluation before each video stimulus ends.

The assessments were conveyed in a dark room. When the television was turned off, the illuminance level of the experiment room was sufficiently dark, less than 0.1 lux. The dimension was 3.3 m (width)  $\times$  6.2 m (depth)  $\times$  3.3 m (height), and the television was placed in the center of the room. The viewing distance between the television and observer was 2.5 m, and all observers had a similar field of viewing, FOV of 27.4°. For the experiment, the television was set as Movie mode.

### **RESULT**

In Figure 3, the responses are viewed by each image. The evaluations of participants vary from the properties of the video stimuli. They commonly prefer a range with lower luminance when the luminance of the video changes dynamically. For example, in the case of the stimulus with dark luminance changing statically, the luminance range with 50% or greater majority evaluated as “good” was over 125 nit. However, in the case of the video stimulus with dynamic dark luminance, the range was formed under 100 nit. Furthermore, people preferred brighter brightness when watching videos with low luminance. For example, for the 500 nit stimuli, the majority of the people (25 out of 30) who

## Comfortable Brightness for Watching Television in the Dark

saw the video with static high luminance said it was too bright, while only a few of the people (6 out of 30) who saw the static low luminance video said the screen was too bright.

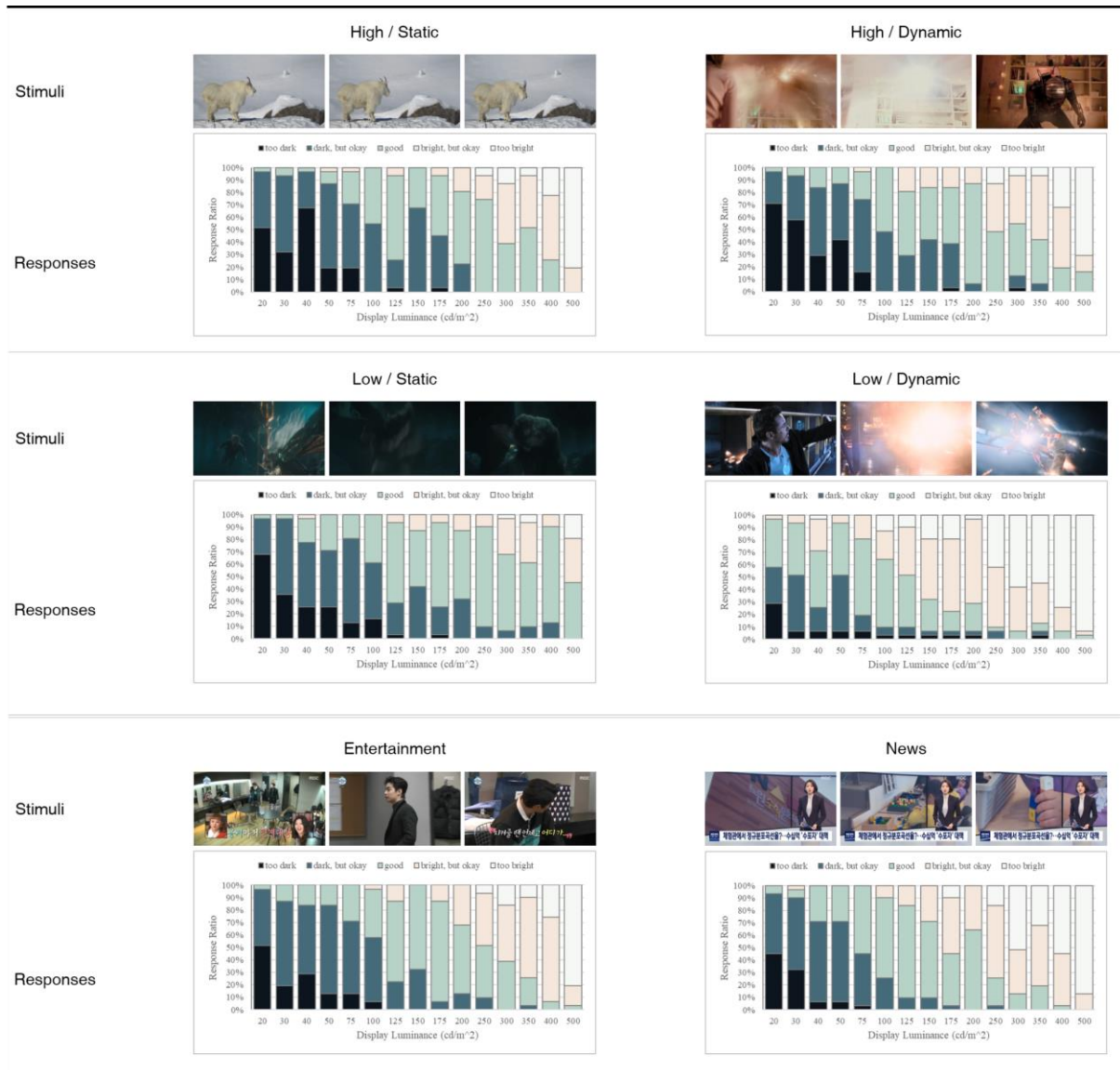

Figure 2: Response ratio according to the type of videos.

As the brightness of the image changed for the overall stimulus, the average of the evaluations responded by the participants was calculated. After, the regression line about the evaluation score was extracted by taking the brightness of video stimuli as the independent variables ( $R^2 = .959, p < .050$ ). The expression of the extracted regression line is as follows. The derived formula is as follows:

$$Score = 0.874 \times \ln(Brightness) - 4.253$$

As a result of estimating the optimal brightness through the regression line, the most appropriate brightness of video (score = 0) watching in the darkroom was calculated to be 129.82 nits. In addition, the acceptability range (score between -0.5 and 0.5) was calculated from 73.26 to 230.03, while the perceptibility range (score between -1 and 1) was calculated from 41.35 to 407.60.

### Comfortable Brightness for Watching Television in the Dark

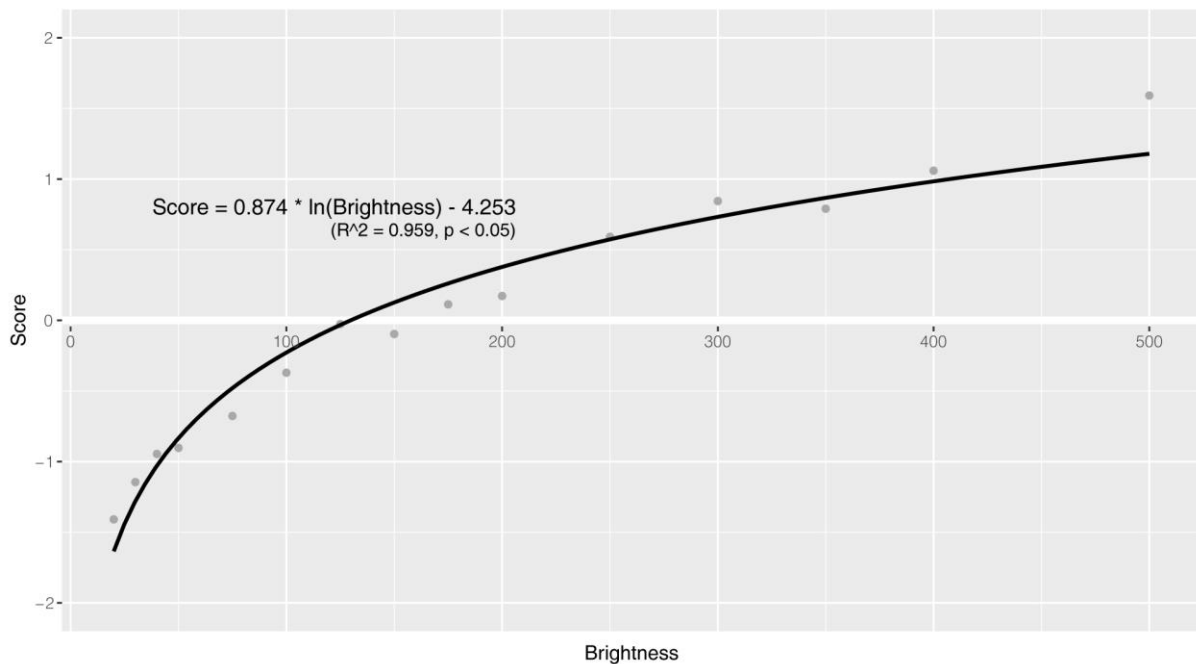

Figure 3: Mean value of evaluation at each brightness and regression line.

## DISCUSSION

Displays are often excessively bright, and we tried to explore an appropriate brightness of viewing television in dark. Manufacturers competitively introduce newer televisions with higher maximum luminance, however, little efforts have been made to avoid the glare hazard. In spite of the advances in ABC techniques, compared to mobile displays such as smartphones, television displays remain unexploited. In this circumstance, we tried to investigate an optimal range of brightness of television displays especially when we view them in dark.

In the visual assessments, we prepared six video stimuli. Then we varied the brightness of each image in 15 luminance levels. Based on the brightest spot of the image, white color, the luminance ranged between 20 nit and 500 nit. Using a 5-point Likert Scale, observers judged whether the presented image had adequate brightness. When collecting responses, instead of asking them to select one optimal brightness, we let them judge the entire 15 luminance variations. By doing so, we obtained acceptable or optimal ranges of luminance, which manufacturers selectively choose their own answers.

Furthermore, the evaluation has been greatly influenced by the presented video stimuli. The range of luminance in which a majority of participants answered "good" was different across all six contents. In other words, simply providing a darker backlight can provide people with a decent viewing experience, but it may not be the best solution to provide a "good" viewing experience. Rather, users will be able to watch the video more comfortably by providing a function that modifies the backlight based on the content considering the luminance characteristics, such as brightness and diversity.

However, the empirical findings in this study are limited to the six kinds of video. In addition to the luminance characteristics, various genres of videos that users are likely to watch in a dark room or at night might be considered. Moreover, a future study needs to employ a wider range of FOV or display sizes. For example, a previous study found that observers expect lower luminance when a display is larger (Fujine et al. 2008). Also, age needs to be taken into consideration in the following study, as the

visual ability changes substantially with age (Inoue and Akitsuki 1998). More specifically, as the pupil size decreases with age, less amount of illuminance reaches the retina (Winn et al. 1994).

## **CONCLUSION**

This study investigates the optimal display brightness when viewing a television display in dark. We presented six full-screened 8-second-long videos in 15 levels of brightness and collected observers' assessments using a 5-Point Likert Scale. We identified an acceptable luminance range between 40 nit and 250 nit. The tendency of the assessment varied from video to video; the more diverse the luminance changes, the darker the brightness. This study provides empirical evidence that display manufacturers can apply to offer users a more comfortable viewing.

## **ACKNOWLEDGEMENTS**

This work was supported by the National Research Foundation of Korea (NRF-2018R1A1A3A04078934) and the BK21 plus program through the National Research Foundation (NRF) funded by the Ministry of Education of Korea (NO.4120200913638).

## **REFERENCES**

- Fujine, T., Yoshida, Y., and M. Sugino. 2008. The relationship between preferred luminance and TV screen size. In: *Image Quality and System Performance V*, International Society for Optics and Photonics. (6808): 68080Z.
- Inoue, Y., and Y. Akitsuki. 1998. The optimal illuminance for reading: effects of age and visual acuity on legibility and brightness. *Journal of Light and Visual Environment*, 22(1), 1\_23: 1-33.
- Merrifield, R., and L.D. Silverstein. 1988. The ABC's of automatic brightness control. In: *Society for Information Display International Symposium Digest of Technical Papers*: 178-181.
- Na, N., and H. J. Suk. 2015. Adaptive display luminance for viewing smartphones under low illuminance. *Optics express*, 23(13): 16912-16920.
- Rempel, A. G., W. Heidrich, H. Li, and R. Mantiuk. 2009. Video viewing preferences for HDR displays under varying ambient illumination. In: *Proceedings of the 6th Symposium on Applied Perception in Graphics and Visualization*: 45-52.
- Winn, B., D. Whitaker, D. B. Elliott, and N. J. Phillips. 1994. Factors affecting light-adapted pupil size in normal human subjects. *Investigative ophthalmology and visual science*, 35(3): 1132-1137.

# Effect of red color and external interferences in selection tasks

Akira Asano<sup>1,\*</sup>, Ayaka Shimura<sup>1</sup>, and Chie Muraki Asano<sup>2</sup>

<sup>1</sup> Kansai University, Japan; a.asano@kansai-u.ac.jp

<sup>2</sup> Hokkaido University of Education, Japan; asano.chie@s.hokkyodai.ac.jp

\* Corresponding author: a.asano@kansai-u.ac.jp

## Abstract

It has been said that the red color has high visual attractiveness, i. e., attracts much visual attention. It is investigated by experiments in this paper whether the visual attractiveness of red color can be reduced by external interferences of suggesting to the respondents the avoidance of the red color. It was conducted in remote experiments, and the respondents are all Japanese language speakers. As the first step, an image of two black “buttons,” guided as “Select one of the buttons to get a piece of sweets,” was presented to all the respondents, and they selected a button. As the second step, red and blue “buttons” were presented, and the respondents were requested to select one similar to the first step under some interferences. It was found that the red was significantly avoided in the case that it was commented, “A piece of 'spicy snacks' is given when you press one of the buttons.”

**Keywords:** *Color attractiveness, Attractiveness of red, interference to attractiveness*

## INTRODUCTION

Each hue of colors is assigned a traditional role. For example, red is often used for indicating “prohibition,” yellow for “caution,” and green for “permission,” and so on. Such customary roles are accepted commonly and often interculturally, for example, the traffic signal system. On the other hand, it has been said that red has high visual attractiveness (Paakki et al. 2019), Lehmann et al. (2018). The attractiveness of color means the strength of impression or the degree of attracting visual attention. The customary meaning of “prohibition” and the high attractiveness of red is somewhat conflicting with each other.

We assume in this paper that the attractiveness of red can be controlled by external interferences and show it through experiments of selection problems. The experiment has two steps; In the first step, two black buttons are shown to the respondent, and he/she is guided to select one of the buttons to get a piece of sweets. In the second step, red is assigned to the button that the respondent did not select in the first step and blue to the other, and the same guide to select one as the first step. In the second step, one of the various interferences is given to the respondent to suggest the avoidance of red color. The interferences are a movie showing an animation to rush the respondent to select immediately, telling the respondent that one of the buttons gives a piece of spicy snacks, and a slideshow to show that red means stopping or prohibiting traffic signs.

The experimental results show that the number of respondents selecting red decreased significantly only in the “spicy snack” interference. It indicates that an appropriate external interference can inhibit the attractiveness of red.

## EXPERIMENTS

We conducted remote experiments via Google Forms, and the respondents are all Japanese language speakers. As the first step, an image of two black “buttons,” guided as “Select one of the buttons to get a piece of sweets,” is presented to all the respondents, and they select one of the buttons. The image of the two black buttons is shown in Figure 1. As the second step, the respondents are requested to select one of the buttons similar to the first step under one of the following conditions (0)-(4):

(0) The same condition as the first step, i. e., with two black buttons, is repeated.

(1) Red color is assigned to the button that the respondent did not select in the first step, and blue color is assigned to the other. The image of the red and blue buttons is shown in Figure 2.

(2) Color assignment is the same as (1). A movie showing the message "Answer immediately" with blinking animation is presented at the selection as interference. A screenshot of the movie is shown in Figure 3.

(3) Color assignment is the same as (1). It is commented at the selection, "A piece of 'spicy snacks' is given when you press one of the buttons," as interference.

(4) Color assignment is the same as (1). A slideshow of photos of traffic signals and signs is presented at the selection as interference for suggesting that red indicates prohibition. A screenshot of the slideshow is shown in Figure 4.

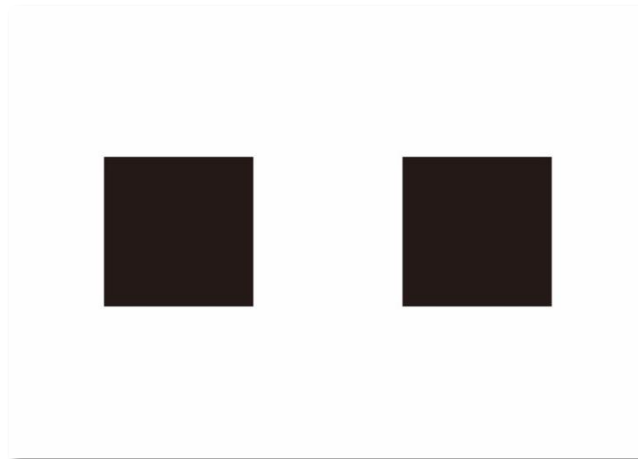

Figure 1: Two black buttons presented in the first step.

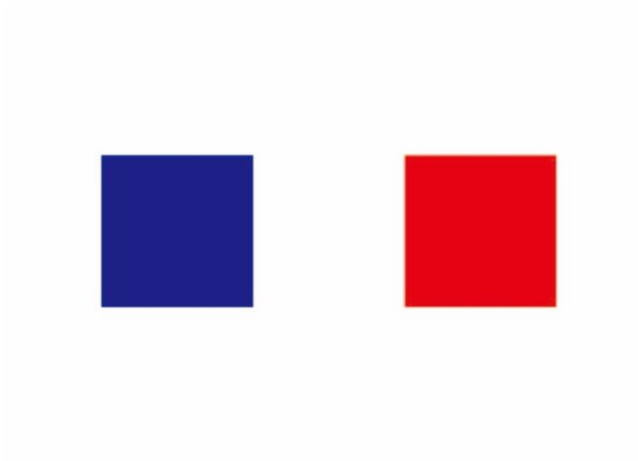

Figure 2: Blue and red buttons presented in the second step.

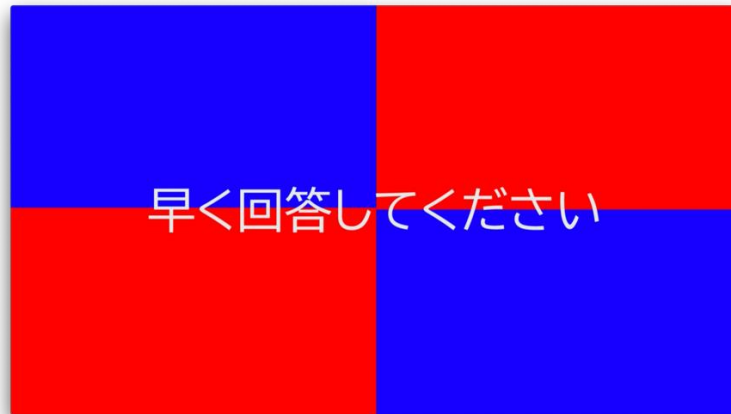

Figure 3: A screenshot from the movie presented under the condition (2). The movie blinks by interchanging the red and blue regions. The Japanese text means “Answer immediately.”

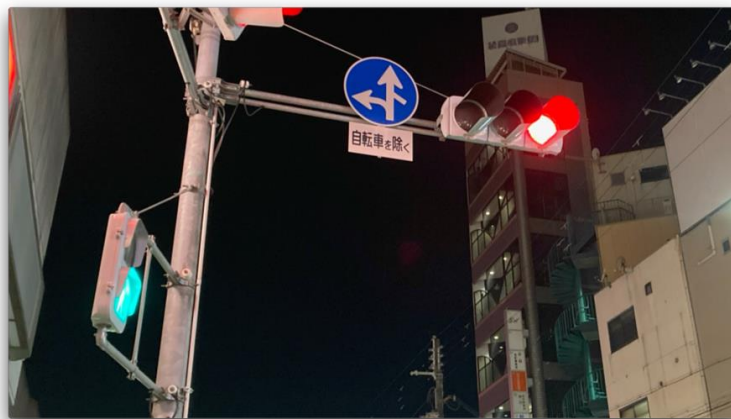

Figure 4: A screenshot from the slideshow presented under the condition (4).

## EXPERIMENTAL RESULTS

The results of the experiments are shown in Tables 1-5. The numbers in the table indicate the number of respondents in each category. For example, in Table 1, 24 respondents selected the right button, and 6 selected the left one in the first step. In the second step, 18 of the former 24 still selected the right and 6 changed the selection to the left, and 2 of the latter 6 changed it to the right, and 4 still selected the left.

According to the result of the experiments under the condition (0) in Table 1, 26.6% ( 8 of 30, that is,  $(6 + 2) / (24 + 6)$  ) of the respondents changed their selections, right to the left or left to right, in the second step. The result under condition (1), in Table 2, shows that 57.1% (8 of 14) changed their selection to the red button at the second step. The ratio of respondents who changed the selection significantly increased; If we assume independent trials of changing the selection at the probability  $8/30$ , the probability that 14 of the trials yields 8 or more changes is significantly small, about 0.0051. It indicates the attractiveness of the red color.

The result under the condition (3), commenting “a piece of 'spicy snack' may appear,” shows that 26.6% ( 4 of 15 ) changed their selection to the red button at the second step, as shown in Table 4. The ratio is the same as the result under the condition (0) and obviously smaller than the condition (1). It



indicates that the “spicy snack” comment inhibited the attractiveness of the red color. Such effect was not observed in the cases of conditions (2) or (4); 50.0% (6 of 12 in (2) and 7 of 14 in (4), respectively) of the respondents changed their selection.

1 <sup>st</sup> step		2 <sup>nd</sup> step	
right	24	right	18
		left	6
left	6	right	2
		left	4

Table 1: Experimental results under the condition (0). Shaded cells indicate the number of respondents who changed their selection in the second step.

1 <sup>st</sup> step		2 <sup>nd</sup> step	
right	8	right (blue)	4
		left (red)	4
left	6	right (red)	4
		left (blue)	2

Table 2: Experimental results under the condition (1).

1 <sup>st</sup> step		2 <sup>nd</sup> step	
right	8	right (blue)	4
		left (red)	4
left	4	right (red)	2
		left (blue)	2

Table 3: Experimental results under the condition (2).

1 <sup>st</sup> step		2 <sup>nd</sup> step	
right	10	right (blue)	9
		left (red)	1
left	5	right (red)	3
		left (blue)	2

Table 4: Experimental results under the condition (3).

1 <sup>st</sup> step		2 <sup>nd</sup> step	
right	9	right (blue)	4
		left (red)	5
left	5	right (red)	2
		left (blue)	3

Table 5: Experimental results under the condition (4).

## **DISCUSSION AND CONCLUSIONS**

The avoidance of red by the “spicy snacks” comment may be affected by the cultural characteristics. The respondents are Japanese language speakers, and there are popular snack brands that are spicy, which are not always in red. Nevertheless, the results suggest that the impression of “spicy” is related to the red color, and they tend to be avoided.

## **ACKNOWLEDGEMENTS**

This research is partially financially supported by JSPS KAKENHI Grant No. 19K12692.

## **REFERENCES**

- Paakki, M., M. Sandell, and A. Hopia. 2019. Visual Attractiveness Depends on Colorfulness and Color Contrasts in Mixed Salads. *Food Quality and Preference* 76: 81-90.
- Lehmann, G. K., J.E. Andrew, and R.J. Calin-Jageman. 2018. Meta-Analysis of the Effect of Red on Perceived Attractiveness.” *Evolutionary Psychology: An International Journal of Evolutionary Approaches to Psychology and Behavior* 16 (4).



# A study on colour emotions of the mask

Ray-Chin Wu<sup>1</sup>, Chao-Lung Lee<sup>2,\*</sup>, Ming-Hsiu Mia Chen<sup>3</sup>, Chien-Wei Chang<sup>4</sup> and Yun-Maw Cheng<sup>5</sup>

<sup>1</sup> The Department of Media Design, Tatung University, Taipei, Taiwan; rcwu@ttu.edu.tw

<sup>2</sup> The Graduate Institute of Design Science, Tatung University, Taipei, Taiwan; longlee1221@gmail.com

<sup>3</sup> The Graduate Institute of Design Science, Tatung University, Taipei, Taiwan; mira@gm.ttu.edu.tw

<sup>4</sup> The Department of Information Management, Tatung University, Taipei, Taiwan; cwchang@gm.ttu.edu.tw

<sup>5</sup> The Graduate Institute of Design Science & Department of Computer Science and Engineering, Tatung University, Taipei, Taiwan; kevin@gm.ttu.edu.tw

\* Corresponding author: longlee1221@gmail.com

## Abstract

Face masks have become the must-have daily accessories to slow the spread of COVID-19. People tend to choose different masks based on their feelings or preferences. The aim of this study was to evaluate colour emotions for plain colour masks. There were two stages of experiments conducted. Firstly, a Likert scales was used to investigate bipolar adjective pairs of colour emotions in order to obtain appropriate pairs. Secondly, a semantic differential technique was applied to analyze the selected bipolar adjective pairs of colour emotions. The result showed that the emotions aroused by plain colour masks are “clean,” “like,” “modern,” and “new.” A neutral colour was conceived as “cool.” These two bipolar adjective pairs, “modern-classical” and “new-old,” are similar. Also, lightness can affect intensity of colour emotions.

*Keywords: Colour emotion, Colour psychology, semantic differential technique*

## INTRODUCTION

Wearing face masks has become a fixture of daily life across the world since COVID-19 made its first appearance and declared a pandemic. Matching masks to pair with apparel and accessories in order to stay safe in style is the new fashion trend. Speaking of this change, colour is the key to this new global culture. The number of mask manufactures started to produce and provide masks in various colour options is on the increase. Furthermore, Kumar et al. (2020) investigated a variation of emotional effects since COVID-19 outbreak. These were mainly the tendencies towards trust and fear. This study was focused on the relation between colour preference of masks and emotional effects of COVID-19. The contributions described in this paper include:

- Finding appropriate bipolar colour emotion pairs of face masks.
- Positioning the scale intensity of bipolar colour emotion pairs for face masks in CIELAB colour space.

## METHODOLOGY & RESULTS

A two stages of experiment, which investigates appropriate adjectives of colour emotions and analyses the resulting psychophysical data, was conducted.

In the first stage of the experiment, there were 13 pairs of bipolar adjectives of colour emotions collected according to the previous researches of Kobayashi (1981) and Ou et al. (2004). These 13 adjective pairs of colour emotions were accessed by observers through 7-point Likert scales. There were 114 observers for the survey, including 50 males and 64 females. Each observer was presented with the Likert scale questionnaire. The result of survey showed that mean scores of colour emotions were higher than 4, including “clean-dirty,” “like-dislike,” “modern-classical,” “warm-cool,” “new-old,” “heavy-light,” and “hard-soft.” These 7 pairs of adjectives were then applied in the next stage of experiment.

In order to investigate coloured masks commonly available in the market, this study collected plain colour masks from community pharmacies and derive coordinates of colours for each mask by instrumental analysis. The 11 masks were selected as colour stimuli and the colour coordinates were obtained using an NCS Colourpin colour reader. As shown in Figure 1, CIELAB values of these colours spread to a large range of hue within the high-lightness section.

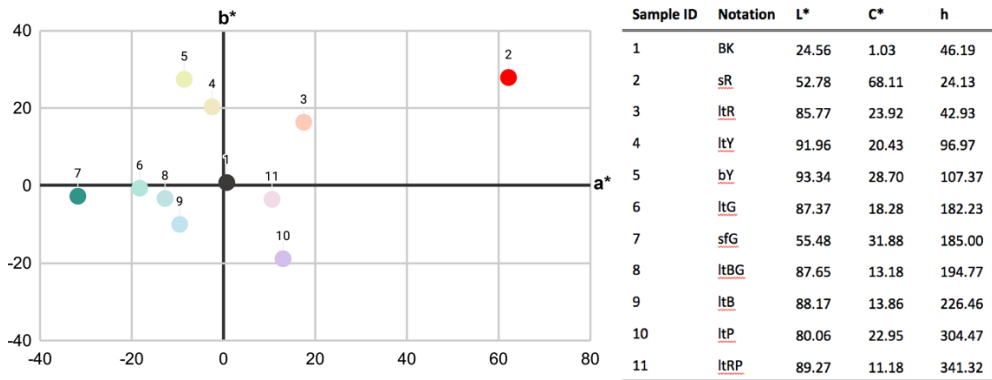

Figure 1: The 11 mask samples in the CIELAB colour space.

The second stage of the experiment was conducted in a behavioral testing room with average illuminance of 380 lx. One observer at a time entered the room, sat down in the assigned seat, and adapted to the light environment for 10 minutes. A tablet device (Apple iPad Mini 7.9-inch) was applied for presentation of stimuli. The tablet device was set at 40cm viewing distance and observers used this device with direct viewing. In order to confirm stable colour reproduction on the display, a tele-spectroradiometer (PR650) was utilised to measure three colour mask images on the tablet screen. These three colours are BK, bY, and ltBG, and the standard deviations of luminance are 0.17 in BK colour, 3.32 in bY colour, and 1.84 in ltBG colour. The result suggested satisfactory stability of colour reproduction on the display.

A total of 129 observers, including 70 males and 59 females, whose ages ranged from 18 to 24, and the average age was 18.95 had been recruited to perform the experiment. The experiment assessed 11 plain colour masks by using 7 pairs of bipolar adjectives of colour emotions from the first experiment. Each observer was presented with a single plain colour face mask displayed against a medium gray background on a tablet screen. The colour emotions of these masks were evaluated by using semantic differential technique.



Figure 2: Screen layout for the experiment.

During the experiment, spectacles were allowed to wear to correct some observers' visual acuity. After the instructions were given, the observer started the experiment with a tablet device. Figure 2 showed the screen layout of stimulus of plain colour masks on a tablet. Each stimulus was located at the center of the screen and the size of stimulus was 6 cm by 4.5 cm in the 9° by 6° viewing angle setting. There were 10 numbered buttons arranged in line underneath the layout. These buttons were divided into two sides, i.e., "clean" and "dirty". Each side was consisted of five point scales, representing "a little," "slightly," "normal," "very," and "extremely." All of 11 stimuli were presented to each observer randomly and 7 bipolar colour emotion pairs were evaluated in each stimulus. The observer was asked to press one of buttons indicating their perception of the colour mask. In between presentations of each stimulus was a slide of full-screen gray, which lasted for one second to avoid any effect of afterimage. Each observer took approximately 8 minutes to complete. The result data were expressed as mean values that indicate observers expected to rate from a colour emotion pair for a particular colour sample.

These results were described using bubble charts, as shown in Figure 3. Each bubble represents the locations of the 11 plain mask samples in the CIELAB colour space. The size of each bubble indicates the scale intensity of bipolar colour emotion pairs. The scale intensity was the average of colour emotions pairs rating scores for colour masks. Also, there were two colours of bubbles in these charts, red and blue. Red bubbles represent colour emotions of "clean", "like", "modern", "new", "hard", "heavy", and "warm". Blue bubbles represent colour emotions of "dirty", "dislike", "classical", "old", "soft", "light", and "cool".

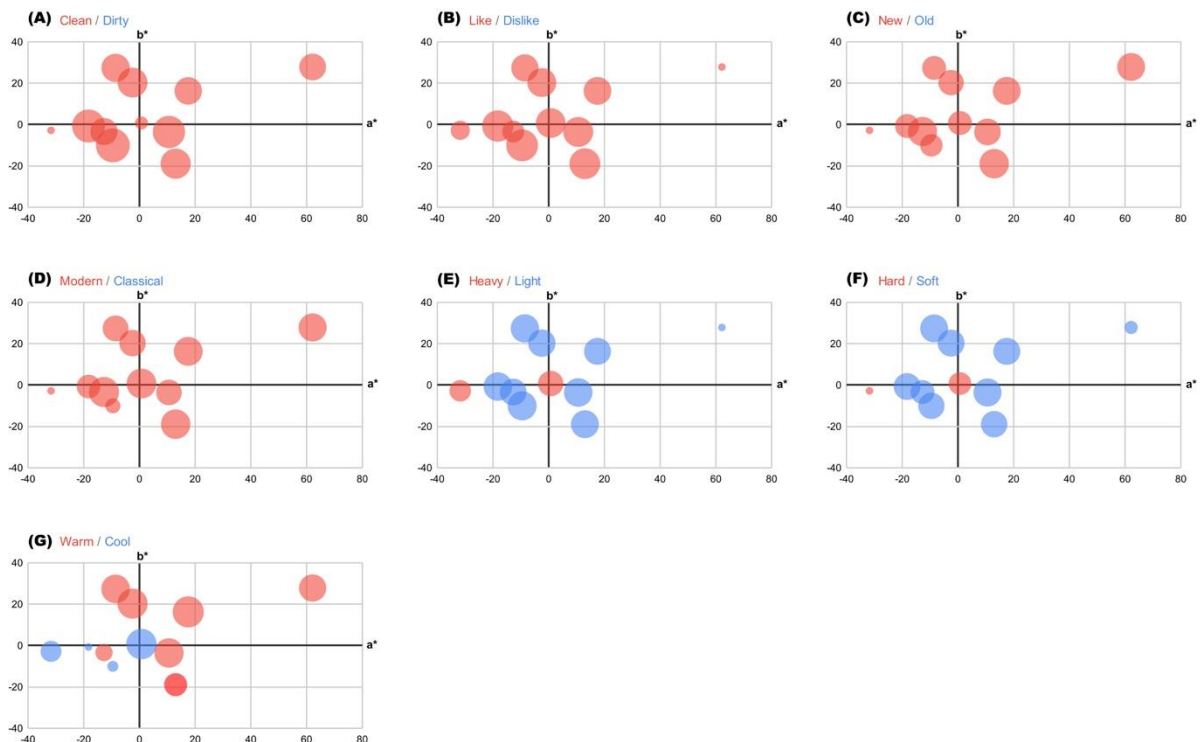

Figure 3: The bubble chart of 7 bipolar colour emotion pairs in the CIELAB colour space: a\*-b\* diagram.

Few tendencies can be seen from Figure 3. In Figure (A), all bubbles are red and this shows that observers considered these 11 plain colour masks evoked the emotion of "clean." Thus, these colour masks were associated with the emotions of "like," "modern," and "new" so as shown in Figure 3 (B) to (D). It also shows that the biggest scale intensity of colour emotion pairs is "clean" for the ItB colour

mask (The value is 3.74). In comparison, the smallest bubbles is the colour emotion of sfG colour in most charts, i.e., Figure 3 (A), (C), (D), and (F). Its rating score is range from 0.33 to 0.98. In Figure 3 (E) and (F), demonstrate that most colour mask were considered as relevant to “light” and “soft”. Otherwise, BK colour and sfG colour were associated with the emotion of “heavy” and “hard”. Red and blue bubbles spread to the CIELAB colour space as shown in Figure 3 (G). It is considered that a hue value had more influence on “warm-cool” than other colour emotions. Colours located in quadrant III of  $a^*-b^*$  plane easily evoke the emotion of “cool,” and a neutral colour, BK, is also associated with “cool.” In addition, the sizes of corresponding bubbles are similar in the bubble charts of “modern-classical” and “new-old” as shown in Figure 3 (C) and (D). This phenomenon was identified as the difference between the meaning of the words, “modern-classical” and “new-old”, is subtle. The plain colour masks with high-lightness were considered as “soft”, “light”, and “clean” in colour emotions. The relevance between emotions and lightness was also recognised.

## **CONCLUSION**

As the impact of the COVID-19 reshapes our daily lives, face masks have become the most important part of any outfits. The results of the study indicate plain colour masks are associated with emotional effects. A colour mask not only reserves the original image of “clean”, but evokes the perception of “new” and “modern”. This is different from a surgical mask. Also, the “light” and “soft” image of masks can be altered by using colours.

## **REFERENCES**

- Gao, X.-P., J. H. Xin, T. Sato, A. Hansuebsai, M. Scalzo, K. Kajiwara, S.-S. Guan, J. Valldeperas, M. José Lis, and M. Billger. 2007. Analysis of cross-cultural color emotion. *Color Research and Application* 32:223-229.
- Gupta, V., N. Jain, P. Katariya, A. Kumar, S. Mohan, A. Ahmadian, and M. 2021. Ferrara. An Emotion Care Model using Multimodal Textual Analysis on COVID-19. *Chaos, Solitons & Fractals* 144:110708
- Kumar, A., S. U Khan and A. Kalra. 2020. COVID-19 pandemic: a sentiment analysis: A short review of the emotional effects produced by social media posts during this global crisis. *European Heart Journal* 41:3782-3783
- Kobayashi S. 1981. The aim and method of the Color Image Scale. *Color Research and Application* 6:93–107.
- Kobayashi S. 1992. *Color Image Scale*. New York: Kodansha USA.
- Ou, L., M. R. Luo, A. Woodcock, and A. B. Wright. 2004. A study of color emotion and color preference, Part I: Color emotions for single colors. *Color Research and Application* 29:232–240.
- Ou, L., M. R. Luo, A. P.-L. Sun, N.-C. Hu, and H.-S. Chen. 2012. Age effects on colour emotion, preference, and harmony. *Color Research and Application* 37:92–105.
- Ou, L., Y. Yuan, T. Sato, W.-Y. Lee, F. Szabó, S. Sueeprasan, and R. Huertas. 2018. Universal models of colour emotion and colour harmony. *Color Research and Application* 43:736-748.

# Is Naturalness a Valid Lighting Concept?

Andrew Chalmers<sup>1,\*</sup>

<sup>1</sup> Institute of Biomedical Technologies, Auckland University of Technology, Auckland, New Zealand;  
andrew.chalmers@aut.ac.nz

\* Corresponding author: andrew.chalmers@aut.ac.nz

## Abstract

The purpose of this paper is to answer the question in the title by outlining several experimental investigations of the lighting quality of various light sources, predominantly LEDs. All the cases represented here included colour naturalness as at least one of the dimensions studied, and one has to conclude that naturalness is something of great interest to lighting engineers and scientists. A question remains, however, regarding an acceptable definition of naturalness in lighting. The paper also includes a brief overview of some of the major metrics used to represent light source colour quality.

**Keywords:** LED lighting, colour in lighting, colour rendition, colour quality, colour naturalness

## INTRODUCTION

The concept of Naturalness was thrust to the forefront of the LED lighting community in 2020 when one LED supplier proposed *Spectral Similarity* (explained later) as a metric for the naturalness of a light source (i.e. to classify the capacity of a light source to illuminate coloured surfaces in such a way as to provide the "most natural" view of the colours). To put this into context, the CIE, and the lighting community generally, have for several decades been grappling with the inadequacies of the colour rendering index (CRI, symbol Ra), and a number of alternative, or supplementary, metrics have been proposed in attempts to provide lighting users with more useful data.

The widespread availability of LED lighting in the new millennium has been nothing short of revolutionary. The lumen-per-watt efficacy has climbed to unprecedented levels, while the physical size of the sources has shrunk to sizes measured in millimetres, making for significant increases in efficiency in luminaire design. In the realm of colour, LEDs are providing the source designer with an unparalleled range of narrow-band monochromatic spectra which can be combined in ways to create white light sources of widely differing SPDs (spectral power distributions) with a correspondingly wide range of colour properties. These can be further expanded by the recent developments in the formulation of phosphor materials which are able to act as wavelength converters, often with wide-band outputs.

Until relatively recently, the only colour specifications available to users were the CCT (correlated colour temperature) which largely determines the atmosphere created by the lighting, and the CIE colour rendering index Ra as a guide to the colour quality of the source. At a time when fluorescent sources dominated the interior lighting scene, these two terms were generally sufficient.

However, the CRI was found to be sadly deficient when LEDs came onto the general lighting scene. Many LED lamps with "good" Ra values (and high luminous efficacies) were found to give unacceptable colour performance for users out in the marketplace. The CIE and other professional and standardization bodies have been working on this problem for much of the past two decades. A more complete overview of the recent developments will be given in the next section, after which the question of Naturalness, and some possible naturalness metrics, will be studied in detail.

This paper will focus on the performance of light sources in relation to their ability to provide a natural portrayal of the colours of objects in the scenes they illuminate, and it concentrates largely on LED-type sources. It will not explore the specific effects of variations in the CCT of sources (as it is



hoped ultimately to discover a Naturalness metric that will apply independently of CCT) and the concept of dynamic lighting is excluded.

### **COLOUR RENDITION AND COLOUR QUALITY**

We note that the causes and effects of the problems with the CIE Ra have been discussed in a paper by Van Tright (1999). In spite of the criticisms it has received, Ra is still the internationally accepted metric for colour rendering (CIE 1995), and it is included here for completeness' sake.

Briefly, the computation method for Ra involves: (a) the identification of the test source; (b) selection of the appropriate reference illuminant; (c) calculating the colour of a selected test colour sample under each of the sources, using a chromatic adaptation transform to correct for differences between the test and reference source; (d) calculating the difference between the two resulting sample colours; (e) repeating steps (c) and (d) for the 14 defined CIE test colours; (f) calculating the mean colour difference for the first 8 CIE test colours; (g) scaling the result (f) by a set constant, and then subtracting from 100 to yield the value of Ra.

An updated method for estimating the colour quality of a source was published by NIST (Davis and Ohno 2010) and known as the CQS (colour quality scale). It was also based on a colour difference approach, using the CIE definition of reference illuminant, but with 15 newly-defined test colours, and using more up-to-date colour difference and adaptation calculations, as well as more sophisticated mathematical procedures to produce the final results, given in three main forms: Qa (general quality index), Qf (fidelity index) and Qp (preference index).

Another more modern approach, known as TM-30-15, was published by IES (2015), again using a colour difference method but with a modified definition of the CIE reference illuminant, and using a new set of 99 test colours. It included new advances in colour difference, chromatic adaptation, and averaging computations, to yield two main outputs: Rf (colour fidelity index) and Rg (gamut area index).

In 2017 the CIE adopted their colour fidelity index Rf (CIE 2017), a modified version of the IES Rf, but using the same basic calculations that were built into the IES system. The IES has more recently published TM-30-18, a revised version of the 2015 method, harmonizing the Rf calculation with the CIE.

Meanwhile, there have been many other efforts over the past two decades to find or refine these and other metrics that may have the potential to serve as measures of colour quality, summarized by (Smet et al. 2012), and including Naturalness. One of these, often referred to as the MCRI (memory colour rendering index) is singled out for mention here, and explained in detail in (Smet and Hanselaer 2016). The metric was based on the assumption that the colour rendition or colour quality of a light source improves when the colour of familiar objects is rendered more closely to what is expected or recalled. The method made use of ten test colours, being the colours of ten well-known objects. After first computing their colours under the test source, the corresponding colour values under CIE illuminant D65 can be evaluated by use of a chromatic adaptation transform and then converted to the IPT colour space. The degree of similarity of each object's chromaticity to the respective memory colour of each familiar object can then be calculated and combined to yield index Sa and then rescaling the values to give index Rm in the 0 ... 100 range.

## **EVIDENCE FOR COLOUR NATURALNESS**

At least ten research groups have been active over the past dozen or so years in researching the colour quality properties of light. Here (in *approximate* chronological sequence) are highlighted a number of those groups whose results are based on visual evaluations of quality factors including Naturalness.

Jost-Boissard et al. (2009) reported on experiments with 12 different LED spectra at approx. 225 lux and CCTs of 3050 and 3950 kelvins, using simultaneous viewing of 2 light booths by a total of 40 observers (at different times). They comment that “One may not have a precise idea of what is naturalness and thus would not know what to expect.” This appears to be a recurring theme in the majority of the work reported here, although many of the authors glided over this problem.

In a later piece of work (Jost-Boissard et al. 2015) using a range of different light sources at approx. 220 lux and CCTs of 3000 K and 4000 K, the results from 36+ observers indicated that both Ra and Qa correspond to visual Naturalness with  $r^2 \geq 0.88$ . This led to the comment that “A high fidelity score does not necessarily mean a natural rendition since it is based on comparison to a reference illuminant which itself may not be considered as the most natural.” This acute observation has been echoed by many other workers in this field. Significant correlations with other metrics (including MCRI and CQS quantities) are also given in the paper.

Smet et al. (2010) used six different sources (including three LED combinations) at 250 lux and 2750 K, in a 2-booth setup viewed by a total of 92 observers who were asked to evaluate the sources for Preference, Fidelity, Vividness, Naturalness and Attractiveness. Naturalness was found to correlate closely with Sa (or, MCRI), Ra, and Qa (all with Pearson correlation coefficients  $\geq 0.86$ ). As a justification for the use of Sa, they comment that “Colours often seem ‘wrong’ when they are not what we expect ... them to be”. A later paper (Smet et al. 2011) using a different statistical approach to examine thirteen metrics, led to Spearman correlation results : Ra and Qf ( $r \geq 0.65$ ); Sa ( $r = 0.45$ ).

Islam et al. (2013) and Dangol et al. (2013) describe an investigation based on 21 LED sources and 3 fluorescent lamps at 2700, 4000 and 6500 kelvins, to determine visual observations by 60 participants of “Naturalness of objects, Visual appearance of the lit environment, and Colourfulness of the Macbeth Colorchecker Chart”. This writer’s examination of their data showed that the average Naturalness response correlated with Qp and Qg ( $r^2$  scores between 0.4 and 0.7 for the various sources at the different CCTs). Correlation ( $r^2$  score) with the mean value of Qp and Qg has been calculated as 0.28 at 2700 K and  $\geq 0.75$  for 4000 K and 6500 K. Bhusal and Dangol (2017) conducted a new analysis of the data which showed a “moderate correlation” (Spearman  $r = 0.48$ ) of Naturalness with TM-30 Rg.

Khanh et al. (2017a) used 5 different sources (including two LED types) viewed by 38 observers in a mock-up office, at 470 lux and CCTs between 2300 and 4100 kelvins, to scale Colour preference, Naturalness and Vividness for comparison against a total of 14 colour quality metrics. In one of the clearest instances of specific guidance for the observers, Naturalness was defined as “Subjective extent of how natural the colour appearance of an identified object (e.g. a rose) is under the current light source compared to the ideal colour appearance in your memory in the way you remember that object.” This may help explain the correlation of Naturalness with MCRI Rm ( $r^2 = 0.72$ ) in their results.

In a further study (Khanh et al. 2017b) seven multi-LED spectra (all with Ra  $\geq 96$ ) at 3220 K were evaluated by 23 observers using a single light booth. In the analysis of the merged data set of their two 2017 papers, several proposals were made for a prediction formula for the Naturalness colour quality of any source, of which the simplest is shown here as Equation (1) with  $r^2$  of 0.64:

$$CQ_{\text{Nat}} = \text{MCRI} + 0.000019(\text{CCT}) + 0.087(\text{Qp}) \quad (1)$$

In a study of reddish cosmetic products, using 7 multi-LED spectra at 3200 K and 550 lux, Khanh and Bodrogi (2018) showed a high correlation of Naturalness with standalone indices Qp and MCRI Rm ( $r^2 = 0.88$  in both cases). Six “responsive observers” provided the subjective evaluations.

Royer et al. (2017) used 26 different LED spectra at 3500 K and 215 lux and a total of 28 observers. They were asked to provide a range of subjective responses, including “normalness” which is taken here to be analogous to Naturalness, and which is expressed on a scale of 1 to 8, with a “1” representing “most normal”. A number of combinations of TM-30 metrics were compared, and a proposed formula for Normalness (with  $r^2 = 0.83$ ) is given in Equation (2):

$$\text{Normalness} = 9.37 - 0.069(R_f) - 3.76(R_{cs,h1}) \quad (2)$$

where  $R_{cs,h1}$  is the red chroma shift in the TM-30 system.

Royer et al. (2017) also make the strong point that “... guidance or thresholds derived from this experimental data should not be indiscriminately applied to other contexts”. Such a caveat almost certainly also applies to all the works cited in this section, and this needs to be borne in mind.

### Spectral Similarity

The idea of spectral similarity as a measure of Naturalness was mentioned at the beginning of this paper. The proposal, published by Bridgelux Inc. (2020), defined the ASD (average spectral difference) in the following terms<sup>1</sup>: “The ASD value, expressed as a percentage, always compares a test source to a reference source at the same CCT”. The reference source is determined by use of the TM-30 reference-source methodology. The two SPDs are then “Y-normalized so that they are comparable in the visible spectrum”. The absolute values of the differences between the two SPDs are sampled at 1 nm intervals from 425nm to 690nm. These values are averaged (arithmetic mean) and the result converted to a percentage to give the ASD. It will be evident that the ASD should be zero to achieve the highest possible Naturalness in this approach.

There does not appear to have been any controlled visual experimentation to verify this quantity as a Naturalness metric. In an online article, Livingston et al. (2020) have discussed several criticisms of the ASD, including:

- “While spectral similarity is easily defined and calculated, that doesn’t establish that it provides useful information, which is perhaps the reason no previous spectral similarity metric has gained traction in the lighting community.”
- A number of past experiments have shown that “... spectral similarity measures like ASD are not well correlated with people’s descriptions of the naturalness of a light source.”

### Summary

Because of length limits, this section has presented a short selection of relevant visual research data published over the past decade. It is not claimed to be exhaustive, and the author acknowledges the contributions made by many other research groups in this period.

Where it has been possible to pinpoint specific standalone metrics that correlate with Naturalness, these are included in Table 1 along with their coefficients of determination.

---

<sup>1</sup> Direct quotes in this paragraph are from (Bridgelux Inc. 2020) and the remainder is paraphrased from the same source.

Year	CIE Ra	MCRI Sa	MCRI Rm	CQS Qa	CQS Qf	CQS Qp	CQS Qg
2010	0.77	0.76		0.74			
2013						≥ 0.50	≥ 0.40
2015	≥ 0.88	≥ 0.36		≥ 0.88	≥ 0.84	≥ 0.64	
2017			0.72				
2018			0.88			0.88	

Table 1: Summary of potential Colour Naturalness metrics with quoted (or deduced) values for  $r^2$ . Notes:  $r^2$  = coefficient of determination, where  $r$  = Pearson correlation coefficient. MCRI Rm results have been interpreted from the papers' contents.

In addition to these metrics, there have been proposals for Naturalness formulas, as in Equations (1) and (2). This author also offers the following simple formula based on the work of Islam et al (2013):

$$CQ_{\text{Nat}} = \frac{1}{2}(Q_p + Q_g) \quad (3)$$

where  $CQ_{\text{Nat}}$  represents the average Naturalness discussed in that paper, with a deduced average  $r^2 = 0.61$  (in the range 0.28 to 0.78 for sources of different CCTs).

Note that this survey has included only one piece of visual research utilizing the IES TM-30 method (Royer et al. 2017). There is likely to be an increase in such output in the near future – particularly since the publication of TM-30-18.

## CONCLUSIONS

To attempt an answer to the question in the title ... it seems safe to say that the preceding content clearly demonstrates a strong interest in the naturalness concept among the members of the lighting fraternity. That is not to say that the findings in Table 1 and Equations (1) to (3) can be regarded as definitive; rather, they are pointers towards possible future approaches.

There would seem to be two essential steps to enable progress in this field, which needs to be underpinned by further visual research:

1. Agreement on a definition for Naturalness in lighting;
2. Creation of a database of SPDs with their corresponding colour Naturalness gradings.

In terms of step 1, it has already been noted that Khanh et al. (2017a) provided a definition as an aid to their observer panel, and this would appear to have much to recommend it. Another suggestion (this from outside the field of illumination) has been put forward by Goodman (2008) as part of a project on the feasibility of the measurement of naturalness, and which states that Naturalness is: "The probability that a material or object is perceived as being natural i.e. perceived as being derived from nature." It may be possible to rephrase this to fit the needs of lighting.

Step 2 will depend on a satisfactory definition (step 1) and will depend on the ability of research groups to access the funding to carry out the visual experimentation necessary to create such a database. As an interim step, it may be possible for the authors mentioned above to provide tables of SPDs for the sources investigated.

## REFERENCES

Bhusal, P. and R. Dangol. 2017. Performance of different colour quality metrics proposed to CIE TC 1-91 *International Journal of Sustainable Lighting*, 20: 91-103.

- Bridgelux Inc. 2020. *Average Spectral Difference, a new method to make objective comparisons of naturalness between light sources*. Bridgelux White Paper: 16 pp.
- CIE (Commission Internationale de l'Éclairage). 1995. *CIE 13.3-1995: Method of measuring and specifying colour rendering properties of light sources*. CIE, Vienna: 16 pp.
- CIE (Commission Internationale de l'Éclairage). 2017. *CIE 224-2017: Colour Fidelity Index for accurate scientific use*. CIE, Vienna: 44 pp.
- Dangol, R., M. Islam, M. Hyvärinen, P. Bhusal, M. Puolakka, and L. Halonen. 2013. Subjective preferences and colour quality metrics of LED light sources. *Lighting Res. Technol.* 45: 666-688.
- Davis, W. and Y. Ohno. 2010. Color quality scale, *Optical Engineering* 49 (3): 16 pp.
- Goodman, T. 2008. Measurement of Naturalness. Presentation at 12<sup>th</sup> IMEKO Man, Science and Measurement Symposium, Annecy, France.
- IES (Illuminating Engineering Society of North America). 2015. *IES TM-30-15: IES Method for Evaluating Light Source Color Rendition*. IES, New York.
- Islam, M., R. Dangol, M. Hyvärinen, P. Bhusal, M. Puolakka, and L. Halonen. 2013. User preferences for LED lighting in terms of light spectrum. *Lighting Res. Technol.* 45: 641-665.
- Jost-Boissard, S., M. Fontoynt, and J. Blanc-Gonnet. 2009. Perceived lighting quality of LED sources for the presentation of fruit and vegetables. *Journal of Modern Optics* 56: 1420-1432.
- Jost-Boissard, S., P. Avouac, and M. Fontoynt. 2015. Assessing the colour quality of LED sources: Naturalness, attractiveness, colourfulness and colour difference. *Lighting Res. Technol.* 47: 769-794.
- Khanh, T., P. Bodrogi, Q. Vinh, and D. Stojanovic. 2017a. Colour preference, naturalness, vividness and colour quality metrics, Part 1: Experiments in a Room". *Lighting Res. Technol.* 49: 697-713.
- Khanh, T., P. Bodrogi, Q. Vinh, and D. Stojanovic. 2017b. Colour preference, naturalness, vividness and colour quality metrics, Part 2: Experiments in a viewing booth and analysis of the combined dataset. *Lighting Res. Technol.* 49: 714-726.
- Khanh, T. and P. Bodrogi. 2018. Colour preference, naturalness, vividness and colour quality metrics, Part 3: Experiments with makeup products and analysis of the complete warm white dataset. *Lighting Res. Technol.* 50: 218-236.
- Livingston, J., M. Royer, L. Whitehead. 2020. *Spectral Similarity as a Measure of Naturalness?* FIRES Forum 11 September 2020.  
<https://www.ies.org/fires/spectral-similarity-as-a-measure-of-naturalness/>
- Royer, M., A. Wilkerson, M. Wei, K. Houser, and R. Davis. 2017. Human perceptions of colour rendition vary with average fidelity, average gamut, and gamut shape, *Lighting Res. Technol.* 49: 966-991.
- Smet, K., W. Ryckaert, M. Pointer, G. Deconinck, and P. Hanselaer. 2010. Memory colours and colour quality evaluation of conventional and solid-state lamps. *Optics Express* 18: 26229-26244.
- Smet, K., W. Ryckaert, M. Pointer, G. Deconinck, and P. Hanselaer. 2011. Correlation between color quality metric predictions and visual appreciation of light sources. *Optics Express* 19: 8151-8166.
- Smet, K., W. Ryckaert, M. Pointer, G. Deconinck, and P. Hanselaer. 2012. A memory colour quality metric for white light sources. *Energy and Buildings* 49: 216-225.
- Smet, K. and P. Hanselaer. 2016. Memory and preferred colours and the colour rendition of white light sources. *Lighting Res. Technol.* 48: 393-411.
- Van Tright, C. 1999. Color rendering, a reassessment. *Color Res. Appl.* 24: 197-206.

# Changes in Color Appearance and Preference of Rose Affected by Color Temperature and Illuminance

YoonJeong Jo <sup>1</sup> and YungKyung Park <sup>2,\*</sup>

<sup>1</sup> Ewha Womans University; jojo33377@ewhain.net

<sup>2</sup> Ewha Womans University; yungkyung.park@ewha.ac.kr

\* Corresponding author: yungkyung.park@ewha.ac.kr

## Abstract

The purpose of this study is to analyze the color appearance and preference evaluation that changes according to the color temperature and illuminance of light sources for rose color and to identify the interaction between color temperature and illuminance accordingly. Five colors of Roses were photographed at chromatic temperatures of 2700K, 3,500K, 5000K, and illuminance levels of 300lx, 600lx, 1000lx, and 1500lx, with a total of 60 stimuli used in the experiment. Results show that, first, the color temperature of the light source influenced the color appearance and preference evaluation of the rose. Second, illuminance influenced the color appearance and preference evaluation of roses. Finally, color temperature and illuminance interacted to affect the color appearance and preference of roses but did not affect roses of all colors. In conclusion, although the color temperature values for color appearance were different for each color of the rose, roses of all colors had the highest preference for illuminance at 1500lx.

**Keywords:** *Rose, Color Temperature, Illuminance, Consumer Evaluation*

## INTRODUCTION

Flowers have many aesthetic properties because they are ornamental plants. Among the aesthetic properties of flowers, color has the greatest impact on consumer purchases (Behe et al. 1999). However, the color of the flowers looks different depending on the lighting environment in the space they display. To see an object, light sources affect its apparent color, which is perceived differently from conventional colors (Wheatley 1973). Previous studies have shown that changing the color temperature of the light changes the rate of wavelengths that enter the object, which has the greatest effect on the color appearance, and that the color temperature suitable for color display varies by object color (Kim et al. 2011). It is also confirmed that the color temperature of lighting in commercial facilities affects the color appearance evaluation of the product and that the color temperature value of suitable lighting that increases color appearance evaluation varies by product (Kim et al. 2011). The illuminance intensity is also closely related to the preference for goods and affects the color appearance of objects. Therefore, the illuminance color temperature and illuminance of the space in which the flowers are displayed should be considered very important. However, there are no specific recommended standards for color temperature and illuminance for flower shops. Therefore, an analysis of the color temperature and illuminance suitable for the color appearance and preference evaluation of flowers should be studied.

Lighting is an essential element in recognizing objects, so appropriate colors or brightness are chosen depending on the purpose or location. Therefore, the color temperature and illuminance of the flower shop lighting are set differently for each space. The space of a flower shop can be divided into three main categories: a display space, a flower refrigerator and a workspace. The space, where flowers are purchased in the flower shop, is very flexible. Therefore, it is necessary to consider all three lighting environments in the space. Previous studies have shown that the display space of the flower shop is 2800K, the refrigerator is 3500K, the workspace is 5000K and 6500K, and that there is a difference in color recognition as the color temperature and illuminance change (Yang et al. 2014).

Therefore, in this work, we tried to verify that the lighting in each space of the flower shop is properly set and to identify the color temperature and illuminance of the lighting that can increase the color appearance and preference. In addition, to promote the purchase of flowers, it is important to identify which of the attributes of the product affect the purchase the most. Previous research has shown that the properties of products displayed in commercial spaces provide a critical clue that affects consumers' perceptions and evaluations, and consumer evaluations serve as the basis for purchasing (Olson and Jacoby 1972). Prior study in Ok and Lee (2005) confirmed that quality, price, design, color, and type of flowers all affect purchasing. Prior research by Behe et al. (1999) stated that the characteristics of flowers that can increase the purchase of flowers include quality, color, shape, scent, and price and that the most influential factor in the purchase is the preference for flower color.

In this study, we checked how the color temperature and illuminance of light sources by rose color affect consumers' color appearance and preference evaluation. Through this study, we would like to propose suitable values of light color temperature and illuminance that are suitable for flower color appearance in flower shop spaces and that can increase consumer preference by the color of flowers.

### **PLANNING EXPERIMENT**

The flower used to stimulate the experiment is a rose. Roses are consumers' favorite flowers (Yue et al. 2009), and because they are cut flowers that consumers usually buy (Park et al. 2014), they were selected as experimental stimuli. Also, roses with monochromatic petals were selected. There are a total of five colors used in the experiment, including Red, Pink, Yellow, White (Lee 2017), and Purple, the order of rose colors most favored by consumers in prior studies. The types of roses that matched the experimental colors were selected. The color of the rose was visually measured using the RHS Colour Chart, and the  $L^*a^*b^*$  value of the rose was measured using a spectrophotometer and shown in Table 1. As a result, the experiment defined Marsha as White, Vital as Red, Soleo as Yellow, Ocean Song as Purple, and Pink Party as Pink.

<b>Experimental Roses</b>	<b>Color</b>	<b>R.H.S</b>	<b>L*</b>	<b>a*</b>	<b>b*</b>
Marsha	White	yellowish white	90.4	-5.2	12.7
Vital	Red	vivid red	33.2	50.7	23.5
Soleo	Yellow	vivid yellow	81.1	9.5	76.3
Ocean Song	Purple	very light purple	71.9	13.1	-4.9
Pink Party	Pink	vivid purplish pink	42.7	64.8	10.2

Table 1: Measurement of experimental roses.

The experimental stimulus was produced by setting the light source conditions of the experiment through the LED Navigator V6.3.7 Permission: LED Cube program, and photographing the roses with a camera. The background of the experimental stimulus was set to N5 ( $L^*=50$ ,  $a^*=0$ ,  $b^*=0$ ). For each lighting situation, a total of 60 experimental stimuli were produced for each rose color, as shown in Figure 1.

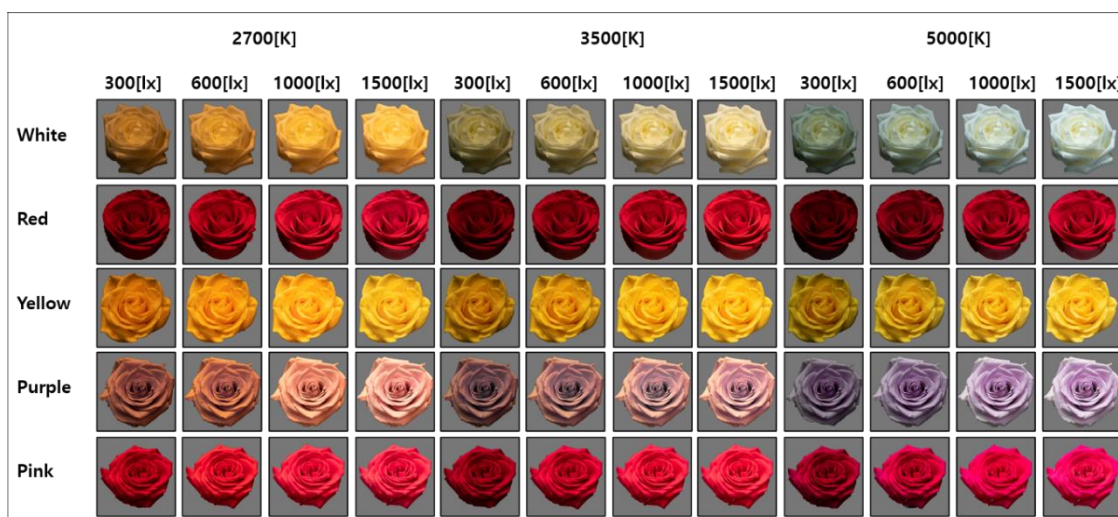

Figure 1: Experimental Stimulus.

The experiment was conducted online, with a total of 40 participants. For gender, 29 women (72.5%) and 11 men (27.5%) participated. The survey progression was presented with 60 experimental stimuli each and then asked to respond to color appearance and preference on a 5 point Likert scale.

## RESULT

One-way Anova was performed to verify that the mean of the experimental variables differs significantly depending on the color of the rose. As a result, we confirmed that there were significant differences in the color appearance ( $F=159.620$ ,  $p<.01$ ) and preference ( $F=37.182$ ,  $p<.01$ ) for each color of the rose. Therefore, we proceeded with the analysis by rose color.

The results of the color appearance and preference analysis according to the color temperature of each rose are as shown in Figure 2. For White roses, the main effect of color temperature was significant in both color appearance ( $F=159.620$ ,  $p<.01$ ) and preference ( $F=17.251$ ,  $p<.01$ ). Therefore, for White rose, the color appearance and preference evaluation were the highest at 5000K and the lowest at 2700K. For Red roses, the main effect of color temperature was significant in both color appearance ( $F=6.062$ ,  $p<.05$ ) and preference ( $F=13.942$ ,  $p<.01$ ). Therefore, for Red rose, the color appearance and preference evaluation were the highest at 2700K and the lowest at 5000K. For yellow rose, the main effect of color temperature was significant in preference ( $F=9.428$ ,  $p<.01$ ), it was not significant in color appearance ( $F=1.549$ ,  $p=.214$ ). Therefore, for yellow roses, both color appearance evaluation and preference evaluation were found to be the highest at a color temperature of 2700K and the lowest at 5000K. For purple roses, the main effect of color temperature was significant in both color appearance ( $F=188.600$ ,  $p<.01$ ) and preference ( $F=43.349$ ,  $p<.01$ ). Therefore, for purple roses, we found that both the color appearance evaluation and preference evaluation had the highest color temperature of 5000K. For pink roses, the main effect of color temperature was significant in both color appearance ( $F=60.682$ ,  $p<.01$ ), and preference ( $F=13.688$ ,  $p<.01$ ). Therefore, we confirm that for pink roses, the color appearance evaluation was the highest at 5000K, and the preference evaluation was the highest at 2700K.



### Changes in Color Appearance and Preference of Rose Affected by Color Temperature and Illuminance

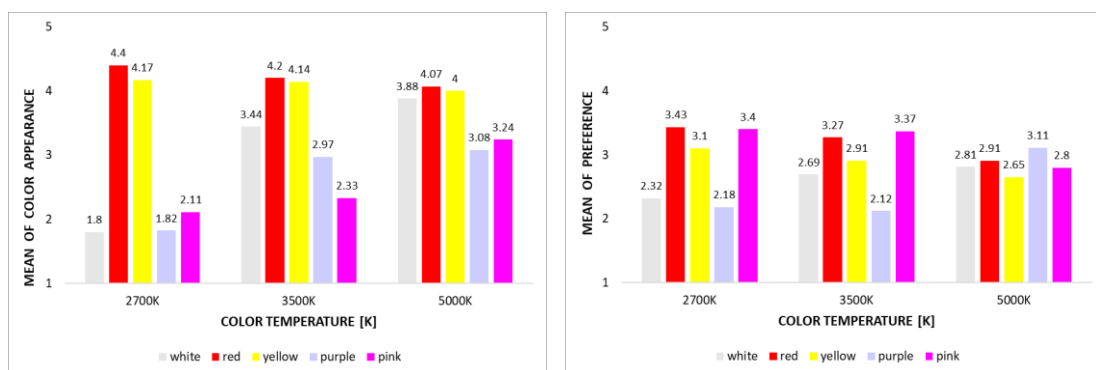

Figure 2: Graph of Color Appearance and Preference Means by Color Temperature by Rose Color.

The results of color appearance and preference analysis according to the illuminance of each rose color are shown in Figure 3. For White roses, the main effect of illuminance was significant in both color appearance ( $F=27.121$ ,  $p<.01$ ) and preference ( $F=196.841$ ,  $p<.01$ ). Therefore, for White rose, we found that all variable evaluations were the highest at 1500lx of illuminance and that all variable evaluations were the lowest at 300lx. For Red roses, the main effect of illuminance was significant in both color appearance ( $F=3.097$ ,  $p<.05$ ) and preference ( $F=51.142$ ,  $p<.01$ ). Thus, for Red roses, the color appearance evaluation was the highest at 600lx, 1000lx, and the lowest at 300lx. We found that both preference evaluations were the highest at 1500lx of illuminance and the lowest at 300lx. For yellow rose, the main effect of illuminance was significant in both color appearance ( $F=23.690$ ,  $p<.01$ ) and preferences ( $F=124.113$ ,  $p<.01$ ). Therefore, both color appearance and preference evaluations were highest at 1500lx of illuminance, and lowest at 300lx. For purple rose, the main effect of illuminance was not significant in color appearance ( $F=1.495$ ,  $p=.215$ ), it was significant in preference ( $F=226.320$ ,  $p<.01$ ). Thus, for purple roses were present, color appearance and preference evaluations were the highest at 1500lx and the lowest at 300lx. For pink roses, the main effect of illuminance was significant in both color appearance ( $F=85.217$ ,  $p<.01$ ) and preference ( $F=3.913$ ,  $p<.05$ ). Therefore, both color appearance evaluation and preference evaluation were highest on 1500lx and lowest on 300lx in the order 1500lx > 1000lx > 600lx > 300lx.

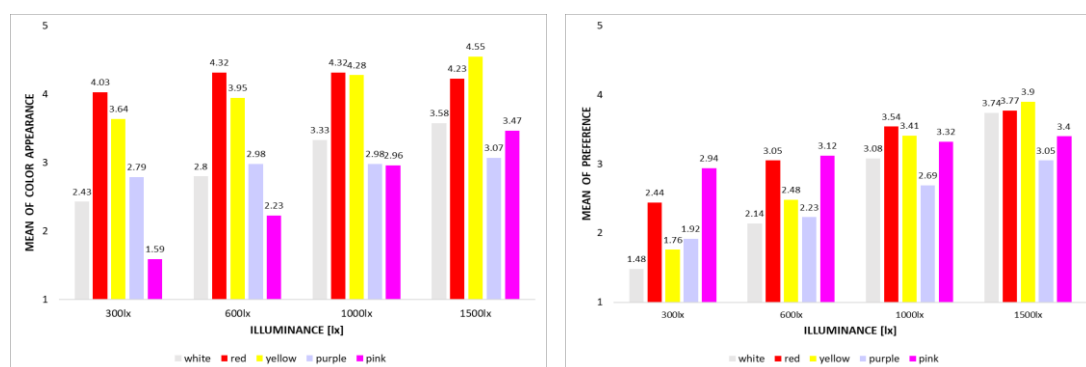

Figure 3: Graph of Color Appearance and Preference Means by Illuminance by Rose Color.

In addition, for White roses, the interaction effects of color temperature and illuminance was significant in both color appearance ( $F=4.677$ ,  $p<.01$ ) and preference ( $F=6.848$ ,  $p<.01$ ). We also found that high illuminance results in highly variable evaluations, and low illuminance results in low variable evaluations. For Red roses, the interaction effects of color temperature and illuminance was not

significant in color appearance ( $F=1.304$ ,  $p=254$ ), it was significant in preference ( $F=3.721$ ,  $p<.05$ ). We also found that all variables are lowest when their illuminance is 300lx at a color temperature of 5000K. For yellow rose, the interaction effects of color temperature and illuminance was not significant in color appearance ( $F=0.144$ ,  $p=.990$ ), it was significant in preference ( $F=1.953$ ,  $p<.1$ ). Therefore, we found that all variables are lowest when their illuminance is 300lx at a color temperature of 5000K. For purple rose, the interaction effect of color temperature and illuminance was not significant in color appearance ( $F=0.231$ ,  $p=.967$ ) and preference ( $F=0.956$ ,  $p=.454$ ). For pink roses, the interaction effects of color temperature and illuminance was significant in color appearance ( $F=2.592$ ,  $p<.05$ ). But it was not significant in preference ( $F=0.094$ ,  $p=.997$ ). Thus, for Pink rose, the preference evaluation means was the highest at 1500lx of illuminance at 2700K, and the lowest at 3000lx of illuminance at 5000K.

## **DISCUSSION AND CONCLUSION**

Through this study, we found how color appearance and preference evaluations change depending on the color temperature and illuminance control of the light source by rose color. In addition, we examined how color temperature and illuminance interact to significantly affect each variable, which identified the relationship between the variables. Since the analysis shows significant differences in rose colors, the results of each hypothesis can be summarized by rose colors as follows:

For white roses, the color temperature and illuminance were shown respectively, showing significant main effects on color appearance and preference. Furthermore, the interaction between color temperature and illuminance was significant across all variables. The experiments showed that both the color appearance and preference of the White rose were rated the highest with a color temperature of 5000K and illuminance of 1500lx. This was consistent with the results of the highest color appearance evaluation at 5000K, which is higher than 2700K and 3,500K in prior work (Yang et al. 2014). However, in the case of illuminance, prior studies showed the best color appearance at 1000lx and the lower the color appearance assessment, but this study showed the highest color appearance assessment at 1500lx. This study conducted an experiment with one rose, but in the previous study, five roses were used, resulting in an area effect, resulting in a difference in the results.

For red roses, the color temperature and illuminance showed significant color appearance and preference, respectively. The interaction between color temperature and illuminance was significant only in preference. In addition, the best evaluation of each variable was shown under different light source conditions. The color boy was rated the highest at a color temperature of 2700K and 600lx of illuminance, consistent with the previous study's result that the red color was the highest at a color appearance at 2800K similar to the experimental color temperature (Kim et al. 2011). This was consistent with the results of prior studies that the sharpness of the red rose increased at 2700K and 3,500K, while the blue wavelength spectrum at 5000K and 6500K added blue to reduce the color appearance of the dark flowers (Yang et al., 2014). Furthermore, this work was consistent with the results that the color appearance evaluation is low when the illuminance level is 500lx or less.

For yellow roses, the main effect of color temperature was not valid in color appearance. This was inconsistent with previous studies suggesting that color temperature affects color appearance when an object is yellow (Kim et al. 2011). Prior work showed that the results of this study were inconsistent in that the experimental stimulus was an object rather than a flower. Color temperature was valid in preference. The main effects of illuminance were also valid for all variables. The interaction between color temperature and illuminance was only significant in preference.

For purple roses, the main effect of color temperature was valid for all variables. The main effects of illuminance were only valid for preference. Furthermore, the interaction between color

temperature and illuminance was not valid for all variables. The color appearance, quality satisfaction, and preference of purple roses were rated the highest at 5,000K, and the preference was rated the highest at 1500lx. This was consistent with the previous study that purple-colored flowers had a higher color temperature of 5000K than 2700K with a higher color temperature (Yang et al. 2014). However, it was inconsistent with prior studies that illuminance affects color appearance evaluation (Lee and Yoon 2019). Therefore, for purple roses, the color vision assessment was only significant at color temperature.

For pink roses, the main effects of color temperature and illuminance were valid for all variables, respectively. The interaction between color temperature and illuminance was only effective in color appearance. The pink rose's color boy was rated highest with a color temperature of 5000K, a preference of 2700K, and all variables were rated highest with an illuminance of 1500lx.

Through this study, we confirmed that the values of light source color temperature and illuminance, which affect color appearance and preference, differ from each rose color. In the case of color temperature, the appropriate color temperature was different depending on the color of the rose. However, both experimental roses were highly rated at high altitudes of 1000lx and 1500lx, and low illuminance of 300lx. Therefore, we confirmed that consumer assessment of flowers was negative at low illuminance levels.

## REFERENCES

- Behe, B., R. Nelson, S. Barton, C. Hall, C., Safley, C. D. and Turner, S. 1999. Consumer preferences for geranium flower color, leaf variegation, and price. *HortScience*, 344: 740-742.
- Kim, K., S. Hong, and A. Choi. 2011. A Study of Method to Improve Color Appearance through the Application of LED Lighting –Focused on Groceries–. *The Korean Society of Living Environmental System*, 185: 590-598.
- Kim, H., Y. Kim, and A. Choi. 2011. A Study on the Subjective Evaluation of Color Appearance under the Different LED CCT Conditions. *Journal of the Korean Institute of Illuminating and Electrical Installation Engineers*, 252: 43-52.
- Lee, W. 2017. Study on a Preference for Flower. *Journal of Korea Floral Art Research Association*, 19: 38-79.
- Ok, J. and J. Lee. 2005. An Analysis of the Factors of Effect to the Consumer's Behaviour in Floral Goods Selection. *Journal of the Korean society of floral art and design*, 12: 137-148
- Olson, J. C. and J. Jacoby. 1972. Cue utilization in the quality perception process. *ACR Special Volumes*.
- Park, K., S. Heo, and S. Choi. 2014. The Consumer Behavior Survey for Ginseng, Green Tea and Flowers. *Korea Rural Economic Institute*, 6: 1-177.
- Wheatley, J. 1973. Putting colour into marketing. *Marketing*, 67: 24-29.
- Yang, E. M., Kang, H. M., Kim, C. S., and C.H. Pak. 2014. Dependence of the color appearance of some flowers on illuminance. *Color Research and Application*, 391: 28-36.
- Yue, C., A. Rihn, B. Behe, and C. Hall. 2009. Consumer preference for flowers as gifts: Age segments, substitutes, and perceived risk. *American Floral Endowment*, Alexandria, VA.

# Effect of the shade due to the surface unevenness of objects on whiteness perception

Ichiro Katayama <sup>1,\*</sup> and Kin'nosuke Yamaji <sup>2</sup>

<sup>1</sup> Kindai University; katayama@waka.kindai.ac.jp

<sup>2</sup> Graduate School of Kindai University; 2033730007p@waka.kindai.ac.jp

\* Corresponding author: katayama@waka.kindai.ac.jp

## Abstract

This study measured the subjective equivalent luminance of the whiteness of plaster samples with regularly arranged unevenness on their surfaces illuminated with constant illuminance to determine the effects of shading caused by the surface unevenness of white objects on whiteness perception. As a result, the subjective equivalent luminance was about 5% to 20% higher than the average luminance of the sample, and white objects with uneven surfaces were perceived to be brighter and whiter than their average luminance. This is thought to be because a low-luminance area of the object surface is perceived not as a low-reflectance area but as a shaded area caused by the unevenness of a uniform high-reflectance surface. In addition, it became clear that the subjective equivalent luminance is strongly influenced by the highlighted parts caused by the surface unevenness of objects.

**Keywords:** *whiteness, object, surface unevenness, shade*

## INTRODUCTION

White-colored goods, such as white paper and fabrics, are evaluated based on the degree of their whiteness. The quantification of whiteness has been practiced since the 1930s: Katayama (2019). However, few studies have been conducted to determine how the shade created by the surface unevenness of white objects affects the perception of their whiteness: Lin et al. (2012). Previously, it was elucidated that whitish, textured images generated by luminance modulation are perceived to be brighter than the average luminance and are whiter and that the highlights of the image have a strong effect on whiteness perception: Katayama et al. (2020). In this study, plaster samples on which surface unevenness was intentionally created were used to examine how whiteness perception would be influenced by the shade created by surface unevenness.

## EXPERIMENTAL EQUIPMENT AND METHODS

A plaster sample with an uneven surface (standard stimulus) and a plaster sample with a smooth surface (comparison stimulus) were juxtaposed across a partition wall in an observation box painted with an achromatic color equivalent to N7, and each was illuminated with an independent white LED light source (correlated color temperature: 7800 K) in the box. All lights were turned off during the experiment, except for the LED light sources illuminating the stimuli. The observers were asked to adjust the illuminance of the comparison stimulus so that its whiteness became equal to that of the standard stimulus illuminated at a constant illuminance, and the luminance of the comparison stimulus at that point (subjective equivalent luminance) was recorded. Six types of standard stimuli were prepared: three types with convex areas (convex 1SR2, convex 0.5SR2, and convex 0.5 triangular pyramid) and three types with concave areas (concave 1SR2, concave 0.5SR2, and concave 0.5 triangular pyramid). The unevenness of each sample was a regular pattern in horizontal and vertical directions. The specifications and appearance of the presented standard stimuli are shown in Figures 1 and 2, respectively. The luminous reflectance of the standard and comparison stimuli was 92%, each was a square of 50 mm per side, and they were held at 30° to the vertical direction. Figure 3 shows the luminance histogram of each standard stimulus. The luminance distribution was obtained using a

Effect of the shade due to the surface unevenness of objects on whiteness perception hyperspectral camera (NH3-KDK, EBA Japan). The vertical dashed line in the figure shows the average luminance. In Figure 3, the standard stimuli are composed of various luminance components centered on the average luminance.

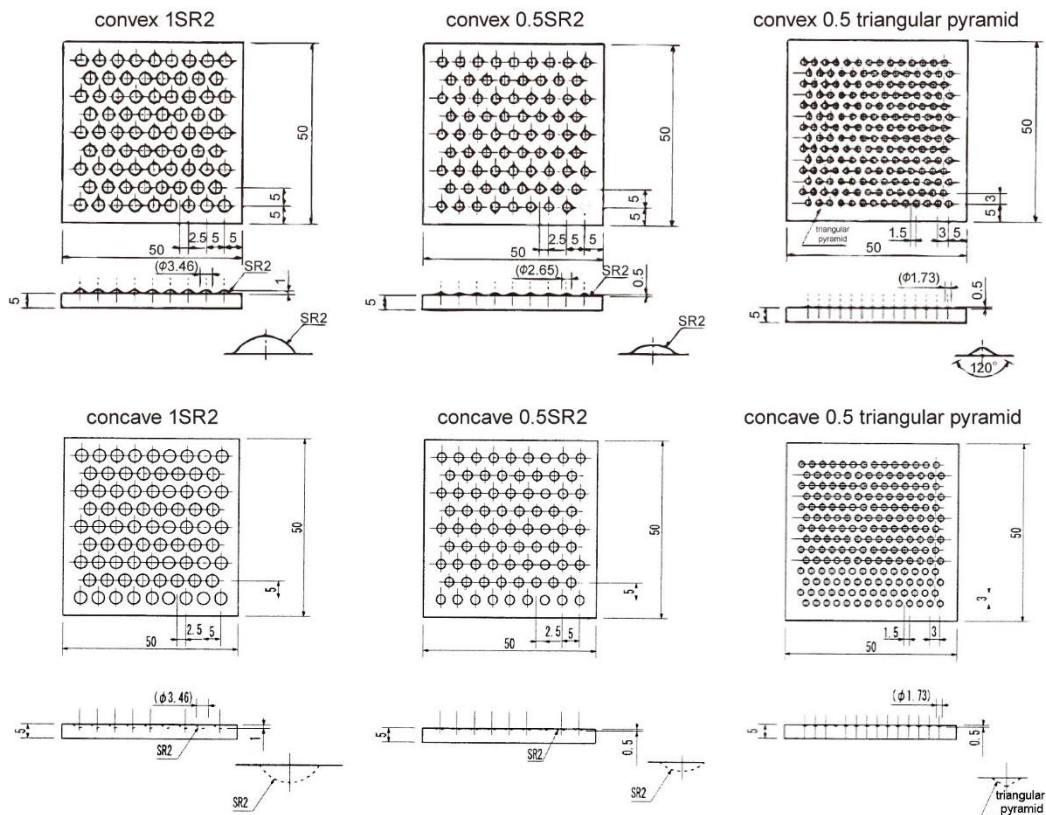

Figure 1: Specification of each standard stimulus.

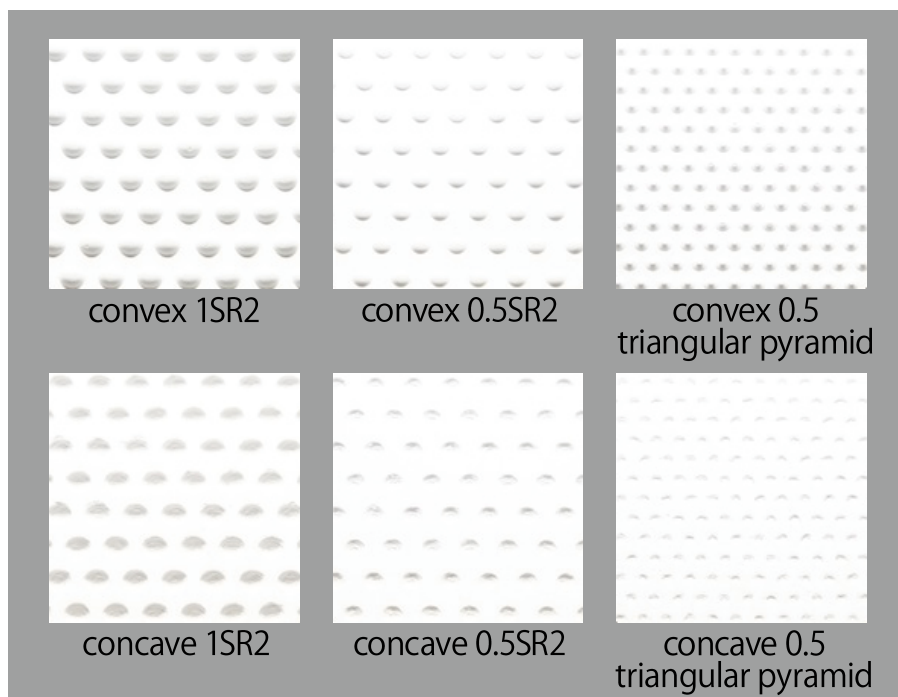

Figure 2: Appearance of each standard stimulus.

Effect of the shade due to the surface unevenness of objects on whiteness perception

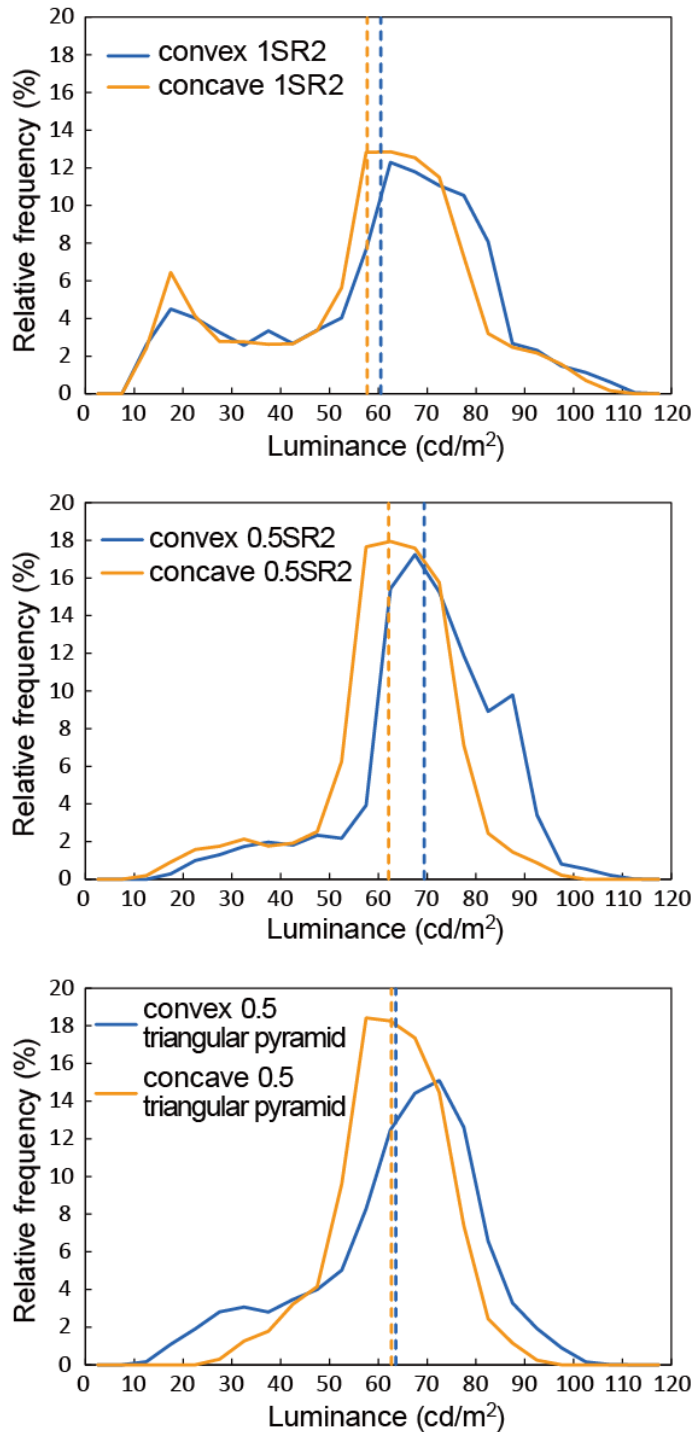

Figure 3: Luminance histogram of each standard stimulus.

The observers observed the stimuli at a distance of 60 cm with a binocular natural vision. Both standard and comparison stimuli were held so that the center of the stimulus was positioned at approximately the same height as the observer’s eyes. The subjective equivalent luminance was measured eight times for each of the six types of standard stimuli. The spatial order (left-right arrangement) of the standard and comparison stimuli was switched after four measurements. The six types of standard stimuli were presented in random order among observers. As a control experiment, the subjective equivalent luminance was measured under the same conditions using the comparison stimulus (plaster sample with a smooth surface) as the standard stimulus. The observers were a total

Effect of the shade due to the surface unevenness of objects on whiteness perception of 10 males and females in their 20s with normal color vision and normal visual acuity (including corrected vision).

## RESULTS AND DISCUSSION

Statistical tests of the difference between the average luminance of the standard stimuli and the average value of the subjective equivalent luminance (Welch's method of ranked t-test) showed a significant difference at the 1% level for all standard stimuli. In the control experiment using a plaster sample with a smooth surface as the standard stimulus, no significant difference was observed between the average luminance of the standard stimulus and the average value of the subjective equivalent luminance. This suggested that the difference between the subjective equivalent luminance and the average luminance was caused by the surface unevenness of the object.

Subsequently, the ratio of the subjective equivalent luminance to the average luminance of each standard stimulus was calculated. Figure 4 shows that the subjective equivalent luminance is 5% to 20% higher than the average luminance of the standard stimuli and that white objects with uneven surfaces are perceived to be brighter and whiter than their average luminance. The results indicated that the low-luminance areas of the standard stimuli are perceived not as low-reflectance surfaces but as high-reflectance surfaces under low illuminance: Adelson (1993), Kingdom (2011). Figure 5 shows the standard deviation of the luminance of each standard stimulus. The comparison between Figures 4 and 5 showed that a stimulus with a larger standard deviation of the luminance tends to have a higher subjective equivalent luminance than its average luminance. A significant correlation was found at the 5% level between the ratio of the subjective equivalent luminance to the average luminance of the standard stimuli and the standard deviation of the luminance of the standard stimuli (Figure 6). The results suggested that surfaces containing relatively more high-luminance components (highlighted components) are perceived to be brighter and whiter and that low-luminance components (shading components) have lesser effects on the subjective equivalent luminance.

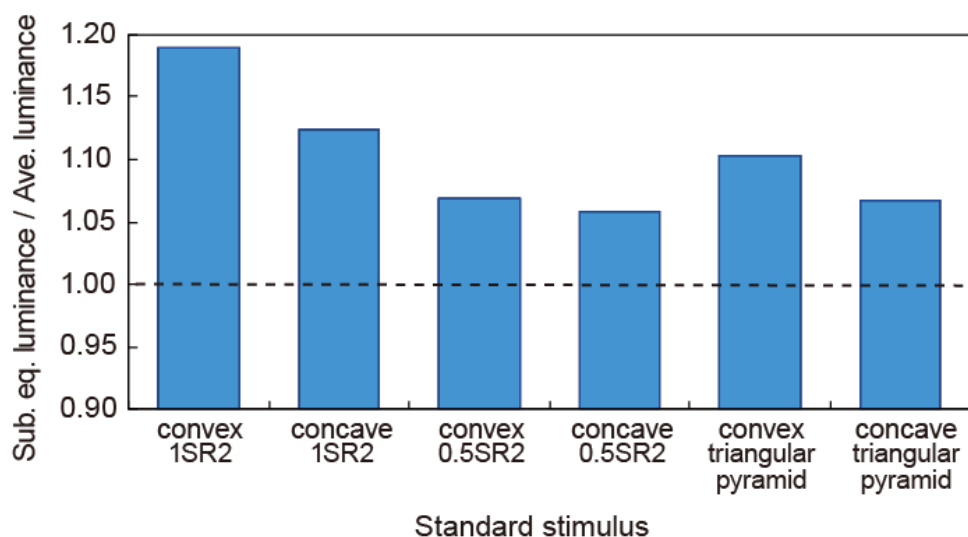

Figure 4: Ratio of the subjective equivalent luminance to the average luminance of each standard stimulus.

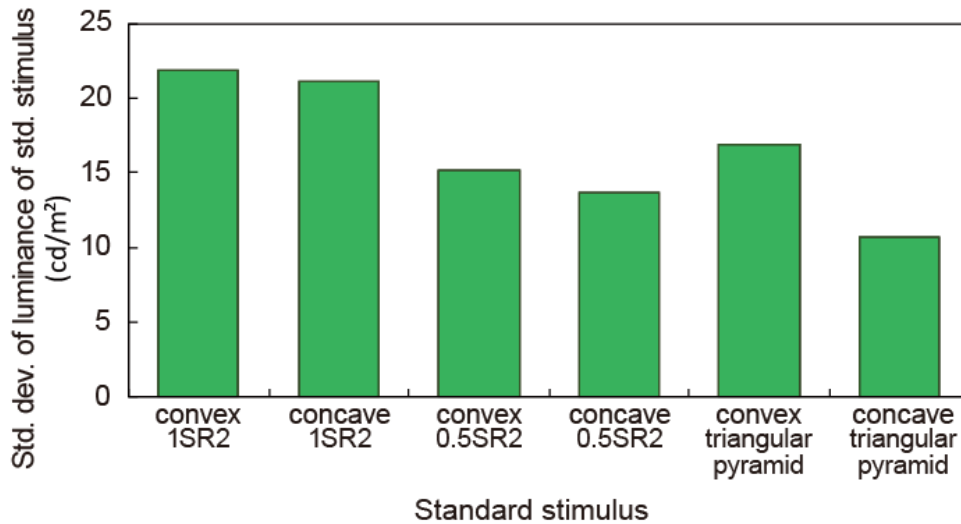

Figure 5: Standard deviation of the luminance of each standard stimulus.

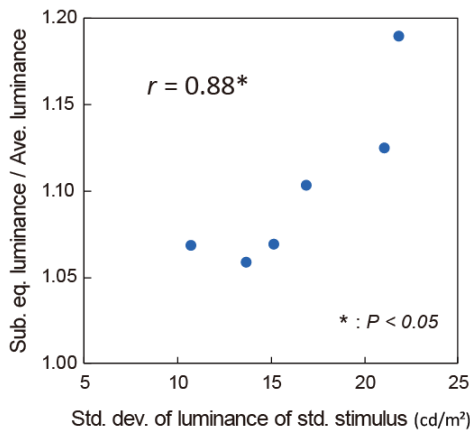

Figure 6: Relationship between the ratio of the subjective luminance to the average luminance and the standard deviation of the luminance.

## CONCLUSIONS

This study revealed that, as in approximate white images with textures expressed by luminance modulation, the surfaces of real objects with shading (luminance distribution) caused by regularly arranged unevenness are perceived to be brighter and whiter than their average luminance. This is thought to be because the low-luminance area of the surface is perceived not as a low-reflectance area but as a low-illuminance area caused by the unevenness of a uniform high-reflectance surface. Furthermore, because surfaces containing relatively more high-luminance components were perceived to be brighter, it became clear that the subjective equivalent luminance was strongly influenced by the highlighted parts caused by the surface unevenness of objects and not much influenced by the low-luminance parts.



## **ACKNOWLEDGEMENTS**

This work was supported by JSPS KAKENHI Grant Number JP18K11511.

## **REFERENCES**

- Adelson, E. H. 1993. Perceptual organization and the judgment of brightness. *Science* 262: 2042-2044.
- Katayama, I. 2019. Performance Comparison of Various Whiteness Formulas Based on Visual Evaluation Experiments. *Journal of Science and Technology in Lighting* 43: 7-17.
- Katayama, I., K. Yamaji, S. Nishi, and M. Doi. 2020. Effect of texture on whiteness perception. In: *AIC 2020 Natural Colours – Digital Colours, Proceedings of the Interim Meeting of the International Colour Association*, 324-328.
- Kingdom, F. A. A. 2011. Lightness, brightness and transparency: A quarter century of new ideas, captivating demonstrations and unrelenting controversy. *Vision Research* 51-7: 652-673.
- Lin, J., R. Shamey, and J. Trussell. 2012. The effect of texture on perception and measurement of whiteness. *AATCC Review* March/April: 61-68.

# Perceived attractiveness across Chinese and Pakistani ethnic groups

Muhammad Farhan Mughal <sup>1</sup>, Ming Ronnier Luo <sup>1,2, \*</sup> and Michael Pointer <sup>2</sup>

<sup>1</sup> State Key Laboratory of Modern Optical Instrumentation, Zhejiang University, Hangzhou, China; farhan@zju.edu.cn

<sup>2</sup> School of Design, University of Leeds, Leeds, UK; m.r.luo@zju.edu.cn

\* Corresponding author: m.r.luo@zju.edu.cn

## Abstract

In perceptual science, many factors contribute to a face being considered attractive. Previous studies have shown that attractive faces are perceived as belonging to people who are cooperative, sociable, likeable, healthy, etc. Also, facial feature geometry has been shown to have a significant role in the overall perception of the face. In this work, a psychophysical experiment was conducted that used Chinese and Pakistani facial images and observers. A new model is proposed to correlate the data relating to the attractiveness of the Chinese and Pakistani faces and to compare the data with previous models of symmetry, golden ratio, neoclassical canons and their combination. Also, the differences were evaluated between the results from Chinese and Pakistani observers. It was found that the new model performed better than existing models and the ethnic group difference was quite reasonable.

**Keywords:** *Attractiveness, model, symmetry, golden ratio, neoclassical canons, ethnic group difference.*

## INTRODUCTION

Attractiveness is the most widely studied impression investigated, amongst all the visual impressions (Jones, A., 2019, Pallett P.M., 2010, Schmid, K., 2008) including sociable, friendly, mature, cooperative. Griffin and Langlois (2006) found a strong connection between attractiveness and other visual impressions. Based on the above, the authors Mughal, Luo and Pointer (2020) conducted two psychophysical experiments by varying eight individual facial features: eye vertical position, eye horizontal position, eye size, nose length, nose width, lips thickness, lips width and lips position. The first experiment was to define the visual impression variables. The experiment was conducted using Chinese and Pakistani facial images from the Leeds and Liverpool Skin Colour (LLSC) dataset. For each facial feature, facial images were rendered by up to four magnitudes, e.g., very small, small, medium, large, very large mouth sizes. Observers rated each image in terms of yes/no (attractive or unattractive). Sixteen visual impression scales were investigated in Experiment 1 (sociable/unsociable, cooperative/uncooperative, easy-going/fussy, relaxed/tense, careful/careless, imaginative/unimaginative, attractive/unattractive, lively/dull, active/passive, mature/immature, feminine/masculine, healthy/unhealthy, likeable/dislikeable, elderly/young, intelligent/stupid and natural/unnatural). After or analysis, three factors (designated as attractive/unattractive, feminine/masculine and mature/immature) were found to best represent the sixteen visual impressions. Models were developed to predict attractiveness and it was found the model performed better when facial features were measured with respect to the length and width of the face. The results were compared with those of the model of symmetry, golden ratio and neoclassical canons.

The above results were based on individual facial features. To repeat this for the full face, three models of symmetry, golden ratio and neoclassical canons were implemented to predict the visual impressions from the facial images. A further model given by Schmid, Marx and Samal (2008) was a combination of symmetry, golden ratio, and neoclassical canons. A model is also proposed that uses the measurements of facial feature ratios with respect to the length and width of the face.

The two main goals of the study were:

- to develop a model by measuring multiple facial feature ratios with respect to length, width or area of the face,
- to compute the impact of ethnic group differences on Chinese and Pakistani facial images,

## **METHOD**

### **Participants**

In total, 36 observers were recruited for the experiment. Out of the 36, 19 were Chinese (10 Male + 9 Female) and 17 Pakistani (10 Male + 7 Female). All the participants were students at Zhejiang University, China. The age range of the Chinese observers was between 23 and 27 years, with a standard deviation of 3.12 years. The age range of the Pakistani observers was between 24 to 31 years, with a standard deviation of 2.36 years.

### **Stimuli**

78 Chinese facial images (34 from the LLSC dataset and 44 from the internet) and 40 Pakistani facial images (7 from the LLSC dataset and 33 from the internet) were used as stimuli for the experiment.

### **Procedure**

The experiment was conducted using an Eizo GM-243W LCD display located in a dark room. The display had a screen diagonal of 24.1 inches and a native resolution of 1920 x 1200 pixels. The peak white of the display was set at the chromaticity of CIE illuminant D65 and a luminance of 100 cd m<sup>-2</sup>. The luminance uniformity was approximately 8% deviation from the centre of the screen to the corners. An image processing procedure was used for each image, firstly, to convert each pixel of the LLSC facial image from camera RGB values to CIE XYZ tristimulus values via a camera characterisation model given by Hong, Luo and Rhodes (2001).

The LLSC images were transformed to XYZ via a 3×11 polynomial camera characterisation model developed by Hong, Luo and Rhodes (2001). The RGB values of the internet images were transformed to XYZ tristimulus values using the sRGB equation and CIE D65 illuminant. Secondly, the XYZ values were transformed to monitor RGB values using the GOG monitor characterisation model (Berns R.S., 1996). The performance of the monitor model was evaluated using the 24 colours in the Macbeth ColorChecker Chart. The Luo, Cui and Rigg (2001) average colour difference was approximately one CIEDE2000 unit. The experiment was designed in two parts to include images from the two datasets, LLSC and internet, respectively.

The observers were asked to rate each image on a scale of -3 to +3 with no "0" in-between: -3 represented least attractive and 3 most attractive.

### **Measuring the Faces**

After the experiment was finished and experimental data was obtained, the four previous models: symmetry, golden ratio, neoclassical canon and their combination were implemented. Then a new model was constructed by measuring facial features with respect to the dimensions of the face.

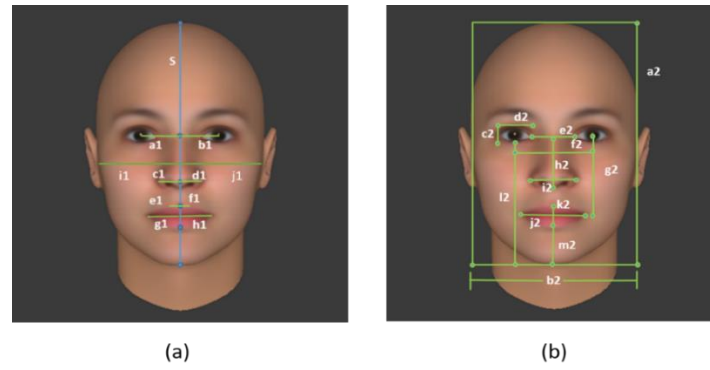

Figure 1: Method of measuring the face (a) symmetry (b) all the other methods.

Figure 1(a) shows the symmetry measures of the eyes, nose and lips in a facial image. A vertical axis "S" was obtained by joining the points from the top to the bottom of the face. This axis is called the axis of symmetry. The distances  $d_L$  and  $d_R$  represent the distances of the various features from the left and right of the axis of symmetry. The symmetry is calculated by Eq. (1).

$$Symmetry\ measure = \frac{|d_L - d_R|}{(d_L + d_R)} \quad (1)$$

According to this definition, symmetry of the eye, nose, lips and full face are defined by  $(|a1-b1|)/(a1+b1)$ ,  $(|c1-d1|)/(c1+d1)$ ,  $(|g1-h1|)/(g1+h1)$ , and  $(|i1-j1|)/(i1+j1)$ , respectively (see Figure 1a).

The golden ratio was measured by calculating the distance between the ratio of the facial feature and 1.618 (so-called golden ratio). The ratios of facial features included mouth width to the inter-ocular distance ( $j2/e2$ ), mid-eye distance to interocular distance ( $f2/e2$ ), the mid-eye distance to nose width ( $f2/i2$ ), mouth width to nose width ( $j2/i2$ ), the interocular distance to the thickness of the lips ( $e2/k2$ ), and the nose width to the thickness of the lips ( $i2/k2$ ) (Figure 1b). Neoclassical canons include face width equal to four-times nose width ( $b2 = 4 \times i2$ ); lips width equal to 1.5 times the nose width ( $j2 = 1.5 \times i2$ ); interocular distance equal to nose width ( $e2 = i2$ ) (Figure 2). Schmid, Marx and Samal (2008) suggested the above rules calculate ratios of symmetry, golden ratio, and neoclassical canons from facial images. Table 1 lists the definition of each facial feature according to the new model.

No.	Facial Feature	Facial Ratio Measurements	Definition (Figure1)
1	eye vertical position	eye-chin distance to face length	$e3 / a3$
2	eye horizontal position	interocular distance to face width	$f3 / b3$
3	eye size	eye area to face area	$(c3 \times d3) / (a3 \times b3)$
4	nose length	nose length to face length	$g3 / a3$
5	lips thickness	lips thickness to face length	$i3 / a3$
6	lips position	Lips chin distance to face length	$k3 / a3$

Table 1: Method to measure according to the new model.

### Implementing models

From a previous study of Mughal, Luo and Pointer (2020), it was found that Chinese and Pakistani attractiveness depends upon four different facial features. For Chinese faces, the four features are eye vertical position, eye horizontal position, eye size and lips position. For Pakistani faces, the four parameters are eye vertical position, nose length, lips thickness and lips position.

All five models were implemented using Matlab software. The method used to obtain the coefficients was Quantum Particle Swarm Optimization (QPSO). It recursively optimizes the result of a mathematical equation. Garcia, Huertas, Melgosa and Cui (2007) metric standard residual sums of square (STRESS) was used to minimize the difference between the output of the equation and the experimental data. The equation used for the optimization is given by Eq. (2)

$$T = a_1F_1 + a_2F_2 + a_3F_3 + a_4F_4 + C \quad (2)$$

where  $a_1$  to  $a_4$  are the coefficients to be optimized and  $F_1$  to  $F_4$  are the facial features,  $C$  is a constant. The STRESS is defined by Eq. (3)

$$STRESS = \left( \frac{\sum_{i=1}^n (A_i - FB_i)^2}{\sum_{i=1}^n F^2 B_i^2} \right)^{1/2} \times 100 \quad (3)$$

with  $F = \sum_{i=1}^n A_i^2 / \sum_{i=1}^n A_i B_i$ , where  $n$  is the number of sample pairs and  $F$  is a scaling factor to adjust  $A$  and  $B$  data sets on to the same scale. The STRESS value always lies between 0 and 100. Zero STRESS value indicate perfect agreement between two datasets.

## RESULTS AND DISCUSSIONS

The five models implemented were symmetry, golden ratio, neoclassical canons, their combination and the new model. The results were evaluated in terms of STRESS and correlation coefficient ( $R$ ). It was found that the new model performed better than the previous models.

Table 2 lists the result both in terms of correlation coefficient and the STRESS values in  $R$ /STRESS format. The STRESS values of the combination model and new models are the same as that of a new model. This shows that the Pakistani faces combination model is also one of the best models.

Models	Chinese	Pakistani
Symmetry	0.37/33	0.31/32
Golden Ratio	0.51/31	0.39/31
Neoclassical Canons	0.40/33	0.38/31
Combination	0.60/28	0.56/28
New Model	0.69/26	0.58/28

Table 2: Results of performances of Models.

The ethnic group difference was also evaluated by measuring the  $R$ -values between the Chinese and Pakistani observers while observing (i) Chinese faces and (ii) Pakistani faces. It was found that the  $R$ -values between the Chinese and Pakistani observers while viewing Chinese face was 0.72 and 0.66 for Pakistani faces, respectively. These values are considered reasonable indicating a reasonable agreement between the two groups of the observers.

## CONCLUSIONS

It was found that to model the attractiveness of Chinese and Pakistani faces it is better to measure the facial feature ratios with respect to the length and width of the full face. This approach proved better than the model of symmetry, golden ratio, neoclassical canons and their combination model.

The second goal was to determine the difference between Chinese and Pakistani observers and it was found to be a minimum for both the Chinese and Pakistani faces.

## REFERENCES

- Berns, R.S. 1996 Methods for characterising CRT displays. *Displays* 16:173-182.
- Garcia, P.A., R. Huertas, M. Melgosa, and G. Cui. 2007 Measurement of the relationship between perceived and computed color differences. *JOSA A* 24:1823-1829.
- Griffin, A.M., J.H. Langlois. 2006 Stereotype directionality and attractiveness stereotyping: Is beauty good or is ugly bad? *Social cognition* 24:187-206.
- Hong, G., M.R. Luo., P.A. Rhodes. 2001 A study of digital camera colorimetric characterisation based on polynomial modeling. *Color Research & Application* 26:76-84.
- Jones, A.L., B. Jaeger. 2019. Biological bases of beauty revisited: The effect of symmetry, averageness, and sexual dimorphism on female facial attractiveness. *Symmetry* 11: 279.
- Luo, M.R., G. Cui., B. Rigg. 2001 *The development of the CIE 2000 colour-difference formula: CIEDE2000. Color Research & Application* 26:340-350.
- Mughal, M.F., M.R. Luo., M. Pointer. 2020 Modelling visual impressions for Chinese and Pakistani ethnic groups. *Pattern Recognition* 2020:107259.
- Pallett, P.M., S. Link, K. Lee. 2019 New "golden" ratios for facial beauty. *Vision Research* 50: 149-154.
- Schmid, K., D. Marx, A. Samal. 2008 Computation of a face attractiveness index based on neoclassical canons, symmetry, and golden ratios. *Pattern Recognition* 41:2710- 2717.



# The Valence and Arousal contribution of colour parameters

Tzuhao Liu <sup>1</sup>, John Hutchings <sup>2</sup>, and Ming Ronnier Luo <sup>1,2,\*</sup>

<sup>1</sup> State Key Laboratory of Modern Optical Instrumentation, Zhejiang University; Hangzhou, China; winston\_liu@zju.edu.cn, m.r.luo@zju.edu.cn

<sup>2</sup> School of Design, University of Leeds, UK; johnb.hutchings@btinternet.com

\* Corresponding author: m.r.luo@zju.edu.cn

## Abstract

Previous studies found that music emotion can be expressed well by valence and arousal. In addition, music can be expressed by static and dynamic colours. The goal of this study is to evaluate people's emotions resulting from audio using a number of emotion terms including 'Valence' and 'Arousal'.

From the results of our earlier experiments about colour and music emotion, 'Joy' and 'Intensity' were extracted from 25 perceptions that can be used to describe music emotions.

In this experiment, the same music pieces were used, and subjects were asked to judge them using 13 scales, including 'Valence' and 'Arousal'. According to the factor analysis in this experiment, the scales of 'Valence' and 'Arousal' were both located in the factor of Joy. This indicates that in this experiment, the 2 scales cannot be used to explain the colour parameters well since the two sets of data were too close.

**Keywords:** *colour emotion, musical emotion, emotional space*

## INTRODUCTION

In the past research on music and colour emotion, the dimensions of 'Valence' and 'Arousal' were frequently used to evaluate people's emotions. This was first proposed by Mehrabian and Russell (1974), who concluded that human emotions can be described from three dimensions, 'Valence' (or 'Pleasantness'), 'Arousal', and 'Dominance'. This was called the PAD model. They later (1980) showed that the first two dimensions of the PAD model are sufficient to explain most of the self-reported differences in emotional state. Zhang et al. (2019) used these 2 scales to study the emotion prediction based on the recognition of physiological signals and music features, while Whiteford et al. (2018) introduced these 2 scales to reveal the contribution rate of emotion to colour dimensions, such as  $L^*$ ,  $C^*$ , and hues. The present experiment was designed to understand the relationship between colours and the dimensions of 'Valence' and 'Arousal' (hereafter referred to as V-A emotional space), and to compare the results to the related studies.

In Whiteford et al.'s study (2018), subjects were asked to evaluate the lightness, chroma, and hue of 37 Munsell colour samples. The subjects then evaluated 40 different styles of music clips by V-A emotional space, and choose the three most matching colours for each piece of music. Finally, the link between the colour parameters (lightness, chroma, hue) and the V-A emotional space was determined.

From the authors' previous experiment (2020), the colour data obtained from the 13 music pieces were collected to establish associations between music and colour emotion. Factor analysis indicated that 2 factors, named 'Joy' and 'Intensity' respectively, were sufficient to explain emotions aroused by the music. Finally, 4 modes of colour sequence were then designed, showing cool and warm sequences representing emotions of 'Joy+' and 'Joy-'.

In the present study, a new model similar to that of Whiteford et al. (2018) was used to predict colour in terms of lightness, chroma, yellow-blue, and red-green signals. The results from the both models were compared. Using these models, the contribution of 'Valence' and 'Arousal' to the colour parameters (lightness, chroma, and hue) can be understood.



## EXPERIMENT

The present experiment was performed in a dark room. Six subjects were invited to join the task, their average age was 24.8 and the standard deviation was 1.07. All the six subjects had musical backgrounds (learned vocal music or musical instruments for more than ten years).

Before the experiment, subjects were allowed a 60-second environmental adaptation using the same viewing conditions as the earlier experiment. The background colour of the experimental panel was set to medium grey ( $L^* = 50$ ).

The subjects first listened to the music for 1 minute. They then made a subjective evaluation of each music piece using a total of 13 judgements. These scales included the 11 evaluation scales used in the previous experiment (warm-cool, hard-soft, heavy-light, happy-sad, agitated-calm, active-passive, strong-weak, large-small pitch variation, dense-sparse, like-dislike, bright-dark) as well as valence and arousal. The degree of judgement for each adjective ranged from -3 to 3, i.e., -3 and 3 mean "extremely", while -1 and 1 mean "slightly", and there was no neutral answer for the subjects to choose.

There were in total 13 pieces of music, which were same as used in the first two experiments. Two of these pieces were randomly selected and repeated, so there were a total of 15 randomly presented musical stimuli for each subject. The purpose of the repeats was to confirm the stability of the subject's data.

## RESULTS

This study forms the third part of a colour and music emotion project. In this section, the results of the three experiments, including this study and the first two experiments by Liu et al. (2020), were compared. The 3 experiments are hereafter named Experiments 1, 2 and 3.

### 1. Data analysis

The data stability of each subject was first analysed. For the two random pieces of music repeated in Experiment 3, the consistency of the data for each subject was calculated. The results are shown in Table 1. It can be seen that the results of the two evaluations agreed well (correlation coefficient higher than 0.7).

subject number	1	2	3	4	5	6
r	0.792	0.826	0.723	0.801	0.743	0.783

Table 1: The data stability of each subject

The data consistency between the experiments was then analysed. The consistency of the 11 evaluation scales between Experiments 2 and 3 is shown in Figure 1. Each point represents the average data of an evaluation index of all subjects for a piece of music. For example, if the scale 'Active' of the music piece 'F Major' had an average score of 2.1 in Experiment 2 and average score of 2.5 in Experiment 3, the coordinates of the point will be (2.1, 2.5). It was found that the results of the 11 common scales between the two experiments agreed well ( $R^2 = 0.832$ ).

The data consistency of each scale in the experiments was also calculated, as shown in Table 2. It can be seen that the results are similar except for the 'Heavy' and 'LPV' (large-small pitch variation) scales. It can be inferred that these 9 scales are suitable for music evaluation.

	Experiment 1 & 2	Experiment 2 & 3
Active	0.958	0.940
Happy	0.970	0.915
Strong	0.965	0.879
Agitated	0.736	0.773
Warm	0.904	0.866
Hard	0.808	0.754
Bright	0.950	0.852
Dense	0.964	0.939
Heavy	0.360	0.512
LPV	0.640	0.625
Like	0.776	0.776

Table 2: The  $R^2$  value of different scales between experiments.

Figure 1: The consistency of different scales between Experiments 2 &amp; 3.

## 2. Colour modelling

The contributions of 'Valence' and 'Arousal' to the colour parameters were then calculated.

Using data from Experiment 1, colours corresponding to each piece of music were obtained. The colour data were then transformed to the CIELAB colour space (2019), and the lightness, chroma, and hue of each piece of music were obtained. In order to compare with the model of Whiteford et al. (2018), the hue angle of colours was transformed to hue composition, red-green and yellow-blue, using the CAM16 model by Li et al. (2016).

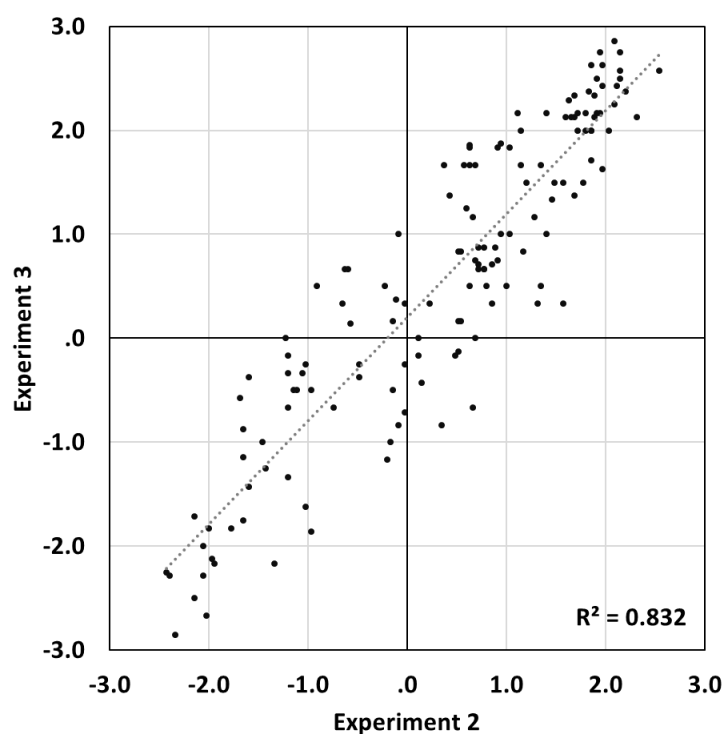
The relationship between the V-A emotional space and colour dimensions was established using the multiple linear regression (MLR). Figure 2(a) shows the results for colour dimensions of lightness, chroma, red-green, and yellow-blue. The variance is denoted by the  $R^2$  value of each MLR equations, and the contribution of 'Valence' and 'Arousal' was determined by the coefficients in each equation. The Whiteford et al. (2018) results are shown in Figure 2(b). The bar graph was given from their paper, but the exact explanation rate for each colour dimension was not given there. Figure 2 shows the contributions of Valence and Arousal emotions to chroma, lightness, red-green, and yellow-blue perceptions.

For chroma in Figure 2(a), the contributions of 'Valence' and 'Arousal' from the present results were nearly equal, explaining more than 96.0% of the data. Lightness was almost entirely contributed to by arousal, explained by 84.6% of all data. These are different from the Whiteford et al.'s results. In Figure 2(b), the contribution of 'Valence' was about 3 times that for 'Arousal' in saturation, while for lightness, the contributions of the two scales were nearly equal.

Regarding the contribution of emotional space to hue, the total explanation rates of red-green and yellow-blue were 40.4% and 80.6%, respectively. The results clearly showed in Figure 2(a) that most of the hue component was contributed by the dimension of 'Valence', while 'Arousal' contributed minimally. This is inconsistent with the results in Figure 2(b), showing that there was a discrepancy between the results of this study and that of Whiteford et al.

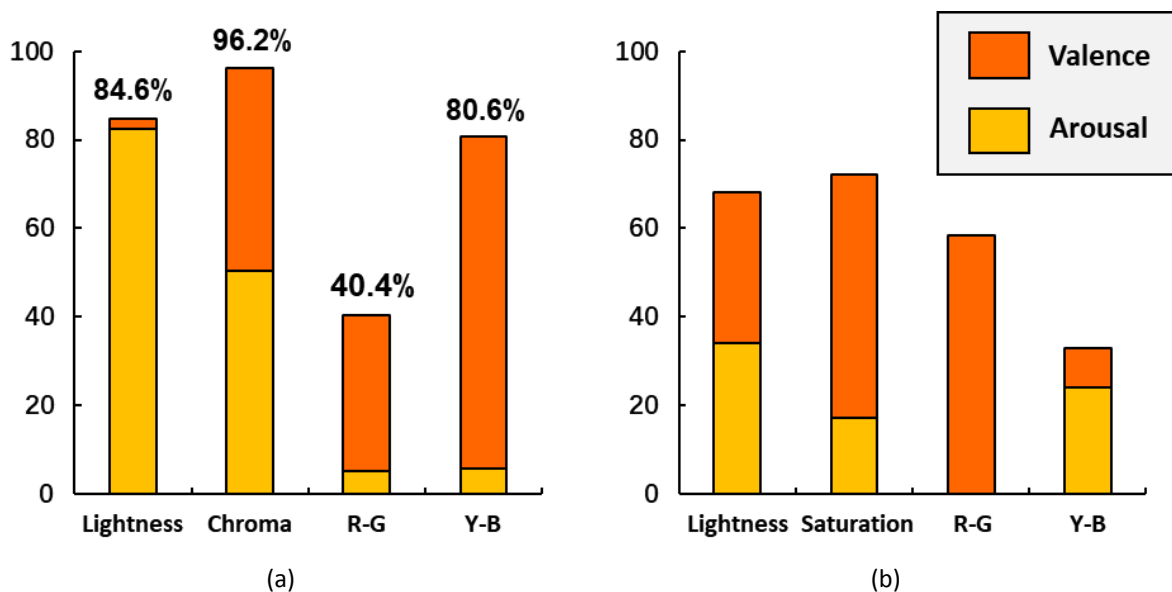

Figure 2: The variance explained by Valence and Arousal (a) this study (b) results of Whiteford et al. (2018).

### 3. Factor analysis

Factor analysis was conducted on the 12 scales, that of 'like-dislike' being removed. The results are shown in Figure 3. The scales were grouped into two factors, organized as follows:

- Factor 1 interpreted as 'Joy' contained the scales 'active', 'happy', 'bright', 'Valence', 'warm', 'Arousal', and 'strong'.
- Factor 2 interpreted as 'Intensity' contained 'hard', 'LPV', 'agitated', 'dense', and 'heavy'.

It can be seen in Figure 3 that the scales of 'Valence' and 'Arousal' were both located in the factor of Joy. This indicates that in this experiment, these 2 scales cannot be used to explain the colour parameters well since the data of the two were too close.

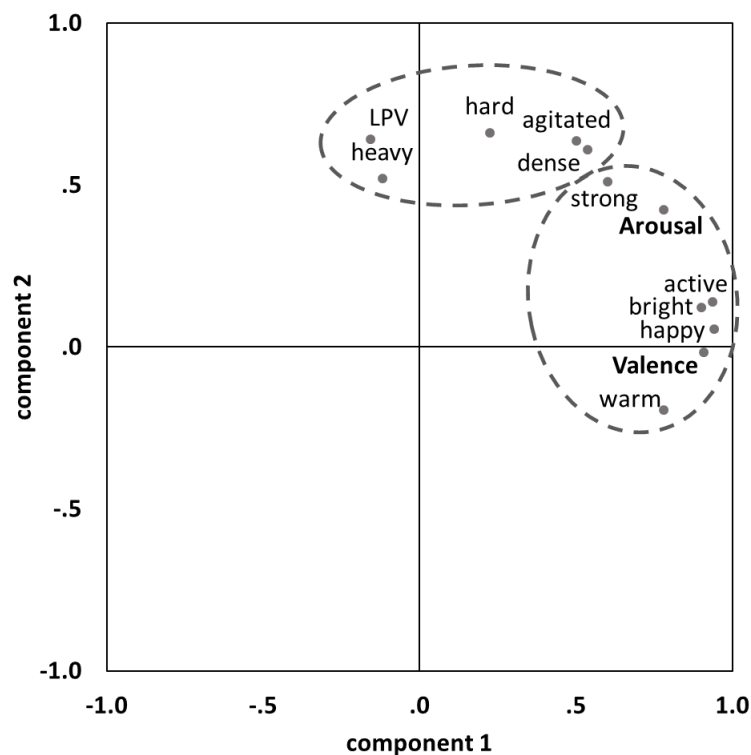

Figure 3: Factor analysis of the 12 scales.

### CONCLUSION

This study was the third part of the colour and music emotion project. The experiment and analysis were strongly related to the previous 2 experiments.

The conclusions of the three experiments are as follows:

- From Experiment 1, it was found that music can be described by two factors, 'Joy' and 'Intensity'. It also found from Experiment 1 that colours can be divided into 2 groups (warm and cool) to represent music.
- In Experiment 2, the perceptions together with colour sequences on display were used to assess the same 13 music pieces from Experiment 1. The results clearly showed that dynamic display colour sequence can significantly affect the emotion perception of the music.
- In this article, the scales of 'Valence' and 'Arousal' was included to study music emotion. Using factor analysis, it can be found that the both 'Valence' and 'Arousal' were located in the factor of Joy. This shows that because the two scales were so close, these two scales perhaps cannot be used to explain the colour parameters well.

### REFERENCES

- Mehrabian, A., J. A. Russell. 1974. *An approach to environmental psychology*. the MIT Press.
- Russell, J. A. 1980. A circumplex model of affect. *Journal of personality and social psychology* 39(6): 1161-1178.

- Zhang, L. K., S. Q. Sun, B.X. Xing, R.M. Luo, and K. J. Zhang. 2019. Using psychophysiological measures to recognize personal music emotional experience. *Frontiers of Information Technology & Electronic Engineering* 20(7): 964-974.
- Whiteford, K. L., K.B. Schloss, N.E. Helwig, and S. E. Palmer. 2018. Colour, music, and emotion: Bach to the blues. *i-Perception* 9(6): 1-27.
- Liu, T. H., J.B. Hutchings, and M.R. Luo. 2020. Is colour associated with musical emotion? In: *AIC 2020 Proceedings of the International Colour Association*, P. Callet, J. Vallet, ed. Avignon: Popes' Palace, 395-400.
- Fairchild, M. 2019. CIE 015:2018 Colourimetry, 4th Edition. The international commission on illumination, Vienna, Austria, 2019.. *Colour Research & Application* 44(4).
- Li, C., Z. Li, Z. Wang, Y. Xu, M.R. Luo, G. Cui, M. Melgosa, M.H. Brill, and M. Pointer. 2017. Comprehensive colour solutions: CAM16, CAT16, and CAM16-UCS. *Colour Research & Application* 42(6): 703-718.

# Visual and sensory perceptions between static and dynamic colors

Rui Pessoa Vasques <sup>1,\*</sup> , António Cruz Rodrigues <sup>2,\*</sup> and Diamantino S. Abreu <sup>1,\*</sup>

<sup>1</sup> Universidade Europeia, IADE, Faculdade de Design, Tecnologia e Comunicação, UNIDCOM/IADE, Unidade de Investigação em Design e Comunicação, Av. D. Carlos I, 4, 1200-649 Lisboa, Portugal, admissions@iade.pt; ruivasquesdesign@gmail.com, diamantinoabreu@gmail.com

<sup>2</sup> Universidade Lusófona de Humanidades e Tecnologias, Campo Grande, 376, 1749-024 Lisboa – Portugal, Delli, Design Lusófona Lisboa, info@ulusofona.pt; antoniocruzrodrigues@gmail.com

\* Corresponding author: ruivasquesdesign@gmail.com, antoniocruzrodrigues@gmail.com, diamantinoabreu@gmail.com

## Abstract

Through the investigation of natural pigments, the main object of the PhD in Design by the author Rui Vasques, several questions arise and refer to the reflection on different aspects about color.

This PhD investigation has as main objective, the study of the pigments and colors existing in the different types of soil of the mountains of Socorro and Archeira (Torres Vedras), for the discovery of the potential of the use of these pigments by Live With Earth Association, located in Cadriceira. The method is based on the experimentation and prototyping of different applications of these pigments, such as natural paints, plasters and dyes, for the development and creation of eco-products able to add value to the universes of eco-arts, eco-design, eco-construction, education and social entrepreneurship.

One of the chapters of the thesis-project is about color in its different study optics, focusing on design and color psychology, with a transdisciplinary and complex thinking approach. As a factor that permanently influences human physiology and behavior, the psyche, is a vast field of information, frequencies, images, sensations, etc... It is intended to study through the human psyche, the phenomena that happen in it, related to the different ways of perceiving colors, as well as the categories of colors introduced in this study: static and dynamic.

This article represents a deep reflection about human perception, the five senses, the meanings, the characteristics and potentials existing in colors, creating a parallelism and a duality between two categories of colors: the “static colors” that we mostly observe in human metrics and applications, and the “dynamic colors”, mutant, which we mainly observe in nature. This article intends to deconstruct these categories of color, while also framing, in general, the connection of the themes addressed with the concepts of “organic” and “inorganic”.

Considering light, time and erosion, as the main influencing factors, this study aims to answer the main questions:

- Which are the different human sensory perceptions, between dynamic colors and static colors?
- Which are the meanings present in dynamic colors, in static colors, and between them?
- Which are the main differences and similarities between dynamic colors and static colors?
- How do static and dynamic colors communicate?

This study is carried out through bibliographic research, among other references, and through a questionnaire addressed to professionals from different areas who work with color, and also an interview with the artist Micaela Jarast, whose painting work is based on the philosophy and use of ecological inks made with natural and semi-natural pigments.

Of the few certainties we have today, it is that everything is uncertain and is constantly changing, on a path of evolution. However, within this certainty, humanity continues to erect structures, mechanisms, ways of thinking, actions, behaviors and beliefs that go in the opposite direction, of eternal permanence, of resistance to the natural mutations of life, of preservation and resilience.

**Keywords:** *Natural Pigments, Design PhD, Static and Dynamic Colors, Eco-Arts, Sustainability*

## INTRODUCTION

This article represents a deep reflection on human perception, the five senses, meanings, characteristics and forms of communication existing in colors, creating a parallelism and a duality

between two categories of colors: the “**static colors**” that we mostly observe in human metrics and applications and the “**dynamic colors**”, mutant, that we mostly observe in nature. This article intends to deconstruct these color categories, while also framing, in a general way, the connection of the themes addressed with the concepts of “inorganic” and “organic”. Considering light, time and erosion as the main influencing factors, this study intends to answer the main questions:

- Which are the different human sensory perceptions, between static colors and dynamic colors?
- Which are the meanings present in static colors, in dynamic colors and between them?
- Which are the main differences and similarities between static and dynamic colors?
- How do static and dynamic colors communicate?

For the first two questions, a comprehensive questionnaire was carried out, in order to better understand the universe of colors, and how they behave in the external (physical reality) and internal (ethereal reality) fields of the human being.

In the external field, of physical reality, it is important to understand how colors behave on Planet Earth, in the sense that they change depending on their geographic location, and also according to different factors to which they are submitted, described previously in general . There is a common truth about color perception at a geographic level, which generalizes and defends the fact that colors differ between the equator, and the northern and southern hemispheres. The closer to the equator, the more vivid, more vibrant, more intense, more saturated and warmer are the colors that exist and the way we perceive them. The closer to the northern or southern hemispheres, on the contrary, the less vivid, less vibrant, less intense, with less saturation and less warm the colors and the ways in which we perceive them are revealed. In most theories about color studies, dynamic colors are associated with warm colors, as they convey the sensations of greater vitality, movement, energy, and static colors are associated with cold colors, by the fact that there is less vitality, movement or energy, in the environments and contexts where these colors are inserted. This article intends to deconstruct these concepts and associations, presenting instead a broader spectrum of understanding about static colors and dynamic colors, and disassociating them from the concept described above, which in my opinion, only includes light and temperature in his theory, forgetting other factors such as time, erosion, decomposition, and other random factors, which I consider extremely important, when we observe and understand the universe of colors, and their different perceptions at the level of the human being.

Internally, from the psyche, human physiology, emotions and ethereal fields of information such as the collective subconscious, collective imagination (Jung 1973), and also morphic resonance and morphic fields of collective memory (Sheldrake 1982), there is a whole new universe that needs to be understood in relation to the presence of colors, their perceptions, meanings, and mainly, the ways they communicate and the messages they communicate.

### **Questionnaire / Opinion Gathering Interview:**

An opinion-gathering survey was carried out through a small questionnaire addressed to different people working in different fields. This same questionnaire was used in the special interview with artist Micaela Jarast, a painter from Argentina, who mainly uses natural paints and pigments.

*Micaela Jarast - <https://www.instagram.com/micaelajarast>*

### **1- What are static colors for you?**

For me, color is a vibration, in permanent relationship with other colors. There is only one color isolated from the others in abstract terms, so I would not come to perceive a color as static, as I understand that it is always influenced by another, in constant change.

Considering the perception of more saturated and ecstatic colors, and others more silent and neutral, such as the Red - Gray ratio; Gray itself would be a profoundly dynamic color, since, as Paul Klee says, "grey is the center of everything, it contains virtually every color, every value, every line".

## **2- What are dynamic colors for you?**

The color itself is dynamic. When we talk about Color Circle, we understand that colors are always related by analogies, complements and counterpoints. Red will not be the same next to an orange, next to a gray, or next to a green. In the first case, it will be a simple pass; in the second, it will change the gray's passivity; and in the third, they will exalt for being complementary.

From the point of view of painting, color is used as a net (weave), where the game is to compose a harmony and balance resulting from the tension of color relations.

## **3- What are, in your opinion, the main similarities between static and dynamic colors?**

To define the color, it seems to me necessary to contextualize it.

Color perception in nature, for example, is pure light. A stone wall that looks like static gray would be influenced by the movement of sunlight, the green resonance of the herb and the blue influence of the sky. Therefore, the supposedly static gray would be vibrating with these resonances.

## **4- What are, in your opinion, the main differences between static and dynamic colors?**

If the color is always in relation to the other, the quality of each will increase its difference. If gray were perceived as static, being in relation to hot red; gray will be exalted by red and red will find its home in grey.

## **5- What is your perception of how colors communicate?**

From my perspective as a visual artist, I use color as a means of expression, as a language.

Using clay and natural pigments to compose, it is possible to apply the harmony and balance of the color circle to the way it organizes the earth's pigments. I would say that colors created from the earth are much more neutral than colors created by humans and industry; which tend to be much more saturated and artificial.

From the other answers (7 in total) we conclude that the general opinion is based on the current general established concept of static and dynamic colors, cold and warm.

Based on the ideas described in this article, the concepts and theory are generated that **"a static color is a color that does not change, or only changes through light, and processes of erosion over long periods of time"** and that **"a dynamic color is a color that changes, not only through light, but also through short, medium and long periods of time, through erosion, and other random factors that influence them."**

To better understand "what are the different human sensory perceptions between static colors and dynamic colors", "what are the meanings present in static colors, in inanimate colors, and between them?", and also "how do static and dynamic colors communicate?", the following list was elaborated :

### **Communication through Static Colors and Dynamic Colors:**

#### *Static Colors*

- Communicate to our bodily senses through the collective subconscious.



- Communicate to our mental perceptions through historical meanings, imaginary / collective and individual signs, and the collective subconscious
- Communicate through the intentions of those who design them in a given context
- Communicate information that is related to the behavior and existence of colors in nature, replicated by humans
- Communicate different sign languages and codes of knowledge developed by human beings
- Communicate the identity of a brand, logo, symbol, object, poster, product, or other result of an intentional design
- They communicate cultural and ethnographic aspects in clothing, flags, objects, instruments and other artifacts and symbols created by human beings.
- They communicate different color codes: computer (HTML: Name, Hexadecimal, RGB) and materials (CMYK, PANTONE, RAL, NCS)

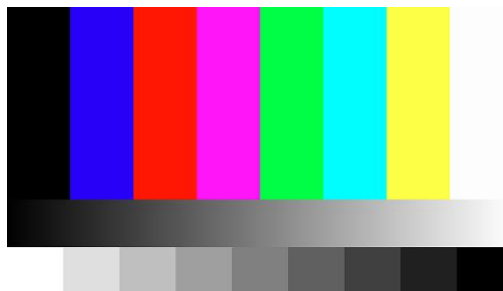

Figure 1: "No Signal" – RGB static TV screen.

### *Dynamic Colors*

- Communicate the amount of light in the atmosphere or environment.
- Communicate the aquatic depth levels.
- They communicate the different states/stages of maturation and degradation of the food: 1) inedible, 2) at the right edible point, 3) edible.
- Communicate the different states/stages of formation and/or degradation of materials.
- Communicate temperature points in different materials. (wood/ metals/ ceramics/ stones/ fire/ gas...) : 1) very cold, 2) cold, 3) room temperature, 4) hot, 5) very hot, 6) extremely hot.
- They communicate the time of exposure of materials to various factors such as oxygen, water and humidity. (geological processes, fungi, rust, mosses...)
- Communicate diverse sensations and perceptions through lights, visual effects, multimedia, stained glass, transparencies, video, photography, painting...
- Communicate the health status of tissues and living materials: 1) Various infections, 2) Blood flows, 3) Aging.
- They communicate rare phenomena such as the refraction of light (rainbow), special materials that change color depending on the perspective (peacock's tail, scales, shells, precious stones), fluorescence, among others.



Figure 2: The dynamic colors on the leaves communicate their degrading state.

“The line that divides organic molecules from inorganic molecules has originated controversy and has historically been arbitrary, but generally organic compounds have hydrogen-bound carbon, and inorganic compounds do not. The etymology of the word “organic” means that it proceeds from “organos”, related to life, as opposed to the inorganic that would have the meaning of everything that lacks life.” (Wikipedia)

In general, and assuming the enormous complexity of the subject, as well as the enormous amount of questions and hypotheses that it raises, from a perspective of continuity, it is concluded from this study, in addition to the conclusions described above, that **static colors are related to the processes of inorganic compounds, and dynamic colors are somewhat related to the processes of organic compounds**, there are always some exceptions to the rule. Transposing to the object of study of the PhD in Design that I perform, the natural pigments, it is important to perceive these concepts, to the extent that one intends to deepen the origin of each pigment, whether it is associated with organic or inorganic processes, and in sequence, whether the color of the pigment is a static color or a dynamic color.

Contrary to the theory itself, being one of the exceptions of the rule, I consider according to research on the constitutions of soils, and the colors of soils, that the pigments under study, come mostly from soils abundant in clays and minerals, and in turn, inorganic. In this case, static colors would be considered, being **“a color that does not change, or only changes through light, and processes of erosion in long periods of time”**. In this case, pigments bring advantages to human use, in the arts, in decoration, in design, in architecture, in engineering, and in other sectors and industries, to the extent that they are predictable, stable, and the original colors prevail over time, such as the industry of wall paints, wood paints, and paints in general. Being natural pigments pure raw materials, their colors can be transformed by joining with other pigments, with other materials, such as in the application of inks, plasters or dyeing, and also under the influence of water, and of course, light.

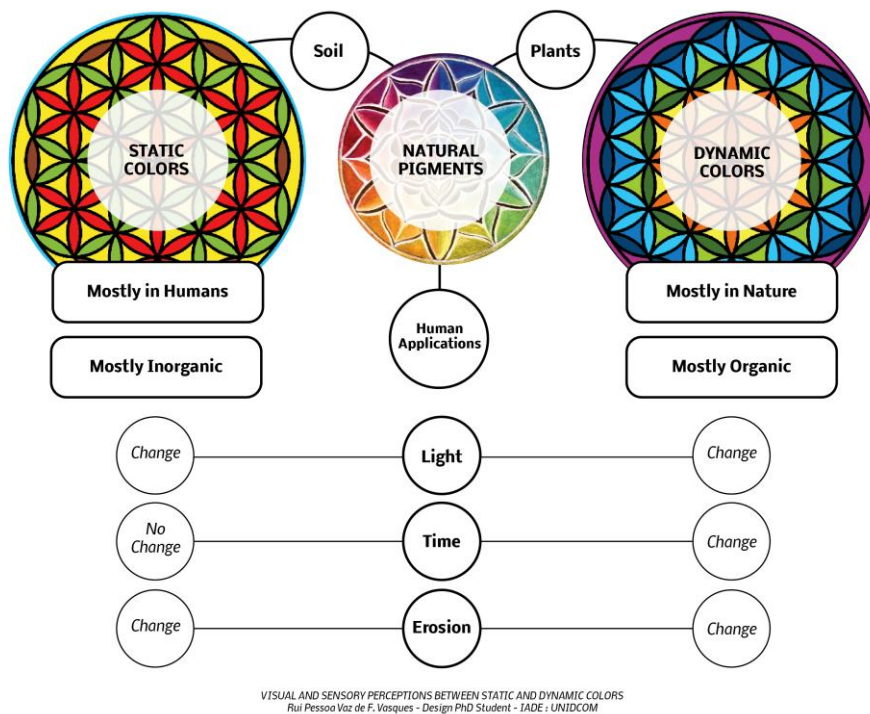

Figure 3 : Mindmap “VISUAL AND SENSORY PERCEPTIONS BETWEEN STATIC AND DYNAMIC COLORS - IADE : UNIDCOM”.

Natural pigments from soils are thus one of the bridges between static colors and dynamic colors, because on the one hand they transmit stability in their colors and inorganic behaviors, most of which are composed of clays and minerals, but on the other hand, they are colors that originate in nature, and capable of being used in different human applications, and also that they can be changed, depending on different processes and intentional, physical or chemical factors.

Natural pigments from plants, vegetables, flowers, blood, among other organic compounds tend to be more related to the concept of dynamic colors, since their color comes from nature, and “changes, not only through light, but also through short, medium and long periods of time, through erosion, and other random factors that influence them”. But also, these organic colors can be mixed with other materials which can stabilize them, and be transformed into static colors. We found this bridges and paradoxes something wonderful, exciting and innovative, for our research, and for the universe of color perception, studies and research.

Of the few certainties we have today, everything is uncertain and is constantly changing, on a path of evolution. However, within this certainty, humanity continues to erect structures, mechanisms, forms of thought, actions, behaviors and conducts that go in the opposite direction, eternal permanence, resistance to the natural changes of life, preservation and resilience. The same happens in the universe of colors.

**ACKNOWLEDGMENTS**

Design PhD granted by FCT – Fundação para a Ciência e Tecnologia – Bolsas de Doutoramento.

**REFERENCES**

Jung, C. 1973. *Synchronicity: An Acausal Connecting Principle*. Princeton University Press.  
 Sheldrake, R. 1982. *Morphic Resonance, The Nature of Formative Causation*. Park Street Press.

# The Emotional Language of Color in Architecture

Dr. Pia López-Izquierdo <sup>1,\*</sup>

<sup>1</sup> Universidad Politécnica de Madrid; pia.lopezizquierdo@upm.es

\* Corresponding author: pia.lopezizquierdo@upm.es

## Abstract

As a result of the restrictions triggered by Covid 19, the “psychological health” of the population has been deeply affected. I believe that architecture and color can play a major role in improving the psychological well-being of individuals, acting as catalyzer between the physical and emotional worlds. When we use color in the 3D physical spaces, due to the nature of its perception, thoughts and emotions are triggered, creating behavioral benefits. We will explain that color perception can sometimes be enriched by the beliefs of the cultural background and the natural environments, Varela et al. (201a). And it is in the Chinese Philosophy in which we encounter the color beliefs connected to the communicative and emotional contents.

In this paper, we present the emotional language of color, made up of five concepts involving color and its situation in space. We will display some of the proposals made for a penitentiary in Seville, Spain.

**Keywords:** *Color, Emotion, Architecture, Cognitive psychology, Chinese philosophy.*

## INTRODUCTION:

Human well-being is not a simple subject, is far more complex than the idea we had until now. Our proposal argues that well-being can be considered as a double faced concept: physical well-being, which brings together the conditions of comfort, and mental health.

My assertion is that color acts on both: transforming the physical space when applied to it, that leads to a reduction of stress, and by inheriting into space thoughts and emotions that generate behavioral benefits. In this paper we will try to expose the second point, explaining the emotional color concepts that will allow us to design spaces that meet the ideal “wellbeing” conditions.

To shape our argument, we will start by recalling an example associated with the traditional use of color. Historically, the red purple and purple were used in the robes of Roman emperors, senators, as in the ceremonial dresses of cardinals, popes, and kings. When people saw a red robe, they perceived two different things: they saw a red stain but also felt a sense of “power” and “authority” Heller (2004).

This means that the perception is “enriched” and colored by the belief associated to purple, the idea of “power”; similarly, in the East the color associated with power was golden yellow. This characteristic phenomenon of color perception makes it a perceptual experience since both cognition and action are involved, Varela et al. (2011). Thus, this is the corner stone of color in architecture: the beliefs accompanying certain colors permeate and enrich its perception, whether it is a belief rooted in culture or coming from the natural environments.

### A first Step into Color Perceptual Experience: Feelings and Sensations

We can use an example to depict more accurately what we are talking about: If we enter a space with a ceiling painted in a blue-sky tone (1a), -a blue that looks like a sky-, a new “phenomenon” will take place: At first, we will see a blue surface; nevertheless, the ceilings that “look like a sky” will unleash some side effects. We will feel an immediate relaxation and afterwards, the ceilings will appear higher and deeper for the spatial qualities associated to the belief “the sky is blue”. Thus, we will behave in a distinctive way standing more uplifted among other things.

This example depicts accurately the unusual case of color perception we want to talk about, allowing us to draw some conclusions:

- Color is not just a perception but rather a perceptual experience, meaning there is a perception, a cognition and an action involved in the process. Thus, sometimes and under certain conditions, color is no longer a feature of things, like when it surrounds us in architecture.
- The cognitions that participate in this color experience are the beliefs we have about certain colors that are predominant in the natural environment. The enrichment of perception are the contents closely related to the beliefs of the color applied, a phenomenon called the Cognitive Penetration of Perception, studied in the Philosophy of Perception. Mac Pherson (2012)
- We can say that there is CogPen when what we see or what we perceive with our senses is determined, influenced, or colored by what we believe and by what we know; that is, in our claim, by the beliefs of the natural environments. Stokes (2013)
- My statement is that color skills rest in the contents underlying color beliefs coming from the “Physical”, Gibson (2015) and “Cultural” worlds, Noë (2004).

### When Emotions come into Scene

Let us use another example to introduce the role of emotions in the perception of color. When we enter a space in a green “that looks like vegetation”, as seen on Figure 1, something happens: at first you feel calm, an astounding calm. The reason rests on a very complex process that we will explain. We will follow an order to describe the steps based on the Cognitive Process of Emotion. Dr. Hita Villaverde (2000) stated that there was a kind of emotional decoding in the visual process.



Figure 1: Corridor: a) Blue that looks like a Sky ceiling. b) The green communicative concept. Proposal for the Psychiatric Penitentiary in Seville, Spain. Pia López-Izquierdo (2021).

Departing from this claim, we propose that a parallelism could be set up in the knowledge of color, when talking about an experience, between the Cognitive process of emotion as Becks (1956) and Ellis (1962) anticipated, which was further developed by Brioles (2002-2003). We suggest a scenario of relationships and parallelisms in which perception, cognition, emotion, and behavior are intertwined (Figure 2) and enriched with the Enactive Theory tradition. In these lines we will not develop an explanation of the Enactive theory, initiated by Merleau-Ponty (1942), but rather will point out the importance of considering perception as an action, as the enactive tradition defends. As a result, we consider that color behavior in space is a Perceptual Experience, having a sensorimotor profile of color.



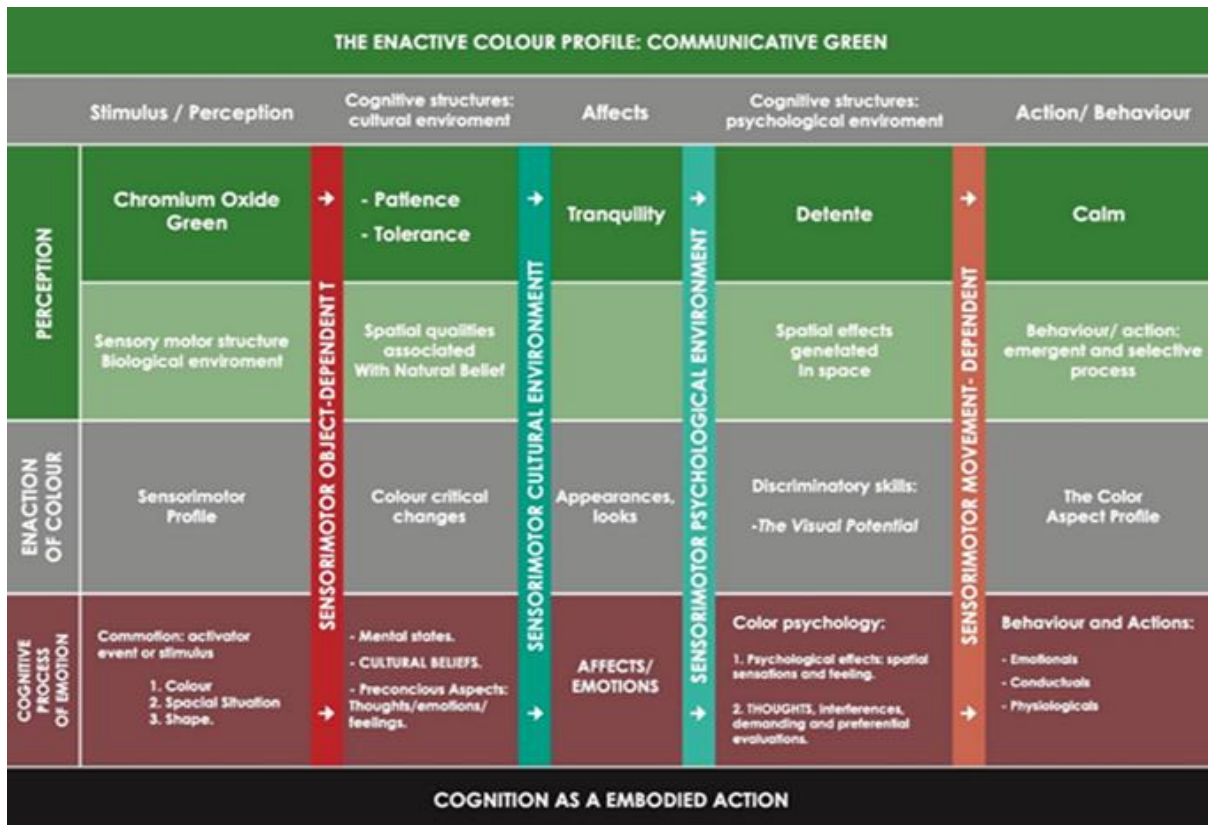

Figure 2: Color Perceptive Experience as a Cognitive process of emotion. Pia López-Izquierdo. Berkeley (2017) and Paris (2013).

However, let us go back to the thread of the argument. When entering a space in a green that surround us like depicted on Figure 1b, we perceive at first a green stain, with its chromatic features as chroma, value and hue. Then, the cognitive structures of the cultural background related to the belief will follow, in this case “patience and tolerance”, that triggers an emotion. Why does this “Cognition appears? The moment has come to understand what the beliefs are, which is their role, where does it come from and why is it so.

**The Role of Beliefs in the Perception of color:**

As we previously saw, the bridge that connects color perception in architectural spaces with the rich and complex phenomenology of its experience are the “beliefs”, known in literature as doxastic states. It is where the basis of color performance in space are affecting people’s behavior. Dokic (2012-2013)

Architectural spaces inherit color beliefs contents through their spatial qualities (As seen in the second example, “blues that look like a sky” Figure 1a or through their cognitive contents (this is the case we are looking at now) of the background beliefs associated to each one, penetrating color perceptual experience. What is important to mention is that what we see is not affected in its sensorial content (we keep seeing a red or green stain) but what takes place happens through the sensory dimension of the perceptual experience, and not through its sensorial content as propose Dokic (2012-2013).

The beliefs involved in color perception are the ones anchored and embedded in cultural systems Hutchins (1995) and related to the notion of both the natural and cultural environments, Gibson (2015) and Noë (2004). We consider two cultural traditions associated to the use and manipulation of color: the western painterly tradition and the Easter Chinese philosophy. It is in the later, where the cognitive

contents connected to the emotions are rooted. These cultural systems are cultural traditions where colors have been manipulated, the corner stone on which, due to their relationship to the physical world, a complex cognitive dimension is contained: the Five Elements Chinese philosophy.

**The Five Elements Phylosophy: a Phenomenological Explanation**

The Five Elements Chinese Philosophy is a cultural system that gathers social and cultural cognition, on which medicine and acupuncture are grounded. They depict the world as constituted by Five elements (water, wood, fire, earth and metal), each one corresponding to a season, an organ, a natural element and a color. Fernandez (2000-2017) undertook a research portraying this system as a process of complex thought called “the Constructive Mind”. The key point is that the Constructive Mind cycle corresponds to a Constructive Emotion cycle attached to it. This investigation gives the consistency and accuracy to ground our communicative color claim. Figure (3).

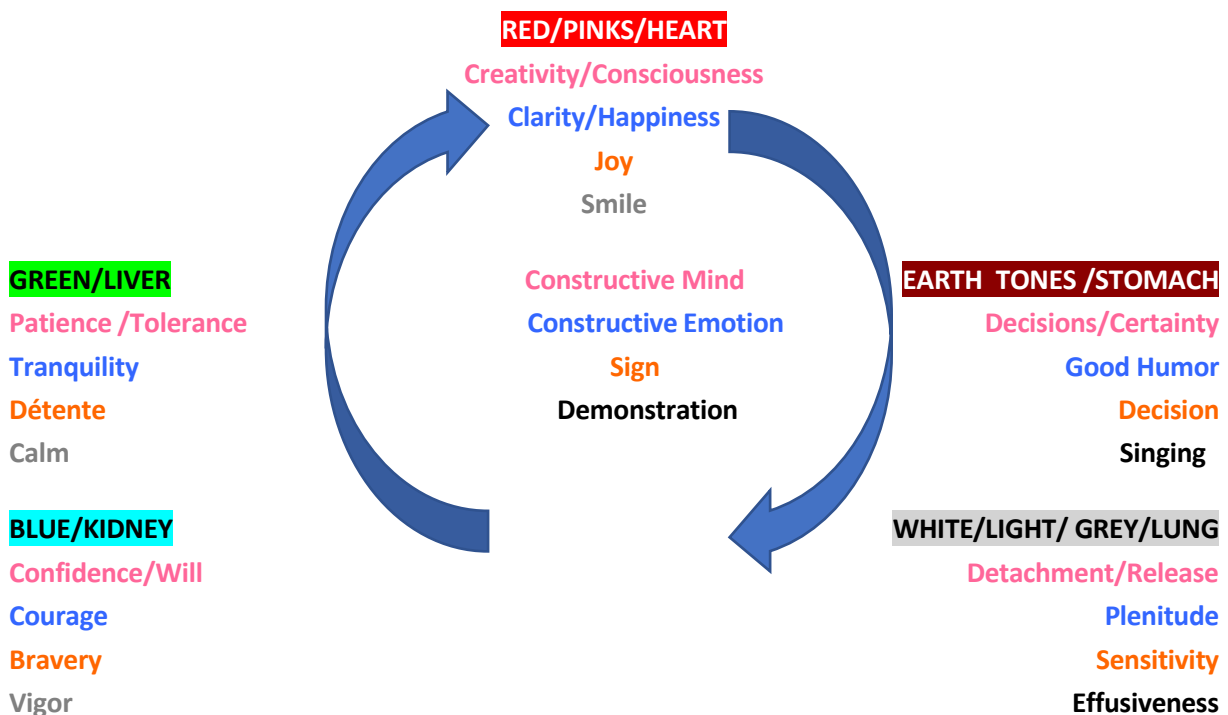

Figure 3; Schemes of the Constructive Mind and the Constructive Emotion. 7Fernandez (2000-2017).

If we go back to the previous example of the communicative green Concept, once the emotion “tranquility” appears, there is a second cognitive structure related to the psychological environment that arises: the “detente”, leading to a final behavior, “Calm”. In the following scheme, we expose the correspondence between the constructive mind and the constructive emotion that arises in each step of the cycle. The next question would be how do we become aware of the thoughts inherited into space? Through behavior, as we know that emotions are behavioral, as the cognitive Psychology asserts. In my research, I propose that when entering a colored space with one of the five color concepts, all these cognitive contents are preconscious in the Freudian sense housed in a blind level, although always using them. Thus, color is acting as the Psychic impulse that pushes color contents from the preconscious to consciousness, triggering a highly complex communicative and emotional issues into space. My claim is that due to the social genesis of the preconscious as De Lucas (1990) proposes, the enriched Five Elements contents are universal since they refer to natural environments, and therefore people everywhere are influenced in the same way, although without being conscious.

In conclusion, there are five colors with the following Visual properties: Blues that look like water, greens that look like vegetation, reds (oranges and dark pink) that look like fire, ochre-brownish tones that look like the earth and white and light grey that look like metal. These colors are responsible for the emotional ability of color, when applied according to the proposed spatial schemes (Figures 4 and 5). These are the five color concepts, understood as the basic color notes of the Emotional Language of Color for architecture.



Figure 4: Color Enactive Concepts: Blue, Green and White. Pía López-Izquierdo. Paris 2017.



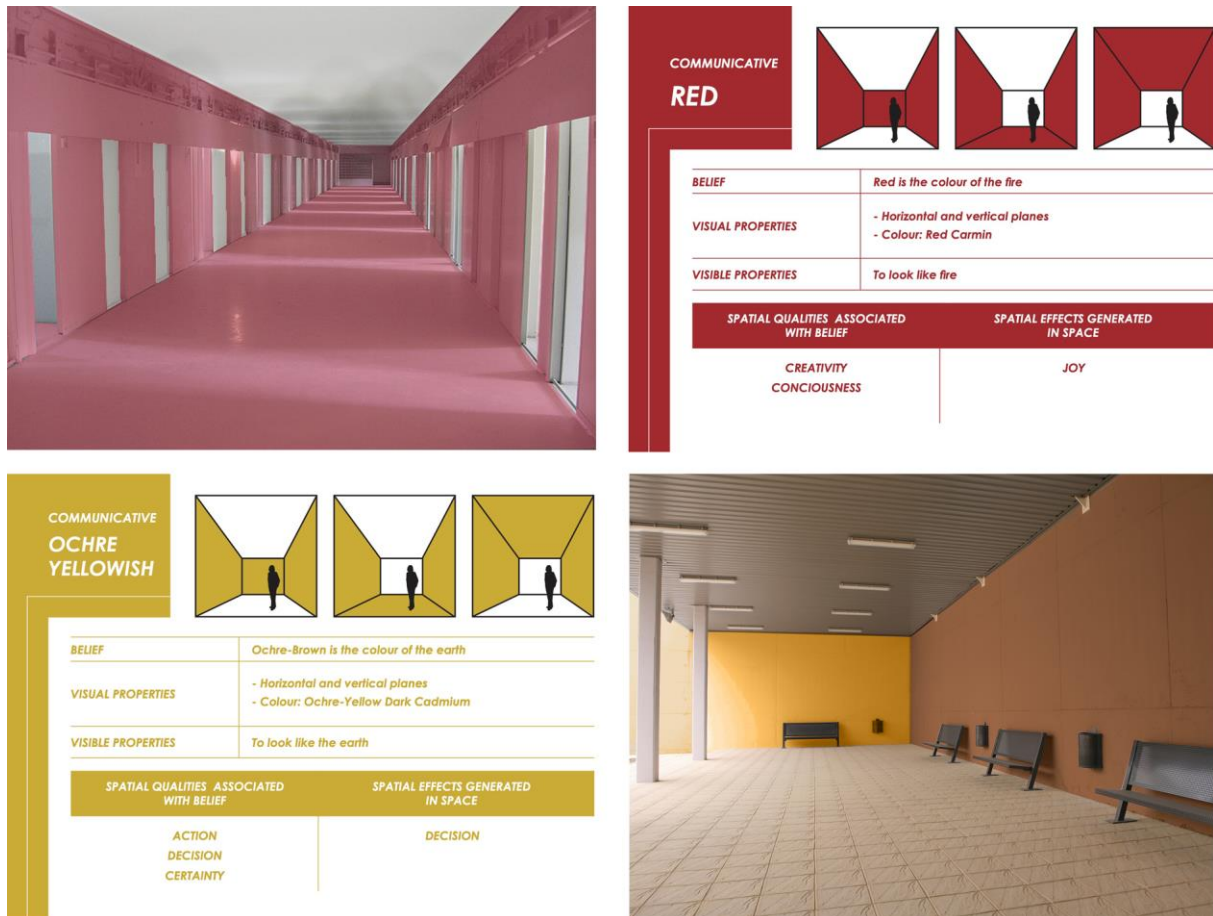

Figure 5: Color Enactive Concepts: red and earth tones. Pía López-Izquierdo, Paris 2017.

## REFERENCES

- Becks, A. and J. Becks. 2011. *Cognitive Behavior Therapy: Basics and Beyond*. New York: Guilford Press
- Brioles, P. 2002/2003. *Inteligencia Emocional*. University of Alcalá.
- De Lucas Hita Villaverde, E. 2000. *Algunos aspectos de la Percepción Cromática*. In: Granada, Congreso Español del Color.
- Dokic, J. 2012-2013. *La Pénétration Cognitive de la Perception*. EHESS. Paris.
- Fernandez, J. 2000-2003. *Constructive Mind and the Constructive Emotion*. Universidad de Alcalá.
- Ellis, A. 1962. *Reason and Emotion in Psychotherapy*. Oxford: Lyle Stuart.
- Gibson, J. 2015. *The Ecological Approach to Visual Perception*. New York: Psychology Press & Routledge
- Heller, E. 2004. *Psicología del Color*. Barcelona: Gustavo Gili.
- Hutchins, E. 1995. *Cognition in the Wild*. Cambridge Massachusetts: MIT Press.
- MacPherson, F. *Cognitive Penetration of Colour Experience: Rethinking the Issue in Light of an Indirect Mechanism*. *Philosophy and Phenomenological Research*, Vol 84, Nº1, 2012, p.p 24-62.
- Merleau-Ponty M. 1945. *Phénoménologie de la Perception*, Paris: Éditions Gallimard.
- Noë, A. 2004. *Action in Perception*. Cambridge Massachusetts: MIT Press
- Varela F. Javier, E. Thompson, and E. Rosch. 2011. *De cuerpo presente: Las Ciencias Cognitivas y la Experiencia Humana*. Barcelona, Gedisa
- Stokes, D. 2013. Cognitive penetrability of perception, *Philosophy Compass* 8 (7):646-663

# Application of color feelings prediction formulas to the estimation of two-color combination feelings of “kimono”

Sachiko Noguchi <sup>1</sup>, Rumiko Takata <sup>2</sup>, Kaori Segawa <sup>2</sup> and Ichiro Katayama <sup>3,\*</sup>

<sup>1</sup> Kimono Color Coordinator Association, art@color.ne.jp

<sup>2</sup> Joshibi University of Art and Design, serendipity@colordesign.jp, segawa.kaori@gmail.com

<sup>3</sup> Kindai University; katayama@waka.kindai.ac.jp

\* Corresponding author: katayama@waka.kindai.ac.jp

## Abstract

This study aimed to examine the applicability of color feelings prediction formulas to the estimation of color combination feelings of “kimono” by performing an evaluation experiment of color combination feelings using illustration images of a woman wearing “kimono” and analyzing the correlation between the evaluation and estimation values of color feelings prediction formulas. As a result of the experiment, the following conclusions were obtained: (1) “Pleasantness” and “beauty” are closely similar feelings. (2) “Floridness” and “contrast” are closely similar feelings. (3) Color feelings prediction formulas are effective in estimating the color combination feelings of “kimono.” However, there is room for improvement in the estimation accuracy of “pleasantness” and “contrast.”

**Keywords:** kimono, color feelings, two-color combination, color feelings prediction formulas

## INTRODUCTION

“Kimono” is standard clothing consisting of *nagagi* (ankle-length garment) and *obi* (sash belt). Therefore, its impression is influenced by colors, patterns, and textures rather than shapes. However, no research has been done to quantitatively analyze how colors, patterns, texture, and the like affect the impression of “kimono.” In contrast, research on color feelings and color combination harmony has a long history: Judd and Wyszecki (1963: 361). The color feelings prediction formulas developed by Nayatani et al. (1970) are particularly notable in terms of the scale of the experiments and the strictness of the analysis of the results: Nayatani and Sakai (2009).

This study aimed to examine the applicability of color feelings prediction formulas to the estimation of color combination feelings of “kimono” by deeming “kimono” as a two-color combination of *nagagi* and *obi*. This study is the first step to developing a color combination design assistance tool for “kimono” based on the findings from color harmony research.

## COLOR FEELINGS PREDICTION FORMULAS

From the mid-1960s to the early 1970s, the Color-Harmony Committee was organized mainly by Nayatani and other experts in psychology, statistics, and physics to establish an academic system for color combination harmony. As a result of the color combination assessment experiments using 38 rating scales, the four major factors comprising the color feelings of two- and three-color combinations were as follows: “pleasantness,” “contrast,” “floridness,” and “warmth”: Nayatanai et al. (1970). Furthermore, color feelings prediction formulas were developed to estimate these factors from Munsell values. The method for calculating the estimation values of the four main factors of color feelings is shown below.

The estimation value of the “pleasantness” factor was obtained with the multiple regression formula consisting of 11 explanatory variables, as indicated in Equation (1):

$$x_{p,AB} = b_0 + \sum_{n=1}^{11} b_n x_{n,AB} \quad (1)$$

Application of color feelings prediction formulas to the estimation of two-color combination feelings of “kimono”

where  $x_{p,AB}$  is the estimation value of the “pleasantness” factor,  $b_0$  is the constant,  $b_n$  is the partial regression coefficient, and  $x_{n,AB}$  is the explanatory variable determined by the locations of component colors in the Munsell color space and their combinations.

The estimation value of the “contrast” factor is expressed by the sum of color difference among component colors and the value of higher Munsell Chroma among them, as indicated in Equation (2):

$$x_{c,AB} = 2\Delta E_{AB} + 3C_{\max,AB} \quad (2)$$

where  $x_{c,AB}$  is the estimation value of the “contrast” factor,  $\Delta E_{AB}$  is the color difference among component colors based on the Godlove color difference formula, and  $C_{\max,AB}$  is the value of higher Munsell Chroma in component colors.

The estimation value of the “floridness” factor is expressed by the sum of the “floridness” factor for each component color, as indicated in Equation (3):

$$x_{f,AB} = x_{f,A} + x_{f,B} \quad (3)$$

where  $x_{f,AB}$  is the estimation value of the “floridness” factor in two-color combinations, and  $x_{f,A}$  and  $x_{f,B}$  are the estimation values of the “floridness” factor for component colors A and B, respectively. The estimation value of the “floridness” factor for a single color is obtained from Equation (4):

$$x_{f,i} = f(H_i) + 0.2(V_i + 0.5C_i)^2 \quad (4)$$

where  $f(H_i)$  is the value determined with the Munsell Hue of component color  $i$ , and  $V_i$  and  $C_i$  are its Munsell Value and Chroma, respectively.

The estimation value of the “warmth” factor is expressed by the sum of the “warmth” factor for each component color, as indicated in Equation (5):

$$x_{w,AB} = x_{w,A} + x_{w,B} \quad (5)$$

where  $x_{w,AB}$  is the estimation value of the “warmth” factor in two-color combinations, and  $x_{w,A}$  and  $x_{w,B}$  are the estimation values of the “warmth” factor for component colors A and B, respectively. The estimation value of the “warmth” factor for a single color is obtained from Equation (6):

$$x_{w,i} = c_0 + \sum_{n=1}^9 c_n x_{n,i} \quad (6)$$

where  $x_{w,i}$  is the estimation value of the “warmth” factor,  $c_0$  is the constant,  $c_n$  is the partial regression coefficient, and  $x_{n,i}$  is the explanatory variable determined by the locations of component colors in the Munsell color space and their combinations.

Assuming that the area ratio of the component colors A and B is  $\alpha$ :  $(1-\alpha)$ , Equations (3') and (5') are as follows, respectively: Sakai and Doi (2011):

$$x_{f,AB} = \alpha x_{f,A} + (1-\alpha)x_{f,B} \quad (3')$$

$$x_{w,AB} = \alpha x_{w,A} + (1-\alpha)x_{w,B} \quad (5')$$

### **COLOR COMBINATION FEELINGS EVALUATION EXPERIMENT**

Illustrations of a woman wearing “kimono” with two-color combinations were prepared by painting *nagagi* and *obi* with different colors (Figure 1) and shown to the observers using an LCD (EV2116W-A, Eizo). The correlated color temperature of the LCD’s white point and the illumination light were both set to 6500 K to match the colorimetric value of a displayed image with the perceived color. The distance between the LCD and the observer was about 60 cm, and the illuminance on the desk where the LCD was installed was about 800 lx. The viewing angle of the displayed illustration was 20° (vertical) × 7° (horizontal), and the background of the illustration was achromatic, equivalent to N5.



Figure 1: Example of the illustration.

With respect to the 102 pairs of two-color combinations comprising 204 colors systematically selected from the Munsell color space: Mori et al. (1967), the estimation values of “pleasantness,” “contrast,” “floridness,” and “warmth” were calculated using color feelings prediction formulas. Thirteen pairs of two-color combinations ranged evenly from color combinations with high estimation value to those with low estimation value for each factor. Forty-one patterns of two-color combinations were selected, excluding overlapping color combinations. Eighty-two colors comprising 41 two-color combinations displayed in the aforementioned LCD were measured using a color luminance meter (CS-100, Konica Minolta) and converted to Munsell values. Figure 2 confirms that the selected pairs of color combinations are distributed throughout the Munsell color space. The number of two-color combinations prepared was 41 patterns, but because the inverted color combinations of *nagagi* and *obi* were distinguished, the total number of the patterns was 82.

The observers evaluated each pattern’s “pleasantness,” “contrast,” “floridness,” and “warmth” based on a seven-point rating scale. They answered on such factors as “refinement,” “beauty,” and “lucidity,” which are the rating scales with a high factor loading to the “pleasantness” factor among the 38 rating scales selected by the Color-Harmony Committee, in the same manner. These three scales

Application of color feelings prediction formulas to the estimation of two-color combination feelings of “kimono” were added in consideration of rating difficulties caused by the ambiguity of the word “pleasantness.” After the observer completed his or her response to all rating scales with respect to a color combination pattern of “kimono,” a next color combination pattern was displayed after a 2 s interval (the state of only N5 background). The color combination patterns of “kimono” were presented in random order.

The observers were students and faculty members of a “kimono” vocational school, comprising 43 females and 2 males whose average and median age were 33.5 and 22 years, respectively. They had normal color vision and normal visual acuity (including corrected vision).

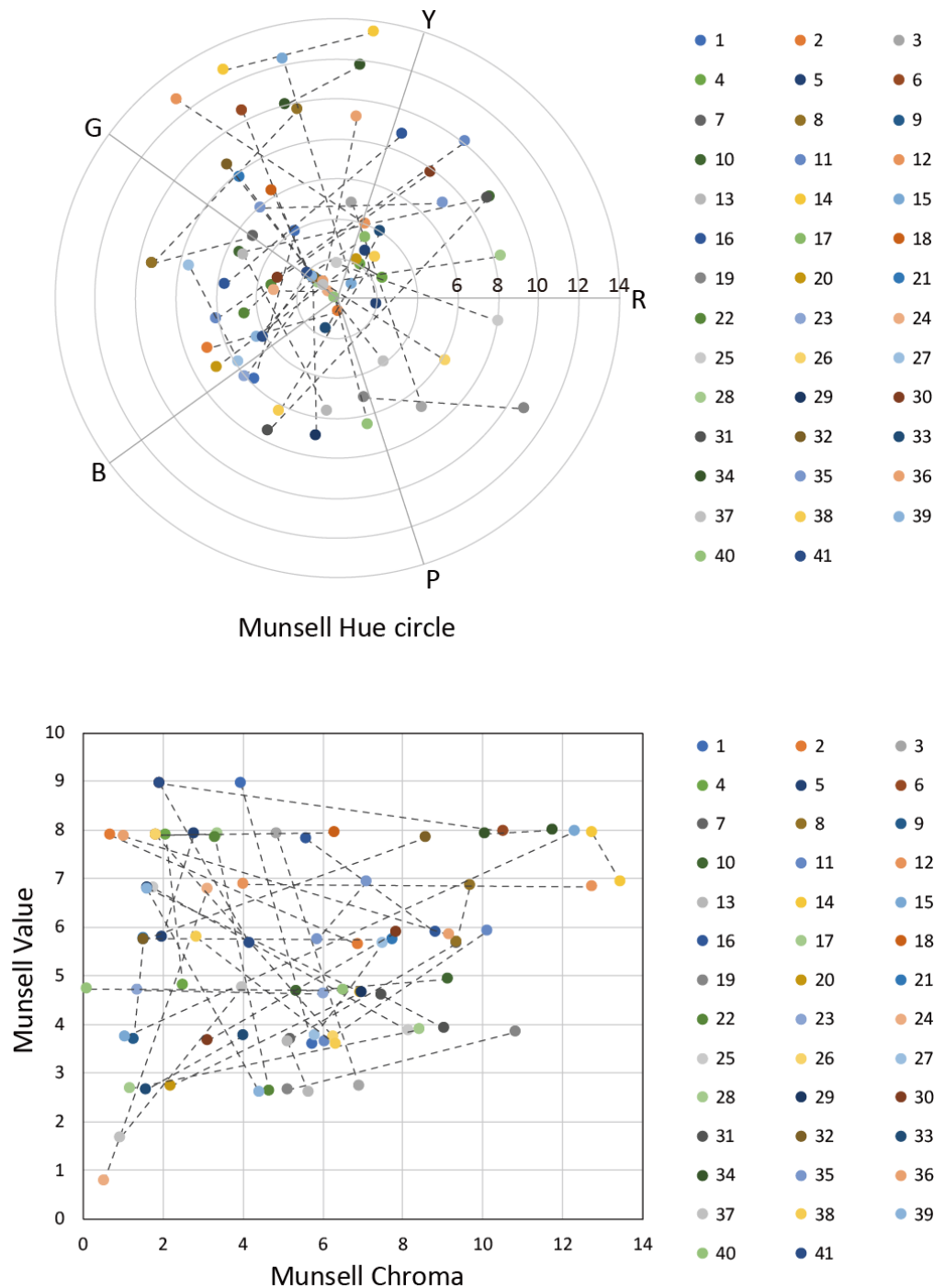

Figure 2: Distribution of the color combinations in Munsell color space.

## RESULTS AND DISCUSSION

The correlation matrix shown in Table 1 was obtained from the ratings by all observers as “pleasantness,” “contrast,” “floridness,” “warmth,” “refinement,” “beauty,” and “lucidity.” A strong correlation was observed between “pleasantness,” “refinement,” “beauty,” and “lucidity,” indicating a particularly strong correlation between “pleasantness” and “beauty.” A strong correlation was also seen between “floridness” and “contrast” ( $r = 0.88$ ). From these results, it can be considered that “pleasantness” and “beauty” are closely similar feelings, and the same holds true for “floridness” and “contrast.”

When the estimation values obtained by color feelings prediction formulas were compared to the average values of the evaluation values given by the observers in “pleasantness,” “contrast,” “floridness,” and “warmth,” a significant correlation was confirmed at the 1% level between the estimation and evaluation values in each emotional factor (Table 1). Especially, the correlation coefficient between the estimation and evaluation values of “warmth” was 0.87. Likewise, the correlation coefficient between the estimation and evaluation values of “floridness” was 0.81, resulting in sufficiently high estimation accuracy. However, the evaluation value of “contrast” had the highest correlation coefficient ( $r = 0.70$ ) with the estimation value of “floridness,” followed by the correlation coefficient ( $r = 0.64$ ) with the estimation value of “contrast.” Furthermore, the color combination feeling that best correlated with the estimation value of “pleasantness” was “lucidity,” with a correlation coefficient of 0.64.

From the above, color feelings prediction formulas are effective in estimating two-color combination feelings of “kimono,” but the estimation accuracy of “pleasantness” and “contrast” is lower than that of other factors, leaving room for improvement.

		evaluation results						
		pleasantness	contrast	floridness	warmth	refinement	beauty	lucidity
evaluation results	pleasantness	-	-0.388 **	-0.202	-0.231 *	0.830 **	<b>0.882</b> **	0.775 **
	contrast	-0.388 **	-	<b>0.880</b> **	0.441 **	-0.379 **	-0.118	-0.228 *
	floridness	-0.202	<b>0.880</b> **	-	0.448 **	-0.332 **	0.026	-0.112
	warmth	-0.231 *	0.441 **	0.448 **	-	-0.489 **	-0.115	-0.555 **
	refinement	0.830 **	-0.379 **	-0.332 **	-0.489 **	-	0.794 **	<b>0.869</b> **
	beauty	<b>0.882</b> **	-0.118	0.026	-0.115	0.794 **	-	0.780 **
	lucidity	0.775 **	-0.228 *	-0.112	-0.555 **	<b>0.869</b> **	0.780 **	-
estimation values	pleasantness	<b>0.544</b> **	-0.084	0.039	-0.387 **	<b>0.529</b> **	<b>0.559</b> **	<b>0.644</b> **
	contrast	-0.332 **	<b>0.643</b> **	0.489 **	0.204	-0.259 *	-0.189	-0.120
	floridness	-0.278 *	<b>0.697</b> **	<b>0.808</b> **	0.493 **	-0.412 **	-0.091	-0.152
	warmth	-0.322 **	0.570 **	0.515 **	<b>0.868</b> **	-0.467 **	-0.154	-0.480 **

significance level \*: 5%, \*\*: 1%

Table 1: Correlation matrix between evaluation and estimation values.

## CONCLUSIONS

The following conclusions were reached by examining the applicability of color feelings prediction formulas to the estimation of color combination feelings of “kimono.” (1) “Pleasantness” and “beauty” are closely similar feelings. (2) “Floridness” and “contrast” are closely similar feelings as well. (3) Color feelings prediction formulas are effective in estimating the color combination feelings of “kimono.” However, there is room for improvement in the estimation accuracy of “pleasantness” and “contrast.” Further studies should modify color feelings prediction formulas for the estimation of color combination feelings of “kimono” and verify its performance.

## **REFERENCES**

- Judd, D. B, and G. Wyszecki. 1963. *Color in business, science, and industry*. Second edition. New York: John Wiley and Sons.
- Mori, N., Y. Nayatani, A. Tsujimoto, J. Ikeda, and S. Namba. 1967. An appraisal of two-color harmony by paired comparison method (Part 1). *ACTA CHROMATICA* 1-5: 221-235.
- Nayatani, Y., A. Tsujimoto, C. Asano, S. Machihara, J. Ikeda, S. Namba, H. Sobagaki, and M. Hirata. 1970. An analysis of affective values on three-color harmony by the semantic differential method. *Farbe* 19: 195-217.
- Nayatani, Y., and H. Sakai. 2009. Proposal for selecting two-color combinations with various affections. Part 1: Introduction of the method. *Color Research and Application* 34-2: 128-134.
- Sakai, H., and M. Doi. 2011. Prediction formulas of color feelings taking into account the emotional scale and area effect. *Journal of the Color Science Association of Japan* 35 supplement: 126-127.

# Color Preference for Color Combinations Applied onto Three-Dimensional Color Configuration

Shi-Min Gong <sup>1,\*</sup> and Wen-Yuan Lee <sup>2</sup>

<sup>1</sup> Department of Commercial Design, Ming Chuan University; gong73@mail.mcu.edu.tw

<sup>2</sup> Department of Media Design, Tatung University; wylee@gm.ttu.edu.tw

\* Corresponding author: gong73@mail.mcu.edu.tw

## Abstract

This study aimed to understand the color preference on 3D color configuration. Thirty-two observers were invited to take part in a psychophysical experiment. Each observer was asked to assess 141 experimental samples on the “like-dislike” scale. According to the results, color preference is mainly affected by the sum in lightness, and needs to be divided into three phenomena: (1) when achromatic color configured with achromatic color, the lightness sum between two colors is greater, it is more liked, (2) when color combination is chromatic color configured with achromatic color, the color preference is lower when the sum in lightness between the two colors is closer to 110, but when the sum in lightness is greater than 110, the higher the sum in lightness, the more it is liked, and (3) two colors with higher lightness sum tend to be more preferred while chromatic color configured with chromatic color.

**Keywords:** *color preference, color configuration, design, color psychology*

## INTRODUCTION

In the modern world, the competition of product design moves from manufacturing to appearance. For product appearance, color is the most direct attribute that customers perceive. A considerable number of studies over the years have looked into the color preference, for instance, Cohn (1894) studied the phenomenon of color preference in 1894. After more than 100 years, research is still ongoing into color preferences. We found that the majority of previous research on color preference has been limited to the exploration of single colors. A few studies, such as Ou et al. (2004) and Ou et al. (2012) used color combinations, but these color samples used were color patches. Although some design applications have been used in recent research, such as floral pattern fabrics by Hsu and Ou (2016), packaging design by Marques da Rosa et al. (2019) or print advertisement with a fictitious brand logo and interior image by Jeon et al. (2020), the presentation of these color configurations is still on the plane or computer screen. This made the results of color preference impractical. The product designers need to understand how the colors appear on the product rather than on the color patch. Therefore, the authors of this study conducted color harmony research by using 3D configuration. In our previous study, Gong and Lee (2019), it was found that the color harmony on 3D color configuration is different from those on the planar color configuration. These results led us to speculate whether there are also differences in color preferences. Hence, the current study carried out a psychophysical experiment using a series of color combinations applied to 3D color configuration to assess the color preference.

## EXPERIMENTAL PLAN

To understand the color preference of color combination applied to 3D color configuration, a psychophysical experiment was conducted. Thirty-two observers, including 13 males and 19 females (average age 21.2 years old) took part in this experiment. Each observer was asked to assess two-color combinations on 3D color configuration on the “like-dislike” scale. This experiment was conducted in



a dark room. Each experimental sample was displayed in a viewing cabinet and illuminated by a D65 simulator. The viewing distance was about 45 cm with a 45/45 illuminating/viewing geometry, as shown in Figure 1(a). The luminance levels on three surfaces of experimental sample were measured. They were 230.5 cd/m<sup>2</sup>, 165 cd/m<sup>2</sup>, and 112.5 cd/m<sup>2</sup>, respectively, as shown in Figure 1(b).

In term of the color configuration, in order to meet the needs of product design, the frequently-seen cuboid shape configured with side circle was used as the color configuration in the experiment, as shown in Figure 1 (b). The main color was applied onto the cuboid shape and the secondary color on the side circle.

To produce two-color combinations, 11 basic color terms (red, orange, yellow, green, blue, brown, purple, pink, white, black, and gray) according to Berlin and Kay (1969) were selected to be the main colors. Each main color was produced according to their boundaries in CIELab space proposed by Lin et al. (2001a, 2001b, 2001c). In addition, five types of color scheme techniques, as proposed by Yano (2008), were used to produce secondary colors, including “neighboring tone with neighboring hue”, “different tone with the same hue”, “same tone with different hue”, “chromatic-achromatic combination”, and “achromatic-achromatic combination”. A total of 141 color combinations were applied onto cuboid configured with side circle, as shown in Figure 1(c). Each color was measured by a GretagMacbeth® Eye-One. The CIELAB values were calculated under CIE D65 and 1964 standard colorimetric observers.

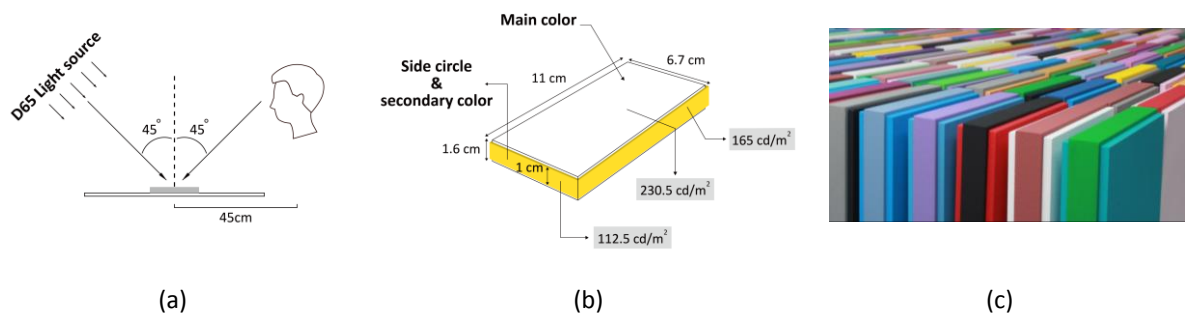

Figure 1: The experimental samples and situation.

### **INTRA- AND INTER-OBSERVER VARIATION**

Prior to analysis, intra- and inter-observer variations were evaluated using the root mean square (RMS). The former assessed whether the observers can repeat the same judgment or not. The latter examined how well the individual observer agreed with the mean results. RMS equation is given below. An RMS of 0 represents a perfect agreement between two data arrays.

$$RMS = \sqrt{\frac{\sum (X_i - Y_i)^2}{n}}$$

The results are illustrated in Figure 2. The intra-observer variation and inter-observer variation range between RMS of 0.53 and 2.88. Observer 17 and 19 were found to have an RMS value exceeding 2.0 on inter-observer variation. Observer 19 was also found to have an RMS value exceeding 2.0 on intra-observer variation, indicating that these observers provide inconsistent judgment. Therefore, the data of these observers were excluded from further analysis.

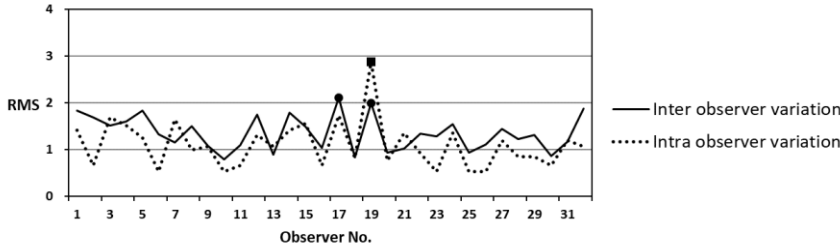

Figure 2: Intra- and inter-observer variation.

**RESULT**

To understand if color attributes had any impact on the color preference, the addition and subtraction interrelationships between two colors were calculated as color parameters. These color parameters include  $\Delta E$ ,  $\Delta C^*$ ,  $\Delta L^*$ ,  $\Delta a^*$ ,  $\Delta b^*$ ,  $\Delta h$ ,  $C^*_{sum}$ ,  $L^*_{sum}$ ,  $a^*_{sum}$ ,  $b^*_{sum}$ , and mid h, as summarized in Table 1.

Table 1: Two-color interrelationship to understand the impact of color attributes on color preference.

Subtraction	Addition
$\Delta E = \sqrt{(L_1^* - L_2^*)^2 + (a_1^* - a_2^*)^2 + (b_1^* - b_2^*)^2}$	$C^*_{sum} = C_1^* + C_2^*$
$\Delta C^* =  C_1^* - C_2^* $	$L^*_{sum} = L_1^* + L_2^*$
$\Delta L^* =  L_1^* - L_2^* $	$a^*_{sum} =  a_1^* + a_2^* $
$\Delta a^* =  a_1^* - a_2^* $	$b^*_{sum} =  b_1^* + b_2^* $
$\Delta b^* =  b_1^* - b_2^* $	$midh = \begin{cases} \text{if } (h_1 - h_2) > 180^\circ, & (360 -  h_1 - h_2 ) / 2 + h_2 \\ \text{if } (h_1 - h_2) \leq 180^\circ, &  h_1 - h_2  / 2 + h_2 \end{cases}$
$\Delta h = \begin{cases} \text{if } (h_1 - h_2) > 180^\circ, & 360 -  h_1 - h_2  \\ \text{if } (h_1 - h_2) \leq 180^\circ, &  h_1 - h_2  \end{cases}$	

The correlation coefficient was used to see how well the color preference correlate with color parameters. The results are summarized in Table 2, It can be seen that  $L^*_{sum}$  had higher correlation coefficients of 0.52, in comparison with other parameters. This implies that lightness sum is an important parameter affecting color preference of two-color combination on 3D color configuration.

$\Delta E$	$\Delta C^*$	$\Delta L^*$	$\Delta a^*$	$\Delta b^*$	$\Delta h$	$C^*_{sum}$	$L^*_{sum}$	$a^*_{sum}$	$b^*_{sum}$	mid h
0.16	0.25	0.40	-0.09	-0.03	-0.10	-0.04	0.52	-0.19	0.26	-0.13

Table 2: Correlation coefficients between color preference and color parameters.

To further explore how color scheme techniques influence upon color preference, the color combinations were categorized into three types.

Type I: the color combinations used achromatic color as main color and secondary color.

Type II: the combinations configured by achromatic color and chromatic color.

Type III: the combinations used chromatic color as man color and secondary color.

Each type was calculated correlation coefficient with color preference by using color parameters as shown in Table 1. The results of correlation coefficient are summarized in Table 3. Also the scatter plot for highest correlation coefficient are provided in Figure 3.

For Type I, the results showed that the L\*sum has a highest correlation coefficient of 0.85, as shown in Figure 3 (a); when lightness sum is greater, it tends to be preferred.

For Type II, the lightness sum was found to have highest correlation coefficient (r=0.50), indicating the positive correlation. Further, in Figure 3(b), it can be seen the trending line appears U pattern. The lowest U pattern are located at lightness sum of 110. This indicated that the color preference of two-color combination on 3D color configuration is lower when the lightness sum between the two colors is close to 110.

For Type III, the highest correlation is with L\*sum, and the correlation coefficient is 0.58, as shown in Figure 3(c). In Figure 3 (c), it can be found that a higher lightness sum of two colors denotes more preferred.

	$\Delta E$	$\Delta C^*$	$\Delta L^*$	$\Delta a^*$	$\Delta b^*$	$\Delta h$	$C^*_{sum}$	$L^*_{sum}$	$a^*_{sum}$	$b^*_{sum}$	mid h
Type I	0.02	0.07	0.02	-	-	-	-	0.85	-	-	-
Type II	0.47	0.30	0.41	-0.07	0.31	0.06	0.34	0.50	-0.09	0.31	-0.20
Type III	-0.12	0.23	0.31	-0.09	-0.24	-0.42	0.05	0.58	-0.10	0.37	-0.09

Table 3: Correlation coefficients between color preference and color parameters.

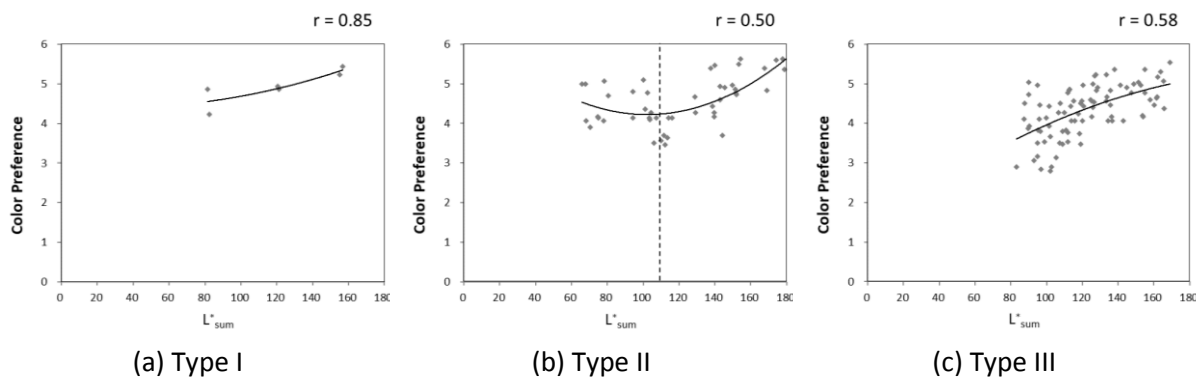

Figure 3: Correlation coefficient between color preference and L\*sum. (a) Type I, (b) Type II and (c) Type III.

**CONCLUSIONS**

In the current study, we conducted a psychophysical experiment to see the color preference of two-color combination applied on 3D color configuration. The results showed that color preference is mainly affected by lightness sum between two colors. Regardless of color scheme technique, the lightness sum between two colors will be the influential parameter to create color preference. This tells us that higher lightness sum, the more it is preferred.

**ACKNOWLEDGEMENTS**

This study is funded by the National Science Council in Taiwan. The project number is NSC 100-2221-E-036-029-MY2.

## REFERENCES

- Berlin, B., and P. Kay. 1969. *Basic Colour Terms: Their Universality and Evolution.*: Basic Colour Terms: Their Universality and Evolution.
- Cohn, J. 1894. Experimentelle Untersuchungen über die Gefühlsbetonung der Farben, Helligkeiten und ihrer Combinationen. *Philosophische Studien* 10, 562-603.
- Gong, S.-M., and W.Y. Lee. 2019. Colour harmony of two-colour combinations using a 3D colour configuration. *Coloration Technology*, 135(4), 292-304.
- Hsu, M.-Y., and L.C. Ou. 2016. Colour preference for Taiwanese floral pattern fabrics. *Color Research and Application*, 41(1), 43-55.
- Jeon, E., Y. Han, and M. Nam. 2020. How you see yourself influences your color preference: Effects of self-construal on evaluations of color combinations. *Psychology and Marketing*, 37(7), 980-994.
- Lin, H., M. R. Luo, L.W. MacDonald, and A.W.S. Tarrant. 2001a. A cross-cultural colour-naming study. Part I—Using an unconstrained method. *Color Research and Application*, 26(1), 40-60.
- Lin, H., M. R. Luo, L.W. MacDonald, and A.W.S. Tarrant. 2001b. A cross-cultural colour-naming study. Part II—Using a Constrained Method. *Color Research and Application*, 26(3), 193-208.
- Lin, H., M. R. Luo, L.W. MacDonald, and A.W.S. Tarrant. 2001c. A cross-cultural colour-naming study. Part III—A colour-naming model. *Color Research and Application*, 26(4), 270-277.
- Marques da Rosa, V., C. Spence, and L. Miletto Tonetto. 2019. Influences of visual attributes of food packaging on consumer preference and associations with taste and healthiness. *International Journal of Consumer Studies.*, 43(2), 210-217. doi:10.1111/ijcs.12500
- Ou, L.-C., Luo, M. R., Sun, P.-L., Hu, N.-C., Chen, H.-S., Guan, S.-S., and K. Richter. 2012. A cross-cultural comparison of colour emotion for two-colour combinations. *Color Research and Application*, 37(1), 23-43.
- Ou, L.-C., M. R. Luo, A. Woodcock, and A. Wright. 2004. A study of colour emotion and colour preference. Part II: Colour emotions for two-colour combinations. *Color Research and Application*, 29(4), 292-298.
- Yano, R. 2008. *The Art of Designing* (L. Siao-Yang, Trans.): Solutions Publishing CO.



# Lighting emotions: a review of the emotional influence of color perceived lightness

Alessandro Bortolotti<sup>1,3,\*</sup>, Loreta Cannito<sup>2,3</sup>, Stefano Anzani<sup>1,3</sup>, Maurizio Rossi<sup>4</sup> and Riccardo Palumbo<sup>1,3</sup>

<sup>1</sup> Department of Neuroscience, Imaging and Clinical Sciences, University Gabriele d'Annunzio Chieti-Pescara; alessandro.bortolotti@unich.it; stefano.anzani@unich.it, riccardo.palumbo@unich.it

<sup>2</sup> Department of Psychological, Health and Territorial Sciences, University Gabriele d'Annunzio Chieti-Pescara; loreta.cannito@unich.it

<sup>3</sup> Center for Advanced Studies and Technology (CAST), University "G. D'Annunzio" of Chieti-Pescara.

<sup>4</sup> Department of Design, Politecnico di Milano; maurizio.rossi@polimi.it

\* Corresponding author: alessandro.bortolotti@unich.it

## Abstract

As human beings, we are continuously exposed to stimuli that modulate our psychological functioning and behavior, presumably through the influence exerted on our emotions. In literature, among others, the feature of color, mainly related to the three attributes of hue, chroma, and lightness, represents one of the most explored topics. By the way, the multidisciplinary lens through which it has been investigated and the partial lack of methodological rigor make it difficult, thus far, to unify the research evidence while being able to disambiguate the single contribution of each color's attribute. The current review aims to provide an overview of the most recent literature, focusing on evidence that highlights the role of the perceived lightness of color, in its functional as well as aesthetic properties, in influencing emotions and behavior. Practical implications and future directions in this research area are outlined.

**Keywords:** *Color, Lightness, Psychology and Context*

## INTRODUCTION

Our world is full of stimuli that constantly bombard us, and we give meaning to these stimuli. One of the stimuli that we perceive and that involuntarily modify our behavior is color. Throughout history, different disciplines, with different research methodologies, have dealt with the study of color. Through a series of theoretical and empirical works, they have created a general framework on the subject (Elliot 2015). The scientific literature presents different works on various aspects of color as a stimulus, such as the physics of color (basic properties of color), the physiology of color (processing of color information), and the language of color (naming a given color in different countries). Color has been defined in a myriad of ways, and it is fair to say that a universal and definitive definition has yet to emerge. Since the 2000s, a new line of research is taking more and more a slice of scientific publications, "color-psychology". The research in this field deals with the relationship between color and cognition, color and behavior, color and purchase (just to name a few). Unfortunately, research in this field does not all have methodological rigor (Elliot and Maier 2014). In this review, the main purpose is to shed light on the previous literature on color and psychological functions going to break down both the characteristics of color individually, focusing mainly on the perceived lightness of color, and breaking down and analyze separately the psychological characteristics that color can influence. We will analyze recent theories and research regarding the possible relationship between emotions and the perceived lightness of a color. Color exists only in the mind; it is a highly subjective experience that creates great individual differences. Each color can be described as possessing three main attributes: hue, saturation, and lightness. In summary, color perception provides us with a representation of the physical objects and lights in our three-dimensional environment (Geisler 1989). This process allows us a complete understanding of the space around us through different processes. The global process of "color perception" gives us a description of the physical properties of these objects and lights; a description of how information about these physical properties is

transported by light to the eyes and stored by optics to form the retinal image; a description of how retinal photoreceptors respond to the retinal image; a description of how photoreceptor responses are transformed by visual processing into the way we see the world (our perceptual representation); and finally the emotional connection generated by the color-object interaction that through experience will go on to modify future behavior in relation to the same "colored object". As a starting point for psychological theories associated with color, one could point to when the theory of color and psychological functioning has been present since Goethe in 1810 wrote his "Theory of Colors". In his book, he linked color categories to emotional response. Historical research on the topic has created at least general conceptual statements about color and psychological functioning, particularly with people's general associations with colors and their corresponding influence on emotions, cognition, and behavior (Frank and Gilovich 1988). Different studies have investigated the relationship between color and other more specific psychological variables, such as sexual attractiveness or intellectual performance (Pazda 2014). One of the most investigated cognitive functions is the attentional process influenced by color. On selective attention, for example, it has been shown how red stimuli receive an attentional advantage (Elliot 2015). Other cognitive functions have been investigated as studies on color, and athletic performance have linked the use of red to improved performance (Elliot and Maier 2014). Other studies have investigated the relationship between memory-emotion modulated by color and how it affects performance in older adults (Mammarella *et al.*, 2016). As seen from the extensive reference literature, all effects of color undoubtedly depend on certain psychological conditions (or variables) independent of the stimulus but vary from individual to individual. These variables have been significantly underestimated until a few years ago, variables such as the culture of belonging, sex, age, the individual's emotional state, and the type of task (in the experimental case). These variables make the color-emotion interaction a process that cannot be underestimated, and it is not universal. The awareness and realization that understanding these conditions will be an important marker of maturity for future work in this area. These variables, hitherto underestimated, have created several methodological errors, creating results based on false expectations.

### **COLOR CONTROVERSY**

A constant feature of this work points to critical methodological problems that precluded rigorous testing and clear interpretation. One such problem has been the inability to pay attention to scientific procedures, including investigator blindness to the condition, identification and exclusion of color-deficient participants, and standardization of color presentation or exposure duration. One of the most common mistakes is the inability to specify and control color on a spectral level in manipulations. Without this specification, it is impossible to know what precise combination of color properties has been studied. Without such control, it is inevitable to confuse focal and non-focal color properties (Valdez and Mehrabian 1994). Another problem is perhaps due to an optimistic view of one's research, as the effects of variables are inflated and given for universals (Elliot and Maier 2014). Color varies on three primary attributes, hue, lightness and chroma. Each of these attributes can influence psychological functioning. Thus, more rigorous experimental work addresses both the multidimensionality and perceived typicality of color stimuli in manipulations. All of these methodological problems have greatly hindered (rigorous) scientific progress in this area. Color control is typically improperly performed at the device level (rather than the spectral level), is impossible to implement (e.g., in web-based platform studies), or is ignored altogether. Color control is undoubtedly difficult, as it requires technical equipment to evaluate and present color, as well as

the experience to use it. The results of uncontrolled research can be informative in initial explorations of color hypotheses, but such work is inherently fraught with interpretive ambiguity (Elliot and Maier 2014) that must be subsequently addressed. The process of color perception is not only a function of lightness, chroma, and hue, but also of factors such as viewing distance and angle, the amount and type of ambient light, and the presence of other colors in the immediate background and general surroundings (Fairchild 2015). In basic scientific research on color, these factors are carefully specified and controlled to establish standardized viewing conditions for participants. These factors have been largely ignored and have allowed for variation in research on color and psychological functioning, with unknown consequences. To date, most theories have focused on hue, one in particular, red, which is understandable given its importance in nature, body, and society. In most theories, the only hue is considered most likely because it is the easiest color property to manipulate experientially. However, lightness and chroma also undoubtedly have implications for psychological functioning. Finally, it is also likely that many situational (Bubl et al. 2010) and intrapersonal (Fetterman et al. 2015) factors influence color perception, such as the concept of color preference (Palmer and Schloss 2010). The complexity of color as a stimulus capable of creating psychological effects needs more attention and further scientific research in this regard, for while much has been done, just as much remains unexplored.

### **THE LIGHTNESS EFFECT**

We will focus on the importance of one of the fundamental dimensions of color, lightness, which is just as important, if not more so, than hue. For many years it has been known that light directly influences physiology and increases arousal (Cajochen 2007). In the field of neuropsychology, cognitive performance refers to the ability of the human mind to acquire, store and process information, to solve problems of any kind; from the simplest ones, such as the needs of daily life, to others decidedly more complex, such as the level of subjective vigilance and the level of alertness that involve the brain, and in particular the attentional process. Here it is crucial to make an important distinction; lightness is the ingredient that specifies the amount of white or black present in the perceived color (Gilchrist 2007). Determining the amount of white or black in a color spot is possible either out of context or in context. However, the type of evaluation that allows us to accurately determine the level of grey (the distance from the two extremes of white and black) in a color is contextual. To demonstrate the correctness of this statement, we must first introduce a terminological distinction. We can, therefore, call brightness the total amount of light perceived, emitted from a source, or reflected from a surface. The evaluation of this quantity is a non-contextual judgment, but dependent only on the perceptual effect of light incident on the retina. On the other hand, we define lightness (or value) as the amount of light coming from an object, compared to the amount of light coming from a white surface subjected to the same illumination. This is a contextual evaluation. There are non-visual effects of lightness that affect the human body through direct action on the human nervous system and with consequences that affect alertness level (attentional process) mood (or emotion), behavior and other human physiological parameters such as heart rate and body temperature. In general, light and lightness represent the core of the visual perception process through transduction, the process by which the radiant energy of environmental stimuli is converted into neural activity. Leaving aside the difference between natural and artificial light, which have significant differences between them, we will focus on the concept of lightness in general without making this distinction. The effects of light on psychological components can be divided into several "categories" encompassing all human cognitive functions.



### **The lightness effect on emotion**

The emotions triggered by the external environment change the individual's internal state, affecting the regulation of body temperature, mainly due to endogenous phenomena such as sweating and vasodilation. In some cases, light with color shades that turn toward red induces a feeling of greater environmental warmth than light that turns toward blue (Te Kulve et al. 2016). However, the latter type of research results is sometimes contradictory because psychological factors may also come into play, leading to different results in different social and cultural contexts. A non-pathological condition, winter depression or seasonal affective disorder (SAD) is a disorder that affects people during the winter who usually are healthy during other seasons of the year (Targum and Rosenthal 2008). The symptoms are those types of depression, such as lack of energy, tendency to sleep a lot, insomnia, and difficulty concentrating. How color relates to emotions is the subject of much psychological research, but the results are difficult to assess for practical use. The reasons for this are both technical and conceptual. On the technical side, color-emotion data have been collected using experimental methods that vary widely in precision and scope, as described below. If we wanted to list all the studies on the subject of color (or lightness) associated with psychological characteristics, a review would not be enough.

### **The lightness effect on Attention**

Visual attention comprises a set of mechanisms that modulate sensory and cognitive processing to select the most behaviorally relevant stimuli for further limited-capacity processing. The effects of light and lightness are visible in human behavior. These include changes throughout the day (circadian rhythm). Reaction times are generally longer in the early morning and decrease for the day, only to increase during the night and peak in the early morning. These measures reflect other diurnal changes such as body temperature and cortisol secretion. This essentially modifies an attentional mechanism called alertness. For example, the psychophysiological and behavioral effects mediated by light stimulation assess differences in illumination (Badia et al. 1991). The level of alertness, assessed with EEG through beta brain waves (14-30 hertz), showed a significant increase in the strong light condition, which also decreased drowsiness and increased body temperature, going to modulate the alert attentional state. Another relevant study (Cajochen 2007) focused on the chromatic component of light (blue light); in the blue light condition, in addition to observing a reduction in melatonin, there was an increase in body temperature, heart rate, and level of alertness of the subjects involved. This did not occur with exposure to yellow light. Similar results were also observed in a typical office setting (Smolders et al. 2012). The results showed that with the brighter lighting, the subjects had shorter reaction times, higher alertness levels, and increased heart rate, especially towards the end of the hour of exposure to the stronger light.

### **The lightness effect on Memory**

Memory is now defined in psychology as the ability to encode, store, and retrieve information; focusing on these processes, one research study investigated the effects of different wavelengths of light on brain waves associated with memory processes (Okamoto and Nakagawa 2016). Cortical activity was monitored using magnetoencephalography (MEG). The experiment was conducted by exposing subjects for 30 minutes (during the day) to two different lighting conditions, green light, and blue light. The results showed that blue light increased cortical activity related to the active maintenance of working memory. Similar results were also observed in research in which, instead of monochromatic lights, they used two white lights, 3,000 (warm light) and 5,000 K (cool light), noting that the 5,000 K light stimulates the central nervous system more (Noguchi and Sakaguchi 1999).

Working memory in the human cognitive system is a part of memory, with a time-limited capacity that supports the temporary storage of information available for brain processing. This cognitive structure is essential in reasoning and in guiding decision-making and behavioral processes.

### **The lightness effect on Decision-Making**

A popular way to study decision-making is undoubtedly the studies on consumers. Recent studies in this field are studies on cross-modal associations. In this regard, the lightness of the color is associated with characteristics such as hot-cold or sad-happy. The effects of the new correspondences between somatosensory and visual perceptions extend from capturing visual attention to preference formation and how attitudes toward sensory experiences play a critical role in preference formation. The results showed cross-modal correspondences between the sensation of warm and light colors (Motoki et al. 2019). Recognition of the impact of sensory experiences in natural shopping environments has led to increased attention to the effects of such experiences on consumer behavior (Krishna et al. 2017). Still, other studies show how the color of a dark (versus light) product encourages higher durability ratings but lower ease-of-use ratings (e.g., a pc) (Hagtvedt 2020). These influences are related to the impact of color lightness on perceived weight: darker (compared to lighter) colors cause objects to appear heavier. However, there is still little evidence in this area of study.

### **CONCLUSION**

The effects of light are varied and are not limited only to the effects we have mentioned above. We could go on and on describing other effects of light and lightness on cognitive performance, but while much has been done so far, it is also true that not enough has been done, due to the individual limitations placed on examination above, placing more significant blame on the scientifically unrigorous way of conducting such research in the field. Moreover, the study of psychological effects related to color is a very hot topic, and one should approach it more cautiously without drawing hasty and universal conclusions. Color is too complex a phenomenon or concept to "take lightly" its study, then associated with cognitive functions is an even more difficult task because of the many variables involved. Just think of the physical characteristics related to color and how difficult it can be to study them rigorously if you then have the "scientific presumption" to associate them to psychological characteristics without taking into account variables such as context and individual variables (just to mention a few) you fall into error. This work shows various limits of research in this field, and it is hoped that this overview will let us think about the complexity of the stimulus and the importance of its decomposition into physical characteristics. Perhaps by studying these characteristics individually, giving them all the proper importance, it will be possible to obtain a more accurate result than those obtained so far.

### **REFERENCES**

- Badia, P. et al. 1991. Bright light effects on body temperature, alertness, EEG and behavior. *Physiology and Behavior* 50(3):583-588. doi: 10.1016/0031-9384(91)90549-4.
- Bubl, E. et al. 2010. Seeing gray when feeling blue? Depression can be measured in the eye of the diseased. *Biological Psychiatry* 68(2): 205-208. doi: 10.1016/j.biopsych.2010.02.009.
- Cajochen, C. 2007. Alerting effects of light. *Sleep Medicine Reviews* 11(6): 453-464. doi: 10.1016/j.smr.2007.07.009.
- Elliot, A. J. 2015. Color and psychological functioning: A review of theoretical and empirical work. *Frontiers in Psychology* 6(APR):1-8. doi: 10.3389/fpsyg.2015.00368.

- Elliot, A. J., and M. A. Maier. 2014. Color psychology: Effects of perceiving color on psychological functioning in humans. *Annual Review of Psychology* 65: 95-120. doi: 10.1146/annurev-psych-010213-115035.
- Fairchild, M. D. 2015. Seeing, adapting to, and reproducing the appearance of nature. *Applied Optics* 54(4): B107. doi: 10.1364/ao.54.00b107.
- Fetterman, A. K., T. Liu, and M. D. Robinson. 2015. Extending Color Psychology to the Personality Realm: Interpersonal Hostility Varies by Red Preferences and Perceptual Biases. *Journal of Personality* 83(1): 106-116. doi: 10.1111/jopy.12087.
- Figueiro, M. G., and M. S. Rea. 2016. Office lighting and personal light exposures in two seasons: Impact on sleep and mood. *Lighting Research and Technology* 48(3): 352-364. doi: 10.1177/1477153514564098.
- Figueiro, M., and D. Overington. 2016. Self-luminous devices and melatonin suppression in adolescents. *Lighting Research and Technology* 48(8): 966-975. doi: 10.1177/1477153515584979.
- Frank, M. G., and T. Gilovich. 1988. The Dark Side of Self- and Social Perception: Black Uniforms and Aggression in Professional Sports. *Journal of Personality and Social Psychology* 54(1): 74-85. doi: 10.1037/0022-3514.54.1.74.
- Geisler, W. S. 1989. Sequential Ideal-Observer Analysis of Visual Discriminations. *Psychological Review* 96(2): 267-314. doi: 10.1037/0033-295X.96.2.267.
- Gilchrist, A. L. 2007. Lightness and brightness. *Current biology: CB*, 17(8): R267-9. doi: 10.1016/j.cub.2007.01.040.
- Hagtvedt, H. 2020. Dark is durable, light is user-friendly: The impact of color lightness on two product attribute judgments. *Psychology and Marketing* 37(7): 864-875. doi: 10.1002/mar.21268.
- Krishna, A., L. Cian, and N. Z. Aydinoglu. 2017. Sensory Aspects of Package Design. *Journal of Retailing*, 93(1): 43-54. doi: 10.1016/j.jretai.2016.12.002.
- Mammarella, N. et al. 2016. When green is positive and red is negative: Aging and the influence of color on emotional memories. *Psychology and Aging* 31(8):914-926. doi: 10.1037/pag0000122.
- Motoki, K. et al. 2019. Light colors and comfortable warmth: Crossmodal correspondences between thermal sensations and color lightness influence consumer behavior. *Food Quality and Preference* 72(November 2018): 45-55. doi: 10.1016/j.foodqual.2018.09.004.
- Noguchi, H., and T. Sakaguchi. 1999. Effect of Illuminance and Color Temperature on Lowering of Physiological Activity. *Applied Human Science* 18(4): 117-123.
- Okamoto, Y., and S. Nakagawa. 2016. Effects of light wavelength on MEG ERD/ERS during a working memory task. *International Journal of Psychophysiology* 104: 10-16. doi: 10.1016/j.ijpsycho.2016.03.008.
- Palmer, S. E., and K. B. Schloss. 2010. An ecological valence theory of human color preference. *Proceedings of the National Academy of Sciences of the United States of America* 107(19): 8877-8882. doi: 10.1073/pnas.0906172107.
- Pazda, A. D., A. J. Elliot, and T. Greitemeyer. 2014. Perceived sexual receptivity and fashionableness: Separate paths linking red and black to perceived attractiveness. *Color Research and Application* 39(2): 208-212. doi: 10.1002/col.21804.
- Smolders, K. C. H. J., Y. A. W. de Kort, and P. J. M. Cluitmans. 2012. A higher illuminance induces alertness even during office hours: Findings on subjective measures, task performance and heart rate measures. *Physiology and Behavior* 107(1): 7-16. doi: 10.1016/j.physbeh.2012.04.028.
- Targum, S. D., and N. Rosenthal. 2008. Research to Practice what are the clinical symptoms of seasonal affected by seasonal mood genetic predisposition findings that support the distinction between these.
- Te Kulve, M. et al. 2016. The influence of light on thermal responses. *Acta Physiologica* 216(2): 163-185. doi: 10.1111/apha.12552.
- Valdez, P., and A. Mehrabian. 1994. Effects of Color on Emotions. *Journal of Experimental Psychology: General* 123(4): 394-409. doi: 10.1037/0096-3445.123.4.394.

# Color as a therapeutic adjuvant: theories and applications in the hospital setting

Anna Marotta <sup>1,\*</sup> and Alessandra Brosio <sup>2</sup>

<sup>1</sup> Politecnico di Torino; nannarella.marotta@gmail.com, alessandrabrosio@libero.it

\* Corresponding author: nannarella.marotta@gmail.com

## Abstract

If in the past the hospital was conceived as a mere container of professional skills, whose success was linked to the preparation and skills of individual professionals, today hospitals define their goals on basis of user demand.

The quality that is sought is no longer just the health one, but also takes into consideration all the sensory perceptions that an individual, in an evident state of illness or not, can perceive.

Medical staff and patients are influenced by the environment in which they spend most of their time; each structure, as a whole, conveys important non-verbal messages that can be perceived and interpreted in a positive or negative sense and consequently have repercussions on the outcomes of their work and of the treatments themselves.

The present contribution therefore aims to compare some outcomes resulting from the application of theories, consolidated and modern, and of consciously conducted experiments, with shareable results.

**Keywords:** *humanization, well-being, multisensory perception, care*

## INTRODUCTION

Over the years, scientific advances have opened new horizons, guaranteeing a higher life expectancy and it has passed from the concept of "cure" to that of "care", in which the protagonist of the health intervention is no longer the disease but the patient, "complex" person with physical, psychological and social socio-cultural characteristics, unique needs and desires in constant change.

However, with the evolution of these aspects, health facilities have often remained the same, in many cases becoming dilapidated and obsolete.

A careful planning of hospital environments is therefore of primary importance (see Figure 1), as a reasoned use of color and the creation of a comfortable environment not only improve the quality of life in hospital stays, but can be considered "therapeutic adjuvants" in the patient's response.

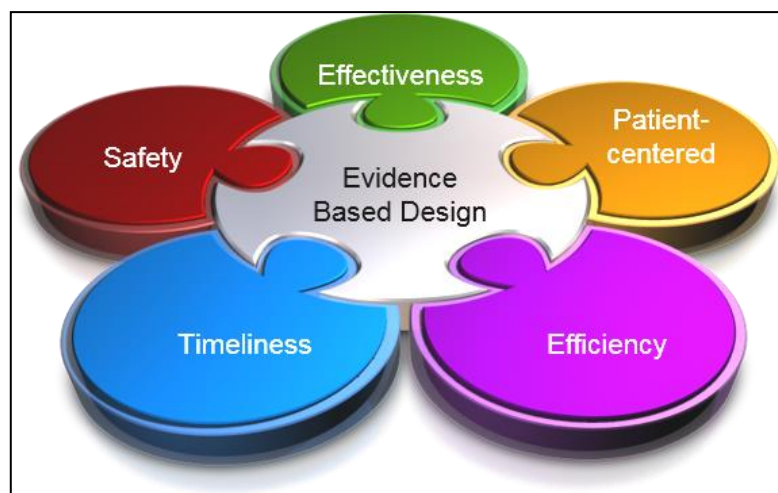

Figure 1: Fundamental criteria of Evidence Based Design.

<https://www.bancroft-ae.com/evidence-based-design-philosophy/>

To achieve this goal, a thorough knowledge of the historical and cultural roots in which the multiple theories on color were born and developed are indispensable; in fact, they make complementary contributions to each other in the realization of an organic project and act as an essential matrix for all forms of intervention, from scratch and on the existing one.

The limited space that is granted to us does not allow the necessary lists of the 48 individual authors and related theories, including the disciplinary contributions that are taken as a basis, for which reference is made to figure 2.

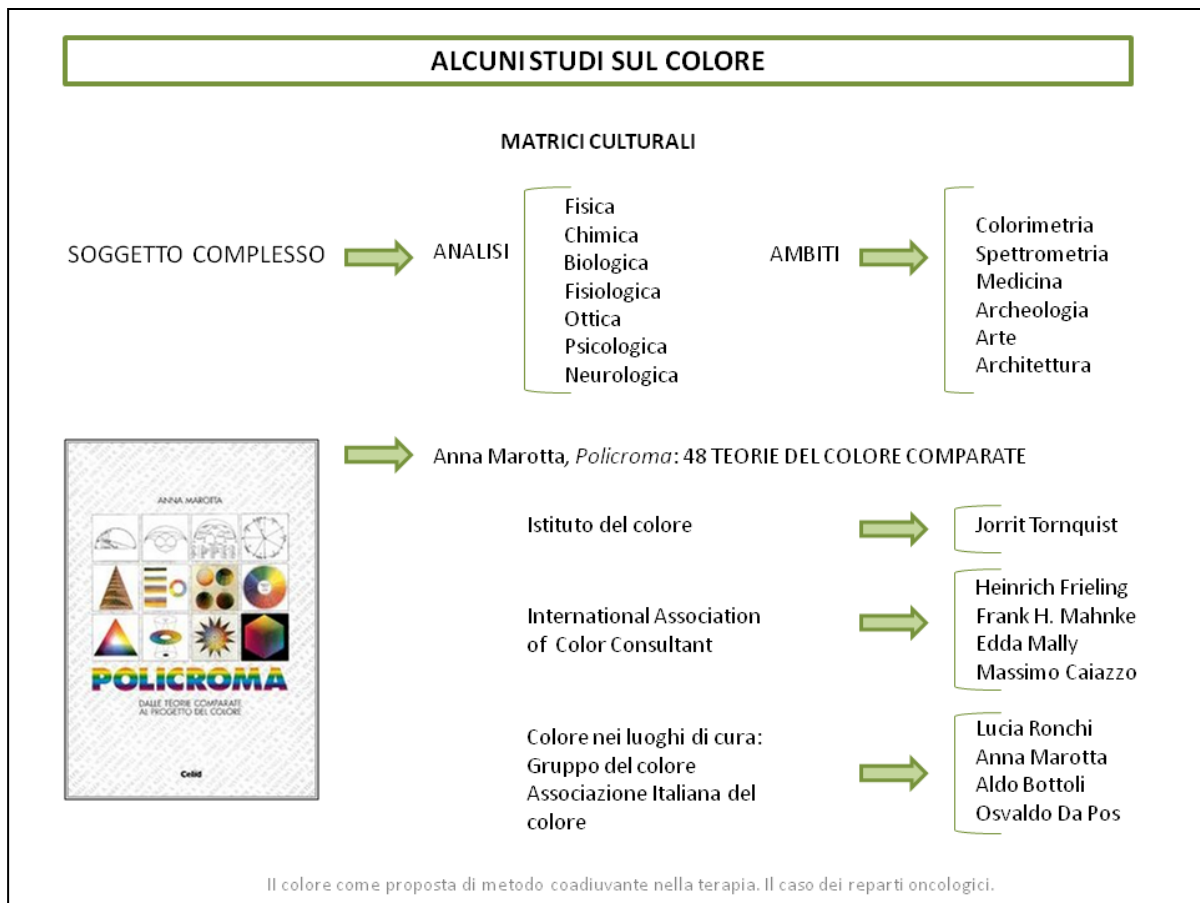

Figure 2: Study of color and related cultural matrices. Daniela Mosso, Color as a proposal for an adjuvant method in therapy. The case of oncology departments, Master's degree thesis in Architecture, Politecnico di Torino, 2014.

The common intent of each project must therefore be to achieve a dynamic systematization of the approach to color contextualized in the present, thanks also to new technological and IT resources.

In fact, introducing the most advanced digital technologies, including interactive ones, will allow patients (of all ages, genders and pathologies) to modify the chromatic and luminous structure of the environments, to dialogue with the spaces, sensations and visual information. Examples of best practices in the use of virtual and augmented reality have already been adopted in numerous hospitals (one among many, the interactive Nature Trail wall by Jason Bruges for the Great Ormond Street Hospital for Children in London), as well as the use of stimulation multisensory (olfactory and visual pathways).

### ***Frequentia and Variatio: the Nature Trail of London***

Conceived and designed for children and adults, this art work runs along the internal walls of some corridors of the structure, precisely those that lead to the anesthesia room (see Figure 3). The intent was to relax, distract and personally involve the little patients with a Nature Trail: the walls have been transformed into a point-like canvas which, if touched, comes alive with the creatures of the forest (horses, deer, porcupines, frogs and others).

The work essentially consists of two elements: the integrated LED panels and the custom-designed graphic wallpaper, which reproduces the trees and foliage of the forest.

These are therefore digital surfaces that, barely touched, recreate interactive animated models made of light that appear as if hidden among the trees and foliage of a virtual forest.

The LED panels are incorporated into the wall surface at different heights so that they can be used by children of different ages. The work consists of 70 LED panels, for a total of 72,000 LEDs.

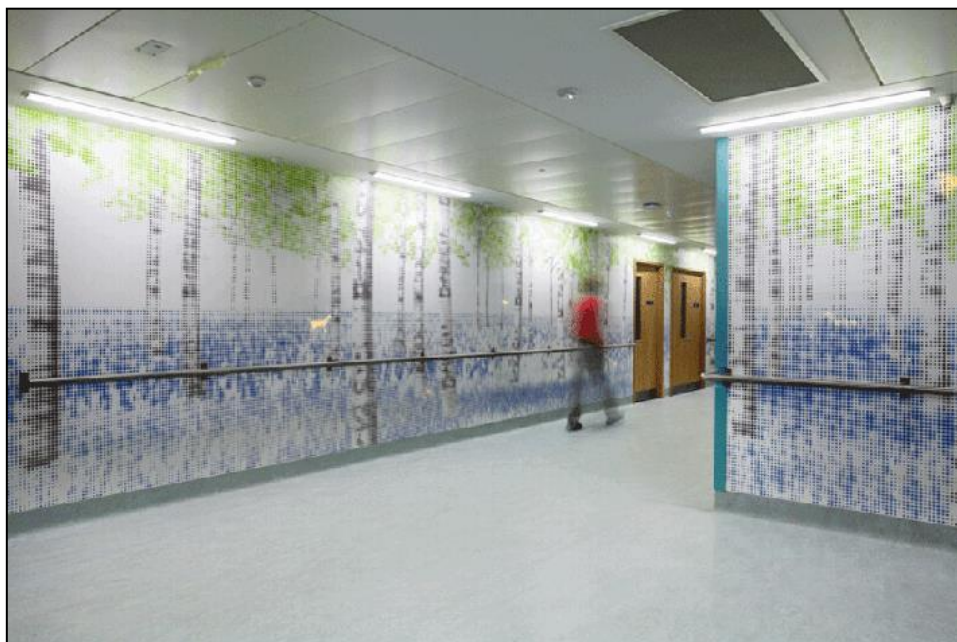

Figure 3: "Nature Trail", 2013 installation by Jason Bruges Studio, characterized by the "lightness" of green and the effects of transparency.

<https://www.dandad.org/awards/professional/2013/spatial-design/19919/nature-trail/>

### **Nature and color: Evelina London Children's Hospital**

Also in London, the Evelina Children's Hospital was designed with the little patients who experience it every day in mind, so much so that the children were consulted by the designers on what they most wanted to see around them (see Figure 4).

The building, on the south bank of the Thames near St Thomas', is spread over seven floors and includes a large greenhouse in the center, which extends for its entire length of 100 meters and occupies four floors in height, topped by a roof. in glass that radiates light throughout the building.

The glass facade offers a spectacular view over the city.

The central theme is nature, with a vertical path that starts from the "sea" to reach the sky. The floors are named after different realms of the natural world, while the floor nicknamed The Beach has a playground, restaurant, and school for long-term patients.



The hospital was designed to be adaptable, with flexible partitions and mobile structures throughout the building.

Since the facility serves a diverse community where 140 languages are spoken, colors, visual/thematic symbols and artwork have been used for easier access to information.



Figure 4: Reception and “Starslide”, 2005. Commissioned by Guy's and St Thomas' Charity for Evelina Childrens Hospital in London, designed by Michael Hopkins Architects. The contrast between saturated colors and white surfaces creates an effect of great vitality. <http://www.lilianeijn.com/portfolio-item/starslide-2005/>

### **Perceive to heal: l'IRCCS Auxologico Italiano di Milano**

The “CAVE” project is being tested in this facility, in which virtual reality is used to improve the motor/cognitive skills of patients with permanent and temporary deficits.

The CAVE is a virtual room where the Virtual Immersive Telepresence (TIV) is experienced, an integrated system that allows to reconstruct a real reality, considering the cognitive stresses (see Figure 5).

Currently the stimuli are only auditory and visual in nature but in the future they will also be olfactory and tactile.

Thanks to the stereostop 3D vision, linked to a position tracking system, the system allows a correct reading of spaces, colors, lights, volumes and distances, thus giving the distinct sensation of being immersed within the virtual scene projected on the screens. A concrete example is that of the patient's simulation of purchasing some products in a supermarket, a situation that could easily recur once the patient is discharged. The simulations are very useful in cases of stroke and in the early stages of senile dementia and Parkinson's.

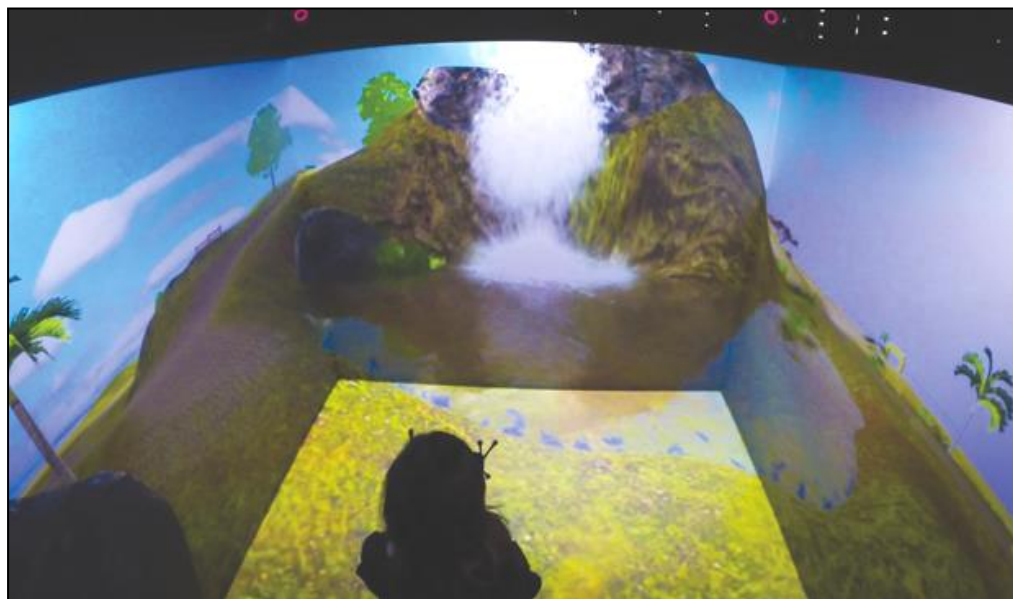

Figure 5: “CAVE”, IRCCS Auxologico Italiano di Milano.

The effect (also chromatic and luministic) of great likelihood facilitates polysensory tests.

<https://www.pisamedica.it/2016/06/nasce-lera-della-cybertherapy-il-futuro-si-chiama-realta-virtuale>

The advantages over traditional techniques are represented by the possibility of carrying out the rehabilitation exercise in a safe and controlled environment which nevertheless faithfully reproduces the characteristics of the environments and the systematic monitoring of performance indicators during the rehabilitation exercise.

## **CONCLUSIONS**

The examples proposed here, in extremely concise and incomplete terms, only confirm the complexity and the need for various types of approaches: ... The main road to be pursued is that of continuity of research, especially in their disciplinary, interdisciplinary intersections, with increasing attention to technologies and interactive results up to immersion, in their applications, but always attentive to humanization.

Color, in all its functions and components, should always be integrated into the architectural design phase (of the new or existing) -

Finally, the same project should always be tested, in order to evaluate its efficacy and psycho / physiological benefits on patients and users of the health centers.

## **REFERENCES**

- Bonaldi, A. 2006. *Evidence Based Design. Ambiente ospedaliero e salute*, 1° Forum italiano per la valutazione delle tecnologie sanitarie, Trento 19 - 21 gennaio 2006.
- Brosio, A. 2016. *Ruolo del colore e delle afferenze multisensoriali nei criteri per la progettazione e la riqualificazione delle strutture sanitarie: il punto di vista degli esperti e degli utenti*, tesi di L.M., Politecnico di Torino, rel. A. Marotta, 2016.
- Cannavici, C. 2014. *Il Colore come Bene Culturale nell'Architettura. Cromie per il benessere nell'ospedale umanizzato*, tesi di L.M., Politecnico di Torino, 2014.
- Giuliano, C. 2002. *Cromie per il benessere*, Tesi di Laurea, Rel. A. Marotta, Politecnico di Torino. Facoltà di Architettura, Corso di Laurea in Architettura, 2002.



- Marotta, A. 1999. *Policroma. Dalle teorie comparate al progetto del colore*, Celid.
- Marotta, A. 2013. *"Architettura terapeutica": colore, decorazione, movimento nell'umanizzazione negli ospedali*. Torino: Raffaele Bernardini.
- Mello, P. 2000. *L'ospedale ridefinito. Soluzioni e ipotesi a confronto*. Firenze: Alinea.
- Mosso, D. 2014. *Il colore come proposta di metodo coadiuvante nella terapia: il caso dei reparti oncologici*, tesi di L.M., Politecnico di Torino, rel. Anna Marotta, 2014.
- Wood, S., E. Wood, and D. Boyd. 2013. *Sensation and perception, in The world of psychology*. Pearson: New International Edition.
- Nature trail, Jason Bruges Studio, DESIGN, 9 FEBBRAIO 2013.  
<http://www.designplayground.it/2013/02/nature-trail-jason-bruges-studio/>
- Nature Trail: una foresta animata a Led verso la sala operatoria, 16 Luglio 2013, News NULL.  
<https://officebit.com/nature-trail-una-foresta-animata-a-led-verso-la-sala-operatoria.htm>
- Progetto CAVE, IRCCS Auxologico di Milano, 2016.  
<https://www.supereva.it/un-ospedale-italiano-guarisce-con-la-realta-virtuale-i-pazienti-con-problemi-neurologici-19698>

# Colour shift due to Chromogenic dynamic glass

Barbara Matusiak<sup>1,\*</sup>, Marzieh Nazari<sup>1</sup> and Kine Angelo<sup>1</sup>

<sup>1</sup> Norwegian University of Science and Technology NTNU, Norway;

\* Corresponding author: barbara.matusiak@ntnu.no

## Abstract

Visual and thermal comfort are crucial for users' well-being and work efficiency. The solar radiation through windows may become a source of thermal and visual discomfort. A Chromogenic Dynamic Glass is being tested in the Test-cell at NTNU, Norway, as a promising glass that automatically adjusts the light transmittance according to the weather conditions. As the glass has a colour tinge, technical measurements and the visual evaluations of colour were done in following scenarios: No glass, clear Reference glass and the Smart glass (Chromogenic). The results show a clear difference in perception of colours between the Reference and the Smart glass. The Smart glass behaves differently in sunny conditions (shift toward green, washed-up colours, especially red and purple) and overcast conditions (shift toward yellow, more colourful). The Smart glass makes colour compositions (besides the monochromatic yellow) less harmonious, slightly cooler, faded and sombre, and less sharp, especially in overcast condition.

**Keywords:** *Colour shift, Smart Glazing, SPD, Visual Evaluation, Window.*

## INTRODUCTION

Daylighting is a critical environmental aspect with a profound impact on the human perception of spaces (Steane et al. 2004; Boyce 2003; Pallasmaa 2012), productivity, satisfaction and health of residence in the built environments (Galasiu et al. 2006; Aries et al. 2015; Khademagha et al. 2016). Visual and thermal comfort is crucial for occupant's well-being and work efficiency. However to provide visual comfort (avoiding glare risk) and improve energy saving (preventing overheating) the main strategy was to limit sunlight in architectural spaces (Corrodi et al. 2014). Operable sun-shading systems are theoretically the most energy effective devices for thermal comfort assurance. Nevertheless, they are also the most problematic building elements regarding maintenance. Smart glazing such as Electrochromic or Photochromic glasses enables gradual or stepwise adjustment of light transmittance according to daylight conditions and occupants needs. However, this also is not without side effect in a form of serious colour shifts.

Previous studies conducted at NTNU by (Angelo et al. 2012)'s and (Arbab et al. 2017, 2018) indicate that even a clear glazing (2-3 layers) can cause minor colour distortions and that the electrochromic glass was the one causing the strongest shift, toward the blue. The present study examines the Chromogenic dynamic window glass, a promising glass that automatically adjusts the light transmittance according to the weather conditions and voltage. The study consists of technical measurements and three steps of visual evaluation VE1, VE2 and VE3 aiming to evaluate differences in SPD, chromaticity coordinates and human colour perception due to the use of this glazing.

## METHODOLOGY

Three scenarios were created: 1. No glazing (open window), 2. A reference Clear Glazing (Pilkington optifloat double clear 4mm, Optitherm S1) and 3. ChromoGenics Dynamic Glass (ChromoGenics AB, Altechs 1 EN12150) called Smart glass as it reacts by increase/decrease of coloration (and transmittance) to the solar radiation fluctuation (temp. and light) and to applied voltage, Table 1 shows the maximum and the minimum settings applied in the study.

Glasses	Sunny_ Maximum coloration		Overcast_ Minimum coloration	
	Visual Transmittance ( $\tau_{vis}$ )	Visual Transmissivity ( $T_n$ )	Visual Transmittance ( $\tau_{vis}$ )	Visual Transmissivity ( $T_n$ )
Clear Glazing	0.69	0.75	0.61	0.66
Smart Glazing	0.25	0.27	0.58	0.65

Table 1: The visual Transmittance and Visual Transmissivity of the glasses.

The location of the experiment was the Test Cell Laboratory, at NTNU university, Trondheim, Norway (63° N, 10° E). The used room has a window wall oriented to the south with the Smart glass fastened to it temporarily for the purpose of the study, with the voltage source connected directly to the glass. Two boxes with the dimensions of 40x40x70cm, representing a scaled model of the room, were positioned in the front of the window wall. A portable Clear glass was mounted in the front of the box on the left side (Reference), while the box to the right directly touched the Smart glass (Test room). Eight standard CIE color samples plus one color added by Arbab et al. (2017) were used.



Figure 1: (Left and middle) Setting of the experiment in the Test Cell, views from the inside and the outside. (Right) the nine colour samples.

Colours	NCS Notation	Munsell notation	Appearance in Daylight
Sample 1	NCS S 2050-G10Y	2.5 G 6/6	Light green
Sample 2	NCS S 2040-R60B	2.5 P 6/8	Light violet
Sample 3*	NCS S 3020-Y50R	5 YR 6/4	Light yellowish red
Sample 4	NCS S 3020-Y90R	7.5 R 6/4	Light greyish red
Sample 5	NCS S 2040-R40B	10 P 6/8	Light reddish purple
Sample 6	NCS S 2040-R80B	5 PB 6/8	Light blue
Sample 7	NCS S 3030-B50G	10 BG 6/4	Light bluish green
Sample 8	NCS S 2060-G40Y	5 GY 6/8	Strong yellow green
Sample 9	NCS S 4020-Y	5 Y 6/4	Dark greyish yellow

Table 2: Eight standard CIE colour samples and one extra \* (added to represent skin colour, Arbab et al. 2017).

### Measurements

The illuminance inside the scaled model boxes was measured with a luxmeter Hagner Model EC1, while Correlated Colour Temperature (CCT) and Spectrum Power Distribution (SPD) were measured using a spectroradiometer PR<sup>®</sup>-650 SpectraScan<sup>®</sup> Colorimeter PHOTORESEARCH. The SPD diagrams of colours were retrieved from the SpectraWin2 software, Table 3. The measurements of colour samples positioned outdoors were made alternatively through the Smart glass, Clear glass and through an open

window. Then, the CIE standard samples were placed indoors, and their SPD values were measured one by one inside the boxes for all three scenarios: No Glazing, Clear Glazing and Smart Glazing. All measurements and all Visual Evaluations were carried out in April 2021 in two scenarios: Sunny weather condition with the maximum coloration and Overcast weather with the minimum coloration.

**VE 1.: How the perception of outdoor colours change when seen through the Smart glass?**

Four trained observers perceived the nine selected colours exposed outdoors alternately through the clear and the Smart glass. They were asked to give scores on a five-step scale.

**VE 2.: How the perception of indoor colours change when illuminated by the daylight filtered by the Smart glass?**

The observers made visual matching between the nine colour samples placed in the Test room and the Reference room. The procedure can be compared to that which is used by an optician when testing eyeglasses; at first, we put identical colour samples in both chambers, and then systematically change the samples in the Reference room until we found the best match to the studied sample in the Test room. Prior to the observations, colour samples were chosen to give a wide distribution of hues and nuances, using the NCS System (see Figure 2).

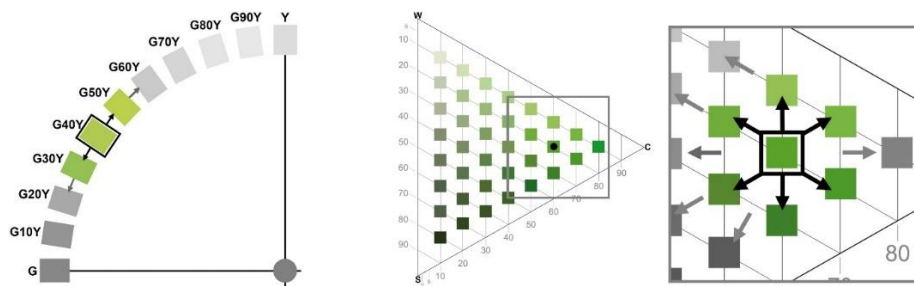

Figure 2: Illustration of principle of selection of test colours using the NCS system, using reference sample 8 (NCS S 2060-G40Y) as an example.

**VE 3. How the perception of indoor colour compositions change when illuminated by daylight filtered by the Smart glass?**

Four images, works of renowned photographer Joanna Kustra were chosen, Figure 3., since she is using principles of colour harmony during the development and retouching of her works.

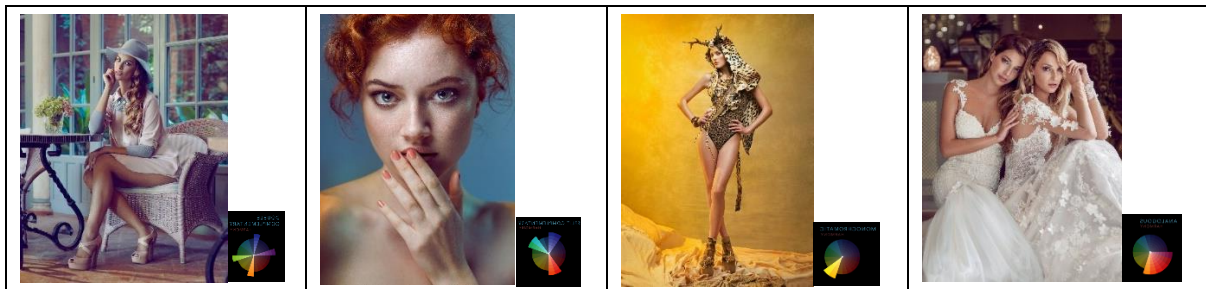

Figure 3: Images used in the visual evaluation of colour compositions, works of Joanna Kustra.

The colour harmonies used in the experiment were: 1 - Double Complementary, 2 - Split Complementary, 3 - Monochromatic, and 4 - Analogous harmony (neighboring hues). The split complementary (image 2) is made by one hue applied on the largest area (skin and hairs) and two hues

on the opposite side of the colour circle applied on smaller areas (bluish background and a hinge of green on the body. Double complementary (image 1) allows the largest number of hues.

Prior to the observations, pairs of words have been selected from the List of Words to Describe Colors <https://grammar.yourdictionary.com/grammar/word-lists/list-of-words-to-describe-colors.html> following two rules: i) the chosen words should fit in pairs with opposite meaning to make evaluation on a scale from the one quality to the opposite one, ii) the pairs should have a meaning when applied to a colour composition rather than to a single colour.

- |              |               |                    |             |
|--------------|---------------|--------------------|-------------|
| Harmonious – | Inharmonious, | Colorful –         | Washed out  |
| Warm –       | Cold,         | Vivid (contrast) – | Dim (faded) |
| Radiant –    | Somber,       | Sharp –            | Blur        |

**RESULTS**

The light measurements show considerable differences in the SPD, both between glasses, between sunny and overcast conditions and even between the measurement taken through the glass or not, Table 3. Figure 4 shows a colour shift of most of the colours toward green in the sunny, and even stronger shift toward yellow in the overcast conditions.

	Indoor		Through the Smart glass	
	Sunny (max coloration)	Overcast (min coloration)	Sunny (max coloration)	Overcast (min coloration)
Smart Glass				
Clear Glass				
No glass				
Sample 1 (S 2050-G10Y)				

Table 3: Spectral Radiance Distribution of colour Sample 1 in three scenarios.

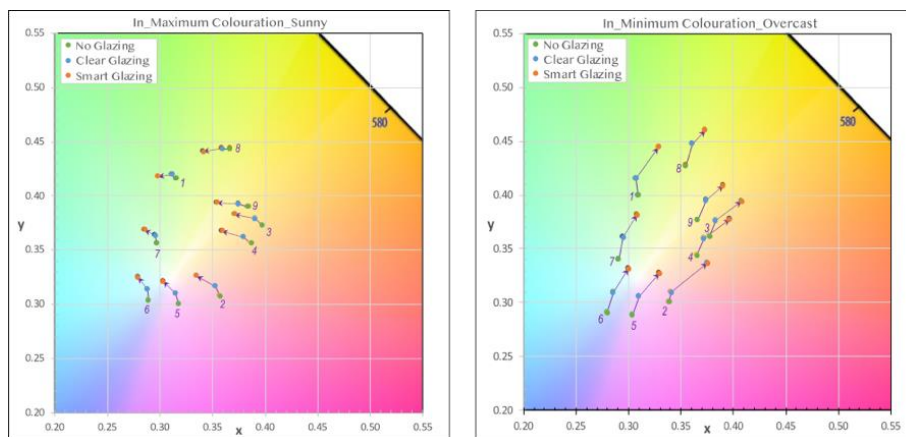

Figure 4: Colour in three scenarios shown on the section of the chromaticity diagram.

**VE1.** In the sunny weather, Colours 2 and 5 changed most, followed by 3, 4 and 9, i.e. when looking through the Smart glass, i.e. the violet-pink colours followed by reddish colours will be most changed. In the overcast condition, the colour change will not be that strong and the colours most affected are 1,2,6,7,8, i.e. blue and green.

**VE 2.** The results were analysed with the help of the NCS System (see figure 5).

a) In general, results of the observations in sunny conditions show that the strongest tendency is that green colours are less affected by the glazing. Most hues shift in the direction towards green, and most nuances will be perceived slightly muted (10%) except for the clearest green nuance that will be enhanced (no. 1). The yellow hue (no. 9) has the largest shift in hue (20%), the nuance is stable.

b) In general, results of the observations in overcast conditions show that the strongest tendency is that samples containing noticeable amount of red are mostly affected by the glazing in hue but least affected in nuance. The yellow colour (no. 9) is the most stable colour in both hue and nuance. Hues containing noticeable amount of red and green both shift in the direction towards yellow, while hues containing noticeable amount of blue are stable.

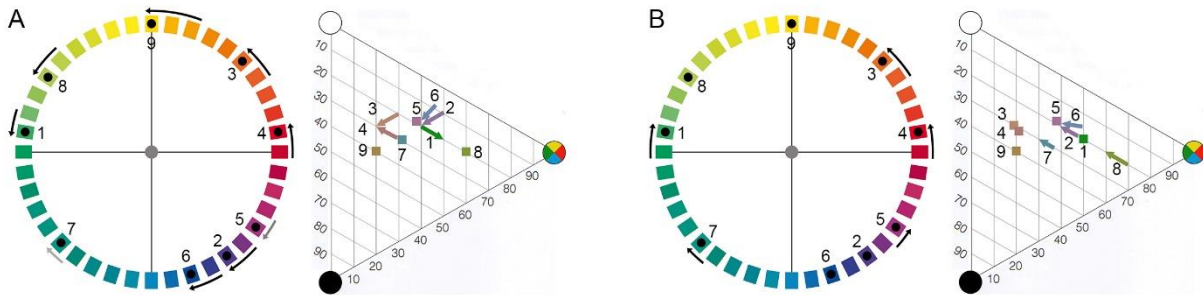

Figure 5: Illustration of colour shift when analysing test results from observations. A shows results for colour shift in sunny weather conditions, and B shows results for colour shift in overcast weather conditions. The direction of the arrows shows the direction in which a colour would be perceived. Example colour 8; for a colour to be perceived as NCS S 2060-G40Y one would have to use NCS S 2060-G50Y in overcast weather conditions, but the colour is relatively stable in sunny weather conditions.

VE 3. The conclusions were formulated only if three of four experts voted similarly, e.g. T to the right of R on the 5-point scale with opposite words on the poles.

### Colour composition results

For most of the quality descriptors the results were similar for Overcast and for Clear sky with sun. Under both conditions in the Test room the images were perceived as less harmonious, slightly cooler, more faded and sombre, also less sharp. Astonishingly, the Colourful – Washed out quality was evaluated differently. In the sunny conditions the colours in the images were perceived as washed-up, while in the Overcast conditions as more colourful. Following observations have been done regarding the use of images.

Image 1 (double complementary) gave the clearest results, which means that the image is perceived significantly different in the Test room compared to the Reference room, good agreement.

Image 2 (split complementary) also gives many answers, still vivid-faded and radiant-sombre for Sunny, and harmonious-inharmonious, and warm-cold for Overcast could not be evaluated, no agreement.

Image 3 (mono) is perceived as less different in the Test room compared to the Reference room, as expected, due to the monochromatic colour composition (nuances of yellow). Images similar to this one, having monochromatic colour harmony, are not recommended in colour evaluation studies, even though the yellow colour is known as the one having the widest SPD of all colours, but interior decoration in the monochromatic yellows are recommended in rooms with Smart glazing.

Image 4 (analogous) functioned slightly better than Image 3, but much worse than image 1.

## CONCLUSIONS

A Chromogenic Dynamic Glass has been tested as a promising future window glass that automatically adjusts the light transmittance according to the weather conditions and voltage. As the glass has a dynamic colour tinge, technical measurements and the visual evaluations of colour were done to test colour behaviour in following scenarios: No glass, clear Reference glass and the Smart glass. The results show a clear difference in colour perception between the Reference glass and the Smart glass, which makes colour compositions (besides of the monochromatic compositions) less harmonious, slightly cooler, more faded, sombre, and less sharp. The Smart glass behaves differently in sunny conditions (shift toward green, washed-up colours, especially red and purple) and overcast conditions (strong shift toward yellow and more colourful). When looking through the Smart glass most significant difference was registered for the violet-pink and reddish colours in Sunny conditions.

## ACKNOWLEDGEMENTS

The authors acknowledge very good and supportive cooperation with the SINTEF, HVIT project.

## REFERENCES

- Kine, A., B. Szybinska Matusiak, and K. Fridell Anter. 2012. Colour shift behind modern glazing. *Proceedings of the Interim Meeting of the International Color Association (AIC 2012)*, 52-44.
- Arbab, S., B. Szybinska Matusiak, and C. A. Klöckner. 2018. Colour shift of interior surfaces with advanced glazings. *Journal of the International Colour Association* 21:10-35.
- Arbab, S., B. Szybinska Matusiak, F.A. Martinsen, and B. Hauback. 2017. The impact of advanced glazing on colour perception.
- Aries, M. B. C., M. P.J. Aarts, and J. van Hoof. 2015. Daylight and health: A review of the evidence and consequences for the built environment. *Lighting Research & Technology* 47 (1):6-27.
- Boyce, P.R. 2003. *Human Factors in Lighting*. Second Edition (2nd ed.) ed: Taylor & Francis.
- Corrodi, Michelle, and Klaus Spechtenhauser. 2014. *Illuminating: natural light in residential architecture*. Vol. 3: Walter de Gruyter.
- Galasiu, A. D., and J. A. Veitch. 2006. Occupant preferences and satisfaction with the luminous environment and control systems in daylight offices: a literature review. *Energy and buildings* 38 (7):728-742.
- Khademagha, P., M.B.C. Aries, A.L.P. Rosemann, and E.J. Van Loenen. 2016. Implementing non-image-forming effects of light in the built environment: A review on what we need. *Building and Environment* 108:263-272.
- Pallasmaa, J. 2012. *The eyes of the skin: architecture and the senses*: John Wiley & Sons.
- Steane, M.A., and K. Steemers. 2004. *Environmental diversity in architecture*: Routledge.

# ColorDoku 3d, gamification to improve perceptual color discrimination ability and spatial vision

Juan Serra <sup>1,\*</sup>, David de Andrés <sup>2</sup> and Ana Torres <sup>2</sup>

<sup>1</sup> Grupo de Investigación de Color en Arquitectura, Instituto de Restauración del Patrimonio, Universitat Politècnica de València; juanserra@ega.upv.es atorresb@ega.upv.es

<sup>2</sup> ITACA, Universitat Politècnica de València; ddandres@disca.upv.es

\* Corresponding author: juanserra@ega.upv.es

## Abstract

The description of color as a visual phenomenon with three perceptual variables, hue, value and saturation, resulted in different 3D color models since the beginning of the XIX<sup>th</sup> century. The ability to discriminate colors and organize them in the right order is a worth training for architects and artists, as it improves their sensitivity and expands their color abilities. Moreover, to have a robust spatial imagination is an essential skill for an architect, and so it is the understanding and manipulation of 3d objects. To merge the knowledge about regular polyhedra and color understanding, we have developed a digital app called ColorDoku 3d, in which the user can drag and drop the colors provided into the right faces of a solid to complete a 3d puzzle. This app is aligned with innovative pedagogical practices like gamification, that has demonstrated to be a good way to engage students in tough learning.

**Keywords:** *architecture, geometry, color order system, gamification, puzzle*

## INTRODUCTION

In the acquisition of skills to work with the color for an architect or an interior designer, it is important to train the visual discrimination of colors and to gain the sensitivity to display different colors in order. Both learnings are on the roots of the different color curricula in the architecture schools since the beginning of the XX<sup>th</sup> Century and are considered essential knowledge. Gamification demonstrates to be a good way of involving students in the acquisition of these skills that not only need a rational understanding of color theory, but also need to be naturally integrated as an instinctive skill, something that happens after a dedicated training. Digital color puzzles are good alternatives to train these abilities but it is noteworthy that, despite having color three perceptual variables, most of the available color puzzles keep working with just two dimensions of color. For this reason, we have developed a new app called ColorDoku 3d, to ease the understanding that color has three perceptual variables and to train the visual discrimination of these variables. The app also gives the opportunity to get familiar with interesting and difficult to understand polyhedron.

## THE TEACHING OF COLOR ORDER SYSTEMS IN ARCHITECTURE CURRICULA

The description of color as a visual phenomenon with three perceptual variables, hue, value and saturation, allowed the proposition of different three-dimensional models since the beginning of the XIX<sup>th</sup> century, with different shapes depending on the arrangement of the fundamental colors and specific nomenclatures for the variables (Nemcsis and Caivano 2015).

The ability to discriminate colors and organize them in the right order is a worth training for architects and artists, as it improves their sensitivity and expands their color abilities. For these reasons, almost all the modern color curricula for architects included the study of color circles and other similar organizations of colors with a certain logic (Hirschler et al. 2018). This was also the case of the basic courses at the *Bauhaus Dessau* and the *Hochschule für Gestaltung Ulm*, with important academics such as Albers, Itten, Maldonado, etc. (Campos and Moya 2021). In recent years, some of



ColorDoku 3d, gamification to improve perceptual color discrimination ability and spatial vision

the traditional color exercises shifted into a digital version, as it happened with the perennial Interaction of Color by Joseph Albers (Franco Taboada 2015). Nevertheless, some of these traditional exercises need personal involvement, are time-consuming, and not always are easy for generations of students and professionals that are becoming more impatient and less persistent (Bauman 2015). At the same time, in a completely digitalized society, gamification gives an opportunity to improve the color skills, and the pleasure of organizing colors in order is on the roots of a big number of digital games: Blendoku (Lonely Few 2015), Tinge (Suwao LLC 2019), Chroma (Noisy Duck 2021) and Chroma Rush (Lonely Few 2017). As indicated, all these apps have a two-dimensional interface and forget that color is a three dimensional perceptual phenomenon (Figure 1).

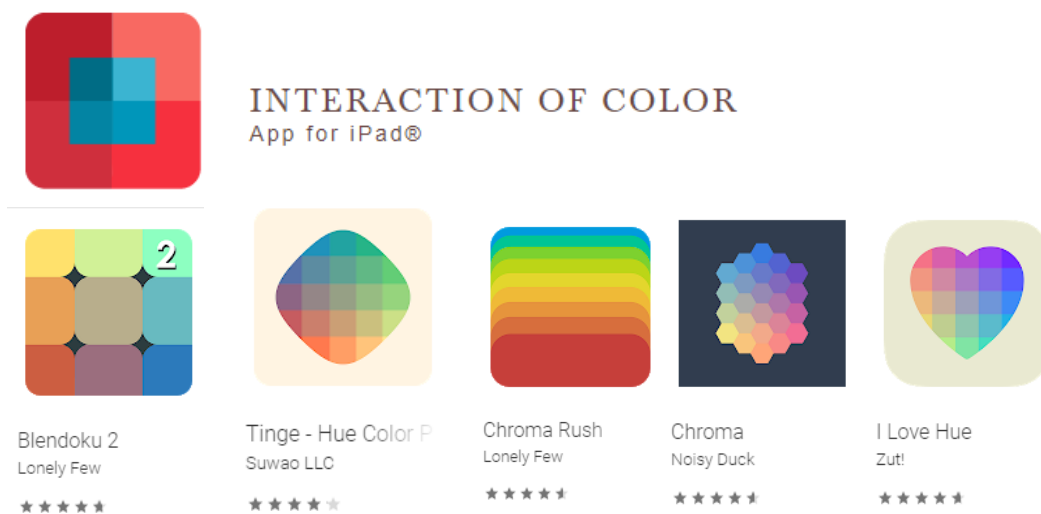

Figure 1: Icons of some popular color Apps. The first one, Interaction of Color, is a digital version of the traditional exercises of J. Albers in a digital way.

### **THE TEACHING OF REGULAR BODIES IN ARCHITECTURE CURRICULA**

To have a robust spatial imagination is an essential skill for an architect, and so it is the understanding and manipulation of three-dimensional objects. If we review the European history of architecture, this ability has traditionally been cultivated with the study of regular polyhedra with complex geometries that we find since the most important treatises of geometry belonging to the Renaissance period until today. This is the case of *De Divina Proportione* (1509) written by the mathematician Luca Pacioli and illustrated by Leonardo da Vinci, who used the most cutting edged graphic resources of that period to help in the understanding of the geometries, with skeletal solids that allowed an easy distinction between front and back edges (Figure 2a).

In the XIX<sup>th</sup> century, the color was also used as a graphic resource for a better understanding of geometry. This is the case of the founding text of geometry *The Elements* (*Στοιχεῖα*) written by Euclides (325-265 bC), that was reedited by Oliver Byrne in 1847 with graphical codes of colors replacing the original text (Higón-Calvet 2013). The combination of colors and geometry resulted in a very beautiful and easy to understand publication (Figure 2b). Nowadays, the videos and animated graphics with continuous movement seem to be the most adequate means of expression to explain and understand complex geometries.<sup>1</sup>

<sup>1</sup> <http://www.matematicasvisuales.com/index.html>

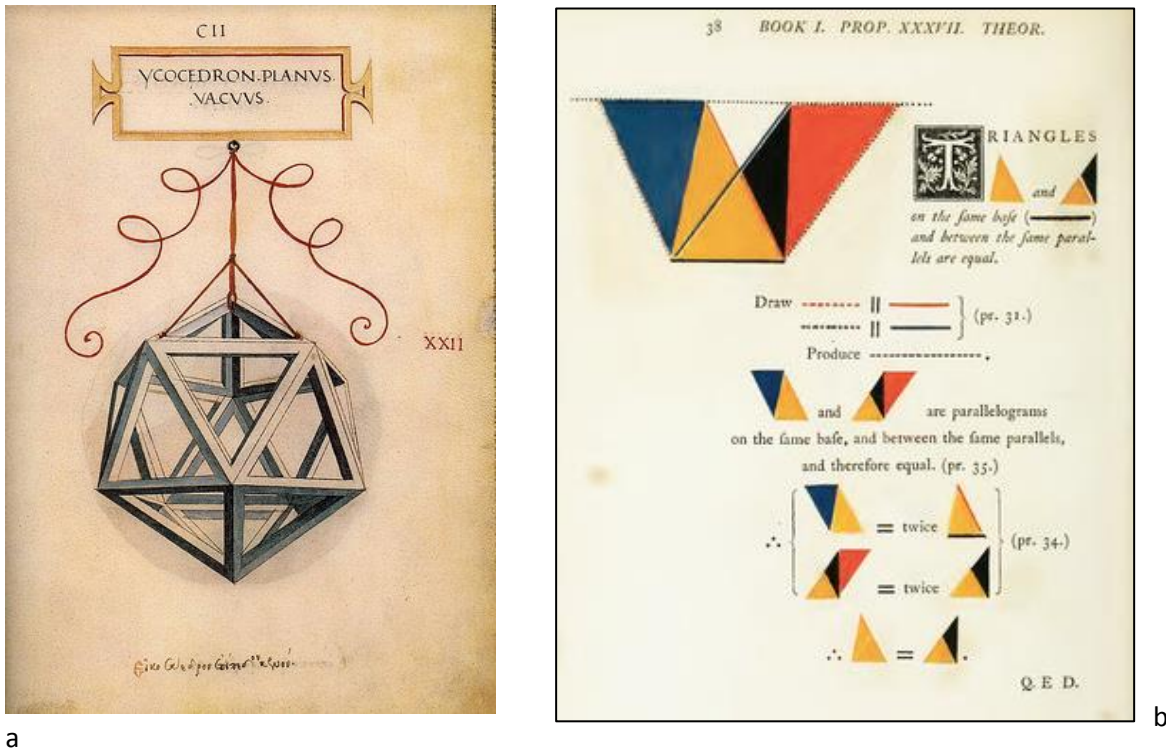

Figure 2: a) Representation of an icosahedron, *Ycocedron Planus Vacuus*, by Leonardo da Vinci for *De Divina Proportione* (Luca Pacioli 1509); b) Oliver Byrne, *The First Six Books of the Elements of Euclid*, London, 1847. Book I Prop. XXXVII "Triangles on the same base and between the same parallels are equal".

### DESCRIPTION OF THE APP COLORDOKU 3D

To merge the knowledge about regular bodies and color understanding, we have developed a digital app called ColorDoku 3d that is available for free at the web page of the Color Research Group in Architecture UPV<sup>2</sup>. By the moment, it contains four regular solids with triangular faces: icosahedron (20 triangular faces), triacysthetrahedron (12 triangular faces), tetrahexahedron (24 triangular faces) and hexaquisoctahedron (48 triangular faces) (Figure 2). The icosahedron is a polyhedron that belongs to the Platonic solids, and has been widely represented and used since antiquity. The other three polyhedra belong to the family of Catalan solids, after the Belgian mathematician Eugène Charles Catalan. These polyhedra are generated with two Archimedes solids, and so their faces have irregular polygons but equal dihedral angles: the triacysthetrahedron is a truncated tetrahedron, the tetrahexahedron is a truncated octahedron and the hexaquisoctahedron is a truncated cuboctahedron.

In the initial screen of the app, users can choose between the four aforementioned polyhedra, and set different parameters depending on the expected level of difficulty for the game, such as the scale of the solid, its position inside the color space, and the number of faces of the figure that will appear with the colors already set. With this information, a color palette is displayed and the 3d puzzle is launched. Turning the figure round in any direction and increasing its size if needed, users can drag and drop the colors provided in the color palette into the right faces of the solid to complete the 3d puzzle.

<sup>2</sup> [https://grupocolor.webs.upv.es/?page\\_id=3275](https://grupocolor.webs.upv.es/?page_id=3275)

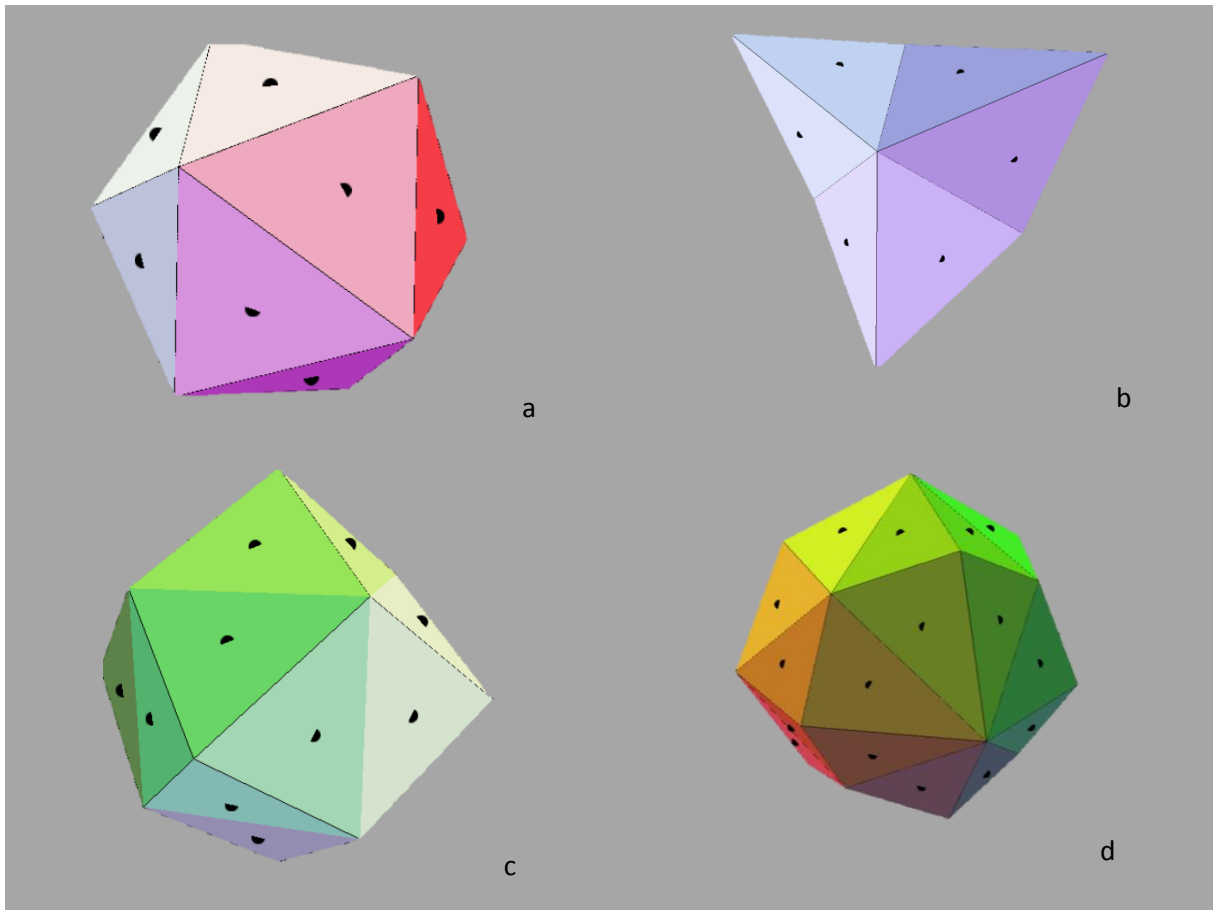

Figure 3: The four regular bodies implemented in ColorDooku 3d: a) icosahedron, b) triacystetrahedron, c) tetrahexahedron and d) hexakisoctahedron.

In the screen of the settings, and when the scale of the regular body is under 100%, it is possible to place it in different positions inside a virtual cube (Figure 4). This cube represents the color space HSL (Hue, Saturation, lightness), which is an alternative model to RGB, and therefore a useful color space for digital displays. When the user selects different values between 0% and 100% for the three spatial directions X, Y and Z, is placing the solid in a different position into the HSL space. The app will automatically generate a color palette assigning to each triangular face of the solid the color corresponding to the barycenter of such a face in the HSL model.

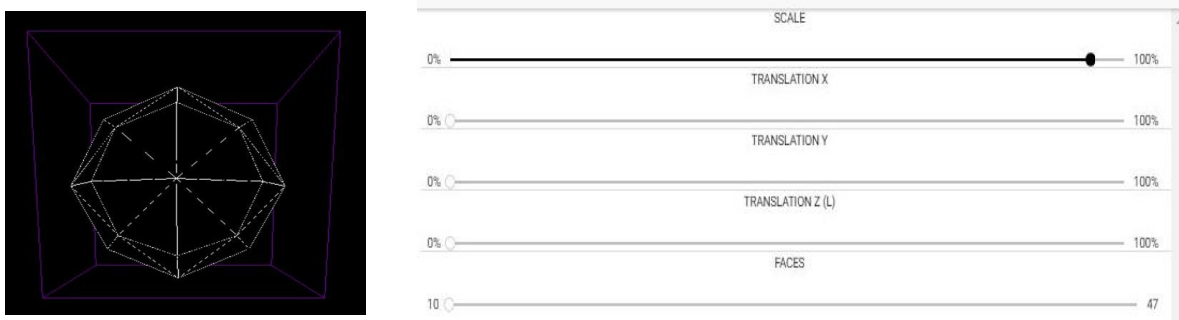

Figure 4: Aspect of the screen for the puzzle settings with indication of the variables to set: scale, translation X, translation Y, Translation Z and faces.

When the 3d puzzle is launched, the interface is divided in two parts. On the left side there is a color palette with all the colors of the puzzle in a random order and on the right side the user can rotate and scale the solid. Those colors preset have a grey cross on the color palette and a black dot on the corresponding face to indicate that they are locked. The rest of the colors in the color palette can be dragged and dropped onto the corresponding face. With the help of an eraser, the user can remove a color placed in a wrong position that will automatically move back to the color palette. When the 3d puzzle is correctly completed the indication “puzzle completed” appears.

We hope that this new app will help to improve at the same time the perceptual color discrimination ability together with the spatial vision.

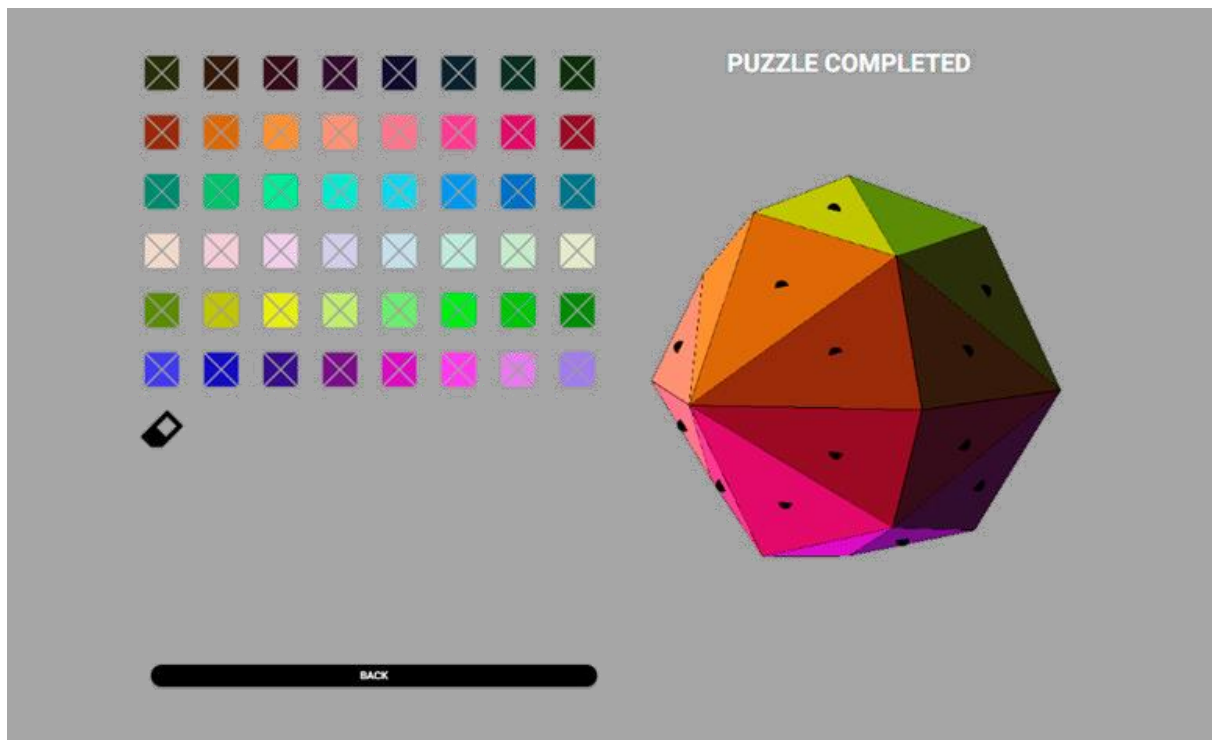

Figure 5: Interface of ColorDoku 3d with a completed puzzle of an hexaquisoctahedron.

## **RESULTS AND CONCLUSIONS**

In the course 2020/21 we invited the students enrolled in the subject Graphic and Chromatic Design of the Master in Architecture of the UPV to train with ColorDoku 3d and give their opinion. A total of 18 students (12 females, 6 males; Mean age= 23) played with the app for a couple of days and gave a feedback via an online questionnaire. Regarding the selection of the polyhedra, icosahedron was the most selected (50%), followed by tetrahexahedron (27.8%), hexaquisoctahedron (16.7%) and triacysthetrahedron (5.6%), therefore the selection of the polyhedra seemed to be rooted in a personal attachment and not in the number of faces of the solid or its difficulty. According to the answers, 33.3% of the respondents considered the random colors combination provided beautiful, 22.2% not beautiful and 44.4% indifferent. Considering the difficulty of the 3d puzzle, 44.4% considered it easy, 33.3% intermediate and 21.7% difficult or very difficult, with this assessment dependent on the puzzle settings of each participant. In an informal interview in the classroom, students expressed their interest in the app, indicating that it was fun and engaging, but also pointing out some aspects to improve, particularly related with the interface and the general user-friendliness of the app. Students seemed to be in favor of having an automatic preset of the parameter of the puzzle.

We conclude that ColorDoku 3d is a useful tool for the education of students in the improvement of their perceptual color discrimination ability and spatial vision, being a complementary resource to train their color abilities out of the classroom via gamification. In the future, the app will need some upgrades to make it more user-friendly and engaging, taking into account the information provided by a target group of users.

### **ACKNOWLEDGEMENTS**

We want to acknowledge Irene Cebrián Onsurbe for her work in the technical development of ColorDoku 3d.

### **REFERENCES**

- Bauman, Z. 2015. *Los Retos de La Educación En La Modernidad Líquida*. diegoan.
- Campos, Á. L. F., and M. D. S. Moya. 2021. Tono vs. Código El Color En El Curso Básico de La Hochschule Für Gestaltung Ulm. *EGA Expresión Gráfica Arquitectónica* 26 (41): 178–89. <https://doi.org/10.4995/EGA.2021.14036>.
- Franco Taboada, J. A. 2015. “From Goethe’s Theory of Colours to Albers’ Interaction of Colour.” *EGA Revista de Expresion Grafica Arquitectonica* 20 (25): 48–55. <https://doi.org/10.4995/ega.2015.3703>.
- Higón-Calvet, J. L. 2013. The Use of Colour as a Way for the Understanding of the Geometry. The Edition of Euclid’s Elements by Oliver Byrne. London 1847. In *X Congreso Nacional Del Color SEDO*, Á. García-Codoñer (ed.), 424–25. Valencia (Spain): Universitat Politècnica de València.
- Hirschler, R., P. Csillag, P. Manyé, and M. Neder. 2018. How Much Colour Science Is Not Too Much? *Color Research and Application* 43 (6): 977–92. <https://doi.org/10.1002/COL.22275>.
- Nemcsis, A, and J. L. Caivano. 2015. “Color Order Systems.” In *Encyclopedia of Color Science and Technology*, edited by Ming Ronnier Luo. New York: Springer. <https://doi.org/10.1007/978-3-642-27851-8>.

# Determination of the Representative Color of a Smartphone Image

Katherine Carpenter <sup>1,\*</sup> and Susan Farnand <sup>1</sup>

<sup>1</sup> Rochester Institute of Technology, Rochester, NY, USA; kmc2582@rit.edu, spfpci@rit.edu

\* Corresponding author: kmc2582@rit.edu

## Abstract

An online experiment was performed to assess what observers determine to be the representative color of an image. This experiment was part of a larger study assessing color science in the context of agriculture. It was an attempt to understand which characteristics people use to categorize a crop, particularly tomatoes, as ripe and how those characteristics are rendered by smartphone imaging. Observers were shown an image for one second, followed by a gray screen. They were then presented with an array of nine colors to choose from as the most representative of the image they had just seen. There was a split in observers' choices of representative color in terms of choosing the mean versus choosing a more saturated color. A trend was visible in the location of the color chosen, where the centermost color was chosen most often. No trend was found in time taken per image.

**Keywords:** *psychophysics, smartphones, agriculture*

## INTRODUCTION

An online experiment was created to assess how participants determine the representative color of an image. There have been previous studies that characterized observers' use of average color, as in Webster, Kay, and Webster (2014) and Milojevic, Ennis, Toscani, and Gegenfurtner, (2018) and most saturated color, as in Bartleson (1960), Kuriki (2004), and Kimura (2018), in determining the representative color of an image. Additionally, humans have been shown to average color over a non-uniform distribution, such as a tomato. No tomato is entirely uniform in color; instead, it is composed of several shades of reds and oranges, sometimes even yellows and browns. This is especially true for an unripe tomato, with veins of green running across the surface, yet when people look at a tomato, they have a quantifiable answer of "red", "orange" or "green."

To examine what characteristics of crops such as tomatoes participants use in their determinations of the representative color, the images taken for the tomato experiment were repurposed, as well as images of grass, sky, and skin. The inclusion of the additional images served to check if the participants use the same methods of determination for tomatoes as with previously studied subjects. Participants are asked to make a choice of which color best represents the overall image. This was done for the set of full images, as well as 16x16 and 64x64 pixel subsampled versions of images. Examples of subsampled arrays are given in Figure 1. The colors chosen by participants were recorded, in addition to the time taken on each image and the location of the color chosen to track if there were additional factors affecting choice.

## BACKGROUND

Color can provide a multitude of detail about an object. Differences in color can help observers detect features within or surrounding an object and to break up a scene into individual parts. While there is a long history of assessment of color discrimination and detection, research into how people form matches to blue. In a study published recently, it was found that observers tend to prefer simple averaging when asked to determine if colors were "yellower" or "bluer" than a given standard stimulus, Virtanen, Olkkonen, and Saarela (2020). This was true even when there was significant skew to the color distributions being displayed. Mean hue was also found to be used most when observers sorted autumn leaves by color, Milojevic et al. (2018). When participants were asked to adjust colored dots to match the average hue of rapidly displayed ensembles, it was found that the selected mean hues were most often the expected mean hues, suggesting that participants can accurately average

hue over a given array, Maule and Franklin (2016). When these results were compared to the performance of a simulated ideal observer, an ideal observer generated by an AI to maximize performance was found to perform as well or better than most live observers while only using two elements, compared to the sixteen elements presented to the human observers, Maule and Franklin (2016). This suggests that humans do not perform hue averaging as intuitively as they average other characteristics.



Figure 1: An example of an image used in the representative color experiment and its 64x64 pixel and 16x16 pixel downscaled counterparts.

On the other hand, there can be a bias in observers' judgment that favors more saturated colors when determining average color, Kuriki (2004), and Kimura (2018). Memory colors have also tended towards higher saturation and lightness than the actual remembered color when viewing such subjects as green grass and red bricks, Bartleson (1960). This experiment uses an element of memory, given the brief presentation of the images, so this idea may be relevant. Humans are likely to have strong pre-existing memory colors of tomatoes, such as they do for oranges or bananas. The idea for this experiment is to determine if these concepts apply to color determination of tomatoes to better understand how observers' perception of ripeness relates to different physical characteristics and what observers see from the smartphone renderings.

## **METHODS**

An experiment was designed to test how observers determine the representative color of a tomato, along with other targets. If these characteristics could be related to tomatoes, they could also be tied to collection and marketing of tomatoes that would be most valued by the consumer. This study was conducted remotely and assessed which characteristics observers use to determine what they feel to be the representative color of the image. This was done with and without the context of the full image, showing first subsampled and scrambled images and gradually increasing the frame of reference.

Eighteen images of red, orange, and green tomatoes were tested. Two images of the sky, one with and one without clouds, one image of grass, one image of green peppers, one image of skin, one image of a wood panel, and one image of sand were also assessed to ascertain if observers use the same characteristics for images of a wider gamut of colors than those in tomatoes in a consistent fashion. These images are shown in Figure 2.

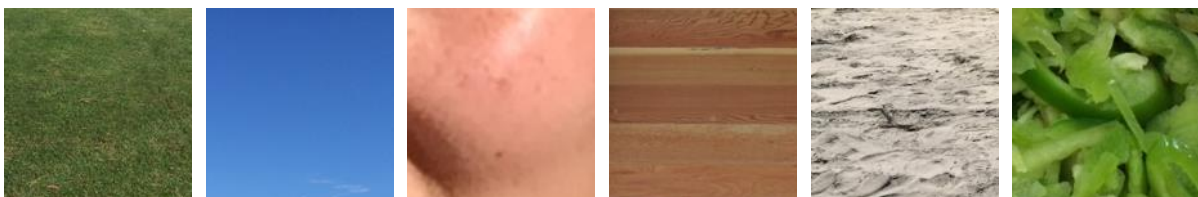

Figure 2: The images being used in addition to the tomato images in the representative color experiment.



First, the images were cropped to a point where the overall features were intact. Since tomatoes are round and do not ripen uniformly, there are specular highlights, blemishes, and a range of colors that needed to be represented in the image. However, there are strong memory colors tied to tomatoes that would potentially bias observers' choices if they viewed the entire image, Bartleson (1960). The images were cropped into squares of 768 x 768 pixels, a size determined to cut out backgrounds but still retain the color information across each image. Every twelfth pixel was then taken to create a 64x64 pixel square that represented the image at a reduced viewing quality. The same process was followed to create a 16x16 pixel square using every forty-eighth pixel. The positions of each pixel in the 16x16 image were then randomized to create an image where colors were distributed throughout, fully removing any context of highlights and shadows. This created five levels of context for each image. An example of an image and each of its decontextualized permutations is given in Figure 3.

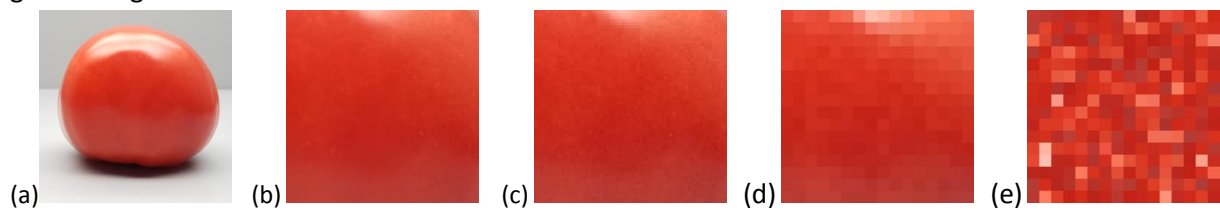

Figure 3: An example of (a) a full image, (b) its 768x768 cropped iteration, (c) its 64x64 iteration, (d) its 16x16 contextualized iteration, and (e) its 16x16 scrambled iteration.

From the images, nine color options were offered to observers to choose from as the most representative color. Nine was the number chosen so the observer would not be overwhelmed by too many options or ignore the peripherally placed ones. The nine colors were taken from the 16x16 images since the colors within those images would be present in all levels of the image. First, the most chromatic pixel, most saturated pixel, and an average of the entire 16x16 image were taken. Then, the image was split into nine subsections, where the most chromatic, most saturated, and average pixel value were found for each subsection. This yielded many colors that were too similar for observers to distinguish, so colors that were within 2  $\Delta E_{00}$  were removed, until there were only nine remaining. This threshold was chosen since it is around the color difference threshold for images, shown in Stokes, Fairchild, and Berns (1992) and Farnand (2003). If all colors within 2  $\Delta E_{00}$  had been removed and there were still more than nine options, the  $\Delta E_{00}$  threshold was increased, and the lightest and darkest colors were removed. If all colors within 2  $\Delta E_{00}$  had been removed and there were fewer than nine options, averages of the remaining colors were created to fill holes in color space. These colors were then compared to the 2  $\Delta E_{00}$  threshold until there were nine usable options. These nine colors were the same for each iteration of the images and were randomized within the 3x3 array of options each time it was presented to the observer. An example array and the image it is drawn from is shown in Figure 4.

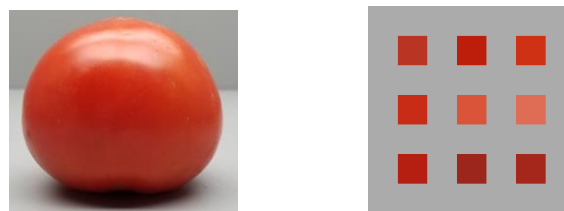

Figure 4: An example array of colors taken from an image of a dark orange tomato.



Since the experiment was run online, the goal was to keep it to a manageable time for observers. This was important because with an online experiment there is more danger of observers getting bored and having their attention wander. Additionally, there was no one present to monitor the observers' progress. As such, the experiment was designed to take around fifteen minutes so it would not be drawn out to a point where distractions in whatever unknown setting in which observers were participating may become an issue. The observers were shown one level of context at a time, seeing first all the scrambled 16x16 images, followed by the contextual 16x16 images, the 64x64 images, 768x768 cropped images, and then the full images. The order of presentation within each tier was randomized. Similar to the procedure followed in Virtanen et al. (2020), each image was displayed on the screen for one second, then a full gray screen was flashed for one second, following which the array of nine options was presented. The same gray color separates each option to keep the colors from affecting the perception of the others. The observer was then asked to click on the color they deemed the most representative of the image. A full gray screen was presented for one second following the selection, followed by the next image for one second. In addition to the color selection, the reaction time and location of choice was also recorded to track if there were any other trends in color selection. The results of the investigation were then considered in evaluating the relationship between the colors taken with the smartphone cameras. A second round of data collection was subsequently run in early 2021. Additional images were included in the second round. Eleven people participated in both rounds of data collection, giving the opportunity to examine intra-observer variability. Color choices, response times, and general location choices were recorded.

**RESULTS**

Twenty-seven people participated in the first round of data collection. Sixteen people participated in the second round of data collection.

**Location of Choice**

There was a definite trend in the location of choices observers made. The number of selections at each location for both data sets are shown in Table 1 a-b.

(a)	217	381	323	(b)	267	343	349
	403	451	373		383	507	399
	207	220	125		212	269	231

Table 1: The total number of choices made at each location in the array for (a) the first data set and (b) the second data set.

The center option was selected more than any other in both data sets and was chosen by far the most in the second set. The center row was chosen the most, followed by the upper row. The bottom row was chosen the least. Observers' preference for keeping their eyes in the center or higher is documented in past research, Farnand and Fairchild (2014). Additionally, since all of the observers were participating at home and not in a controlled environment, they likely did not have an optimal set up for their computer and may not have been not at eye level with their monitor. This could make it more likely for them to not look at the bottom row since it is farther away from their viewing angle. One suggestion for future research in such a format was to remove the choice from the middle, forcing participants to move their eyes more to find a choice. Any bias in choice location with regards to individual colors should be accounted for over the course of many participants since the locations of each color is randomized within the array with every iteration. Overall, for observers who participated

in both sets of data collection, the locations selected were relatively consistent. The number of selections for the center square were almost identical, though there were more selections in both the upper row and bottom left in the second round of data collection.

**Time of Choice**

As would be expected, there were occasional participants who took longer than the rest, while the average participant took between 1.77 s and 2.48 s. The average participant spent a total of 8 minutes and 14 seconds to select colors for 185 images in the second data set, while the participant who took the longest spent 14 minutes and 29 seconds making selections. In general, in both sets, there does not seem to be an overall pattern where people took more or less time once they gained the context of the full image. Where some images had comparatively longer times spent on the scrambled 16x16 array, others had longer times on the full image. As with the times taken per participant, the median time per image was lower than the mean in each instance. The mean and median times taken by most of the observers who participated in both rounds of data collection did not vary by more than 0.5 s between sets, while none varied by more than 1.21 s. Every participant took a longer mean time per image and every participant, but one had a longer median time per image in the second set of data than the first. This suggests that viewing the increased number of images caused more time to be taken per image. Perhaps this is due to a kind of decision fatigue caused by having to make more decisions.

**Mean vs. Saturated Color**

In the first data set, participants chose an average color 1172 times, a saturated color 685 times, and a chromatic color 720 times. In the second data set, participants chose an average color 1269 times, a saturated color 874 times, and a chromatic color 815 times. When looking at each category individually, participants chose a mean color more than saturated or chromatic colors. However, if the higher-color saturated and chromatic colors are grouped together, participants were more likely to choose these colors than a mean color. This suggests that the research supporting observers being biased towards more saturated colors is most relevant in this case. If this is to be applied to marketing tomatoes, that would suggest images with boosted saturated color should be used.

A table of observers’ choices by level of context is given in Table 2 a-b. Overall, the level of context did not change observers’ perception in the second set. They were roughly as likely to choose an average color when looking at the 16x16 scrambled images as they were when looking at the full images. In the first set, the number of selections of an average color slightly decreased for 64x64 and 768x768 images, while the number of selections of saturated colors slightly increased. While the difference is small, it does seem that observers were more likely to choose an average color to represent the image when they had less context available to them; when more context became available, the observers became slightly more likely to select a saturated color. This would also support the use of more highly saturated images when marketing produce to consumers.

First Set	Scrambled	16x16	64x64	768x768	Full
Average	250	247	222	220	233
Saturated	128	131	146	138	142
Chromatic	139	141	145	148	147

(a)

Second Set	Scrambled	16x16	64x64	768x768	Full
Average	257	257	247	248	260
Saturated	174	166	186	176	172
Chromatic	160	167	158	163	167

(b)

Table 2: Average, saturated, and chromatic choices of observers by level of context.

**ACKNOWLEDGEMENTS**

Thank you to Katie Albus and Dara Dimoff for creating the application GUI used in this experiment.

**REFERENCES**

- Albus, K. 2020. Determining the Representative Color of a Multicolored Image. *YouTube*.  
<https://www.youtube.com/watch?v=ZXgiRBD0cl4&list=LLMm8n3UutRv6hoF63mcrSbg&index=2&t=0s>.
- Bartleson, C. J. 1960. Memory Colors of Familiar Objects. *Journal of the Optical Society of America*. 50-1:73-77.
- Farnand, S. P., 2003. Using  $\Delta E$  metrics for measuring color variation in hard-copy pictorial images. In: *Color Imaging VIII: Processing, Hardcopy, and Applications, Proceedings of SPIE 5008*.
- Farnand, S. P. and M.D. Fairchild. 2014. Designing pictorial stimuli for perceptual experiments. *Applied Optics* 53: C-72-C82.
- Kimura, E. 2018. Averaging colors of multicolor mosaics. *Journal of the Optical Society of America A* 35: B43-B54.
- Kuriki, I. 2004. Testing the possibility of average-color perception from multi-colored patterns. *Optical Review* 11: 249-257.
- Maule J. and A. Franklin. 2016. Accurate rapid averaging of multihued ensembles is due to a limited capacity subsampling mechanism. *Journal of the Optical Society of America A* 33: A-22-A29.
- Milojevic, Z., R. Ennis, M. Toscani, and K.R. Gegenfurtner. 2018. Categorizing natural color distributions. *Vision Research* 151: 18-30.
- Stokes, M., M.D. Fairchild, and R.S. Berns. 1992. Precision requirements for digital color reproduction. *ACM Transactions on Graphics (TOG)* 11-4: 406-422, 1992.
- Virtanen, L. S., M. Olkkonen, and T. P. Saarela. 2020. Color ensembles: Sampling and averaging spatial hue distributions," *Journal of Vision* 20-5: 1-14.
- Webster, J., P. Kay, and M.A. Webster. 2014. Perceiving the average hue of color arrays. *Journal of the Optical Society of America A* 31-4: A-283-A292.

# Psychophysical Study of the Perception of Color Gradient Boundaries

Nian Xiong<sup>1</sup>, Henry J. Trussell<sup>2</sup> and Renzo Shamey<sup>1,\*</sup>

<sup>1</sup> Color Science and Imaging Laboratory, TECS, North Carolina State University; nxiong@ncsu.edu

<sup>2</sup> Department of Electrical and Computer Engineering, North Carolina State University; hjt@ncsu.edu

\* Corresponding author: rshamey@ncsu.edu

## Abstract

Color gradients constitute an important component in the color quality control evaluation of multicolored patterns that contain color transitions. A psychophysical study was designed and employed to test a set of lightness change, hue change, and chroma change color gradients. The influence of several parameters on the visual detection of the gradient boundaries and perceived smoothness levels were tested. These parameters included the orientation and slope of the color transitions and variations in the gradient-based on lightness, hue, or chroma.

The design of the psychophysical experiment contained two parts. In the first part, the perceived boundaries of color gradient stimuli were determined. In the second part of the study, the perceived smoothness of the stimuli was examined. We propose that different gradient slopes cause differences in ranked smoothness. We further hypothesize that the orientation of the color gradients also influences the perceived smoothness. Four binary transition regions were simulated: brown-green, brown-tan, green-olive, and light sage-olive. Three different linear-gradient slopes were applied to each transition, and the stimuli were presented in four orientations: horizontal, vertical, right diagonal, and left diagonal.

Results indicate that the gradient slopes influence both the perceived boundaries and perceived smoothness levels. Observers were found to be more sensitive to luminance variations than chromatic variations. Furthermore, observer responses indicate higher sensitivity to color variations in the horizontal direction.

**Keywords:** color gradient, perception, color boundaries

## INTRODUCTION

In the field of color quality control of multicolored patterns, color gradients constitute an important parameter that influences the color quality evaluation process. The procedure often involves first identifying color gradient regions in multicolored patterns followed by evaluating their color quality in terms of the smoothness of transitions.

The spatial luminance contrast sensitivity is significantly higher than the chromatic contrast sensitivity functions red-green and yellow-blue at constant luminance, which indicates the human visual system (HVS) is more sensitive to small changes in luminance contrast compared to chromatic contrast (Robson 1966; Fairchild 2013). In previous studies the HVS was found to be more sensitive to frequency variations in the horizontal and vertical directions than in the diagonal directions (Rajala et al. 1992).

In this study, the effects of the dominance of lightness, hue or chroma in color gradients, as well as the orientation and the slopes of color gradients on the perceived gradient boundaries and smoothness levels were investigated. Four sets of image stimuli were displayed on a color-calibrated monitor to several observers who identified gradient boundaries and evaluated their smoothness levels. The results may have applications in the quality control of multicolored products where color gradients are present and can improve color separation accuracy of multicolored images.

### Hypotheses& Experimental Setup and Procedure

We hypothesize that the visual detection of boundaries in color gradients is influenced by the slope and the orientation of the gradients. We also assume that observers would be less likely to consistently detect boundaries in gradient regions that are perceived as smooth. We further hypothesize that the average perceived boundaries of color gradients will be closest to the ground truth for gradients consisting of lightness changes followed by those with changes in hue or chroma.

In terms of perceived smoothness of color transitions, we hypothesize that larger gradient step sizes would result in lower smoothness values. The step size represents the magnitude of the quantization steps required to transition from one solid color to another over a given number of pixels. The larger the step size, the smaller the number of pixels required to transition from one color to another. Furthermore, for stimuli with the same step sizes that are required to form the gradients, the average smoothness ranks will differ in different orientations and will be lower for the horizontal and vertical directions than the diagonal directions.

The subjective assessments, using a color-calibrated monitor, were conducted in a dark room environment with no additional light present. It is known that the photoreceptors in the retina have a non-uniform distribution, and the fovea has the highest number of ganglion cells and cones in the retina (Jerde 2014). Therefore, the size of the stimulus was kept as small as possible to ensure the visual response was primarily due to signals generated from cones concentrated in this region. In this experiment, an 8-bit 27- inch Eizo ColorEdge CG277 monitor was used. The distance between the observer and the monitor was fixed at 75 cm. A 4.6-degree arc was required to display an image with a resolution of 512×512 pixels. The luminance level was set to 110  $cd/m^2$  at a color temperature of 7500K, since the selected gradient colors were designed for outdoor applications. A display warm-up time of 7 min was applied prior to testing. The observers were given two minutes to adapt to the lighting environment before starting the visual experiment. The background of the stimuli was set to a neutral gray with the  $L^* = 70$  to mimic the interior color of the physical viewing booths used in North America, as shown in Figure 1.

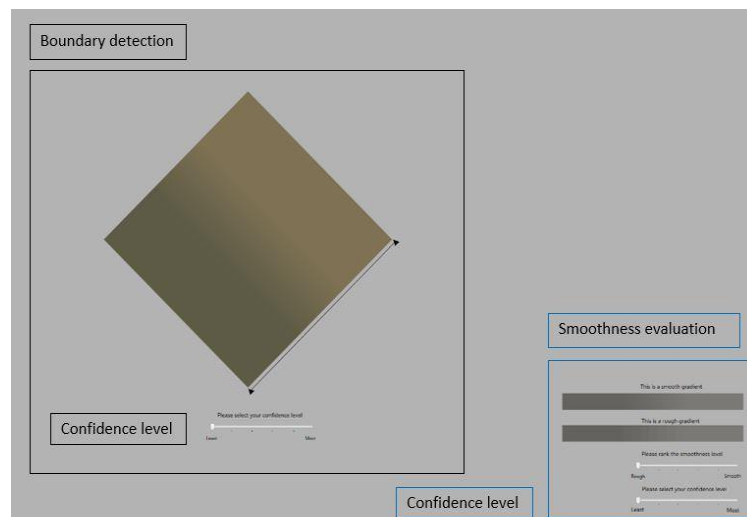

Figure 1: The Graphic User Interface of the visual assessment.

With the image stimulus displayed in the middle of the screen the observers were given two tasks: to indicate the perceived boundaries of the gradient color region by moving the cursors and to choose

the transition smoothness level of the region. The confidence percentage for both tasks was also determined. The observers conducted these tasks for the image stimuli presented in four orientations and repeated their judgment three times for each stimulus. The order in which the images were displayed was randomized. The image stimuli in Figure 2 show hue based gradients (first row), lightness based gradients (second row), gradients with changes in lightness-hue-chroma (third row), and chroma based gradients (fourth row). The gradient slopes decrease in each row from left to right by increasing the area of the gradient region in the image.

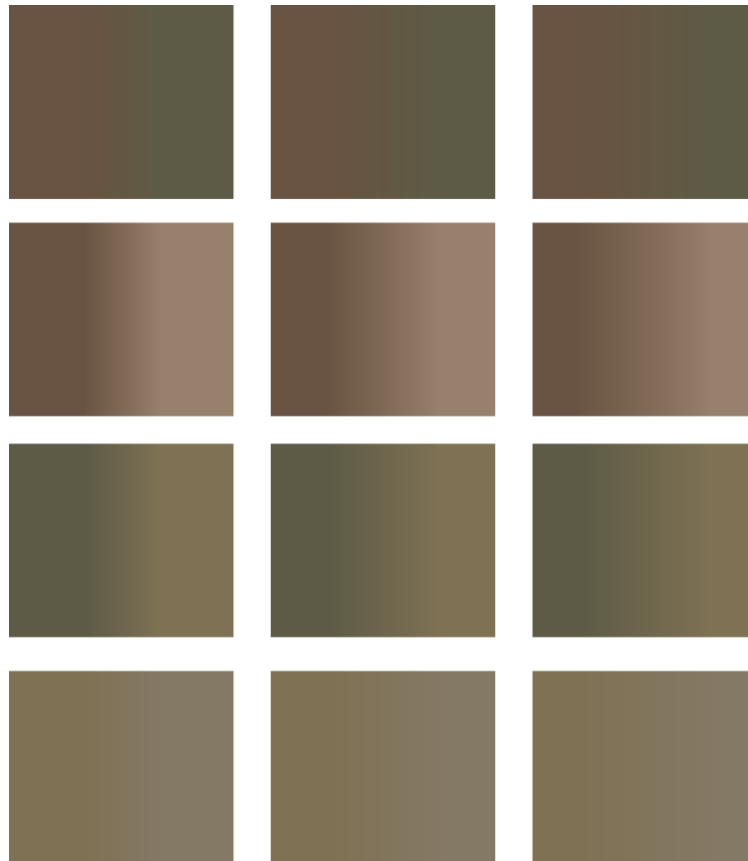

Figure 2: The image gradient stimuli used in the experiment: top row brown-green, 2<sup>nd</sup> row brown-tan, 3<sup>rd</sup> row green-olive and bottom row sage-olive with gradient slopes decreasing from left to right in all rows.

## **RESULTS AND DISCUSSION**

### **Boundary detection analysis**

An analysis of variance (ANOVA) test was conducted for results obtained from each image stimulus. The results, at a 95% confidence level, indicate no significant differences between the perceived boundaries identified in different orientations. While one of the hypotheses states that the variance among selections would be lower for the horizontal and vertical directions due to the associated sensitivity levels of the HSV in those directions, the results, shown in Figure 3, only support this for the horizontal orientation, which has a smaller variance among the four orientations in most of the comparisons. Based on these results, the responses from different orientations for each image stimulus were averaged in order to analyze the influence of the gradient slope on assessments.

$\Delta E_{00}$  values of perceived gradient boundaries from one of the end colors were compared between different gradient slopes for each gradient stimulus. The boxplots are shown in Figure 3, and the results of ANOVA tests are shown in Table 1. A comparison of the results supports the hypothesis that the gradient slopes influence the detection of the perceived boundaries ( $p < 0.05$ ). In Figure 2, the average color difference ( $\overline{\Delta E_{00}}$ ) between the preset boundaries and the perceived boundaries increases as the gradient slope decreases (slope 1 > slope 2 > slope 3). The observers tend to be less sensitive to and less precise in determining the boundaries as the gradient slope decreases. This supports our hypothesis. A comparison of the ratio of  $\Delta E_{00}$  of the colors of the perceived boundaries to the  $\Delta E_{00}$  between the solid colors indicates higher precision in observer selected boundaries for lightness-change gradients than that of the hue or chroma-change gradients. This partially supports the relevant hypothesis.

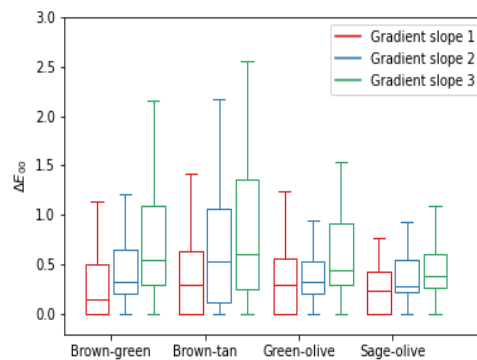

Figure 3:  $\Delta E_{00}$  of perceived gradient boundaries from one of the end colors.

Gradient end colors	$\overline{\Delta E_{00}}$ of slope 1	$\overline{\Delta E_{00}}$ of slope 2	$\overline{\Delta E_{00}}$ of slope 3	p-value
Brown - Green	0.47	0.66	0.92	0.032
Brown - Tan	0.40	0.67	0.96	<0.001
Green - Olive	0.51	0.41	0.74	0.046
Sage - Olive	0.42	0.50	0.31	0.007

Table 1: ANOVA test results for data shown in Figure 3.

### Smoothness evaluation analysis

Figure 4 shows the perceived smoothness levels for the same stimuli but with different gradient slopes. The perception of gradient transition smoothness likely depends on the detection of variations in color attributes. In most cases, the perceived smoothness does not decrease by increasing the gradient slope. This does not support our hypothesis. There are several potential reasons for this observation including limitations in the gradient ratio settings to explore the smoothness and roughness limits; changes in the field of view size of the displayed gradient region which may have influenced the smoothness judgments and the color quantization error (Sharma and Trussell 1997) for image display.

Additionally, stimuli presented in the horizontal direction were given the lowest smoothness ranks in most cases, which was in accordance with the hypothesis. Thus, observers seem to be stricter in their evaluation of smoothness in the horizontal direction than in diagonal directions. However, responses for the vertical direction had higher smoothness values though at a lower confidence level

in most cases. One possible reason is the misalignment of the gray reference bar used for the smoothness evaluation with the displayed stimuli. The reference could only be shown in one direction (horizontal), which may have made it challenging for observers to detect transitions in the vertical direction.

From the after-experiment survey of several observers, we noticed observation of quantization levels even in color transition stimuli that were considered to be smooth enough. We had assumed that the Mach bands effect (Mach 1865) appeared near the preset edges of the color gradient regions, where an edge enhancement is induced by the lateral inhibition of retina. These “fake” bands help determine the boundaries but diminish the smoothness evaluations. Furthermore, the images were all linear transitions in the CIELAB color space and the color step sizes were considered to be too small to cause a visible non-smooth perception than that caused by the color quantization error or Mach bands effect.

Based on these observations, another set of smoothness ranking experiments was conducted to further investigate the influence of gradient slopes on the perceived smoothness. A set of stepped gradients were simulated instead of the original linear gradients to minimize any non-smooth perceptions caused by the Mach bands effect or the color quantization error. The gradient colors used were the same as those shown in Figure 2. In this case, however, the dimensions of the gradient region remained the same for the displayed images that had different slopes to keep the field of view size of the gradient region constant. Four different quantization steps were applied to each gradient. The quantization steps in the gradient region increased from 1 to 4 in terms of different color attributes. The smaller the quantization step, the greater the number of quantization levels formed in the gradient region, and the lower the probability that the observer would see visible bandings. The results are shown in Figure 4 and Table 2.

<b>End colors</b> <b>Image pair</b>	<b>Brown - Green</b>	<b>Brown - Tan</b>	<b>Green - Olive</b>	<b>Sage - Olive</b>
Step 1, Step 2	0.210	0.950	0.026	<0.001
Step 1, Step 3	0.002	<0.001	0.001	<0.001
Step 1, Step 4	0.160	<0.001	0.001	<0.001
Step 2, Step 3	0.009	<0.001	0.006	0.120
Step 2, Step 4	<0.001	<0.001	0.004	0.010
Step 3, Step 4	<0.001	0.670	0.130	0.077

Table 2: Paired t-test p-values for the additional experimental results.

As shown in Figure 4 (right), the perceived smoothness generally decreases as the gradient step size increases except for the hue-change gradient. To test the statistical significance of differences a paired t-test of the limited sampling size was conducted. Results are summarized in Table 2, which show at least four significantly different image pairs out of the six total stimuli displayed. Figure 3 also shows an inversely proportional relationship between the gradient step size (1-4) and the perceived smoothness.



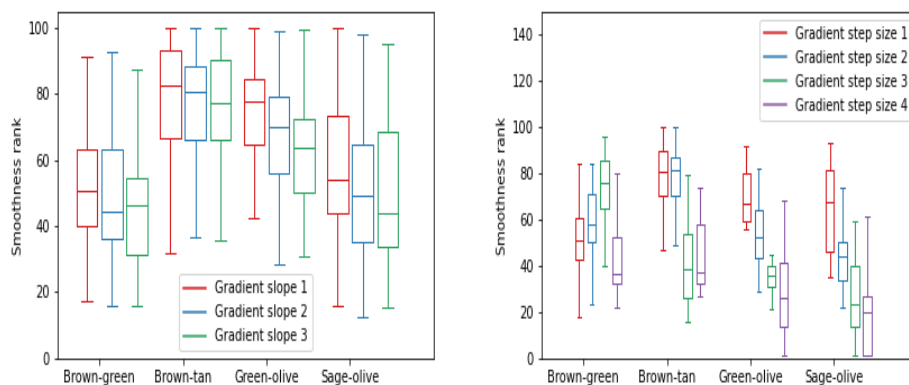

Figure 4: Smoothness ranks of the color gradients (left), and smoothness ranks of the color gradients in the additional experiment with different step sizes (right).

## CONCLUSION

A psychophysical study was performed to investigate the detection of perceived boundaries in color gradients and to assess the magnitude of smoothness in color transitions. The results indicate that the perception of gradient boundaries is influenced by the gradient slopes regardless of the type of the gradient shown, i.e., hue-change, lightness-change, chroma-change, or hue-lightness-chroma-change. As the gradient slope increases, the observers tend to be more accurate in their determination of gradient boundaries. The gradient slope also influences the perceived smoothness levels at a constant field of view size. Perceived smoothness levels are inversely proportional to the size of the quantization step of the gradient. The orientation of the displayed gradients does not seem to have a significant effect on the detection of boundaries or the evaluation of the smoothness. However, observer responses were found to be more consistent when assessing horizontal color gradients as indicated by the smallest variance in that direction. Finally, observer responses also indicate higher sensitivity to changes in gradient lightness than hue, followed by changes in chroma.

## REFERENCES

- Robson, J. G. 1966. Spatial and temporal contrast-sensitivity functions of the visual system. *JOSA* 56, no. 8: 1141-1142.
- Fairchild, M.D. 2013. *Color appearance models*. John Wiley & Sons.
- Rajala, S.A., H. J. Trussell, and B. Krishnakumar. 1992. Visual sensitivity to color-varying stimuli. In: *Human Vision, Visual Processing, and Digital Display III*, vol. 1666:-386. International Society for Optics and Photonics,.
- Baars, B., and N.M. Gage. 2013. *Fundamentals of cognitive neuroscience: a beginner's guide*. Academic Press.
- Elliot, A.J., M.D. Fairchild, and A. Franklin, 2015. *Handbook of color psychology*. Cambridge University Press.
- Mach, E. 1865. *Über die Wirkung der räumlichen Vertheilung des Lichtreizes auf die Netzhaut: vorgelegt in der Sitzung am 3. October 1865*. K. k. Hof-und Staatsdruckerei.
- Sharma, G., and H.J. Trussell. Digital color imaging. *IEEE transactions on image processing* 6, no. 7 (1997): 901-932.

1 COLOR AND MEASUREMENT INSTRUMENTATION	2 COLOR AND DIGITAL	3 COLOR AND LIGHTING	4 COLOR AND PHYSIOLOGY
5 COLOR AND PSYCHOLOGY	6 COLOR AND PRODUCTION	7 COLOR AND RESTORATION	8 COLOR AND BUILT ENVIRONMENT
9 COLOR AND DESIGN	10 COLOR AND CULTURE	11 COLOR AND EDUCATION	12 COLOR AND COMMUNICATION MARKETING

## 6 COLOR AND PRODUCTION

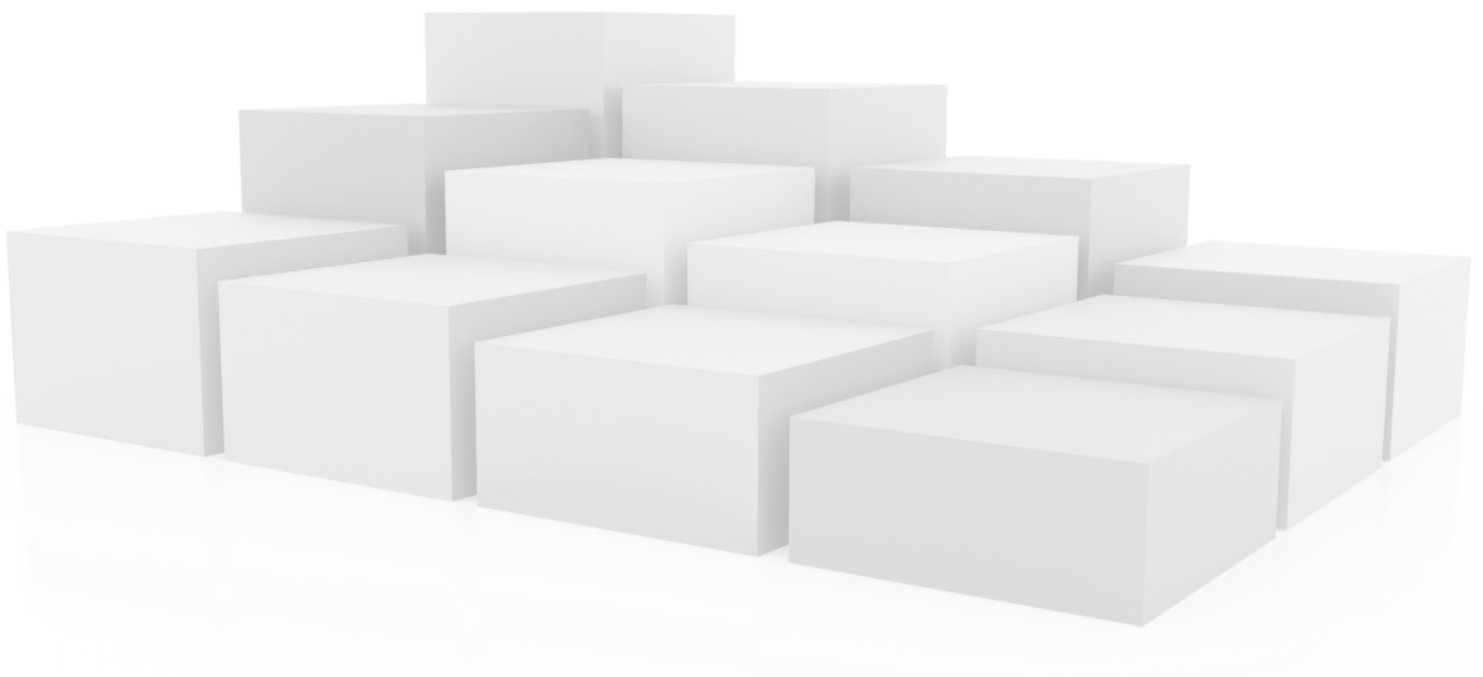



# Colour fading in the polyurethane coating depending on the substrate and conditions of natural weathering

Vesna Marija Potočić Matković<sup>1</sup>, Ana Sutlović<sup>1,\*</sup> and Martinia Ira Glogar<sup>1</sup>

<sup>1</sup> University of Zagreb Faculty of Textile technology s 1; marija.potocic@ttf.unizg.hr 2; ana.sutlovic@ttf.unizg.hr 3; martinia.glogar@ttf.unizg.hr

\* Corresponding author: ana.sutlovic@ttf.unizg.hr

## Abstract

Coated textiles are mostly used in clothing, medicine and transport. Advantages of polyurethane coatings are greater resistance to abrasion and splitting, increased strength and durability. The properties of such materials can be significantly affected by pigment dispersion. Polyurethane-coated knitted fabrics were of interest because they exhibit positive mechanical and thermal properties, and yet they are little studied. Polyurethane coating was prepared in pastes in yellow, blue and dark blue hue, which is used to obtain polyurethane coatings. The results are presented as differences in CIEL\*a\*b\* colour parameters and total colour difference. After exposure to the natural weathering, it is noticed that in the summer season the materials in dark blue hues resist best, while in winter conditions the smallest difference in colour is obtained for yellow materials. In addition, a good correlation of knitted substrate mass, thickness and yarn count with colour fading occurred.

**Keywords:** coated knitted fabric, pigment dispersion, outdoor exposure, colour fading, polyurethane coating

## INTRODUCTION

Numerous scientific studies are conducted in the field of development of coloured polymer dispersions for textile coatings. A wide range of coloured pigment paste dispersions is available for applications for a wide variety of applications which can affect the properties of the substrate in synergy. The development of coloured polymer dispersion is primarily aimed at improving the weathering resistance of usable properties such as elasticity, tensile strength or friction. The additional treatment of PUR coated (PUC) knitted fabrics can be fungus, antibacterial, antistatic and flame-retardant treatment, or agent to enhance the colour fastness. Sundang et al. (2020) investigated PUR as dye fixing agents. Das et al. (2017) investigated the influence of UV ageing on the properties of green PUR coatings. The yellowness index ( $\Delta YI$ ) follows a systematic increasing trend with increment in irradiation time which indicates photodegradation of polyurethane. Štaffová et. al. (2021) studied dynamic color and phase change of chosen thermochromic systems and their incorporation into polyurethane textile coating.

The gap in the field of scientific research of the application of coloured coatings is in the textile substrate properties. Varying the structure of fabric, density, mass, thickness and yarn count it is possible to obtain a coated fabric with knitted substrate with different properties. Coated knitted fabrics are generally more stretchable and elastic than coated woven fabrics and therefore protective clothing and sportswear are more comfortable than clothes made out of coated woven fabric. Information of weather durability is essential when developing new textile materials or improving existing materials intended for outdoor use (Potočić Matković and Skenderi 2017).

Degradation of textile material under natural weathering conditions is caused by sunlight, temperature and moisture. For handling natural exposure tests different exposure techniques are available. Proper exposure methodology, with reference to seasonal changes in weather are especially important to ensure that the test results are useful, especially for textiles. Seasonal differences greatly affect the time and mode of physio-mechanical degradation of coated textiles

Colour fading in the polyurethane coating depending on the substrate and conditions of natural weathering (Potočić Matković and Skenderi 2017). The ideal way to test materials which have a short service life is to expose a replicate test array at different seasons of the year. Weatherability of coated textiles was mostly researched at high loads coated fabric used in the building industry. Generally, the degree of surface degradation on all the fabrics was more severe due to the harsher climate, if a fabric is exposed to a higher dosage of UV radiation, it is likely to experience the higher degradation (Wypych 2013).

This paper examines the impact of natural weathering on the colour fading of PUC fabric. Research was also focused on the selection of fabric construction parameter which correlates with the colour fading best, and can serve as indicator to predict colour fading of tested knitted fabrics.

## **EXPERIMENTAL SETUP**

### **Materials and structural properties**

Nine knitted fabrics with different structures were chosen to cover a wide interval of the tested characteristics. They were coated under the same conditions, on the same coating line, with PUC from Novotex (Table 1). PUC was prepared in three colours from the base of hydrophilic polyester which is used to obtain PUC which let water vapour pass through. Polyurethane was applied to the knitted fabric using the transfer procedure. The polyurethane paste was applied to the backing paper using the pump. The paper is directly introduced through the whole coating line (Recomo Company) and is used as an endless conveyor for applying polyurethane. Coatings are adjusted with the distance between the knife on which the polyurethane paste is applied and the roller under the knife. The applied polyurethane paste with the paper passes through the dryer with speed of 10 m/min, where the temperature was adjusted to 80 °C. Here, drying is carried out due to evaporating solvent. At the dryer exit there are cooling rollers to cool down the PUC. Subsequently the other coating of the same polyurethane paste is applied in the same way. The final coating was a polyurethane binding agent on which the knitted fabric was laminated. In the dryer at 160 °C, during 3 minutes, the binder was cross linked. At the end of the coating line there is a unit to separate the backing paper from the finished material. The backing paper returns to the beginning of the coating line and is used to apply the polyurethane paste. The mass of PUC was 80 g/m<sup>2</sup> and thickness 0,16 mm.

Pigment dispersion suitable for the pigmentation of polyurethane in solution, for transfer or direct coating, was used. Pigments were Norene from Novotex in appearance of viscous paste in yellow, blue and dark blue colour hue.

Coated fabric sample	Knitted fabric - substrate					Coated fabric		
	Structure	Material	Yarn count (dtex)	Mass per unit area of substrate (g/m <sup>2</sup> )	Thickness (mm)	Density per cm horizontal / vertical	Total mass per unit area (g/m <sup>2</sup> )	Thickness (mm)
CF1	Simplex	PA	55	184	0,74	18/17	283	0,78
CF2	Locknit	PA	111	152	0,62	14/24	249	0,62
CF3	Power-net	PES	17	47	0,26	10/60	130	0,30
CF4	Voile	PES	17	60	0,32	12/54	147	0,40
CF5	Power-net	PA	13	134	0,4	12/68	238	0,47
CF6	Locknit	PA	44	284	0,86	28/38	385	0,88
CF7	Simplex	PA	44	167	0,65	17/15	264	0,69
CF8	Locknit	PA	44	279	0,77	28/40	372	0,78
CF9	Sleeknit	PA	13	100	0,51	13/88	192	0,51

Table 1: Properties of substrate and coated fabrics.

### Measuring methods

Ageing of coated fabric was carried out in conformity with standard EN ISO 877-1:2010 – Methods of exposure to solar radiation – Part 1: General guidance and EN ISO 877-2:2010 – Part 2: Direct weathering.

The rack employed in test was made from untreated wood; a flat frame mounted on a support was suitable. The exposure angle was fixed at 45°, facing the equator. The location of exposure was Zagreb, Croatia (lat.: 45° N, long.: 16° E), with humid continental climate with hot summers and cold winters. Duration of exposure of samples during summer season was from 15th of July to 15th of October, and during winter season from 1st of December to 1st of March. The climatic conditions during the test were monitored and reported by courtesy of Croatian Meteorological and hydrological service. The most important weather information is given in Table 2.

Duration of exposure	Total solar radiant exposure (J/cm <sup>2</sup> )	Temperature - t - monthly mean of daily mean (°C)	Relative humidity - Rh - monthly mean of daily mean (%)	Precipitation - R - monthly total of rainfall (mm)	Precipitation - S - monthly total of snow (cm)
15.07.-31.07.	12211	20,4	67	63,3	0
01.08.-30.08.	16622	23,2	61	15,6	0
01.09.-31.09.	13740	20,3	63	42,0	0
01.10.-15.10.	5305	12,5	71	26,5	0
<b>Aver. summer</b>	<b>47878</b>	<b>19,1</b>	<b>66</b>	<b>147,4</b>	<b>0</b>
01.12.-31.12.	6107	3,7	85	84,5	1
01.01.-31.01.	7753	2,5	72	19,4	1
01.02.-01.03.	10186	-1,9	69	26,3	27
<b>Aver. winter</b>	<b>24046</b>	<b>1,4</b>	<b>75</b>	<b>130,2</b>	<b>29</b>

Table 2: The climatic conditions during the test (\*Aver. – average value for season).

Colour fading in the polyurethane coating depending on the substrate and conditions of natural weathering

The evaluation of colour characteristics has been obtained objectively using a remission spectrophotometer DataColor Spectra Flash 600 PLUS – CT. The results are presented as total colour difference values ( $dE_{CIE76}$ ) obtained by measuring and comparing the samples before and after the samples exposure to natural weathering during summer or winter season. Colour difference values were calculated using formula (1), defining the samples before exposure as reference samples.

$$dE_{CIE76} = ((dL^*)^2 + (da^*)^2 + (db^*)^2)^{1/2} \quad (1)$$

where  $dL^*$  is difference in lightness value,  $da^*$  and  $db^*$  are differences in  $a^*$  and  $b^*$  colour coordinates indicating the change in  $L^* a^* b^*$  colour space position and also indicating the change in chroma ( $C^*$ ) and hue ( $h$ ).

The mass ( $g/m^2$ ) of the knitted fabric, without and with PUC was determined according to the standard EN ISO 2286-2:1998 for coated surface fabrics, in which it is determined how to separate the coating from the substrate and to weigh 5 samples with a mass per unit area of  $100 \text{ cm}^2$ .

The thickness was measured according to the standard EN ISO 5084:1996, ie 10 measurements for each fabric type.

The obtained results were statistically analysed (descriptive statistics, hypothesis testing, regression analysis).

## RESULTS AND DISCUSSION

Results in colour changes during weathering are shown in table 3. While values of correlation coefficient of the constructional parameters of knitted substrate and colour fading is given in Table 4.

Samples	$dL^*$	$da^*$	$db^*$	$dC^*$	$dh$	$dE$	$dL^*$	$da^*$	$db^*$	$dC^*$	$dh$	$dE$
<b>Yellow</b>	<b>Summer season</b>						<b>Winter season</b>					
CF1	-2,53	2,89	-11,26	-10,66	-4,63	11,89	-0,42	1,92	0,05	0,32	-1,90	1,97
CF2	-2,55	3,77	-12,53	-11,73	-5,79	13,33	-0,13	2,07	0,05	0,34	-2,04	2,07
CF3	-5,27	1,70	-20,33	-19,79	-4,96	21,07	-3,16	0,12	-4,78	-4,72	-0,76	5,73
CF4	-3,70	0,92	-17,53	-17,19	-3,58	17,94	-2,07	-0,52	-3,01	-3,05	0,13	3,69
CF5	-2,85	1,95	-14,12	-13,64	-4,12	14,53	-1,26	0,27	-1,42	-1,37	-0,45	1,91
CF6	-2,74	2,38	-16,20	-15,61	-4,95	16,60	-0,25	1,57	0,42	0,63	-1,50	1,64
CF7	-2,35	1,87	-13,95	-13,49	-4,01	14,27	-2,07	-1,40	-2,99	-3,14	1,02	3,90
CF8	-4,22	1,53	-16,94	-16,49	-4,16	17,53	-0,26	2,95	0,27	0,70	-2,88	2,98
CF9	-3,01	1,46	-14,10	-13,71	-3,58	14,49	-1,25	-0,11	-2,42	-2,42	-0,20	2,73
<b>Blue</b>	<b>Summer season</b>						<b>Winter season</b>					
CF1	1,05	-8,03	5,04	-0,89	-9,44	9,54	1,15	-5,56	0,67	1,56	-5,38	5,72
CF2	1,17	-7,85	4,95	-0,91	-9,24	9,35	1,61	-5,53	0,24	1,93	-5,19	5,77
CF3	-0,92	-3,96	9,87	-7,17	-7,85	10,67	-0,25	-0,97	4,35	-3,73	-2,44	4,46
CF4	0,40	-7,80	6,32	-2,06	-9,83	10,05	0,72	-5,42	3,26	-0,79	-6,28	6,37
CF5	0,51	-8,16	5,09	-0,85	-9,58	9,63	1,31	-5,47	1,11	1,13	-5,47	5,73
CF6	1,09	-7,95	3,54	0,31	-8,70	8,77	1,07	-5,33	0,72	1,41	-5,19	5,48
CF7	0,19	-8,73	3,87	0,47	-9,54	9,55	0,92	-5,78	0,65	1,68	-5,57	5,89
CF8	1,22	-7,58	5,77	-1,74	-9,37	9,61	1,43	-5,35	0,43	1,67	-5,10	5,55
CF9	0,53	-8,49	5,28	-0,81	-9,96	10,01	0,74	-5,74	1,27	1,12	-5,77	5,93

Colour fading in the polyurethane coating depending on the substrate and conditions of natural weathering

Dark Blue	Summer season						Winter season					
	CF1	-0,22	-0,07	5,12	-5,12	0,23	5,13	-0,24	1,20	4,27	-4,15	1,57
CF2	-0,83	-1,57	4,44	-4,47	-1,47	4,78	-0,57	-0,2	3,88	-3,89	1,00	3,93
CF3	-0,1	-2,78	3,51	-3,49	-2,80	4,48	-0,19	-1,17	3,13	-3,16	-1,07	3,35
CF4	-0,16	-2,13	4,75	-4,77	-2,09	5,21	-1,16	-0,88	3,85	-3,88	-0,73	4,11
CF5	-0,18	-3,23	3,60	-3,55	-3,29	4,84	-0,25	-1,26	2,59	-2,63	-1,19	2,89
CF6	-0,74	-2,01	4,11	-4,13	-1,96	4,63	-0,97	-0,75	4,05	-4,08	-0,59	4,23
CF7	-0,29	-2,61	3,16	-3,16	-2,62	4,11	-0,73	-1,5	4,29	-4,32	-1,40	4,60
CF8	-1,36	-1,54	3,36	-3,39	-1,47	3,94	-0,63	-0,04	3,88	-3,88	0,19	3,93
CF9	0,48	-2,36	3,72	-3,73	-2,34	4,43	0,35	-0,77	2,41	-2,44	-0,68	2,56

Table 3: Colour changes between exposed and unexposed samples during summer and winter season.

Parameters of coated textile	dL*	da*	db*	dC*	dh	dE
		Summer season				
Yarn count of substrate	0,4195	0,8699	0,5086	0,5396	-0,7557	-0,4711
Mass per unit area (g/m <sup>2</sup> )	0,3270	0,3028	0,2484	0,2561	-0,2180	-0,2527
Thickness of substrate(mm)	0,5153	0,4526	0,4664	0,4746	-0,2595	-0,4679
Density horizontal (loops/cm)	0,1331	0,0984	0,0234	0,0275	-0,1104	-0,0311
Density vertical (loops/cm)	-0,3935	-0,5750	-0,3878	-0,4057	0,4678	0,3709
Total mass per unit area (g/m <sup>2</sup> )	0,3725	0,3275	0,2911	0,2987	-0,2204	-0,2963
Thickness (mm)	0,5368	0,4227	0,4684	0,4747	-0,2200	-0,4732
	Winter season					
Yarn count of substrate	0,6053	0,5462	0,5900	0,5961	-0,5108	-0,3821
Mass per unit area (g/m <sup>2</sup> )	0,7663	0,6529	0,8236	0,8217	-0,5862	-0,5823
Thickness of substrate(mm)	0,8002	0,5920	0,8210	0,8131	-0,5161	-0,6195
Density horizontal (loops/cm)	0,6461	0,6097	0,7064	0,7101	-0,5602	-0,4151
Density vertical (loops/cm)	-0,3374	-0,2899	-0,4188	-0,4154	0,2486	0,1598
Total mass per unit area (g/m <sup>2</sup> )	0,7804	0,6417	0,8374	0,8332	-0,5705	-0,6191
Thickness (mm)	0,7829	0,5611	0,8203	0,8095	-0,4806	-0,6315

Table 4: Values of correlation coefficient of the constructional parameters of knitted substrate and colour fading after summer and winter season.

Weathering of yellow samples during the summer season given in Table 3 show the most significant change in colour ( $dE > 11$ ) with the largest change occurring in the chromaticity value ( $dC^* > -10$ ). The most important influence of the sun is proved by  $dE < 4$  during the winter season. Samples show that changes in colour and lightness are correlated (Table 4) with the mass and thickness of the knitted substrate, and thus with the mass and thickness of the PUC textile. After exposing the PUC knitted textiles to summer conditions, the colour changes are larger but also less correlated with the substrate. Greater exposure to solar radiation has a greater impact than the properties of the substrate. Blue samples, especially dark blue have a more uniform colour fading throughout the year (Table 3). Blue PUC samples in colour and lightness values correlate with the mass and thickness of the substrate (Table 4). Correlations in colour changes are higher in winter but correlations in brightness are higher in summer. Dark blue PUC textiles show very small changes in



Colour fading in the polyurethane coating depending on the substrate and conditions of natural weathering colour during winter without correlations, in summer it can be seen more noticeable changes and correlations. In addition to the characteristics of textile substrates, these changes are the result of polyurethane and pigment chemistry. Polyurethane polymers are made by combining isocyanates (R-N=C=O) with polyols containing hydroxyl (-OH) functional groups. Coloured polyurethane is result of interaction of functional groups with the pigment in dispersion form. Weathering of polyurethane polymer causes degradation in the direction of reducing mechanical properties and chemical degradation as well. Both of these changes result in colour fading. In addition, during exposure to atmospheric, pigment degradation occurs, first on the azo group which is more typical for yellow pigments.

## **CONCLUSIONS**

Presented investigation of coated fabric fading and its dependence on fabric substrate, as well as environmental conditions, give a good insight into the behaviour of coated fabrics. PUC fabrics are widely used for different outdoor purposes, and therefore exposed to natural weathering that may intensively affect the fading. The information about the intensity of fading should be useful when projecting coated materials in order to improve fabric properties. The investigation outlined that in addition to the previously established dependence of colour fading on the choice of polymer and colour pigment, this study established the relationship between fading and the substrate itself on which the coloured polyurethane coating is deposited. Changes in colour and lightness are correlated with the mass and thickness of the knitted substrate, and thus with the mass and thickness of the PUC textile. After exposing the PUC knitted textiles to summer conditions, the colour changes are larger but also less correlated with the substrate.

## **REFERENCES**

- Das, S., P. Pandey, S. Mohanty, and S. K. Nayak. 2017. Investigation into the Influence of UV Aging on Green Polyurethane/Nanosilica Composite Coatings Based on Transesterified Castor Oil and Palm Oil Isocyanate. *Journal of Inorganic and Organometallic Polymers and Materials* 27: 641-657.
- Potočić Matković, V. M., and Z. Skenderi. 2017. Influence of Modification on the Structural and Tensile Properties of Polyurethane Coated Knitted Fabrics after Natural Weathering. *Fibers & Textiles in Eastern Europe* 25, 4: 89-94.
- Sundang, M., C. S. Sipaut, S. and Saalah. 2020. Preparation of Cationic Polyurethane Dispersion and Its Effectiveness as Denim Dye Fixing Agent. *Materials Science and Engineering* 778: 1-7.
- Štaffová M., F. Kučera, J. Toháček, P. Dzik, F. Ondreáš, and J. Jančář. 2021. Insight into color change of reversible thermochromic systems and their incorporation into textile coating. *J Appl Polym Sci.* 138:e49724.
- Wypych, G. 2013. Handbook of Material Weathering, 5th ed. Toronto: ChemTec Publishing.

# Evaluation of Emotional Images According to Differences in Post-processing of plastic Cosmetics Containers

Ji Eun Lee <sup>1,\*</sup>

<sup>1</sup> Ewha Womans University; smilelje@naver.com

\* Corresponding author: smilelje@naver.com

## Abstract

Among the elements constituting the package designs, the completeness of color, material, and surface treatment finish (hereinafter referred to as CMF) is an important factor that determines the quality of the product and plays a major role in forming a brand image identity. This study was intended to examine emotional images according to colors and surface treatment finishes (post-processing) among cosmetics package design elements. Emotional image evaluation was carried out with a Likert scale using the extracted emotional adjectives for sample rendering, and those emotional images that appeared at high values by color and by post-processing were analyzed through the average values of individual evaluation results. As a result of the study, it was identified that emotional images appeared differently by color and by post-processing through emotion evaluation. The results of this study suggest that the emotional images of cosmetic containers may change according to changes in the color and post-processing.

**Keywords:** Color, Emotional, CMF, Cosmetics, Plastic materials

## INTRODUCTION

Recently, as interest in K-beauty has been increasing, the scale of the domestic cosmetics market has been growing. Accordingly, competition among cosmetics brands is intensifying naturally. If a certain image of a brand is consistently perceived by consumers, it can lead to lasting relationships and loyalty to the brand. Therefore, cosmetics brands exhibit their discrimination from other brands with product package designs that fit their brand image in order to establish their identity.

Cosmetics package designs play a role in maintaining the characteristics of a product by delivering information, attributes, and contents of the product to consumers through visual elements (Gu and Kim 2010). Cosmetics package designs consist of elements such as the brand logo, design layout, shape, material, and color. Among such elements, the completeness of color, material, and surface treatment finishing (CMF) is an important factor that determines the quality of the product and plays a major role in forming a brand image identity. It is also one of important elements to satisfy the emotions of consumers (Lee 2014).

Therefore, in this study, those package design elements that can lead to the cosmetics brand identity will be analyzed through the emotional images according to the colors and surface treatment finishes (post-processing) among the cosmetics package design elements in order to prepare objective standards for enhancing brand competitiveness.

## METHOD

### Stimulus selection

First, in view of the fact that the customer base of the cosmetics market is being diversified, a market survey was conducted targeting domestic mid- to low-priced brands that can be easily accessed to select the shapes and types of basic cosmetics containers that are mainly used for products. A total of nine brands were surveyed, which are Laneige, Mamonde, Innisfree, Etude, The Face Shop, Missha,

Tony Moly, It's Skin, and Nature Republic, and cream products in the best-selling basic lines with the highest sales in each brand were mainly surveyed.

According to the results of the survey, the shape of containers most extensively used for cream products was the jar shape, and pp plastic was mainly used as the material. Thereafter, the range of colors (R, YR, YG, G, BG, PB, N9.5, translucent) and the tones (bright) used frequently in the products of the nine brands were extracted using the IRI Hue&Tone System. Those surface treatment finishes (post-processing) that were frequently used by the nine brands were glossy general injection that did not undergo any post-processing, matt coating, which has a matt finish, and glossy/matte silver vapor deposition that gives a feeling of metal.

Consequently, a total of 48 sample ranges were selected by combining the colors and surface treatment finish (post-processing) elements extracted through the market survey, and the final sample images were made by substituting the foregoing into pp(plastic) jar-type cream containers through 3D rendering.

finish (post-processing)	container cap	container body	color
case 1	general injection (glossy)	general injection (glossy)	
case 2	matt coating	matt coating	
case 3	glossy silver vapor deposition	general injection (glossy)	R, YR, GY, G, BG, PB, N9.5, translucent (case 3-6 are only for container body)
case 4	glossy silver vapor deposition	matt coating	
case 5	matt silver vapor deposition	general injection (glossy)	
case 6	matt silver vapor deposition	matt coating	
Total number of samples		48	

Table 1: Table of combinations of colors and post-processing elements for sample images.

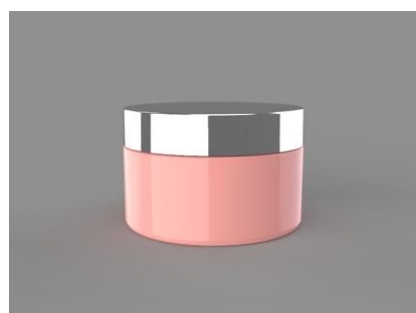

Figure 1: Rendered sample images.

### Extraction of emotional adjectives

In the case of emotional vocabularies, since there are many previous studies conducted in South Korea, the vocabularies finally presented in previous studies were collected rather than directly extracting emotional vocabularies. Referring to previous studies on emotional images of product designs and cosmetics packages, 16 emotional adjectives (luxurious, clean, transparent, splendid, elegant, simple, natural, rough, smooth, moist, soft, light, feminine, refined, mysterious, and medicinal) that appeared frequently in relation to the shape, color, and material qualities were extracted. Thereafter, color design experts excluded adjectives with the same meanings and finally extracted six emotional adjectives (clean, elegant, natural, moist, soft, refined). In addition, 'preferred' was added in order to

investigate changes in preference according to emotional images. Therefore, a total of seven adjectives were selected.

**Emotional images evaluation**

Emotional images of the 48 rendered images were evaluated using the finally extracted adjectives. A total of 40 men and women in their 20s to 40s participated in this evaluation questionnaire survey. The participants evaluated the degrees of images felt by them on a 7-point Likert scale using the seven emotional adjectives presented for 48 cosmetics container images. The evaluation method was composed so that answers would be selected from the Likert 7-point scale, ranging from 1 (not at all) to 7 (strongly agree). The evaluation questionnaire survey was carried out through mobile using the Google online questionnaire, and the participants were asked to evaluate the images with the mobile phone set to 100% brightness and the horizontal screen.

**RESULTS**

In this study, to examine which emotional images show high scores for the colors and post-processing of cosmetic packages, the average values of the evaluation results were derived and arranged in a table.

**Results according to color changes**

The results of evaluation of emotional images according to colors are as shown in Figure 2. In the case of R and YR, the 'soft' image showed high scores, in the case of GY and G, the 'natural' image showed high scores, in the case of BG and PB, the 'moist' image showed high scores, and in the case of achromatic color N9.5(Wh) and translucent color, the 'clear' image showed high scores. In the case of relatively similar series of colors located closely in the hue circle, the same emotional image adjectives showed high scores.

R							
	case 1	case 2	case 3	case 4	case 5	case 6	mean
elegant	4.85	4.45	4.95	<b>5.00</b>	4.73	4.70	4.78
clear	4.58	4.23	4.65	4.50	4.43	4.35	4.45
natural	3.28	3.73	3.55	3.65	3.40	3.50	3.52
moist	4.80	3.78	4.88	4.33	4.45	3.98	4.37
<b>soft</b>	<b>5.68</b>	<b>4.68</b>	4.68	4.70	<b>5.00</b>	<b>4.83</b>	<b>4.93</b>
refined	5.03	4.40	<b>5.15</b>	4.83	4.63	4.65	4.78
preferred	4.80	4.13	4.40	4.45	4.30	4.30	4.40

BG							
	case 1	case 2	case 3	case 4	case 5	case 6	mean
elegant	4.08	3.53	4.25	4.05	4.15	4.13	4.03
clear	4.63	4.13	4.68	<b>4.50</b>	4.40	4.45	4.46
natural	4.43	4.13	4.05	4.40	4.23	4.38	4.27
<b>moist</b>	<b>5.25</b>	<b>4.08</b>	<b>5.23</b>	4.40	<b>5.08</b>	4.50	<b>4.75</b>
soft	4.48	<b>4.68</b>	<b>4.25</b>	4.20	4.28	<b>4.53</b>	4.38
refined	4.03	3.90	4.40	4.15	4.20	4.25	4.15
preferred	4.13	3.63	4.18	4.00	4.03	4.18	4.02

YR							
	case 1	case 2	case 3	case 4	case 5	case 6	mean
우아함	3.95	3.70	<b>4.88</b>	4.53	4.35	4.13	4.25
깨끗함	3.95	4.10	4.35	4.15	3.95	3.93	4.07
자연적인	3.85	4.03	3.83	3.65	3.85	3.50	3.78
촉촉한	4.25	3.63	4.53	3.90	3.90	3.28	3.91
부드러운	<b>4.50</b>	<b>4.80</b>	4.78	<b>4.70</b>	<b>4.48</b>	<b>5.00</b>	<b>4.71</b>
세련된	3.80	3.80	4.28	4.20	3.88	4.23	4.03
선호하는	3.93	3.70	4.15	3.73	3.55	3.55	3.77

PB							
	case 1	case 2	case 3	case 4	case 5	case 6	mean
elegant	4.43	4.40	5.05	4.18	4.65	4.83	4.59
clear	5.13	4.98	5.40	5.30	4.90	<b>4.95</b>	5.11
natural	4.28	4.18	4.53	4.10	4.48	4.48	4.34
<b>moist</b>	<b>5.45</b>	<b>4.93</b>	<b>5.63</b>	<b>5.33</b>	<b>5.23</b>	4.63	<b>5.20</b>
soft	5.05	<b>5.28</b>	5.15	4.83	4.90	4.88	5.01
refined	4.70	4.70	5.13	5.08	4.78	4.80	4.86
preferred	4.80	4.73	5.05	5.25	4.83	4.85	4.92

GY							
	case 1	case 2	case 3	case 4	case 5	case 6	mean
elegant	3.30	3.18	3.53	3.55	3.30	3.30	3.36
clear	4.10	4.10	4.05	<b>4.43</b>	3.58	3.93	4.03
natural	<b>5.10</b>	<b>4.48</b>	4.28	<b>4.43</b>	<b>4.40</b>	<b>4.35</b>	<b>4.50</b>
moist	4.70	3.70	<b>4.78</b>	4.20	4.28	3.70	4.23
<b>soft</b>	4.33	4.18	4.08	4.13	3.95	3.90	4.09
refined	3.53	3.75	3.50	3.88	3.13	3.43	3.53
preferred	3.48	3.75	3.40	3.33	-3.23	3.28	2.33

N9.5							
	case 1	case 2	case 3	case 4	case 5	case 6	mean
elegant	5.08	5.05	5.45	5.40	5.13	5.20	5.22
<b>clear</b>	<b>6.23</b>	<b>6.10</b>	<b>5.80</b>	<b>5.88</b>	<b>5.60</b>	<b>5.75</b>	<b>5.89</b>
natural	4.73	4.83	4.50	4.13	4.50	4.43	4.52
moist	5.45	4.68	5.65	5.00	5.05	4.48	5.05
soft	5.28	5.35	5.45	5.13	5.30	5.15	5.28
refined	5.20	5.00	5.60	5.18	5.18	5.00	5.19
preferred	5.38	5.18	5.53	5.38	5.08	4.85	5.23

G							
	case 1	case 2	case 3	case 4	case 5	case 6	mean
elegant	3.05	3.50	4.18	3.90	3.35	3.80	3.63
clear	3.98	4.20	4.73	4.15	3.88	4.03	4.16
natural	<b>4.90</b>	<b>4.80</b>	4.85	<b>4.50</b>	<b>4.28</b>	<b>4.53</b>	<b>4.64</b>
moist	<b>4.90</b>	4.00	<b>5.25</b>	4.30	4.13	3.88	4.41
soft	4.28	4.48	4.43	4.25	4.03	4.25	4.28
refined	3.28	3.70	4.25	3.85	3.60	3.78	3.74
preferred	3.53	3.80	4.33	3.58	3.40	3.53	3.69

translucent							
	case 1	case 2	case 3	case 4	case 5	case 6	mean
elegant	2.98	2.63	3.88	<b>4.43</b>	3.98	4.85	3.79
<b>clear</b>	<b>4.03</b>	<b>3.30</b>	3.83	3.95	3.93	4.48	<b>3.92</b>
natural	2.73	2.48	2.83	2.88	2.80	2.80	2.75
moist	3.40	2.88	3.98	3.80	3.90	3.58	3.59
soft	3.23	3.05	3.55	3.75	3.60	3.80	3.50
refined	2.98	2.83	<b>4.00</b>	4.28	<b>4.20</b>	<b>5.00</b>	3.88
preferred	3.20	2.63	3.98	4.05	3.83	4.50	3.70

Figure 2: Table of analysis of average values of emotional images according to color changes.

**Results according to changes in post-processing**

The results of evaluation of emotional images according to changes in the post-processing are as shown in Figure 3. In the case of the combination of general injections (glossy/glossy), the combination of glossy silver vapor deposition-general injection(silver glossy/glossy), and the combination of matt silver vapor deposition-general injection(silver matt/glossy), the ‘moist’ image showed high scores, in the case of the combination of matt coatings(matt/matt) and the combination of matt silver vapor deposition-matt coating(silver matt/matt), the ‘soft’ image showed high scores, and in the case of the combination of glossy silver vapor deposition-matt coating(silver glossy/matt), the ‘clean’ image showed high scores.

case 1										
	R	YR	GY	G	BG	PB	N9.5	traslucent	mean	
elegant	4.85	3.95	3.30	3.05	4.08	4.43	5.08	2.98	3.96	
clear	4.58	3.95	4.10	3.98	4.63	5.13	<b>6.23</b>	<b>4.03</b>	4.58	
natural	3.28	3.85	<b>5.10</b>	<b>4.90</b>	4.43	4.28	4.73	2.73	4.16	
moist	4.80	4.25	4.70	<b>4.90</b>	<b>5.25</b>	<b>5.45</b>	5.45	3.40	<b>4.78</b>	
soft	<b>5.68</b>	<b>4.50</b>	4.33	4.28	4.48	5.05	5.28	3.23	4.60	
refined	5.03	3.80	3.53	3.28	4.03	4.70	5.20	2.98	4.07	
preferred	4.80	3.93	3.48	3.53	4.13	4.80	5.38	3.20	4.15	

case 4										
	R	YR	GY	G	BG	PB	N9.5	traslucent	mean	
elegant	<b>5.00</b>	4.53	3.55	3.90	4.05	4.18	5.40	<b>4.43</b>	4.38	
clear	4.50	4.15	<b>4.43</b>	4.15	<b>4.50</b>	5.30	<b>5.88</b>	3.95	<b>4.61</b>	
natural	3.65	3.65	<b>4.43</b>	<b>4.50</b>	4.40	4.10	4.13	2.88	3.97	
moist	4.33	3.90	4.20	4.30	4.40	<b>5.33</b>	5.00	3.80	4.41	
soft	4.70	<b>4.70</b>	4.13	4.25	4.28	4.83	5.13	3.75	4.47	
refined	4.83	4.20	3.88	3.85	4.15	5.08	5.18	4.28	4.43	
preferred	4.45	3.73	3.33	3.58	4.00	5.25	5.38	4.05	4.22	

case 2										
	R	YR	GY	G	BG	PB	N9.5	traslucent	mean	
elegant	4.45	3.70	3.18	3.50	3.53	4.40	5.05	2.63	3.80	
clear	4.23	4.10	4.10	4.20	4.13	4.98	<b>6.10</b>	<b>3.30</b>	4.39	
natural	3.73	4.03	<b>4.48</b>	<b>4.80</b>	4.13	4.18	4.83	2.48	4.08	
moist	3.78	3.63	3.70	4.00	4.08	4.93	4.68	2.88	3.96	
soft	<b>4.68</b>	<b>4.80</b>	4.18	4.48	<b>4.25</b>	<b>5.28</b>	5.35	3.05	<b>4.51</b>	
refined	4.40	3.80	3.75	3.70	3.90	4.70	5.00	2.83	4.01	
preferred	4.13	3.70	3.75	3.80	3.63	4.73	5.18	2.63	3.94	

case 5										
	R	YR	GY	G	BG	PB	N9.5	traslucent	mean	
elegant	4.73	4.35	3.30	3.35	4.15	4.65	5.13	3.98	4.20	
clear	4.43	3.95	3.58	3.88	4.40	4.90	<b>5.60</b>	3.93	4.33	
natural	3.40	3.85	<b>4.40</b>	<b>4.28</b>	4.23	4.48	4.50	2.80	3.99	
moist	4.45	3.90	4.28	4.13	<b>5.08</b>	<b>5.23</b>	5.05	3.90	<b>4.50</b>	
soft	<b>5.00</b>	<b>4.48</b>	3.95	4.03	4.53	4.90	5.30	3.60	4.47	
refined	4.63	3.88	3.13	3.60	4.20	4.78	5.18	<b>4.20</b>	4.20	
preferred	4.30	3.55	-3.23	3.40	4.03	4.83	5.08	3.83	3.22	

case 3										
	R	YR	GY	G	BG	PB	N9.5	traslucent	mean	
elegant	4.95	<b>4.88</b>	3.53	4.18	4.25	5.05	5.45	3.88	4.52	
clear	4.65	4.35	4.05	4.73	4.68	5.40	<b>5.80</b>	3.83	4.68	
natural	3.55	3.83	4.28	4.85	4.05	4.53	4.50	2.83	4.05	
moist	4.88	4.53	<b>4.78</b>	<b>5.25</b>	<b>5.23</b>	<b>5.63</b>	5.65	3.98	<b>4.99</b>	
soft	4.68	4.78	4.08	4.43	4.20	5.15	5.45	3.55	4.54	
refined	<b>5.15</b>	4.28	3.50	4.25	4.40	5.13	5.60	<b>4.00</b>	4.54	
preferred	4.40	4.15	3.40	4.33	4.18	5.05	5.53	3.98	4.38	

case 6										
	R	YR	GY	G	BG	PB	N9.5	traslucent	mean	
elegant	4.70	4.13	3.30	3.80	4.13	4.83	5.20	4.85	4.37	
clear	4.35	3.93	3.93	4.03	4.45	<b>4.95</b>	<b>5.75</b>	4.48	4.48	
natural	3.50	3.50	<b>4.35</b>	<b>4.53</b>	4.38	4.48	4.43	2.80	3.99	
moist	3.98	3.28	3.70	3.88	4.50	4.63	4.48	3.58	4.00	
soft	<b>4.83</b>	<b>5.00</b>	3.90	4.25	<b>4.53</b>	4.88	5.15	3.80	<b>4.54</b>	
refined	4.65	4.23	3.43	3.78	4.25	4.80	5.00	<b>5.00</b>	4.39	
preferred	4.30	3.55	3.28	3.53	4.18	4.85	4.85	4.50	4.13	

Figure 3: Table of analysis of average values of emotional images according to changes in post-processing.

**DISCUSSION AND CONCLUSIONS**

This study examined emotional images according to colors and surface treatment finishes (post-processing) among cosmetics package design elements to develop effective package designs that fit brand identities.

Those colors and post-processing elements that are the most extensively used in the domestic market were derived to make 48 cosmetic sample images. Thereafter, referring to previous studies on emotional vocabularies regarding product designs and cosmetics package elements, seven emotional adjectives were extracted. Finally, emotional images were evaluated to examine emotional adjectives for 48 sample images, and the results according to colors and surface treatment finishes (post-processing) were arranged.

The results of the study are as follows. First, emotions according to colors were evaluated and according to the results, in the case of R and YR, the ‘soft’ image showed high scores, in the case of GY and G, the ‘natural’ image showed high scores, in the case of BG and PB, the ‘moist’ image showed high scores, and in the case of achromatic color N9.5(Wh) and translucent color, the ‘clear’ image showed high scores. The results as such can be interpreted as indicating that relatively similar colors located in the same series in the hue circle can have similar emotional images.

Next, in the results of evaluation of emotions according to the combinations of post-processing, in the case of the combination of general injections (glossy/glossy), the combination of glossy silver vapor deposition-general injection(silver glossy/glossy), and the combination of matt silver vapor deposition-

general injection(silver matt/glossy), the 'moist' image showed high scores, in the case of the combination of matt coatings(matt/matt) and the combination of matt silver vapor deposition-matt coating(silver matt/matt), the 'soft' image showed high scores, and in the case of the combination of glossy silver vapor deposition-matt coating(silver glossy/matt), the 'clean' image showed high scores.

Through the evaluation of emotions, it could be seen that emotional images appeared differently by color and by post-processing, and such results suggest that the emotional images of cosmetics containers may vary according to changes in the color and post-processing. In addition, it was found that there are conditions for those combinations of colors and post-processing that can maximize certain emotional images. For example, it is thought that when a 'soft' image is desired to be shown, the relevant emotional image can be more effectively shown by expressing the package container with bright R and YR series colors and designing the finish (post-processing) as a combination of matte coatings (matte/matte). Lastly, it could be seen that the preference increased when the emotional image strongly felt from the sample image was being moist and clean. It is thought that if products representing a brand is developed through the data as such, post-processing elements that have the emotional image that coincide with the brand image can be applied to products to show the brand image more strongly.

In this study, since the participants were asked to evaluate emotional images only according to changes in color and post-processing elements while the shapes of the containers were set identically, the results of this study can be said to have appeared according to changes in the color and post-processing. However, this study is meaningful in that it mainly examined the emotional images of colors and post-processing among product package elements unlike the existing studies on emotional vocabularies related to domestic cosmetic brand images and products. In addition, it is expected that this data will be helpful in preparing objective standards by verbalizing subjective emotions about packages.

## REFERENCES

- Chae, J. S., Y. S. Jang, and H. B. Kim. 2016. Extracting Representative Emotional Words for Analyzing Preference Factors in Product Design; Focused on Shape, Color and Texture. *JOURNAL OF INDUSTRIAL DESIGN STUDIES* 10(4): 31-38.
- Gu, H. Y., and M. K. Kim. 2010. The package design strategy for a brand image reinforcement of raw rice wine. *A Journal of Brand Design Association of Korea* 8(1): 5-21.
- Kim, C. J., and J. S. Park. 2015. Consumer's emotional responses to cosmetic packaging design. *A Journal of Brand Design Association of Korea* 34(34): 79-90.
- Lee, M. J., J. M. Rhie, Y. S. Jang, and M. J. Jang. 2012. Preference of moisturizing cosmetics' container design image-With a focus on sensitivity adjective image language. *Korean Society of Design Science* 25(1): 125-134.
- Lee, N. J. 2014. The Research of the User Emotional Actions on the Product CMF(Color/Material/Finishing): Focusing on the Robot Design for Single Households (Masters dissertation). *Ewha Womans University*, Seoul, Republic of Korea.
- Shin, Y. W., and M. S. Shin. 2019. 2019 Cosmetic Industry Analysis Report. Korea health Industry Development Institute.



# Shape, Color and Meanings. Comparison of Two Studies

Georgina Ortiz-Hernández <sup>1</sup>, Citlali Quetzalli Ortiz Hernández Ramírez <sup>1</sup> and Oscar Francisco Bustamante <sup>2,\*</sup>

<sup>1</sup>, Psychology Faculty, UNAM, AMEXINC; georginaortiz@gmail.com, citlali110q@gmail.com

<sup>2</sup> AMEXINC; ozkar3478@gmail.com

\* Corresponding author: ozkar3478@gmail.com

## Abstract

In this paper, we compare two studies, one conducted in 2008 and the other in 2019. Our main objective was to analyze if time has influenced the assigned meanings to shapes and colors in a student population with similar characteristics.

Our most relevant findings were: In the first study (2008), we found a higher number of meanings for the colors, meanwhile in the second, we found a higher number of answers associated with the different shape-color associations. Some meanings appeared for the same shape-color associations in both studies. The green and the blue square had the higher number of answers, meanwhile the pink and the gray circle and triangle generated new meanings.

**Keywords:** *shape, color, meaning*

## INTRODUCTION

The world around us is full of elements that communicate different meanings that we interpret based on our experiences with the objects and their functionality with reality.

Therefore, our brain interprets the stimuli of our surroundings that we perceive through our senses, and it transforms them into organized and congruent sensations where the exterior world generates a series of meaning-signifiers which, in turn, are translated to a communication code so we can state that the visual perception is determined neither by the stimulus configuration nor by subjective arbitrariness, but it is mediated by the processing of unconscious elements at a pre-attention level. Later, these elements generate cognition capturing each element as an organized whole (Wertheimer 1923) and, by a prototypic matching, where an object is compared with the abstract and idealized patterns that are stored in the memory (Matlin 1996).

Thus, in the perceptual process of the shape, Gestalt laws explain that perception tends to group different components by their similarity, giving the impression of being part of the same structure, or by their proximity that integrates them into a single object or transforms the elements of nature into geometric shapes (Montserrat 1998).

Furthermore, the *perception of color* is a learning process based on the experience that begins in a social environment and later becomes something private. Thus, this element becomes an essential component to outline and refine the images of the objects (Ortiz Hernández 2008). We must not forget that an important attribute of color is its relationship with emotional aspects that, at the same time, are associated with certain culturally established symbolisms (Ortiz 2002), which allows attributing a series of meanings to different shapes and colors that modify how the colors of things are appreciated (Kandel et al. 1996).

Therefore, the interpretations given to the meaning-color associations result from prior knowledge and expectations about a color or an object (Treisman and Schmidt 1986) and the utility provided by color in everyday life (Ortiz 2008).

For all these reasons, we considered that shapes and meanings are influenced by personal and cultural aspects within a context, allowing the generation of meanings that can be modified over time.



The study had the following objectives:

- To verify if time influence the modification of the meanings for the shape-color associations
- To discover if color-shape associations patterns are preserved over time

**Sample**

The sample consisted of 1246 students from the Universidad Nacional Autónoma de México, 600 from the first study, and 646 from the second from different humanities, sciences, and social areas careers.

**Instrument**

The instrument had three sections: in the first one, we collected demographic information. In the second one, we asked about the experience of the participants with color; and in the third one, we presented three shapes: a circle, a square, and a triangle in nine different colors: red, pink, orange, yellow, green, blue, gray, white, black and no color at all (colorless) which had to be evaluated with a meaning.

**Analysis of results**

We obtained 1,218 different meanings that were classified in 53 different categories in both studies. We compared both studies analyzing their frequencies and defining significant differences of the data through a square chi test with relevance acceptance criteria of  $\alpha \leq 0.05$  and establishing chromatic patterns (Ortiz 2008). For this purpose, we only considered the first ten categories and the five meanings with the highest frequencies in both studies.

**COMPARISON OF THE RESULTS OF THE FIRST AND THE SECOND STUDY (2019)**

With this non-parametric analysis, we observed that:

- There were significant differences ( $p \geq 0.001$ ) (Figure 1) for the three shapes (circle, square, and triangle) with the red, pink, blue, white, gray, and black colors, for the orange and green circles and squares; and for the yellow square and triangles and the colorless square.

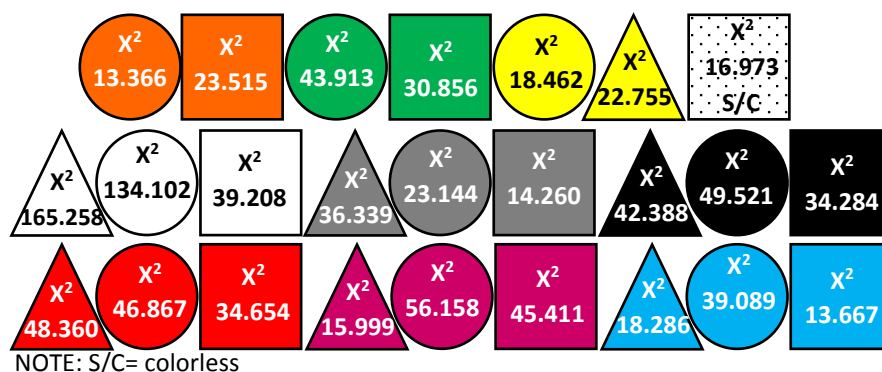

Figure 1: Significant differences in the Chi-square test for the categories of both studies.

Analyzing the frequencies of the categories that both studies had in common, in the first study we obtained a higher number of frequencies for 4 categories and 42 shape-color associations, and in the second study, in 14 classifications and 36 shape-color associations. However, both studies presented high frequencies in 6 categories but different shape-color associations.

Thus, the first study had the higher frequencies, mainly in the following categories:

- a) Games and toys, blue circle
- b) **Positive affections**, red and pink circle, triangle and square, orange circle and square and orange square and green and yellow circle;
- c) **Qualities**, white square, circle, and triangle; negative affections, gray square, circle and triangle, and black triangle;
- d) **Nature**, black circle and square and red circle;
- e) **Furniture and accessories**, white square; and
- f) **Mortuary**, black triangle.

In the second study, the higher frequencies in the categories were:

- a) **Games and toys**, red, orange, and green circle; pink square;
- b) **Positive affections and quantity**, white circle and triangle;
- c) **Qualities**, black square and triangle;
- d) **Nature**, blue square and triangle;
- e) **Furniture and accessories**, gray and black square, pink triangle; and
- f) **Geometric figures**, colorless square and black triangle.

Therefore, the first study showed a higher number of white, red, yellow, gray, and colorless shapes with higher frequencies of categories compared to the second study that had a higher number of orange figures with higher incidences. However, the number of blue, green, pink, black, and colorless shapes in both studies was the same.

Regarding the meanings, they were analyzed and classified according to Ortiz (2011). We selected those that were relevant or showed higher frequencies in both studies (2008 and 2019). The high permanence colors were those present for the three shapes and the same color, the medium permanence colors were those with the same color and two shapes, and the low permanence colors were those with one meaning, one shape, and one or more colors (see Figure 2).

**High permanence meanings**



**Medium permanence meanings**

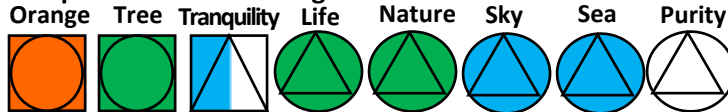

**Low permanence meanings**

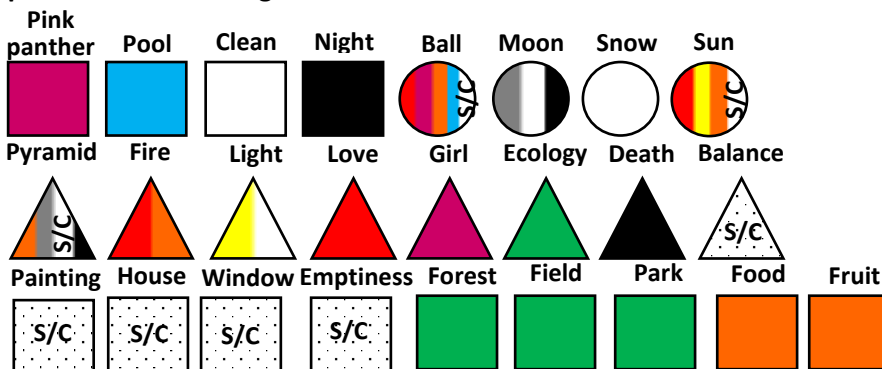

Figure 2: Meanings that appear in both studies (2008 and 2019).

**UNIQUE MEANINGS OF EACH STUDY**

Unique meanings were determined based on the fact that a meaning appeared for a specific shape-color association in one of the studies but not in the other.

In the quantitative analysis, for the first study, we found that there were fewer shapes (72) and meanings (48) and a higher incidence of concepts in the colorless shapes and none in the blue ones. In the second study, we found a higher number of shapes (117) and meanings (63) and a higher quantity of concepts for the three shapes and with all the colors, except for the colorless triangle and the gray, black and red squares (Figure 3).

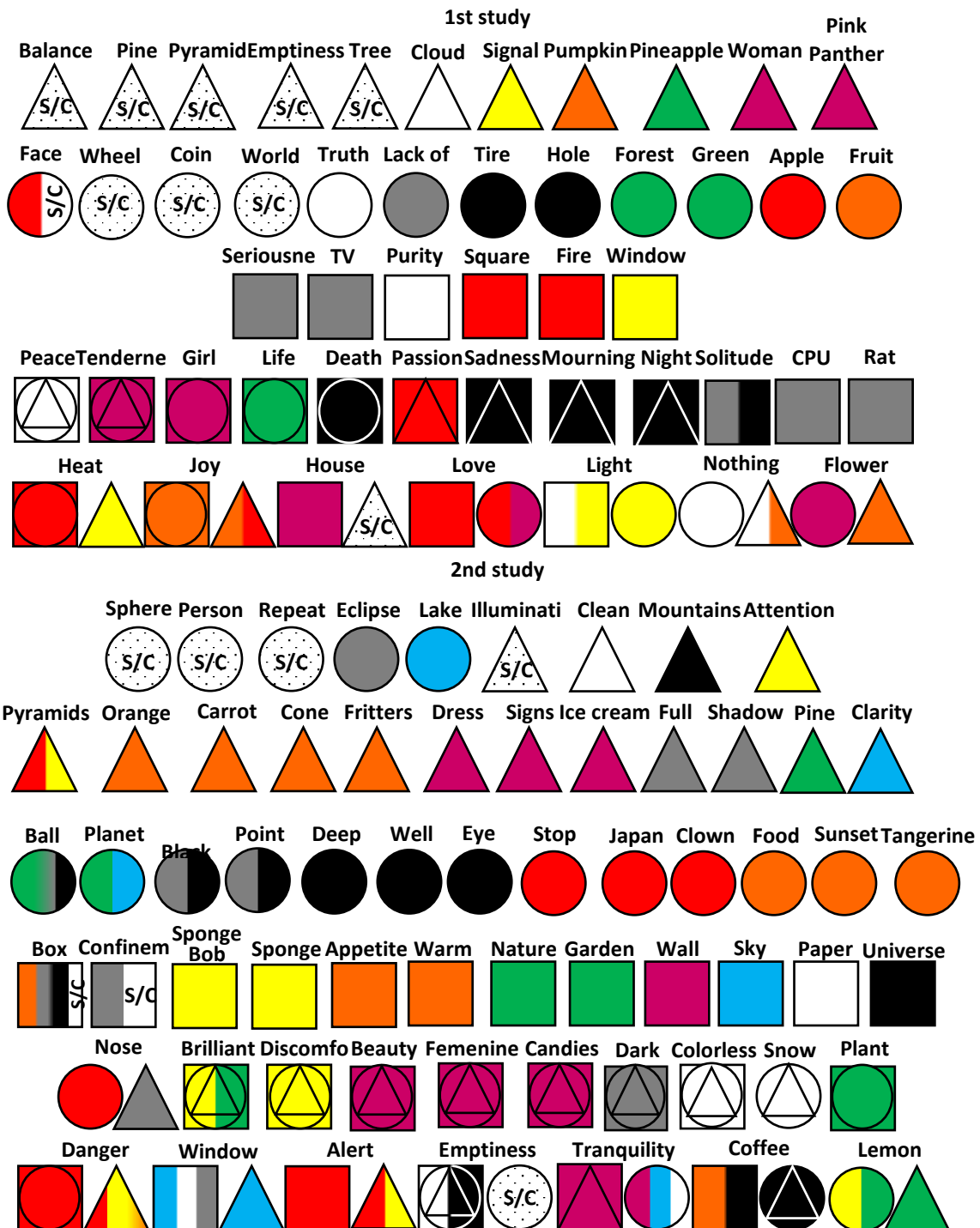

Figure 3: Unique meanings of each study (2008 and 2019).

## **CONCLUSIONS**

The determination of meanings in the objects we perceive is influenced by the dynamics established by shapes and colors, creating some properties.

Human imagination and creativity use both aspects to shape them into concrete objects, concepts, and ideas. However, the properties obtained by these mental creations do not arise from nothing but come from a dynamic of construction between subject-object and object-subject, i.e., the person establishes the properties perceived and communicated by the object and transforms these characteristics into more or lesser abstract meanings.

Shape and color are the sources of established meanings and the raw material for creativity and the invention of new things.

For this reason, the meanings that we found in this study are different from those of 2008. However, this could be perceived as an opinion, thus to verify this assumption, we compare the categories of both studies using a chi-square test. There were statistically significant differences for 25 of the 30 stimuli, proving that concepts people have about something evolve.

We should also point out that this non-parametric analysis was carried out with the categories that coincided in both studies, and those that do not have a simile in the other study could not be evaluated, so they can be considered evidence of the emergence of new concepts.

Likewise, we observed that the second study had a higher number of meanings for a greater diversity of shape-color associations compared to the first study showing that not only are there meanings that remain in the collective memory, but that those new concepts are added to it.

However, it also should be noted that not all the meanings that we presented here were unknown since terms discovered in previous studies were found, including the 2008 study.

These terms were named high permanence terms since they were found for one or more shapes and one or more colors in both studies, confirming that some concepts are linked to colors that transcend time.

This fact confirms one of the many life paradoxes: although humanity is constantly changing, it does it based on previous knowledge that is constant and serves as a foundation for interpreting the world and at the same time to transform reality into something new and, paradoxically, into something already known.

From these results, most of the meanings maintained in the collective memory and that transcended time are associated with the green and blue colors and, to a lesser degree, the white, orange, red, yellow, and black colors, and the colorless ones. On the contrary, the colors with less high permanence concepts were the grey and the pink ones.

Likewise, the square was the shape with the highest number of high permanence meanings, followed by the triangle and, finally, the circle.

Having said this, we can conclude that the shapes with a circular and a triangular structure and pink and gray colors are those with the greatest versatility to generate new meanings in the collective imagination, a phenomenon that could be verified in future research.

## **REFERENCES**

- Kandel, E., T. Gessell, J. Schwartz, and H. James. 1996. *Neurociencia y conducta*. España: Prentice Hall.
- Matlin, M. W. 1996. *Sensación y percepción*. México: Prentice Hall Hispanoamericana,.
- Monserrat, J. 1998. *La percepción visual*. España: Biblioteca Nueva.

- Ortiz Hernández, G. 2002. El lenguaje simbólico de la magia y el color. *Revista SEFPSI* 3(1).
- (2008). *Forma, color y significados*. Trillas 2002.
- Treisman and Schmidt. 1969. Illusory conjunctions in the perception of objects. In: *Cognitive Psychology* 14.
- Wertheimer, M. 1923. *Productive Thinking*. New York: Harper.

1 COLOR AND MEASUREMENT INSTRUMENTATION	2 COLOR AND DIGITAL	3 COLOR AND LIGHTING	4 COLOR AND PHYSIOLOGY
5 COLOR AND PSYCHOLOGY	6 COLOR AND PRODUCTION	7 COLOR AND RESTORATION	8 COLOR AND BUILT ENVIRONMENT
9 COLOR AND DESIGN	10 COLOR AND CULTURE	11 COLOR AND EDUCATION	12 COLOR AND COMMUNICATION MARKETING

## 7 COLOR AND RESTORATION

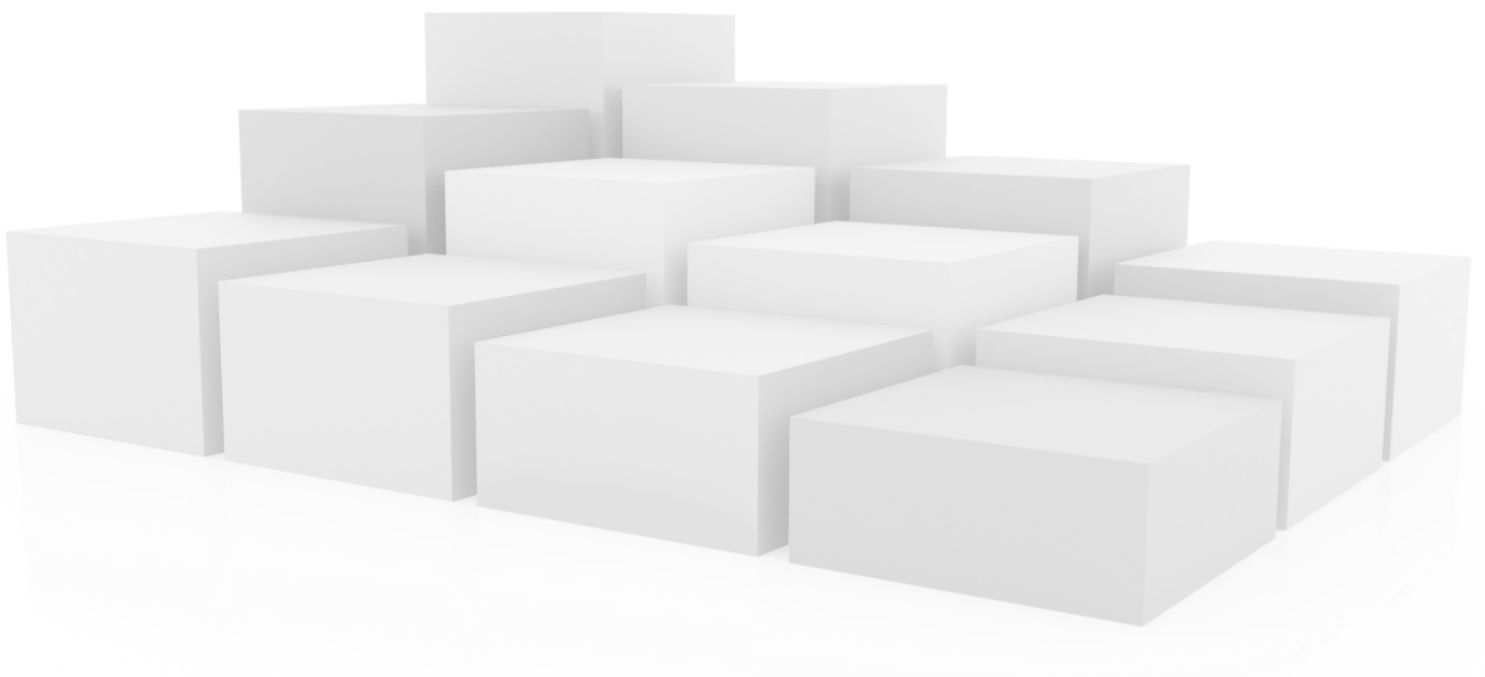



# Colour Prediction Method of Digitalized Korean Court Documentary Painting

Junglim Lee <sup>1</sup> and YungKyung Park <sup>2,\*</sup>

<sup>1</sup> Ewha Womans University; jlee0520@ewhain.net

<sup>2</sup> Ewha Womans University; yungkyung.park@ewha.ac.kr

\* Corresponding author: yungkyung.park@ewha.ac.kr

## Abstract

*Minhwa* artists work to revitalize *chaesaek-hwa*, painting in brilliant colours, that reflect Korean people's traditions and aesthetics and one of the important tasks is retrieving the original colours. The purpose of this study was to predict the colours that are used in a digitalized court documentary painting, *The Royal Procession to the Ancestral Tomb in Suwon*, from 1795 Joseon Dynasty for accurate depiction and heritage colour preservation. The experiment was done with the colours extracted from the digital file of the painting and *CIELAB*. 17 colours were chosen to make the target colours. RGB values extracted from the colours were then converted to  $L^*a^*b^*$  and  $L^*$ ,  $C^*$  and  $h_{ab}$  were calculated.  $L^*C^*$  tone graph was made for each colour and discoloration tendency was examined with one of the four shapes of colour clusters. Newly calculated  $L^*$ ,  $C^*$  and  $h_{ab}$  were then converted back to RGBs and the colours that are predicted to be close to the original were then created and displayed.

**Keywords:** discoloration, colour prediction, Korean court documentary painting, *CIELAB*

## INTRODUCTION

*Minwha* is well-known as *Chaesaek-hwa* (painting in brilliant colours) and is originated from court paintings, expressing vibrant colours of *Obangsaek* (the five basic colours), which well-represents the Korean traditional colour spectrum that plays an important role in the history of Korean paintings (Oh 2017). *Minhwa* artists today try to revitalize these *Chaesaek-hwa* from the past by reproducing them and/or reinterpreting them in various ways. There are *Minhwa* artists who are strict with following the traditional colours and techniques to preserve and maintain the cultural and artistic values from the past. It is crucial for them to reproduce the paintings and to restore them as close to the original as possible with the colours from when they were initially used.

The visual colour appearance of old paintings from the past can be chemically and physically degraded (Pappas and Pitas 2000). Deteriorations and colour changes are most noticeable with simultaneous increase in lightness and decrease in chroma (fading), decrease in lightness (darkening) or a change in hue (Berns 2001). With the technology available today, old paintings can be restored digitally without causing them further physical or chemical damages that can be irreversible, and the original look can also be simulated virtually with hypothetical perfection (Liyu et al. 2013). The main purpose of this study is to predict the colours used in one of the most significant court documentary paintings in Joseon history, the *Royal Procession to the Ancestral Tomb in Suwon*, from 1795 using the colour space, *CIELAB* in the digital realm. This digital colour prediction would give us a glimpse of how the colours would have looked like on the paintings hypothetically when they were initially produced.

## EXPERIMENT

The purpose of this study was to predict the colours used in Joseon Dynasty with the colour space, *CIELAB* using the digitalized 8-panel folding screen paintings of the *Royal Procession to the Ancestral Tomb in Suwon*, painted in 1795 kept in National Museum of Korea (Figure 1).





Figure 1: Kim Hongdo, Kim Tuksin, Yi Inmun et al., "The Royal Procession to the Ancestral Tomb in Suwon", after 1795, eight-panel screen, ink and colour on paper, 50.4 x4600 cm, The National National Museum of Korea, Seoul.

A total of 17 colours, painted on the costumes of the government officials, soldiers, court dancers and musicians, were chosen to create the target colours of prediction (Table 1). The colours of the costumes were chosen for the experiment for: (1) they are comprised of the most vibrant colours that are relatively well maintained; (2) they are painted without gradation with consistent painting technique for costumes need to be in same colour; (3) there are large number of them throughout 8 panels of painting, which are suitable for the experiment.

White	Black	Yellow	Brown	Red	Orange
Pink	Deep Red	Aqua Blue	Indigo Blue	Cerulean Blue	Sky Blue
Bluish Green	Green	Olive Green	Dark Green	Emerald Green	

Table 1: 17 Colours for the predictions selected from the figures of the painting.

Using the close-up files of the paintings with high resolution, each panel was screened and the most vivid and saturated colours with the least colour damage were selected by eyes and picked out with Eyedropper tool from Photoshop and RGBs were taken. RGB values based on sRGB were then converted to  $L^*a^*b^*$  and Lightness ( $L^*$ ), Chroma ( $C^*$ ) and hue angle ( $h_{ab}$ ) were calculated (Table 2).

R2P3	L*		R2P3	C*		R2P3	h <sub>ab</sub>	
18	40.5		12	38.9		2	33.8	
3	41.7		11	43.9		7	34.0	
19	43.0		10	45.7		19	34.6	
13	43.3		6	46.2		3	34.8	
21	43.8		17	47.4		1	35.1	
2	44.1		9	47.8		18	35.5	
5	44.7		8	48.4		5	36.2	
15	45.2		22	49.5		13	37.9	
22	46.7		4	50.3		4	39.1	
1	47.6		16	52.4		22	39.3	
7	48.2		7	52.9		10	40.2	
10	49.7		1	53.1		15	40.5	
16	49.8		14	53.4		14	41.4	
20	50.1		20	54.2		17	41.7	
4	52.1		18	54.6		16	41.8	
8	54.0		2	55.0		6	42.1	
6	54.2		15	55.3		8	42.2	
9	54.7		21	55.4		20	43.0	
17	55.0		3	55.4		21	43.1	
14	55.6		13	55.5		9	46.0	
11	58.3		19	55.5		11	46.5	
12	61.7		5	56.2		12	53.1	

Table 2: L\*, C\* and hab Sorted Chart – Example.

L\*C\* tone graph was made for each colour and discoloration tendency was examined and target colour area was predicted according to the shape of the tendency (Figure 2).

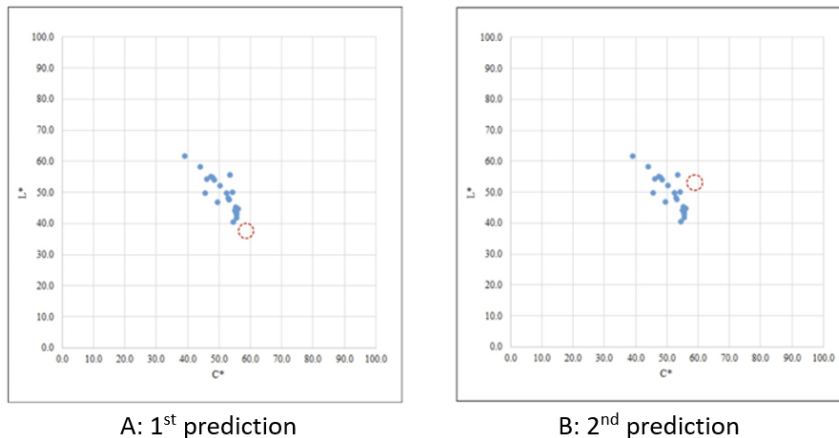

Figure 2: L\*C\* tone graph with 1st and 2nd predicted target colour area – Example.

For achromatic colours, L\* graphs were narrowed first: Black at the lowest L\* and White at the highest L\*. With the narrowed L\* graphs, C\* graphs were narrowed corresponding to the values chosen from the narrowed L\* graphs. With these narrowed graphs, polynomial trendlines were created to get the equation used to calculate the predicted colours (Figure 3). H<sub>ab</sub> values were also narrowed with the values that are corresponding to the narrowed L\* graphs and averaged.

For chromatic colours, C\* graphs were narrowed first with high C\* values and L\* and h<sub>ab</sub> graphs were narrowed corresponding to the values from narrowed C\* graphs. There were two predictions made for the chromatic target colours. The first prediction was made according to the shape of discoloration tendency, whether to increase or decrease L\*, and the second prediction was made with averaging L\* for all colours (Figure 2). For the first prediction, if L\* was increased with increase in C\*, L\* was increased from the narrowed L\* graphs to get the target colours. If L\* was decreased with increase in C\*, L\* was decreased from the narrowed L\* graphs to get the target colours. h<sub>ab</sub> graphs

were narrowed, corresponding to narrowed C\* values and the narrowed values were averaged. The predicted colours that were created from the adjustments of L\*, C\* and h<sub>ab</sub>, the colours that had ΔE\*<sub>ab</sub> ≥ 2.3 were decided to be taken as the predicted colours since 2.3 corresponds to a JND (Sharma 2003) for the colour difference.

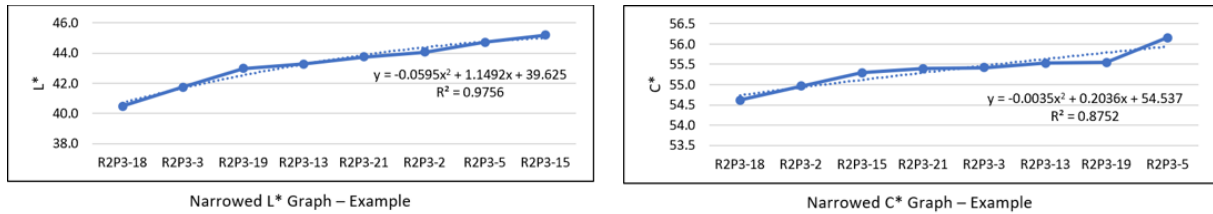

Figure 3: Narrowed L\* and C\* graph with polynomial trendlines and equations – Example.

**RESULTS**

Examination of 17 colours extracted from the digital files showed that each colour had its own tendency of discoloration which was observed on L\*C\* tone graph and the selected colours showed 4 patterns of discoloration tendencies (Table 3). These different patterns of tendency revealed that there is a pattern that could be used to predict the colours on the painting before the deterioration occurred. Out of 17 colours, (A) circular ellipse shape of discoloration tendency was shown by 3 colours: Red, Indigo Blue and Bluish Green. (B) Straight elongated ellipse shape of discoloration tendency was shown by 2 colours: Green and Yellow. (C) Descending elongated ellipse shape of discoloration tendency was shown by 7 colours: White, Orange, Pink, Olive Green, Emerald Green, Aqua Blue and Sky Blue. Lastly, (D) ascending elongated ellipse shape of discoloration tendency was shown by 5 colours: Black, Deep Red, Dark Green, Brown and Cerulean Blue (Table 3).

Discoloration Tendency	Colours						
(A) 	Red	Indigo Blue	Bluish Green				
(B) 	Green	Yellow					
(C) 	White	Orange	Pink	Olive Green	Emerald Green	Aqua Blue	Sky Blue
(D) 	Black	Deep Red	Dark Green	Brown	Cerulean Blue		

Table 3: 17 Colours Categorized into Four Types of Discoloration Tendencies.

### Colour Prediction Method of Digitalized Korean Court Documentary Painting























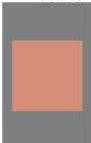



























 Damaged Image	1. White - highest C* 	Predicted White  $L^*=96$ $a^*=-0.5$ $b^*=3.6$	 Damaged Image	2. Black with highest C* 	Predicted Black  $L^*=1.9$ $a^*=0.4$ $b^*=-0.5$
 Damaged Image	3. Red - highest C* 	Predicted Red  $L^*=41$ $a^*=53$ $b^*=32$	 Damaged Image	4. Orange - highest C* 	Predicted Orange  $L^*=48$ $a^*=46$ $b^*=32.1$
 Damaged Image	5. Pink - highest C* 	Predicted Pink  $L^*=61$ $a^*=23$ $b^*=23$	 Damaged Image	6. Deep Red - highest C* 	Predicted Deep Red  $L^*=37$ $a^*=46$ $b^*=27.6$
 Damaged Image	7. Aqua Blue - highest C* 	Predicted Aqua Blue  $L^*=58$ $a^*=-15$ $b^*=-19$	 Damaged Image	8. Indigo Blue - highest C* 	Predicted Indigo Blue  $L^*=28$ $a^*=-2$ $b^*=-25$
 Damaged Image	9. Cerulean Blue - highest C* 	Predicted Cerulean Blue  $L^*=47$ $a^*=-14$ $b^*=-24$	 Damaged Image	10. Sky Blue - highest C* 	Predicted Sky Blue  $L^*=65$ $a^*=-14$ $b^*=-8.2$
 Damaged Image	11. Bluish Green - highest C* 	Predicted Bluish Green  $L^*=59$ $a^*=-19$ $b^*=-7.8$	 Damaged Image	12. Green - highest C* 	Predicted Green  $L^*=58.7$ $a^*=-42$ $b^*=19.1$
 Damaged Image	13. Olive Green - highest C* 	Predicted Olive Green  $L^*=55$ $a^*=-12$ $b^*=34$	 Damaged Image	14. Dark Green - highest C* 	Predicted Dark Green  $L^*=28$ $a^*=-16$ $b^*=15.2$
 Damaged Image	15. Emerald Green - highest C* 	Predicted Emerald Green  $L^*=68$ $a^*=-31$ $b^*=14$	 Damaged Image	16. Yellow - highest C* 	Predicted Yellow  $L^*=69$ $a^*=8$ $b^*=57.5$
 Damaged Image	17. Brown - highest C* 	Predicted Brown  $L^*=40.7$ $a^*=14.9$ $b^*=23.1$			

Table 4: 17 predicted colours painted over the selected images and compared to the damaged images and the colours with highest C\*.

With the final predicted colours from the second experiment, hypothetical digital restoration on the figures is created (Table 4). The parts of the figures where the colours are extracted are digitally covered with the final predicted colours. The digitally restored figures are compared with the most damaged figures from the painting as well as the figures with the colours that have the highest C\*.

## **CONCLUSION**

The purpose of this study was to predict the colours used in one of the most significant court documentary paintings in Joseon history, the *Royal Procession to the Ancestral Tomb in Suwon*, from 1795 using the colour space, *CIELAB* in the digital realm. Discoloration tendency of the selected colours were observed from the digital file of the painting with 4 different patterns, which were used to make the target colours that are predicted to be close to the original colours from the painting when it was initially produced.

The final look of the figures that are digitally restored with the target colours achieved from the experiment look brighter, clearer, and more vivid compared to the colours that are extracted from the painting. Applying these predicted target colours to all the figures on the entire painting would give a great simulation of how the painting would have looked like when it was initially produced in the digital realm. This digitally restored court documentary painting would provide a useful colour data to not only *Minhwa* artists who work to reproduce or reinterpret the painting, but also to those who explore to use the colours from the Joseon Dynasty.

## **REFERENCES**

- Berns, R. S. 2001. The science of digitizing paintings for color-accurate image archives: a review. *Journal of imaging science and technology* 45(4): 305-325.
- Liyu, F., H. Chenchen, and S. Yi. 2013. Application modes of virtual restoration and reconstruction technology in protection and presentation for cultural heritage in China. *Digital Heritage International Congress 2*: 353-356.
- Oh, Y. 2017. Color Analysis of Decorative Court Paintings in the “Late Joseon Dynasty”. *AIC 2017 Jeju*, 74-77.
- Pappas, M., and I. Pitas. 2000. Digital color restoration of old paintings. *IEEE Transactions on image processing*, 9(2), 291-294.
- Sharma, G. 2003. *Digital color imaging handbook*. (1.7.2. ed). CRC press.



# The Experimental Restoration of the Colour of Nanjing Brocade from China

Wensi Lin <sup>1</sup>, Mengyue Zhang <sup>2</sup>, Jisheng Wang <sup>3</sup>, Mengqi Li <sup>4</sup> and Jing Chen <sup>5,\*</sup>

<sup>1</sup> Exhibition Department, Shanghai Museum; linwensi@shanghai-museum.org

<sup>2</sup> Nanjing Boao Culture Technology Company Limited; zhangmengyue\_boao@qq.com

<sup>3</sup> The Institute of Archaeology, Chinese Academy of Social Sciences; 513923540@qq.com

<sup>4</sup> Shanghai Traditionow Culture Development Corporation Limited; manchi.li@traditionow.com

<sup>5</sup> School of Arts, Nanjing University; cjchen@nju.edu.cn

\* Corresponding author: School of Arts, Nanjing University; cjchen@nju.edu.cn

## Abstract

The precious colour knowledge of Nanjing Brocade has no systematic documentation and it's difficult to recover the fading fabrics. This paper introduces a comprehensive research on literature, artifacts and expert experiences that demonstrates the colour range of Nanjing brocade from both conceptual and visual perspectives. We firstly collected colour terms by text mining to find the commonly used colours of Nanjing brocade. Then, we detected natural dyes in textile fragments by high performance liquid chromatography (HPLC), and conducted dyeing experiments in ancient way to create colour samples of Nanjing brocade. Finally, a perceptual evaluation by experts helped match the samples to terms. Therefore, we can develop a colour specification in line with Chinese aesthetics. With internationally accepted LCh value, the specification will facilitate colour identification and application for researchers, producers, and designers.

**Keywords:** Chinese colour, textile colour, natural dyes, text mining, HPLC

## INTRODUCTION

Chinese silk production had great impact in the world through Silk Road from history, and still have great vitality today. The important imperial robe materials made in Nanjing (southwestern Jiangsu, China) during the Yuan, Ming and Qing dynasties represents the topmost craftsmanship of silk dyeing and weaving in China. These materials were later collectively known as the Nanjing brocade or Cloud brocade, which was famous for its cloud-like colours and intricate patterns (Huang et al., 2003). The development of silk refining and over-dyeing at that time greatly enriched the colour range that could be dyed and used for weaving. Meanwhile, the Chinese created hundreds of colour terms<sup>1</sup> to describe the subtle tonal variations. Moreover, the government office set in Nanjing strictly supervised the accuracy of each brocade's colour. Nanjing brocade therefore became an embodiment of rich knowledge of Chinese colour. However, knowledge of Nanjing brocade colour has not been systematically documented, but scattered in the literature, artifacts and the craftsmen's experience. Only a few of colour terms and natural dyeing methods appear in the literature. Precious experiences in colour recognition and dyeing were mainly kept by individuals and passed on from master to apprentice as trade secrets. Hence, Chinese colour knowledge was easily forgotten, especially after the popularity of western colour specifications and synthetic dyes. The ancient brocade fabrics, meanwhile, are irreversibly fading. It's difficult to tell what colours they once were, and how to reoccur them.

In 2009, Nanjing brocade was selected into the representative list of oral and intangible heritage of humanity of UNESCO<sup>2</sup>. Institutions like Nanjing Yunjin Brocade Research Institute have been trying to recover ancient textiles, but mainly on weaving technique. As for colour, they usually use synthetic

<sup>1</sup> A colour term (or colour name) is a word or phrase that refers to a specific colour. The colour term may refer to human perception of that colour (which is affected by visual context) which is usually defined according to a colour system. See Wikipedia "Color term" for details: [https://en.wikipedia.org/wiki/Color\\_term](https://en.wikipedia.org/wiki/Color_term)

<sup>2</sup> "Craftsmanship of Nanjing Yunjin brocade". UNESCO Intangible Cultural Heritage. Retrieved 3 March 2021. <https://ich.unesco.org/en/RL/craftsmanship-of-nanjing-yunjin-brocade-00200>

dyes and choose to restore the colour of faded fabric surface, but this methodology cannot reproduce the original colour. On the other hand, Nanjing brocade is still the city's signboard and in great demand on market. Yet the designers and producers are in lack of an acknowledged brocade colour specification. The *Nanjing Brocade Silk Colour Swatches* currently used in several institutions has three obvious drawbacks. First, it was were dyed with synthetic colourants which covers a different perception from natural colourants. Second, the swatch of certain colour was selected by just one expert, so its subjective and unilateral. Third, it has not been digitized and lacks colour value, causing inconvenience for propagation and communication. Textile production in China now prefers Pantone colour system, but we are longing for a colour system that roots in Chinese traditional aesthetic cognition.

Therefore, this research aims to discover the colours commonly used in Nanjing brocade and to attempt to restore them with ancient materials and techniques, thereby establishing a specification for both heritage conservation and handicraft production. The specification is supposed to set out colour samples with related colour terms and introduce their dyeing materials and methods. Moreover, the international common practice is to give colour values to facilitate and standardize colour usage. For achieving these goals, we collected colour terms through text mining of relevant literature to explore the range of ancient Nanjing brocade colours from a conceptual perspective. We also found some records on dyeing techniques. Together with information on dyes obtained through HPLC and the help of dyeing experts, we conducted natural dyeing experiments to visualize the possible colours of Nanjing brocade and create colour samples. Then, a colour perceptual evaluation by experts helped match the samples to colour terms, and create a colour specification with LCh value. Our work presents and promotes Nanjing brocade colour in a more accessible and more precise way, which facilitates colour identification and application for researchers, producers, and designers. The approach presented in this work will also be beneficial to other researchers of textile colour.

## MATERIALS AND METHODS

We launched a project as shown in Figure 1. As colour knowledge of Nanjing brocade is scattered and fuzzy in the ancient literature, textile artifacts and expert experiences, some advanced techniques are necessary to collect and transform it. The major processes of knowledge production of Nanjing brocade colour are as follows:

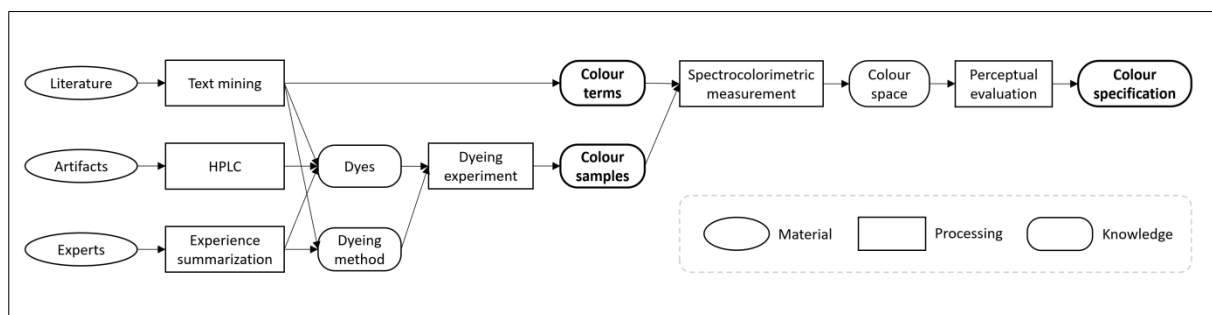

Figure 1: The knowledge production process of Nanjing brocade colour in this research.

### Text mining

To extract new information from different written resources by computer, text mining is particularly useful for collecting highly dispersed colour information (Wong et al., 2016). The colour information we need includes colour terms, natural dyes, and dyeing methods. Our resources of Nanjing brocade literature involve over 22 historical archives and literary works of the Yuan, Ming, and Qing dynasties,

as well as ancient textile catalogues from 13 museums. We use Markus<sup>3</sup> for text annotation and Docusky<sup>4</sup> for database building from the outset. Still, back-end data processing scripts and machine learning algorithms are now better choice due to their flexibility.

### **HPLC**

To restore the colours of Nanjing brocade, we need to know what natural dyes they were made of in the ancient days. HPLC has shown great potential when dealing with dye analysis in textiles (Pauk et al., 2014). We sampled 25 textile fragments in different colours from two Ming and Qing official robes. The identification of natural dyes is based on the comparison of the HPLC results obtained from textile fragments with those obtained from reference samples we dyed. Our reference database concerns 25 specimens of Chinese plant material and one specimen of sticklac by now.

### **Dyeing experiment**

Combining the information obtained from text mining, HPLC analysis, and the experience summarized from professional dyers, we designed dyeing experiments to explore the ancient techniques and the colour range of natural dyes. Two experts participated in and conducted more than 35 experiments with 21 natural dyes, including over dyeing of two different dyes. There are detailed text and image records throughout the experiments.

### **Perceptual evaluation**

A numerical system of colour specification including colour samples with corresponding assigned colour terms, referred to as colour space, is an ideal tool for understanding the colour characteristics of Nanjing brocade. The spectrophotometric measurement provides the most accurate LCh value of our dyed samples for colour space building. The evaluation of colour perception by experts in this research is a new attempt to formulate colour specification. 10 experts participated in the evaluation. They are from different research institutes of Nanjing brocade or dyeing factories. Our questionnaire consists of 3 main questions: 1) What are the commonly used colour terms for Nanjing brocade? 2) What is the typical colour of each term and its LCh data? 3) Among all the samples we have dyed with natural materials, what is the most visually ideal sample for each colour? Experts were asked to point out the focal point of each colour in the LCh colour space, with reference to both the artifacts and our dyed samples. The quantitative result of evaluation allows further comparisons and calculations.

## **RESULTS AND DISCUSSION**

The significant knowledge produced in this research are the Nanjing brocade's colour terms, colour samples, and a colour specification:

### **Colour terms**

There are 73 different colour terms in the entire corpus of Nanjing brocade text, occurring nearly 1000 times in total, of which more than a quarter are scarlet (*dahong* 大红) and a fifth are cyan (*qing* 青). The word cloud (see Figure 2-a) shows all the colour terms that occur more than once. These terms are usually used to describe the ground colour of a textile which gives the first impression of Nanjing brocade. Most high-frequency colour terms are "basic colour terms" that refer to an abstract hue category, including cyan, blue, green, red, yellow, and purple. As for specific colour, scarlet is the most

---

<sup>3</sup> Ho, Hou leong Brent, and Hilde De Weerd. MARKUS. Text Analysis and Reading Platform. 2014- <http://dh.chinese-empires.eu/beta/> Funded by the European Research Council and the Digging into Data Challenge.

<sup>4</sup> Planned by the National Taiwan University Digital Humanities Research Center, Information Engineering Coefficient Collection and Automatic Inference Laboratory, chaired by Professor Xiang Jie, and designed and developed by Dr. Du Xiechang. <http://docusky.org.tw>



dominant colour of Nanjing brocade, and bright yellow (*minghuang* 明黄), agilawood brown (*chenxiang* 沉香) and mineral blue (*shiqing* 石膏) are also in common use.

Dividing all the colour terms into 10 hue categories (Figure 2-b), we can clearly see the distribution of Nanjing brocade colour. It reveals that Nanjing brocade is a kind of colourful textile, as the neutral colours (black, white and grey) account for only 3%. Red and cyan are the dominant hues of Nanjing brocade. Positioned as the national colour by the Ming emperor, red was highly popular among the royals and nobles, and still has a great impact on the aesthetics of the Chinese. Cyan covers a large range of cool shades that well complement and match the warm reds and yellows, and was often used for official robes in China. Blue and green play a similar role to cyan and can both be included in the cyan hue. Yellow is an important colour as only the royal family had been allowed to use it since the Tang dynasty. Furthermore, considering the identity of the wearer, we found that men’s costumes of Nanjing brocade had much less colour diversity than women’s and were more concentrated on reds and cyans. This is probably because only men worked outside as officials. Hence, there were etiquette restrictions on the colour of their clothing but fewer aesthetic demands.

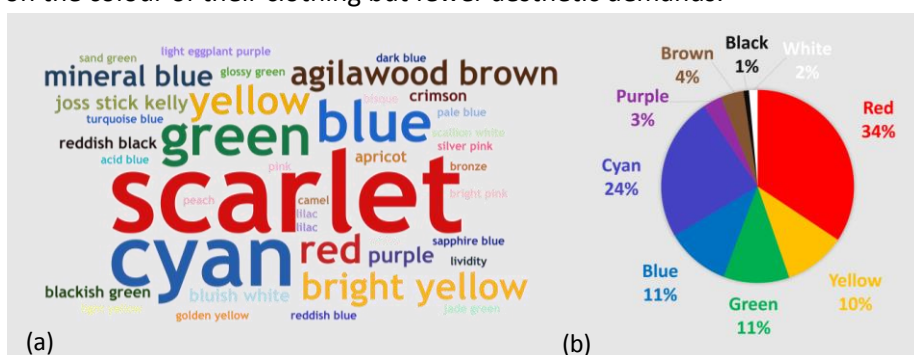

Figure 2: The distribution of Nanjing brocade colour terms: (a) Word cloud by the frequency of individual terms. (b) Hue categories proportion of all colour terms. (Colours in the chart are just indicative).

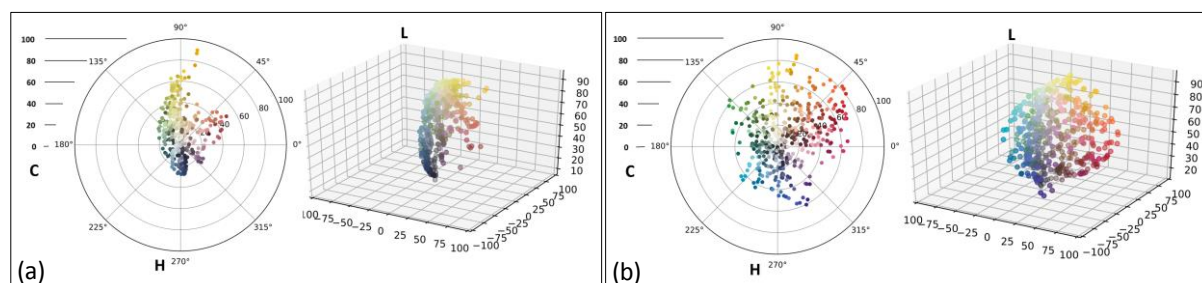

Figure 3: The CIELCh colour space of dyed samples: (a) LCh space of natural dyes. (b) LCh space of the *Nanjing Brocade Silk Colour Swatches* made with synthetic dyes.

### Colour samples

In HPLC, we successfully detected 9 natural dyes in textile fragments. The cyan fragments were all dyed with indigo, the red ones with madder and *polygnum cuspidatum*. In contrast, the yellow pieces were dyed with various materials, including gardenia fruit, pagoda bud, berberis, goldthread and curcuma aromatica. Besides, all green fragments were over-dyed with indigo and one of the yellow dyes. These results confirm and supplement the information from literature.

For the dyeing experiment, we’ve tried 8 dyes detected by HPLC, 16 dyes recorded in the literature, and 4 dyes recommended by experts. Finally, we got 434 different samples of dyed silk threads. All of them were measured the CIELCh value and positioned in colour space as shown in Figure 3-a. Compared to the colour range of the *Nanjing Brocade Silk Colour Swatches* made with synthetic dyes

(see Figure 3-b), the natural dyed samples also cover the entire hue but generally have lower saturation (indicated by the C value) except for yellow. Although the colour range will be expanded by conducting more experiments with more dyes, the difference between synthetic and natural colour is still notable, which strengthens our determination to build a natural colour specification.

**Colour specification**

Three questions got access to the solution through colour perceptual evaluation with experts:

First, among all the 73 colour terms we find in ancient literature, over 60% of them are still in common use, and 10 thereof are the most typical ground colours for Nanjing brocade today. We have successfully matched 33 colour terms with dyed samples, including all the 10 typical colours.

Second, except for the basic colour terms that represent broad hue category, each specific colour term covers a certain shade in the colour space and usually has a focal point (the typical colour). However, this ideal point differs among experts. For example, any light blue within a certain range can be considered bluish white (*yuebai* 月白), yet the typical colour pointed out by experts are generally separated into three disconnected areas, as shown in Figure 4. Considering the opinion of the majority, we decided on an ideal colour of bluish white in L=92, C=12, h=235.

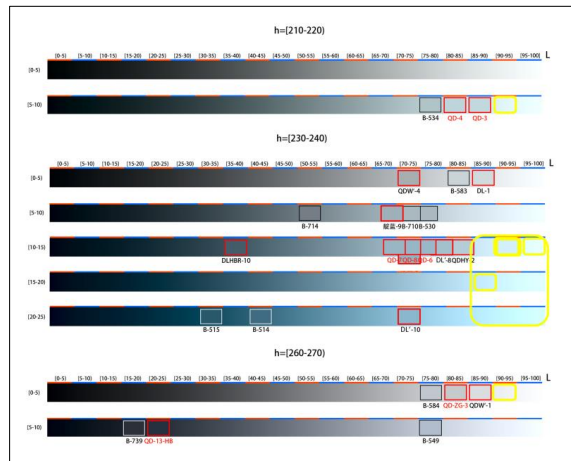

Figure 4: The focal point of bluish white (in yellow squares) by experts (other squares are reference samples).

Third, there is not always an ideal natural dyed sample for each colour term, but currently we can select a closest one from our experiment results. The recommended natural dyed sample for Bluish White went to the lighted one we tinged with indigo solution, which has a value of L=85, C=7, h=228. We will try to dye a closer one in further experiment (see “bluish white” in Figure 5).

Name	<i>Dahong</i> 大红 Scarlet	<i>Minghuang</i> 明黄 Bright yellow	<i>Xinghuang</i> 杏黄 Apricot yellow	<i>Xiangse</i> 香色 Joss stick	<i>Youlü</i> 油绿 Glossy green
Sample					
LCh Dye	40 51 32 Safflower	75 91 80 Gardenia fruit	69 76 80 Gardenia fruit	40 34 115 Gardenia fruit & Indigo	75 46 104 Pagoda bud & Indigo
Name	<i>Molü</i> 墨绿 Blackish green	<i>Yuebai</i> 月白 Bluish White	<i>Shiqing</i> 石青 Mineral blue	<i>Chenxiang</i> 沉香 Agilawood brown	<i>Xuan</i> 玄 Reddish black
Sample					
LCh Dye	32 14 161 Indigo & Goldthread	85 7 228 Indigo	20 10 261 Indigo & Amur-cork tree	46 11 33 Gallnut	11 3 291 Gallnut

Figure 5: The specification of 10 typical ground colour of Nanjing brocade.

With all the data and samples obtained, we create a colour specification of Nanjing brocade. Figure 5 shows a simplified specification of 10 typical colours. This specification will solve the problems we raised at the beginning of this article. It shows the colour terms and the relevant samples with documentation of the dyeing materials and methods. It also gives the internationally used CIE values of the colours and has a digital version, which enables the users to identify and apply these colours quickly, accurately and widely. As a colour system of natural dyes, this specification covers a softer, more subdued shade than that made with synthetic dyes, which enables the users to get closer to the traditional Chinese aesthetic.

## **CONCLUSIONS**

This paper introduces a comprehensive research that demonstrates the colour range of Nanjing brocade from both conceptual and visual perspectives. Our project leverages information from literature, artifacts, and expert experience, basing on the methodology of text mining, HPLC, dyeing experiment, and perceptual evaluation. The colour terms collected by text mining reveal that red and cyan are the dominant hues and scarlet is the most typical ground colour. The samples produced in dyeing experiments with natural colourants proves that the traditional Nanjing brocade colours should be much less saturated than those dyed with synthetic colourants today. The final perceptual evaluation of experts transformed blurry colour perception into LCh values and matched certain colour terms with samples to create a colour specification. This specification can guide the heritage conservation and handicraft production of Nanjing brocade, as identifying and communicating colours will be faster and more accurate. The methodology presented in this work, along with our literature and natural dye database, also provides a reference for other researchers of textile colour.

## **ACKNOWLEDGEMENTS**

This research was supported by the Fundamental Research Funds for the Central Universities from Nanjing University (project no. 011514370105).

Appreciations are given to all participants who volunteered their time and shared their experiences, especially Junzheng Liu, Nana Dong, and other experts of Nanjing brocade or textile dyeing for their help with dyeing experiments and colour perceptual evaluation. We are also grateful to Han Chen for his contribution to images collection and colour control, as well as Wei Liu, Yun Yang, Jixiong Liu and Chongming Luo for supporting colour space building.

## **REFERENCES**

- Burke, P. 2012. *A social history of knowledge: from the encyclopaedia to Wikipedia*. Cambridge: Polity.
- Fraser, B., F. Bunting and C. Murphy. 2004. *Real World Color Management*. San Francisco: Peachpit Press.
- Huang, N., B. Wang and Z. Xiao. 2003. *Nanjing Brocade of China*. Nanjing: Nanjing Press.
- Pauk, V., P. Barták and K. Lemr. 2014. Characterization of natural organic colourants in historical and art objects by high-performance liquid chromatography. *Journal of separation science* 37(23): 3393-3410.
- Wong, M. Y., Y. Zhou and H. Xu. 2016. Big data in fashion industry: Color cycle mining from runway data. Proc. In: *AMCIS 2016: Surfing the IT Innovation Wave—22nd Americas Conference on Information Systems*. Association for Information Systems, 1-10.
- Xu, Z., et al. 2002. *Nanjing Brocade*. Nanjing: Nanjing Press.

# Quantitative color examination and restoration of historical architecture: the study of polychrome decoration of a Qing-style timber-frame structure in Tsinghua University (Beijing, China)

Yutong Jiang<sup>1</sup>, Luke Li<sup>1,\*</sup> and Yihua Zheng<sup>1</sup>

<sup>1</sup> Tsinghua University; jyt\_510@163.com, liluke@mail.tsinghua.edu.cn, zyhcqzr@hotmail.com

\* Corresponding author: liluke@mail.tsinghua.edu.cn

## Abstract

This study incorporates quantitative color examination and measurement into the study of visual performance of traditional Chinese architecture. It provides an objective and scientific way for generating color-restoration drawings and makes it possible to compare the similarities and differences of color schemes between different cases on a common and standard ground.

**Keywords:** *polychrome decoration, color examination, color reproduction, heritage architecture*

## **INTRODUCTION: PAST RESEARCH ON THE COLOR OF CHINESE ARCHITECTURAL POLYCHROME DECORATION**

Polychrome decoration is an indispensable visual component of the traditional Chinese timber-frame structure. In addition to the practical function of preventing moths and insects, polychrome decoration largely determines the overall appearance of the building. It can be said that the history of traditional Chinese architecture is also an extremely rich history of architectural color development.

The ostensive nature of visual images means that the study of such material relies heavily on some form of "presence" of the images themselves. The presence of the image allows the reader to better understand the point through the cross-reference of words and the subject. Photographs are the most objective and authentic first-hand record. However, because most of the cases with polychrome decoration have been damaged and indecipherable over the years, their current state differs greatly from their original state, and many details cannot be identified by the pure observation but require other means of representation. Color-reconstruction drawing is a more common tool. It not only illustrates a more complete decorative appearance, but also reflects researcher's own understanding of the subject. So, color-restoration drawing is not only an expressive technique, but also an important result of the research.

Since digital techniques were not yet popular in the early days, scholars drafted and hand-painted most of their works as shown in Figure 1. With their subdued color and fine details, these drawings can be considered works of art with ornamental value in their own right. However, the authors of these works did not elaborate on the criteria and process for selecting the colors in the restored drawings. In fact, the use of color in hand-painted drawings relies heavily on the draftsman's own subjective visual experience and perceptual judgment, and is a creative process that cannot be replicated. Therefore, it is difficult to quantify the similarities and differences between these restored works and the originals, and we cannot obtain an objective understanding of the color of the original architecture through these drawings.

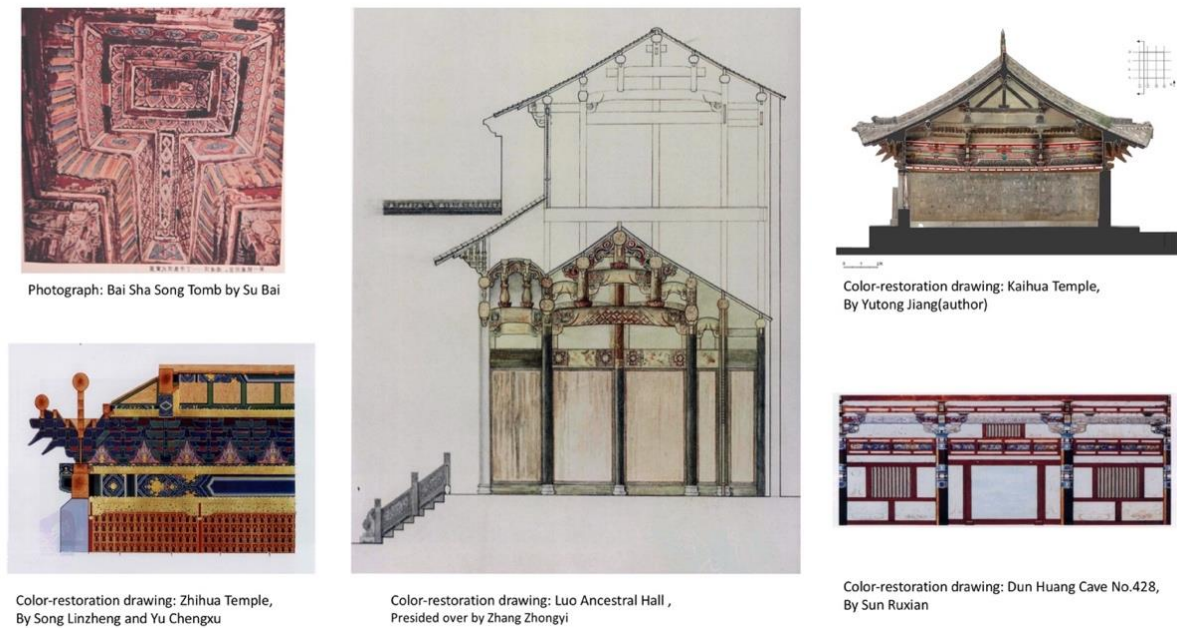

Figure 1: Photographs and color-restoration drawings of different cases.

By briefly reviewing the history of color restoration in the study of Chinese architecture, it can be found that a set of scientific procedures have not yet been established for the investigation of polychrome decoration and the selection of color in restoration drawings. The importance of such a methodology is not only to quantify more scientifically the color characteristics of a particular architecture case, but also to make possible the comparison of color differences between different cases, and to place all kinds of traditional Chinese architectural colors in a common, standard and scientific color system.

## **EXPERIMENTATION AND EXPLORATION: COLOR SURVEY OF QING-STYLE WOODEN MODEL IN TSINGHUA UNIVERSITY**

### **Overview of research subjects**

The research subject is a timber-frame model located on the north side of the first floor of the Department of Architecture Hall of Tsinghua University, covering an area of about 3.2x2.6 meters. The Qing-style polychrome decoration is distributed all over the surface of the model. This type of decoration uses gold as the pattern outline, incorporating blue, green and red as the three main colors, a high-class form that can only be used in royal buildings back in Qing dynasty.

### **The basic procedure of color survey**

#### *On-site Data Acquisition*

- **Holistic Photography:** Used to obtain the overall color effect of the space. We use *Color Checker Passport* by Xrite to later calibrate the color in digital software.
- **Micro Photography:** Used to obtain morphological information of the color coating, such as the size of pigment particles, whether one pigment is superimposed on another, whether there is a



Quantitative color examination and restoration of historical architecture: the study of polychrome decoration of a Qing-style timber-frame structure in Tsinghua University (Beijing, China)

mixture of pigments and other phenomena that are difficult to observe with normal observation.

- Visual color evaluation: This process uses standard color match cards published by professional color institutions to compare with the study object, the color card that appears to be closest to the overall feeling of the target color is selected. This process can be regarded as a qualitative color measurement on a larger scale.
- Chromaticity measurement: The  $L^*a^*b$  chromaticity coordinates of the study subject are measured with professional instruments. There are two types of chromaticity measurement instruments adopted in this study, the RAL COLORCATCH NANO by RAL (Switzerland) and the CM 2600d spectrophotometer by Konica Minolta (Japan).

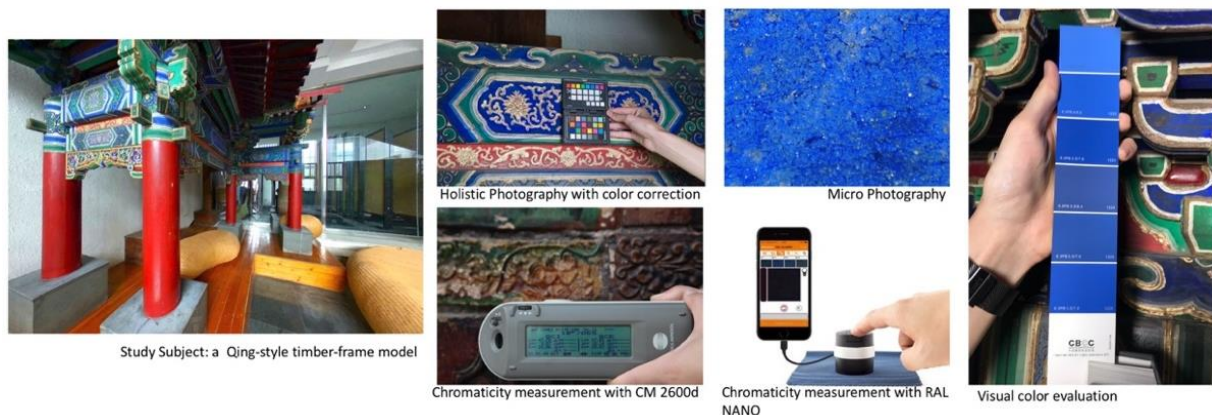

Figure 2: On-site Data Acquisition Process.

### *Data processing and color palette generation*

Several concepts need to be briefly explained in order to scientifically generate a set of color for the color restoration drawings: the "ideal model", the original state and the current state.

- The original state is the state of the building when it was first built. In this state there is no obvious contamination and fading of the polychrome decoration, reflecting the details of the freshly painted surface.
- The current state is the state of the building observed by the researcher. After a long period of sunlight and weathering, there are different degrees of fading and flaking on the surface of the color coating. However, if examined closely, traces of color that reflect the original color effect can still be found.
- The ideal model, on the other hand, is a state that has never existed in reality and exists only in the designer's mind, strictly following all the rules and standards, and is a perfect state that eliminates all kinds of errors and discrepancies.

The color-restoration drawing can show each of the above three states. For example, the restoration of the Luo Ancestral Hall is closer to the visual effect of the current state, while the restoration of the Kaihua Temple tries to approach the ideal model of the polychrome decoration (Figure 1).

Depending on the purpose of restoration, the criteria for the color palette differed accordingly. From the  $L^*a^*b$  chromaticity data obtained through on-site investigation, two different types of colors can be generated.

- Average color: The average color of all color samples of the same hue. Average color can describe the more stable appearance a color presented, closer to the comprehensive effect that the human eye can perceive when observing that color.
- Extreme chroma color: Since discolored pigment often tends to appear lighter (or whiter), the color sample with the highest chroma value can be considered closer to the original state.

These two types of color, the average color and the extreme chroma color can be used to reproduce “the current state” and “the original state” color-restoration drawings respectively. After converting  $L^*a^*b$  values to LCH data, further data processing procedures are as follows.

- Data identification: The two color measuring instruments used in this survey have different measuring calibers. The Konica Minolta CM 2600d spectrophotometer has higher stability and larger caliber (8 mm dia.) and performs better with larger and more uniform color surface. the RAL COLORCATCH NANO has smaller caliber (0.36-8mm dia.), making it easier to measure small color patches with mottled colors. In addition, some pigments use oil as the substrate, others use glue, resulting in different glossiness of the color coating. Therefore, it is necessary to select SCI (Specular Component Included) or SCE (Specular Component Excluded) data according to the glossiness of the target color sample.
- Excluding outlier : Firstly, color samples that are obviously contaminated or discolored will be excluded from the data. Secondly, any color date with  $\Delta E_{2000} > 4$  from average will also be excluded. Since the color appearance of polychrome decoration can be affected by artisan’s hand movements, its stability is naturally lower than modern spray printing product, so the color difference tolerance is relatively relaxed compared with GB/T 15608 (Chinese color system standard), where the acceptable  $\Delta E_{2000}$  should be less than 3.
- Determining the number of shades: The main technique of applying color in Qing style polychrome decoration is called "receding shades" (退晕), which forms a natural and harmonious color transition by overlaying 2-3 shades of the same color with different lightness. Taking color blue as an example, from the color space diagram, most of the dots are distributed within a hue angle of  $30^\circ$ , indicating that the color samples observed on-site as blue are consistent with the actual chromaticity value judgment. The lightness of these blue colors shows three gradients, indicating that there are three layers of “receding shades” on the study subject.

After the above processing and analysis of chromaticity data, the average color and extreme chroma color of each shade can be generated separately, and are applied to color-restoration drawings of “the current state” and “the original state” respectively.

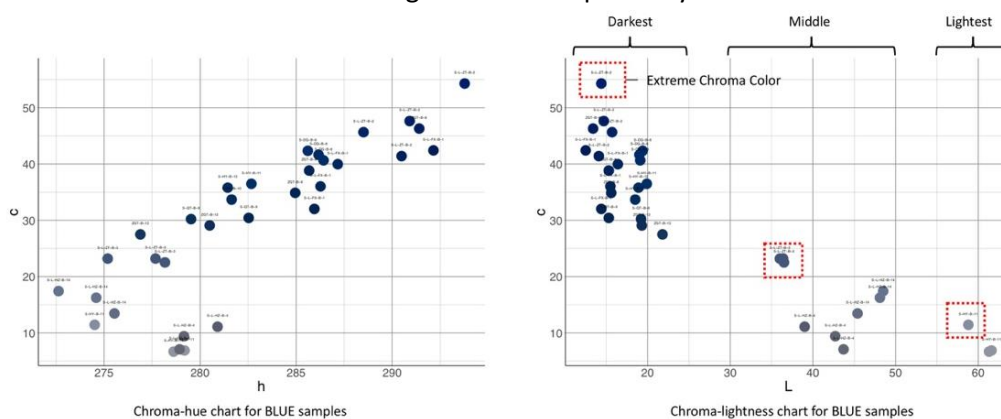

Figure 3: Data Processing of Blue samples.



Figure 4: Color-Restoration Works(Original State and Current State).

## FURTHER INTERPRETATION OF CHROMATICITY DATA

### *Chromaticity Pattern*

Taking blue as an example, from this L-C diagram of average color and extreme chroma color (Figure 5), several things can be identified:

- The lightness of all extreme chroma colors is smaller than the average colors by around 5, which indicates that the former is less faded and discolored than the average.
- The darkest shade blue has the largest sample numbers (21), following the middle shade(12) and the lightest shade(6). It may be generalized that the greater the number of samples, the further the distance between the extreme chroma color and the average color. This is perhaps because the larger the number of samples measured, the closer the average color is to the overall appearance of that color, while at the same time the chances of measuring a purer chroma extreme color will be higher. It can be assumed that when the number of samples increases to a certain level, the difference between the average color and the extreme chroma color will stabilize to a certain amount that may reflect the degree of discoloration of the color of the polychrome decoration.
- The three shades of blue are basically equidistantly distributed on the lightness axis, about 15 for the darkest shade, 40 for the middle shade and 60 for the lighter shade. In other words, each shade can be clearly distinguished by its appearance, and the three shades can form a continuous and stable transitional effect.

### *Implication regarding Craftsmanship*

There is an iconic technique in Qing dynasty polychrome decoration known as “gelled patterning with gold leaf”(沥粉贴金). The basic process is to mix a kind of paste from glue and earth powder, outline the raised pattern through the tip of the tube stuffed with the paste, and then gild the pattern with gold leaf. In addition to that, the technique of applying gold leaf or gold powder directly to the surface of the structure without gelled patterning also exists.

These two kinds of gold-related techniques can both be seen on the study subject. According to the SCE chromaticity data (Figure 5), the gold without gelled paste has higher lightness than the gold with gelled paste. This phenomenon may have two possible explanations. Firstly, the gelled gold is three-dimensional and takes up a smaller area, making it harder to measure and the chromaticity value may be affected by nearby colors. Secondly, there are two types of gold leaf used in polychrome decoration, one is called *Kujin* (库金 as pure gold), the other is *Chijin* (赤金 as pink gold). *Kujin* contains up to 98% gold, while *Chijin* only contains 74% and the rest is mainly silver. The difference in composition causes



Chijin to be visually whiter. It can be speculated that Kujin with higher purity might be used in gelled patterning gold while Chijin might be applied to larger areas without gelled paste.

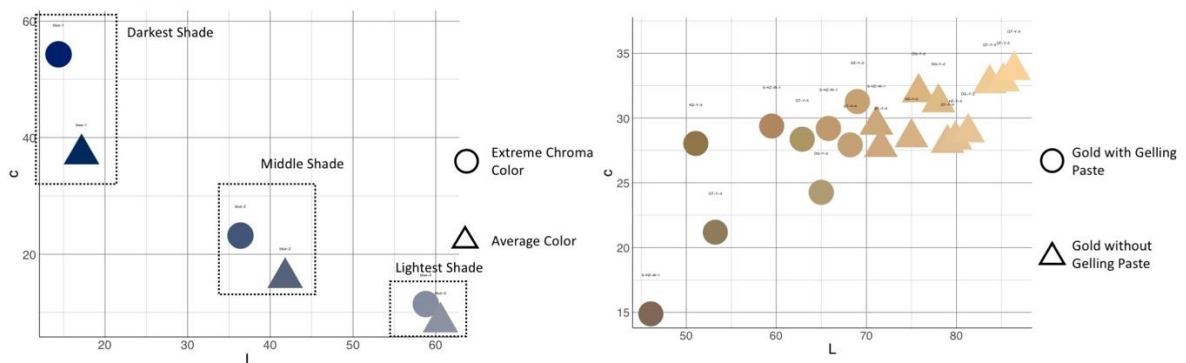

Figure 5: L-C Charts of Blue and Gold.

### **FURTHER DISCUSSION – FINDING THE “IDEAL MODEL” THROUGH RESTORATION OF THE ORIGINAL CRAFTMANSHIP AND PIGMENT**

This paper explores the procedures for quantitative color examination of the polychrome decoration of Chinese heritage architecture. This process not only helps researchers to form a more scientific understanding of the color performance of the architecture, but also reveals some hidden clues regarding design and craftsmanship.

This research method focuses on the visual characteristics of the color of heritage buildings, looking for areas where the pigment is less discolored, in order to resemble as much as possible the color appearance of the building as when it was just finished painting. However, even such areas are still not the true "ideal model" of the polychrome decoration.

In order to more accurately restore the ideal color effect, color examination and investigation should also include methods such as microsample extraction, X-ray fluorescence analysis (XRF), polarized light microscopic analysis (PLM), and cross-sectional microscopic analysis, to identify the material composition of the pigments and the painting process (such as the thickness of the pigment layers and the order of coloring).

Based on the understanding of material and craftsmanship, we can obtain a complete set of "ideal color scheme" by experimenting on a series of color sample using original pigment and procedure and measuring its chromaticity values, which can be used to produce the color-restoration result of the "ideal model" of the heritage architecture.

### **REFERENCES**

- Jingyi, B. 2007. *Paintings and Polychrome Decoration of ancient Chinese buildings*. Beijing: China Building Materials Industry Press.
- Luke, L., and S. Yiyuan. 2021. A Preliminary Study on the Visual Properties and Material Practices of the Color Surfaces of Heritage Buildings--Take the Traditional Mineral Pigment “Shiqing” (Azurite) as an Example. *Palace Museum Journal* (04): 65-94+110-111.

# Diagnostic analysis for colour restoration of a painted Japanese *emakimono*

Martina Redi <sup>1</sup>, Sofia Ceccarelli <sup>2,\*</sup>, Alessandra Terrei <sup>1</sup>, Noemi Orazi <sup>2</sup>, Valeria Guglielmotti<sup>3,4</sup>, Dariush Hampai <sup>3</sup>, Sultan Dabagov <sup>3,5,6</sup> and Fulvio Mercuri <sup>2</sup>

<sup>1</sup> Laboratorio di Conservazione e Restauro dei Beni Culturali, Dipartimento Studi Letterari, Filosofici e di Storia dell'Arte, Università di Roma Tor Vergata, Italy; rdemtn96@gmail.com , terrei.alessandra@gmail.com

<sup>2</sup> Dipartimento di Ingegneria Industriale, Università di Roma Tor Vergata, Italy; sofia.ceccarelli@uniroma2.it, noemi.orazi@uniroma2.it, mercuri@uniroma2.it

<sup>3</sup> INFN LNF, XlabF, Via E. Fermi, 54, I-00044, Frascati, Rome, Italy; dariush.hampai@Inf.infn.it

<sup>4</sup> Università degli Studi Guglielmo Marconi, Via Paolo Emilio, 29, Rome, Italy valeria.guglielmotti@Inf.infn.it

<sup>5</sup> RAS P.N. Lebedev Physical Institute, 119991 Moscow, Russia; sultan.dabagov@Inf.infn.it

<sup>6</sup> National Research Nuclear University MEPhI, 115409, Moscow, Russia

\* Corresponding author: sofia.ceccarelli@uniroma2.it

## Abstract

In the restoration of painted artworks, the colour characterisation is a fundamental analysis to address the choice of suitable materials for the recovery and the consolidation of the painting layers. In this paper, we present a diagnostic study on a unique Japanese painted paper handscroll (*emakimono*), dated back between the late Edo (1603-1867) and the early Meiji (1868-1912) periods, preserved at the Museum of the Civilisation- Prehistoric Ethnographic Museum “Luigi Pigorini” in Rome (Italy). The artwork required an urgent restoration and consolidation of the entire structure. In order to identify the most appropriate materials for the intervention, non-destructive FORS and XRF measurements were carried out on the artefact. The results allowed the identification of the colour palette used for tests on the chromaticity and the efficacy of the proper consolidants to employ in the final restoration.

**Keywords:** *Heritage Science, FORS, pigments, restoration, Japanese handscroll*

## INTRODUCTION

The colour has been employed in the human artistic expression in many contexts with the shared purpose of communicating a message. The loss of such features leads to the decrease of the value of the artworks itself, such as in the case of ancient manuscripts. In the latter, the colour appears in many types of decorations, like as small and colourful illuminations, typical of occidental medieval manuscripts, or as part of the story itself, such as in the oriental handscroll here investigated. The studied specimen is classified as *emakimono*, that means “horizontal painting to unroll” (Okudaira 1962) and it is characterised by a particular decorative apparatus with a rich coloured palette which presented several conservation problems, such as the loss of adhesion of the pigments powder. Thus, a non-destructive diagnostic survey based on the colour identification was essential in order to elaborate the best restoration approach to consolidate the artwork. For these reasons, Fiber Optics Reflectance Spectroscopy (FORS) has been employed on the handscroll as main technique for the colours characterisation, as well-established methodology for qualitative detection of pigments through characteristic spectra and colorimetric evaluations (Clarke et al. 2021; Idjouadiene et al. 2021; Aceto et al. 2014; Leona and Winter 2001). Then, the final identification of the colours has been achieved combining the FORS results with those obtained by means of XRF technique. The results have been then used for the elaboration of a laboratory mock-up for studying the behaviour of different types of consolidants with the final goal of planning the most adequate intervention procedure.

## THE EMAKIMONO

The studied handscroll is entitled *Jizō Engi Jō* (地蔵縁起、上) and it narrates the Legend of Jizo of the Yata temple in Kyoto, Japan (Blair and Tsuyoshi 2015). The scroll is a modern copy of a 14<sup>th</sup> century work, known as *Yata Jizō Engi*, probably illustrated by the painter Takashina Takakane. A brief text written on the last sheet of the scroll dates the *Jizō Engi Jō* back approximately to the 1870 decade, referring to its purchase for export purposes during the Meiji era. The artwork was acquired by the Italian artist Vincenzo Ragusa (1841-1927) who lived in Tokyo between 1876 and 1882, developing a particular interest for the Japanese art. Between 1888 and 1916, the Italian artist sold his collection to the Royal Luigi Pigorini Prehistoric Ethnographic Museum in Rome, which is today part of the Museum of Civilization. The *Jizō Engi Jō* represents part of the legends relating to the Yata-dera temple principal deity, the Bodhisattva Jizō, and illustrates the journey of the High Priest Manmei to the Reign of King Enma, where the monk meets Jizō (Figure 1) and admires the Bodhisattva's benevolence towards the souls of the damned, who can be saved from the Hell by Jizo's intercession.



Figure 1: *Jizō Engi Jō* emakimono: detail of the meeting between the High Priest Manmei and the Bodhisattva Jizo with the sampled points (©\_ Museo delle Civiltà – MPE “Luigi Pigorini”).

The illustrated scenes in the handscroll are painted in Japanese style (*Yamato-e*), typical of the late 14<sup>th</sup> century, including both Chinese and Japanese texts within the artwork. The surface of the entire scroll appears glossy and compact, probably due to the characteristic sizing of the support with *dōsa*, a solution made from the animal skin glue (*nikawa*) and alum, which reduces the porosity of the paper (Winter 1984). The studied handscroll has a particular wide structure with an approximate length of 10 m for 35 cm in height.

### Conservation issues

The specimen has never been restored before and several damages affected the paper support, such as material losses caused by an extended entomological attack and horizontal creases spread on the surface of the first sheets, probable symptoms of a wrong handling of the object. Nevertheless, structural and mechanical properties of the support were to be considered in discrete state of conservation. On the other hand, the dehydration and the aging of the media's binding determined its loss of functionality hence causing losses, flaking of the pictorial surface and the incoherence of the pigments in many areas of the handscroll, requiring an urgent consolidation procedure (Figure 2a, b).



Figure 2: a) Detail of a colourful decoration of the handscroll where significant losses of pigments are clearly evident; b) Flaking of paint and losses of pigments appear more evident under magnification (x10) ©\_Museo delle Civiltà-MPE "Luigi Pigorini".

### **THE DIAGNOSTIC APPROACH**

The colour characterisation of the *emakimono* has been carried out using the FORS technique, comparing the obtained spectra with the ones from available database (CNR 2020) and considering the XRF results. The results have been then used for the preparation of a laboratory mock-up on which further colorimetric tests have been performed for the identification of the best consolidant to apply during the restoration treatment on the artwork, by evaluating any chromacity variations due to an artificial ageing process induced on the sample.

#### **Colours analyses**

FORS spectra were recorded with a StellarNet GREEN-Wave spectrometers equipped with a halogen lamp for measurements within the range 350-1150nm. The instrument was optically coupled by means of fibre to a cube with an internal integrating sphere able to measure an area with a diameter of 1cm ("StellarNet FORS Systems" 2021). The XRF spectra have been acquired in the same points of the FORS measures by using the "Rainbow X-Ray" (RXR) experimental station developed at the XLab Frascati of the Istituto Nazionale di Fisica Nucleare – Laboratori Nazionali di Frascati (INFN-LNF) (Hampai et al. 2015; Cappuccio et al. 2021). Such an X-ray fluorescence system is based on the use of polycapillary lenses in a confocal geometry for investigating specimens of the dimensions ranging from several millimeters up to half meter (Hampai et al. 2018).

#### **Mock-up preparation**

Further FORS measurements were carried on the mock-up before and after an accelerated ageing process performed for 17 days within a climate chamber at a temperature of 80° C and humidity values between 65-70%. The process has been carried out to evaluate the effects caused by the ageing of the consolidants on the sample's chromaticity and refractive index. For such an evaluation, the variations of colorimetric and brightness parameters ( $\Delta E$  and  $\Delta L$ , respectively) have been considered to verify the consolidants inability to alter the refractive index and the chromatic characteristic of the media (i.e., that it must not shine, dull or yellow the surface). The parameters variation was calculated from the CIE Lab (Oleari 2008) colorimetric coordinates measured on the same points on the samples before and after the artificial ageing.

## RESULTS

### Identification of the palette

The FORS spectra show the typical profiles of analysed colours (yellow, red, green) with a higher signal in correspondence of most homogeneous sampled areas, such as in the case of red pigment (Figure 3: FORS spectra of the measured colours (continuous lines) and the references (dotted lines)). The different signal intensity between the green and yellow samples with the respect of their references are probably due to pigment powder inhomogeneity, paper support and binder ageing effects.

. The lower reflectance signal is due also to the support and binder contributions that probably reduce the back-reflected light from the pigments. Then, the spectra have been compared with the existing database, providing a preliminary recognition of the pigments, lately confirmed with the XRF measurements.

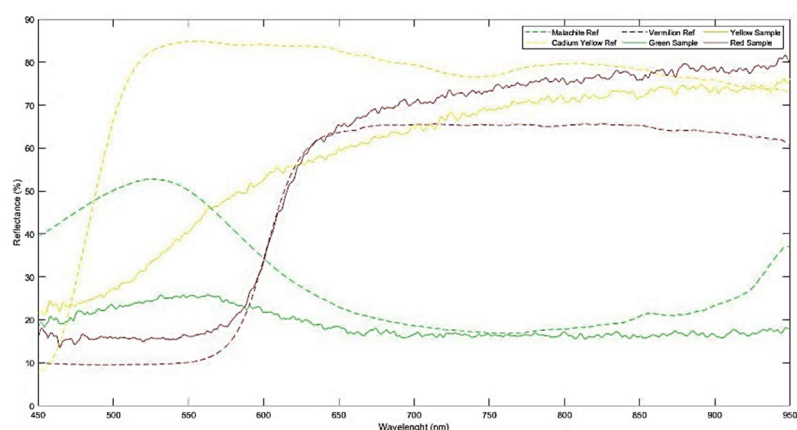

Figure 3: FORS spectra of the measured colours (continuous lines) and the references (dotted lines). The different signal intensity between the green and yellow samples with the respect of their references are probably due to pigment powder inhomogeneity, paper support and binder ageing effects.

The final identification of the analysed colours is summarized in Table 1, providing information about the chemical characterisation and the identified pigment, indicating when the match with the spectral profile is founded. Such results have been then used for the preparation of the laboratory mock-up for chromacity tests on the binders and consolidants, described in the following paragraph.

Colour	Chemical elements by XRF data	Pigment	FORS Ref.
Red	K, S, Ca, Fe, Hg	Cinnabar/Vermilion (HgS)	✓
Green	K, Ca, Fe, Cu, Zn, Hg	Malachite ( $\text{Cu}_2(\text{OH})_2\text{CO}_3$ )	✓
Blue	K, Ca, Fe, Cu, As	Prussian blue ( $\text{FeK}[\text{Fe}(\text{CN})_6]$ )	✗
Orange	S, Ca, Fe, Ga, Pb	Lead tetroxide ( $\text{Pb}_3\text{O}_4$ )	✗

Table 1: Pigment identification by the colour's measurements: XRF chemical components, corresponding pigments and FORS spectra correspondence indicated with the check mark.

### Mock-up preparation and analysis

The laboratory mock-up has been prepared using powdered mineral pigments mixed with *nikawa* glue, applied on a support made of two layers of Japanese paper sized to simulate conditions and materials

as similar as the original ones (Figure 4). The paint samples were then treated with the following consolidants: Klucel G (prepared in alcohol solution, with a concentration of 1%), Funori at 0,5% concentration in water solution (both clarified and not), *nikawa* glue at 1% concentration (Hummert, Henniges, and Potthast 2013). For each colour, an area without consolidant was considered in order to allow the comparison between the treated and non-treated samples.



Figure 4: Preparation of the laboratory mock-up using the pigment identified by the FORS analyses.

The best results have been obtained by the samples treated with *nikawa* and non-clarified Funori. In both these cases were measured the smallest variations of the colorimetric parameters (as shown by the example values reported in Tab.2), corresponding to changes not perceptible to the eye.

Treatment	Parameters	Pre-artificial ageing	Post-artificial ageing
Nikawa	$\Delta L$	-0,6	0,1
	$\Delta E$	3,2	2,7
Clarified Funori	$\Delta L$	-0,7	0,2
	$\Delta E$	7,7	3,5

Table 2: Most significant results related to Cinnabar/vermilion red samples treated with two consolidants and analysed before and after the artificial ageing.

Thus, considering the smallest values of  $\Delta E$  and  $\Delta L$ , the consolidant considered suitable for the restoration of the handscroll was the *nikawa* at 1% concentration, as the same adhesive traditionally used as binding and whose properties of flexibility, chemical stability and compatibility with Oriental artefacts and paintings are beginning to be acknowledged even in the Western conservation culture (Radeglia and Quattrini 2014). The consolidation treatment was executed with a compressed air sprayer, isolating the damaged painted areas with masks cut out of paper to avoid as much as possible the dispersion over the not-damaged areas of the painting.

## CONCLUSIONS

A colorimetric survey has been performed on a colourful and written modern copy of a 14<sup>th</sup> century Japanese handscroll entitled *Jizō Engi Jō*. At the moment of the study, the 19<sup>th</sup> century artwork presented several adhesion issues, mainly regarding the pigments, so that an urgent restoration procedure was needed. The results of FORS measurements allows to characterise the colour palette of the handscroll and prepare a laboratory mock-up used for the identification of the best consolidants to employ to avoid further detachments of the pictorial apparatus of the Japanese handscroll.



## ACKNOWLEDGEMENTS

The authors would thank Dr. Loretta Paderni, Director of the Asian Department at National Prehistoric Ethnographic Museum Luigi Pigorini-Museum of Civilization, Prof. Laura Micheli at the Chemistry Department Laboratories of the University of Tor Vergata for the artificial ageing of the samples and Prof. Luca Milasi of La Sapienza University of Rome for the translations of the texts in the handscroll.

## REFERENCES

- Aceto, M., A. Agostino, G. Fenoglio, A. Idone, M. Gulmini, M. Picollo, P. Ricciardi, and J. K. Delaney. 2014. Characterisation of Colourants on Illuminated Manuscripts by Portable Fibre Optic UV-Visible-NIR Reflectance Spectrophotometry. *Analytical Methods* 6 (5): 1488-1500. <https://doi.org/10.1039/c3ay41904e>.
- Blair, H., and K. Tsuyoshi. 2015. Editors' Introduction. *Japanese Journal of Religious Studies* 42 (1): 1-26. <http://nirc.nanzan-u.ac.jp/nfile/4399>.
- Cappuccio, G., S.B. Dabagov, V. Guglielmotti, D. Hampai, M. Martini, C. Mazzuca, L. Micheli, and M. Redi. 2021. PolyCO in XRF Analysis: Fundamental Parameter Method Applied for Japanese Buddhist Scroll Studies. *Radiation Physics and Chemistry* 188 (November): 109660. <https://doi.org/10.1016/J.RADPHYSICHEM.2021.109660>.
- Clarke, M., F. Gabrieli, K. Rowberg, A. Hare, J. Ueda, B. McCarthy, and J. Delaney. 2021. Imaging Spectroscopies to Characterize a 13th Century Japanese Handscroll, The Miraculous Interventions of Jizō Bosatsu. *Heritage Science*. <https://doi.org/10.1186/s40494-021-00497-1>.
- CNR. 2020. Pigments Database. 2020. <http://fors.ifac.cnr.it/index.php>.
- Hampai, D., Yu. M. Cherepennikov, A. Liedl, G. Cappuccio, E. Capitolo, M. Iannarelli, C. Azzutti, Yu.P. Gladkikh, A. Marcelli, and S. B. Dabagov. 2018. Polycapillary Based MXRF Station for 3D Colour Tomography. *Journal of Instrumentation* 13(04): C04024–C04024. <https://doi.org/10.1088/1748-0221/13/04/C04024>.
- Hampai, D., A. Liedl, C. Polese, G. Cappuccio, and S. B. Dabagov. 2015. "RXR: A New X-Ray Facility at XLab Frascati." *X-Ray Spectrometry* 44 (4): 243-47. <https://doi.org/10.1002/xrs.2614>.
- Hummert, E., U. Henniges, and A. Potthast. 2013. Stabilisation Treatments with Aerosols: Evaluating the Penetration Behaviour of Gelatine and Methylcellulose. *Restaurator* 34(2): 134-71. <https://doi.org/10.1515/res-2013-0008>.
- Idjouadiene, L., T. A. Mostefaoui, A. Naitbouda, H. Djermoune, D. E. Mechehed, M. Gargano, and L. Bonizzoni. 2021. First Applications of Non-Invasive Techniques on Algerian Heritage Manuscripts: The LMUHUB ULAHBIB Ancient Manuscript Collection from Kabylia Region (Afniq n Ccix Lmuhub). *Journal of Cultural Heritage* 49 (May): 289-97. <https://doi.org/10.1016/J.CULHER.2021.03.008>.
- Leona, M., and J. Winter. 2001. Fiber optics reflectance spectroscopy: a unique tool for the investigation of Japanese paintings. *Studies in Conservation* 46 (3).
- Okudaira, H. 1962. *Emaki: Japanese Picture Scrolls*. Charles E. Tuttle.
- Oleari, C. 2008. *Misurare Il Colore*. Edited by Hoepli.
- Radeglia, D, and M. V. Quattrini. 2014. *Il Rotolo Giapponese Bamodoizu - The Japanese Bamodoizu Roll*. Edited by Gangemi Editore.
- "StellarNet FORS Systems." 2021. <https://www.stellarnet.us/systems/color-measurement-systems/>.
- Winter, J. 1984. "Natural Adhesives in East Asian Paintings." *Studies in Conservation* 29 (sup1): 117-20. <https://doi.org/10.1179/sic.1984.29.Supplement-1.117>.

# Hyper-Spectral Imaging Technique: Application for Colorimetric Analysis of Paintings

Marcello Piccolo <sup>1,\*</sup>, Costanza Cucci <sup>1</sup>, Andrea Casini <sup>1</sup>, Filippo Cherubini <sup>1</sup>, Lorenzo Stefani <sup>1</sup>

<sup>1</sup> Istituto di Fisica Applicata “Nello Carrara” del Consiglio Nazionale delle Ricerche (IFAC-CNR), Florence, Italy.  
(m.piccolo.c.cucci, a.casini, f.cherubini, l.stefani)@ifac.cnr.it

\* Corresponding author: m.piccolo@ifac.cnr.it

## Abstract

Collaboration with curators and conservators is of utmost importance when working with Hyper-Spectral Imaging (HSI) technique as the instrumentation and experimental protocols have to match their requested requirements. Other recommendations that need to be followed when acquiring data with an illumination/observation geometry configuration are those issued by the Commission Internationale de l’Eclairage (CIE) for calibrated RGB images and colorimetric values. The difficulties related to obtaining accurate, reliable, and reproducible data suitable for matching the colorimetric calculations as required by CIE result in the still rare application of HSI technique in the art field for colorimetric analysis of paintings before and after restoration. This paper describes the HSI scanner developed at IFAC-CNR for non-invasive diagnostics and accurate color acquisitions on paintings and will discuss HSI measurements focused on color evaluation of the paint surface of a 15th century panel painting before and after the challenging restoration operations.

**Keywords:** hyperspectral imaging technique, color measurement, CIEL\*a\*b\*, sRGB, paintings

## INTRODUCTION

Hyper-Spectral Imaging (HSI), which can be used in different applicative contexts, enables the acquisition of data-sets that include hundreds of spectral images acquired in very narrow spectral bands (bandwidth 2–10 nm). It is a technique that can be implemented with different sensors and camera models but for cultural heritage (CH) applications, it mainly operates in reflectance mode. Moreover, depending on the type of sensor, it covers the Visible (Vis), Near Infrared (NIR), and Short-Wave Infrared (SWIR) regions Cucci et al. (2016). The data obtained with HSI allow the reconstruction of a reflectance spectrum of each pixel in the scene, thus providing laboratory-like spectroscopic information that can be used for identification purposes.

In addition, HSI technique can be used for high quality archival documentation of art works. The data have to be acquired in correspondence to requirements established by curators and conservators with HSI instrumentation adapted to their protocols and with an illumination/observation geometry configuration that follows the Commission Internationale de l’Eclairage (CIE) recommendations, such as the  $2 \times 45^\circ/0^\circ$  or  $d/0^\circ$  configurations, to provide calibrated RGB images and colorimetric values (i.e., CIE XYZ, CIEL\*a\*b\*, sRGB, etc.) Marcus (1998), Berns (2001), Martinez et al. (2002), CIE (2004), Burger and Burge (2009), Cucci et al. (2011).

It is still rare to find experimentations of the HSI technique applied to colorimetric analysis of paintings before and after restoration due to the challenges in meeting the colorimetric calculations required by CIE in data accuracy and reproducibility.

IFAC-CNR has developed a HSI scanner for non-invasive diagnostics and accurate color acquisitions on paintings that will be the focus of the present paper. The measurements centering on the color analysis of a 15th-century panel painting’s surface, before and after the challenging restoration operations, will serve as a case study for illustrating the application of HSI in the field of visual art.



## EXPERIMENTAL

IFAC-CNR developed a pushbroom HSI system consisting of a linear scanner formed of an orthogonal pair of linear motion actuators that move a hyperspectral head in a vertical plane. The components of the head are an ORCA-ER CCD camera (Hamamatsu), a spectrograph (Specim V10E) with very negligible geometric deformations and additional filters for internal diffuse light compensation, and a telecentric lens (Opto-Engineering). The system operates in the 400-900 nm spectral range with an optical module optimized to minimize errors and distortions in the acquired image that may be caused by the non-planarity of the painting and its surface defects. The telecentric lens is able to perform parallel projection within  $\sim 3$ cm depth. This feature is critical for close range scanning in order to avoid parallax errors. It also has an impact on the precision in joining adjacent scan lines, even in situations in which the paint surface may not be flat. The telecentric depth tolerance feature allows for ideal positioning of the scanner in relation to the painting with the assistance of linear pointers. The slightly overlapping vertical strips are scanned at a constant velocity of 1.5 mm / sec. The camera operates at 16.7 frames per second in 2x2 binning mode for each vertical scan, focusing on an image of a magnified object at 60 mm long line segment of the sensor.



Figure 1: IFAC-CNR spectrographic imaging head with the lighting module during the acquisition of HSI data.

The 3300 K QTH source emits radiation, which is sent via an optical fiber illuminator (Schott-Fostec) on an optical fiber bundle ending with a pair of cylindrical lenses. The function of these is to focus the radiation symmetrically at  $45^\circ$  with respect to the normal to the surface, as recommended by CIE (Fig. 1). The color accuracy has been tested on Spectralon™ color standards (SCT) and the results have been very promising, as reported in table 1.

Colorimetric errors may occur, due to straylight, which is isolated from external light. It can be only approximately compensated by flat subtraction from all measured signal wavelengths on spectral channels below 400 nm.

The spatial resolution is evaluated at 50% contrast reduction and is greater than 2 lines/mm at all wavelengths in the 400-900 nm range with spatial sampling rate of the system is 11 dots/mm (279 dpi).

Spectralon Color Target (SCT)	SCT Color difference ( $\Delta E_{00}$ )
red	1.5
green	1.2
blue	0.4
yellow	0.6
cyan	1.2
orange	0.9
purple	0.0
violet	1.0

Table 1: Color difference for the SCT comparing the CIEL\*a\*b\*1976 color values provided by the produced and those calculated from the IFAC HSI scanner for 2° Standard Observer and D65 illuminant.

In order to circumscribe any possible cause of damage on artworks due to light exposure, the maximum illumination of  $\sim 16000$  lux and UVA fraction of approximately  $56 \mu\text{W}/\text{lumen}$  were verified under typical measurement conditions (scan at 1.5mm/sec). When dealing with light sensitive and faded materials the high peak value suggests caution, and the resulting total exposure to light is less than 500 luxhr, which can be considered a fair value regarding the risks of photo-degradation as reported by Thomson (1986).

IFAC-CNR HSI device follows a standardized experimental acquisition protocol that guarantees comparability of different measurement sessions concerning reproducibility of illumination, data-acquisition, repositioning, etc.

## CASE STUDY

The panel painting “Polittico dell’Intercessione” (ca. 1425, 97 cm  $\times$  222 cm) by Gentile da Fabriano (c. 1370–1420) was studied by using HSI. The painting belongs to the Church of San Niccolò Oltrarno in Florence. In 1897, it was badly damaged by fire and, after one century of oblivion, it was selected for a challenging restoration project carried out by the Opificio delle Pietre Dure (OPD) in Florence, Italy, in 1995 Ciatti and Frosinini (2006).

The HSI data were acquired before and after the restoration of the painting mainly to study the colorimetric variations of the painted surface following the treatment. The colorimetric data were stored as CIEL\*a\*b\*76 TIF images files that enabled the visualization of the three-color parameters ( $L^*$ ,  $a^*$ ,  $b^*$ ) as three separated grey level maps, in which high values for the three parameters corresponded to brighter pixels in the resulting image file. Figure 2 presents the sRGB image reconstructed of a detail of the scene “the Resurrection of Lazarus” at the end of the restoration procedure. As the gamut of the colors used by the artist was dramatically reduced after the fire of 1897 and by the previous restoration, it is evident that the color parameters have changed to varying extent depending on the areas of the paintings. To better visualize the results on the painting after the removal of the aged varnish, CIE  $b^*$  value can be used; it represents the blue–yellow component, with yellow and blue in the positive and negative directions, respectively. The images of the  $b^*$  colorimetric values calculated for the CIEL\*a\*b\*1976 color space before and after the restoration and with their color-difference image are reported in Figure 3.



Figure 2: sRGB image of the Lazarus detail reconstructed from the HSI data at the end of the restoration procedure.



Figure 3:  $b^*$  colorimetric value grey scale images before restoration (left); after being restored (middle);  $\Delta b^*$  (after–before) colorimetric value image difference (right). Courtesy of Picollo et al. (2020)

The new elaborated image difference that enables the visualization of these colorimetric variations becomes an important tool for conservators and art historians to obtain knowledge on the extent that previous restoration has altered the artwork.

## **ACKNOWLEDGEMENTS**

The authors would like to thank the former “Soprintendenza Speciale per il Polo Museale Fiorentino” and the “Opificio delle Pietre Dure”, in Florence.

## **REFERENCES**

- Berns, R. S. 2001. The science of digitizing paintings for color-accurate image archives: A review. *J. Imaging Sci. Technol.*, 45: 305–325.
- Burger, W. and M. J. Burge. 2009. *Principles of Digital Image Processing. Core Algorithms*. London: Springer. pp. 97–124.
- Ciatti, M., C. Frosinini, Eds. 2006. Il Gentile Risorto. Il “Polittico dell’Intercessione” di Gentile da Fabriano. Studi e Restauro. Florence, Italy: Edifir Edizioni Firenze.
- CIE. 15:2004. Technical Report. Colorimetry, 3rd ed.; Commission International de l’Eclairage (CIE), Central Bureau of the CIE: Vienna, Austria.
- Cucci, C., A. Casini, M. Picollo, M. Poggesi and L. Stefani. 2011. Open issues in hyperspectral imaging for diagnostics on paintings: When high-spectral and spatial resolution turns into data redundancy. In: *SPIE Optics for Arts, Architecture, and Archaeology III*, S. Pezzati, ed. Bellingham, WA, USA, Volume 8084, 808408.
- Cucci, C., J. K. Delaney and M. Picollo. 2016. Reflectance hyperspectral imaging for investigation of works of art: Old master paintings and illuminated manuscripts. *Acc. Chem. Res.*, 49: 2070–2079.
- Marcus, R.T. 1998. The measurement of color. In: *Color for Science, Art and Technology*, K. Nassau, ed. Amsterdam: Elsevier, 31–96.
- Martinez, K., J. Cupitt, D. Saunders and R. Pillay. 2002. Ten years of art imaging research. In: *IEEE 2002, Proceedings*, 90, 28–41.
- Piccolo, M, C. Cucci, A. Casini, L. Stefani. 2020. Hyper-Spectral Imaging Technique in the Cultural Heritage Field: New Possible Scenarios. *Sensors*, 20(10): 2843.
- Thompson, G. 1986. *The Museum Environment*. Butterworth Heinemann and The International Institute for Conservation of Historic and Artistic Works, Second Edition.



# Spectrographic analysis of colourants of cultural items: from a qualitative to a semi-quantitative data treatment through BCTs

Guido Frison <sup>1,\*</sup>, Maurizio Aceto <sup>2</sup>, Angelo Agostino <sup>3</sup>, Dimitris Mylonas <sup>4</sup> and Alberto Calatroni <sup>5</sup>

<sup>1</sup> UCL Anthropology Department, 14 Taviton Street, London WC1H0BW, UK; frison.guido@gmail.com

<sup>2</sup> Dipartimento di Scienze e Innovazione Tecnologica, Università degli Studi del Piemonte Orientale, 15121 Alessandria, Italy; maurizio.aceto@uniupo.it

<sup>3</sup> Dipartimento di Chimica, Università degli Studi di Torino, 10125 Torino, Italy; angelo.agostino@unito.it

<sup>4</sup> New College of the Humanities at Northeastern. Assist. Professor in Computer Science; dimitris.mylonas@nchlondon.ac.uk

<sup>5</sup> Lucerne University, Senior scientist; calatroni.alberto@gmail.com

\* Corresponding author: frison.guido@gmail.com

## Abstract

We propose to use current spectrographic techniques for detecting colourants in cultural items in a semi-quantitative way, by systematically utilising the notions of colour term, basic colour term (BCT), and by sampling the coloured areas of each BCT. Given for example two manuscripts (MSS), criteria for sampling the areas of the illuminations of a given BCT, and the detected colourants of those areas, it is possible to estimate a degree of colourant difference. Further, a unique identifier of the item colourants is proposed. For achieving this aim we discuss some steps of the analytical procedure, and borrow from ecology three homologous concepts for detecting colourants, i.e.: for a given BCT, the colourant richness, the colourant abundance distribution, and the evenness of this distribution. Further, we explore a procedure, the input of which is a generic picture, and the output is a map of the same object giving the BCTs distribution.

**Keywords:** *colour term, BCT, colourant richness, colourant abundance distribution, colourant evenness*

## INTRODUCTION

Spectrographic techniques for detecting colourants and other materials used in visual arts are based on three conceptual notions, namely, colour terms of the selected stained spots, spectrographic data, and colourants. However, colour terms have never been systematically utilised. Moreover, spectrographic techniques have been used since their beginnings in the early 1990s in a purely qualitative way, without a sample criterion concerning the possible presence of rarely used colourants.

We propose to use current spectrographic procedures in a semi-quantitative way by systematically utilizing the notions of 'colour term' and 'basic colour term' (BCT). Given, for example, two MSS, and criteria for sampling the areas of the illuminations of a given BCT, it is possible to estimate a quantitative degree of their difference. Further, a unique identifier of the item colourants is proposed.

For achieving this aim we will provide a brief introduction to the following empirical concepts of a generic cultural item, namely, the colourant richness, or number of colourants used for each BCT, its colourant abundance distribution (CAD), and the evenness of this distribution, or the degree of variability in colourant abundances. These notions are already used in other disciplines, in particular in ecological studies on biological diversity.

One of us suggested a systematically utilization of the notions of colour term and its corresponding BCT<sup>1</sup> for each analysed stained spot. The modern English BCTs are the following in alphabetical order

---

<sup>1</sup>According to Berlin and Kay (1969: 5-7), a BCT should have the following four properties:

- i) "It [the BCT] is monolexic; that is, its meaning is not predictable from the meaning of its parts";
- ii) "Its signification is not included in that of any other color term";
- iii) "Its application must not be restricted to a narrow class of objects";

only for convenience: BLACK, BLUE, BROWN, GREEN, GREY, ORANGE, PINK, PURPLE, RED, WHITE, YELLOW (in capital letters to differentiate them from colour terms). The difference between colour term and BCT is paramount: for example, 'red' is a BCT, but not 'red-orange' or 'dark red' or 'light red', that are included in the RED BCT.

The treatment of colour terms and BCTs triggered a further working hypothesis of creating an application capable of capturing an image of an illumination and producing the distribution of the BCTs of the miniature itself as an output.

The article is divided in two sections: the first deals briefly with the notions listed above, and the second one examines only few important problems, that we encountered in the course of the analytical process. Further, we illustrate the design of a procedure, the input of which is a generic picture of a given illumination of a MS or a picture, and the output is a picture of the same object giving the BCTs distribution.

### ***A SHORT OVERVIEW OF THE NOTIONS OF COLOURANT ABUNDANCE DISTRIBUTION (CAD), RICHNESS AND EVENNESS***

The detection of the colourant abundance distribution of a BCT is one thing, and providing a synoptic measure of the diversity of colourants of the same BCT of two items represents a second different challenge. A further problem is detectability: not all colourants are equally easy to detect because any analytical technique has definite and specific limits.

Given a cultural item and one of the 11 BCTs, the CAD refers to a vector of colourants, and their absolute and/or relative abundances (see below Table 1). The 11 CADs, one for each BCT, represent a simple but complete information which can be called *colourant identifier of the cultural item*.

Relat. freq.	Azurite	Indigo	Ultram. blue	Madder/ Indigo	Indigo/ Yell. Col.	Indigo/ Ultram.	Unk- nown	<b>Σ relat &amp; abs. freq.</b>	Statistical units (Number of MSS)
a <sub>i</sub>	7.14	35.71	38.1	14.29	4.76	0	0	<b>(100) 42</b>	3 Late antiquity MSS
b <sub>i</sub>	0	20.69	74.14	0	0	3.45	1.72	<b>(100) 58</b>	7 Medieval MSS

Table 1: BLUE BCT: two colourant abundance distributions from 10 MSS of the Paris Bibliothèque Nationale de France. The CADs of two Syriac collections of MSS (relative (a<sub>i</sub> and b<sub>i</sub>) and absolute colourant abundances).

We wish to underline that only the relative abundances are conserved, whether the sample sizes are appropriate. N.B.: we arbitrarily consider as a colourant not only the pure colourant (e.g. azurite, indigo, etc.), but also their mixtures, for increasing the number of 'colourants'. Many different graphical procedures are used to display the equivalent of the CADs, see McGill (2011).

---

iv) "It must be psychologically salient for informants".

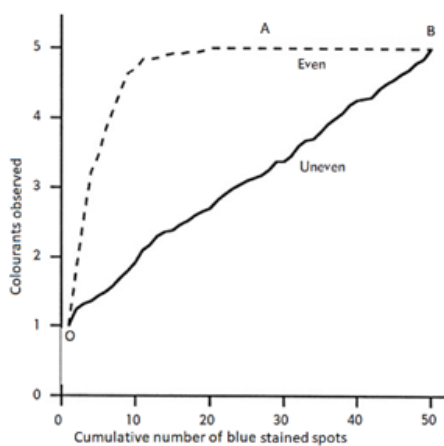

Figure 1: The observed colourant richness of a cultural item in function of the cumulative number of the (BLUE) stained spots. Courtesy by Anne Magurran (2004: 75).

For exploring the relationships between the CADs of the colourants of a given BCT, the richness estimation, and the sample size, let us assume a statistical model in which the chosen BCT is BLUE, the number of already analysed BLUE spots<sup>2</sup> from a MS is 50, and five the number of colourants. Many CADs are possible: Figure 1 shows two ideal extreme distributions: the curve OAB refers to a perfect even assemblage in which each colourant is equally abundant (10 individuals), whereas the uneven assemblage includes four colorants, the abundances of which are equal to one individual, and the abundance of the fifth is 46 individuals.

The *cumulative abundances* (on the horizontal axis) of the two distributions are constrained under the rule of successively sampling at random an individual from each assemblage, without replacement<sup>3</sup>. The richness of both distributions is five, but this data emerges earlier for the even assemblage due to the presence of the asymptotic segment A\_B. Instead, the curve of the uneven assemblage is bound to converge by the model's constraints with the even curve at the x-coordinate= 50.

The two curves represent two assemblages with different evenness, which is meant as a community property in which, if each colourant present is equally abundant, then the MS has high evenness, and if the colourants differ widely in abundance, the assemblage has low evenness. It is apparent that actual CADs will be somewhere between the end-types of Fig. 1, and that uneven assemblages require larger sample sizes than even ones. Given a certain level of confidence (e.g. 95 %), the sample size increases exponentially if the rare colourants make up 5% of the sample, thus becoming incompatible with the slot of time available for the analysis of the cultural items. For estimating colourant richness from samples in the case of bio-richness, see Chazdon et al. (1998).

## **SEVEN PROBLEMS IN THE COURSE OF THE ANALYTICAL PROCESS**

**#1. Codicological and palaeographic description of a generic MS.** The codicological and palaeographical studies of a MS provide significant clues on its possible heterogeneity; if homogeneous, the MS represents a statistical unit of analysis consisting of a set of homogeneous illuminations and its correlated text. If heterogeneous, the different parts of the MS are different statistical units.

<sup>2</sup>The colour name of the stained spot may be sapphire-blue, indigo-blue, light blue, dark blue, etc., that is, one of the many colour terms included in the BLUE BCT, see Kerttula (2002: 175-186).

<sup>3</sup>Data is averaged over 50 randomizations, Magurran (2003: 75).



**#2. Choice of a generic stained spot(*i*) ( $i=1,2,3\dots n$ ) of a given folio and MS, and ascription of a colour term to the spot(*i*).** These operations occur at the same time, but they require different cautions. The analysed number of stained spots for a given BCT, or BCT sample size, must comply a certain level of confidence and permit statistical computations, and the ascription of a colour term to each spot (*i*) is a multi step process.

In a preparatory phase, the analyst performs a first judgement of the illuminations using pictures of the illuminations themselves, chooses the stained spots to be analysed, and associates a colour term according to his perception and experience to each of them. Successively, when the analyst has access to the illuminations of the real manuscript, the previously assigned colour terms can be checked, and some errors may be corrected. Later, a BCT is associated to the colour term of the stained spot, and to the results of spectrographic analyses, then it is possible to check the consistency of the entire process, and further mistakes could be fixed. In a scientific context, the visual stimuli which are in most of the cases presented to subjects are calibrated, using Munsell charts. However, unlike archaeological soil studies, where Munsell charts are used, the estimation of a colour term requires less accuracy, as many colour terms are associated with the same BCT.

The distribution of BCTs in the Munsell system can be determined through an ongoing colour naming experiment<sup>4</sup>. Colour stimuli of about 3 degrees in size from a viewing distance of 50cm were presented against a neutral mid-grey background with a black outline of 1 pixel. The 600 test stimuli of the colour naming experiment were selected from the Munsell Renotation Data. Colours were specified in the sRGB standard colour space of the Internet and out of gamut colours were removed. Participation was voluntary and anonymous. For this study, we used a refined dataset from 330 English speaking observers with a normal colour vision producing 5428 responses, see Mylonas and MacDonald (2016). For each BCT responded by the observers of the experiment, we computed the empirical arithmetic mean and variance-covariance matrix in CIELAB assuming D65 illuminant. These Gaussian distributions for each BCT can be used to assign automatically a BCT to spot measurements and or image regions of artworks in CIELAB. Lighting conditions as close as possible to the standard one, which is called D65, theoretically 40 cm from the MS placed horizontally<sup>5</sup>. Average midday light in Western Europe corresponds roughly to D65.

**#3. Ascription of the BCT corresponding to the colour name:** this may be made by using Kerttula's *English colour terms* (2002), which gives a large set of related colour terms for each BCT.

**#4. A codebook for treating data.** The smallest unit of the analytical work is the stained spot(*i*), namely its analytical features consisting of four sets of pieces of information, which are collected in a vector i.e.:i) The cultural institution, the MS and its production. ii) The co-ordinates and features of the spot(*i*). iii) Spectrographic data. iv) Invasive analysis: in some cases, it is possible to find detached fragments of painting in the gutter of a book, which cannot be repositioned, and the fragments can be subjected to micro-invasive analysis with powerful techniques such as HPLC-MS or Raman-SERS, in order to have more accurate information on the colourants.

**#5. Increasing number of records involve a SPSS type application.** The main problem of using an applicative of SPSS type is that the list of colourant classes must be clearly defined and closed before entering the records, and must be open to accept analytical results with greater or lesser accuracy. For example, an analyst may not be able to distinguish whether a given red lake is of animal or vegetal origin. In this latter case the applicative should contain a poor but still useful class named 'red lac',

---

<sup>4</sup> Designed by Mylonas and MacDonald (2016), it is available at <https://colournaming.org>.

<sup>5</sup> <https://web.archive.org/web/20171204115107/http://www.cie.co.at/publ/abst/s005.html> (retrieved 2021, July 6th).

together with the classes 'red lac of vegetal origin', 'red lac of animal origin', and the most precise class, for example red lac from *Kerria lacca* (Kerr). Another example, even more common, is the classification of pigments containing iron oxides. There are a lot of pigments in which the chromophore system is due to hematite ( $\text{Fe}_2\text{O}_3$ ) or goethite ( $\text{FeO}\cdot\text{OH}$ ). As far as non-invasive techniques are concerned, it is not possible to go beyond the identification of hematite-containing and goethite containing pigment. In the end, the classification of such pigments could limit to more generic terms such as "hematite-containing" or "red iron oxide pigment" and "goethite-containing" or "yellow iron oxide pigment".

**#6. Diversity between two MS or collections of MSS.** The notion of diversity is used across a big number disparate discipline: the present work aims to compare two sets of colourants used in two collections of MSS. Two different kinds of comparison can be made: the first concerns the presence/absence data, whereas in the second case one considers the relative abundances of the colourants. A legion of diversity indices had been proposed by the literature, see Schroeder and Jenkins (2018). In the present paper we use the simple diversity index DI (usually called segregation index in the literature), which is used in social sciences since the 1950s, see Duncan and Duncan (1955). Let us consider, for example, the two vectors of Table 1, the DI is simply half of the summation of the absolute differences of the pairs of cells of the two vectors, namely  $0.5\sum |a_i - b_i| = 0.52$ .

**#7. The features of a photometric procedure for automatic BCTs scanning.** Given a generic miniature, the application aims to evaluate for each BCT the portion of the coloured surface, and therefore the BCTs distribution of the illumination. The procedure requires to:

i) choose a colour space (e.g., CIELAB), and its related metric, which defines a distance operator  $d(\mathbf{x}_i, \mathbf{x}_j)$  between two colour vectors  $\mathbf{x}_i$  and  $\mathbf{x}_j$ . The choice of colour space  $\mathcal{S}$  and distance operator  $d$  influences the properties of the subsequent clustering algorithm.

ii) Define the eleven centroids  $\mathbf{x}_0$  to  $\mathbf{x}_{11}$ , one for each of the 11 BCTs through the crowdsourcing experimental procedure mentioned in #2.

iii) Define either one distance threshold  $K$  or one distance threshold  $K_i$  for each colour centroid  $\mathbf{x}_i$ . informed by the covariance matrix of each BCT as determined in step #2. The threshold(s) will be used to assign all vectors within a hypersphere centred around each centroid to that specific colour. A candidate vector  $\mathbf{x}$  will be assigned to the colour  $i$  if and only if  $d(\mathbf{x}, \mathbf{x}_i) < K_i$ . A colour vector which is not close enough to any of the centroid will be assigned to a null-class.

iv) An algorithm is needed, once the thresholds are set, for scanning the illuminations and classify the colours according to the metric and thresholds.

Further, histograms of the colours distribution for the whole surface can be generated for each MS and aggregated appropriately, and the program should compute the BCT average values of the coloured area of two generic collections of MSS given the distribution of the BCTs and the area examined of each single MS.

N.B.: The parameters  $K_i$  can be learned by applying a supervised learning algorithm to a labelled colour dataset, if this is obtainable with reasonable effort. In alternative, expert knowledge can be used to set the thresholds Note that the procedure described above requires an appropriate colorimetric calibration procedure in order to be reproducible across acquisition devices and samples.

## REFERENCES

Berlin, B., and P. Kay. 1969. *Basic Color Terms: Their Universality and Evolution*. Berkeley and Los Angeles: University of California Press.

- Chazdon R. L., R. K. Colwell, J. S. Denslow, and M. R. Guariguata. 1998. Statistical methods for estimating species richness of woody regeneration in primary and secondary rain forests of North-eastern Costa Rica. In: *Forest biodiversity research, monitoring and modelling: conceptual background and old world case studies*, F. Dallmeier, J.A. Comiskey (eds). Paris: UNESCO, New York: Parthenon, 285-309.
- Duncan, O. D., and B. Duncan. 1955. Methodological Analysis of Segregation Indexes. *American Sociological Review* 20, 2: 210-217.
- Kerttula, S. 2002. *English colour terms: etymology, chronology, and relative basicness*. Helsinki: Société Néophilologique.
- Magurran, E. A. 2004. *Measuring biological diversity*. Malden (MA): Blackwell Publishing
- McGill, J. B. 2011. Species abundance distributions. In: *Biological diversity: frontiers in measurement and assessment*, A E. Magurran, and J. B. McGill (eds.). Oxford, New York: Oxford University Press, 105-122.
- Mylonas, D., and L. MacDonald. 2016. Augmenting Basic Colour Terms in English. *Color research and application* 41, 1: 32-42.
- Schroeder, P. J., and G. D. Jenkins. 2018. How robust are popular beta diversity indices to sampling error? *Ecosphere* 9, 2: e02100. doi:10.1002/ecs2.2100.

# Color, landscape and cultural heritage. The case of the Pitillal River, in Puerto Vallarta, Jalisco, México

Jimena Vanina Odetti <sup>1,\*</sup> and Alberto Reyes González <sup>2</sup>

<sup>1</sup> Instituto Tecnológico José Mario Molina Pasquel y Henríquez, Campus Puerto Vallarta;  
jimena.odetti@vallarta.tecmm.edu.mx

<sup>2</sup> Instituto Tecnológico José Mario Molina Pasquel y Henríquez, Campus Puerto Vallarta;  
alberto.reyes@vallarta.tecmm.edu.mx

\* Corresponding author: jimena.odetti@vallarta.tecmm.edu.mx

## Abstract

A study on the Pitillal River in Puerto Vallarta is presented, from the chromatic study of its biodiversity, architecture and urban development. The objective is to make an analysis of the construction of a joint memory between color and the river as cultural heritage. The relationships built with the river, biodiversity and the colors that are characterized in their context are identified. With a qualitative research methodology, we start from the visual and ethnographic study of the river, its colors and its context; heritage is pointed out as a tool to revalue identities. As work areas, two polygons were established. The first, in its eastern position in the high mountain area, where there is a relationship with the community of origin. The second polygon is in the western part, where the river meets the sea, the most visible area when it is in front of the framework of the tourist structure, generating relationships and occupations of the territory with new tourist scenography's.

**Keywords:** *Color and Landscape, River, Territorial Identities, Color and Biodiversity.*

## INTRODUCTION

The coastal tourist cities in Mexico are the result of the neoliberal in the 70s, for the implementation of tourist activity as a strategy for the economic development of the Mexican state; this led to the generation of strategic projects such as CIP's 2 (Integrally Planned Centers) Cancun, Huatulco, Ixtapa, Loreto, Los Cabos. At the same time, activity was generated in territories that, despite not having the support structure of the National Tourism Fund, FONATUR, of the federal government, developed tourist activity as their main economic activity, as is the case of Puerto Vallarta.

Puerto Vallarta is the second beach resort in Mexico. Its history references three stages; the first with its relationship as a small-scale port to support the mining towns that are in the mountains that surround the Bahía de Banderas, where the city is located. The second stage referring to an agricultural production process promoted by the establishment of the Montgomery Fruit Company which was interrupted after the Mexican revolution and the establishment of the territories in the bay. The third stage refers to the establishment of the tourist activity originated, by the media exposure of the people in the production of the film *The Night of the Iguana*, an adaptation of the novel by Tennessee Williams by John Huston, which generated the establishment of temporary residencies by figures of American cinema such as Elizabeth Taylor and Richard Burton.

From this new visibility of the territory, investment was generated in different urban facilities and infrastructures, by the state and private initiative. Examples include the port terminal, the bus station and the Puerto Vallarta international airport. It should be noted the differentiation that exists between Puerto Vallarta and the CIPs in its positioning within beach destinations, since its historical process differs from a master plan planned by the Mexican state.

## **JUSTIFICATION**

Heritage in tourist territories faces the uses determined by the business sector and the imagery built of beach life, migratory processes have brought different social practices, of which heritage has generated and joint construction, the mountain relationship, river and sea.

The river has been, for the local population, a meeting and interaction space where rest, sports, and productive activities happen randomly, such as fishing. The physiognomy of the rivers that cross the urban area of Puerto Vallarta, provide users with shade from the vegetation cover provided by the trees in their channel, sheltering the aforementioned activities.

For the development of this chapter, two lines of analysis were proposed, the first is a review of the state of the art on the current production of the theme landscape and color; this review was generated with specialized literature on JCR from 2000 to 2020, generating a bibliometric analysis, to recognize the variables that define the literature consulted. The second moment focuses on the definition of the subject of study, the Pitillal River in Puerto Vallarta, and its historical process, relationships from society with social practices by locals and tourists, and the change that color presents with urban development.

As part of this definition of the study subject, two work polygons were determined. One in the mountain area to the east of the city, where the settlement of the local population is identified, and within which cultural practices and appropriation of space take place of the riverbed, related to the architecture of peri-urban environments, characterized by low-scale single-family housing, in self-construction processes, with backyard animals.

In this regard, Bengoa (2001) points out that the processes of anthropization of a territory necessarily develop over time, and that this temporal course generates different stages of domination and interrelation between society and nature, which acts as a support for human activities, constituting a dynamic process of changes in the functions of the peri-urban.

For the second polygon, the lowest point of the river was determined, where it meets the sea in its western position with respect to the layout of the city, where we find architectural elements, typical of tourist equipment, with different languages, mainly postmodern architecture, treating to integrate eclectic stylistic elements.

## **METHODOLOGY**

Through a qualitative research methodology, we start from the visual and ethnographic study of the river, its colors, and its environmental context. As work areas, two polygons were established at opposite points of the riverbed. The first in its eastern position in the high mountain area, where there is a relationship with the community of origin, the second polygon is in the western part, where it finds the river with the sea, the most visible area when facing the framework of the tourist structure, generating relationships and occupations of the territory with new tourist scenography.

To analyze the color palettes of both polygons, as a first step an analysis of aerial photographs were generated in two temporal cuts, to identify the vegetation and the predominant colors in the urban context, within the selected polygons. Then photographs were taken in the field, of the facades within these polygons and photographic urban images were built that served to select those predominant colors from the natural context of the river to the colors of the built architecture.

For a first stage of the project, chromatic scales are obtained that are the instrument to begin to analyze the relationship of natural color, with the built color, changes in the environment, vegetation and the relationship between the inhabitants with their chromatic context..

Color, landscape and cultural heritage. The case of the Pitillal river, in Puerto Vallarta, Jalisco, México

As conceptual axes to organize the study, we started from the context of the beach tourist territory of the City of Puerto Vallarta, to propose the concept of heritage, built by the action and perception of the inhabitants and tourists, from the daily practice of space, the choice and transformation of the colors of the peri-urban context and the context of the tourist area. Which define the study areas, giving rise to the construction of imaginaries based on experience, in the two studied areas: the river, the streams and the beach with the coastal limits.

## RESULTS

From the selection of the two study polygons on the river sides, one in the eastern zone (Peri-urban) and the second in the west (Tourist), the comparative analysis of aerial images was carried out, at different times, specifying the years , where the two work areas were selected to identify the colors that make up the area surrounding the Pitillal River, characterized by gallery vegetation.

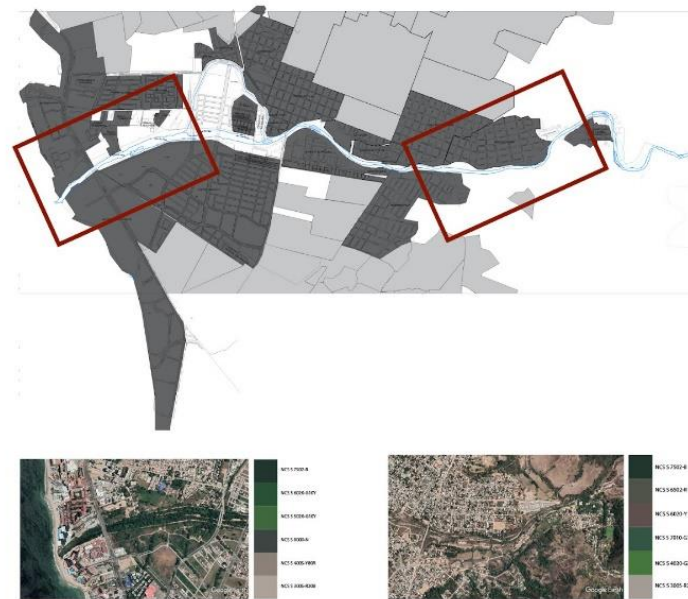

Figure 1: Study areas, tourist area polygon and Peri-urban polygon.



Figure 2: Aerial image with color scales.

Color, landscape and cultural heritage. The case of the Pitillal river, in Puerto Vallarta, Jalisco, México

In this step of the project, photographic urban images were selected from both study areas and the color scales of the facades and context vegetation were analyzed. The colors of the predominant chromatic scales were identified with the Natural Color System (color ordering system), to be able to compare and study the color choices that are made on the facades of the tourist strip and the facades of the peri-urban area.

Between both cases, we can observe different chromatic decisions. In the case of the area near the beach, which belongs to the tourist strip, where the river meets the sea, a limited color scale is observed, in which the warm neutral colors, which are those chosen by hotel chains and shopping malls that are located on one side of the river and facing the sea. Along with warm neutral tones with a predominance of ochre, mostly grayish neutral tones are accompanied by accents established by blue tones of the crystals. The green tones identified correspond to the vegetation of the context.

In the case of the peri-urban area, these chromatic scales begin to establish certain contrasts. Both in saturation with the choice of colors with more saturated tones between reddish and blue, and other completely neutral scales that present a range of earth tones, related to the colors of the construction materials, many of them unfinished, and of the streets not yet finished or paved. Again and to a lesser extent, the context vegetation gives the greens.



Figure 3: Images and chromatic scales of the Tourist Zone.





Figure 4: Images and chromatic scales of the peri-urbane zone.

## DISCUSSION

One of the first to be analyzed has been the relationship between the presence of vegetation in areas of high added value and how the natural resource of the beach generates a greater visibility and presence of green spaces, denser and more complex. The marginalized areas far from the tourist area, on the other hand, show a loss of vegetation. The appearance of new colors can be observed, from the elimination of the vegetative layer, observing the presence of the color of the substrate, brown and gray tones with the presence of concrete and related materials.

In this sense, beginning to observe the chromatic relationships between architecture and its natural context, has allowed us to see how they are differentiating in these two areas. While in the area of high added value we identify facade elements with neutral colors, when compared with the aerial image we can see a greater diversity of green tones, which are characterized by conservation and even processes of urban nature. In the case of the peri-urban polygon, the color in other tones is present both in facades and in its aerial image, evidencing a loss over time of the vegetative cover.

It can also be noted how the color choices made by hotel chains do not precisely have a relationship of cultural identity with the port and / or with the context of the river.

In contrast, free choices of colors can be noted on peri-urban facades that respond to the personal tastes of the inhabitants, to cultural values related to their places of origin and to the relationship with the materials and the geographic and natural context of the river.

## CONCLUSIONS

One of the objectives of this first stage of the project has been to study architecture, color and the environmental context, obtaining as first conclusions how they are related to cultural practices and processes, where economic dynamics seem to trace conservation routes for the pre-existing landscape to urbanization.



As well as in the tourist territory, there is a wide range of scenery and conservation of natural resources that benefit tourism. In contrast to the places where city workers live, especially in the peri-urban, which expands deforesting and placing new architectures, which do not incorporate chromatic elements that generate harmonies. However, if they present chromatic decisions, materials, expressing freedom of choice and generating chromatic elements related to cultural identity.

It is important to point out how the study of color can open doors to analyze processes of environmental, urban, and architectural changes and relate them to cultural practices and processes that show the different dynamics that occur around the landscape and the construction of the cultural heritage of a tourist city.

## **REFERENCES**

- Bengoa, G. 2001. Evolución histórica del periurbano marplatense. En *Donde muere la ciudad*, pp. 21-48, Héctor Echechuri, (compiler). Mar del Plata: Centro de Investigaciones Ambientales, FAUD, UNMdP.
- Caivano, J. L. 1995. *Sistemas de orden de color*. Serie Difusión(12).
- Chinyele, B. J., and N.B. Lwoga. 2019. Participation in decision making regarding the conservation of heritage resources and conservation attitudes in Kilwa Kisiwani, Tanzania. *Journal of Cultural Heritage Management and Sustainable Development*, 9(2), 184–198. <https://doi.org/10.1108/JCHMSD-05-2017-0019>
- Dragouni, M., K. Fouseki, and N. Georgantzis. 2018. Community participation in heritage tourism planning: is it too much to ask? *Journal of Sustainable Tourism*, 26(5), 759–781. <https://doi.org/10.1080/09669582.2017.1404606>
- Gnemmi, H. 1983. *Puntos de Vista sobre la conservación del patrimonio arquitectónico y urbano*. Cordoba Argentina: Ediciones EUDECOR.
- Lombardi, R., J. C., and G. C. 2015. *Color y territorio urbano: metodologías de abordaje y caso de estudio*. Color y material en la arquitectura de Buenos Aires. XXIX Jornadas de Investigación. FADU. UBA. (págs. 10-25). Buenos Aires.: FADU.UBA
- Navarrete Escobedo, D., and Navarrete Escobedo, D. 2017. Turismo gentrificador en ciudades patrimoniales. Exclusión y transformaciones urbano-arquitectónicas del patrimonio en Guanajuato, México. *Revista INVI*, 32(89), 61–83. <https://doi.org/10.4067/S0718-83582017000100061>

# LED-based versus Filter-based Multispectral Imaging Methods for Museum Studio Photography

Olivia Kuzio<sup>1</sup> and Susan Farnand<sup>1,\*</sup>

<sup>1</sup> Rochester Institute of Technology; ok9617@rit.edu, susan.farnand@rit.edu

\* Corresponding author: susan.farnand@rit.edu

## Abstract

Two practical methods for implementing multispectral imaging within the framework of museum studio photography were investigated. Imaging was carried out using a consumer RGB digital camera paired with either 1) colored glass filters and a broadband source or 2) optimized multiband LED illumination, yielding five or six spectral image bands, respectively. Color targets were used to develop and verify profiles for transforming between the multiband camera signals and final color managed images. The filter-based and LED-based profiles were assessed quantitatively for color accuracy using color difference statistics, and several paintings were imaged and rendered using the profiles as visual demonstration of the differences. While both were superior to conventional RGB imaging, the LED-based method outperformed the filter-based method for accurate reproduction of independent data. This supplements practicality and cost considerations that are informing the development of accessible multispectral imaging strategies for highly color accurate museum studio photography.

**Keywords:** *multispectral imaging, LEDs, filters, cultural heritage*

## INTRODUCTION

Spectral imaging has become a familiar technique for scientific examination of cultural heritage materials, popular for the material characterization and mapping capabilities it provides (Gabrieli et al. 2019; Delaney et al. 2016). Because it is closely associated with scientific studies, a key advantage of spectral imaging beyond its technical capabilities is often overlooked: the superior color reproduction it affords over conventional RGB imaging (Hill 2007), which is a largely untapped asset for color critical collections photography, digital and print reproduction, and conservation documentation. Furthermore, its introduction to this field as a laboratory analysis has led to the assumption that spectral imaging can only be carried out using specialized instruments and processing. To address these concerns, the case study presented here demonstrates that spectral imaging for highly accurate color reproduction can be carried out using equipment and capture methods practical for routine museum studio photography.

Spectral imaging involves subdividing the wavelength range of interest into small sections and capturing an image in each. In a traditional approach, a monochrome sensor and optimized filter set are used to achieve the desired wavelength sampling (Berns 2018, 2019). As they have become more mainstream, narrowband LEDs paired with a monochrome sensor have also been used to sample the spectrum (Paray 2020). Other spectral imaging approaches rely on the inherent three-channel nature of the color filter array in RGB cameras to collect the desired multiplicity of channels (Berns et al. 2005; Shrestha and Hardeberg 2015, 2018). When strategically paired with a set of two or three filters or lights, the camera's spectral sensitivity can be manipulated to afford six or more channels. The desire to utilize low barrier-to-entry tools for the current research has led to interest in leveraging this approach, especially considering previous work that showed a significant improvement in color accuracy can be obtained by color profiling based on as few as six spectral channels versus the three channels of conventional RGB imaging (Kuzio and Farnand 2021). In this work, six spectral channels were acquired by differently filtering or illuminating two RGB images, which were combined to create six band multispectral image sets, and processed to afford highly accurate color managed images.

Neither filter-based nor illumination-based methods are a perfect spectral imaging solution. Filters can be paired with existing studio lighting, but are damage-prone, and gather dust and fingerprints. They either need to be manually changed between captures or moved using bulky filter wheels/sliders with delicate mechanics. Small physical shifts that occur during filter changes and/or varying optical properties between filters often necessitate image registration during processing. However, filters are both the more familiar and less expensive option. On the other hand, multichannel LED lighting systems typically used for spectral imaging offer extended flexibility for their investment. Many can be controlled programmatically, enabling the development of automated capture routines, and a single system can be used to make many illuminants by tuning the channels match a desired spectral profile. Thus, a single LED system could be used for many of an imaging studio's lighting needs.

To supplement these practical considerations, this work is a case study comparing the relative color rendering accuracy of filter-based versus LED-based multispectral capture strategies. Both methods were used to collect multispectral image sets of color targets and paintings. Color transformation profiles were developed based on one of the targets and used to render color-managed images of the paintings. The colorimetric accuracy of the two methods was evaluated using color difference statistics relative to the measured values of both the calibration and the independent targets, and supplemented with a visual comparison of the rendered images of the paintings. Together with practical considerations, relative color quality is a factor affecting method viability within the framework of a comprehensive multispectral imaging strategy for museum photography.

## **METHODS**

### **Equipment and Software**

A commercially available 42 MP Sony  $\alpha$ 7R III mirrorless digital camera equipped with a Sony FE 90 mm f/2.8 macro lens was used for imaging. The particular camera used has had its internal IR filter removed, extending its sensitivity to longer wavelengths, as illustrated in the plot of the camera's sensitivity in Figure 1. Note that its color filter array was not modified, and its three-channel sensitivity remains. The camera was controlled remotely using Imaging Edge (Sony), and RawDigger Profile Edition (LibRaw) and MATLAB (Mathworks) were used for image inspection and processing.

Two screw-on colored glass filters with the spectral transmittance profiles plotted in Figure 1 were used for the filter-based method. The cyan and yellow filters were chosen to mimic the selections described by Berns for "dual-RGB imaging" (Berns et al. 2005; Berns 2016). The illumination paired with the filters was a set of 5900 K Broncolor Pulso G studio strobes equipped parabolic reflectors.

The LED-based method utilized illumination by a set of LED light sources (LEDMotive). Each light contained ten LED color channels with the spectral radiance distributions plotted in Figure 1. The particular LEDs in this set were originally optimized for high colorimetric and spectral accuracy in cultural heritage imaging applications when used sequentially and paired with a monochrome camera (Paray 2020). Each light contains the LEDs within a small housing (16 x 12 x 12 cm) and is outfitted with a parabolic reflector to mimic studio lighting. The lights were controlled using  $\mu$ Wave (LEDMotive), which allowed independent control of each LED channel.

Two color targets were used to calibrate the color transformation profiles and verify their colorimetric accuracy. The calibration target was the Next Generation Target V2 (Avian Rochester), originally designed for the Library of Congress, and the verification target was the Artist Paint Target (Image Science Associates), designed at Rochester Institute of Technology with real paint mixtures for evaluating the spectral estimation accuracy of spectral imaging systems (Berns 2014) (Figure 1).

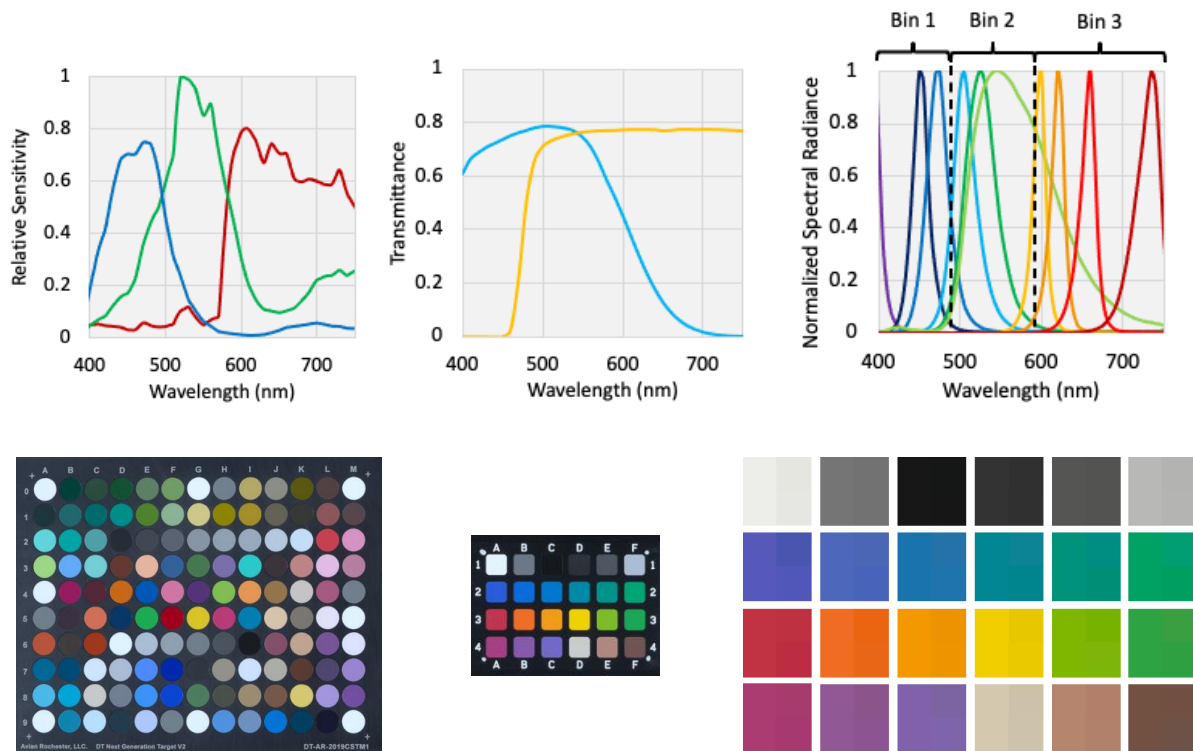

Figure 1: Top left: Red, green, and blue channel camera sensitivity (colored accordingly). Top center: Cyan and yellow filter spectral transmittance (colored accordingly). Top right: Spectral radiance of the 10 LEDs, with peak wavelengths of 395, 450, 475, 505, 525, 545, 600, 620, 660 and 735 nm. Bottom left: Next Generation Target V2, the color profile calibration target. Bottom center: Artist Paint Target, the color profile verification target. Bottom right: Simulated Artist Paint Target. Each patch shows the rendered color obtained from measurement (left half), filter-based imaging (top right quarter), and LED-based imaging (bottom right quarter).

## Spectral Band Selection

### *Filter-based Method*

The cyan and yellow filters modify the camera's spectral sensitivities to those plotted in Figure 2. Because the green channels are so similar, that of the yellow filter (dashed green line) was disregarded, and all image processing was carried out on the remaining five spectral bands.

### *LED-based Method*

From the overall set of ten LEDs in the lights, two combinations comprised of three LEDs each were optimized to provide the highest possible colorimetric accuracy when rendering from six bands captured between two images. The optimization procedure involved first binning the LEDs into three groups based on their peak wavelengths (Figure 1). There were 36 possible combinations of groups of three when one LED was chosen from each bin. The 630 possible pairs of these groups were then enumerated, and the corresponding spectral sensitivities were calculated. Finally, the theoretical colorimetric performance afforded by each pair was assessed by simulating its color rendering of the Next Generation Target. The optimal pair was deemed to be that which gave the lowest mean  $\Delta E_{00}$  with respect to the measured values of the target. The spectral sensitivities of this pair are plotted in Figure 2. The LED combinations that make up this pair are visually bluish and yellowish, respectively, and will be referred to as the blue light and yellow light.

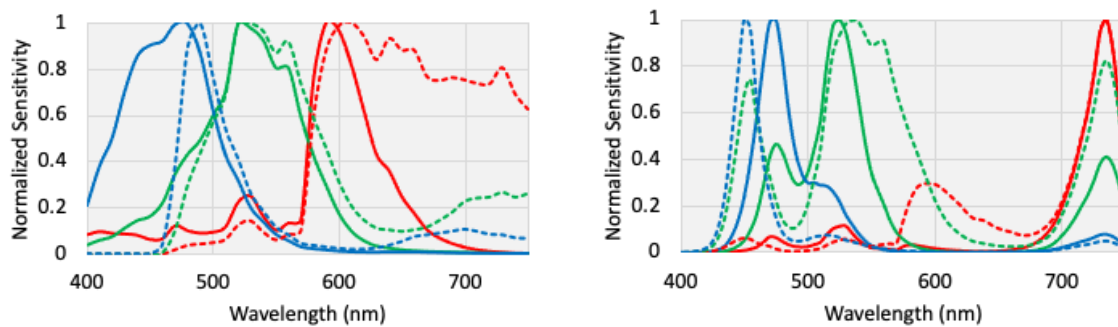

Figure 2: Left: Spectral sensitivities of the red, green, and blue camera channels (colored accordingly) given by the cyan (solid) and yellow (dashed) filters. The green channel of the yellow-filtered image (dashed green line) was disregarded. Right: Spectral sensitivities of the red, green, and blue camera channels (colored accordingly) given by the blue (solid) and yellow (dashed) lights. The blue light is a combination of the 475, 525, and 735 nm LEDs. The yellow light is a combination of the 450, 545, and 735 nm LEDs.

### Image Capture and Processing

A copy stand setup with typical camera/light  $0^\circ/45^\circ$  geometry was used for capture for both the filter-based and LED-based methods. Images of 1) color targets, 2) paintings, and 3) a flatfield were collected under the cyan and yellow filters (using strobe illumination), and the blue and yellow lights. The exposures used for each method were set by maximizing the digital counts in the camera channel with the highest signal, while allowing some headroom to avoid clipping.

All images were initially collected as 14-bit linear RAW ARQ files using Imaging Edge. Next, RawDigger was used to perform dark current subtraction, to inspect and extract the average digital counts for the color targets, and to export the images as TIFF files. Then, MATLAB was used to first scale the image data to 16-bits and to perform flatfielding to correct illumination nonuniformities in the images of the targets and paintings. Second, color profiles were developed for both imaging methods by optimizing the transformation between the average digital counts and the measured values of the calibration target to give the lowest mean  $\Delta E_{00}$ . These profiles were subsequently applied to the image sets of the paintings and used to render the final color managed images.

### RESULTS AND DISCUSSION

Statistics summarizing the color difference values obtained for the calibration and verification targets are given in Table 1. Differences in color accuracy between the target used for calibrating (Next Generation Target) versus verifying (Artist Paint Target) the color profiles are expected, as the profile will better estimate the values of the target used to build it. The verification target color difference data are a better assessment of each method's independent performance, and there is a clear difference in the color accuracy obtained for the verification target between the filter-based and LED-based methods. While both methods obtain mean  $\Delta E_{00}$  values below the perceptible limit of color differences in digital images of about  $2 \Delta E_{00}$ , the 90<sup>th</sup> percentile and maximum values for the filter-based method fall above this threshold (Stokes, Fairchild, and Berns 1992). This indicates that some colors in independent data will be reproduced with a noticeable difference with respect to the original colors. Figure 1 illustrates this in a visualization of the Artist Paint Target that compares the measured colors versus the colors as reproduced by each method. Despite the superiority of the LED-based

method, note that the particular advantage of using either of the multispectral imaging methods over conventional color imaging is illustrated by their performance relative to that of color-managed RGB imaging of the same verification target (Table 1, final column).

Target	$\Delta E_{00}$ Value	Filter-based	LED-based	RGB
Next Generation Target (Calibration)	Mean	0.9	0.5	1.0
	90 <sup>th</sup> percentile	1.8	0.8	1.8
	Maximum	4.4	2.0	4.6
Artist Paint Target (Verification)	Mean	1.9	1.3	6.8
	90 <sup>th</sup> percentile	3.9	2.0	11.7
	Maximum	4.7	2.3	14.0

Table 1:  $\Delta E_{00}$  statistics for the calibration and verification targets according to imaging method.

As a further visual demonstration of the differences in color rendering between the filter-based and LED-based methods, images of two paintings that were captured and rendered accordingly are shown in Figure 3. Notable differences in rendering occur in saturation and hue shifts of reds, blues, and purples. This is likely due to the more narrowband nature of the short and long wavelength sensitivities of the LED-based method versus those of the filter-based method (Figure 2).

It should be noted that in the LED-based method, the degrees of freedom afforded by the ten channel lights enabled the collection of six unique spectral bands between the two captures, while the spectral bands afforded by the two selected filters were fixed, and gave two spectral bands with redundant sensitivity. A third filter could be added to provide additional bands to supplement the original five, but at the cost of extending capture and processing time. When using screw-on filters, as was done here, capture efficiency especially would be significantly impacted.

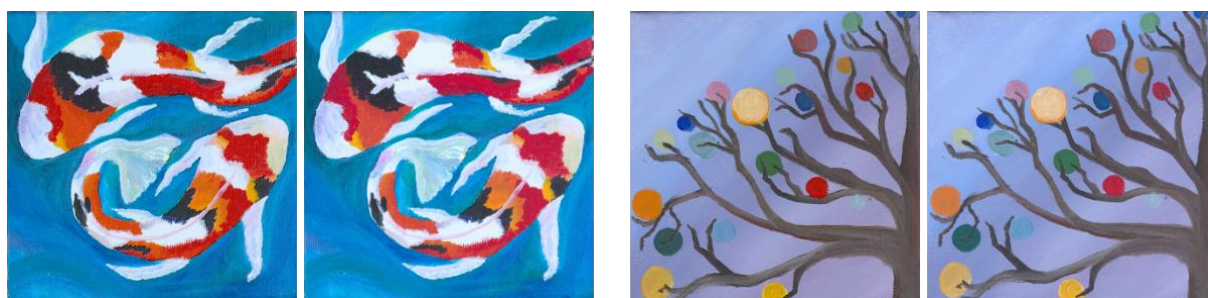

Figure 3: Two paintings as rendered by the profiled filter-based (left) and LED-based (right) methods.

## CONCLUSION

The colorimetric accuracy of a simple filter-based and LED-based multispectral imaging method was compared, with the latter exhibiting higher color accuracy, likely due to the flexibility of the multichannel LED lights that allowed optimization of the spectral bands. However, both methods clearly outperformed conventional RGB imaging when considering independent data. These results illustrate color quality considerations to weigh alongside the practical merits of different methods proposed for establishing routine multispectral imaging within the framework of museum studio photography.

**ACKNOWLEDGEMENTS**

This work was supported by a grant from The Andrew W. Mellon Foundation.

**REFERENCES**

- Berns, R. S. 2014. "Artist Paint Target (APT): A Tool for Verifying Camera Performance." Rochester Institute of Technology.
- . 2016. "Theory and Practice of Dual-RGB Imaging." Rochester Institute of Technology.
- . 2018. "Practical UV-VIS-NIR Multispectral Imaging." In *Archiving 2018 Final Program and Proceedings*, 47–52. Washington, DC.
- . 2019. "Digital Color Reconstructions of Cultural Heritage Using Color-Managed Imaging and Small-Aperture Spectrophotometry." *Color Research and Application* 44 (4): 531–46.
- Berns, R. S., L. A. Taplin, M. Nezamabadi, M. Mohammadi, and Y. Zhao. 2005. "Spectral Imaging Using a Commercial Colour-Filter Array Digital Camera." In *The Fourteenth Triennial ICOM-CC Meeting*, 743–50.
- Delaney, J. K., M. Thoury, J. G. Zeibel, P. Ricciardi, K. M. Morales, and K. A. Dooley. 2016. "Visible and Infrared Imaging Spectroscopy of Paintings and Improved Reflectography." *Heritage Science* 4 (1): 1–10.
- Gabrieli, F., K. A. Dooley, M. Facini, and J. K. Delaney. 2019. "Near-UV to Mid-IR Reflectance Imaging Spectroscopy of Paintings on the Macroscale." *Science Advances* 5 (8): 1–10.
- Hill, B. 2007. "High Quality Color Image Reproduction: The Multispectral Solution." In: *9th International Symposium on Multispectral Colour Science*, 1–7.
- Kuzio, O, and S. Farnand. 2021. "Color Accuracy-Guided Data Reduction for Practical LED-Based Multispectral Imaging." In *Archiving 2021 Final Program and Proceedings*, 65–70.
- Paray, J. N. 2020. "LED Selection for Spectral (Multispectral) Imaging." Rochester Institute of Technology.
- Shrestha, R., and J. Y. Hardeberg. 2015. "An Experimental Study of Fast Multispectral Imaging Using LED Illumination and an RGB Camera." In *23rd Color and Imaging Conference Final Program and Proceedings*, 36–40.
- . 2018. "Assessment of Two Fast Multispectral Systems for Imaging of a Cultural Heritage Artifact - A Russian Icon." In: *Proceedings - 14th International Conference on Signal Image Technology and Internet-Based Systems*, 645–50.
- Stokes, M., M. D. Fairchild, and R. S. Berns. 1992. "Precision Requirements for Digital Color Reproduction." *ACM Transactions on Graphics* 11 (4): 406–22.

# A new target to test color accuracy in technical photography of fine arts

Eric Kirchner <sup>1,\*</sup>, Carola van Wijk <sup>2</sup>, Henni van Beek <sup>3</sup>, Tammo Koster <sup>4</sup> and Pim Koeckhoven <sup>5</sup>

<sup>1</sup> AkzoNobel Paints and Coatings, Color Technology, Rijksstraatweg 31, 2171 AJ Sassenheim, The Netherlands; eric.kirchner@akzonobel.com

<sup>2</sup> Rijksmuseum, Image Department, Museumstraat 1, P.O. Box 74888, 1070 DN Amsterdam, The Netherlands; c.van.wijk@rijksmuseum.nl

<sup>3</sup> Rijksmuseum, PK-online, Museumstraat 1, P.O. Box 74888, 1070 DN Amsterdam, The Netherlands; h.van.beek@rijksmuseum.nl

<sup>4</sup> AkzoNobel Paints and Coatings, Color Technology, Rijksstraatweg 31, 2171 AJ Sassenheim, The Netherlands; tammo.koster@akzonobel.com

<sup>5</sup> AkzoNobel Paints and Coatings, Color Technology, Rijksstraatweg 31, 2171 AJ Sassenheim, The Netherlands; pim.koeckhoven@akzonobel.com

\* Corresponding author: eric.kirchner@akzonobel.com

## Abstract

We created a new color target for camera profiling, consisting of 63 color patches. It was created in order to reduce problems that relate to the main bottlenecks when using the common color target for professional photography, the ColorChecker SG chart. Here, we investigate specifically the influence of glossiness and impastos.

Our results prove that spectrophotometer measurement data at 45/0 geometry is affected if the paint has impasto instead of being smooth (CIEDE2000 = 3). However, the effect from having a high-gloss or a matte varnish has a much stronger influence on measured reflectance data (CIEDE2000 = 18). For high-gloss varnishes, also the reproducibility of reflectance measurements becomes worse in the case of impasto paints (CIEDE2000 =  $2.0 \pm 2$ ), even if the paint sample is not rotated between measurements. Impasto paints make gloss measurements effectively useless, especially in the case of varnishes with high gloss.

**Keywords:** Cultural heritage, Digitization, Camera profiling, Color management

## INTRODUCTION

Many art collections were digitized and published online by the world's largest museums. Parallel to this, requirements for digital photography have become increasingly stricter. The two internationally recognized sets of guidelines for technical photography of museal fine arts (Metamorfoze and FADGI) result in a so-called camera profile for well-controlled lighting conditions, as detailed in FADGI (2010) and Dormolen (2012). This includes creating an accurate mathematical camera model that converts camera RGB values into CIE-Lab coordinates such that color differences between CIE-Lab values and corresponding spectrophotometer values are minimized.

In both guidelines this process is applied on a set of standardized color patches. Originally the MacBeth ColorChecker Rendition chart was used for this, based on work by McCamy et al. (1976) and using a more or less standardized process for professional photography as described in e.g. Rodney (2005). Currently, the most demanding professional photography often uses a descendant of this chart, which is called the ColorChecker SG chart, as described by supplier X-Rite (2020). It contains 140 color patches. The supplier of the chart made CIE-Lab data for all 140 patches available online, thus serving as generic ground truth data.

Recently in Kirchner et al. (2021) we showed that the main color deviations in this process originate from the darkest patches in the chart. We also found that variations in glossiness for the black patches on charts produced in different years contribute significantly to these errors when the generic ground



truth data is used. High accuracy digital photography was shown to be possible only when using spectrophotometer data on individual ColorChecker SG charts.

### **THE NEED FOR A NEW COLOR TARGET**

We continue this investigation by creating a new test object that is aimed to solve four more weak points in the current process, as listed below. The new test object is created with artist paints, in order to generate reflectance curves that are probably more similar to those of fine art objects than when using the printed inks and dyes that occur on the ColorChecker SG chart (cf. Mohammadi et al., 2005).

#### *The need for independent evaluation*

When building camera profiles, the same color targets are used for training the model and for evaluating its accuracy. In both cases, the X-Rite ColorChecker SG chart is used. It would be better to evaluate the performance on a different and independent set of data. Therefore, we created a new chart with a range of color patches independent of those on the ColorChecker SG chart.

#### *Better represent chromatic dark colors*

Since our analysis in Kirchner et al. (2021) showed that dark colors are the most critical when building a camera profile, we included very dark colors with different color hues. This is important especially since dark nuances are characteristic for 17th century Dutch paintings and other *claire-obscur* art works. The ColorChecker SG chart includes hardly any dark chromatic color patches.

#### *More relevant level of glossiness*

Our previous investigation showed that even small changes in glossiness in the color patches introduce color differences large enough to fail the strictest Metamorfoze and FADGI guidelines. Therefore, the new chart includes color patches from two different glossiness levels. Apart from including matte patches that are similar in glossiness to the patches in the ColorChecker SG chart we also include high-gloss patches with a gloss level similar to that of most paintings that are usually the objects of museal photography.

#### *Better represent surface roughness of paintings*

Rembrandt, Van Gogh and many other artists often applied *impastos* in their paintings: thick layers of paints creating dramatic visual effects. In photography *impastos* often lead to glossy reflections that distort the image. For museal photography polarization filters are often used to remove these glossy reflections, assuming that the color representation of other parts of the object are not affected by these filters.

When creating the new chart, we included color patches with strong *impasto*, while using the same paint material as used for the smooth color patches. In this way we will be able to quantify the influence of *impastos* on the color accuracy of the camera profile, both with and without using cross polarization filters.

### **EXPERIMENTAL**

The new color patches were created by mixing oil paints (Royal Talens, Van Gogh product line). In this way, we generate reflectance curves that are more representative of the reflectance curves found

A new target to test color accuracy in technical photography of fine arts on fine art than when using the color patches of the ColorChecker chart as test set, since X-Rite creates those based on inks.

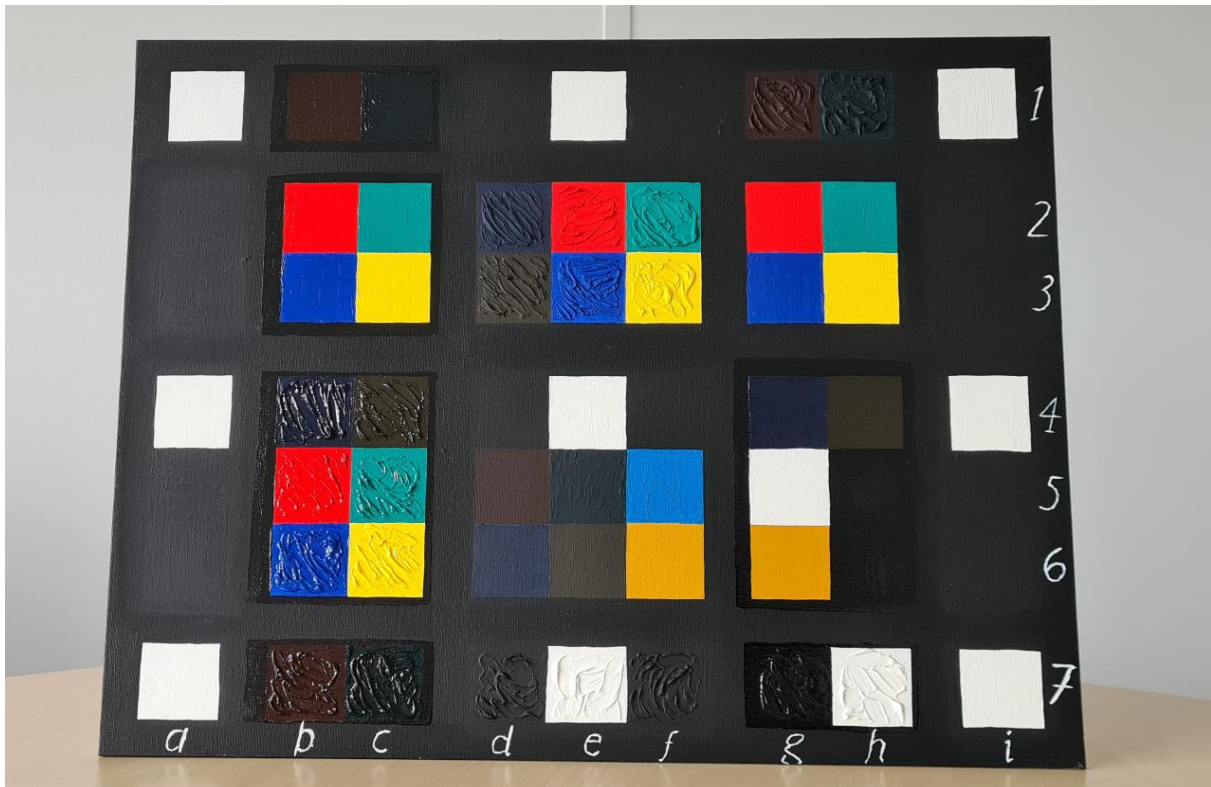

Figure 1: New color target, which allows evaluations independent of training set (ColorChecker SG), contains more chromatic dark colors, and validates camera profiles for art objects of various glossiness and smoothness (impastos).

The new color target contains 63 patches as shown in Figure 1. It contains 12 color patches that are smooth and high-gloss (patch B1-C3 and G4-H6), 10 color patches that are impasto and high-gloss (patch B4-C7, G7 and H7) and 11 color patches that are impasto and matte (patch D2-F3, D7-F7, G1 and H1). The other 30 patches are smooth and matte.



Figure 2: Part of the new color target, showing detailed view on color patches with identical paint material and color, while differing in smoothness (impasto).

Since in Kirchner et al. (2021) we found that very dark colors form the main bottleneck for camera profiling, we did not only represent bright versions of the main color categories red, yellow, blue and green (abbreviated here as R, Y, B and G and an alternative yellow Y2). We also included four different very dark ( $L^* < 30$ ) versions for these chromatic colors (abbreviated as DR, DY, DB and DG), as well as adding two separate pure black paints (ivory black K1 and lamp black K2) to represent different achromatic blacks. White was represented by Titanium white (abbreviated as W1).

The oil paints were applied with an artists' brush. We allowed them to dry for 10 months before applying high-gloss and matte varnishes.

We used a spectro2guide spectrophotometer (supplier: BYK-Gardner) to measure both reflectance in  $45^\circ/0^\circ$  geometry, gloss values at  $60^\circ$  and fluorescence on each of the 63 patches. Each patch was measured three times independently, and with different orientations of the spectrophotometer separated by  $90^\circ$  rotations.

Since some of the patches feature paint with impasto, we used an auxiliary plastic/foam ring on the spectro2guide in order to prevent ambient light to enter the measurement spot and to avoid instrument lighting to escape from the measurement spot. However, the height differences in the paint are up to a few millimeters, and we expect the ring to be not fully successful.

## RESULTS

For the measured reflectance values, Table 1 summarizes the color differences that we find due to variations in glossiness (high-gloss versus matte) and paint application (impasto versus smooth paint application).

Color	High-Gloss, smooth	Matt, impasto	High-gloss, impasto
W1	0.3	1.0	1.6
K1	11.3	0.7	8.5
K2	11.4	1.2	13.5
R	7.6	1.3	5.1
G	6.1	1.1	5.5
B	7.4	2.4	2.4
Y	1.4	1.9	1.6
Y2	4.1		
DR	11.3	2.9	1.0
DG	11.6	1.2	1.3
DB	10.8	1.5	2.1
DY	8.9	2.0	2.8

Table 1: Color difference CIEDE2000 as caused by differences in gloss (high-gloss versus matte) and differences in application (flat paint versus impasto). In all cases, flat matt paint surfaces are taken as the reference. Note that color Y2 was not applied for all gloss-application combinations, resulting in empty cells in the table.

These results show that the reflectance data are strongly influenced by glossiness and by impastos. Strong impastos lead to color variations up to CIEDE2000 = 3. The application of high-gloss varnishes creates color variations up to CIEDE2000 = 18 when comparing with exactly the same paints when applied matte.

Color differences of CIEDE2000 > 10 arise especially for the darkest colors when comparing high-gloss with matte patches. These color differences are still substantial for colors with higher lightness values, and only become almost negligible for white patches. For matt paints, comparing impasto with smooth paint surfaces leads to much smaller color differences (CIEDE2000 < 2). Glossy impasto paints differ considerably from matte smooth paints, but we find color differences that are much smaller for dark chromatic paints (CIEDE2000 < 2) than for dark achromatic paints (CIEDE2000 > 8).

Color	High-Gloss, smooth	Matt, impasto	High-gloss, impasto
W1	-0.4	-0.8	-2.2
K1	-17.5	-1.1	-13.0
K2	-17.7	-17.2	-21.4
R	-4.4	-1.1	-3.8
G	-5.6	-1.0	-5.9
B	-9.6	-2.9	-2.9
Y	-0.7	-2.4	-2.0
Y2	-3.1		
DR	-14.0	-3.5	-1.3
DG	-16.7	-1.7	0.2
DB	-14.8	-2.0	2.2
DY	-11.7	-2.6	-3.7

Table 2: Lightness differences  $\Delta L^*$  as caused by differences in gloss (high-gloss versus matte) and differences in application (flat paint versus impasto). In all cases, flat matt paint surfaces are taken as the reference, which in almost all cases have a higher lightness value, thus explaining the many negative entries in this table. Note that color Y2 was not applied for all gloss-application combinations, resulting in empty cells in the table.

Table 2 shows the contribution from lightness differences to color differences.

Not surprisingly, we find that reflectance measurements show poor reproducibility in the case of high-gloss impasto patches. Without rotating the samples, the reproducibility is CIEDE2000 =  $2.0 \pm 2$ , which is much larger than the corresponding values for impasto matte patches (CIEDE2000 =  $0.3 \pm 0.3$ ), smooth high-gloss (CIEDE2000 =  $0.2 \pm 0.1$ ) and smooth matte patches (CIEDE2000 =  $0.1 \pm 0.1$ ). If the spectrophotometer is rotated by 90° before taking the measurement, the reproducibility further deteriorates to CIEDE2000 =  $3.1 \pm 3$  for high-gloss impasto patches. We conclude that for high-gloss impasto patches it is beneficial to keep instrument orientation constant, but the resulting reproducibility is still bad.

For the measured gloss values, we find that for smooth patches, gloss values are  $1.4 \pm 0.9$  Gloss Units for matte and  $23.3 \pm 8$  Gloss Units for high-gloss patches. However, for impasto matte patches the value drops to  $0.3 \pm 0.3$  Gloss Units, showing that the uneven surface of impasto paint disturbs gloss measurement. For impasto high-gloss paints, the distortion of gloss measurement is much larger, and we now measure only  $2.7 \pm 3$  Gloss Units. This shows that for high-gloss impasto paints gloss measurements are useless.

For the fluorescence measurements, we find that several of the mixing paints show some fluorescence. For the white patches that were created by Titanium white paint, these may be due to optical brighteners used by the paint supplier to make the white paint brighter. For the blue paints (labeled as Cobalt blue and Phthalo blue) it is not clear if the fluorescence is caused by optical brighteners in these paints, or by a lack of paint opacity that makes optical brighteners in the substrate detectable.

## **CONCLUSIONS**

We have shown that reflectance measurements at 45/0 geometry from a spectrophotometer are influenced by impasto paints versus smooth paints (CIEDE2000 = 3), but that the effect from applying high-gloss varnish versus matte varnish is much stronger (CIEDE2000 = 18). We showed that the reproducibility of reflectance measurement is bad for high-gloss impasto paints (CIEDE2000 =  $2.0 \pm 2$ ), even when the sample is not rotated. Gloss measurements are also greatly affected, making gloss measurements effectively useless especially for high-gloss impasto paints.

## **REFERENCES**

- Dormolen, H. van. 2012. *Metamorfoze preservation imaging guidelines*. The Hague: National Library of the Netherlands.
- FADGI – US Federal Agencies Digitization Guidelines Initiative, Still Image working group. 2010 and 2016. *Technical guidelines for digitizing cultural heritage materials*. Washington: The Library of Congress.
- Kirchner, E., C. van Wijk, H. van Beek and T. Koster. 2021. Exploring the limits of color accuracy in technical photography. *Heritage Science* 9(57): 1-13.
- McCamy, C. S., H. Marcus, J. G. Davidson. 1976. A color rendition chart. *Journal of Applied Photography and Engineering* 2: 95-99.
- Mohammadi, M., M. Nezamabadi, R.S. Berns and L. A. Taplin. 2005. A prototype calibration target for spectral imaging. In: *Proceedings of the AIC 10th Congress of the International Colour Association*, 387-390.
- Rodney, A. 2005. *Color management for photographers: hands on techniques for Photoshop users*. Amsterdam: Elsevier.
- X-Rite. 2020. Color Checker Digital SG. Online: <https://xritephoto.com/camerasolutions>. Accessed 17 June 2021.

# Hyperspectral mapping (VIS-SWIR) of materials of three 18<sup>th</sup> C. tapestries of Royal Manufactures in France (Gobelins, Beauvais, Aubusson)

Hortense de La Codre <sup>1,3</sup>, Charlotte Marembert <sup>2</sup>, Rémy Chapoulie <sup>1</sup>, Laurent Servant <sup>3</sup> and Aurélie Mounier <sup>1</sup>

<sup>1</sup> IRAMAT-CRPAA (UMR 5060 CNRS / Université Bordeaux Montaigne), Institut de Recherche sur les ArchéoMATériaux, Centre de Recherche en Physique Appliquée à l'Archéologie, Maison de l'Archéologie, 33 607 Pessac – France; hortense.de-la-codre@u-bordeaux-montaigne.fr, chapouli@u-bordeaux-montaigne.fr, aurelie.mounier@u-bordeaux-montaigne.fr

<sup>2</sup> Atelier de teinture Myrobolan, Bruxelles – Belgique; myrobolan@mail.com

<sup>3</sup> Institut des Sciences Moléculaires (UMR 5255 CNRS/Université de Bordeaux) 33405 Talence – France; laurent.servant@u-bordeaux.fr

\* Corresponding author: hortense.de-la-codre@u-bordeaux-montaigne.fr

## Abstract

At the end of the 17<sup>th</sup> century, and following a reorganisation by Colbert, the Aubusson, Gobelins and Beauvais French Manufactures obtained the title of Royal Tapestry Manufacture. This title gave rise to the establishment of numerous rules concerning the quality of the materials used in the works produced. A control of the said quality exercised by inspectors of the Crown and renowned board painters sent to work in the Manufactures, leading to the birth of the “Grand Teint” Tapestries (Bertrand 2013). This study therefore proposes to compare the materials used in the three Manufactures through three tapestries dating from the mid-18<sup>th</sup> century, each coming from one of the Royal Manufactures. The power of hyperspectral imaging (in the visible and near infrared ranges) and the treatment's robustness of the data are exploiting and discussed to map the materials (textiles and dyes).

To enable the study of these high quality tapestries, a colour chart of more than 600 references based on recipes from 18<sup>th</sup> century treatises (Hellot 1750; Macquer 1761; Cardon 2003) was created, thanks to a collaboration with the Myrobolan dyeing workshop (Brussels). The reference spectra (mainly reflectance or fluorescence) of these samples were then recorded with several non-invasive analysis methods (HSI-VIS-NIR, FORS, LED $\mu$ SF...) creating a database that will finally be compared to the spectra recorded on the tapestries studied, thus allowing the identification of the materials used at the time (Mounier et al. 2014; Daniel et al. 2016; Delaney et al. 2016). The amount of radiation sent to the work during the HSI analyses are controlled and measured as 55 lux per hours.

In order to allow the identification of the materials used, different classification techniques based on the database have been tested and optimized to obtain material maps (Spectral Angle Mapper, Extraction of endmembers...). On the tapestries studied, the analyses revealed, for example, differences in the use of textiles between the Manufactures. For example, the Gobelins used more silk than wool comparing to Aubusson. Also, dyes were not fixed on same fibre type. Indigo is dyed mostly on silk in the Gobelin tapestry whereas it is fixed on wool at Aubusson. Thanks to the mapping classification, many differences have been noticed.

Finally, the characterization and the mapping of the materials allowed a discussion on the technical and aesthetic choices of the Manufactures and also to place them in a French and European context. The price, the provenance, the ease of supply or the commissioner could explain some material choices.

**Keywords:** Tapestry, Dyes, Hyperspectral imaging (HSI), Visible & Infrared reflectance spectroscopies, French manufactures

## REFERENCES

- Bertrand, P. 2013. *Aubusson, tapisseries des lumières: splendeurs de la manufacture royale, fournisseur de l'Europe au XVIIIe siècle*. Snoeck.
- Cardon, D. 2003. *Le monde des teintures naturelles*. Belin.
- Daniel, F., A. Mounier, J. Pérez-Arantegui et al. 2016. Hyperspectral imaging applied to the analysis of Goya paintings in the Museum of Zaragoza (Spain). *Microchemical Journal* 126: 113-120. doi:10.1016/j.microc.2015.11.044
- Delaney, J. K., P. Ricciardi, and L. Glinsman. 2016. Use of Near Infrared Reflectance Imaging Spectroscopy to Map Wool and Silk Fibres in Historic Tapestries. *Anal Methods* 8: 7886-7890. doi:10.1039/C6AY02066F
- Hellot, J. 1750. *L'art de la teinture des laines et des étoffes de laine en grand et petit teint, avec une instruction sur les déboüillis*. Vve Pissot.
- Macquer, P.-J. 1761. *Art de La Teinture En Soie*. Desaint.
- Mounier, A., G. Le Bourdon, C. Aupetit, et al. 2014. Hyperspectral imaging, spectrofluorimetry, FORS and XRF for the non-invasive study of medieval miniatures materials. *herit sci.* 2(1): 24. doi:10.1186/s40494-014-0024-z

# The NCS color notation as a guide to produce colors from traditional pigments in conservation: The case study of two painted ceilings from eighteenth-Century Churches in colonial Brasil

Márcia Hazin <sup>1,\*</sup> and João Pernão <sup>2</sup>

<sup>1</sup> Architect, M.Sc . Faculdade de Arquitetura-Universidade de Lisboa ; marhazin@gmail.com

<sup>2</sup> Architect, M.Sc, PhD. Faculdade de Arquitetura –Universidade de Lisboa; jnpernao@fa.ulisboa.pt

\* Corresponding author: marhazin@gmail.com

## Abstract

Roman Catholicism, introduced in Brazil since the 16<sup>th</sup> century by religious missionaries who accompanied the Portuguese explorers and colonizers, contributed decisively to the art expressed in the churches built in this former colony of Portugal, with religious orders and congregations assuming an important role in this process. This paper represents part of a PhD research that aims to use the NCS (Natural Color System) to analyze the painted ceilings of the churches of Pernambuco, Brazil, from the eighteenth century, namely those legally protected at the federal level. The motivation for this investigation is based on the promising field of color studies, which, together with new technologies, has allowed for a greater understanding of the works of the past. A standardized and worldwide known color system, free from any relation to paint brand references, will add a new scope to color analysis on this field, allowing also the possibility of comparison between paintings and the registration of future changes in surface colors due to the passage of time, or other aging factors. Moreover, there is a considerable number of works of art (paintings on wood ceilings), with no attributed authorship, which is a historical gap that this study of colors could help to solve. The intention is to contribute to the research procedures in the fields of conservation, restoration, the study of colors, and the investigation of authorship. On this case study, this procedure was applied to two eighteenth century painted ceilings on churches in Pernambuco. For the comparative study between these two monuments, the classification of the colors was carried out with NCS color reader and sample comparison, allowing the definition of hue, chromaticness and blackness.. These color dimensions were later used to formulate and test the mixture of pigments in order to use colors in the process of restoration. This research is expected to build a procedure that will add scientific knowledge and methodological improvements to the work of professionals in this field.

**Keywords:** Colonial Painted Ceilings, Baroque Art, Natural Pigments, NCS Color System

## INTRODUCTION

The 18th century in Brazil was marked by the development of religious art through regional schools. The Pernambucan school stood out for its originality, especially in the municipalities of Recife and Olinda, presenting a fascinating work in the field of Baroque and Rococo religious art.

This article addresses the study that contemplated the analysis and classification of colors of two painted ceilings in Catholic churches in Pernambuco (as part of the PhD course at the Faculty of Architecture of the University of Lisbon), which are considered monuments and were elevated to the category of Cultural Heritage property by IPHAN (Institute of Historical and Artistic Heritage of Brazil), due to their artistic and historical values. The religious artworks related to this school, more specifically the paintings on the linings of the listed churches, date from the year 1728 (beginning of the construction of the São Pedro dos Clérigos Cathedral in Recife/PE), until the end of the 18th century, a period that corresponds to the second phase of the baroque produced in Pernambuco. With the objective of analyzing the artistic elements of the paintings on the ceilings of these monuments, the research presents a theoretical and practical character, being inserted in the field of Historical Heritage and in the line of research of Conservation and Restoration. For this, it was necessary to trace a



chronological panorama of the construction of the colonial churches, the techniques and the period of the execution of the painting of the linings and the craftsmen of the time in order to know the materials used and their specificities.

As for the monuments selected for the case studies, it was considered as a criterion, the period of their construction and the artwork used in the ceilings of their naves. Within this aspect, it was necessary to approach the configuration of the sacred space and to what extent the architecture (internal and external) contributes to the impression of feeling and spirituality in the built environment. The work started from an extended study of the ceilings of fourteen churches from the XVIII century, (two of which were studied in more depth contemplating the classification of the colors used in the ceilings), which are protected at the federal level by the Brazilian government, in the state of Pernambuco.

For the analysis and classification of the colors of the painted ceilings, besides the historical period, the similarity of styles and colors between the works of art were also taken into consideration when choosing the two monuments: Church of the Franciscan Convent and Chapel of Engenho Bonito. The choice is also due to the fact that there are pre-existing studies about the physical-chemical parameters of the pigments used in the paintings on the roofs of these temples. Another issue concerns the authorship of the work of one of these paintings being recognized, which can eventually be solved in the process of color analysis, since the shades of the paintings are very similar, and may be an indication that the works have the same author or belong to the same school.

The objective of this research was to analyze the paintings on the ceilings, on wooden support, in order to identify and classify the color palettes based on the NCS (Natural Color System).

Other objectives unfolded from this:

1. To know the current existing procedures of analysis of studies of painted ceilings of the XVIII century in order to subsidize the construction of guidelines for the study of this type of work;
2. To analyze iconographically and stylistically the paintings of the 18th century painted ceilings of the federally listed churches in the State of Pernambuco, Brazil;
3. Analyze the system of socio-political and economic contexts and their relations with the Church as an institution, in the state of Pernambuco, Brazil, in the eighteenth century;
4. To classify the color palette in the NCS (Natural Color System) of the painted lining of the church of the Franciscan Convent of Santo Antonio (Igarassu/PE) and of the Chapel of Engenho Bonito (Nazaré da Mata/PE).
5. To make comparative studies between the ceiling paintings of the two mentioned monuments, contemplating styles, designs, color palette and physical-chemical analysis;
6. To correlate the colors of the ceilings, classified in the NCS system, with pigments existing in the market, in order to be able to reproduce part of the colors of the studied works.

## **METHODOLOGY**

To comply with the main objective of the research, first we had to analyze the colors of the paintings of the ceilings on wooden support, using the NCS color system, in order to relate and classify their palettes. At a second stage we tried to reproduce part of these colors, taking the NCS notation as guide, aiming at a future use of this methodology to contribute to the field of conservation and restoration. In this way, we intend to emphasize the relevance of color classification technologies in the field of restoration works, not only to better describe the painting characteristics in a standard system, that

The NCS color notation as a guide to produce colors from traditional pigments in conservation: The case study of two painted ceilings from eighteenth-Century Churches in colonial Brasil

could be understood and reproduced anywhere, but also to be able to measure the behavior of the pigments over time.

By comparing the colors classified according to their position in the triangle and chromatic circle of the NCS system, the color family to which the color belongs can be perceived, making it easier to find the closest shades, an action that can be performed in the laboratory, optimizing the working time on site.

Based on the color notations obtained with the NCS color reader applied to the ceiling of the churches, the colors were reproduced following the hue proportions provided by those notations (Figure 1). The actual pigments used for the reproduction of the classified colors were chosen from the physicochemical analyses performed on the pigments of the paintings of the assets, in addition to following the hues and nuances oriented by the colorimeter.

Subsequently, the color reader was used again, this time to measure the colors reproduced in the laboratory and compare the result with the colors collected *in loco*. Results were compiled in a spreadsheet.

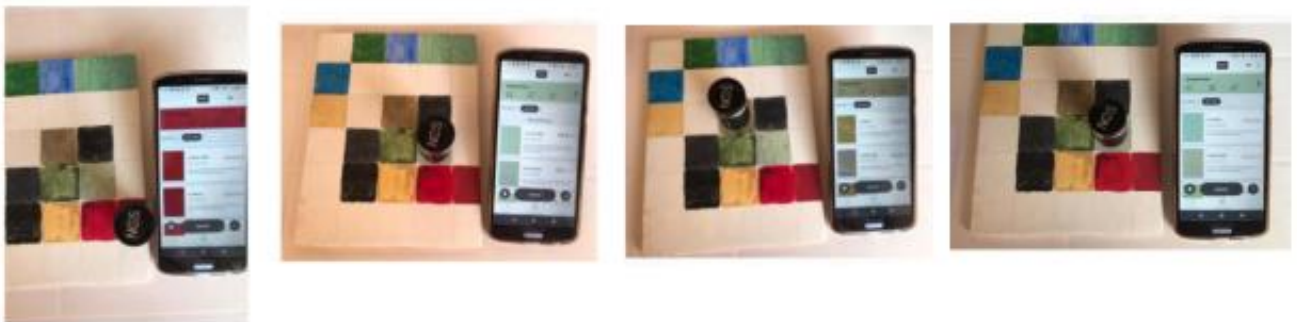







Figure 1: Classification of the colors obtained, reproduced by current pigments.

### Analysis

The table below presents the colors measured in the paintings on the ceilings of the two monuments, classified in the NCS system.

Chapel of Engenho Bonito		Church of the Franciscan Convent of Santo Antonio	
NCS Notation	Color	NCS Notation	Color
S3030-G		S3020-G	
S2030-B90G		S3020-B90G	
S3030-G20Y		S3020-G10Y	

The NCS color notation as a guide to produce colors from traditional pigments in conservation: The case study of two painted ceilings from eighteenth-Century Churches in colonial Brasil

S7020-G70Y		S7010-G90Y	
S2020-Y10R		S3020-Y10R	
S3050-Y90R		S3050-Y80R	
S6010-Y50R		S6020-Y80R	
S5040-Y70R		S4040-Y40R	

Table 1: Colors classified by the NCS System found in the two churches studied.

The similarity between the colors used in the paintings of the two churches is impressive, particularly if we think that the NCS color reader analysis is done only through a small hole a few millimeters in diameter, and that the paintings are full of subtle color variations.

## RESULTS

Even knowing that NCS is a perceptual based system, we tried to reproduce the 8 colors of the Chapel of Engenho Bonito and the 8 colors of the Franciscan Convent Church in the laboratory from the information provided by the NCS notation, namely the information regarding the Hue, Chromaticness and Blackness. After reproducing the 8 colors of the two monuments and positioning the colors reproduced in the laboratory in the chromatic triangle and circle of the NCS system, we compared this positioning (of the colors reproduced) with the colors classified *in loco* in the two monuments and observed the proximity of the colors in both the triangle and the chromatic circle.

Figure 2 below shows the percentage of the accuracy of the colors obtained *in loco* and reproduced.

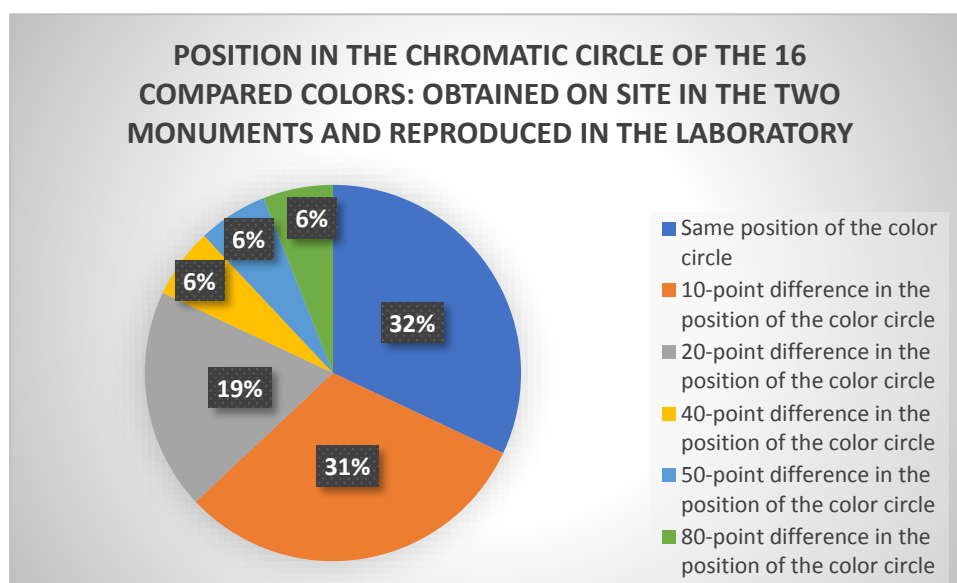

Figure 2: Percentage of accuracy between the original colors and the ones obtained with the mixture of pigments.

The research concluded that the NCS notation proved to be an excellent guide for directing the pigments' color mixture in the search for the color one wants to achieve, giving the guidelines for Blackness, Chromaticness and Hue. The restorer therefore has the possibility to be guided more efficiently in the search for the color he intends to reach. From this possibility, the experiments can be done in the laboratory and taken to the work, substantially reducing the time spent in the search for color, which for a long time was done through complete trial and error.

Another conclusion of the work concerns the similitude between the color palette of both the two monuments studied. This characteristic, along with others like the drawing style, could help to deduced that they are part of the same school, the Pernambuco school of baroque/rococo. However, they cannot be attributed to the same author because there is a time difference of 113 years between them.

## REFERENCES

- Aguiar, J. 1999. *Cor e Cidade histórica- Estudos Cromáticos e Conservação do Patrimônio*. Porto: Rainho & Neves Ltda.
- Ayer, R. 2015. *Manual do Artista* (5ª Ed.). São Paulo: Martins Editora Livraria Ltda.
- César, J. C. de O. 2010. O NCS - Natural Color System e possíveis aplicações no projeto arquitetônico. In: *Revista do Programa de Pós-Graduação em Arquitetura e Urbanismo da FAUUSP*, v. 17 (n.27), 194-207. São Paulo.
- Chevreul, M. E. 1839. *De La Loi Du Contraste Simultané des Couleurs*. Paris: Chez Pitois Levrault et C.
- Coutinho, E. 2001. Ano da criação: entrevista a Alexandre Bandeira. In: *Continente Multicultural*, ano 1 (n.3), 33-42. Recife: Companhia Editora de Pernambuco.
- Cruz, A. J. 2000. A Matéria de que é Feita a Cor. Os Pigmentos Utilizados em Pintura e sua Identificação e Caracterização. Tomar, Portugal: *1º Encontro de Conservação e Restauro-Tecnologias*, Instituto Politécnico de Tomar.
- Cruz, A. J. 2004. Os Materiais da Pintura Mural Romana segundo o tratado de Vitruvius. Lisboa, Portugal: *Revista do Instituto de História da Arte da Faculdade de letras de Lisboa*, (n.3), p. 67-86.
- Cruz, A. J. 2007a. Os Pigmentos Naturais Utilizados em Pintura. Tomar, Portugal: Departamento de Arte, Arqueologia e Restauro, Instituto Politécnico de Tomar, Centro de Química e Bioquímica, Faculdade de Ciências da Universidade de Lisboa.
- 2007b. Pigmentos e Corantes das Obras de Arte em Portugal, no Início do Século XVII, segundo o Tratado de Pintura de Filipe Nunes. In: *Conservar Património, n 6. Lisboa, Portugal: Associação Profissional de Conservadores Restauradores de Portugal*.
- Cursio, Í. F. 2017. *Cor Luz, Cor Pigmento – A Física e as Artes*. Curitiba: Editora CRV.
- Ferrero, J. L C. Roldán, D. Juanes, C. Morera, E. Rollano (2001). EDXRF Analysis of Pigments of Works of Art from The Spain's Cultural Heritage. *Advances in X-ray Analysis* 44: 425-431.
- Finlay, V. 2014. *The Brilliant History of Color in Art*. Los Angeles: Getty Publications.
- Fraser, T., and A. Banks. 2007. *O Guia Completo da Cor*. São Paulo: Editora SENAC.
- Mayer, R. 2015. *Manual do Artista*. São Paulo: Martins Editora Livraria Ltda
- Pernão, J. N. 2012. *A Cor como Forma do Espaço Definida no Tempo: Princípios Estéticos e Metodológicos para o Estudo e Aplicação da Cor e Arquitetura e nas Artes*. Lisboa: Universidade Técnica de Lisboa.
- Rosenfield, L. L. 1991. *A Utilização das Cores em Alguns casos do Retoque na Restauração*. Porto Alegre: Porto Arte, Vol.2, n.3.
- Varichon, A. 2009. *Colores. Historia de su significado y fabricación*. Barcelona, Espanha: Gustavo Gili, SL.



# Colours of pre-cinema projections: the evolution of hand-painted magic lantern glass slides' palette

Ângela Santos <sup>1,\*</sup>, Vanessa Otero <sup>2</sup> and Márcia Vilarigues <sup>1</sup>

<sup>1</sup> Department of Conservation and Restoration and VICARTE Research Unit, NOVA School of Sciences and Technology (FCT NOVA), Portugal; aba.santos@campus.fct.unl.pt; mgv@fct.unl.pt

<sup>2</sup> Department of Conservation and Restoration and LAQV@REQUIMTE and VICARTE Research Unit, NOVA School of Sciences and Technology (FCT NOVA), Portugal; van\_otero@fct.unl.pt

\* Corresponding author: aba.santos@campus.fct.unl.pt

## Abstract

With the magic lantern, the projection of moving animated images was combined with sounds and revolutionised the means of communication for collective audiences.

The colours used to paint by hand 18<sup>th</sup>- and 19<sup>th</sup>-century European magic lantern glass slides from Portuguese collections are being studied to unveil a possible relation between the materials applied and the place of production and makers. Ultraviolet-Visible, X-Ray Fluorescence and Raman spectroscopic techniques were explored to allow a first insight into the evolution of the magic lantern colour palette over time. By developing a timeline, it was possible to find differences between manufacturers, countries and periods, mostly in the early 19<sup>th</sup>-century and revealed to be a promising tool to attribute slides with more precision. Light-sensitive colourants were identified, such as red and yellow organic lake pigments, which is extremely important to develop and implement conservation strategies towards their preservation.

**Keywords:** *Magic Lantern glass slides, Painting materials characterisation, Pre-cinema colours, Glass painting, 18<sup>th</sup> century, 19<sup>th</sup> century*

## INTRODUCTION

The magic lantern was the first popular device for the projection of images that globally revolutionised social communication, being used for the dissemination of science, religion, and advertisement, to illustrate lectures and entertain children and adults (Frutos 2010). By combining the projection of colourful moving animated images with audio performances the magic lantern achieved its apogee during the 18<sup>th</sup> and 19<sup>th</sup> centuries and is considered a mark of the beginning of the "pre-cinema" period (Frutos 2010; Robinson et al. 2001).

During that time, several documents with instructions on the production of magic lantern slides were written, and they provide valuable information on their artistic and manufacturing practices (Frutos 2010). According to these, the moving images were initially hand-painted on glass plates with watercolours and oils which, when projected, revealed their magic by playing with the colours' transparency and light. Colours for magic lantern glass painting were listed by these authors, and it is worth mentioning that their number was necessarily restricted due to the importance of transparency (Groom 1855). As it stands to reason, the artists needed to master the glass painting techniques to produce quality slides since all the details and imperfections were magnified during the projections (Frutos 2013; Rodrigues et al. 2019).

Despite knowing the colours advised by literature from that period, we can only be certain of which ones were applied on historical slides through their material characterisation, and this period is particularly interesting to study due to the changes in the production of painting materials, with alchemy giving place to chemistry and the discovery of new elements that triggered the development of different compounds and colours (Harley 2001).

A set of 18<sup>th</sup>- and 19<sup>th</sup>-century European hand-painted magic lantern slides from the Portuguese collections of Portuguese Cinematheque – Museum of Cinema (CP-MC), National Museum of Natural

History and Science (MUHNAC) of the University of Lisbon (ULisboa), and Department of Conservation and Restoration (DCR) of the NOVA School of Sciences and Technology (FCT NOVA), is being studied within the framework of the PhD project "*Lanterna Magica: Technology and Preservation of Painted Glass Slides for Projection with Magic Lanterns*". A correlation between the materials on written sources and hand-painted slides from the same period has been made and the first guidelines for their conservation were established (Rodrigues et al. 2019; Santos et al. 2019; Santos et al. 2021).

In this work, 44 hand-painted slides from these collections were analytically characterised, 24 from unknown makers, and 20 produced by three of the most renowned 19<sup>th</sup>-century manufacturers: Philip Carpenter (Birmingham and London), later Carpenter and Westley (London); William Edward and Frederic Newton (London); and Lapierre (Paris) (Figure 1). The relationship between the colourants identified and their attributed time of production and manufacturer is explored.

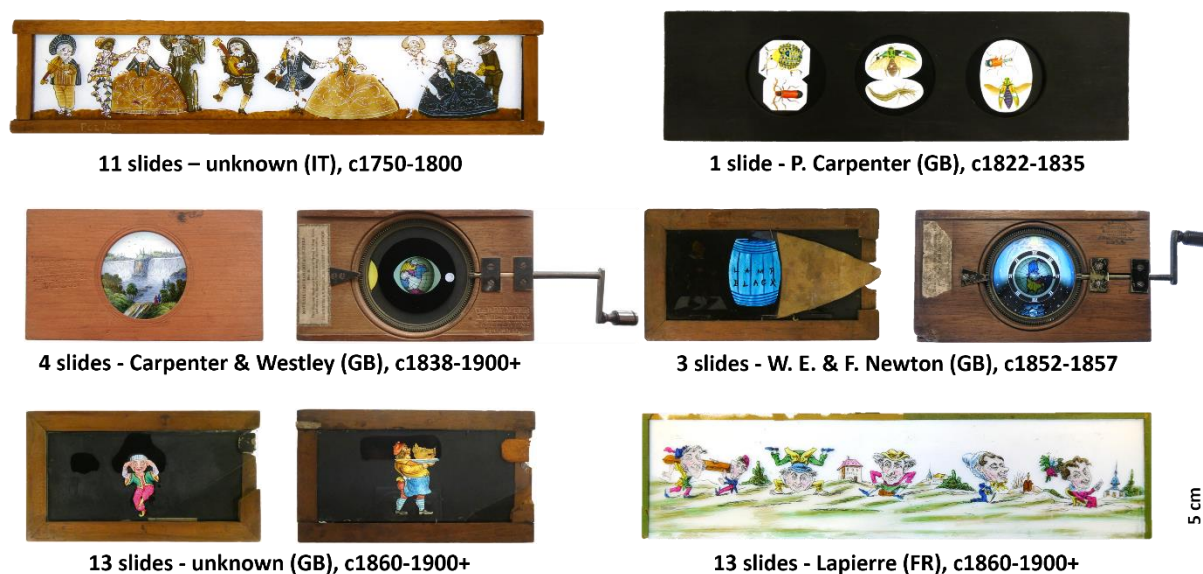

Figure 1: Selection of representative slides studied and their proposed attribution. Institutional identification codes of the presented slides (from top left to right): PC002/002 from CP-MC; FCT.V.LM01 from DCR; PC189/009 from CP-MC; PC3301/005 from CP-MC; FCT.V.LM02 from DCR; PC3301/001 from CP-MC; PC3302/009 from CP-MC; MUL-MUHNAC-UL000068 from MUHNAC; PC166/006 from CP-MC (photo credits: Ângela Santos).

## METHODOLOGY

The characterisation of the colours was achieved in-situ using three complementary techniques.

Ultraviolet-Visible Spectroscopy (UV-Vis) was performed in absorbance mode using an AvaSpec-2048-SPU spectrophotometer with an AvaLight-HAL Deuterium Halogen (Avantes). The spectra were acquired in the 200–1100 nm range with 10-50 ms integration time and 20 accumulations.

Energy Dispersive X-Ray Fluorescence Spectrometry (EDXRF) was carried out using an ARTAX 800 spectrometer with air-cooled low-power X-ray tube with a Mo target and Xflash<sup>®</sup> Peltier cooled silicon drift detector. The conditions were 40 kV, 0.6 mA, and 120 s acquisition time in a He atmosphere.

Raman Spectroscopy was carried out using a Labram 300 Jobin Yvon spectrometer, equipped with a 17 mW HeNe laser operating at 632.8 nm. The laser power at the surface of the samples was controlled using a set of neutral density filters varying between 0.6 and 2.

## RESULTS AND DISCUSSION

Analysis revealed that many of the colours resulted from mixtures rather than a single colourant and the materials revealed to be even less variate than expected from the literature. As shown by the timeline (Figure 2), interesting changes in the colour palette occurred, mostly in the early 19<sup>th</sup> century.

Regarding the colourants identified, a yellow ochre with hematite and goethite, detected by the UV-Vis band at 660 nm and broadening of the band between 850-930 nm, was used in yellows and oranges until c1835 (Figure 3e; Table 1) (Townsend 1987). Later, it gave place to gamboge, a yellow gum resin also found in orange, brown and green mixtures on English 19<sup>th</sup> century slides (Figure 3e,d).

Hematite was mostly used in the 18<sup>th</sup> century to paint outlines and red areas (Figure 3e). In a few slides, it was mixed with cochineal to produce orange. From c1850 onwards it started to be widely used as brown in both English and French slides. After c1822, another red pigment, vermilion, was identified in orange, red and pink mixtures (Figure 3e).

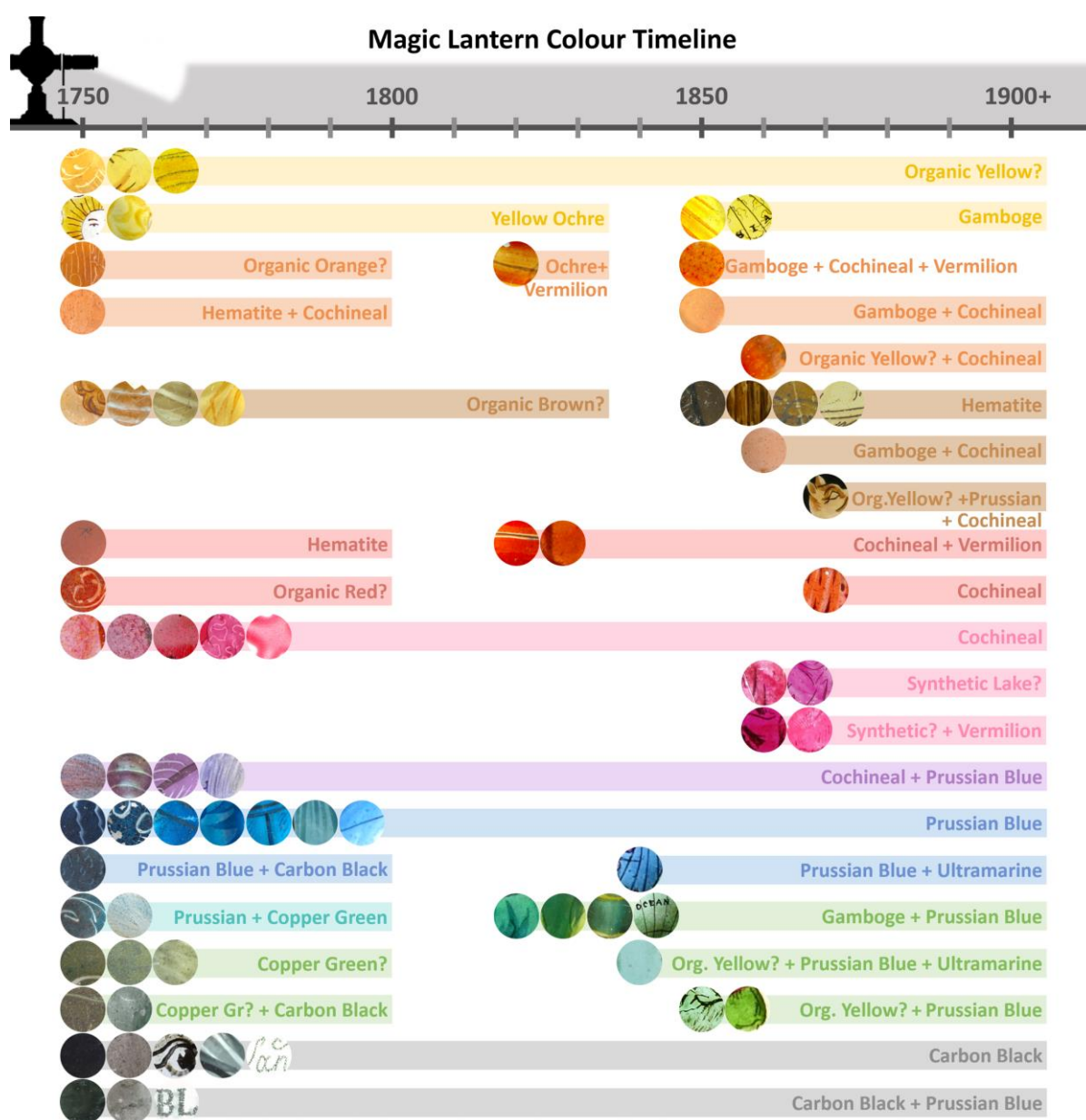

Figure 2: Timeline of the main colours and respective colourants applied on hand-painted magic lantern slides (? - unidentified colourants). Different hues found for the same colour are illustrated with detail images of the slides.



Cochineal-based lakes, defined by the UV-Vis spectra indicative of an aluminium anthraquinone lake according to Fonseca et al. (2019), were consistently used throughout both centuries and by all producers (Figure 3a and Table 1). They were used as red and pink lakes and were generally mixed with yellows to produce oranges and browns, and with blues to make purples (Figure 3b). In contrast, seven Lapierre slides revealed to have an unidentified synthetic pink possibly similar to eosin, detected by its strong UV-Vis and Raman signals, and orange UV fluorescence (Figure 3a).

Prussian blue was another favourite, being present in all of the slides analysed. It was also commonly found in purple and green colours, respectively mixed with cochineal and gamboge or other organic yellows (Figure 3b,d). A blue mixture of ultramarine and Prussian blue was also identified in one Carpenter and Westley slide, in both blue and green colours (Figure 3c,f). Before c1822, greens were made of a copper-based compound detected by EDXRF instead of mixtures.

Finally, carbon-based blacks were consistently detected not only in painted areas but also in 19<sup>th</sup> century painted and printed outlines. It was also used to darken blue and green colours (Figure 3f).

Considerable differences between manufacturers were also observed. Lapierre had a restricted palette, only composed of mostly pure yellow, brown, pink, blue, green and black colours, whether Italian and English producers frequently included oranges, reds and purples and combine the different paints in subtle colour gradients and hues (Figure 1). Concerning the colourants used by known producers, only P. Carpenter used yellow ochre. Interestingly, this slide also had a green made of gamboge and Prussian blue, which can indicate the use of a green formulation sold under the name of Hooker's green or Prussian green. Besides being used by P. Carpenter, gamboge was only applied by W.E. and F. Newton. Only Lapierre used a synthetic pink lake, possibly on later slides, and only Carpenter and Westley applied ultramarine besides Prussian blue in one of the slides analysed.

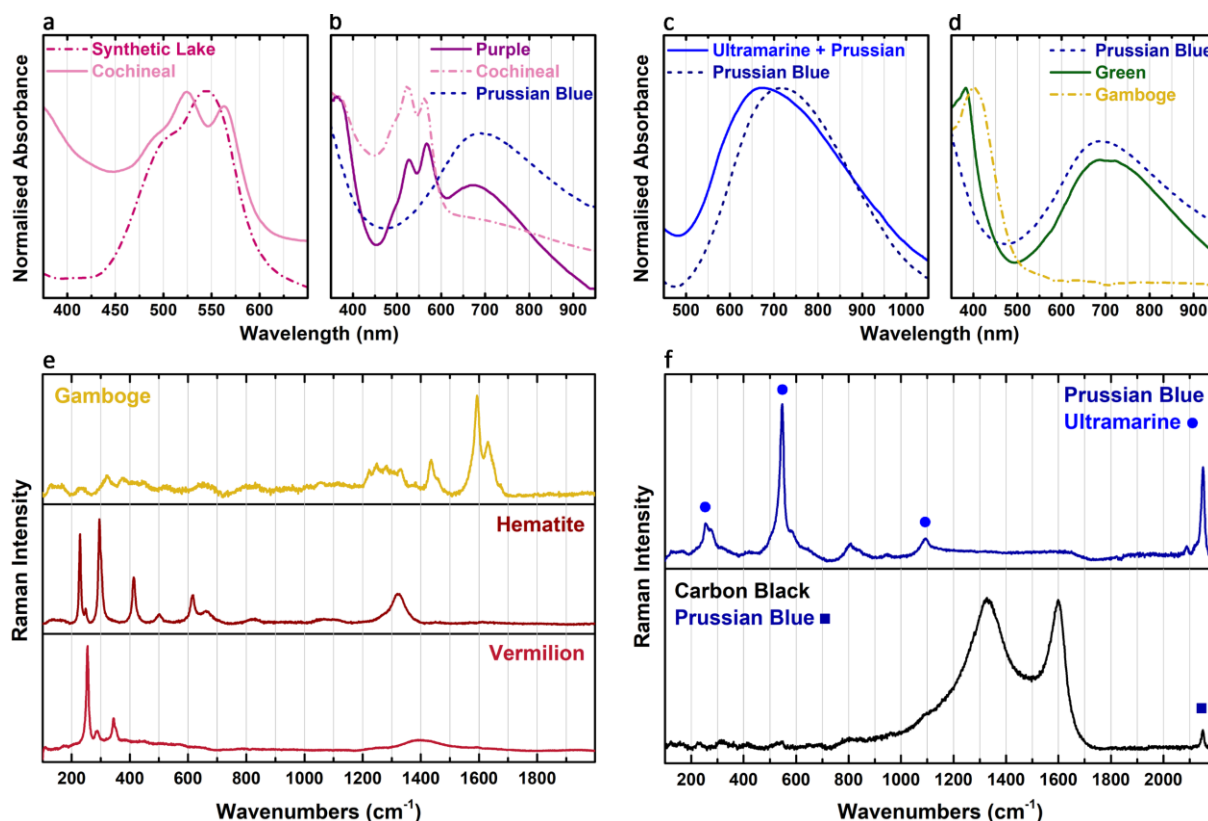

Figure 3: Representative spectra of UV-Vis (a, b, c, and d) and Raman (e and f) of several of the colours identified on hand-painted magic lantern glass slides. The main characteristic bands are presented in Table 1.

Colourant	UV-Vis Spectroscopy		Raman Spectroscopy	
	Bands (nm)	Transition	Bands (cm <sup>-1</sup> )	Assignment
<b>Gamboge</b>	620-635	n.i.	1436	$\delta$ (CH <sub>2</sub> )
	665-675		1593	$\nu$ (C-CH)
			1630	$\nu$ (C=C)
<b>Goethite</b> ( $\alpha$ -FeOOH)	500	$2(^6A_1) \rightarrow 2(^4T_1)$	-	-
	660	$^6A_1 \rightarrow ^4T_2$		
	850-930 <sub>br</sub>	$^6A_1 \rightarrow ^4T_1$		
<b>Hematite</b> ( $\alpha$ -Fe <sub>2</sub> O <sub>3</sub> )	550	$2(^6A_1) \rightarrow 2(^4T_1)$	224, 244, 292, 409	$\delta$ (Fe-O)
	860	$^6A_1 \rightarrow ^4T_1$	611	$\nu$ (Fe-O)
<b>Vermilion</b> (HgS)	-	-	254, 286 <sub>sh</sub>	$\delta$ (S-Hg-S)
			344	$\nu$ (Hg-S)
<b>Cochineal</b>	524, 563	$n \rightarrow \pi^*$	-	-
<b>Prussian blue</b> (Fe <sub>4</sub> (Fe[CN] <sub>6</sub> ) <sub>3</sub> )	680-720 <sub>br</sub>	Charge-transfer Fe <sup>2+</sup> /Fe <sup>3+</sup>	235 <sub>sh</sub> , 276, 327 <sub>sh</sub>	$\delta$ (C-Fe-C)
			530, 600 <sub>sh</sub>	$\delta$ (Fe-C $\equiv$ N)
			2094, 2156	$\nu$ (C $\equiv$ N)
<b>Ultramarine*</b> (Al <sub>6</sub> Na <sub>8</sub> O <sub>24</sub> S <sub>3</sub> Si <sub>6</sub> )	668 <sub>br</sub>	Charge-transfer S <sub>2</sub> <sup>-</sup> /S <sub>3</sub> <sup>-</sup>	255	$\delta$ (S <sub>3</sub> <sup>-</sup> )
			547	$\nu_s$ (S <sub>3</sub> <sup>-</sup> )
			1091	overtone
<b>Carbon black</b>	-	-	1327	$sp^3$ (CC)
			1597	$sp^2$ (CC)

Table 1: Colourants' main characteristic bands of UV-Vis and Raman Spectroscopies (Bacci 2000; Berns and Imai 2002; Carter et al. 2016; Cosentino 2014; Fonseca et al. 2019; Legodi and de Waal 2007; Moretti and Gervais 2018; Townsend 1987; Vandenabeele et al. 2000). \*The UV-Vis band presented corresponds to the mixture of ultramarine and Prussian blue and not to this pigment alone which would be observed between 600-610 nm. Note: sh-shoulder, br-broad,  $\nu$ -distention,  $\delta$ -bending, s-symmetric.

## FINAL REMARKS

Although this work included only a small set of hand-painted magic lantern glass slides, especially when compared to 19<sup>th</sup> century mass production, it was already possible to find differences between periods, manufacturers and countries. The most significant changes occurred in the early 19<sup>th</sup> century and the representation of the palette over time enables the visualisation of its evolution. By characterising the colourants, it revealed to be possible to attribute the production dates of some of the slides with more precision, for example by identifying the synthetic pink lake used by Lapierre.

This study unveiled a promising path for future investigation on this subject. Further research will be fundamental for the creation of a spatial-temporal map that will provide knowledge on each manufacturer evolution over time. Finally, light-sensitive colourants such as gamboge, cochineal and Prussian blue were identified, which is of relevance to advance knowledge towards their preservation.

## ACKNOWLEDGEMENTS

The authors acknowledge the support of the Portuguese Foundation for Science and Technology (FCT-MCTES), for CORES-PD/00253/2012, PhD grant PD/BD/136694/2018 (Ângela Santos), 2020.00647.CEECIND (Vanessa Otero), and Research Units VICARTE (UIDB/00729/2020 and UIDP/00729/2021) and LAQV@REQUIMTE (UIDB/50006/2020 and UIDP/50006/2020). This research benefited from the use of the PRISC (Portuguese Research Infrastructure of Scientific Collections). The authors are grateful to the Portuguese Cinematheque – Museum of Cinema and National Museum of Natural History and Science of the University of Lisbon for the collaboration with this PhD project.

## REFERENCES

- Bacci, M. 2000. UV-VIS-NIR, FT-IR, and FORS Spectroscopies Ed. *Modern Analytical Methods in Art and Archeology - Chemical Analysis Series* 155 (12): 321–361.
- Berns, R. S., and F. H. Imai. 2002. The Use of Multi-Channel Visible Spectrum Imaging for Pigment Identification. *13th Triennial Meeting Rio de Janeiro Preprints, ICOM Committee for Conservation 1*: 217–222.
- Carter, E. A., F. R. Perez, M. Garcia, H. G. M. Edwards. 2016. Raman Spectroscopic Analysis of an Important Visigothic Historiated Manuscript. *Philosophical Transactions of the Royal Society A: Mathematical, Physical and Engineering Sciences* 374: 1–13.
- Cosentino, A. 2014. FORS Spectral Database of Historical Pigments in Different Binders. *E-Conservation Journal*, 2: 54–65.
- Fonseca, B., C. S. Patterson, M. Ganio, D. MacLennan, and K. Trentelman. 2019. Seeing Red: Towards an Improved Protocol for the Identification of Madder- and Cochineal-Based Pigments by Fiber Optics Reflectance Spectroscopy (FORS). *Heritage Science* 7 (92): 1–15.
- Frutos, F. J. 2010. *Los Ecos de Una Lámpara Maravillosa: La Linterna Magica En Su Contexto Mediatico*. Salamanca: Ediciones Universidad de Salamanca.
- . 2013. From Luminous Pictures to Transparent Photographs: The Evolution of Techniques for Making Magic Lantern Slides. *The Magic Lantern Gazette* 25 (3): 3–11.
- Groom, Edward. 1855. *The Art of Transparent Painting on Glass*. London: Winsor and Newton.
- Harley, R. D. 2001. *Artists' Pigments c. 1600-1835: A Study in English Documentary Sources*. London: Archetype Publications.
- Legodi, M. A., and D. de Waal. 2007. The Preparation of Magnetite, Goethite, Hematite and Maghemite of Pigment Quality from Mill Scale Iron Waste. *Dyes and Pigments* 74 (1): 161–168.
- Moretti, G., and C. Gervais. 2018. Raman Spectroscopy of the Photosensitive Pigment Prussian Blue. *Journal of Raman Spectroscopy* 49 (7): 1198–1204.
- Robinson, D., S. Herbert, and R. Crangle, eds. 2001. *Encyclopaedia of the Magic Lantern*. London: The Magic Lantern Society.
- Rodrigues, B., Â. Santos, M. J. Melo, V. Otero, and M. Vilarigues. 2019. Magic Lantern Glass Slides Materials and Techniques: The First Multi-Analytical Study. *Heritage* 2 (154): 2513–2530.
- Santos, Â., V. Otero, and M. Vilarigues. 2019. Characterisation of Glass and Painting Materials from 18<sup>th</sup>-Century Hand-Painted Glass Slides Used for Projection with Magic Lanterns. In: *Recent Advances in Glass and Ceramics Conservation 2019, Proceedings of the Interim Meeting of the ICOM-CC Glass and Ceramics Working Group and Icon Ceramics and Glass Group*, J. Mandrus and V. Schussler, ed. London, 223–28.
- Santos, Â., B. Rodrigues, V. Otero, and M. Vilarigues. 2021. Defining the First Preventive Conservation Guidelines for Hand-Painted Magic Lantern Glass Slides. *Conservar Património* 37: 100–115.
- Townsend, T. E. 1987. Discrimination of Iron Alteration Minerals Data in Visible and Near-Infrared Reflectance Data. *Journal of Geophysical Research* 92 (5): 1441–1454.
- Vandenabeele, P., B. Wehling, L. Moens, H. Edwards, M. De Reu, and G. Van Hooydonk. 2000. Analysis with Micro-Raman Spectroscopy of Natural Organic Binding Media and Varnishes Used in Art. *Analytica Chimica Acta* 407 (1–2): 261–274.

1 COLOR AND MEASUREMENT INSTRUMENTATION	2 COLOR AND DIGITAL	3 COLOR AND LIGHTING	4 COLOR AND PHYSIOLOGY
5 COLOR AND PSYCHOLOGY	6 COLOR AND PRODUCTION	7 COLOR AND RESTORATION	8 COLOR AND BUILT ENVIRONMENT
9 COLOR AND DESIGN	10 COLOR AND CULTURE	11 COLOR AND EDUCATION	12 COLOR AND COMMUNICATION MARKETING

## 8 COLOR AND BUILT ENVIRONMENT

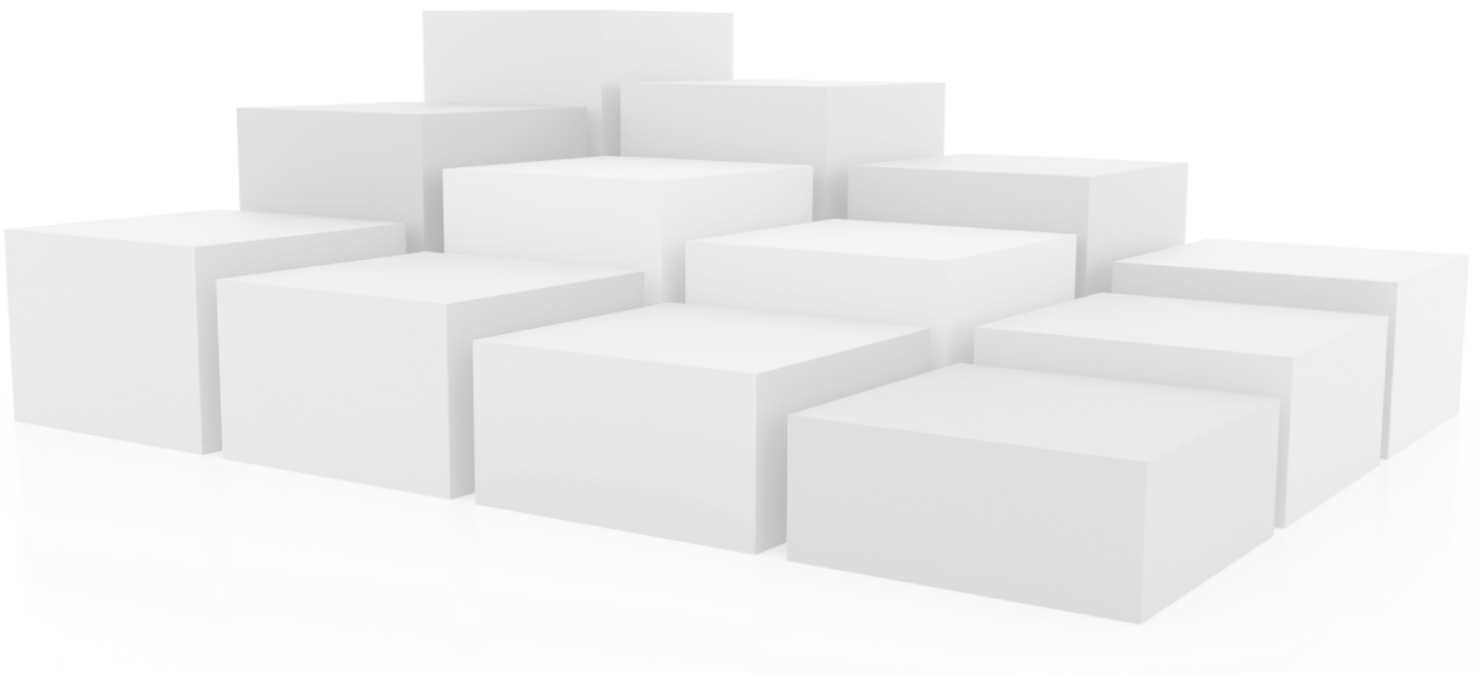

AIC 14<sup>th</sup> Congress Milano 2021 - August 30<sup>th</sup>– September 3<sup>rd</sup> 2021



# Spatio-temporal Factors of Colored Light Sequences in the Built Environment : the case of a choral concert – Part One

Jean-Luc Capron <sup>1,\*</sup>

1 Université catholique de Louvain; jean-luc.capron@uclouvain.be

\* Corresponding author: jean-luc.capron@uclouvain.be

## Abstract

When designing a light show using sequences of colored lights, it is essential to consider spatial and temporal dimensions, as well as their interactions. These two dimensions must be approached in their multiple aspects, taken individually and in their interactions. In this paper, the color lighting design of a choral concert in an enclosed space, defined by a backstage wall and a space dedicated to spectators between four large pillars will be analyzed. The analysis is carried out on the basis of 1,890 photos captured every half a second during a 15-minute performance. We will present in detail the characteristics of the context of the performance, in order to identify the spatial and temporal strategies of the performers, the audience and the designers of the color lighting. This light show responds to the rhythm of songs and declamations of poems to make of the event a visual as well as an acoustic experience.

**Keywords:** colored light, spatio-temporal, built environment, human perception, lighting design

## INTRODUCTION

This work follows on that presented in two previous papers by the author focusing on the modification of spatial perception by color patches (2003) and the perception of colored light sequences in the built environment (2011).

The objective of this paper is to set steps for research in space, light and color by adding the temporal to the spatial dimension. We will therefore try to specify the framework by listing the components on the basis of an event of which the characteristics are known and manageable. This enables listing the spatial and temporal parameters in the next steps, and analyzing them. Subsequently, the interactions can be considered between the spatial and the temporal dimensions, and their effects analyzed. The final objective would be to propose guidelines promoting color lighting design strategies that stimulate the designer's creativity.

A light show responding to a choral concert in a closed and defined space is the occasion of this research. The light show was designed by students enrolled in the Space, Light and Color course taught by the author. The colored lights aim to create an atmosphere in accordance with the songs and poems, and enhance the spatial and temporal perception of the audience.

The concert/light show took place in a vast space with a long wall acting as a backdrop and a quadrangular sub-space materialized by four large pillars of square section (figure 1a).

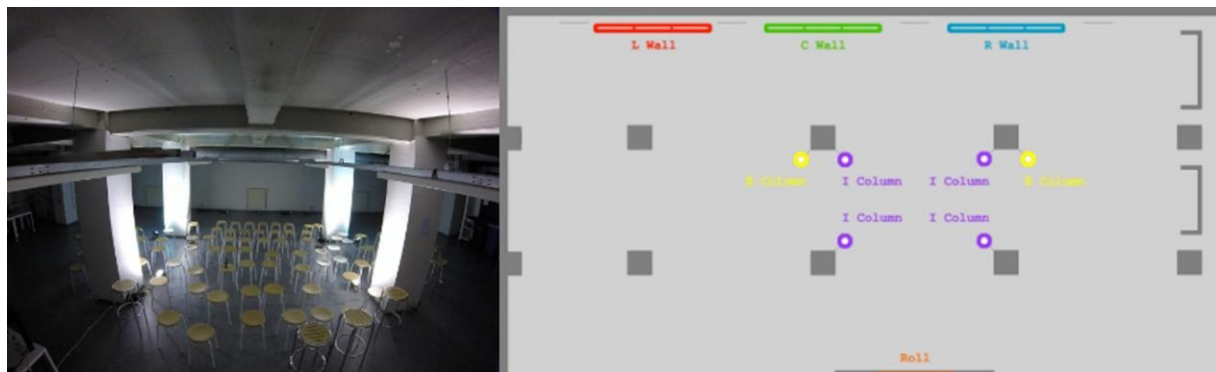

Figure 1: a. Performance space after the concert/light show. b. Plan with lighting fixtures location.

The elementary like structure of the spatial boundaries makes it easier to isolate each of the spatial components and determine their interactions. The light sources are arranged as follow: linearly to illuminate the background evenly, point-wise to illuminate the faces of the pillars, linearly to illuminate the fragment of the ceiling above the quadrangular sub-space (figure 1b). With this clear configuration the projected colored lights and the resulting color patches on the illuminated surfaces can be analyzed independently.

The perception of the physical space is modified not only by the fact that the boundary surfaces are revealed, or not, by light, but also by the color and intensity of the luminous flux, itself resulting from the additive synthesis of the respective flux of the light sources. In addition, the spatial dimension is dependent of the perception of color patches, taken individually or by association with neighbouring colors.

Spatial perception is also modified in its temporal dimension by the sequential appearance/disappearance of colored lights, according to specific rhythms. Further, these rhythms modify the spatial perception of the physical place. In turn, the resulting spatial perception of the place impacts on the perception of the rhythms.

This light show of a built environment with elementary spatial characteristics, will allow us to identify some spatial and temporal strategies. And later to list and characterize spatio-temporal factors, individually or interactively.

## **CASE STUDY**

In this section, will be described three key points of the physical context: the features of the place and lighting fixtures, the design process of the light show in relation to the concert and the characteristics of the set of images analyzed in this research.

The concert/light show took place in the cafeteria of the Faculté d'architecture, d'ingénierie architecturale, d'urbanisme of the Université catholique de Louvain, Brussels campus building (figure <UCL-LOCI-BXL-Cafeteria-01.jpg>). Within the vast room, the specific area for the event is composed of two key elements: a long wall perceived as vertical surface cognitively associated with a scene backdrop, and a sub-space with a quadrangular plan, materialized by four large pillars of square section. The color of the plastered walls and pillars is white, as well as the non-plastered concrete beams and ceiling. The color of the ground is a very light gray linoleum. The cafeteria booth curtain, the ventilation pipes and the cable trays are shiny metal surfaces.

### **Colored Light**

The colored light fixtures are of three types, three specific uses and three specific spatial locations.

The light fixtures are placed at three different significant locations within the room. The variations in color and intensity of the luminous flux were programmed using Nicolaudie's Easy Standalone 2 lighting control software. During the event, the information is transmitted to the projectors according to the DMX512 standard for communication networks in order to control the lighting effects of the lighting scenes.

The first type of lighting fixture consists of nine Chauvert DJ COLORband PIX USB, a LED bar, with a length of 987 mm. The twelve 3 W Tri-color RGB LEDs generate a maximum illuminance level of 2,245 lux at 2 m. Three groups of LED bars are aligned along the so-called backstage wall.

The second type consists of six Chauvert DJ SlimPAR PRO H USB, a LED projector of 198 mm in diameter, consisting of twelve 10 W LEDs, with a maximum illuminance level of 3.218 lux at 2 m. The six projectors are placed at the foot of the four pillars: four projectors in the inner diagonal axis, and

two projectors in the outer diagonal axis of the two pillars near the wall. For DMX control, projectors are grouped in two sets of four and two respectively. The address of each group consist of seven channels, one for each color of the projectors: Red, Green, Blue, Amber, White and UV.

The third type consists of two Chauvert DJ 4Bar LT USB, consisting of a metal bar on which four LED projectors are fixed to compose a set of 198 mm in length. Each projector consists of three Tri-color RGB LEDs of 9 W. The twelve 3 W Tri-color RGB LEDs generate a maximum illuminance level of 2,053 lux at 2 m. The two sets of spotlights are aligned at the back of the room on top of the curtain roll container, at a height of 2.385 m. Thus, at a lower level than the concrete beams, ventilation pipes and the metallic cable trays. All eight projectors are addressed by means of three channels, one for each of the RGB color.

### **Choral Concert**

Based on the recordings made available by the choir director, the songs were split into temporal sequences based on repetitions of musical motifs, rhythmic variations, ... These temporal sequences were analyzed on the basis of the mood of sounds. In order to synchronize the light show and the music, the duration of the sequences were timed. Since temporal variations can occur between the recorded performance of the singers and that performed during the concert, a certain flexibility regarding the timing has been kept. Also, each lighting sequence is slightly longer than the duration of the song preventing a discordance between light and music. When designed, the light show specific to each song is compiled into a single DLM file, but launched individually. The starting signal for each song was given by a discrete signal from the choir director.

### **Set of images**

The analysis carried out is based on 1,890 photos which correspond to as many images captured with a GoPro Hero camera. The camera specifications are a focal length of 35 mm and a focal of F/2.8, the ISO sensitivity and opening time parameters being variable. The ISO sensitivity and opening time variations partially biases the process of a comparative analysis. This variation is necessary to obtain images of sufficient quality to be used as data. This alters the reading of the lighting design, which is usually based on uniform colored areas. Only an image in High Dynamic Range format would avoid these underexposed or overexposed areas. Though, an HDR image is composed of at least three raw pictures of a static scene, which is incompatible with the temporal dynamics of a color light show.

The camera was placed high up, at the back of the room, enabling the coverage of the entire space with no obstacle to obstruct the field of vision. Positioned close to the ceiling, the images captured give a preponderant importance to the ceiling and beams. It also amplifies the shadow/light contrast on the vertical axis. As the sides of the performance space are unlit, the space framed by the camera is sufficient for analysis. The camera is located at the back of the performance space. This area is not illuminated and the only light it receives is very weak and indirect.

To fully focus on space and color, preference was given to still images rather than video. Still images provide a great pixel definition with a good color rendering. The fixed interval of a 1/2 second between captures ensures objectivity in the selection of the set of images. Thus preventing human factor biased selection.

## **SPACE BEHAVIOR**

Below are described some of the spatial strategies developed by the three types of actors involved in the event: the performers, the spectators and the designers of the lighting show.



### **The choir**

For this concert, the Melting Vox choir and its conductor Stefano Poletto, have developed a scenography in accordance to the room characteristics. To do this, they have set up various spatial strategies which can be summarized as follows: A linear arrangement of the singers at the back of the stage, which can be declined in multiple ways depending on the regularity of the intervals between the singers. A circular arrangement around the audience, with a variation on the sides of the quadrangle: An angular arrangement, along the diagonals of the quadrangle or an arrangement normal to the sides of the quadrangle, with a configuration according to the medians of the quadrangle.

### **The Audience**

For organizational reasons, the number of spectators was limited to 50 people, on reservation. The stools were gathered in a circular space exinscribed in the quadrangle formed by the outer angles of the four pillars. About ten spectators joined later on and seats were added at the periphery (figure 1a). After the concert, the analysis of the seating arrangement indicates that the circle initially formed by the stools was dilated to form an ellipse whose main axis is parallel to the axis of the long wall. These modifications show a stereotypical behavior of the spectator looking towards a stage. This despite the fact that the stools, having no backrest, do not give any information on the orientation that will be given to the gaze during the show. The spectators' intuitive behavior looking for a show on a stage, was in this case contradicted by the scenography of the performers and the lighting designers.

### **The designers**

The positioning of the spotlights is a defined in accordance of the space, but also taking into account the performers who must be highlighted but not dazzled. Moreover in agreement with the artists, the goal was never to highlight them, but rather to create an atmosphere in which the voices stem from the silhouette of the performers. An initial analysis reveals three generic strategies for colorfully lighting the space. For this research, these strategies have the advantage of including specific approaches regarding color and space.

A first strategy consists of a uniform colored lighting on the entire surface of the peripheral walls (figure 2a). A variation of this strategy is to light the so-called backdrop and the ceiling in the same shade. In this case, the pillars appear in black (figure 2b) or in a complementary shade (figure 2c).

A second strategy, conversely, consists of lighting the four pillars with neutral light, in white and/or amber (figures 2d, 2e, 2f), all other walls being shaded. A variation of this strategy includes the so-called backdrop wall (figure 2g, 2h) or the ceiling. When only lighting the exterior sides of pillars close to the stage, this strategy can delimit a stage (figure 2i).

A third strategy consists of lighting only the long wall. This can be achieved, for example, by varying the shades of the three groups of lights in order to break the flatness of the walls or to produce moving effects. This possibility was not retained, in the same way that the possibility of varying colors of each LED had been rejected in order not to compete with the performers. An alternative consists of lighting of the so-called backdrop wall with reminders of the colored light elsewhere in the concert space.



Figure 2: Pictures a – c. first generic strategy. Pictures d – l. second generic strategy.

### **TEMPORAL STRATEGIES**

Space and time are intimately linked, which implies that spatial strategies also include a time dimension. Therefore, we will only focus on light show design strategies in terms of projected color and the implications in terms of perception.

While the juxtaposition of two or more colored spots commonly refers to pictorial work, the colored highlighting of space presents an increased complexity. This complexity derives from the three-dimensional space boundaries and the temporal dimension of the performance. The management of colors, in their temporal variation and their spatial and/or temporal juxtaposition, is one of the major difficulties in a light show, whether or not associated with sounds.

An analysis of the possibilities offered by the light show design software shows that the temporal variations of a colored light projected at a given point in space can be the result of two strategies.

A first strategy consists in maintaining a shade for a more or less long period of time followed by another. The shades can be among other of a complementary, gradient, or monochrome type. It must be taken into account that a saturated color visible for a relatively long time, followed by a neutral shade favors the appearance of the afterglow phenomenon. The high degree of saturation of the colored lights emitted by a LED favors the appearance of this kind of visual phenomenon, which in turn may alter the perception of a succession of two saturated colors.

A second strategy is to vary in time the intensity of two or more color LEDs. However, the transition from one saturated hue to another by the additive synthesis of two colors generates chromatic grays which can be perceived as "dirty colors". The high degree of saturation of the

colored light emitted by LEDs promotes the appearance of this kind of perceptual phenomenon. Under these conditions, it is difficult for shades of gray to compete with bright colors.

## **CONCLUSIONS**

When designing a light show using sequences of colored lights, it is essential to consider spatial and temporal dimensions, as well as their interactions. These two dimensions must be approached in their multiple aspects, taken individually and in their interactions. In this paper we presented in detail the characteristics of the case study and outlined some of the spatial and temporal strategies of the performers, the audience and the light show designers.

As a case study, the colored and dynamic lighting of a built environment designed on the occasion of a choral concert further allows the detection of spatio-temporal factors. This, to establish the characteristics of each of these two dimensions, isolated and/or in interaction. For this, the research of Lo and Steemers, specific to concert lighting (2021, 2020, 2014) is of interest, as well as the concept of Relative visual performance developed by Rea (1991, 1986) and a Perception-based Approach proposed by Cuttle (2015).

## **ACKNOWLEDGMENT**

The author would like to acknowledge the Université catholique de Louvain for its financial support for this research and the artistic event. Especially Professor Myriam Watthee-Delmotte who initiated the event "Reste la lumière" on the occasion of the International Day of Light. The singers of the Choir Melting Vox, under the direction of Stefano Poletto, and the actor Malkiel Golomb for their enthusiasm for developing a specific scenography, in accordance with the light show. The students enrolled in the course Space, Light and Color, taught by the author at UCLouvain, who designed and produced the light scenes under my supervision: Tiphaine Boussard, Kilian Daubié, Steven Le Goff, Antonin Mack, Simon Mehanna, Fabiana Paradisio, Vasiliki Privartitsiani, Yassir Rhanja. As well as the Service audiovisuel de la Commission communautaire française (Cocof) for renting the lighting equipment.

## **REFERENCES**

- Capron, J.-L., Huysnans M-H. 2003. Textile Design based on Built Environment and User Specificities: Re-scaling a classroom with colored patterns on textile. In: *AIC COLOR 2002 SI "Color & Textiles*. V. Golob, S. Jeler & Z. Stjepanovič, ed. Slovenian Maribor: Colorist Association & University of Maribor, 69-76.
- Capron, J.-L. 2011. Coloured Light Sequences based on Human Perception: The case of a lit sculpture in an urban open space. In: *AIC 2011, Interaction of Colour & Light in the Arts and Sciences*. V. M. Schindler & S. Cuber, ed. Zurich: pro/colore, 50-53.
- Cuttle, C. 2015. *Lighting Design: A Perception-based Approach*. Oxon: Routledge.
- Lo, V.W.L, and K.A. Steemers. 2020. Methods for assessing the effects of spatial luminance patterns on perceived qualities of concert lighting. In: *Lighting Research and Technology* 52: 106–130.
- Lo, V., and K. A. Steemers. 2021. Evaluating the overall impression of concert lighting: An integrated approach. In: *Lighting Research & Technology* 0: 1–26.
- Rea, M.S., and M.J. Ouellette. 1991. Relative visual performance: a basis for application. In: *Lighting Research and Technology* 23: 135–144.

# Children's colour preferences in the school context

Camilla Giani <sup>1,\*</sup> and Cristina Boeri <sup>1</sup>

<sup>1</sup> Color Lab, Department of Design, Politecnico di Milano; milly.giani@hotmail.it; cristina.boeri@polimi.it

\* Corresponding author: milly.giani@hotmail.it

## Abstract

The aim of the paper is to present an ongoing study on the evaluation of children's colour preferences in the school context. In particular, two experiments have been planned and partially conducted in order to evaluate both the differences that may be found between colour preferences expressed in generic terms and contextualized in a school environment, and the differences that may be found between digital simulations displayed on the computer and experimented using the CAVE technology. The paper presents the methods of the two experiments and the results of the first experimentation conducted on children between the ages of 6 and 10 using an online questionnaire that showed children both digital colour samples and digital colour simulations of the same colours applied to a classroom environment.

**Keywords:** *Colour design, colour preference, school design*

## INTRODUCTION

Several authors have highlighted the importance of colour in school environments in relation to both functional and emotional values, also offering indications regarding the colours and schemes to be adopted (Birren 1969; Mankhe 1998; Grube 2014; Engelbrecht 2003). In the framework of the studies about the evaluation of the emotional response to colour in children, and therefore on children's colour preferences and associations, some experiments were conducted by circumscribing these evaluations to specific contexts. In these studies, simulations of differently coloured interior environments are subjected to the evaluation of children instead of generic or abstract colour samples. In particular, the studies by Read and Upington (2009) and Dalirnaghadeh (2016) assessed children's colour associations and preferences in preschool interiors using the image of a school environment manipulated to create different colour alternatives. In the study by Park (2014), the correlations between colour attributes and children's colour preferences for interior room colours were analysed using scale-models. These studies contribute to the discussion regarding the role of the context in which the emotional response to colour is evaluated and therefore the possible design implications related to the study of colour preferences and associations in children. On the other hand, the limits linked to the simulation of reality and its simplification, even in monochromatic terms, raise the need for more circumstantial studies and research to concretely guide the design choices (Boeri 2019).

In this framework two experiments have been planned and partially conducted in order to evaluate both the differences that may be found between the colour preferences expressed in generic terms and contextualized in a school environment, and the differences that may be found between digital simulations displayed on the computer and experimented using the CAVE technology.

## METHODS

The study focused on the design of two experiments for the evaluation of children's colour preferences in a general and contextualised situations using digital simulations of a primary classroom environment. Both the experiments were designed to involve children (age 6-10) in the evaluation of a selection of 26 colours firstly showed just as digital colour samples and then applied to digital simulations of the same classroom using a 3D model to be experienced in monitor for the first

experimentation and in a CAVE for the second one. CAVE technology will allow the display of a 360 ° image of the classroom created as a 3D model.

The model used for the simulation consist in a traditional classroom of 25 children set up with desks, chairs, wardrobe and shelves. The furnishings used have a gray-coloured metal structure and natural coloured beech wood seats, backrests and shelves (Figure 1).



Figure 1: The classroom view used in the study.

Different colours were applied exclusively to the walls in a monochromatic solution of the classroom environment, which means all the walls were coloured with the same colour. This solution has been used in several studies both to verify the psycho-physiological effects of single colours (Hettiarachchi et al. 2017; Kwallek et al. 1996; Kwallek et al. 1988), and to probe colour preferences related to a specific environment (Read and Upington 2009; Dalirnaghadeh 2016).

The colours selected were decided on the base of their recurrence in the literature addressing the children's colour preferences taking into consideration the belonging to the same age group (6-10 years), and the adoption of material coloured sample for the methodology of investigation (Child et al. 1968; Boyatzis and Varghese 1994; Terwogt and Hoeksma 1995; Hettiarachchi et al. 2017). These colours are: Red, Blue, Green, Yellow, Purple, Pink, Orange, and as achromatic colours White, Black and Gray. As specific colour notations relating to the colour samples adopted in these studies were not always available, the selection of the samples was carried out using NCS - Natural Colour System. The chromatic colours, except pink, were chosen with maximum chromaticness, i.e. the sample closest to the apex of the triangle. In addition, for each hue two additional samples were selected in order to obtain a lighter and darker colours option. Even for the Gray colour two more samples were selected with different blackness. Thus, the total number of samples selected for the study was 26 (Figure 2).

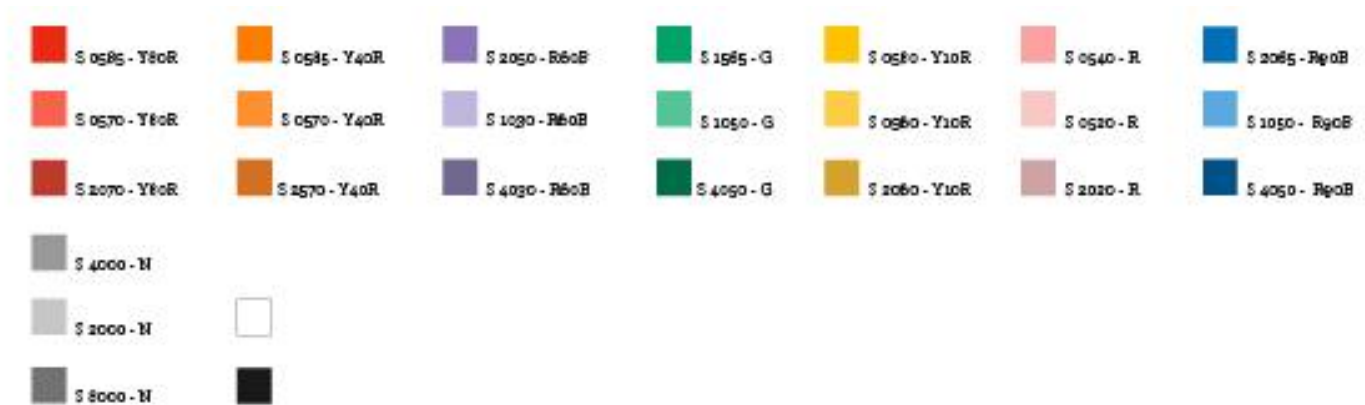

Figure 2: The 26 NCS standard colours identified for the experimentations. At the top the high chromaticness colours followed by the lighter and darker colour options.

Once the colours were identified, the walls of the classroom image were modified using Photoshop software, in order to obtain one classroom chromatic configuration for each colour, and then 26 different colour configurations of the same classroom to be evaluated.

### Experimentation I

The first experimentation aimed to collect and evaluate preliminary data on abstract and contextualized children's colour preferences using digital colour samples and digital colour simulations of classroom environments to be compared with each other and with the reference studies.

The experimentation consisted in the administration of an online questionnaire to school-age children, between the ages of 6 and 10, of both sexes. The questionnaire was designed to be easy for the child to understand and to fill out quickly. One of the main advantages of using the online questionnaire is the ease in reaching a large number of subjects in a short time. On the other hand, the supervision of children delegated only to parents and not done by an expert, may either not be sufficient, or on the contrary, be too intrusive, affecting the children's responses (Punch 2002).

The questionnaire was divided into two main macro sections, and preceded by the request to complete some general information about the children age and gender.

The first section of the questionnaire focused on the investigation of abstract colour preferences. In the first question children were asked to specify the preferred colour among those shown: Red, Yellow, Orange, Blue, Green, Pink, Purple, White, Black and Gray. The options to choose from for this question are presented all together, but in a random order, automatically generated by the Google form. The participant was given the opportunity to provide only one answer to the question. Despite the awareness that colours displayed on unknown and different devices would be different from those identified in the preliminary phase, the form presented visual reference of all colour samples, together with a corresponding colour name, to create a subsequent comparison with the same colour applied in the classroom environment. In the second question of this section, children were asked to assign a grade for each colour (from 1 to 4, where 1 is the lowest and 4 the highest), in order to create a ranking of preference. This method allows to gather more information on the same subject regarding not only the preferred colour, but also to all the other samples (Guilfort and Smith 1959). In the third question children were asked to further express their preference on the colour they already chosen as the

favourite in comparison with two more samples of the same hue and different blackness and chromaticness that would appear lighter and darker.

The second section of the questionnaire was about colour preferences applied to classroom images. The structure of this section was the same as the previous one. Children were asked firstly to choose their preferred coloured classroom among those shown, then to assign a grade for each coloured classroom image (from 1 to 4), and finally automatically directed to the question that involved the coloured classroom they already chosen as the favourite in comparison with two more variants that would appear lighter and darker.

The period in which data were collected was from April 2020 to May 2020. Thanks to the collaboration of the teachers, the answers were given by children attending five different primary schools of Lombardia region in Italy. Specifically, the number of children who participated in this experiment was 101, of which 53 were females and 48 were males. The children's average age participating in the survey was 8.5 years.

### **Experimentation II**

The second experimentation, not yet conducted, involves the use of CAVE technology to simulate both abstract colours and the context of colour preferences. The colours and the 3D representation of the classroom used in this experimentation are the same as those illustrated previously for experimentation I.

The CAVE (Automatic Virtual Environment) of the ED-ME LAB - Laboratory for environmental design and multisensory experiences, of the Politecnico di Milano, is used for the experimentation. The simulation of this CAVE is semi-immersive, through the use of three synchronized projection screens. The projected images are not stereoscopic. The screens on which the image is projected are touch and therefore allow an interaction between the image and the viewer in the CAVE. Furthermore, it is also possible to reproduce sounds and interact vocally with the CAVE system.

The structure of the questions addressed to children is the same as the first experimentation. The differences are in the physical presence of the children participating in the trial and in the smaller number of children involved. The results obtained from this second experimentation will be compared with those of the first experimentation in order to evaluate the different degrees of control over the accuracy in digital colour reproduction as well as to estimate the effects of children's involvement.

### **RESULTS**

The results of the first experimentation allow us both to understand if the colour preferences expressed by children in abstract terms using digital colour simulations are consistent with the results of the reference literature, and to understand if the preferences for the abstract colour are consistent with those expressed for the digital simulation of the class.

As for the results of colour preferences expressed in abstract terms, the most preferred colour was Blue (20,8%). This result appears consistent with Child et al. (1968) and Terwogt and Hoeksma (1995). The colours with the lowest preference scores were Orange, Black and Gray, that was also found in Boyatzis and Varghese (1994) and Hettiarachchi et al. (2017) studies. No child has chosen White as their favourite colour. If we analyse the data from a gender point of view, we can notice that the females' preferred colour was Purple (18,9%) while the males' one was Blue (29,2%), as it was found in Boyatzis and Varghese (1994) research.

Moreover, the results of the first experiment allow us to understand whether the colour preferences expressed by children in general have been confirmed or not once applied to the



classroom context. The percentage of children who changed their colour preference from abstract to contextualized colour was 54%, of which 58% were males and 52% were females.

As we can see from the chart (Figure 3), which compare the total preferences given for each abstract colours and applied to the class image, an increase in preference for Pink in males and an increase in preference for Blue in females regarding the contextualized colours are visible. Another notable data that emerges is related to White colour, which appears to have a greater appreciation for both males and females when contextualised. Even preferences for the Black colour are increased when contextualized compared to preferences for the abstract sample.

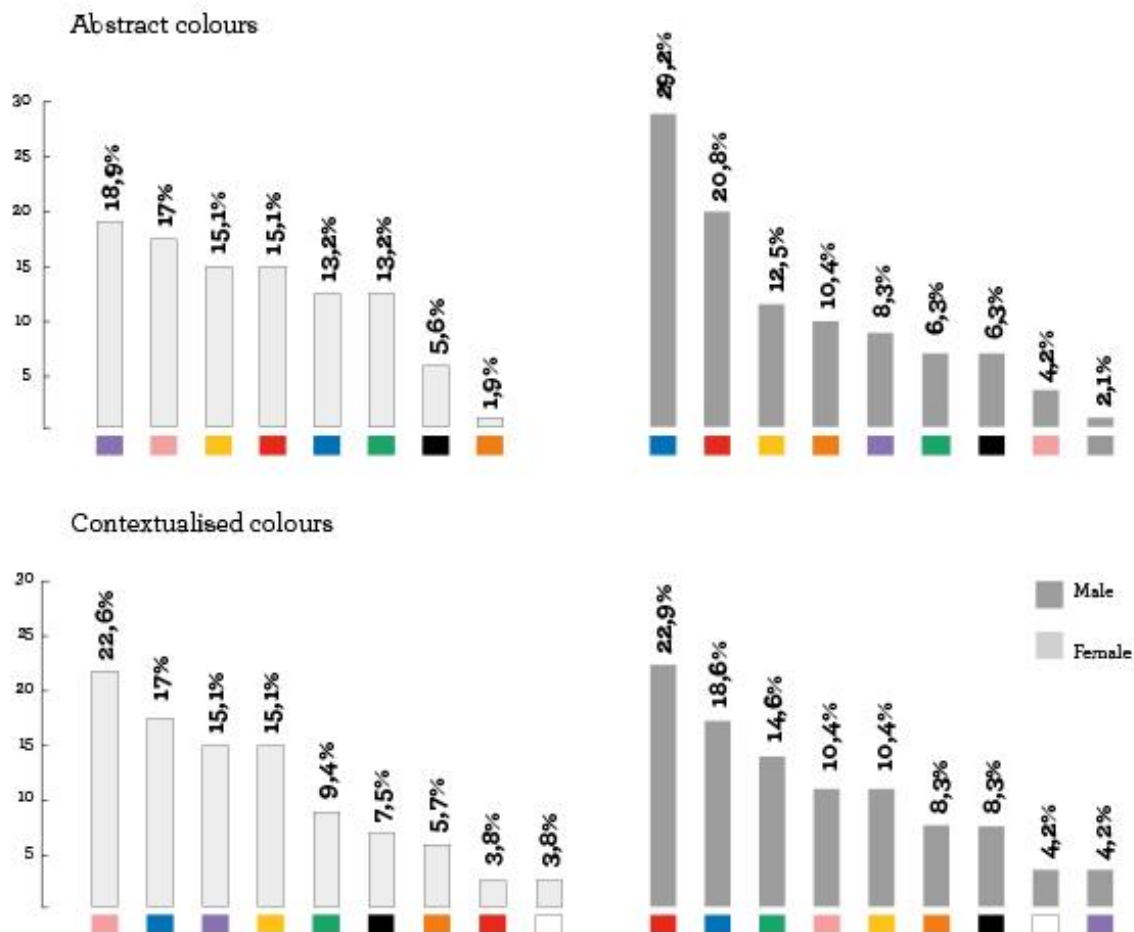

Figure 3: Preferred abstract and contextualised colours for male and female.

Therefore, we can say that preferences for the contextualized colours appear both different and more diversified compared to abstract colour preferences.

### CONCLUSION

The aim of the study is the evaluation of children's colour preferences in general and contextualised situations using digital simulations. The two experiments had the common purpose of probing the children's colour preferences, both abstract and contextualized, and to identify any differences among the two.

Although it is clear the difference between the digital simulation of an environment and the experience of a real environment, there are many advantages offered by the possibility of using the digital simulation to understand if and how the colour preferences in children can be affected by the



contextualization in specific and different contexts. Therefore, this study aims to use digital simulation with varying degrees of control over accuracy in colour reproduction as well as varying degrees of realistic feeling of environment and children's involvement, in order to contribute to explore the design implications of colour preferences and associations.

## REFERENCES

- Birren, F. 1969. *Light, Color & Environment*. Schiffer Pub Ltd. West Chester. Pennsylvania, USA edizione (1988).
- Boeri, C. 2019. Color emotion as a feasible tool in a participatory project for a Primary School. In: *Color Culture and Science Journal* 11(1): 19–27.
- Boyatzis, C. and R. Varghese. 1994. Children's Emotional Associations with Colors. *The Journal of genetic psychology* 155.
- Child, I. L., J. A. Hansen, and F. W. Hornbeck. 1968. Age and Sex Differences in Children's Color Preferences, *Child Development*. Wiley 39: 237-247.
- Daliraghadeh, D. 2016. The Effect of Chromatic and Achromatic Color Schemes on Children's Emotions in a Preschool Classroom. *Master thesis in Arts, Interior Architecture and Environmental Design İhsan Doğramacı Bilkent University*. Ankara.
- Engelbrecht, K. 2003. The Impact of Color on Learning. In: *NeoCON*.
- Giani, C. 2020. The experimentation of children's colour preferences in a school context. *Master Thesis in Interior and Spatial Design, School of Design, Politecnico di Milano*. Milano.
- Grube, K. J. 2014. Detrimental Effects of White Valued Walls in Classrooms. In: *Educational Planning* 21: 69-82.
- Guilford, J. P. and P. Smith 1959. A system of colour preferences. In: *American Journal of Psychology* 62: 487-502.
- Hettiarachchi, A. and A. Nayanathara 2016. Impact of Class Room Colour on Primary Education. In: *"Building the Future—sustainable and resilient environments": 9th International Conference of Faculty of Architecture Research Unit (FARU), University of Moratuwa, Colombo, Sri Lanka, 000-000*.
- Kwallek, N. and C.M. Lewis, J.W.D. Lin-Hsiao, H. Woodson 1996. Effects of Nine Monochromatic Office Interior Colors on Clerical Tasks and Worker Mood. In: *Colour research and Application, John Wiley & Sons* 21: 448-458.
- Kwallek, N., C.M. Lewis, and A.S. Robbins. 1988. Effects of office interior colour on workers. In: *Applied Ergonomics* 21: 275-278.
- Mahnke, F. H. 1998. *Il colore nella progettazione*. Utet, Torino.
- Park, J. G. 2014. Correlations Between Color Attributes and Children's Color Preferences. In: *Colour research and application* 39: 452-462.
- Punch, S. 2002. Research with Children: The Same or Different from Research with Adults?. In: *Childhood* 9: 321-341.
- Read, M. A. and D. Upington 2009. Early Childhood, Young Children's Color Preferences in the Interior Environment. In: *Educ J* 36.
- Terwogt, M. and J. Hoeksma 1995. Colors and Emotions: Preferences and Combinations. In: *The Journal of general psychology* 122: 5-17.

# Prehension and qualification of chromatic and lighting environment. Study case – Paimio Sanatorium, Alvar Aalto

Estelle Guerry <sup>1,2,\*</sup>

<sup>1</sup> LAPLACE UMR 3213 (CNRS, INPT, UPS), Université Paul Sabatier, Toulouse, France

<sup>2</sup> LARA-SEPPIA EA 4154 (UT2J), Université Jean-Jaurès, Toulouse, France

\* Corresponding author: guerry.o.estelle@gmail.com

## Abstract

The case study presented in this paper aims to define the chromatic and luminous character of the Sanatorium Paimio, designed by the architect Alvar Aalto, in order to identify the architect's designs. For it, I based my exploratory work on the development of a chromatic and luminous "identity card" which lists the different colors and lighting modes used. The study is divided into three phases: a color observation, a light observation and the observation of interactive movements. This study highlights the work carried out by the architect on the behavior of chromatic atmospheres under different light and their influence on human reactions, ensuring the most favorable viewing and rest conditions for patients who were staying in his sanatorium. thanks to the combination of the fields of physics, aesthetics, physiology and psychology.

**Keywords:** *Color & light design, Interdisciplinarity, Interior design, Therapeutic environment*

## INTRODUCTION

The Finnish architect Alvar Aalto, designed in 1932 the Paimio sanatorium, welcoming patients suffering from tuberculosis. This place was supposed to allow patients to enjoy complete rest in optimal conditions. As convalescence can last several years in most cases, the architect wanted an environment conducive to the spirit of community between patients and caregivers; this thanks to the design of facilities and spaces accessible to all, comfortable and aesthetically pleasing. In addition, he designed an architectural composition which aimed to make it itself active during the convalescence of patients, in a functional and biodynamic desire. A very detailed program thus made it possible to match each wing to a particular type of space according to the health needs of patients. For it, the color was one of the major elements in the design of this building, in addition to the particular attention paid to the exposure of each wing according to the different uses.

In fact, one of the founding principles of Alvar Aalto's work at the Paimio sanatorium is the therapeutic application of color. Through the use of various types of psycho-sociological effects, he associated the design of moods with the associations of ideas, both subjective and objective, conveyed by the collective representations associated with colors. For example, a patient may experience a sense of warmth through the use of warm colors. It is a principle that is based on an individual's sensitivity to colors, induced in particular by education and cultural affiliation (Déribéré 1968). It is with this in mind that the architect decided to rely on Western codes, identifiable and recognized by most of the patients present. But colors also played a major physiological role that did not depend only on these cultural representations. Inspired by chromotherapy, according to which the colors can have a therapeutic action, the polychromy of the sanatorium was to participate in relieving the ailments of the patients by the particular choice of the radiations of certain colors (Kent 1947; Déribéré 1968) in s 'inspiring work involving the principle of chromotherapy, also called the physiotherapeutic principle according to the experiments carried out between the 19th and the 20th centuries, in particular for the treatment of measles (Chatinière 1900) or smallpox (Rehns 1904).

## MATERIAL AND METHOD

The purpose of the following case study is therefore to define the chromatic and luminous character of Sanatorium Paimio. The study is divided into three phases. 1 / Color observation consists of the identification of color samples of architectural elements (floors, walls, joinery, stair railings and balustrades) from photographs and optical matching compared to the colors of the NCS color chart. The same work was carried out on the furniture (tables, chairs, lights). The main spaces are also represented (outdoor environment, reception hall, dining room, meeting room, bedrooms, corridors, stairs) and reproduced in the form of maps to identify the socio-styles used. 2 / The light observation made it possible to identify the different artificial lighting modes used as well as the types of lighting, supplemented by the natural lighting methods. 3 / The observation of interactive movements consists of the observation of all the chromatic variations, according to the principle of reflection of light, and their mutual influences on our perception.

Not having been able to have personal experience of this place, the study was carried out on the basis of the photographs collected. A margin of error is therefore inevitable but considered acceptable; the challenge being to translate a thought and not to develop a reproducible frame of reference. Thus, the chromaticity values identified in this study can, reduced to their spectral property, present a difference of 1 to 2 nm with the original colors for colors ranging from blue to orange, and up to 6 nm for purple. and reds, values corresponding to the threshold of differentiation of the hues in wavelength of the human eye (Wright and Pitt 1934 as cited in Treméau 2016). Regarding the lighting data, I was unable to collect the elements relating to the characterization of the light sources. Only the different types, artificial lighting and natural light, were observed. In addition, the photographs did not allow me to identify the nature (matte or gloss) of the paints used or the light reflectance value of the colors used.

## RESULTS

### Phase 1 – Color observation

We observe a large polychromy built around thirty-five shades (Figure 1). It falls into four categories of color effects: warm, cool, neutral, and achromatic. We also observe a complementarity between certain colors of the furniture elements, between a blue-green and red, associated with a play of neutrals and punctuated by the use of darks.

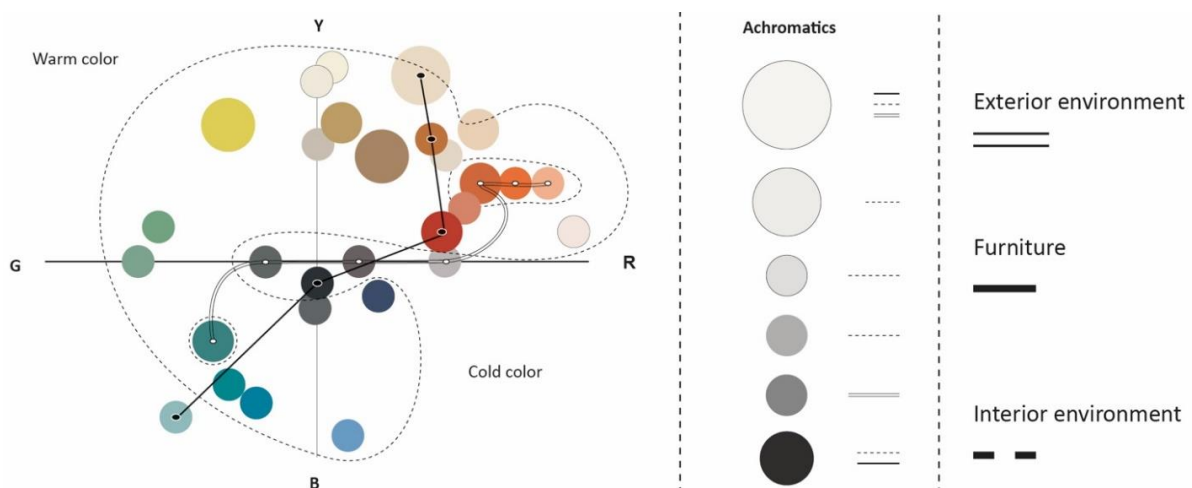

Figure 1: Cartography listing the colors used in the sanatorium program.

In addition, we observe a majority of warm and achromatic colors, representing almost a third of the colors (Table 1). Light colors are mostly used and are the only ones used for warm colors. These nuances are distributed between the exterior, interior and furniture elements. The colors used for the interior environment represent more than half of the shades used for this architectural program.

- Color	Exterior		Interior		Furniture		Total	
	Light -	Dark -	Light -	Dark -	Light-	Dark -	Light -	Dark -
<b>Warm -</b>	6%	-	19%	-	5%	-	30%	-
<b>Cool -</b>	3%	-	5%	1%	2%	-	10%	1%
<b>Neutral -</b>	2%	3%	17%	2%	-	2%	19%	7%
<b>Achromatic -</b>	6%	-	19%	3%	3%	2%	28%	5%
<b>Total</b>	17%	3%	60%	6%	10%	4%	87%	13%

Table 1: Chromatic distribution according to tonality and clarity according to the previous mapping.

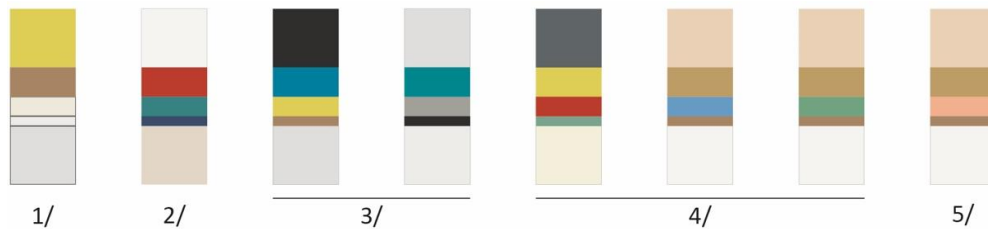

Figure 2: Set of combinations identified according to families of atmospheres previously observed.

Thus, with these color combinations, there are five families of ambience in interior spaces (Figure 2): 1 / natural (analogous composition of warm and gradient colors), 2 / dynamic (strong contrasts and predominantly warm colors), 3 / modern (cool colors, strong contrasts), 4 / relaxed (complementary to contrasting colors, neutrals associated with a tonic), and 5 / romantic (neutrals associated with a tonic).

### Phase 2 – Light observation

There are two types of dominant openings intended to capture natural light, the zenithal and lateral opening. On the facades, there are window-bands and large openings completed by a configuration of multiple leaves. We also observe frames with small footprints, except for large openings, as well as roof openings.

	Bedroom	Common area	Passage area	Dining room
<b>Opening</b>	Casement window	Skylight, window banner, casement window, glass facade		Glass facade
<b>Lamp</b>	Wall lamp, portable lamp	Portable lamp, hanging lamp	Wall lamp, hanging lamp, recessed lamp	Hanging lamp
<b>Lighting</b>	Task lighting, Mood lighting	Task lighting, Mood lighting	General lighting, Mood lighting	General lighting, Mood lighting

Table 3: Directory of openings, lighting and type of artificial lighting according to the needs of use.

Regarding artificial lighting, we observe different types of luminaire allowing the production of general lighting (recessed and suspended luminaires), ambient lighting (wall lamps and suspended luminaires) and by task (localized additional light thanks to floor-standing luminaires and portable lamps).

### Phase 3 – Observation of interactive movements

We observe variations in the perception of colors according to four modalities, reflection of exterior elements, interaction with furniture, between two opposite walls, one of which is white, and between two different opposite walls (Table 2).



Reflection of exterior elements	Interaction with furniture	Interaction between opposite walls including one white	Interaction between opposite walls of different colors
			

Table 2: Directory of the different types of chromatic variations resulting from the influence of light reflection on the built environment.

Reflection of exterior elements concerns the impact of the chromatic reflection of blinds when they are deployed. The blinds, blue-green and orange, slide in warmer tones, also operating this slide on the paintings and interior furniture. Blue turns green, neutrals turn blue and pink-orange, dull ones slide towards warm pastels. The interaction with the furniture leads to the observation of many nuances, induced by the shadows cast by the furniture, the reflectance of the floors and / or walls. If the chromatic cast remains present, we can observe a shift towards lighter, darker shades and up to a neutralization of the original color but without distortion of its tonality. Only saturation and clarity are impacted. The interaction between two opposite walls, one of which is white, leads us to observe the lightening of the original color, to tend towards neutralization of it. Conversely, taking physical distance leads to a darkened perception of this tone. Finally, the interaction between two different opposing walls leads to the observation of a play of chromatic complementarity. In the case of the projection of blue on brown, the complementarity of these two colors calls for the brown to become dominant and to cancel the projected tonality; only the nuances of this dominant are perceptible to us, from the lightest to the most downcast, from the most saturated to the most neutral. On the contrary, for a projection of green on brown and rosé on brown, leading to similar associations, the perception of

Prehension and qualification of chromatic and lighting environment. Study case – Paimio Sanatorium, Alvar Aalto  
green and rosé are preserved, only undergoing a slight neutralization. We will therefore observe a variation in their saturation, but also in their degree of clarity.

## **DISCUSSION**

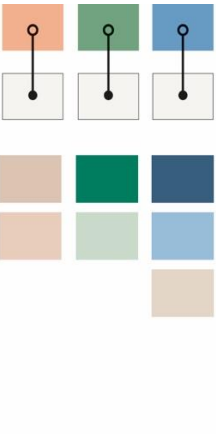
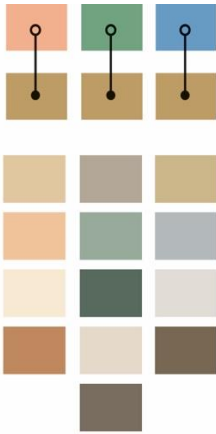
The chromatic combinations that we have previously observed can thus reflect an architect's desire to generate a harmonious chromatic scheme, which can generate a general feeling of well-being, comfort and serenity. The colors observed for the external environment create a dynamic landscape through the use of complementary colors. They generate a strong visual imprint, accompanied by achromatics. They could also refer to Western hygienist representations, thus echoing the care provided in the establishment. Neutrals may have been used in order to attenuate the signal effect of the complementary without negating their function as spatial cues and uses.

Thanks to this polychromy, the architect designed multiple atmospheres. The use of cold colors, in the minority and applied to the bedrooms, allowed him to create a peaceful, calm and relaxing atmosphere. On the contrary, warm colors and neutrals refer to comfortable and warm living spaces. Yellow, mostly used in the lobby and meeting spaces, may have been used for its soothing properties on nervousness (assuming nervousness in patients arriving at this facility). Achromatics, for their part, offer spaces for breathing in an atmosphere punctuated and structured around color. The broken complements make it possible for them to neutralize the natural force of the combination of complements to the product of a slight dynamic because indeed “in a case of simultaneous perception [...] a tone turns towards the complement of the opposite tone” (Dumond 1957). On the contrary, the discordant harmony will accentuate the signal effect and make it possible to emphasize the spatial landmarks. Beyond its modalities of association, polychromy also makes it possible to generate various universes, according to the use given to the spaces, recalling the systems of sociostyles (Kobayashi 1992) anchored in the collective imagination, according to the needs conveyed by the spaces. actions carried out in the areas concerned. The natural atmosphere induces a comforting image and an impression of serenity conducive to reassuring users, especially when entering the premises, while waiting to take exams or receive treatment. Modern atmospheres, inducing an impersonal image, emphasize the functional character of the spaces. The relaxed atmospheres offer a welcoming and joyful image of these living spaces. The romantic atmosphere is considered ideal for rooms that need to be calm, restful, conveying tenderness and kindness. The dynamic atmospheres are also intended to be joyful and welcoming while encouraging action.

But the sensitive dimension of color cannot dispense with its connection to light, which notably contributes to the development of visual perceptions. Light, whether natural or artificial, can thus be designed to strengthen chromatic qualities but can also lead to their evolution through the reflection of colors on each other. These interactive movements thus make the place active and tend to reveal multiple spaces over the days, the meteorological conditions playing a major role by then modifying the nature of the natural light available and causing variations in the perception of colors. But natural lighting above all improves the well-being and comfort of users, particularly in care practices (Déoux et al. 2011). The different openings then have the role of filtering, conducting and distributing the light in order to maximize its capture. The combination of zenith and side openings then offers optimal autonomy in terms of natural lighting. This combination allows an important light contribution and this throughout the seasons. It also provides optimal exposure to the cyclical rhythm of natural light, known today for its benefits on the circadian rhythm, or biological process, of patients (Zielinska-Dabkowska and Bureau 2017). But constrained by natural light conditions, it is necessary to use artificial lighting to compensate for natural light variations and thus produce quality lighting, free from the constraints

Prehension and qualification of chromatic and lighting environment. Study case – Paimio Sanatorium, Alvar Aalto

of natural light. The use of different types of luminaire then corresponds to specific functionalities and makes it possible to meet different needs, in particular through the production of general, ambient and task lighting. General lighting is used to ensure the movement of users in corridors and passageways, as well as the performance of routine tasks in common rooms. This type of lighting is characteristic of a uniform, diffuse and homogeneous distribution of light, notably thanks to the use of large recessed and suspended luminaires offering direct lighting. Ambient lighting, on the other hand, offers light dedicated to a momentary activity and qualifying a small space. This type of lighting is found in all types of interior spaces. The use of wall lights and suspended lights are thus conducive to the production of localized and diffused lighting. The projection of light, thanks to indirect, semi-direct, semi-indirect and mixed lighting, towards clear surfaces thus ensures the diffusion of a soft and even light. Finally, task-based lighting, or supplemental lighting, results in additional localized light thanks to mixed lighting, combined with general lighting, allowing the execution of tasks requiring a high and focused level of lighting. Mainly seen in common areas and bedrooms, free-standing fixtures or portable lamps provide this directional light that can be adjusted as needed. Thus, if a well-designed lighting is therefore defined by a sufficient quantity of light and the choice of a device that eliminates visual discomfort by glare, it is advisable to choose and combine lighting modes adapted to the needs and thus make the secure interior space conducive to comfortable living.

## **CONCLUSION**

The social role of lighting should be considered as a factor of good living, just like that of chromatic atmospheres, thanks to the combination of "physics, aesthetics, physiology and psychology" (Déribéré 1964). It is also a question of being concerned with the behavior of the chromatic atmospheres under the light and their influences on the human reactions, because using the light, it is not only to illuminate, it is to ensure the conditions of vision and of rest the most. favorable, in this case study, to patients staying in the sanatorium.

## **REFERENCES**

- Chatinière, M. 1900. Photothérapie de La Rougeole.
- Déoux, S., O. Massot, and V. Girard. L'habitat, facteur de santé des trente dernières années de vie des aînés? *Gérontologie et société* 34 / 136, 1 (2011): 91-103.
- Déribéré, M. 1968. *La Couleur Dans Les Activités Humaines*. 3e ed. Dunod.
- Déribéré, M. 1964. *L'éclairage*. Que sais-je ? 346. Presses Universitaires de France - PUF.
- Dumond, J. 1957. La Couleur Dans Le Cadre de La Vie. *Couleurs* 20(10): n/a.
- Kent, L. 1947. *Paint Power*. Washington: National paint, varnish & lacquer association.
- Kobayashi, S. 1992. *Color Image Scale*. Kodansha International Ltd.
- Rehns, J. 1904. Niels Ryberg Finsen (1860-1904). *Radium*.
- Wright, W. D., and F. H. G. Pitt. 1934. Hue discrimination in normal colour-vision. In: *Proc. Phys. Soc.* 46: 459-68.
- Treméau, A. 2016. *Éléments de base de la colorimétrie*. Saint Etienne : Laboratoire LIGIV – Université Jean Monnet.
- Zielinska-Dabkowska, K., and A. Bureau. 2017. *La conception lumière appréhender le contexte, les enjeux et les acteurs*. Le Moniteur.

# Is “yellow house” really “yellow”? Survey on determining the range of perceiving the yellow color on building facades depending on the hue, lightness and chroma

Justyna Tarajko-Kowalska <sup>1,\*</sup>

<sup>1</sup> Cracow University of Technology, Faculty of Architecture, Cracow, Poland; justarajko@tlen.pl

\* Corresponding author: justarajko@tlen.pl

## Abstract

The article's primary goal is to present the author's online color survey results. The study was aimed at checking which colors chosen from NCS Color System's four yellowish hue groups: G80Y, G90Y, Y, and Y10R are perceived as "yellow." The 28 nuances differed in hue, lightness, and chroma, were presented separately on color swatches and building facades. At first, the respondents assessed the yellowness of selected colors and then indicated the most appropriate ones for the color term "yellow." The analysis of the 444 results confirmed the high importance of saturation and lightness (whiteness/blackness level) in color appearance and naming. The research proved that a given color is likely described as "yellow" only when its parameters of lightness and saturation are similar to the prototype of the yellow color category, characterized by high saturation and high intrinsic lightness. The clarity of the hue was also the significant factor.

**Keywords:** *yellow, color in architecture, color attributes, color naming, color appearance*

## INTRODUCTION

Yellow has been a very common color in architecture since the earliest times. Thanks to the universal availability of earth pigments - with yellow ochre being not only the oldest yellow pigment but also one of the first pigments ever used by humans - warm, orangey yellows have spread throughout Europe, shaping the chromatic perception of many towns and villages to this day.

Many research confirms (e.g., Janssens and Küller 2009), that yellowish hues from groups: YR (yellow-red), Y (yellow), and GY (green-yellow), according to the NCS – Natural Color System nomenclature, are constantly most preferable for residential buildings facades in many countries, especially in Europe. But, compared to the other primary colors, pure yellow occurs only in a narrow band of the spectrum with a wavelength of 570–580 nm (Lancaster 1996: 63). Varieties of yellow may differ in one, two, or three of the color attributes: hue, lightness and saturation (chroma), thus creating a full spectrum of tones and shades. In the environment many yellowish tones exist, as it “can tend toward green on the one hand and toward orange on the other”, being described as color of gold, lemon, sulphur and saffron (Pastoureau 2019: 173-174).

In residential architecture yellows are usually used in pastel tones with high lightness level, in muted shades with low chroma, or as earthy browns. So the question arises: is a house being called “yellow” really “yellow”?, as in most cases very dark or very pale tones cease to appear yellow anymore. Also, the latest studies on color-emotion relations confirm that less saturated and darker yellows do not even produce the same emotional reactions as highly saturated ones (e.g. Schloss et al. 2020). The same conclusion comes from the author’s recent study on the use of the yellow color in architecture and built environment, where only those examples in which highly saturated tones were used, seem to carry all the characteristics and associations assigned to the yellow color (Tarajko-Kowalska 2021). While thinking or reading about the "yellow building", don't we imagine a brightly colored house, clearly visible in the landscape or being a visual attraction in public space? Those findings and questions led the author to research which samples and building facades, colored



in yellowish hues, different in the attributes of lightness and saturation, are perceived as “yellow”. The main purpose of the article is to present the results of this color survey.

## **METHOD**

To conduct the research, an online questionnaire was prepared in Google Forms.

### **Survey structure**

The study consisted of three parts. The first part was dedicated to collect the respondents' data. Participants reported their gender (female/male) and age (<18, 18-29, 30-39, 40-49, 50-60, >60). They were also asked to specify the level of their experience with color (none, basic, middle, or advanced) and give the information if their proper color vision was confirmed by a medical examination for driving license and/or any color tests. It was also possible to make quick tests online while filling the survey, by clicking the given links to the Ishihara test (<http://colorvisiontesting.com/ishihara.htm>) and X-rite test (<https://www.xrite.com/hue-test>).

In the second part, participants were rating on a scale from 1 to 5 (1 – definitely not, 2 – rather not, 3 – not sure, 4 – rather yes, 5 – definitely yes) if randomly presented color samples can be considered "yellow". After that, responders were asked to indicate three color samples (from all twenty eight color samples seen before) they think are most adequate for the color term "yellow".

The third part of the study was dedicated to building facades. Similarly to previous part, the respondents were asked at first to rate on a scale from 1 to 5 the level of "yellowness" of the presented building façade, which was computer-painted in one of the twenty eight selected colors. After finishing, they chose three facades, which colors they consider the most appropriate for the term "yellow". On average, to complete the survey took around 10-15 minutes.

### **Colors selection**

In order to conduct the survey, 28 colors, differing in hue, lightness (whiteness /blackness level) and saturation (chromaticness), were specified, then used to color the samples and facade of the selected building. The colors used in the survey have been chosen from NCS Color System's four yellowish color groups: G80Y, G90Y, Y, and Y10R. Authors' wish was to represent all the color families: pastel (high lightness and chroma), pale (high lightness and low chroma), vivid (highly saturated), rich (low lightness and high chroma) and finally dull (low lightness and low chroma). However, due to the fact that selected colors were to be presented also on the building façade, very dark and highly saturated colors have been eliminated from the list. Another limiting element was the number of samples for presentation. Finally, seven nuances were selected from each hue group to represent the colors that often appear on the facades of residential buildings: 0515, 0530, 0550, 1015, 1040, 2030, 3010. The author made the choice based on her experience as an architect-designer and on the knowledge of the color palettes offered by various manufacturers of facade paints and plasters. The NCS triangle was used to provide the same nuance for samples from particular hues (Figure 1a,b).

As the color samples were to be presented online, to reflect the colors of a specific notation, the NCS Colourpin Application was used, which ensures a high degree of compatibility between the appearance of the physical NCS Colour samples and the one presented on the displays of electronic devices.

Is “yellow house” really “yellow”? Survey on determining the range of perceiving the yellow color on building facades depending on the hue, lightness and chroma

### Building selection

For the rating of “yellowness” level of the facades, Njálsgata House in Reykjavik on Iceland was chosen. The building was selected because of its high ability to accept different shades and tones of yellowish hues. The house has also gray roof and neutral, almost achromatic neighborhood, which reduced possible influence of adjacent chromatic colors on the perception. For the same reason the photo was taken on a cloudy day, to avoid sun contrasts and shades, which could affect final color appearance (Figure 1c).

1a

nuance	w	s	v	c	m
0515	80	05	0,95	15	0,16
0530	65	05	0,95	30	0,31
0550	45	05	0,95	50	0,52
1015	75	10	0,9	15	0,17
1040	50	10	0,9	40	0,44
2030	50	20	0,8	30	0,37
3010	60	30	0,7	10	0,14

1c



1b

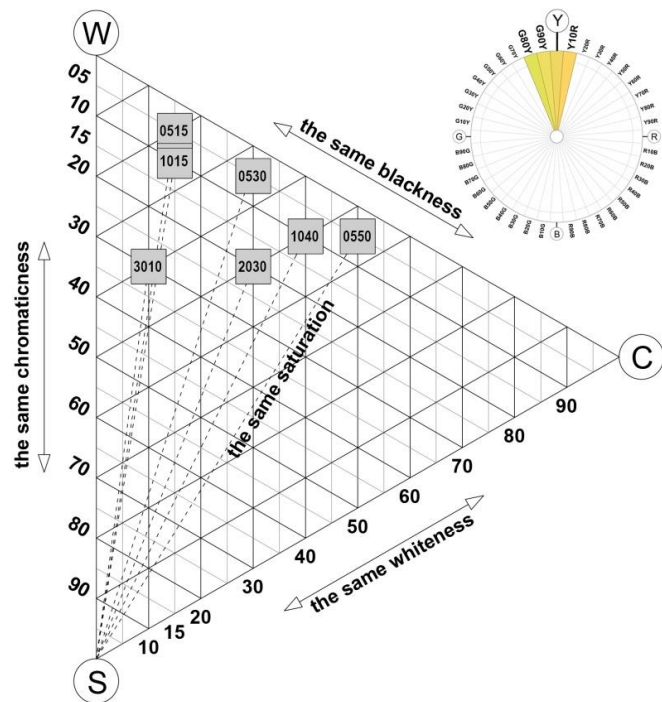

Figure 1. Selection of the colors and the building. 1a. Table with selected nuances and their parameters: s - blackness (aa), c - chromaticness (bb), w – whiteness, v – lightness, m – saturation; 1b. NCS triangle with position of the 7 selected nuances and NCS circle with selected hue groups: G80Y, G90Y, Y, Y10R; 1c. Building facade selected for colors’ presentation (<https://www.archdaily.com/923370/njalsgata-house-krads>).

### RESULTS

The results of the study were analyzed in two ways. The first part consists of the outcomes of assessing “the yellowness” of the individual 28 colors. Those results were presented in individual column charts for each of the 28 swatches and facades, and then the summary graphs for each hue group (G80Y, G90Y, Y, Y10R) were created. The second part contains the results of the color selection most appropriate for the term “yellow.” These effects were presented as horizontal bar charts, ranked from the nuances most frequently chosen to those with the slightest indications.

### Participants

The author collected the data presented in this article in May 2021 for around one month. During that period, 444 participants took part in it, 332 females (74,9%) and 112 males (25,1%). They were primarily Polish students and academic teachers from the Cracow University of Technology, Faculty

of Architecture, but also students of Industrial Design from the Cracow Academy of Fine Arts and others. More than half were in the age range 18-29 (53,3%). Next age group was 40-49 and 30-39 range with about 16% each. There were also some participants in the age range 50-60 (8%) and over 60 (4.7%), as well as few in age less than 18 (1,3%). Only 21% of the participants do not have any confirmation for their proper color vision besides their declarations. Most of the respondents (90,4%) declared some experience with color (basic – 28,1%, middle – 38%, advanced-24,3%).

### **Results of part I – The assessment of yellowness of individual colors appearance on swatches and building facades**

In the rating if presented color can be considered "yellow" (at first assessed on swatches, then on facades), the highest unanimity and percentage of "yes" responses was achieved by the nuance 0550 (highest saturation/lightness, lowest whiteness). The undisputed number one became color 0550-Y with the "yes" results equal 96.2% for sample and 98.2% for facade. The colors 0550-G90Y and 0550-Y10R achieved only slightly worse results, with the percentage of "yes" indications consistently higher for the facades (93,9%, 91,2%) than for the swatches (83,8%, 84,2%). For the 0550-G80Y nuance, a high level of the consensus occurred only for the elevation (82% to "yes"), while for sample over 50% of the responses were negative.

The highest percentage of "no" responses concerns the nuance 3010 (lowest saturation/lightness, highest blackness), which for all hues was not perceived as yellow either for the color swatches or the facades in more than 90% (in most cases, the number of the answers "rather no" and "definitely not" reached 98.9% for samples and 95% for facades).

Also for the 1015 nuance (low saturation, high whiteness), the negative responses dominated in the case of samples, changing slightly together with the hue from G80Y to Y10R (97.1% - 74.1% - 75.8% - 80.8%). In the case of facades, the responses were very diverse, except for the hue G80Y with 72% to "no." There was a slight "yes" tendency for hues G90Y and Y (53.5% -49.2%), but for Y10R the numbers of "yes" and "no" responses were nearly even.

The nuance of 2030 (average level of saturation/lightness, lowest whiteness) brought interesting results, as it existed a discrepancy in its perception between swatches and facades. There was a high percentage of the "no" answers for the samples, slowly decreasing while changing the hue (94.5% -93.5% -85.3% -77.2%). In the case of the facades, the situation was different. While for greenish yellows G80Y and G90Y, the percentage of negative responses was still significant (71.6% -52.3%), for hues Y and Y10R there were more responses to "yes" (51.9% -68.2%).

In the case of the 1040 nuance (high saturation, average blackness/lightness), the hue also played a significant role. Only for the Y there was a high "yes" percentage for both the samples (81%) and the facades (97%). Y10R hue has still high "yes" responsiveness for facades (80%), while for samples it was only 60%. For the greenish yellows of G90Y, there was still a high percentage of "yes" responses to facades (74%), but "no" responses began to dominate in the swatches (42.5%). For the G80Y, the "no" responses predominate for both the samples (80%) and the facades, although here to a lesser extent (60%).

In the case of the 0530 nuance (highest lightness, middle saturation, lowest blackness), full agreement of the "yes" responses occurred for the hues G90Y and Y, with a higher percentage observed for the facades (96%, 92%) than for the samples (77%, 72%). At the Y10R hue, a large variation in the results for the swatches was observed, together with a slight dominance of the "yes"

answers for the facades (60.5%). For the G80Y, there was a full discrepancy in the responses, with 65% "no" for the samples and 58% "yes" for the facades.

For the 0515 nuance (highest lightness/whiteness, low saturation), there was also a dissimilarity of opinions between the samples and facades assessment. Here, too, the hue played a decisive role. For the swatches, the responses were mostly negative, with the percentage of "no" gradually decreasing with the hue change from G80Y to Y10R (89%-69% -50.4% -49%). For the facades, with the change of the hue, the number of positive responses increased from 49% to "no" for the G80Y to 61% to "yes" for the shade Y10R.

### **Results of part II – The best examples of the yellow color on swatches and building facades**

The color 0550-Y was found to be the most appropriate for the term "yellow" for both the swatches (93,4%) and the facades (80.8%). Among the presented samples, it was the color with the highest level of both saturation and lightness. It also has no admixture of other primary colors (it is neither reddish nor greenish). Thus, it can be treated as a "unique hue" and the most similar color to the typical representative for the yellow color category (Witzel 2018; Schloss et al. 2020).

The colors 0550-Y10R (71% for samples and 48.5% for facades) and 0550-G90Y (52.7% for samples and 63% for facades) were second. Also, these colors are characterized by the highest saturation and lightness, but their hues have slight admixtures of red and green, respectively. The remaining color 0550-G80Y in this nuance came in a relatively high fifth place for facades (26.9%), but for the samples, it was in the ninth position with only 4.1% of the response.

The next places were colors: 1040-Y, 0530-Y, and 0530-G90Y. A small percentage of the answers were also given to the nuances 1040 and 0530 for the Y10R hue, and in the case of the facades also for the G80Y. The nuance 3010 was not indicated even once for any of the hues.

Neither for the samples nor the facades were indicated colors having both a high degree of whiteness and low saturation (0515, 1015) or low saturation and low lightness (3010). Thus, saturation was the decisive parameter in that case.

For colors with an average saturation level (0.35, 0.37) lightness and blackness were the decisive parameters. The darker nuance 2030 (brightness 0.8) was not indicated at all, while the lighter 0530 (brightness 0.95) was ranked relatively high for hues Y (28.5% samples) and G90Y (20.5% facades).

### **CONCLUSIONS AND DISCUSSION**

The analysis of the results confirmed, also emphasized by other researchers (e.g., Witzel 2018; Schloss et al. 2020; Divers 2021), the importance of saturation and lightness (the degree of whiteness/blackness) in colors appearance and naming. The attribute of saturation was the most significant when indicating adequate colors for the term "yellow" (the higher the chroma, the more often the color was chosen). Next, the decisive parameter was the degree of whiteness and blackness - colors with a high blackness or whiteness were rarely indicated as "yellow."

The research proved that a given color is likely described as "yellow" only when its parameters of lightness and saturation are similar to the prototype of the yellow color category, characterized by high saturation and high intrinsic lightness (Schloss et al. 2020). Color appearance is also typically assessed by reference to one of the unique hues (Witzel 2018). That explains why the most frequently indicated was the purest hue Y, then Y10R and G90Y, and least often G80Y. The clarity of the hue was the decisive factor, especially in the case of both highly saturated and whitened colors. The confidence of indicating "no" increased with dark and low saturated colors because both

parameters are different from the typical yellow prototype mentioned previously. In addition, dark yellows cross the color category from "yellow" to "brown" (Schloss et al. 2020), and the hues of G90Y and G80Y visually turn green.

So, there is a need to go beyond the basic color categories in the scientific research, as they do not cover the whole variability of perceived color "subcategories," depended on other than hue parameters (in case of yellowish hues this will be, e.g., when lighter: beige, darker: brown, greener: lime, redder: ochre, orange). This can be achieved by extending (but not replacing) the "hue paradigm" with the "value-chroma paradigm" (see Divers 2021). This is important particularly in environmental color design as the vast majority of nuances present in natural surroundings are not highly saturated.

The research also reveals that various nuances are more likely declared "yellow" on the façades than on the samples. This is especially evident when the swatches were rated as not yellow while the facades were still placed in the yellow category. It is known that color is perceived differently on the sample than on the facade. However, the reason for these discrepancies may also be that the color of the sample is evaluated strongly by reference to the typical yellow prototype. In contrast, for the facade, observers base their judgment more on experience and cultural traditions. Thus, the color tests and color choices, which concern particular objects (such as buildings), should not be performed only on color samples, as they may give completely different, even opposite results.

Those findings may be a starting point for a wider discussion on the actual preferences of yellowish colors for building facades and the way of describing them in the context of not only the hues but also, perhaps even above all, their lightness and saturation.

## **APPENDIX A**

Supplementary data to this article with detailed results of the study can be found online at [https://drive.google.com/drive/folders/1f5eFCWPU3F\\_MOAADmP1vvWIDbP0OYbo2?usp=sharing](https://drive.google.com/drive/folders/1f5eFCWPU3F_MOAADmP1vvWIDbP0OYbo2?usp=sharing)

## **REFERENCES**

- Divers, E. 2021. Beyond hue: the affective response to value and chroma, In: *The International Scientific Conference of the Color Society of Russia: Selected papers*, Y. A. Griber and V. M. Schindler, ed. Smolensk: Smolensk State University Press, 154-159.
- Janssens, J., and R. Küller. 2009. Preferences on colors on buildings. In: *Color for Architecture Today*. T. Porter and B. Mikellides, ed. London: Taylor and Francis, 124-127.
- Lancaster, M. 1996. *Colorscape*. London: Academy Editions.
- Pastoureau, M. 2019. *Yellow: The History of a Color*. Princeton: Princeton University Press.
- Schloss, K., Ch. Witzel, and L.Y. Lai. 2020. Blue hues don't bring the blues: questioning conventional notions of color-emotion associations. *Journal of the Optical Society of America A*, 37(5): 813-824.
- Tarajko-Kowalska, J. 2021. Yellow color in European architecture and built environment: traditions and contemporary application, In: *The International Scientific Conference of the Color Society of Russia: Selected papers*, Y. A. Griber and V. M. Schindler, ed. Smolensk: Smolensk State University Press, 319-324.
- Witzel, Ch. 2018. The role of saturation in colour naming and colour appearance. In: *Progress in Colour Studies. Cognition, language and beyond*, L. MacDonald, C. Biggam, and G. Paramei, ed., John Benjamins Publishing Company, 41-58.

# Plant transfer printing on cotton and silk

Ana Sutlović<sup>1</sup>, Martinia Ira Glogar<sup>1,\*</sup>, Ivana Padavić<sup>1</sup> and Koraljka Kovač Dugandžić<sup>1</sup>

<sup>1</sup> University of Zagreb Faculty of Textile technology 1; ana.sutlovic@ttf.unizg.hr; martinia.glogar@ttf.unizg.hr; ina.pp1996@gmail.com; koraljka.kovac@ttf.unizg.hr

\* Corresponding author: martinia.glogar@ttf.unizg.hr

## Abstract

The application of plant transfer printing on cotton and silk was investigated. The influence of pH and choice and concentration of mordants on the visual effect and on the colourfastness to washing and light was examined. The obtained colorations were evaluated spectrophotometrically ( $dE_{76}$ ) obtained by comparing the samples before and after washing and illumination. Plant transfer was carried out with the leaves of the Rosa Canina. Sodium carbonate, acetic acid and oxalic acid were chosen as pH regulators, and potassium aluminium sulphate dodecahydrate, copper(II) sulphate pentahydrate and iron(II) sulphate heptahydrate was used as mordants (metal salts). From the aspect of aesthetics and design, it is necessary to optimize the process parameters in order to achieve optimal fastness of colouration, in that way the usable properties are also ensured. The paper also presents the creative aspect of the research and shows the process of creating an interior object of original aesthetics.

**Keywords:** *plant transfer printing, eco printing, natural dyes, chlorophyll, pH influence, fastness properties*

## INTRODUCTION

Despite the overwhelming dominance of synthetic dyes in the production of dyed and patterned textiles, in the last few decades, there has been an increase in interest in rehabilitation of natural dyes usage. Considerable research is being done to analyse the chemistry of natural dyes, their binding mechanisms to textile material and colour fastness (Rungruangkitkrai and Mongkhlorattanasit 2012). In addition to their ecological acceptability, non-allergic, non toxic and non carcinogenic characteristics as well as UV protection, antibacterial and deodorizing properties, the interest in natural dyes application lays also in their well-known characteristic of producing harmonious, well-balanced, soothing and soft colour palette (Glogar et al. 2020; Arora et al. (2017). Sustainability and environmental friendliness are the challenges of today in textile production as well as in the creative industries in general. Therefore, the application of natural dyes in the processes of dyeing and printing should be observed in the context of the utilization of bio-waste as well (Ismal 2016). Although there are the significant number of scientific research and artistic works dealing with the application of natural dyes in textile dyeing processes; (Samanta et al. 2009; Shahid et al. 2013), there is still a certain gap in the field of natural dye printing. Also when it comes to dyeing or printing textiles with natural dyes, since most natural dyes belong to the group of acid-mordant dyes, their suitability is mainly for protein fibres, while cellulose fibres have the problem of insufficient dyes exhaustion and later color fastness. Therefore, it is a special challenge to examine the possibilities of applying natural dyes in printing on cotton with the necessity of researching optimal conditions and optimizing process parameters. Plant transfer printing belongs to a particularly specific category that has been very little researched, not only in the context of scientific research work but also in the context of creative application. In plant transfer printing the plant releases the pigment in its own contour. The results are not uniform colours nor uniform patterns, but unpredictable and unrepeatable patterns dictated by the plant (Ismal 2016).

Although the plant transfer printing is considered an art form, knowledge of technology as well as scientific research approach are essential given the large number of parameters that affect the end

result and knowledge of their complex interaction is crucial. Colour coordinates and fastness properties are highly affected by process parameters interaction. Optimisation of printing conditions is essential in terms of obtaining optimal colour yield on textile material.

In this paper, the influence of pH and choice and concentration of mordants on the visual effect of plant transfer prints and on the colourfastness to washing and light was examined. In the creative part of the work, a unique object of a standing lamp was made, consisting of a metal construction and a shade patterned by a plant transfer print.

## EXPERIMENTAL SETUP

### Materials and methods

Plant transfer was carried out with the leaves of the plant *Rosa Canina*. Sodium carbonate ( $\text{Na}_2\text{CO}_3$ ), acetic acid ( $\text{CH}_3\text{COOH}$ ) and oxalic acid ( $\text{C}_2\text{H}_2\text{O}_4$ ) were chosen as pH regulators, and potassium aluminium sulphate dodecahydrate  $\text{KAl}(\text{SO}_4)_2 \cdot 12\text{H}_2\text{O}$ , copper(II) sulphate pentahydrate and  $\text{CuSO}_4 \cdot 5\text{H}_2\text{O}$  and iron(II) sulphate heptahydrate  $\text{FeSO}_4 \cdot 7\text{H}_2\text{O}$  was used as mordants (metal salts). Two types of textile substrate made of natural fibres were used: cotton and silk. In the first phase, the textile material was pre-treated with pH regulators, followed by the laying of plants on the materials, with the plants pre-soaked in solutions of metal salts. Furtherly, the fixing process was performed by wrapping the material tightly and exposing it to water vapour for 120 minutes. After the fixing, the textile material was left to cool, unwrapped, the plants were removed and the material was washed and allowed to dry in the shade without direct exposure to sunlight.

The wash fastness properties was examined according to the norm EN ISO 105 - C06: 2010: Textile - Colourfastness test - Part C06: Stability of dyeing in household and commercial washing, while the light fastness test was performed by exposing the samples to sunlight in real conditions, for a period of 60 days. The location of exposure was Zagreb, Croatia (lat.: 45° N, long.: 16° E), with humid continental climate.

The obtained colorations were evaluated objectively using a remission spectrophotometer DataColor Spectra Flash 600 PLUS – CT. The results are presented as total colour difference values ( $dE_{\text{CIE76}}$ ) obtained by comparing the samples before and after washing and illumination. Colour difference values were calculated using formula (1), defining the samples before washing and illumination as reference samples.

$$dE_{\text{CIE76}} = ((dL^*)^2 + (da^*)^2 + (db^*)^2)^{1/2} \quad (1)$$

where  $dL^*$  is difference in lightness value,  $da^*$  and  $db^*$  are differences in  $a^*$  and  $b^*$  colour coordinates indicating the change in  $L^* a^* b^*$  colour space position and also indicating the change in chroma ( $C^*$ ) and hue ( $h$ ).

## RESULTS AND DISCUSSION

Tables 1 and 2 show samples of silk and cotton fabrics obtained by plant transfer printing with appropriate process parameters. Due to the specific uneven colour, for colour measurement, the measurement sites are carefully selected and marked with a red circle in the images.

pH=4 ( $\text{C}_2\text{H}_2\text{O}_4$ )	pH=5 ( $\text{CH}_3\text{COOH}$ )	pH=8 ( $\text{Na}_2\text{CO}_3$ )	pH=4 ( $\text{C}_2\text{H}_2\text{O}_4$ )
Without mordant			$\text{FeSO}_4 \cdot 7\text{H}_2\text{O}$





Table 1: Samples of transfer plant printed silk in different conditions of pH and mordanting with the marked colour measuring point (red circle)









Mordants	pH=4 ( $C_2H_2O_4$ )	pH=5 ( $CH_3COOH$ )	pH=8 ( $Na_2CO_3$ )
$KAl(SO_4)_2 \cdot 12H_2O$	 Sample 5	 Sample 6	 Sample 7
$CuSO_4 \cdot 5H_2O$	 Sample 8	 Sample 9	 Sample 10
$FeSO_4 \cdot 7H_2O$	 Sample 11	 Sample 12	 Sample 13

Table 2: Samples of transfer plant printed cotton in different conditions of pH and mordanting with the marked colour measuring point (red circle)

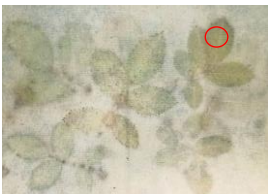
Samples show a significant influence of the pH and mordants. For silk samples (Table 1), in the acid medium (samples 1 and 2) light yellow-green shades were obtained. In alkaline medium (sample 3) darker patterns of sharper contours were obtained, which is more emphasised for patterns obtained with leaves pre-treated in iron salt solution (sample 4). For cotton samples (Table 2), the influence of metal salts of aluminum, copper and iron on the obtained coloration is visible. Aluminum salts give lighter shades on cotton (samples 5-7). With copper salts, the orange shades of medium lightness are obtained, with lower to medium chroma. This resulted in visual appearance of brown shades (samples 8-10). With iron salts, darker shades of blue, purple and grey are achieved (samples 11- 13).

In Table 3 the objective colouristic values, obtained by spectrophotometric measurement, are shown for silk and cotton samples (Table 1 and 2).



Samples	1	2	3	4	5	6	7	8	9	10	11	12	13
L*	72,83	74,32	69,19	50,29	73,38	72,26	60,08	30,69	25,15	39,84	14,05	18,28	29,38
a*	-8,07	-4,42	-2,22	6,07	4,02	3,34	6,41	20,38	19,43	17,24	2,02	2,04	2,50
b*	31,39	25,39	27,91	10,49	23,04	16,55	18,89	11,16	7,96	10,80	0,31	0,22	0,10
C*	32,41	25,77	28,00	12,12	23,39	16,88	19,95	23,24	21,00	20,34	2,05	1,69	2,50
h°	104,42	99,88	94,55	59,94	80,10	78,59	71,26	28,69	22,27	32,06	8,96	6,28	2,29

Table 3: Objective colour parameters obtained spectrophotometrically for samples showed in Table 1 and 2

The highest chromaticity (C\*) and lightness (L\*) were obtained for silk samples in acidic medium without mordants, having hues in yellow-green spectrum (h=104.42° and 99.88°). Chromophores of chlorophyll *a* and chlorophyll *b* are responsible for this effect. In alkaline medium, the hue shifts towards yellow spectrum (sample 3 h=94.55°). By mordanting with iron salts, the hues are changed from green to yellow-orange spectrum, ie h = 59.94° (sample 4). Also the values of lightness and chromaticity decrease, which results in darker shades. The results on cotton fabrics (samples 5-13) shows a significant influence of mordanting on the obtained hues. Using aluminum, yellow shades were obtained (h=71.26° - 80.10°), orange samples with copper (h=22.27° - 28.69°) and red samples with iron (h=2.29° - 8.69°). Table 3 shows that the highest lightness (L\*) is achieved with aluminum, decreases with copper, and the lowest L\* are for samples complexed with iron ions. Also, the chromaticity (C\*) values for samples mordanted with aluminum and copper are around C\*=20, while for samples mordanted with iron salts the chroma decrease obtaining values less than 2.5 which results in dark, black-gray shades. The obtained colourations are the result of the reactivity of chlorophylls - pigments responsible for green coloration in plants. Due to the chemical structure, chlorophylls are esters of dicarboxylic acid, chlorophyllin and phytol alcohol. The basic building block is a chlorine, ie a porphyrin ring with magnesium in the centre to which four pyrrole rings are attached (Figure 1).

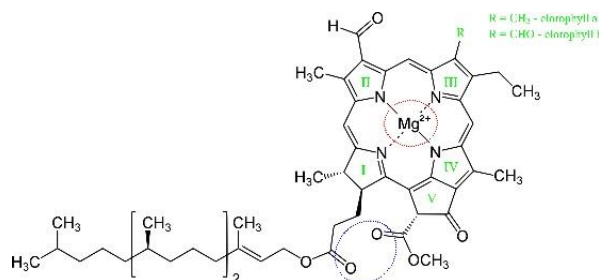

Figure 1: Chemical structure of chlorophyll

A phytol tail, which is hydrophobic and lipophilic, is attached to the porphyrin nucleus, which is hydrophilic. Chlorophylls *a* and *b*, the most important groups of chlorophylls in plants, are chemically related forms and have a characteristic green colour due to absorption in the red and blue part of the spectrum, with chlorophyll *a* being blue-green and chlorophyll *b* yellow-green. Their quantitative ratio in plants is approximately 3:1. The difference in the structure of chlorophyll *a* and *b* is on the third (III) pyrrole ring. Chlorophyll *a* at this position has a methyl group (-CH<sub>3</sub>), while in chlorophyll *b* it is an aldehyde group. Chlorophylls are extremely reactive in acidic media and magnesium is easily released and replaced with ions of other metals (eg mordants in textile dyeing), when complexes of other colours and greater resistance to textile material can occur. The reactions of chlorophyll in the alkaline medium occur outside the chlorine and the complexation of the new metal can act synergistically with

Plant transfer printing on cotton and silk the magnesium ion. In such situations, chlorophyll can be defined as a bio-wetting agent when processing textiles with natural plant pigments Darmokoesoemo, H., et al. (2017); Ahlem G. et al. (2013).

Figure 2 shows the value of the total colour difference  $dE_{76}$ , obtained by comparing the colour parameters of the samples before and after washing in a mild, neutral detergent, as well as before and after exposure to light for a period of 60 days. The colour fastness to washing and light is the result of the influence of process parameters on the reactivity of dyes, ie chlorophyll molecules, depending on the pH, mordants and textile materials. pH as a process parameter has a more significant influence on the acid-mordant dye molecule and the formation of the dye-metal ligand than on the textile material-dye system. For silk samples (1-4) and cotton samples (5-13), better stability was obtained in an alkaline medium and additionally with the use of iron as a wetting agent, while in strongly acidic medium (pH 4) a lower colour fastness is observed. The results of the colour fastness test give preference to the application of plant transfer print in an alkaline medium, ie the synergistic action of magnesium in the chlorophyll molecule (Figure 1) and the formation of ligands with iron on the aldehyde groups of the fifth (V) pyrrole ring and phytol tail.

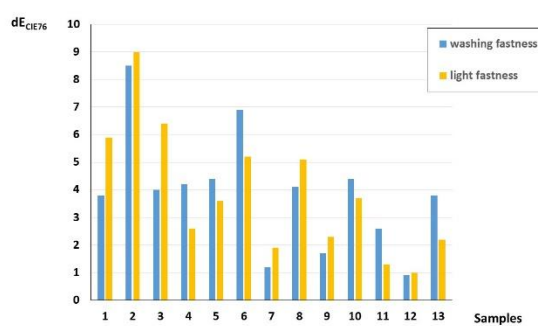

Figure 2: Values of total colour differences ( $dE$ ) regarding washing and light fastness properties

In this research, in addition to the scientific-research approach, the creative concept of application of the obtained samples was considered and a unique functional object was designed, a standing lamp, shown in Figure 3. The construction of the lamp is made of solid wire according to the project designed in the AutoCad program. For the production of lamp shadow, the textile material was patterned and processed under conditions optimized for sample 13 from the research part. In addition to wild rose leaves, a maple leaf was also used.



Figure 3: Realized standing lamp

The shade palette was obtained with range of pH adjusted with acetic acid. Also, changes in  $FeSO_4 \cdot 7H_2O$  concentrations and changes in the time of steam fixation were performed to achieve various shades. The whole composition is complemented by an additional aesthetic element - air lace.

## CONCLUSIONS

By applying plant transfer printing, a unique pattern is always obtained from the aspect of aesthetics and design, there is no possibility of obtaining identical colourations. With very small changes in process and procedure parameters, different colours are obtained. Therefore, it is necessary to optimize the process parameters according used textile material, plants, and mordants, in order to achieve optimal fastness of colouration, and in addition to aesthetic, the functional usable properties of the textile material are also ensured.

## REFERENCES

- Ahlem G. et al. 2013. First application of chlorophyll-a as biomordant: sonicator dyeing of wool with betanin dye, *Journal of Cleaner Production* 39: 97-104.
- Arora J., P. Agarwal and G. Gupta. 2017. Rainbow of Natural Dyes on Textiles Using Plant Extracts: Sustainable and Eco-Friendly Processes. *Green and Sustainable Chemistry* 7: 35-47.
- Darmokoesoemo, H., et al. 2017. Effect of Metal Ion Fe(III) on the Performance of Chlorophyll as Photosensitizers on Dye Sensitized Solar Cell, *Results in Physics* 7: 2907-2918.
- Feldberg W. 2014. Revealing the eco print: Contact dyeing with plants on textiles. *Journal of Weavers, Spinners and Dyers* 1: 17-21.
- Glogar M. I., J. Tancik, I. Brlek, A. Sutlović, and M. Tkalec. 2020. Optimisation of process parameters of Alpaca wool printing with *Juglans regia* natural dye. *Coloration technology* 136: 188–201.
- Ismael Ö. E. 2016. Patterns from Nature: Contact Printing. *Journal of the Textile Association* 77: 81-91
- Rungruangkitkrai N., and M. Mongkhorrattanasit. 2012. Eco-Friendly of Textiles Dyeing and Printing with Natural Dyes. In: Proc. 4<sup>th</sup> RMUTP International Conference: Textile & Fashion, Bangkok, Thailand, 1-17.
- Samanta, A. K., and P. Agarwal. 2009. Application of natural dyes on textiles. *Indian Journal of Fibre & Textile Research* 34: 384-399.
- Shahid M., Shahid-ul-Islam, and F. Mohammad. 2013. Recent advancements in natural dye applications: A review. *Journal of Cleaner Production* 53: 310-331.

# Practice-based research on color planning for educational facilities

Sari Yamamoto <sup>1,\*</sup>

<sup>1</sup> University of Tsukuba, Japan; y-sari@geijutsu.tsukuba.ac.jp

\* Corresponding author: y-sari@geijutsu.tsukuba.ac.jp

## Abstract

In this paper, two color plans for educational facilities are introduced and discussed. The first color plan was realized as part of a renovation of student dormitories and other facilities on campus at the University of Tsukuba. Accent colors were used in accordance with building shape and the same base colors were used for adjacent buildings. The second color plan was part of a reconstruction of facilities at the Tsuchiura Third Senior High School. Colors rarely used outdoors as accent colors were applied, enhancing the uniqueness. Each interior accent color was selected based on the image color of each special room. The resulting color schemes have been well-received by students.

**Keywords:** *color planning, color scheme, renovation, accent color, image color*

## INTRODUCTION

In this paper, the importance and effects of the color of architecture and environment of educational facilities will be discussed with case studies, which are two color plans for exteriors and interiors of educational buildings and facilities shown with images and figures.

Looking briefly at the history of color planning for buildings, color conditioning became popular after World War II, when function was emphasized (Hoshino et al. 1953), followed by demands for amenity and pleasantness (Inui 1976). These days, harmony and familiarity are becoming more important, while taking universal design into consideration. Our color planning basically follows these trends.

## **COLOR PLANNING FOR RENOVATION OF STUDENT DORMITORIES OF UNIVERSITY OF TSUKUBA**

The first case study is a renovation of dormitories and other facilities on the campus of the University of Tsukuba, Japan. Accent colors are used according to building shapes and the same base colors are used for adjacent buildings.

Part of this color plan was previously introduced (Yamamoto 2015; Komatsuzaki et al. 2016), but in this paper, the color planning process has been elaborated. Since around 2010, almost 40 years since the university opened, it has been renovating the aging dormitories one by one. The main purpose of the renovations has been to improve earthquake resistance, to repair the plumbing and other facilities, and to change building layouts to meet the changing lifestyles and requirements of the students. Exterior painting is also important for maintenance purposes, and the same colors were generally used when repainting, such as a uniform beige for the dormitories, which at best gave a calm, and at worst, a somber atmosphere. The vice president for student affairs at that time decided that the exterior colors should be changed to let others know that the building had been renovated. It became considered necessary to promote awareness of the renovation of the building and to change the uniform atmosphere.

The concepts of the color plan for the student dormitory were to create the following: “a student-like brightness”; “a warmth that makes them feel relieved to return to their dormitory”; “individuality that makes them feel the identity of their dorm building”; “harmony with the surrounding environment”; and “cohesion between adjacent dormitory buildings.”

The accent colors were carefully planned according to the particular shapes of the buildings. YR (yellowish) accent colors are actively used on convex surfaces (Figure 1 left), while other accent hues, such as PB (purple), are used sparingly in concave areas (Figure 1 right). For the foreign student dormitories, as more vitality and change was considered necessary, vivid colors were used over large areas in the concave sections (Figure 2). Interior color planning was also conducted, in which the accent color was often used for one of the four walls (Figure 3).

Feedback from students included “I feel energized,” “I feel excited,” and “I am happy to be in a stylish dormitory,” which was as hoped for and expected.



Figure 1: Exterior color planning for dormitories in the south part of the University of Tsukuba campus.



Figure 2: Exterior color planning for foreign student dormitories in the north part of the University of Tsukuba campus.



Figure 3: Interior color planning for Japanese–foreign students shared rooms at the University of Tsukuba.

### ***COLOR PLANNING FOR RECONSTRUCTION OF THE TSUCHIURA THIRD SENIOR HIGH SCHOOL***

The second color planning case study is a reconstruction of facilities at the Tsuchiura Third Senior High School, Ibaraki Prefecture, Japan. Colors that are typically not used for exteriors were used as accent colors, enhancing the originality. Each interior accent color was selected based on the image color of each special classroom.

Color planning in Japan tends to appear in the middle or at the end of the architectural design process, rather than at earlier stages. Fortunately, we could do color planning at the start of this project, and we thus decided on a basic policy of “creating an identity by creating an atmosphere that is different from other high schools, both in terms of the exterior and interior” based on architectural design philosophy. The ultimate goal was to “create a sense of attachment and pride in the school building.”

To realize the above, the following specific concepts were adopted: “create crisp and clear appearance”; “make best use of the characteristics of each special classroom”; “make the classroom layout easy to understand”; and “create a bright environment.”

For the exterior color scheme, the base color and sub-base color of the “Administration and Regular Classroom Building” and the “Special Classroom Building” were the same, and the accent colors were used separately. The accent colors for the south and north faces of the “Administration and Regular Classroom Building” are different. On the north side, 5G (green) was used as an accent color on both sides of the three-story vaulted entrance for students to create a gating effect (Figure 4). This color rarely appears in architecture, and its brightness and beauty make it stand out strongly from the white base, helping to create an identity.



Figure 4: Exterior colors for the north side of the “Administration and Regular Classroom Building,” the Tsuchiura Third Senior High School.

The interior colors of the “Special Classroom Building” are based on the following color scheme. First, theme colors associated with the subjects of the special classrooms were used as the accent colors for each room. In principle, the accent color was to be used only on the largest of the four walls of each room (Figures 5, 6).

However, as the library and audiovisual room are different from the special classrooms, different color schemes were used. The library is positioned as a key part of education, with a large collection of books, and we therefore tried to create a special space for it. The walls were almost entirely painted in red to match the color of the wood used for the bookshelves. The audiovisual room can



accommodate all six classes of the same grade, also making it a special space. To make it effective for use of a projector, a low-light achromatic color, N4 (almost black), was used for the walls.

Following the construction, the high school users were pleased that a good space had been created. Compared to other prefectural high schools, there was almost no difference in the cost of the renovation work, but the quality of the space has been highly evaluated. There have been many visitors from other high schools, and the rate of applicants to this high school is said to have increased.

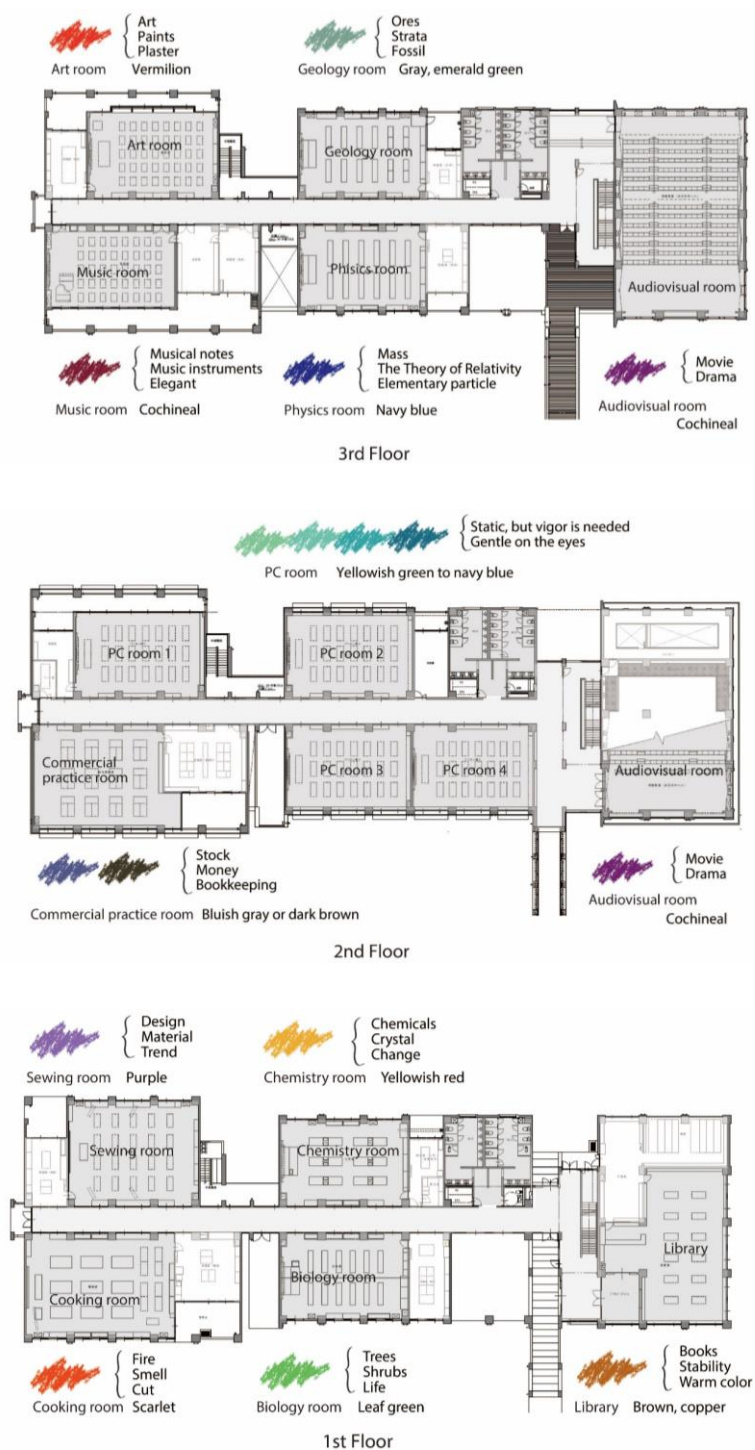

Figure 5: Image colors and image words of each special room of the Tsuchiura Third Senior High School for interior accent colors and signage.



Figure 6: Interior colors of cooking room, 1st floor of the Tsuchiura Third Senior High School.

## **CONCLUSION**

Two case studies of color planning for the renovation and reconstruction of 40-year-old educational facilities were discussed. It was shown that the color planning can give energy and brightness to the students and others.

There are many aging educational facilities in Japan and other countries. We hope that these case studies will serve as references for the renovation and reconstruction of these facilities. In addition, we believe that these examples can be used as a reference not only for educational facilities, but also for housing and apartments that are more than 40 years old, which can be found in many places in the world.

Parts of this paper refer to our previously published papers, Komatsuzaki et al. (2016), Yamamoto and Komatsuzaki (2017), Yamamoto (2021).

## **REFERENCES**

- Hoshino, S. et al. 1953. Special feature on Shikisai Chosetsu (in Japanese). *Journal of architecture and building science, Architectural Institute of Japan* 68(795): 1-30.
- Inui, M. 1976. Kenchiku no shikisai sekkei (in Japanese). Kajima Institute Publishing: 151-157.
- Komatsuzaki, R., Y. Zhuang, M. Baniani, and S. Yamamoto. 2016. Color Planning and Evaluation of University of Tsukuba Student Dormitories Overseas. *Tsukuba Global Science Week 2016 Art & Design Session Proceedings*: 29-32. <http://hdl.handle.net/2241/00144357>.
- Yamamoto, S. 2015. Case Studies of Color Planning for Urban Renewal. *Proceedings of AIC2015 TOKYO*: 113-118. [https://aic-color.org/resources/Documents/aic2015proc\\_1.pdf](https://aic-color.org/resources/Documents/aic2015proc_1.pdf).
- Yamamoto, S. and R. Komatsuzaki. 2017. Color Planning for Tsuchiura Third Senior High School: Color Planning for Educational Facilities, *Annual design review of Japanese Society for the Science of Design, Japanese Society for the Science of Design*: 78-83. [https://doi.org/10.11247/adrjssd.22.1\\_1\\_78](https://doi.org/10.11247/adrjssd.22.1_1_78).
- Yamamoto, S. 2021. Color planning for educational facilities. *THE JOURNAL OF INFORMATION SCIENCE AND TECHNOLOGY ASSOCIATION*, Information Science and Technology Association. 70(3): 107-112. [https://doi.org/10.18919/jkg.71.3\\_107](https://doi.org/10.18919/jkg.71.3_107).





# Urban color mapping in Tokyo: the case study of Hillside terrace

Asako Nakamura <sup>1</sup>, Fabrizio Ivan Apollonio <sup>2,\*</sup> and Marco Gaiani <sup>2</sup>

<sup>1</sup> Consorzio POLI.design; asako.nakamura@mail.polimi.it

<sup>2</sup> Alma Mater Studiorum University of Bologna, Dept. of Architecture; fabrizio.apollonio, marco.gaiani@unibo.it

\* Corresponding author: fabrizio.apollonio@unibo.it

## Abstract

To establish a method to clarify the color image of the city, this study explores the colors of Tokyo from two approaches. The first survey is conducted by extracting colors from aerial photographs, to investigate how the landscape in Tokyo has greyish color impression and which kind of grey it consists of. In the other examination, the changes for over thirty years in the colors and materials of the building facades are visualized in the study site, which is a group of buildings in Hillside Terrace in an area of Tokyo designed by world-renowned Japanese architects. Both macroscopic perspective and chronological microscopic viewpoints are effective to grasp the color image of the city. The visualized urban color images enable to express the mood of the city.

**Keywords:** *urban color mapping, temporal analysis, urban color visualization, multiscale analysis*

## INTRODUCTION

A city is an entity with an expansive surface, so the evaluation of the color-scape should not be based on the color of the façade of a particular building only, but on the accumulation of the past activities of the city and the memories of the people who visit it over the decades, or even more than hundred years so far. The aim of urban color mapping is to identify a method to investigate the image of urban color, analyzing it at and across a variety of spatial scales.

Urban color mapping is basically a multiscale process where relationships among the whole and the parts, between 'micro' and 'macro' levels, need to follow a first systematic mapping of the color at different scales (from the detail of a single building up to the whole city). Moreover, the color change over the time at each scale and the perceived environment is not only what our eyes see now, but the result of the actual observation filtered by our memory.

Unfortunately, methods for urban color mapping and analysis are very similar at the different scales, impeding the possibility to map the features specific of that scale and the color structure at the different scales. Time variations are annotated just as stratigraphy, avoiding the perceptual dimension. Finally, communication of color mapping is usually done using techniques coming from drafting tradition (plans, elevations, and section views in orthogonal projection) that usually is black and white and marking edges and contours. The color is added as simple attribute. This does not allow an easy analysis of the mapping outcomes and the possibility to use these results as design materials.

The paper presents some techniques to solve problems related to the observed methodological lacks. It aims to grasp the images of color in the city with focusing on façade colors and materials by three different types of analysis methods. When it comes to investigate the colors of building façades, it is not only important how color and materials themselves are specified, but also how the target building is positioned in the city-context. In this case, city-context includes the surrounding built environment, history, and culture of the city, developing process of city scape and construction technology. Then three types of results are expected:

- Extracting the comprehensive color images of the whole city,
- Specifying existing colors with the numerical values,
- Changes of color and material in sequential developing process of city scape. This methodology is highly effective to understand the positioning of the building colors in the city, which contributes to design new development as a good indicator.

Tokyo is chosen as a case study, being one of the biggest cities in the world whose short historical context was developed after the Second World War. Tokyo, in fact, allows to face the case of small color differences and neutral colors, requiring accurate color measurements to avoid errors due to imprecise results. In contrast, there are some cities in other countries where it is possible to identify a symbolic color for a city scape (i.e., Chefchaouen in Morocco, also known as the 'blue city', or Strasbourg in France, well-known for its 'reddish stone' buildings). However, from the color perspective, how should we evaluate the image of a city like Tokyo, which has a relatively short history and is so huge that it is difficult to catch the whole picture of its color on a single image? To answer this question, it is significant to visualize the differences between the image of a city and that of other cities in the world by means of color to grasp the chromatic characteristics of them.

'Hillside Terrace', a trendy neighborhood with white buildings built in Daikanyama, is chosen as a case study to examine the urban color mapping. It is, in fact, famous for the miraculously successful urban developing project over 30 years designed by the architect Fumihiko Maki (Maki 2009a).

### ***THE HILLSIDE TERRACE – TOKIO CASE STUDY***

After World War II, Tokyo developed rapidly to meet demand of housing and economic growth. As a result, unharmonized city scape, called 'scrap and build' city, has prevailed through Tokyo, making it looks, from an aerial view, almost grayish.

Daikanyama is a neighborhood characterized by a relaxed atmosphere and with a conspicuously sophisticated area of residential and commercial complex buildings: Hillside Terrace, a collective form developed over seven phases since 1969, corresponding to the continuously changing circumstances of Tokyo (Krieger 1994; Maki 2009b; Per et al. 2013). At the root of the development strategy and of the miraculous success is the question: "What does it mean to live in a city?" and "what should housing be like as urban architecture?" The aim was to create a new community through a new urban village, not just to construct a residential complex. A new kind of urban village, a low-rise, quiet, and sophisticated neighborhood that avoided the commercial and economic-driven development that had taken place in so many other areas of Tokyo. A variety of design strategies are used to create its unique atmosphere, including deference to subtle topographical changes, spatial layering, and the creation of protected exterior public space. There are several public and semi-public spaces, which are opened to the city. These public spaces hold the culture and the vibrant community of the citizens.

Based on a design concept by Maki, architectural details and materials had been varying over 30 years of development, but they still kept the modernism architecture style. Hillside Terrace color of façades is basically white (Figure 1) for three reasons. First, white is a symbol of functionalism, rationalism, and international style (Kitagawa et al. 2014). Second, to stand out the sophisticated shape without any decoration, or to enhance the texture of materials, a white façade is the best solution in terms of color meaning; white is purity and nothing (of meaning). Third, white volume is easy to recognize due to the contrast between light and shadow.

All the façades are white or whitish light gray, but there is a subtle color variation, as it represents Tokyo's scenery of built environment. Color and material of façades varied as times changed. Light gray looks much lighter or almost white by contrast with dark gray joint.

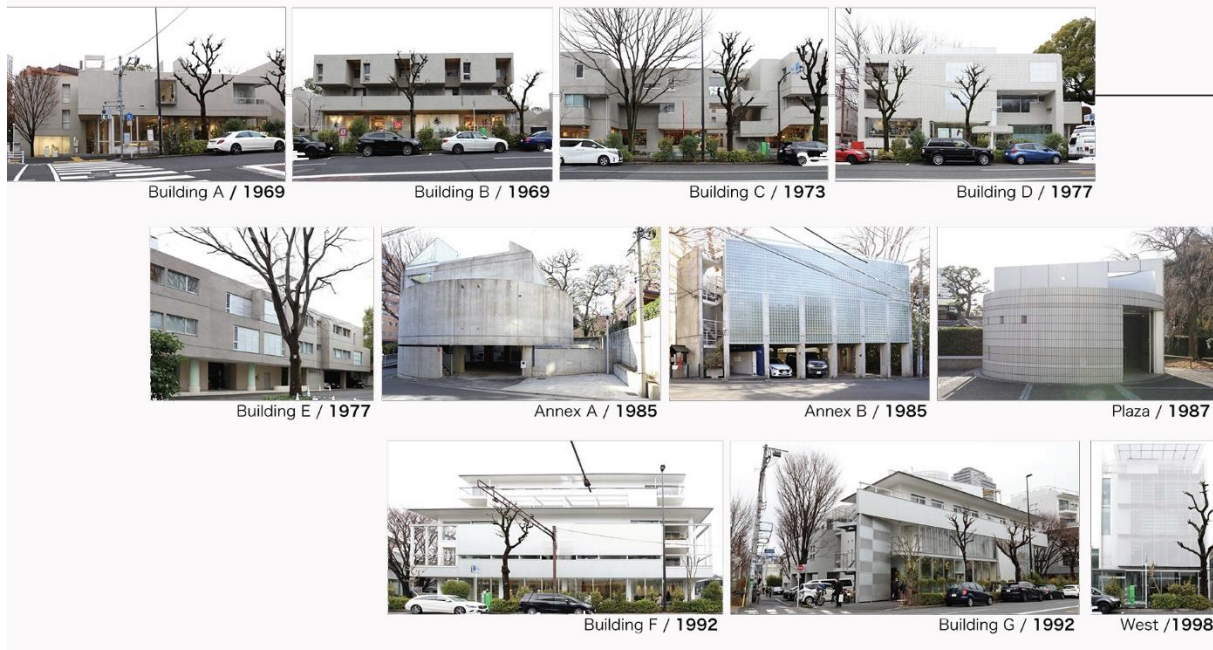

Figure 1: The Hillside Terrace Complex buildings.

## **METHODOLOGY**

In this study, two research techniques are used to analyze the color image of a city to understand the color of a large urban landscape as a surface and to analyze the city color changes over time.

The first method uses bird's-eye aerial photographs to get a collection of all the colors of a city with a wide surface area. In the case study, aerial images from Google Earth 3D are cut out from a bird's-eye angle, and the colors of the city façades are extracted to a 20 colors palette and plotted in a chart using the JPMA Standard Paint Colors, the standard color chart for paint, coatings, and related industries, published biennially by the Japan Paint Manufacturers Association (JPMA 2019) and based on the Munsell color system (Munsell 1905). In this way it is possible to make a comparison with other cities in terms of hue, value and chroma, with the aim of determining the variability of the chromatic textures which is the chromatic characteristic of the city.

The second method include two different analyses. The first one is a variant of the more classical technique of the façade color mapping and is illustrated starting from the case study of Hillside Terraces. The changes in colors and materials of the buildings are used to analyze the images stored in the memories of the city and its visitors. For the façade color survey, colors were identified and plotted in a table using again the JPMA Standard Paint Colors, using the visual colorimetric method. The survey was carried out in January in Japan during the daytime between 9:00 and 15:00, considering the differences in the color temperature of the objects surveyed due to changes in solar altitude. In addition to the color measurement, the façades were photographed and recorded using RAW data from a Canon EOS 6D SLR camera. White balance and distortion adjustments were made using Adobe Camera RAW, and the final images were rendered in the sRGB color space (Figure 2).

A chronological table of materials used was developed to show the subtle color changes along the time corresponding to changes of façade materials. Also, in this case the JPMA system was used.

Color chart

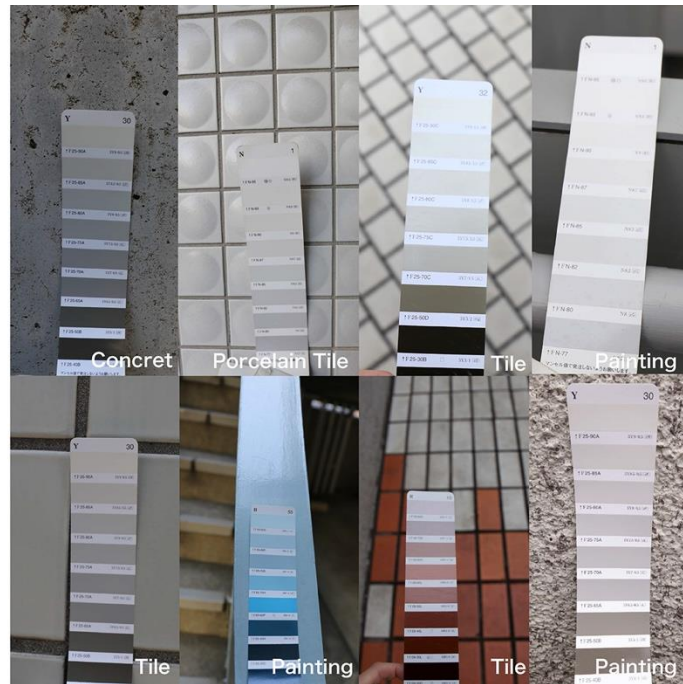
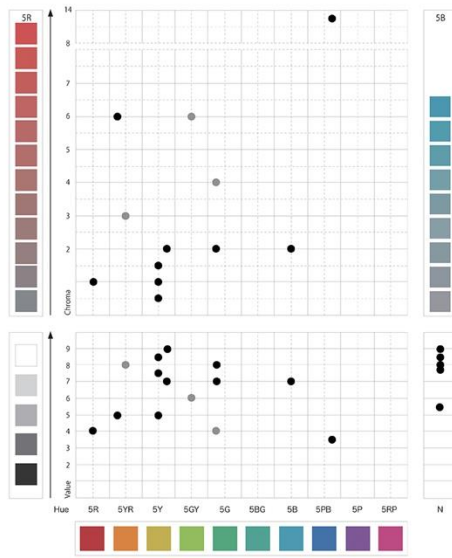

Figure 2: Material color analysis using the JPMA Standard Paint Colors.

## RESULTS AND DISCUSSION

### The macro scale approach

Color scape of the city was achieved by defocusing and sampling the aerial images. Based on the mosaic image, 20 approximate colors were extracted adopting the Pantone color chart. It is recognizable that the image of inclusive urban mood can be produced. The extensive color mapping of the city shows that the façades of Tokyo's streets do in fact contain a wide range of colors, but that most of them have a greyish tinge and the color impression of the city aggregates is greyish (Figure 3). Compared to other cities in the world, Paris is more yellowish than Tokyo, with its light grey and light beige. Rome, with its red roofs and reddish stone buildings, has a mix of mid-toned reds and greys. No other city has a color palette as close to achromatic as Tokyo. The medium to high light grey plot in Tokyo is very characteristic than the rest of the world.

### The chronological approach

The buildings on Hillside Terrace, built over the last 30 years or so, are generally white-colored (Figure 4). The white color is also one of the best solutions to accentuate the unadorned and refined architectural forms. However, when measuring the color of the façade, it can be found that each façade material has changed as the building structure and materials have evolved over time, and the colors have changed within the faintly different white and light grey. Each phase was characterized using specific materials which, albeit with small differences, led to small changes in colors over time, without detracting from the chromatic unity of the whole city. The materials have modernized with times, and the color changed from a beige-like light grey to a much lighter grey with a hint of blue. In the early years, in 1969, the façade was painted; in 1973, textured painting and tiles were used on the floor; in 1977, porcelain tiles appeared, and in 1985, glass blocks were used on the façade. In 1992, the façade was made of aluminum corrugated plates and finally in 1988, steel and aluminum screens were used on the main façade.

Urban color mapping in Tokyo: the case study of Hillside terrace



Figure 3: Color analysis of macro scale approach.



Figure 4: The temporal analysis for the Hillside Terrace Complex façade color materials.

**DISCUSSION**

From the Macro scale survey, it was visualized that the overall color image of Tokyo is more greyish than other cities in the world. In addition, the chronological approach shows that the whitish and greyish streetscape of Hillside Terrace, one of the most representative cityscapes in Tokyo, has undergone subtle changes over the past 30 years, even though all the façades are white or grey.

The colors extracted in the chronological approach are within the range variability of the colors in Tokyo extracted by the Macro scale approach, which shows as Hillside Terrace was color-designed using the Tokyo’s representative color cityscapes. The façades color of Hillside Terrace is a symbol of

the environmental color mood in Tokyo. Although there is a color uniformity throughout Hillside Terrace, since each building was built at a different time and with a variety of colors and materials on its façades brought changes to the streetscape. From this study, it is considered that this diversity of white and light grey is a characteristic of the Tokyo's color landscape.

Furthermore, the image of the city's color scheme, which is not based on individual buildings but on clusters of buildings, was not only the result of the today's new buildings hoarding, but it also considers the buildings of the past. This image of the city's colors cannot be attributed to today's factors only. The color image of a city is not a 'point' image, but a 'surface' image of the landscape, and a 'line' image through the past, which implies depth in time. In other words, it is necessary to consider past events that have a 'linear' chronological depth; this kind of research makes it possible to visualize the image of urban color (Figure 5). The image visualization of the city's colors can be seen as the visualization of the city's personality as well.

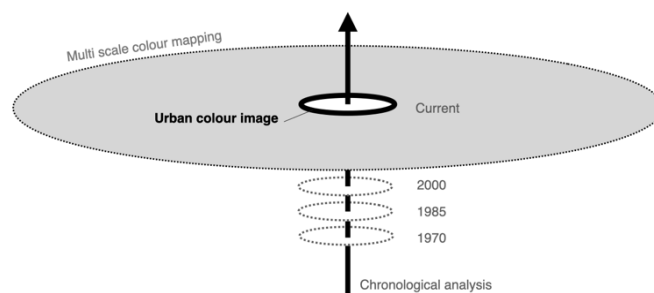

Figure 5: Concept of urban colour image.

## CONCLUSIONS

This study focuses on the establishment of a method to extract the color image of the urban landscape that is not limited to the survey of the façades for a single building. The results show that the two different approaches can be used to visualize the color image of a city over a wide area, considering the changes in the landscape over time, and to understand its color personality.

In this study, we have chosen Tokyo as the target site, but we believe that this method can be applied to other cities as well. It could be applied to the selection of colors and materials for building façades, considering the local context, and as a reference material for the preparation of landscape color guidelines by the government.

## REFERENCES

- JPMA 2019. *Standard Paint Colors 2019 K-edition*. Online: <https://www.toryo.or.jp/eng/>).
- Kitagawa, K., T. Yonezawa, and Yamanashi T. 2014. Polysemy of white in text description of buildings, *Journal of Architecture and Planning (Transactions of AIJ)* 79(698): 923-932.
- Krieger, A. 1994. Investigations in Collective Form: Maki's Quarter of a Century at Hillside Terrace, *Japan Architect* 4: 240.
- Maki, F. 2009a. *Fumihiko Maki*, London New York: Phaidon.
- Maki, F. 2009b. Fragmentation and Friction as Urban Threats: The Post- 1956 City. In Krieger, A. and Saunders W.S. eds. *Urban Design*, Minneapolis – London: University of Minnesota Press, 88-100.
- Munsell, A.H. 1905. *A Color Notation*, Boston: G.H. Ellis Co.
- Per, A.F., J. Mozas, and Ollero A.S. 2013. Hillside Terrace. Fumihiko Maki. Tokyo, 1967-1998. In: *10 Stories of Collective Housing*, Vitoria-Gasteiz, Spain: a+t research group, 322-375.



# Using artificial ground color to promote a restorative sidewalk experience: an experimental study based on manipulated street view images

Lanqing Gu<sup>1,\*</sup>, Adamantia Batistatou<sup>2</sup>, Yvonne N. Delevoye-Turrell<sup>2</sup>, Jenny Roe<sup>3</sup>, Martin Knöll<sup>1</sup>

<sup>1</sup> Technical University of Darmstadt, Department of Architecture, Chair for Urban Design and Planning; knoell@stadt.tu-darmstadt.de

<sup>2</sup> Univ. Lille, UMR 9193 - SCALab - Sciences Cognitives et Sciences Affectives; adamantia.batistatou@gmail.com; yvonne.delevoye@univ-lille.fr

<sup>3</sup> Center for Design and Health, University of Virginia; jjr4b@virginia.edu

\* Corresponding author: lanqing.gu@tu-darmstadt.de

## Abstract

Color is frequently used in urban outdoor spaces, but little research has studied its psychological effects. This study explores the influence of sidewalk floor color on the restorative walking experience in a busy, inner city street lacking natural greenery. We used an achromatic street view image with no vegetation or trees as control. Red, green, and blue were used as “artificial” intervention colors in the sidewalk ground plane to generate 3 visual stimuli. Participants (n=66) rated the perceived restorativeness of the scene and their subjective mood on viewing each image via an online survey. The results indicate “artificial” green ground color, e.g. provided by paint or colored material, promoted a more restorative walking experience enhancing hedonic tone and arousal and increased relaxation more than red ground color. All three color-interventions improved perceived restorativeness and arousal. This study advances the understanding of the psychological impact of color in urban design.

**Keywords:** *Urban design, psychology, walking environment, perceived restoration, ground color*

## INTRODUCTION

In the built environment, colors have been used in various situations and the psychological effects of colors include effects on happiness, relaxation, and arousal (Güneş and Olguntürk 2020; Akers et al. 2012). However, most of these studies look at interior space; little research has focused on the psychological effects of colors in outdoor urban environments. Walking in a lacking-greenery urban environment with historical elements and various architectural features can be restorative as walking in a natural environment (Lindal and Hartig 2013; Karmanov and Hamel 2008). Restorative environments are the settings that facilitate recovery from mental fatigue or stress and elicit positive affective states. *Attention Restoration Theory* (ART) (Kaplan 1992) posits the 4 properties of a restorative environment: being away (being mentally away from daily routine which leads to mental fatigue), fascination (being attracted by fascinating stimuli in environment that employ our involuntary attention), extent (the environment is large enough to form “a whole different world”) and compatibility (the actions required by the environment fit with an individual’s inclinations). Being away and fascination were selected to be the metrics in this study. Sidewalk ground surface plays an important role in the walking experience, as it has the direct, tactile contact with users and its features could affect user’s perception and behavior (Van Cauwenberg et al. 2016). However, no study has explored the effects of sidewalk ground color on mental wellbeing even colors have been extensively applied in transport projects to demark zones and convey information. We argue that there is a need to pay more attention to using color intervention (e.g., applying paint) in urban design to improve place quality, as it is more economical, feasible, and effective compared to other design approaches (e.g., urban vegetation). In this study, we aim to use manipulated street view images to examine sidewalk ground color’s effect on perceived restorativeness and affective wellbeing in an urban street scene



lacking natural greenery. We tested the effects of red, green, and blue, which are most frequently applied in color psychology research. In previous studies, red increases arousal (Wilms and Oberfeld 2018), while green and blue are linked with positive emotional states such as hedonic tone (e.g., increased relaxation and happiness) (Bellizzi and Hite 1992; Wexner 1954). Based on these findings, we developed the following hypotheses for this study:

- H<sub>1</sub>: Green sidewalk ground color is associated with a higher perceived restorativeness compared to other colors.
- H<sub>2</sub>: Red sidewalk ground color is associated with higher arousal compared to blue, green and control (achromatic) color conditions.
- H<sub>3</sub>: Green and blue sidewalk ground colors are associated with increased hedonic tone compared to red.

## **MATERIALS AND METHODS**

### **Participants**

All the participants were enrolled by online recruitment advertisement. In total, 66 participants completed the survey. Among them, 42 were females. The mean age was 26 (SD=4.6). All data collected were anonymous.

### **Stimuli**

We used manipulated street view images to simulate a walking environment. The street view was selected from Rheinstrasse, Darmstadt, an inner-city arterial street including 4 lanes for cars, a tram and bus corridor in the center, green buffers, and cycle and pedestrian infrastructure. It would, in our view, best represent Rheinstrasse as a typical arterial street in a medium sized European city. The street view photo was taken on an overcast winter day. Then, we used the image with major greenery removed as the control condition. Following this, we edited the sidewalk ground color by Photoshop with red (255, 0, 0), green (0, 128, 0), and blue (0, 0, 255), which are additive primary colors in the RGB color model. The intervention design was following the results from a visual realism test among 12 participants: the ground was covered by 40% transparency color with a white outline to demark the zone. Finally, 4 images were included for the study: control, red, green, and blue (Figure 1).



Figure 1: Control condition and red, green, and blue sidewalk ground color interventions.

### **Measurements**

Subjective mood states measures comprised hedonic tone, arousal, and relaxation. The mood assessments were conducted before exposure to image stimuli and after watching each image to measure mood change. The statement for each mood item was rated on a 9-point Likert scale (from 1 = “extremely disagree” to 9 = “extremely agree”). The three statements were: Hedonic tone: “I feel happy”; Arousal: “I feel energetic”; Relaxation: “I feel calm”.

Perceived restorativeness is measured by the Perceived Restorativeness Scale – short version (PRS scale) (Berto 2005). Two statements corresponding to “fascination” and “being away”, which are two

restorative properties of the environment in ART, were rated on a 9-point Likert scale (from 1 = “extremely disagree” to 9 = “extremely agree”). The statements were re-edited for the walking context (Fascination: “This place is fascinating and it is hard to be bored”; Being away: “Spending time here gives me a break from my day-to-day routine”).

## Procedure

All participants were required to do the online survey with a computer screen. They were first asked to standardize the screen settings regarding color, gamma, brightness, and contrast. After this, they did an online color blind test and the participants who did not pass it were excluded from the study. Then, the participants assessed their subjective mood state to create the baseline. Following this, the participants were shown 4 street view images in randomized order. They were asked to watch each image for at least 10 seconds to immerse themselves in the environment and then rate the street view image on perceived restorativeness and subjective mood state. Finally, they were asked to provide information about gender, age, and familiarity with Rheinstrasse.

## RESULTS

Mood change scores were obtained by subtracting baseline score from post test score after viewing each image. A series of repeated measures ANOVA were used to identify significant differences in mood change scores and PRS ratings between intervention conditions. Partial eta squared was used to present effect sizes for each comparison. Mauchly’s W test of sphericity was significant in the hedonic tone, fascination and being away conditions, and sphericity is assumed in other conditions. The Greenhouse Geisser correction was used to report adjusted degrees of freedom for the hedonic tone, fascination and being away outcomes. We used an alpha level of .05 for all statistical tests.

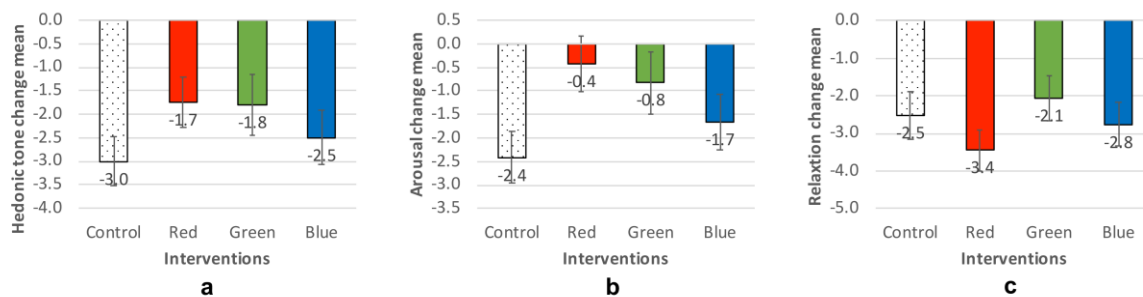

Figure 2: Hedonic tone change (a), arousal change (b) and relaxation change (c) per intervention. Error bars are shown (95% confidence intervals). A bar below zero denotes negative change and a bar above zero positive change. A higher score in hedonic tone indicates more perceived happiness; a higher score in arousal indicates more perceived energy; a higher score in relaxation indicates less perceived stress.

## Mood change

### *Hedonic tone change*

A repeated measures ANOVA showed a statistically significant difference in hedonic tone change between the red, green, blue and control sidewalk ground color interventions,  $F(2.550, 163.174) = 9.714, p < .001, \eta_p^2 = .132$ . The Bonferroni correction confirmed that the red and green sidewalk ground color interventions increased hedonic tone as compared to the control condition ( $p < .001$ ). The green sidewalk ground color intervention enhanced hedonic tone as compared to blue ( $p = .008$ ). No significant differences were found between the other conditions (Figure 2a and Table 1).

### Arousal change

There was a statistically significant difference in arousal change between the stimuli,  $F(3, 192) = 25.361$ ,  $p < .001$ ,  $\eta_p^2 = .284$ . The Bonferroni correction shows confirmed that the red, green, and blue sidewalk ground color interventions enhanced arousal as compared to the control condition ( $p < .001$ ,  $p < .001$ , and  $p = .021$ , respectively). The red and green interventions increased arousal when compared to the blue intervention ( $p < .001$  and  $p = .005$ , respectively). No significant differences were found between the red and green interventions (Figure 2b and Table 1).

### Relaxation change

There was a statistically significant difference in relaxation change between the stimuli,  $F(3, 192) = 7.348$ ,  $p < .001$ ,  $\eta_p^2 = .103$ . The Bonferroni correction confirmed the red sidewalk ground color intervention decreased relaxation as compared to the control condition and green sidewalk ground color intervention ( $p = .033$ , and  $p < .001$ , respectively). No significant differences were found between the other conditions (Figure 2c and Table 1).

Intervention	M (SD)		
	Hedonic tone	Arousal	Relaxation
Pre intervention	6.3 (2.33)	5.6 (3.1)	6.8 (2.7)
Post control	3.3 (2.7)	3.2 (2.8)	4.2 (5.0)
Post red	4.3 (3.5)	5.2 (4.2)	3.3 (3.7)
Post green	4.7 (3.2)	4.8 (3.2)	4.7 (4.1)
Post blue	3.8 (3.6)	4.0 (3.5)	4.0 (4.4)

Table 1: Mean value with standard deviations (SD) in subjective mood state assessment pre and post stimuli.

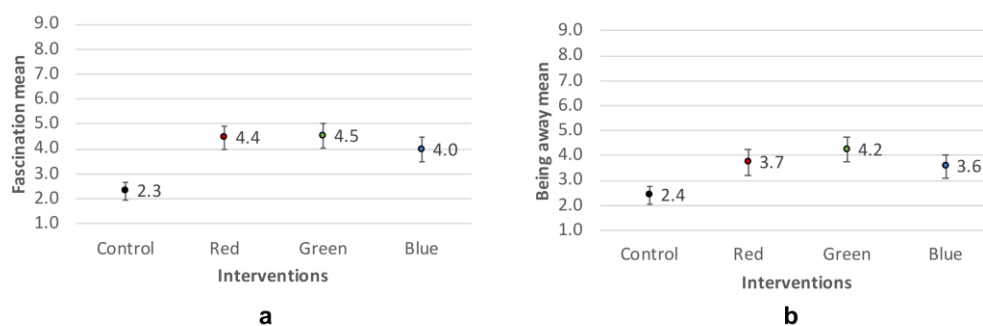

Figure 3: Mean rating scores of fascination (a) and being away (b) per intervention. Error bars are shown (95% confidence intervals). A higher score denotes higher perceived fascination and sense of being away.

### Perceived Restorativeness

#### Fascination

There was a statistically significant difference in perceived fascination between the stimuli,  $F(2.647, 169.377) = 34.128$ ,  $p < .001$ ,  $\eta_p^2 = .348$ . The Bonferroni correction showed that all ground color interventions were perceived as more fascinating than the control condition ( $p < .001$ ). The differences between the other conditions were not significant (Figure 3a).

### *Being away*

There was a statistically significant difference in perceived being away between the stimuli,  $F(2.619, 167.600) = 20.652$ ,  $p < .001$ ,  $\eta_p^2 = .244$ . The Bonferroni correction showed that all ground color interventions were perceived as more being away than the control condition ( $p < .001$ ). The green sidewalk ground color intervention was perceived as more being away than blue ( $p = .021$ ). The differences between the other conditions were not significant (Figure 3b).

## **DISCUSSION**

Our findings are generally consistent with previous literature findings as well as our hypotheses. Firstly, our results confirmed the positive effects of green color on psychological responses: the green sidewalk ground color intervention enhanced the perceived restorativeness of the street environment (i.e., being away and fascination) when compared to the control condition. The green intervention scored higher in hedonic tone and arousal as compared to the blue intervention and improved relaxation as compared to the red intervention. These findings are in line with  $H_1$  and partly with  $H_3$  and consistent with previous studies on the association between green color and positive emotions (Kaya and Epps 2004). Secondly, we observed the red sidewalk ground color enhanced energetic arousal when compared to either the control condition or blue intervention, which is generally in line with  $H_2$ , reaffirming the association of red environment with high arousal (Wilms and Oberfeld 2018). To our knowledge, these findings are for the first time shown with stimuli displaying urban street environment.

We also found that all the color interventions increased perceived restorativeness and arousal as compared to the control condition. The findings implicate that ground color interventions such as paint and colored surface material can enhance restorative quality, especially those lacking greenery, architectural variation, and cultural heritage. For arousal, green and red increased arousal more than blue, but no significant difference between green and red was found in this study, while some research show that red is associated with higher arousal, followed by green (Wilms and Oberfeld 2018). But our study embedded color in a real urban environment, while most studies on color and emotion used color stimuli without connections to reality (Kueller and Mikellides 1993) or in interior spaces. This finding suggests that psychological effects of color may vary with experiment scenes.

We observed that color interventions caused negative change on subjective mood states compared to that measured in a baseline test, which is different from previous studies. In this study, two-thirds of the participants had been to the selected street – Rheinstrasse, which is an inner-city arterial street in Darmstadt with a high traffic flow and noise. Traffic has been shown to be a negative element that decreases place quality related to mental wellbeing (Bornioli et al. 2018). Participants might associate their real walking experience when rating, which leads to negative affective changes. Despite the visual realism test, such large area monochromatic interventions are not common in urban environments, and we speculate that visual stimuli beyond daily experience may lead to negative mood changes. In addition, blue was not found to be associated with increased hedonic tone but slightly increased energetic arousal. These findings again suggest that the psychological responses to color embedded in a real environment will be different from those produced by color stimuli alone.

## **CONCLUSION**

This study reveals that in the urban street setting lacking greenery, green sidewalk color contributed to a more restorative walking experience and enhanced hedonic tone and energetic arousal. It also increased relaxation more than red. In addition, interventions with all three colors – red, green, and

blue – improved perceived restorativeness and arousal in a street that lacks natural greenery. The green and red interventions enhanced energetic arousal more than the blue intervention.

The findings suggest that ground color interventions have the potential to be a further effective means of optimizing urban environmental qualities related to mental wellbeing, in addition to inserting much-needed natural green, as a complementing, cost-effective, and temporary response to streets that lack trees. The study provides a preliminary empirical basis for future urban outdoor space design.

## **ACKNOWLEDGEMENTS**

This study is funded by Deutsche Forschungsgemeinschaft (DFG). Project number 437818133.

## **REFERENCES**

- Akers, A., J. Barton, R. Cossey, P. Gainsford, M. Griffin, and D. Micklewright. 2012. Visual Color Perception In Green Exercise: Positive Effects On Mood And Perceived Exertion. *Environmental Science & Technology* 46 (16): 8661-8666.
- Bellizzi, J. A., and R. E. Hite. 1992. Environmental Color, Consumer Feelings, And Purchase Likelihood. *Psychology And Marketing* 9 (5): 347-363.
- Berto, R. 2005. Exposure To Restorative Environments Helps Restore Attentional Capacity. *Journal Of Environmental Psychology* 25 (3): 249-259.
- Bornioli, A., G. Parkhurst, and P. L. Morgan. 2018. Psychological Wellbeing Benefits Of Simulated Exposure To Five Urban Settings: An Experimental Study From The Pedestrian's Perspective. *Journal Of Transport & Health* 9: 105-116.
- Güneş, E., and N. Olguntürk. 2019. Color-Emotion Associations In Interiors. *Color Research & Application* 45 (1): 129-141.
- Kaplan, S. 1992. The Restorative Environment: Nature And Human Experience. In: D. Relf (Ed.): *The Role Of Horticulture In Human Well-Being And Social Development*. Portland: Timber Press, pp. 134-142.
- Karmanov, D., and R. Hamel. 2008. Assessing The Restorative Potential Of Contemporary Urban Environment(S): Beyond The Nature Versus Urban Dichotomy. *Landscape And Urban Planning* 86 (2): 115-125.
- Kaya, N., and H. H. Epps. 2004. Relationship between color and emotion: A study of college students. *College student journal* 38: 396-405.
- Kueller, R., and B. Mikellides. 1993. Simulated studies of color, arousal, and comfort. In: R.W. Marans, and D. Stokols, D. (Eds): *Environmental simulation*. Boston: Springer, pp. 163-190.
- Lindal, P.J., and T. Hartig. 2013. Architectural Variation, Building Height, And The Restorative Quality Of Urban Residential Streetscapes. *Journal Of Environmental Psychology* 33: 26-36.
- Van Cauwenberg, J., I. De Bourdeaudhuij, P. Clarys, J. Nasar, J. Salmon, L. Goubert, and B. Deforche. 2016. Street Characteristics Preferred For Transportation Walking Among Older Adults: A Choice-Based Conjoint Analysis With Manipulated Photographs. *International Journal Of Behavioral Nutrition And Physical Activity* 13 (1): 1-17.
- Wexner, L.B. 1954. The degree to which colors (hues) are associated with mood-tones. *Journal of applied psychology* 38: 432.
- Wilms, L., and D. Oberfeld. 2017. Color And Emotion: Effects Of Hue, Saturation, And Brightness. *Psychological Research* 82 (5): 896-914.

# Aesthetic Evaluation of Façade Integrated Coloured Photovoltaics Designs-an International Online Survey

Changying Xiang<sup>1,\*</sup> and Barbara Szybinska Matusiak<sup>1</sup>

<sup>1</sup> Department of Architecture and Technology, Norwegian University of Science and Technology, Trondheim, Norway; changying.xiang@ntnu.no; barbara.matusiak@ntnu.no

\* Corresponding author: changying.xiang@ntnu.no,

## Abstract

Façade Integrated Photovoltaics (FIPV) is a promising way to utilize solar energy and to reduce GHG emission in the built environment. However, to the authors knowledge, the colour design of façade integrated photovoltaics has not been studied scientifically yet. The authors developed a theoretical pixelization design method for generation of colour designs for façades with integrated photovoltaics, in which local urban NCS colour palette and colour harmony strategies are used. The city of Trondheim in Norway acts as a backdrop for the study, and two main façade prototypes (multi-story and high-rise building) are derived from the Trondheim's urban context. To test the method, an online international survey has been carried out.

In the first part of the anonymous survey, participants' general attitudes towards FIPV, and their basic information was collected. In the second part, participants were asked to evaluate the aesthetics of two façade prototypes having a pixelization FIPV design, on a 5-step semantic differential scale. Besides, participants were asked to choose the most preferred one among pixelization and non-pixelization façade designs. In the third part, the urban integration levels of pixelization design proposals for real buildings were evaluated with the same 5-levels semantic differential scale.

Nearly half of the total 309 participants were 'experts' with education or working experience in architecture, urban design, or fine arts fields, while the remaining participants were 'laypersons' i.e. without related backgrounds. The survey results show a general preference for the aesthetic qualities of presented pixelated FIPV designs. Also, the presented pixelated FIPV designs are perceived well integrated into urban contexts by the majority of participants. In addition, laypersons tend to rate the presented pixelated FIPV proposals with higher scores in both, aesthetic quality evaluation and contextual coherence evaluation.

**Keywords:** *Aesthetic evaluation, NCS colour, FIPVs, online survey, pixelization*

## INTRODUCTION

Buildings are the largest energy consumption sector which account for one-third of the global energy usage and greenhouse gas (GHG) emission (International Energy Agency, 2013). Façade integrated photovoltaics (FIPV) is a strategy to harvest renewable solar energy on-site leading to the reduction of GHG emission. Most of the precedent studies are focusing on technical aspects like energy productivity (Xiang and Matusiak, 2019). However, many of the new FIPV are not appreciated by people cause of the traditional black or dark blue with low lightness coloured PV panels exposed on building facades. There is urgent need to develop architectural methods to promote the application of FIPVs in urban context. The authors developed a novel theoretical pixelization design method for generation of colour designs for façades with integrated photovoltaics. Pixelization design can be found in artistic works like Neo-Impressionism paintings. Architects can also use this concept as architectural language to create desired façade images. This pixelization method utilized orders of colours, allows moderate complexity for FIPV design and enables even covering of facades of existing buildings in accord with the historical significance and local identity.

**CASE STUDY OF TRONDHEIM CITY**

Figure1: Colourful historical warehouses in the traditional city center of Trondheim (by author).



Figure 2: Colour palette of Trondheim, from Angelo and Booker (2018).

Trondheim city in Norway acts as a backdrop of the pixelization study and online survey. Trondheim is the third largest city in Norway and nowadays it is a city where history and modern development meet. In the traditional central area, a large number of historical buildings (Figure 1) situated alongside the Nidelva river with colourful wooden facades are very much appreciated by the citizens as the most important urban tissue representing the identity of the city (Figure 2). Generally, the age of buildings decreases with the distance from the city.

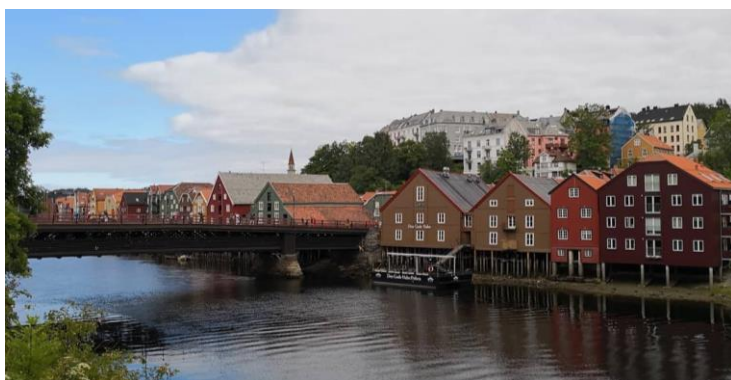
In building typology aspect, the typical building typologies of Trondheim has been investigated based on materials from Trondheim's archive, literature of local urban heritage and contemporary urban morphology (Lobaccaro et al., 2017; Arkivsenteret, 2020), and two facade typologies have derived for FIPV design with pixelization method. One façade prototype geometry was generated with respect of the traditional warehouses in Trondheim center (Figure 3). The second facade prototype represented a typical high-rise apartment block located outside the traditional city center (Figure 5).

In colour design aspect, colour harmony concepts together with the colour palette of Trondheim context (Angelo and Booker, 2018) have been used as guidance. Colour harmony is one of the key criteria for aesthetic preference and the colours of integrated photovoltaics should be in harmony with the rest of the building (Femenias et al., 2017). Westland et al. (2013) summarized four common schemes of colour harmony theories represented in many art and design textbooks with reference to hue circles: Monochromatic harmony (colours in the same or similar hues), analogous harmony (colours in similar hues), complementary colour harmony (opposite colours on a hue circle) and split-complementary harmony (one colour and the two colours on either side of its complementary colour). In The Norwegian colour standard NCS systems, it is suggested that compositions of colours with similarity in one or more of colour attributes (e.g. hue, chromaticness, nuance, blackness etc.) also tend to be more highly appreciated (more harmonious) than others (NCS, 2019). In this study, the following colour harmony strategies, together with the same chromaticness strategy were employed to serve FIPV colour design.

- Monochromatic colour harmony strategy
- Analogous colour harmony strategy
- Complementary and Split complementary colour harmony strategy
- Colour combination with the same chromaticness



A series of colour combination sets (figure 4 and 6) were developed for detailed FIPV design proposals, which were tested in the online survey.

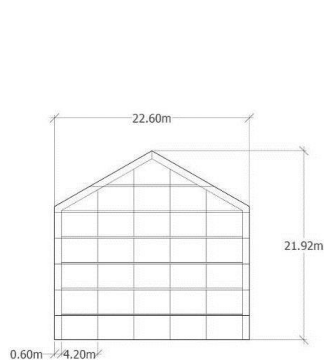

Figure 3: Façade prototype for multi-story buildings.

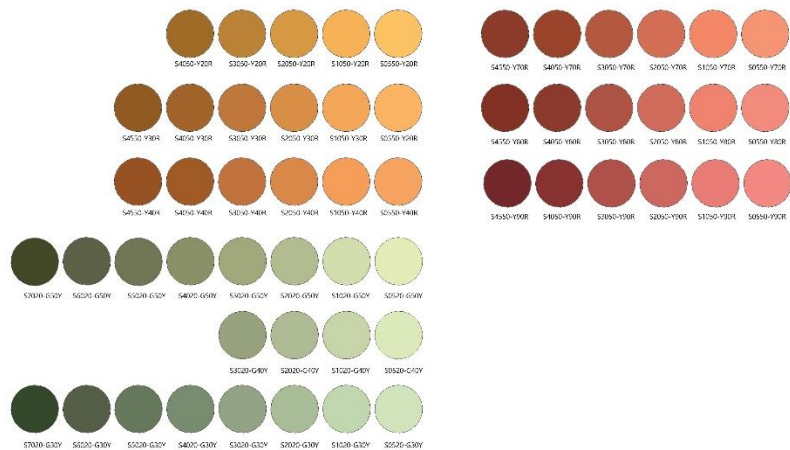

Figure 4: Colour sets for FIPV colour design, for multi-story buildings in sensitive city center in Trondheim.

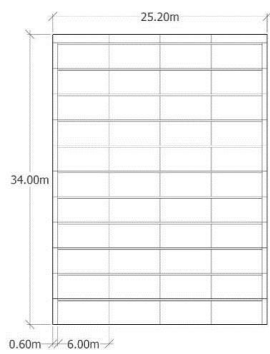

Figure 5: Façade prototype for high-rise buildings.



Figure 6: Colour sets for FIPV colour design, for high-rise buildings outside traditional city center of Trondheim.

### ONLINE SURVEY AND RESULTS

To examine the proposed theoretical pixelization method in this study and to test the research hypothesis: “1. pixelization design can provide aesthetically preferred façades, 2. pixelization method can provide FIPV designs that are harmoniously integrated into the urban co eligible for the study. This online survey consisted of three main parts and was developed based on the online survey platform Google Form. In the first part, participants’ general attitudes towards FIPV and the basic information like gender, ages, professional background were collected.

The second part of this survey, the hypothesis that pixelization design can provide aesthetically preferred façades was tested through a series of questions with façade prototype photos: firstly, participants were invited to evaluate the overall aesthetic of derived façade prototype (without colours) of multi-story and high-rise buildings in Trondheim, on a 5-level semantic differential scale rating from “Very good”, “Good”, “Fair”, “Poor” to “Very Poor” (e.g. Figure 6-Question 13: Here is a prototype of a facade geometry for a high-rise building, how do you evaluate its overall aesthetics?). Then pixelated FIPV designs for the corresponding building prototype with NCS colours in monotonous hues of Y30R was presented and evaluated with the same 5-level semantic differential scale (e.g. Figure



7-Question 14: The prototype has been covered by coloured photovoltaics with slightly varied nuances, how do you evaluate its overall aesthetic now?).

13. Here is a prototype of a facade geometry for a high-rise building, how do you evaluate its overall aesthetics?

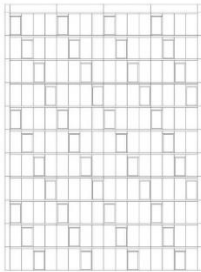

Very good  Good  Fair  Poor  Very poor

Figure 6: Preference evaluation of high-rise facade prototype.

14. The prototype has been covered by coloured photovoltaics with slightly varied nuances, how do you evaluate its overall aesthetic now?

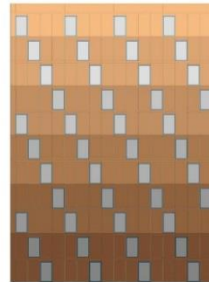

Very good  Good  Fair  Poor  Very poor

Figure 7: Preference evaluation of pixelated FIPVs design for high-rise facade prototype.

In addition, the participants were asked to choose their most preferred ones among the pixelated FIPV designs and non-pixelated FIPV designs (figure 8-question 15).

15. Which facade do you like best? \*

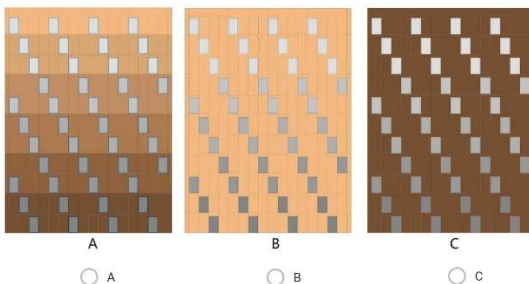

A  B  C

Figure 8: Preference evaluation of pixelization and non-pixelation design, high-rise design.

On the photo below, inside the reddish dash frame, is another similar case in the center of Trondheim, located also by the river. Please answer the following question 18 and question 19.



Figure 9: Selected traditional wooden warehouse for FIPV design.

In the third part, participants were asked to evaluate both the context coherence/integration performance and façade aesthetic performance of pixelization design proposals for real buildings in Trondheim, using the same 5- levels semantic differential scaling. (e.g. Figures 9-11).

18. Here is the new proposal with greenish photovoltaics, please evaluate the coherence between the facade and the surrounding?



Very good  Good  Fair  Poor  Very poor

Figure 10: Contextual integration evaluation.

19. How do you evaluate the aesthetic of the facade itself? \*



Very good  Good  Fair  Poor  Very poor

Figure 11: Preference evaluation of FIPV design.

In total 309 participants participated in this survey, among them around 58% participants were 'laypersons' without education or working experience in architecture, urban design or fine arts related backgrounds. Microsoft Excel were used to analyse the data. 5- scale numerical rating was applied for

corresponding aesthetic quality levels/contextual coherence levels: 1=Very poor, 2=Poor, 3=Fair, 4=Good, 5=Very good. A mean value above 3 can be viewed as the design is generally preferred by participants or that it is coherent with the surrounding context. Results were found from the analysis:

1. For two façade-prototypes, the pixelated FIPV designs were more preferred than non-pixelated FIPV designs when they have the same or similar hues (Figure 12).
2. The presented pixelated FIPV designs were perceived well integrated into urban contexts
3. Participants showed a general aesthetic preference towards the pixelated FIPV designs.
4. Visiting experience with the city center in the past ten years was not an influential parameter of context integration and façade aesthetic evaluation (Figures 13-14).
5. Both genders share similar trend in context integration and aesthetic evaluation (Figure 15).
6. Both the context integration and façade aesthetic performance of FIPV design proposals were more preferred by layperson group, compared with expert group (e.g. Figure 16).

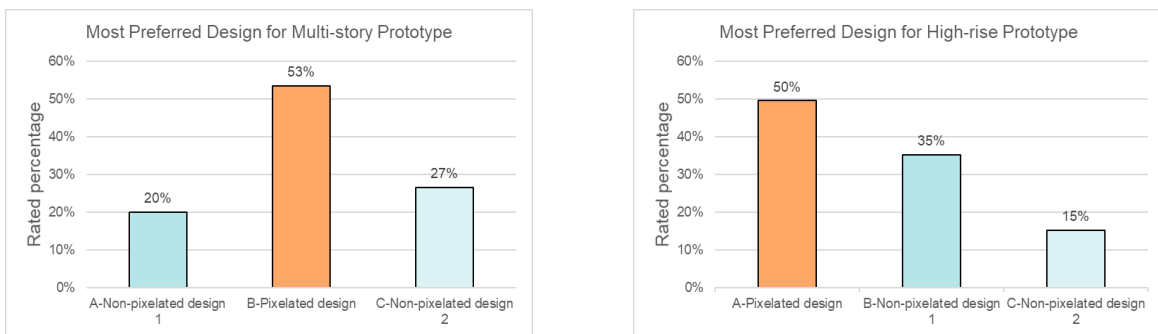

Figure 12: Aesthetic performance, Pixelization design VS non-pixelated designs for two building prototypes.

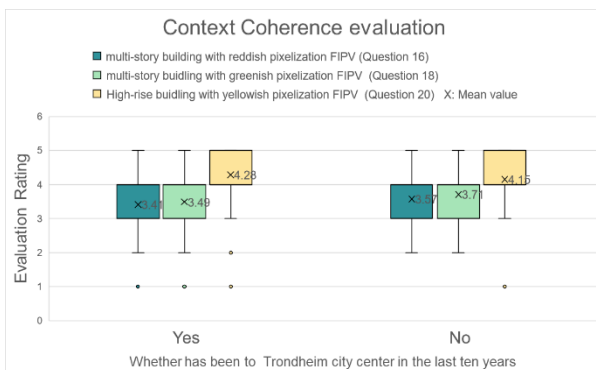

Figure 13: Context coherence evaluation analysis.

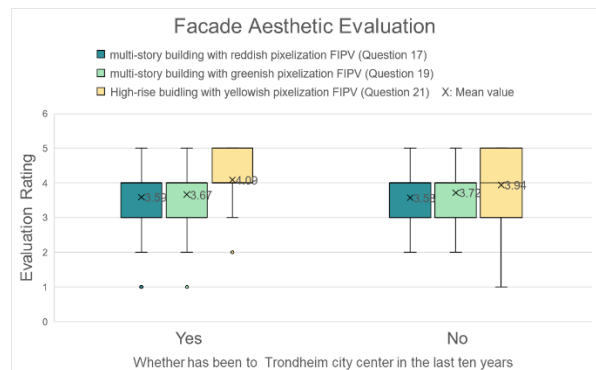

Figure 14: Façade aesthetic performance analysis.

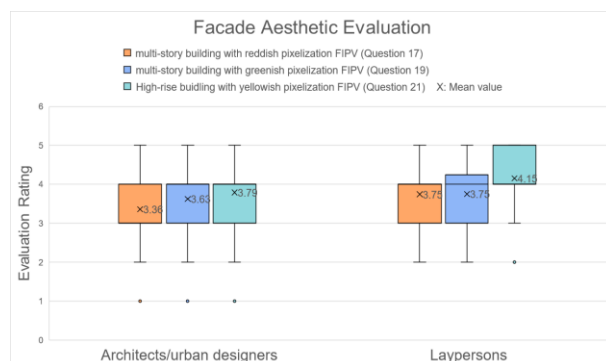
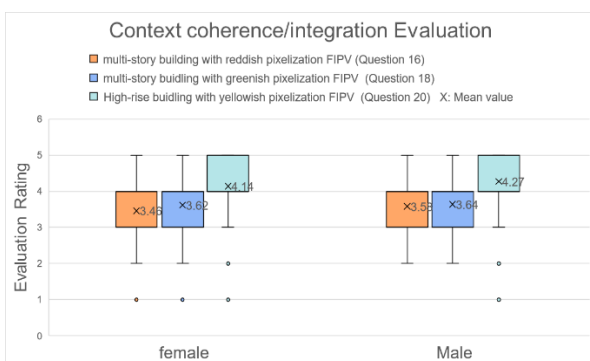

Figure 15: Context coherence evaluation analysis.

Figure 16: Façade aesthetic performance analysis.

## **DISCUSSION AND CONCLUSION**

The survey result provided evidence to support the two hypotheses: 1. pixelization design can provide aesthetically preferred façades, 2. pixelization method can provide FIPV designs that are harmoniously integrated into the urban context. Also, the survey result showed that, laypersons tend to rate the presented pixelated FIPV proposals with higher scores in both, aesthetic quality evaluation and contextual coherence evaluation. A potential reason for this phenomenon could be that the expert group with professional aesthetic training, have higher expectations. Online aesthetic survey is an efficiency way to collect subjective feedbacks from a large number of participants, however online photos cannot demonstrate all visual properties of photovoltaics materials (e.g. gloss and texture). Further research could be using (scaled) physical models to test the pixelization method.

## **ACKNOWLEDGEMENTS**

This work was performed within The Norwegian Research Center for Sustainable Solar Cell Technology (FME SUSOLTECH, project number 257639/E20). The center is co-sponsored by the Research Council of Norway and its research and industry partners. The authors express their gratitude to Professor A. Booker and ass. Professor K. Angelo, the members of the Light & Colour Centre at NTNU, for their participation in preliminary testing of the survey, comments about its content.

## **REFERENCES**

- Angelo, K., A. Booker. 2018. Proposing a formula for Harmonic Urban Colour Composition. In: *Proceedings of the International Colour Association (AIC) Conference 2018*. Lisboa, pp. 59–64.
- Arkivseneteret, 2020. *Arkivseneteret Dora*. Online: <https://www.arkivseneteret.no/>
- Femenias, P., L. Thuvander, A. Gustafsson, S. Park,, P. Kovacs. 2017. Improving the market up-take of energy producing solar shading: A communication model to discuss preferences for architectural integration across different professions, in: *9th Nordic Conference on Construction Economics and Organization*. Göteborg,Sweden, pp. 1–12.
- International Energy Agency, 2013. *Transition to Sustainable Buildings*. Paris.
- Lobaccaro, G., S. Carlucci, S. Croce, R. Paparella, L. Finocchiaro. 2017. Boosting solar accessibility and potential of urban districts in the Nordic climate: A case study in Trondheim. *Sol. Energy* 149, 347–369.
- NCS, 2019. *colour combinaiton and harmonies*. Online: <https://ncscolour.com/other-colour-similarities-using-the-ncs-attributes>.
- Xiang, C., B.S. Matusiak. 2019. Façade Integrated Photovoltaic, state of the art of Experimental Methodology, in: *IOP Conference Series: Earth and Environmental Science*. Institute of Physics Publishing, p. 012062.

# A screen experiment on the assessment of façade colour perception factors

Esra Küçükılıç Özcan <sup>1,\*</sup> and Rengin Ünver <sup>2</sup>

<sup>1</sup> YTÜ; esrakucukkilic@gmail.com

<sup>2</sup> YTÜ, reenginunver@gmail.com

\* Corresponding author: esrakucukkilic@gmail.com

## ABSTRACT

When the colours selected during the façade colour design process are applied to buildings, they are perceived differently from their inherent colours due to colour perception factors. Therefore, during the application stage, different façade colour impressions may occur than expected during the design phase. In the study, an experimental model was proposed for the digital environment to predict the façade colour perception factors by assessing them for certain conditions and a "screen experiment" was carried out as the application of the model. The screen experiment was designed to compare the inherent colour with the perceived colour by using fifty-six images consisting of various combinations of four different façade colours and three façade colour perception parameters. Thus, the screen colour experiment model, which was designed for the virtual/digital environment for the "colour perception" factors that play a very important role in the façade colour design, was made available, and a contribution to the literature was made by revealing the guiding data on the subject.

**Keywords:** *façade colours, colour perception factors, perceived colour, perceived façade colour, screen colour experiment*

## INTRODUCTION

While working on the façade colour design, the colours to be used are generally chosen from the colour charts of various paint companies. However, when the colours decided indoors with a small sample from the colour chart are applied to the façades, very different and even surprising colour impressions may occur. Although there are many reasons for this phenomenon, all of them are based on the definition of "perceived colour", which has an important place in the literature on colour. Three basic components that affect the perceived colour; illuminating light, illuminated object and human visual organ have been studied in this context in many studies (Mikellides and Osborne 2009). Changes in the perceived façade colour components (hue, value, chroma) occur depending on many parameters such as the spectral properties of daylight, the façade view distance, the colour, texture and surface area of the environmental elements entering the visual field. Also, the different spectra of the lamps illuminate the paint charts in the environment where the façade colours are selected and the daylight causes the perceived colour to change. In addition, colours are perceived darker than they are due to the simultaneous contrast caused by the background of the colour charts (Anter 2009).

There are a limited number of studies in the literature on the determination and assessment of the properties that affect the façade colour perception. For example, the studies of Karin Fridel Anter, Karim Asarzadeh et al., and Agata Kwiatkowska, et al. Anter (2009) conducted two studies in different locations and found an increase in the value of the yellow and red façades. In the context of this phenomenon, Anter presented the view that the value differences between inherent colours and perceived colours occur independently of daylight and view distance (Sochocka and Anter 2017). In the study of Asarzadeh et al. (2019), subjects stated that in general, spectral changes in daylight affect the hue and value (lightness-darkness) of perceived colour. It was also revealed that the hue of the perceived colour changes less and the value changes more in chromatic façades. In the study of Kwiatkowska and Kowalska (2018), the value of the perceived façade colour increases, the chroma

changes are not significant, and small changes are determined in the colour hues. The change in hues was generally determined as the perceived colour of green moving towards blue. This phenomenon was related to the simultaneous contrast created by the view distances and the green areas in the background of the building, and it was determined that the hue changes were more in chromatic façades. In addition to all these studies, the International Commission on Illumination (CIE 2014), in its technical report numbered 208:2014, examined the studies on the effects of view distance (the size of the viewing area) on the perceived colour. In the report, changes in the perceived colours of interior surfaces, façades, and self-luminous surfaces according to the size of the viewing area were revealed and comparisons were made with mathematical models. CIE has especially emphasized that the perceived façade colours cannot be explained by the size of the viewing area alone and that the surrounding colours and lighting conditions are also effective in this regard.

In the light of the information given above, it has been seen that the studies in the literature are generally achieved in the outdoors with the on-site survey method, and the sky conditions, the quantity and quality of daylight are variable, thus affecting the results. In this context, a model with fixed conditions has been developed that can be applied in the virtual environment for "the determination and assessment of façade colour perception factors on the perceived colour" (Küçükkılıç Özcan and Ünver 2018, Küçükkılıç Özcan 2015). In this paper, the model for the assessment of colour perception variables on the perceived façade colours and the screen experiment carried out within the scope of this model are introduced and the data obtained from the experiment are evaluated.

### ***A MODEL FOR THE EFFECT OF COLOR PERCEPTION FACTORS ON THE PERCEIVED COLOURS OF THE FAÇADE***

The evaluation of the properties affecting the façade colour perception can be done in three different ways: in the outdoors (on-site), with the model and in the virtual/digital environment. In this study, an original evaluation model has been designed for the properties of the factors affecting the façade colour perception, that can be carried out in a virtual environment. This original model in question consists of three basic steps: drawing schematic images, showing the images to the subjects in a virtual environment, and assessing the responses of the subjects. In the following sections the proposed model is mentioned as the "screen experiment" and an application of this model is also given.

#### **Assumptions on Screen Experiment Parameters**

Among the many factors that change the colour perception in line with the limited scope of the study, the colour properties of natural light, the colour properties of the façade and its surroundings (inherent and perceived colours), and the façade view distance will be used as parameters in the screen experiment.

- **The colour of natural light, facades and their surrounding**

To determine a natural light colour with general validity, the spectral and colour properties of natural light sources in the literature were examined and the daylight spectra for clear and overcast sky conditions in the technical report of the International Commission on Illumination CIE-85-1989, titled "Solar Spectral Irradiance" were used (CIE 1989).

Environmental colours, which are one of the variables that affect the façade colours, were discussed under two titles: natural environment (colours of natural elements such as sky, green space, soil, water, etc.) and artificial environment colours (colours of artificial elements such as buildings, walls, etc.) In this context first, the inherent colours of the façade and its surroundings to be evaluated within the scope of the study were determined, then the perceived colours of the determined inherent

colours under the clear and overcast sky light spectra were calculated. As natural environment colours in the study, 2 sky colours (Clear sky: 4.5B-6.18/1.77, overcast sky: 7.98Y-7.75/0.97) were selected by utilizing daylight spectra in clear and overcast sky conditions in the technical report numbered CIE-85-1989 and titled "Solar Spectral Irradiance", and one yellow-green, medium-dark, medium-chromatic green space (plant) colour (5GY-5/6) was selected by utilizing the average results of a natural environment colour analysis performed by Küçükkılıç Özcan and Ünver (2018) with the Munsell Colour System. To represent the inherent colours of façades in the artificial environment, 2 façade colours (5R-8/2, 5B-8/2) from high-value and low-chroma red and blue hues were used. For inherent façade colours, four high-value, low and medium-chroma colours were used; a warm red (5R-8/4, 5R-8/2), and a cool blue (5B-8/4, 5B-8/2) that are often used in façades (Table 1). Perceived colours of "façade and its surroundings' colours" in the screen experiment were calculated in terms of the CIE 1964 X10 Y10 Z10 tristimulus chromaticity coordinates (x10, y10, z10) for the 10° viewing angle of the CIE 1964 Supplementary Standard Colorimetric Observer (CIE 2005, CIE 2019a, 2019b).

Inherent Colours of Façade	Perceived Colours of Façade	
	Under Clear Sky Conditions	Under Overcast Sky Conditions
5R-8/2	7,24YR-7,45/2,07	5,52YR-7,45/1,99
5B-8/2	4,08G-7,58/1,55	6,87G-7,58/1,39
5R-8/4	2,28YR-7,58/3,93	1,13YR-7,58/3,9
5B-8/4	4,52BG-7,45/3,33	6,26BG-7,45/3,26

Table 1: Perceived colours of façades and environment.

- **The façade view distance**

In the study, the surface area ratios depending on the sensation group and sensation size in the research project of Ünver and Dokuzer Öztürk (2002) were used for the façade view distances that affect the colour perception. The view distances to be used in the screen experiment were limited to the "far view" and "close view" options. The ratio of the target building area to the total viewing area was accepted as 18% for far view and 60% for close view.

### Screen Experiment

A total of eleven colour perception variables were reviewed for the screen experiment visuals and fifty-six visuals were prepared as a result of their combination. The visuals containing the building and its surroundings were prepared as a horizontal rectangle per the "golden ratio" (1.618), which is widely used in architecture and has an important place in visual perception. The building in the visuals was sized to provide 18% for far view and 60% for close view in a rectangle per the golden ratio, and it was placed symmetrically, leaving equal area on three sides (two sides and above) of the building. Façade perimeter area (A), façade area (B), façade inherent colour area (C), and the total area (D) were exemplified in Figure 1.

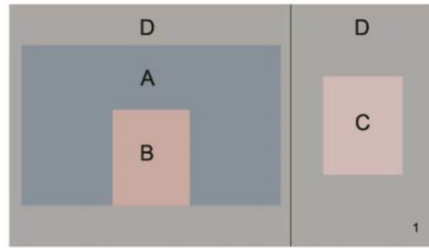

Figure 1: Example for screen experiment image.

Experiment was carried out in the matte black painted section of Yıldız Technical University, Faculty of Architecture, Building Physics Laboratory. The schematically drawn images on the TV screen, which contain the façade, its surrounding area, and the inherent façade colour, were separated by a matte black painted divider panel, preventing the image colours from affecting each other. The positions of the subjects were arranged considering the  $10^\circ$  viewing angle of the CIE 1964 Supplementary Standard Colorimetric Observer, within the horizontal and vertical viewing angles considered to be the limits for the average human eye's visual field. Subjects were positioned to see the perceived colour of the façade with a visual angle of  $10^\circ$  and the surrounding area with a visual angle of  $40^\circ$  (CIE 2005, Fairchild 1997, IES 2011) (Figure 2).

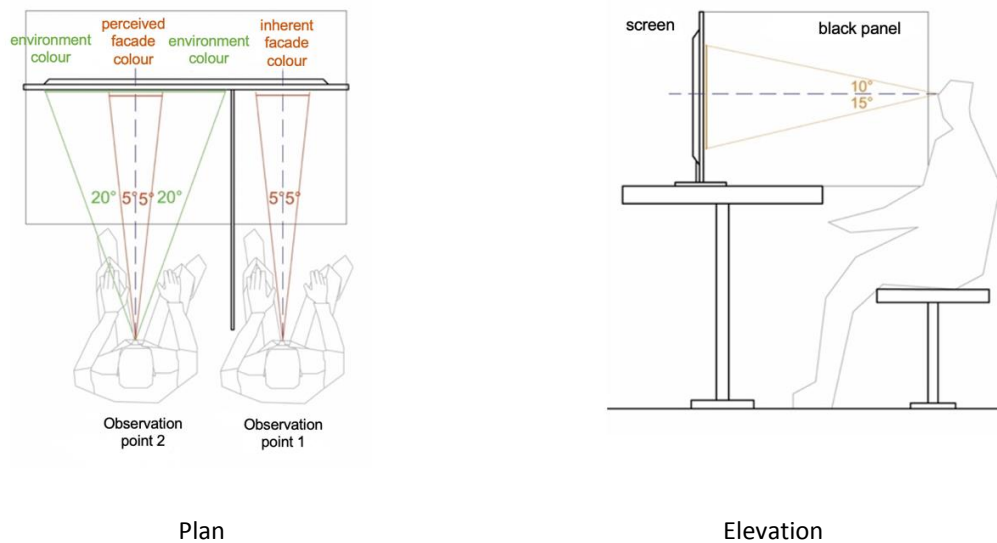

Figure 2: Schematic representation of the screen experiment layout.

Experiments were conducted with thirty subjects whose colour vision anomalies were tested with the Farnsworth Munsell 100 Hue Test and who are trained in the Munsell Colour System (MCS). The subjects were asked to determine the difference between the perceived and inherent colours of the building, in the visuals covering the building and its surroundings, utilizing MCS colour components.

The results of the screen experiment were evaluated using the SPSS 15.0 Computer Statistics Program. The following conclusions were reached by reviewing the findings obtained from the results of the screen experiment in the context of sky light colour, view distance and environmental (natural and artificial) colour perception factors.

- *The sky condition factor* showed statistical significance only with the hue and value components of blue façade colours. While the answer that there was no change in the hue component of the

colours was chosen by a larger number of subjects, the value component of the colours was perceived as darker in both clear and overcast sky conditions. This indicates that the change in blue façade colours that darken (decrease in value) under clear and overcast sky conditions is perceived by the subjects.

- *The view distance factor* showed statistical significance only with the chroma component of the blue façade colours. Colours were perceived as less chromatic in both far and close views.
- *The surrounding colour factor* showed statistical significance with the hue component of the red and blue façade colours and chroma component of the blue façade colours. Almost all surrounding colours created a "simultaneous contrast" in the hue composition of red façade colours, and in this context, reds turned yellowish red. For almost all surrounding colours, the answer of no change for blue façade colours is in majority. In all surrounding colours, only the chroma component of the blue façade colours was perceived as less saturated.

The explanations given above can be summarized as follows in terms of the screen experiment findings.

- In general, the effect of colour perception factors on all three components of the perceived blue façade colours is greater than that of the red ones.
- The sky condition factor only affected the value component of the blue façade colours (~0.5 value steps).
- The view distance factor only affected the chroma component of the blue façade colours (~1 chroma step).
- The surrounding colour factor (green space and artificial environment) affected,
  - the hue component of the red façade colours (~2.5 hue steps),
  - the chroma component of the blue façade colours (~1 chroma step).

## **CONCLUSION**

In this study, a model was proposed for the assessment of façade colour perception factors' and a screen colour experiment was carried out in the virtual environment as an application of this model. The experiment is a virtual comparison set on the screen in a laboratory under fixed conditions, in line with the assessment of the variables of light, view distance and surrounding colours. The experiment was realized with the assessment of fifty-six visuals created with eleven variables of three basic façade colour perception factors by thirty subjects who received colour training.

The results of the screen experiment revealed that the sky condition and view distance, which are among the factors affecting colour perception, affect the value and chroma components of the perceived colour of the blue façades and the surrounding (background) colours affect the hue component of the red façades and the value and chroma components of the blue façades. In addition, it can be said that the inherent colour-perceived colour differentiation for the components will not cause significant changes in terms of colour arrangements. However, it should be noted that the effect of colour perception factors is more important than other colours in colour designs of façades dominated by blue colours.

The colour component changes obtained from the results of the façade colour perception studies in the literature all of which were made with the "on-site inspection method" on the façades of a certain settlement and the "screen experiment" are generally different from each other. The fact that the studies in the literature were carried out with variable natural light, façade/surrounding colours, and view distances in various geographical locations and the screen experiment was carried out with



a different method than other studies, in a virtual environment (computer), under fixed conditions, explains this difference. Therefore, it is normal for the perceived colour component changes that occur due to the variations of a wide variety of factors to be different from each other.

The stages of the model developed under virtual and fixed conditions can be adapted to different studies to predict the changes that the façade colours will undergo due to perceptual parameters during the design stage and arrange them in line with these predictions. The results obtained with the study discussed in this paper and future studies following the aforementioned model will contribute to the literature by providing useful data on the subject.

## REFERENCES

- Asarzadeh K., R. Madani, M.R. Nilforoushan, and F. Mahyar. 2019. An investigation into the impact of daylight on perceived color of façade: understanding the role of chromaticness. *Colour Research and Application* 44: 454-461.
- CIE (Commission Internationale De L'éclairage). 2015. *10 Degree Photopic Photometric Observer*. 165:2005, Vienna.
- CIE (Commission Internationale De L'éclairage). 2014. *Effect of Stimulus Size on Colour Appearance*. 208:2014.
- CIE (Commission Internationale De L'éclairage). 1989. *Solar Spectral Irradiance*. 85-1989.
- Fairchild, M. D. 1997. *Color Appearance Models*. Massachusetts: First Printing, Corporate&Professional Publishing Group.
- Fridell Anter, K. 2009. "Perceived and Inherent Colour: Comparing the Colour of External Facades with Colour Samples." *Colour for Architecture Today*, edited by Porter T, Mikellides B, 133-143. Taylor&Francis, NewYork.
- IES (Illuminating Engineering Society of North America). 2011. *Lighting Handbook*, 10th Edition, New York.
- ISO (International Organization for Standardization), CIE (Commission Internationale De L'éclairage). 2019. Joint ISO/CIE Standard: *Colorimetry — Part 1: CIE Standard Colorimetric Observers*. 11664-1:2019(E).
- ISO (International Organization for Standardization), CIE (Commission Internationale De L'éclairage). 2019. Joint ISO/CIE Standard: *Colorimetry — Part 3: CIE Tristimulus Values*. 11664-3:2019(E).
- Küçükılıç Özcan, E. 2015. "Yerleşimlerde Yapı Yüzü Renk Tasarımına Yönelik Bir Yaklaşım", PhD diss., Yıldız Technical University, İstanbul.
- Küçükılıç Özcan, E. and R. Ünver. 2018. Environmental Colour Mapping and a Case Study for İstanbul, Beşiktaş. In: *AIC 2018 Colour in the Built Environment, Proceeding of the Interim Meeting of the International Colour Association*, Lisboa, 159-164.
- Kwiatkowska A., and J. T. Kowalska. 2018. Survey on Perceived Facade Colours using Colour Samples from Ready-made Plaster Collection for Southern Poland. In: *AIC 2018 Colour in the Built Environment, Proceeding of the Interim Meeting of the International Colour Association*, Lisboa, 133-138.
- Mikellides B, and R. Osborne. 2009. "Seeing Colours." *Colour for Architecture Today*, edited by Porter T, Mikellides B, 42-54. Taylor & Francis Group, New York.
- Sochocka A., and K. Fridell Anter. 2017. Perceived façade colours in different daylight situations: Survey in the old town of Warsaw. *Journal of the International Colour Association* 2017:17: 92-119.
- Ünver R. and Dokuzer Öztürk L. 2002. Toplu konutlarda yapı yüzü renk tasarımında temel ilkeler ve öneriler. Araştırma Projesi, YTÜ Araştırma Fonu, İstanbul.

# Complexity of the theme of the Painted Façades in the large and medium historical centers in relation to the environmental contexts to which they belong

Patrizia Falzone <sup>1,\*</sup>

<sup>1</sup> Affiliation 1; University of Genoa, Department DAD, e-mail: pa.falzone@gmail.com

\*Corresponding author: pa.falzone@gmail.com

## Abstract

The paper aims to address the theme of Painted Façades, more generally the 'color of the historic building', in relation to the environmental contexts to which they belong. It is a fundamental theme in urban planning and architectural design for its pervasiveness at the level of building, urban and urban-environmental episodes of monumental interest and of entire historical centers.

The discussion is conducted with reference to the fundamental points of the color problem: the image of the historic city is unitary, an expression of the history that has identified it over time, therefore formed by the coexistence of the two categories - monuments and basic buildings - always welded together. The methods of approach and attention must also be similar: for the reciprocity of the effects that are determined at the context level when dissonant and ungrammatical interventions are carried out, even in the smallest and most modest building, but belonging to a relevant historical context. Case studies including the *Piazza dei Signori* in Vicenza with the *Basilica Palladiana*, conclude the paper, demonstrating the assumptions and results of the analysis made.

**Keywords:** *Painted Façades, Color, Historic Centers, Environment*

## INTRODUCTION

The paper aims to address the theme and problem of the Painted Façades of the historic building. Certainly not a new topic to which who writes has devoted himself for three decades (Falzone 1980). Now we want to show how it requires, inextricably, to be included in the more comprehensive theme of the 'color of historic buildings' in large and medium-sized historic centers. Above all for the purposes of a more effective and congruent conservation/enhancement. The proposal is to carefully consider the painted façades not only in their features, but also in the relationship with all the façades, of any type, belonging to the same context (Falzone 2011).

This has been shown to be indispensable by the surveys carried out over time during the study of the Italian painted façades (especially on the most significant and identity of the various places). Hence the need to extend the theme of their conservation to the overall color of historic urban spaces (Falzone et al. 2001 b).

Certainly, a much more complex issue because, almost always, these spaces are characterized by the presence of the two different components of the historic building. The basic, or minor, connective building of the historic city, and monumental buildings. Categories for which different regulations are in force and different methods and types of intervention are applied: cause of the results that are often incongruent and / or negative to the overall context.

Therefore, the theme of color appears more and more fundamental and delicate in design (for the conservation, restoration and maintenance of historical buildings): for its pervasiveness at the level of the building, of urban and urban environmental episodes (Falzone 2008).

## The purpose

The example of the historic center of Vicenza wants to demonstrate how the correct congruent conservation/restoration, and enhancement, of the monumental façades, are inseparable from the control of the environment. That is, through the control of all the façades that delimit the space (squares, streets, alleys ...), even and especially those of minor buildings, and of their proper maintenance. An equally important condition for the enhancement and redevelopment of buildings and the environment. To achieve all this, control, pre-design checks and then interventions, however, require adequate methodologies. Starting from Knowledge, to the Project, to the Intervention, up to the Maintenance Project, which is very important. On the other hand, it is also true that to ensure that all this works, they also and above all need ad hoc regulations by the public administrations, and by the Superintendencies, which should above all broaden and interface their fields, which are too sectoral.

For these purposes, I must remember that the Color of the city is the result of the different architectural and decorative forms of the façades, which contribute to forming the overall color. 1. The color of the materials. 2. The color of simple plasters. 3. The colors of bichromatic or trichromatic paints. 4. The colors of actual painted façades. Therefore, working on this theme also requires specific knowledge of the overall 'color of historical buildings' in open spaces. For this, we need to work above all on the theme of the two building types that often coexist in the same context: basic, buildings and listed monumental buildings. For the widespread problem of inadequate interventions on façades or entire buildings belonging to basic construction, not subject to control.

These, if placed in a relevant context of monumental buildings with painted façades, can lead to deterioration of the overall urban-environmental values. Moreover, the case is frequent everywhere of basic buildings that preserved significant pieces of not listed painted façades. So often these are lost, removed or hidden under simple paint. However, in all cases, of major or minor centers, of listed or not prominent façades, it is increasingly evident that this is an environmental problem, which must not be distorted even with the minor intervention. Therefore, it is imperative to consider every historical urban environment both in its individual parts and as a whole. In fact, the image of the city is unitary, an expression of the history that has identified it over time, and formed by the coexistence of both categories, closely linked to each other. In any case, reference must be made to this overall reality, regardless of the type of building on which the intervention is carried out, and however partial the intervention may be. Above all taking into account that even minor dissonant interventions in the smallest modest building can be carriers of degradation to a relevant historical-architectural environment. Therefore, there is a landscape aspect linked to the color of the façades that emerges more and more, with the spread of interventions, often still improper.

An operation that has always been neglected, on the other hand very important, is highlighted and proved to be the preventive perceptive verification, indispensable in any intervention in the historic city, even in the simplest cases, but on objects that interact visually with monumental buildings with painted façades contexts of significant value.

This is the first point that we want to bring to attention, since today there are striking examples of environmental degradation due to poor, uncontrolled interventions, precisely on the color of the basic building. Both in the use of colors and their shades, and in the use of recent materials, with totally different material impact characteristics, which are too impactful. This is exemplified in the case study of the Painted Façades of Vicenza (decorative typology of the façades widespread throughout the Veneto), and in particular on the theme of the famous Piazza dei Signori.

Therefore, before any color project, even in the simple interventions but on objects that visually interact with monumental emergencies or placed in urban spaces of significant value, the need for perceptual verification of the historical environments in all cases is confirmed.

### **The method, the investigations and the role of perceptual verification**

Regarding the theme of the color project of the single façade, the need for an adequate Knowledge Methodology is now shared by the various disciplines which must concern all these fields (History, Representation, Restoration, Technology). The presence of suitable and experienced operators is essential. Therefore, the first essential phase, already practiced, is the preparation of a structured sequence of basic knowledge, tailored to the specific needs of each building, to arrive at the coherent Intervention Project, whatever it may be, on the façades.

Regarding the Scientific Methodology of Knowledge, I underline two important issues. One, which concerns the Survey, which must be understood as a total knowledge of the factory and of the façades under the most diverse aspects: historical, architectural, decorative, technological, and technical. The other concerns the Project phase, which still shows different approaches and criteria, sometimes even a discrepancy between theory and practice, even at a monumental level. Therefore, a theme that still needs to be reasoned today is how to get from the Survey data to the Project data, since it is possible to arrive at very different solutions starting from the same data. And then precisely in this regard the practice of environmental perceptual verification becomes a fundamental decisive support.

In summary, the fundamental investigations, already carried out, both for the Survey and for the Project are: The reading scales (urban level-building level architectural level) (Falzone 2001 a). The type of intervention. Historical knowledge of the factory (Building, Facades). Knowledge of the types of façades (architectural, decorative, and chromatic typology). The dating and layering of the finishes. The type of finish (s) (fresco, dry fresco, tempera, chiaroscuro, graffiti....). Knowledge of the state of conservation and decay. - Technological, material, and technical knowledge. To these investigations must now be added the other fundamental and priority analysis, the PERCEPTIVE one, accompanied by the identification of the type of historical environment in which one intervenes.

The main types are: 1. Uncontaminated historical environment, unitary by epoch; 2. Uncontaminated historical environment but mixed for ages; 3. Historical environment contaminated by incongruous and recent interventions and/or buildings; 4. Historical environment heavily degraded both in the state of conservation and in the building components, the most diversified. This immediately clarifies the situation of that environment and highlights how to solve the problem bearing in mind the fundamental need: the achievement of quality. Because it is precisely the loss of quality that underlies the progressive modification and deterioration of this component and, with it, of the historical figurative characteristics of the places (Falzone 2017). Quality that derives from the quality of Knowledge and of Survey in particular. Then from the quality of the Project; the quality of execution and materials; finally, the quality of the maintenance program. In this sequence the environmental perceptual verification constitutes the central and decisive point.

### **The proposed example. the historical center of Vicenza and the painted facades.**

The historic center of Vicenza shows, among many others, some prestigious sixteenth-century painted façades still inserted in uncontaminated environments. Like the painted façade of the adjacent Thiene palace, with a typology of scenes with figures in geometric parts, and the small building with a façade painted with geometric-decorative motifs and grotesque ornaments in Corso Andrea Palladio. On the

Complexity of the theme of the Painted Façades in the large and medium historical centers in relation to the environmental contexts to which they belong

other hand, the example of the huge Piazza dei Signori, a historical environment rich in Palladian monuments (Basilica, Loggia del Capitaniato), instead shows some inconsistencies. The very long prospect of the Monte di Pietà, on one side, with the exquisite painted façade unfortunately faded, faces the imposing white façade of the Palladio Basilica. Instead, the short sides at the bottom of the square, especially the shorter side, have as a backdrop a row of buildings of minor construction repainted in an incongruous way, both in the colors, too bright, and in the materials, not belonging to the local tradition, strident note, foreign to the rest of the environment. The other short side, wider, has more preserved facades, in light colors, muted, not violently modified. This example of an urban space of very high historical-artistic-environmental value shows the unavoidable need for a double perceptual verification the environment: from the inside, and as perceived from external points of view, even more distant, from which any element inconsistent can be detected. Moreover, it also requires a check from above, of further control, including horizontal surfaces, roofs and floors, no less important components of the urban scene, practice today particularly easy with the use of shooting with drones. perceptual verification constitutes the central and decisive point.

#### **PERCEPTIVE VERIFICATION. Sequence of phases and documents.**

-Detailed plans of the space under investigation where to identify the monumental buildings' façades, other facades, and incongruous ones.

- Plan of the wider environment, with the neighboring areas, where to identify all the points, even the most distant, of perception of the square and its chromatic components, especially those incongruent and too invasive.

1. Photographic shots of the square, of the individual buildings and of the context, both close and wider. 2. Aerial photography with drones: both close and wider context. 3. Investigation and acquisition of all existing constraints regarding the different historic buildings and/or painted façades.

#### **Painted facades in uncontaminated historical environments**



Figure 1: Vicenza. Painted Renaissance façade of the building adjacent to Palazzo Thiene, in Contrà Porti.

#### **Painted facades in uncontaminated historical environments from different periods**



Figure 2: Vicenza. Painted façade of a small Renaissance building in Corso Andrea Palladio.

Complexity of the theme of the Painted Façades in the large and medium historical centers in relation to the environmental contexts to which they belong

### Painted facades in contaminated historical environments.

A striking case is the heart of the historic center of Vicenza, the Piazza dei Signori. Here the long prospect of the Monte di Pietà, on one side, with the very valuable painted facade, unfortunately faded, faces the imposing white facade of the Basilica. On the other hand, the two short sides of the square, with the smaller buildings, show repainting interventions, carried out using bright colors that are not part of the local tradition.



Figure 3: Vicenza, Piazza dei Signori. Palladian Basilica, Monte di Pietà, Loggia del Capitaniato. Views within the square and from the outside. Chromatic details of the materials of the Basilica.

Even the large square distinguished by the Palladian Palazzo da Porto, shows recent buildings with chromatically striking facades with the lighter colors of the tall and short colonnaded façade of the building, but also in the neighboring historical contexts, too bright and contrasting repainting interventions appear the historic buildings, and thus the incongruous jarring red of the façade of the Braschi palace.



Complexity of the theme of the Painted Façades in the large and medium historical centers in relation to the environmental contexts to which they belong



Figure 4: Starting from above: Palazzo da Porto, Piazza Castello; below, Renaissance building with recent, incongruous insertions in the historic center; last, Palazzo Braschi: example of Gothic / Venetian architecture with an incongruously repainted facade, in Corso Andrea Palladio.

## REFERENCES

- Falzone, P. 1980. *Palazzo Geronimo Grimaldi de Jeraci, "Palazzo della Meridiana"*. SCHEDA "A" Catalogo Generale. Ministero Per I Beni Culturali E Ambientali. Direzione Generale Antichità e Belle Arti. Soprintendenza per i Beni Ambientali e Architettonici della Liguria. Genova.
- Falzone P. 2001a. *Costruzione dello Sviluppo Crono-Tipologico delle Facciate Dipinte a Genova*, in Maestri D., Mezzetti C. (a cura di), *Emergenza Rilievo, Applicazioni di metodi operativi al rilievo per la valorizzazione e il restauro dei beni architettonici e ambientali*, KAPPA, Roma 134-147.
- Falzone, P., V. Galimberti, P. Gasparoli, and R. Soro. 2001 b. *Il Progetto del Colore*. ERGA, Genova.
- Falzone P. 2008. *Colore Architettura Ambiente*, KAPPA, Roma.
- Falzone, P. 2011. *Il Colore nel Costruito Storico. Innovazione; Sperimentazione; Applicazione*, Aracne, Roma, DVD allegato.
- Falzone, P. 2017. *Palazzo Cattaneo Della Volta. Architettura e facciate nello spazio di una famiglia-albergo genovese*, in: *I Cattaneo Della Volta. Vicende e protagonisti di una millenaria famiglia genovese*, Sagep, Genova, 410-449.

# Colour and Design of Birth Spaces: A transdisciplinary review

Doreen Balabanoff <sup>1,\*</sup>

<sup>1</sup> OCAD University; doreen.balabanoff@gmail.com

\* Corresponding author: doreen.balabanoff@gmail.com

## Abstract

Colour and light are significant aspects of architectural spatial design that require more critical attention, research, and discussion within birth environment design discourse and planning. Knowledge of how colour, light and darkness impact birth is important for stimulating designers' creative contributions towards better birth spaces. Four themes aid in considering colour and light in birth environment design: 1) amelioration of fear; 2) support for physiological birth processes; 3) ambiance of privacy and intimate sensuality; and 4) grounding for a spiritual experience of birth. The paper presents evidence that colour – understood as material and as light – can be valuable in creating future birth spaces that support women's needs and desires for meaningful, sensitive, and satisfying birth experience.

**Keywords:** *birth environment, colour, light, ambience, architectural design*

## INTRODUCTION

This paper is a part of an ongoing SSHRC-funded Insight Development research project, *Transformational Change for Birth Environment Design*. The enormous task of improving maternal and infant health and wellbeing is a global priority, and the Global Birth Environment Design Network (GBEDN), which the author co-founded, is aiming to elevate awareness, knowledge, and action towards a paradigm shift for birth environment design, as important for better birth experience. The work under development is a rich and searchable database of literature and other resources including case studies that can be activated as a comprehensive web-based resource to inform, aid, and inspire architects, designers and healthcare leaders. Creating salutogenic birth spaces that offer emotional as well as physiological support for birth as a fundamental life experience is an important global project of our time. This paper offers highlights from our transdisciplinary review of birth environment design knowledge, concerning the current state of research on colour and light in birth space design.

### Goals and Methods

"The sense of the open, and that of the closed is suggested to us by light and dark, by luminosity and darkness or shadow. As much as light allows the eyes to see, too much light creates environments where we are no longer able to see... due to the privileging of the undifferentiated which is counter to creating areas of intimacy... [and] to the visioning of one's own existential landscapes."

The Italian architect Bianca Lepori was a key figure in bringing the need for further attention to birth environment forward. In comments on light and colour, she wrote, (1992:129): *It is impossible to define the 'correct' colour for a place of birth, just as it is not possible to provide a standardized model of this space. Perhaps the discourse should work in reverse, that is, eliminating those colors that evoke medicalization, asepticity, 'surgery'.*

She noted that combinations of materials/colours could be calming as well as 'strengthening', as a vivid color could add life, inspire determination or movement, or a pastel colour could soften rigid surfaces.

Much of the literature on the value of design contributions aimed at better birth environment has developed within midwifery research, with some collaboration from architects, designers, obstetricians, anthropologists. Relevant discourse and study also may come from healthcare perspectives seeking to humanize the medical environment...e.g., biophilic or salutogenic theories. A



key point often missed in birth environment design approaches in hospital settings is that birthing women are not ill and should not be characterized as (helpless) ‘patients’.

Within the field of architecture, there is growing interest in atmospheric and phenomenological architecture. Perceptual, hormonal, and epigenetic studies are intermingling with neurobiology, social sciences, and aesthetic and phenomenological philosophies. This ecology of knowledge can significantly inform designers. Today, more than ever, we need transdisciplinary approaches that can open awareness and connection across disciplines.

Review search terms included ‘birth environment’, ‘maternity unit’, ‘parturition and environment’, ‘neurohormones and birth’, ‘birth space’, and the terms light, lighting, color or colour, dark or darkness. The search produced over 70 peer-reviewed publications, subsequently canvassed for meaningful content. Texts excluded did not have enough specific or significant content about use of light and/or colour in birth spaces.

### Findings and Discussion

The findings indicate that while not enough attention has yet been focused on the specifics of light and colour as impactful upon birth processes and birth experience, four emergent themes point to the value and meaning of light-colour-darkness for birth environment design: 1) *amelioration of fear*; 2) *support for physiological birth processes*; 3) *ambiance of privacy and intimate sensuality*; and 4) *grounding for a spiritual experience of birth*.

#### *Amelioration of fear:*

Stenglin and Foureur (2013: 823) discuss the fear that arises as women enter hospital, and suggest ‘bound’/‘unbound’ space as valuable in countering it. They identify three crucial points in the woman’s journey: admission to hospital; early labour; and moment of birth. They discuss the potential value of comforting, private ‘bound’ spaces at admission; ‘unbound’ spaces during early labour; and securely ‘bound’ spaces for the intensely vulnerable time of late labour and giving birth. Organization of space, they note, is impacted by ambiance: “*High levels of illumination are likely to make an enclosed space feel more expansive or Unbound as light enhances our ability to perceive colour, texture, pattern, depth, space and volume* (Gardiner and Moloney 2001) *whereas dim lights create spaces that feel more contracted and Bound.*” They suggest use of warm incandescent lighting and note that temperature is another strong comfort factor.

Earlier, Fahy et al. (2008) discussed the powerful ‘fear cascade’ triggered by stress hormones, and Balabanoff (2019) has elaborated a sense of the ‘inappropriate birthing body’ – these are understood as related to hospital entry, and features and ambiances of the environment, e.g., the red EMERGENCY sign at nighttime entry, the bright hallway lighting, a waiting room without privacy or sensitive lighting/materiality, the often largely white, beige or grey maternity spaces, the lack of natural light, the glare of glossy floors.

#### *Supporting physiological birth*

Support for normal birth is at the core of considerations for better birth environments. The discourse has often been focused on the hormone oxytocin, understood as related to ‘comfort/comforting’: induced by environmental factors such as low warm lighting (e.g., candlelight or incandescent lamps); soft textures and places to rest; natural materials; relaxing views of nature, water, sky; calming music/sounds and aromas (Fahy, Foureur and Hastie 2008; Uvnas Moberg 2011). But another hormone that interacts with oxytocin, melatonin, is now notable as highly significant for labour and birth (Olcede

et al. 2013; Karpovitch and Moiseevich 2018). *Suppressing nighttime melatonin (bright light, blue light) will shut down labour/contractions*. This important information, not yet widely known, runs counter to the idea that blues and greens (think of the new environmental coloured lighting and screen-based imaging options) should be utilized in birth spaces due to their ‘calming’ aspect. Pale green walls warmed by the sun might not be a problem in daytime, but use of blue-violet LED lighting (446-477 nm) or high illuminance white light (10,000 lux) at night, in the birthspace, would specifically slow or stop physiological birth processes (Olcede et al. 2013; Olcede and Beesley 2014; U Florida Report 2018). Wrønding et al (2019), with awareness of this research, found that the caesarean delivery rate was significantly lower in a ‘sensory’ room (6.4%) than in the standard room (10.7%) – different spectral irradiance and illuminance values are shown. They noted that women and staff prefer the two sensory rooms. Lorentzen et al found little difference in clinical outcomes in a sensory room vs a standard room.

Mood is a key concept for supporting physiological processes of birth – and is dynamic rather than static in the timeframe of birth. Stenglin and Foureur (2013: 823) state that lighting is “critically important” and that light should be dimmable and changeable for restful or more active moods. They note that colour can support mood by stimulating with brighter colours or providing restfulness with subdued warmer tones.

Aesthetics of the birth room are not simply cosmetic, they are important to women as influential on how easy or difficult it is to give birth (Newburn and Singh 2006). Duncan (2010) has offered a study about distraction from pain by a large coloured screen/artwork feature, showing impact on length of labour and need for analgesia. Wrønding study of a labour room using large, screened images has similarities (2019). Aburas et al. (2017) studied screening nature images on a television screen but found little change in outcomes. Symon et al (2008) found women scoring higher on ‘comfort questions’ in a postnatal survey were more likely to have had a normal birth. Bowden, Sheehan and Foureur (2016:73-76) gathered images of birth spaces, used visual semiotics, and noted *colour and surface texture* conveyed ‘hygienic, easy to clean, medically functional’...while only 27.5% of images showed ‘notions of domesticity and naturalness of birth’ (a double bed to one side, *soft lighting, warm-coloured walls, wood grain*). Setola et al (2019) provide a comprehensive review of diverse aspects of birth environments and how they impact rates of intervention and normal birth, C-section rates and more. Studies are charted to offer quick insight into topics within birth environment studies that describe design attributes specifically. Colour, natural light and lighting, and ambience and sensory aspects are elements of diverse studies listed, with location and impact specifically correlated.

#### *Ambiance of privacy and intimate sensuality*

The sense of a ‘sanctuary space’ for birth includes but goes beyond physical enclosure to include intimacy. Sensuality, sexuality, and pleasure in birth are less discussed aspects of positive birth experience (Davis and Pascali-Bonaro 2010). Women and supportive partners taking this approach will utilize intimate and sensual sense of touch, low warm lighting, music...but will need privacy that is usually absent in hospital settings. Studies have shown that pain is ameliorated with distraction, and sexual stimulation has been studied in this regard (Mayberry and Daniel 2016).

A key factor in home birth vs. hospital birth is personal space...only familiar persons are in the space, and there are destinations with different levels of privacy. Ambient light and colour can be personalized. Instinctive/personally preferred ways of being are normal in the setting. Dr. Michel Odent has often stated the need to shut down the neocortex to facilitate birth: *“Yet again, we are simply rediscovering what most mammals know instinctively: one does not feel so observed in the dark.*

*Most female mammals try to find a dim corner to give birth...Nevertheless, even some home birth midwives who are very careful to disturb the birth as little as possible have a tendency to underestimate the importance of a dimmed light.” (Odent 1992:17-18; Odent 2009:133).*

### *Grounding for a spiritual experience of birth*

Fundamental within the history of architecture and art is the notion that physical space can activate spiritual awareness. Light and colour are always implicated. Mindfulness is appearing in the interface between spiritual ways of knowing, neuroscience and architecture, and within birth discourse as well. Crowther (2017) notes that definitions of spirituality (related to birth) “seem to largely focus on cognitive and psychological dimensions of meaning.....seeming to neglect an embodied, material, and spatial view.”

In an international cooperative inquiry on spirituality and birth, the authors offered excerpts of their conversations. *“A sanctuary space is important for spiritual experience.” So much has been written about how women need to ‘go inside themselves’ ...a cold, clinical environment is not conducive to that”. “[B]irth spaces that empower holistic care support the physical, emotional and spiritual experience of birth, offering women feelings of deep safety and ‘rightness’.* (Crowther et al. 2021: 138-143).

In Fahy et al (2008: 105) the development of ‘birth territory’ theory and practice includes Bianca Lepori’s concepts of birthspaces that accommodate the “moving, feeling and dreaming body”. Her ideas were incorporated into the ‘Lepori Birth Rooms’ in New Zealand, and the chakras, with their colour coding of areas of the body as related to aspects of world/consciousness were used to choose colours for the spaces.

Aroua et al. (2020) analyzed a variety of maternity spaces to identify colour strategies/preferences and describe a hospital in France) where delivery and labor rooms were white, yellow and light grey. A woman said: *“Yellow is a brilliant and happier color, the color of the sun, of joy; it makes the room shine.”* Another woman said: *“The spaces are good enough...apart from the delivery room. It is grey and austere. It depressed my husband too.”* The birth centre architect spoke of providing security and tranquility with her choice of colours, while an interviewed woman said of the same space, *“I found the maximum privacy in this room; it is warm and colourful.”*

Florence Nightingale spoke of the embodied and spirit-enhancing potency of colour eloquently: *“The effect...of brilliancy of colour is hardly at all appreciated... I shall never forget the rapture of fever patients over a bunch of bright-coloured flowers...Little as we know about the way in which we are affected by form, by colour, and light, we do know this, that they have an actual physical effect. Variety of form and brilliancy of colour in the objects presented to patients are actual means of recovery”* (Nightingale 1898).

## **CONCLUSION**

The literature shows that aesthetic resonance of the environment is important to birthing women, and to birth processes, but are undervalued in the medicalized approach to birth. It is important to build the knowledge base about colour-light-darkness for birth environment designers, so that they can utilize the most current evidence, and develop more understanding of how they might contribute to better birth spaces. There is a need for deeper study of the impact of colour, light and darkness as aspects of birth environment design. Further studies should include a review of the extensive literature on environmental colour and light for relevant knowledge that could be useful in this context.

## ACKNOWLEDGEMENTS

I wish to acknowledge and thank the Social Sciences and Humanities Research Council of Canada (SSHRC) for supporting this work. Many thanks to co-investigators Nicoletta Setola (Italy), J. Davis Harte (USA), and Elizabeth Newnham (Australia), and to research consultants Elena Bellini, Sarah Joyce, Sabrina Pillai, Cindy Stein, Sophya Yumakalov.

## REFERENCES

- Aburas, R., Pati, D., Casanova, R. and Adams, N.G. 2017. "The Influence of Nature Stimulus in Enhancing the Birth Experience." *HERD: Health Environments Research & Design Journal* 10 (2): 81–100.
- Aroua, I., and H. Faten. 2020. "Color Analysis of Birth Space Ambiances." *Cultura e Scienza Del Colore - Color Culture and Science* 12 (01): 40–47.
- Ayerle, G., Schäfers, R., Mattern, E., Striebich, S. Haastert, B., Vomhof, M. Icks, A., Ronniger, Y. and Seliger, G. 2018. "Effects of the Birthing Room Environment on Vaginal Births and Client-Centred Outcomes for Women at Term Planning a Vaginal Birth: BE-UP, a Multicentre Randomised Controlled Trial."
- Balabanoff, D. 2019. "The Inappropriate Birthing Body and How the Birth Environment Is Implicated." In *Inappropriate Bodies: Art, Design, and Maternity*, eds. Rachel Epp Buller and Charles Reeve, 251–90. Toronto: Demeter Press.
- Balabanoff, D. 2017. "Light and Embodied Experience in the Reimagined Birth Environment." University College Dublin. Available at <https://www.researchgate.net/profile/Doreen-Balabanoff>
- Bowden, C., Sheehan, A., and Foureur, M. 2016. "Birth Room Images: What They Tell Us about Childbirth. A Discourse Analysis of Birth Rooms in Developed Countries." *Midwifery* 35 (April): 71–77.
- Crowther, S. and Hall, J. eds. 2017. *Spirituality and Childbirth: Meaning and Care at the Start of Life*. 1 edition. New York, NY: Routledge.
- Crowther, S. A., Hall, J., Balabanoff, D., Baranowska, B., Kay, L., Menage, D., and Fry, J. 2021. "Spirituality and Childbirth: An International Virtual Co-Operative Inquiry." *Women and Birth* 34 (2): e135–45.
- Davis, E., and Pascali-Bonaro, D. 2010. *Orgasmic Birth: Your Guide to a Safe, Satisfying, and Pleasurable Birth Experience*. New York: Rodale.
- Duncan, J. 2011. "The Effect of Colour and Design in Labour and Delivery: A Scientific Approach." *Optics & Laser Technology*, 43 (2): 420–24.
- Fahy, K., Foureur, M. and Hastie, C. 2008. *Birth Territory and Midwifery Guardianship: Theory for Practice, Education and Research*. Edinburgh: Elsevier Health Sciences.
- Nightingale, F. 1871. Introductory Notes on Lying-in Institutions, Together with a Proposal for Organising An ... <http://archive.org/details/introductorynot00nighgoog>.
- Karpovitch, A. E., Inna, E. and Moiseevich, K.I. 2018. "In Melatonin: Pregnancy and Childbirth." *MOJ Current Research & Reviews* 1 (5): 206–10.
- Kitzinger, S. 2011. *Rediscovering Birth*. 2nd Edition. London: Pinter & Martin Ltd.
- Leboyer, F. 1975. *Birth without violence*. New York: Knopf/Random House.
- Lepori, R. B. 1992. *La nascita e i suoi luoghi*. Como: Red Edizioni.
- Lorentzen, I. P., Andersen, C.S., Jensen, H.S., Fogsgaard, A., Foureur, M.F.F. and Nohr, E.A. 2021. "Does Giving Birth in a 'Birth Environment Room' versus a Standard Birth Room Lower

- Augmentation of Labor? – Results from a Randomized Controlled Trial.” *European Journal of Obstetrics & Gynecology and Reproductive Biology*: X 10 (April): 100125.
- Mayberry, L., and Daniel, J. 2016. “‘Birthgasm’: A Literary Review of Orgasm as an Alternative Mode of Pain Relief in Childbirth.” *Journal of Holistic Nursing* 34 (4): 331–42
- Olcede, J., Lozier, S. and Paradise, C. 2013. “Melatonin and the Circadian Timing of Human Parturition.” *Reproductive Sciences* 20 (2): 168–74.
- Olcede, J., and Beesley, S. 2014. “Clinical Significance of Melatonin Receptors in the Human Myometrium.” *Fertility and Sterility* 102 (August).
- Odent, M. 1992. *The Nature of Birth and Breast-Feeding*. Westport, Conn.: Bergin & Garvey.
- Odent, M. 2009. “The Masculinisation of the Birth Environment.” *Journal of Prenatal & Perinatal Psychology & Health* 23 (3): 185–91.
- Setola, N., Eletta, N., Cocina, G.G., Eide, L.B., Iannuzzi, L. and Daly, D. 2019. “The Impact of the Physical Environment on Intrapartum Maternity Care: Identification of Eight Crucial Building Spaces.” *HERD* 12 (4): 67–98.
- Singh, D. and Newburn, M. 2006. “Feathering the Nest: What Women Want from the Birth Environment.” *RCM Midwives: The Official Journal of the Royal College of Midwives* 9 (7): 266–69.
- Stenglin, M., and Foureur, M. 2013. Designing out the Fear Cascade to Increase the Likelihood of Normal Birth. *Midwifery* 29 (8): 819–25.
- Symon A., Paul J., Butchart M., Carr V., and Dugard, P. 2008. “Maternity Unit Design Study Part 3: Environmental Comfort and Control.” *British Journal of Midwifery* 16 (3): 167–71.
- Uvnas-Moberg, K. 2011. *Oxytocin Factor: With a New Foreword: Tapping the Hormone of Calm, Love and Healing*. 2nd edition. London: Pinter & Martin Ltd.
- University of South Florida. 2018. “Nightly Suppression of Contractions in At-Risk Pregnancies by the Infusion of Defused Blue Light.” Clinical trial registration NCT03691740. [clinicaltrials.gov](https://clinicaltrials.gov).
- Wrønding, T., Argyraki, A., Petersen, J. F., Topsøe, M. F., Petersen, M.P. and Løkkegaard, E.C.L., 2019. “The Aesthetic Nature of the Birthing Room Environment May Alter the Need for Obstetrical Interventions – an Observational Retrospective Cohort Study.” *Scientific Reports* 9 (January): 303.

# A multiscale approach to the urban space color analysis starting from the case of study of the Collegio di Milano

Zhaohua Lei <sup>1</sup>, Fabrizio Ivan Apollonio <sup>2</sup> and Marco Gaiani <sup>3,\*</sup>

<sup>1</sup> Poli.Design, Italy; lzhdesign2018@gmail.com

<sup>2</sup> Alma Mater Studiorum University of Bologna, Dept. of Architecture; fabrizio.apollonio@unibo.it

<sup>3</sup> Alma Mater Studiorum University of Bologna, Dept. of Architecture; marco.gaiani@unibo.it

\* Corresponding author: marco.gaiani@unibo.it

## Abstract

In pursuit of a more objective approach to efficiently support the urban color design, the aim of this study is to introduce a multiscale approach to the urban space color analysis. The paper starts with an introduction of a robust method, based on color corrected images. Specific features, problems and solution are then illustrated. The Collegio di Milano complex, designed by the famous architect Marco Zanuso, was selected as a case study to prove the methodology's effectiveness.

**Keywords:** *Urban color analysis, project of color, architecture, color design, Milan*

## INTRODUCTION

From the analysis of some Color Plans, it emerges that all of them, even considering their differences and specific characteristics, are structured on common/shared well-defined phases (Figure 1): historical analysis/research; data survey and acquisition; processing, and design / elements for the project; implementation rules and control, dissemination / communication, and disclosure.

This structure is today consolidated, and it produces well defined results that could be summarized as a general homogeneity of the color façades. However, urban design operates across a variety of spatial scales and then urban color design is an inherently multiscale process. Two motivations support this statement: one more general and one specifically related to the different scales of the built environment. Color harmony and contrast theories show that sizes and/or proportions are main factors affecting visual perception and identification of color (Westland et al. 2007). Secondly, colors of structural components at different scales result in different identities (Moughtin et al. 1999).

These structural features create a difference between small-scale and large-scale environments as identity. This implies the need to analyze the urban color at different scales: city, quarter, block/street, building, building elements.

However, usual urban color analysis techniques are not multiscale, and various scales also are limited to the use in the graphic representations of the buildings using plan or elevations. Color analysis is limited to the check of building using digital images, schemes, cards, and color scales (e.g., the Munsell color system), but colors are not related to each other at the current scale and comparisons of the salient color are not effective at the various dimensions.

In this paper we present a multiscale method dedicated to the urban color analysis with the aim of an efficient support to the urban color design. The approach considers not only changes in hue but also in lightness of the colors, to support both chromatic and materials analysis.

The Collegio di Milano complex (Schiaffonati et al. 2019) and the surrounding area in the city of Milan (Italy) were chosen as case study for this work. This complex is particularly suitable to prove our method because the original intent of the project was to identify color hues by materials, and variation from the base color were achieved exploiting sharp shapes. The variation of light shadows at the different times of the day and in different periods of the years generate lightness variations recalling the typical way of the historical city center of Milan, where façade colors are near neutral with subtle variation achieved changing the lightness more than the hue. The analysis of the colors of the Piazza

A multiscale approach to the urban space color analysis starting from the case of study of the Collegio di Milano del Duomo buildings, in the center of Milan, shows how this feature is proven efficiently by the developed analysis technique.

### The phases / 1

- 1. Historical analysis/research**
- in-depth study of historical research on color and local coloring and plastering techniques: archive, historical building regulations, recipe books, iconography in general (photos, prints);
  - identification of the relevant buildings (not exclusively the restricted/under protection ones), chromatic “invariant”;
  - archiving of documents.

- 2. Data survey and acquisition: Survey & Knowledge**
- Survey / census of the colors present: digital survey / visual survey with NCS system, divided by morphological elements. (background, cornice, string course ...), including woods and irons; photographic survey carried out by performing a standardization of techniques and a rigorous shooting method;
  - stratigraphic and laboratory analysis of the traces of ancient colors on “relevant” buildings;
  - in-depth study of the materials used: plasters, stone materials, bricks, etc.;
  - implementation of the current state of the façade form with the entry of new data: dimensional parameters, morphology of the façade and dimensional ratios of partitions and decorative elements, Color Palette (Digital, NCS coding, etc.) of the color: elements (masonry, wood and iron), location, orientation and topological data (head, line, angle ...), dimensional parameters of the around (street width / building height ratio).

### The phases / 2

- 3. Elaboration and design / Elements for the project**
- data processing: classic (color frequency, color combinations, techniques), new indicators (context ratio indicator, display of inconsistencies, etc.);
  - chromatic maps; the vectorial returns of the façades could be reorganized in order to be connected and recalled in the query operations;
  - color palette;
  - dissemination of elevation and photo planes for public use in the simulation of intervention projects.

- 4. Implementation rules and control**
- project check-list;
  - control criteria;
  - implementation monitoring parameters;

- 5. Dissemination / Communication and disclosure**
- archive in progress;
  - website;
  - Five-year report of photo comparisons.

Figure 1: Color-Design methods and phases.

## THE MULTISCALE APPROACH

The developed method moves within this consolidated structure, as illustrated in Figure 1, using the typical tools of the urban color analysis (digital images, Color Order Systems, plan, elevations, etc.).

The novelty consists in the accurate selection of tools and instrument according to the specific task to be performed and with the aim to let the planner/architect to focus on the new design and not on the data acquisition and processing, following a well-defined workflow based on color hue and lightness. This allows to have more focused references for the specific design tasks at the different scales. The method is based on color corrected digital images to have colorimetrically reliable images for an accurate evaluation of the color (Figure 2). For oblique aerial images the color correction is applied directly on TIFF or JPEG file format exploiting color constancy techniques (Foster 2011). For the terrestrial images is used the RAW file format allowing most suitable results.

This could be done using the popular target-based technique as specified by ISO17321 and the X-Rite ColorChecker Classic target. This method is valid for a lighting geometry, color target materials, and a specific surface structure. Despite these problems, it is appropriate in the urban color analysis field, essentially due to its flexibility and ease of use, granting an accuracy appropriate enough to the need of the urban color design (Gaiani et al. 2021).

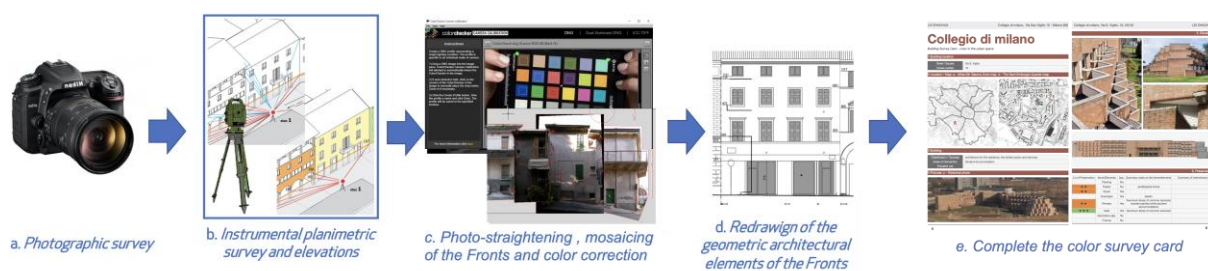

Figure 2: Imaging workflow from acquisition to the color survey cards.



Figure 3: The image color indexing technique to extract a color palette of the dominant colors.

In our case a two-step process was chosen:

- neutralization with respect to a gray color patch (to avoid the typical problems of white due to excessive exposure),
- color correction with respect to the target patches whose color values are known *a-priori*.

Essentially, a captured color image enclosing the reference chart color image is neutralized, balanced, and properly exposed for the gamma of the reference data set. Since two shots cannot be taken in the same frame (i.e., shots with and without the target) we developed a protocol to use the same calibration for groups of images with the same features (i.e., orientation, exposure, and framed surfaces) (Figure 2). Group of photos depicting a whole street or a whole building corresponded to less than ten different profiles, thereby maintaining consistency in the results (Apollonio et al. 2017). As rendered color space, we selected the popular IEC 61966-2-1 sRGB, a color space 100% viewable on the common consumer monitor. Its limited range of colors drawback, narrower than that of human perception is limited in our case, because misrepresented colors are rarely found in our case studies.

Image-based techniques used to analyze colors at the different scales using only images, are:

- image stitching to reproduce full orthogonal elevations for façades and orthographic street views (Figures 6,7),

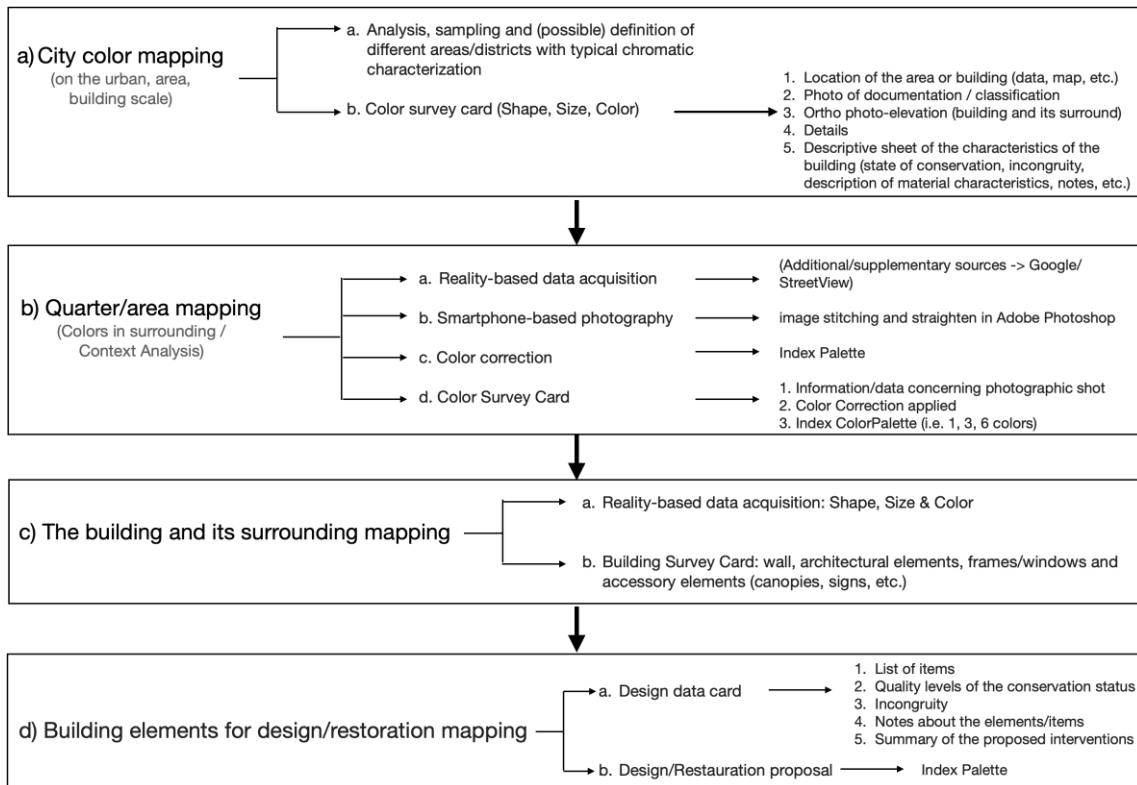

Figure 4: The multiscale workflow.



A multiscale approach to the urban space color analysis starting from the case of study of the Collegio di Milano

- image blur to extract medium color of façades (Figure 7),
- image color indexing to extract color palettes of the dominant colors, a technique particularly suitable for the city color mapping (Figure 3).

A color survey card was developed based on the Pantone color system that, despite some limitations and due to its growing diffusion and the easy conversion of captured color in the sRGB color space, allows an excellent quickness, usability and shareability among the many users involved in the urban color design process.

Main feature of the developed survey card is the color mapping by Pantone and color lightness. This solution allows a quick understanding of hue and lightness for objects at the same scale and at different scales, improving the knowledge in the cases where near neutral colors are dominant and/or perceived color changes are based on the illuminant changes.

In Figure 4 the whole developed workflow is summarized.

### ***THE COLLEGIO DI MILANO CASE STUDY***

Milan is a city populated by 1,378,689 inhabitants in Northern Italy and an historical center with façades presenting near neutral color, mainly grey, beige and brick red.

The Collegio di Milano, designed by the famous Italian architect Marco Zanuso, our case study, is in the South part of the city, embedded in an expansion area developed mainly in the 1960-70s, the Barona area near the Sant’Ambrogio Quarter (Figure 5). The neighborhood consists principally of a large social housing estate designed by the architect Arrigo Arrighetti in 1963, shaped with several very long curved buildings that enclose a large central area of public green space (Figure 6).

The Collegio di Milano complex, the sophisticated brick building - currently used as a residence for university students - was built in the 1970s as a center for assistance to African countries, offering around 100 rooms and shared amenities, in an over 20,000 square meters wide park. The building was subject of renovations several times, which partially altered its interpretation. During 2003, the carried-out renovation works involved the construction of accommodation for the professors on the top floor terrace, the construction of an iron and glass roof and the relocation of the caretaker's accommodation. In 2007 an extension was built, echoing the original system planimetrically but with a simplified façade in brick red colored plaster.

The complex, as the Arrighetti’s social estate intent, somehow tries to keep the memory of a pre-existing landscape made of large farmland, with crops and woodland typical of the countryside.

Through research, we found in the application of building materials that there are mainly brick veneer, plaster, wood and metal frames, metal blinds, plastic pipes, transparent glasses, gneiss marble, frames, and metal mesh. Since the whole volume is clean, minimalist, and there is no rain-proof area, when we arrived at the site, we found that the original façade in Collegio di Milano, the brick tiles, has begun to fall off at the right-angle junction in the most fragile side; also the ceiling of some balconies is leaking. The brick color is dull and uneven due weathering and time. Near this material-based architecture, buildings with more usual situations as color on plaster were composed.

### ***RESULTS AND CONCLUSIONS***

In Figures 5-8 the results of our method applicated to the case study in the Collegio di Milano are illustrated. In detail, in Figure 5 is the color mapping related to the Barona area. In Figure 6 is the color mapping of the Collegio di Milano buildings and material details. The perceived color imagery of the Collegio di Milano’s landscape tended toward a clear tone (flat and harmonious).

A multiscale approach to the urban space color analysis starting from the case of study of the Collegio di Milano



Figure 5: Urban environmental color of Barona area.

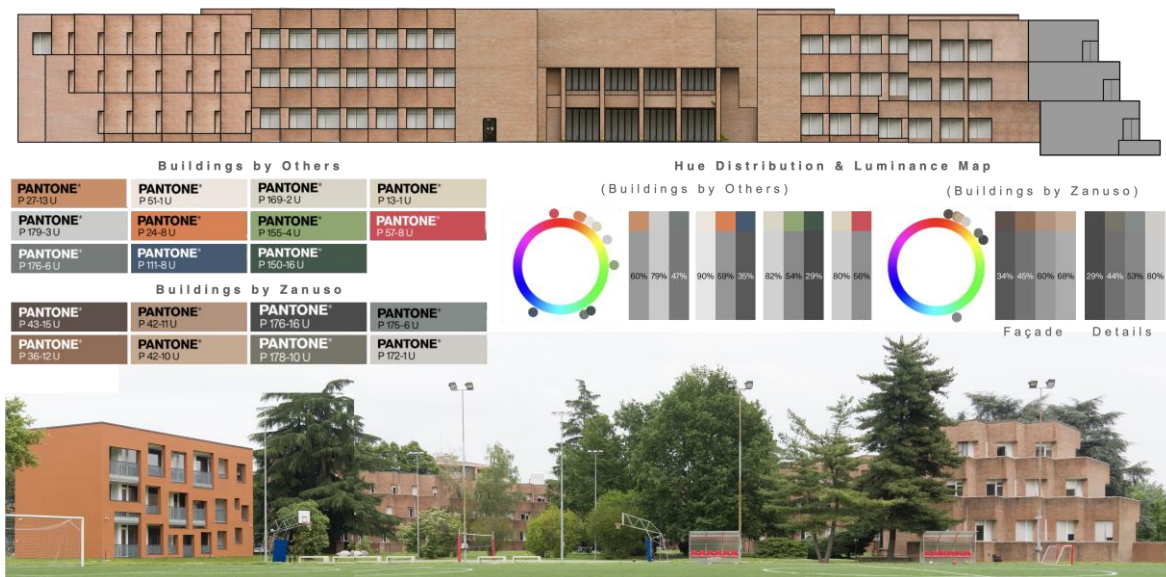

Figure 6: Urban environmental color of Collegio di Milano.

The color appearance of the campus architecture complex's façade is common in red burnt brick with an overall lightness distribution range 60%-68% (medium to high). In the right-angle junction of most balconies, the color becomes dull, the lightness distribution ranges 34%-45% (medium to high). The red, blue fitness equipment and the green lawn present a triad of colors, which also give hue and contrast.

Figure 7 shows the colors and the value of the urban environmental color of buildings surrounding the Galleria Vittorio Emanuele in Piazza Duomo.

Figure 8 show the measurements of lightness and hue of Collegio di Milano complex and Piazza Duomo façades allowing to quickly understand the mood of different urban environments.

A multiscale approach to the urban space color analysis starting from the case of study of the Collegio di Milano



Figure 7: Urban environmental color of buildings surrounding the Galleria Vittorio Emanuele in Piazza Duomo.

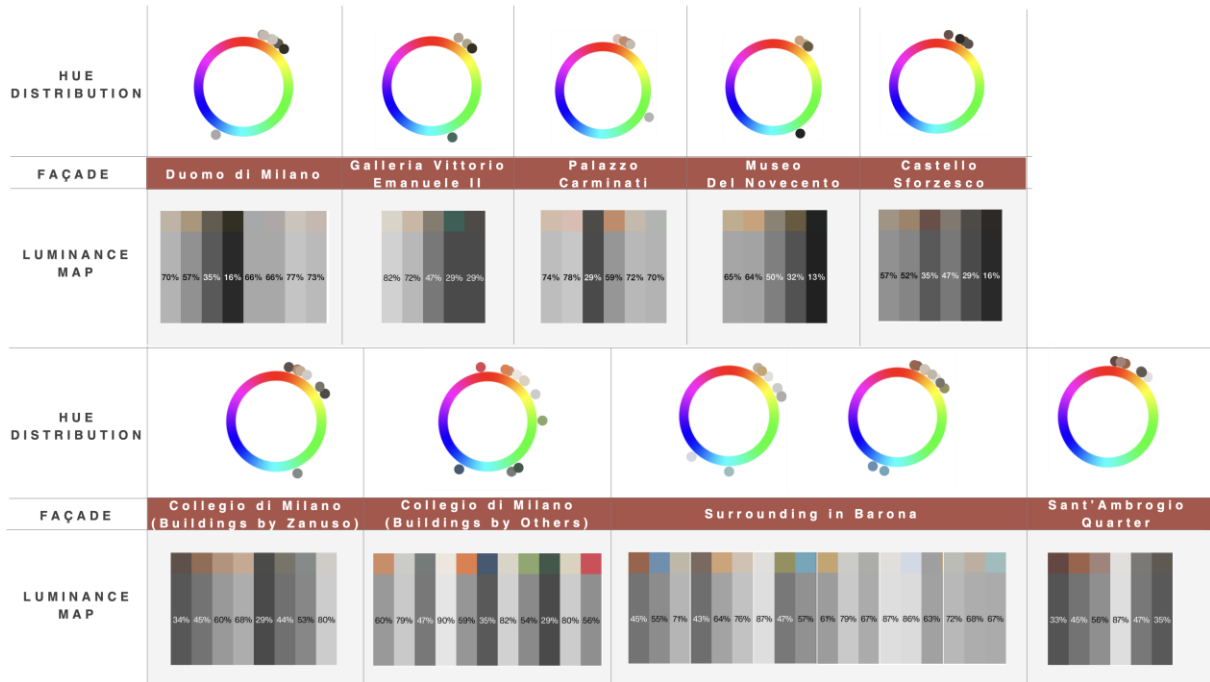

Figure 8: Hue and lightness maps of the colors of Piazza del Duomo (top) and Collegio di Milano with its surroundings (bottom).

## REFERENCES

- Apollonio, F. I., M. Gaiani, and S. Baldissini. 2017. Color definition of open-air Architectural heritage and Archaeology artworks with the aim of conservation. *DAACH* 7: 10-31.
- Foster, D.H. 2011. Color Constancy. *Vision Research* 51(7): 674-700.
- Gaiani, M., F. I. Apollonio and A. Ballabeni. 2021. Cultural and architectural heritage conservation and restoration: which colour? *Coloration Technology*, 137(1): 44-55.
- Moughtin, C., Oc, T. and S. Tiesdell. 1999. *Urban Design: Ornament and Decoration*, 2nd edition, Oxford: Architectural Press.
- Schiaffonati, F., A. Majocchi and G. Castaldo. 2019. *Designing Dwelling, The architecture of the Collegio di Milano*. Milano: Skira.
- Westland S., K. Laycock, V. Cheung, P. Henry, and F. Mahyar. 2007. Colour Harmony. *Journal of the International Colour Association*, 1: 1-15.

# Application of hyperspectral camera and spectroradiometer for spectroscopic and colorimetric measurements on polychrome surfaces in a controlled environment: pros and cons of the presented technologies

Filippo Cherubini <sup>1,\*</sup>, Andrea Casini <sup>1</sup>, Costanza Cucci <sup>1</sup>, Marcello Picollo <sup>1</sup>, and Lorenzo Stefani <sup>1</sup>

<sup>1</sup> Istituto di Fisica Applicata "Nello Carrara" del Consiglio Nazionale delle Ricerche (IFAC-CNR); (f.cherubini, a.casini, c.cucci, m.picollo, l.stefani)@ifac.cnr.it

\* Corresponding author: f.cherubini@ifac.cnr.it

## Abstract

The aim of this work is to compare the data obtained with two technologies, namely a hyperspectral camera and a spectroradiometer, to study the color and colorimetric parameters of polychrome surfaces.

These measurements are generally carried out with dedicated instruments, such as colorimeters and spectrophotometers, which require contact with the surface and cover areas of the order of tens of mm<sup>2</sup>. These two characteristics, contact and a very small analysis area, can severely limit the study of polychrome surfaces, as the measured areas are not necessarily representative of the entire surface. Furthermore, it is not always possible to touch the analyzed objects.

A possible alternative is the use of compact hyperspectral cameras, such as Specim IQ, for the in situ study of the spectral and colorimetric characteristics of these surfaces.

To better address this research, still in the preliminary phase, a measurement set with lighting geometry fixed at 45° with respect to the image plane was defined in the laboratory to uniformly illuminate the investigated surface and avoid having components reflected specularly on the camera lens. With this fixed shot geometry, a series of Labsphere color standards (eight different color samples) will be analyzed using four different color backgrounds.

In this way, it will be possible to define the optimal operating characteristics of the hyperspectral camera for laboratory measurements aimed at studying the color of polychrome surfaces.

**Keywords:** *hyperspectral imaging, color standard, spectroradiometer, Specim IQ.*

## INTRODUCTION

The introduction of a new technology in the field of remote sensing called Imaging Spectroscopy (IS) revolutionized the scientific research of the study of the Earth's during the 1980s (Goetz et al. 1985).

This technology, in its version of hyperspectral imaging (HSI), allows to acquire an almost continuous sequence of spectroscopic images (hundreds) in contiguous and narrow spectral bands (bandwidth <10 nm) over an extended spectral range, generally from the visible (VIS, 400-750 nm) to near infrared (NIR, 750-2500 nm). Over the years, the field of application of this technology has also extended to other areas, especially in the field of cultural heritage (CH), Cucci et al. (2016).

The information obtained from the (HSI) dataset has a high information content and can be processed using different algorithms, according to the type of final information required (relationships between selected spectral images, extraction of a reflectance spectrum for each point of the framed surface, etc., Cucci et al. 2016).

Over the years, the development of this technology has made it possible to reduce and compensate the initial technological limitations (equipment was bulky and difficult to adapt to different working environments), extending the possibility of using hyperspectral technology also outdoors. Among the new image spectroscopy systems available for these applications in the present work the Specim IQ

hyperspectral camera, developed by SPECIM Spectral Imaging Ltd. (Oulu, Finland, [www.specim.fi](http://www.specim.fi)) was considered (Behmann et al. 2018; Cucci et al. 2017).

While representing a technological solution with considerable advantages in terms of portability, the Specim IQ camera has some aspects to be clarified regarding its use for 'quantitative' measurements both in a controlled environment, well-defined instrumental set-up with artificial lighting, and in outdoor environments with natural light (Signoroni et al. 2020).

The reasons for this research tend to want to analyze the accuracy, repeatability and reproducibility of the data acquired by this camera for applications aimed at the colorimetric calculation of two-dimensional objects, through a study in a controlled environment of Spectralon® Color Standards and Grey Standards. (Labsphere, New Hampshire, USA).

### ***TECHNICAL INFORMATION ABOUT THE SPECIM IQ CAMERA AND THE SPECTROCOLORIMETER:***

The Specim IQ covers the 400 – 1000 nm spectral range and provides 7 nm spectral resolution with 3.5 nm spectral sampling and the resulting image from Specim IQ is 512 x 512 pixels, with all the pixels containing 204 spectral samples.

This camera integrates a hyperspectral sensor with additional color cameras and it has also replaceable data storage and batteries. The integrated color cameras support the spectral camera usage by making it possible to direct and point the camera with standard viewfinder image as well as adjust the manual focus of the spectral camera with a normal camera image.

The operating system is designed in a way that it will guide the user to consider the necessary camera adjustment and data quality validations, without a need to go into details of the hyperspectral imaging technology details.

The hyperspectral data acquisition with Specim IQ can be made both outdoor and indoor conditions, with Sun light or artificial, broadband illumination. In addition to the Specim IQ and possible illumination, a reflectance reference targets are needed to correct the effect of the illumination and ambient environment effect from the data, and make the measurements made in different conditions comparable with each other's.

The camera visualizes the hyperspectral data immediately after the measurements and the user has possibility to add metadata to the measurement; the camera will also process the data and provide the processing results visualization for the user.

A Konica-Minolta model spectrophotometer CM-700d was also used. It is equipped with an integrating sphere; it has a measurement geometry d/8° and works in the 400-700 nm spectral range with 10 nm acquisition step. The light source and detector are a pulsed xenon lamp with UV cut filter and a silicon photodiodes array, respectively. The instrument is provided with its own white reference (100% reflective) and a zero calibration box (0% reference).

### ***EXPERIMENTAL SETUP***

It was decided to organize the data survey campaign by configuring an acquisition set as follows:

- Two 50 W halogen lamps, with correlated color temperature of approx. 3000 K, arranged symmetrically at 45° with respect to the targets at a distance of 45 cm from the reference plane to produce a homogenous illumination of the investigated surface and to avoid the presence of specular reflected radiation on the camera lens;
- An average of about 1350 lux of illumination on the reference plane;

- Specim IQ camera arranged on the lamp holder frame (distance of 45 cm from the measuring surface) between the two lamps;
- Set of 8 Spectralon® Color Standards color targets, nominally red, orange, yellow, green, cyan, blue, violet, purple, and a set of 4 Grey Standards targets, nominally Grey 75%, Grey 50%, Grey 10%, Grey 2% of reflectance, which were measured by alternately arranging them on four different colored backgrounds (black, white, gray, black and white checkerboard and reflective gold);
- The measurements were run by a single operator; all measurements were acquired in two hours;
- Camera set with fixed acquisition integration time;

The Labsphere certified color targets report the reflectance spectra acquired with a lambda 19 Perkin-Elmer spectrophotometer by using a 150mm integrating sphere. In the present work, it was considered the CIE L\*a\*b\*76 colorimetric values calculated for the observer 2° and D65 illuminant. It has to be noted that the colorimetric data calculated from spectra acquired with different geometries (8°/d and 2x45°/0°) may show different values.

That said, this work was mainly focused on defining the accuracy and robustness of the measurement system under controlled conditions in order to first check the repeatability and reproducibility of the data acquired with the Specim IQ camera finalized to the calculation of the colorimetric parameters.

All the Standard targets (colors and greys) were placed in the same scene and to better evaluate the response of the camera 11 data-cubes were recorded by randomly placing the samples in each scene and using five different backgrounds.

The colorimetric parameters were calculated starting from the data generated by the IQ camera for the CIE L\*a\*b\*76 colorimetric space and with standard observer 2 ° and illuminant D65 after having interpolated the original spectral sampling acquisition of the data-cubes from 3.5 nm to 1 nm by using a custom software.

The L\*a\*b\* data are displayed as TIF format files and processed with the Adobe Photoshop® software. For each target analyzed, an area of about 961 pixels (corresponding to 31 pixels per side) was selected relative to the square inscribed in the target itself. Subsequently, it was decided to focus on four targets, namely Orange, 75%, 50% and 10% Greys, from which the L\*a\*b\* values were extracted with the Adobe Photoshop® dropper tool. The Orange color target was chosen because it was found to have a higher variation in the colorimetric parameters compared to the data provided by the manufacturer than the others.

## **RESULT AND DISCUSSION**

The acquired HSI data were processed with the software Specim IQ Studio using the SAM (Spectral Angle Mapping) algorithm with a very narrow tolerance (MA = 0.10 radians) to determine the accuracy of the imaging spectral system and to compare these spectra with those provided by Labsphere. The Specim IQ spectra show a good correspondence with the reference ones regardless of the position of the sample in the scene and acquisition background (fig. 1).



Application of hyperspectral camera and spectrophotometer for spectroscopic and colorimetric measurements on polychrome surfaces in a controlled environment: pros and cons of the presented technologies

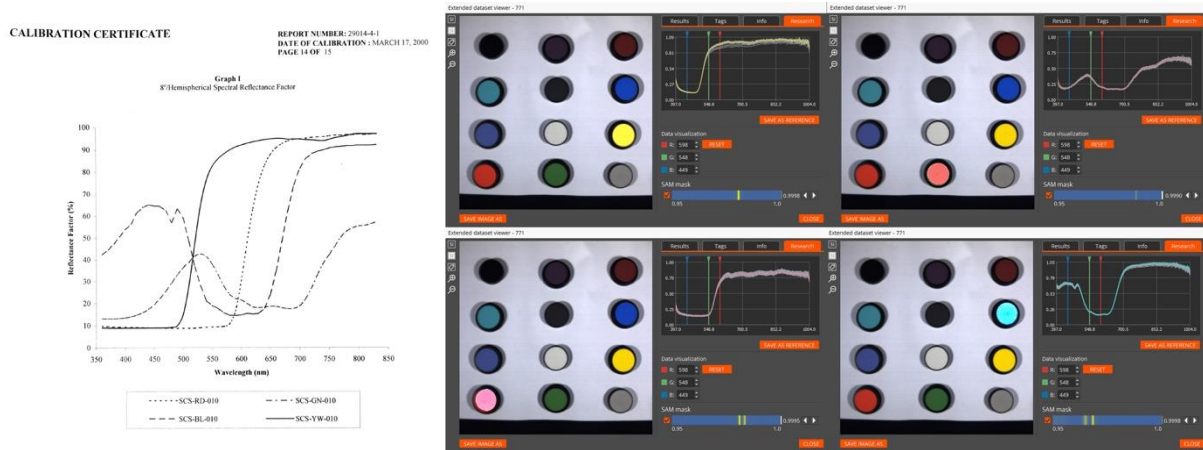

Figure 1: Labsphere reference spectra (left) and Specim IQ spectra (right) of the colored target.

The  $L^*a^*b^*$  values calculated for the IQ camera data were compared with those obtained by the Konica-Minolta spectro-colorimeter CM-700d, which are reported for comparison purpose in table 1.

	<b>Grey 75%</b>	<b>Grey 50%</b>	<b>Grey 10%</b>	<b>Orange</b>
	<b><math>L^*/a^*/b^*</math></b>	<b><math>L^*/a^*/b^*</math></b>	<b><math>L^*/a^*/b^*</math></b>	<b><math>L^*/a^*/b^*</math></b>
IQ \ CM700d	89/0/1	74/0/1	38/0/1	70/45/40
771	91/0/0	74/0/0	40/2/-4	65/43/33
772	91/0/1	74/0/0	40/2/-4	67/44/34
773	92/0/1	74/0/0	40/2/-4	67/44/34
775	91/0/0	74/0/0	40/2/-4	67/44/34
780	90/0/2	74/0/1	38/1/-1	66/44/36
782	90/0/3	74/0/1	35/0/0	67/45/37
783	89/0/2	73/0/1	38/1/-1	64/43/36
784	91/0/2	73/0/1	39/1/-1	69/46/39
785	87/0/2	75/0/1	36/1/-1	69/46/38
786	91/0/1	75/0/0	37/1/-2	72/47/35
787	89/0/0	72/0/0	36/1/-3	69/46/35

Table 1: colorimetric values of the four selected Spectralon targets.

**CONSIDERATION FOR FUTURE DEVELOPMENT**

The Specim IQ results are extremely encouraging. In fact, thanks to a well-performed white calibration and a stable imaging setup, it was possible to determine that the spectroscopic data acquired at close

distances and with homogeneous illumination are sufficiently coherent for all standards even with different backgrounds and positions in the scenes.

If the individual  $L^*a^*b^*$  values are analyzed, the data for luminance ( $L^*$ ) and the data for the green–red axis ( $a^*$ ) present a maximum variability of about 2–3 units. The blue–yellow opponents ( $b^*$ ), on the other hand, have a different response with a maximum variation of about 5 units.

Furthermore, the Photoshop software, through its 'dropper' tool, only allows you to view the integer values  $L^*a^*b^*$ ; it is therefore not possible to evaluate and compare the calculated CIEL $^*a^*b^*$ 76 values with more precision.

It is also important to remember that the imaged scene, despite having been homogeneously illuminated, had slightly variable LUX values at the corners of the shooting scene and this certainly affected the variability of the data reported above.

These preliminary results support the hypothesis that the SPECIM IQ camera can be applied to perform colorimetric studies with sufficient accuracy and reliability at least under controlled shooting conditions. Nevertheless, further laboratory experiments will be performed to validate these preliminary data to take in consideration the comments reported in other researches, Signoroni et al. (2020).

## REFERENCES

- Behmann, J., K. Acebron, D. Emin, S. Bennertz, S. Matsubara, S. Thomas, D. Bohnenkamp, M.T. Kuska, J. Jussila, H. Salo, A.K. Mahlein, and U. Rascher. 2018. Specim IQ: Evaluation of a New, Miniaturized Handheld Hyperspectral Camera and Its Application for Plant Phenotyping and Disease Detection. *Sensors* 2018, 18:441. doi:10.3390/s18020441.
- Cucci, C., J.K. Delaney, M. Picollo. 2016. M. Reflectance hyperspectral imaging for investigation of works of art: Old master paintings and illuminated manuscripts. *Acc. Chem. Res.* 49: 2070–2079.
- Cucci, C., Casini, A., Stefani, L., Picollo, M., Jussila, J. 2017. Bridging research with innovative products: A compact hyperspectral camera for investigating artworks: A feasibility study. In: *Optics for Arts, Architecture, and Archaeology VI*; Pezzati, T., Ed.; SPIE: Bellingham, WA, USA, Volume 10331, 1033106-1-13.
- Goetz, F. H., G. Vane, B.N. Solomon, N. Rock. 1985. Imaging Spectrometry for Earth Remote Sensing. *Science* 1985, 228: 1147–1152.
- Signoroni, A., M. Conte, A. Plutino, A. Rizzi. 2020. Spatial–Spectral Evidence of Glare Influence on Hyperspectral Acquisitions. *Sensors* 2020, 20:4374 . doi:10.3390/s20164374.





# Color, ceramics and architecture in the Spanish Renaissance. Serlian serial ceramics and their role in the construction of a new spatiality

Jorge Llopis <sup>1,\*</sup>, Juan Serra <sup>1</sup> and Irene de la Torre <sup>1</sup>

<sup>1</sup> Grupo de Investigación de Color en Arquitectura, Instituto de Restauración del Patrimonio, Universitat Politècnica de València; jlllopis@ega.upv.es, juanserra@ega.upv.es, irdela@ega.upv.es

\* Corresponding author: jlllopis@ega.upv.es

## Abstract

In Spain, an important tile industry developed during the 16th century which, based on a fusion of traditional techniques together with motifs and new techniques coming from Italy, spread over the Iberian Peninsula and through the Spanish colonies in America. Polychrome ceramics played an important role in the introduction and dissemination of Renaissance designs in architecture. Architectural color, by means of large full-colored ceramic wall panels, created on the basis of modular geometric designs after Sebastiano Serlio's treatises, became a fundamental compositional variable in the introduction of the new Renaissance aesthetics in the territories of the Spanish Empire. The combination of Renaissance ceramic pieces, designed with a limited number of ornamental motifs expressed with a reduced color palette, created interesting compositions that refer directly to this artistic period. This historical study highlights the direct link between tilework and the Renaissance architecture it covers, accompanying its stylistic reading and enhancing its representativeness.

**Keywords:** *Color, Ceramics, Spain, Serlio, Renaissance*

## INTRODUCTION

Between 1580 and 1640, the Iberian Peninsula became unified under the Austrian monarchy. This fact, together with the expansion of the Spanish Crown over large American territories, generated the political unity of an extensive Empire. The Habsburgs undertook an extensive building program aimed at providing the Empire with a unitary and recognizable architectural image based on the assimilation of classicist architectural forms imported from Italy.

In interior spaces, lacking classical formal elements, the polychrome ceramic panels, widely used in both public and private buildings, were the only element that allowed the formalization of this architectural program. The use of ceramic panels rested upon a pre-designed and easily exportable material, which could be distributed throughout the Empire. Through this strategy, uneducated craftsmen without any knowledge of architectural composition could use ceramic panels to compose murals whose design was ultimately derived from the prints in the main treatises, especially those by Sebastiano Serlio. In this way, classical designs were transferred to all types of architectural spaces in Spain, Portugal or the American colonies, generating an architectural "standard" based on the polychromy of the ceramic panels that guaranteed the transmission of Architectural Classicism at all levels.

### Spanish Renaissance architecture and the new spatiality

Within Spain, it is traditionally established that the use of this type of Renaissance ceramics originates in Seville, through the figure of the Italian ceramist Francisco Niculoso (Gestoso 1904). The new technique gave the clay support a pictorial treatment, using a wide chromaticism called the palette of great fire (Menéndez, 1991). In Seville, and from a tradition of massive use of Muslim tilework, a symbiosis will develop between traditional tilework and Renaissance tilework that will be massively used in the characterization of interior spaces in order to create a new spatiality. The rooms of the

Color, ceramics and architecture in the Spanish Renaissance. Serlian serial ceramics and their role in the construction... Alcázar of Seville, the *Casa de Pilatos* (Figure 1), or the Palace of the Countess of Lebrija used the chromaticism of ceramic canvases on a large scale to characterize both the most representative spaces and smaller spaces, creating a model frequently replicated in smaller buildings or in rooms of private homes (Pleguezuelo 1989).



Figure 1: *Casa de Pilatos* (Seville).

Technical innovations will spread from Seville to the other major hub of Hispanic ceramic production, located in Talavera. Among the most recognized figures of Talavera pottery stands out the Flemish ceramist Juan Flores or Jan Floris. Appointed by Felipe II in 1563 and raised as a "master of tile-making" (Martínez 1991), he will have an important role in the introduction of the motif of the *ferroneries*.

The third formal influence that will define the ceramic panels of the 16th century derives from the assimilation of classical forms as base tiles for their subsequent combination in larger panels. This assimilation traces back to the survey of the classical orders carried out in Italy and transmitted by the treatise writers; especially in the Spanish translation of Sebastiano Serlio's Books III and IV. Their massive use of images at the expense of text turned them into ideal, easily interpretable formal compendiums for the use of potters, as they made extensive theoretical knowledge of architecture unnecessary (Llopis et al. 2014).

All this set of influences gave rise to a standardized tilework used almost indistinctly in all the regions of the Empire.

The present paper aims to verify the direct link between Renaissance tilework and the architecture of that historical period. The combination of those ceramic pieces, designed with a limited number of ornamental motifs embodied with a reduced color palette, leads to interesting compositions that refer directly to the Renaissance architecture it covers, accompanying its stylistic reading and enhancing its representativeness.

### **METHODOLOGY: COMPOSITION AND COLOR ANALYSIS OF SERIAL CERAMICS OF SERLIAN ORIGIN**

In order to verify the relative formal uniformity and the reduced color palette of the Renaissance tile designs, we present an annotated selection of the most representative samples of this period below. To determine the chromatic characteristics that define this architectural ceramic, we have carried out

Color, ceramics and architecture in the Spanish Renaissance. Serlian serial ceramics and their role in the construction... a color measurement in Natural Color System (NCS) notation of one of the tiles that make up the baseboards of the Corpus Christi Church in Valencia, using a “NCS Color Scan” contact colorimeter.

### The formal origin of the designs

Due to their abundant presence and wide geographic dispersion, the inverted pyramid and the pointed pyramid shaped tiles –also known as "nail" or "diamond-tipped tiles"– stand out among the first standardized designs (Panels Tiles No. 1 and 2 respectively, within Figure 2 above). They seem to be original from Talavera, and frequently combine with each other. Their design stems from various prints in Serlio's treatise, where they appear in various contexts. Panel Tile No. 1 appears, for example, in Book III, folio XLIIIv, on the back of a cornice, and is made up of a truncated pyramid with a central flower. Panel Tile No. 2 takes the shape of a nail, and appears, for example, in a print on folio XVIIv from Serlio's Book IV, having its origin in masonry wall designs. A third Panel Tile model is No. 3, which, unlike the previous ones, originated in the Flemish *ferroneries*. It traces back to engravings by authors such as Cornelis Bos, who were very successful at the time.

These tiles were freely combined to generate complex wall panels, to which the color provided a strong volumetric effect. They were completed with a wide range of borders that finished off the edges, closing the composition. Although floral and even anthropomorphic designs were occasionally used, potters often resorted to purely architectural designs that, once again, had its origin in the prints of Sebastiano Serlio's treatise. Border Panel nº1 stands out as an example. It is a tile made up of parallel bands, in which eggs and leaves, waves, spirals and palmettes are arranged, respectively. Serlio uses the original motif in classical entablatures such as those drawn in Book III, fol. LXXIII and in Book IV, fol. SLV. The tendency to partial and decontextualized use of these motifs in the tiles can be seen in the individual use of the *ovas* in independent tiles in the case of Panel Border nº3. Serlio frequently uses this element in combination with other moldings, such as the Ionic capital in Book IV, fol. LXXVI. In fact, Serlio himself, in an image from Book IV, folLXXVI, offers moldings to be freely combined according to specific needs, several of which were used by 16<sup>th</sup>-century tile-makers so as to formalize the tiles of the architectural panels of Serlian origin that we are discussing here (Pérez, 1996).

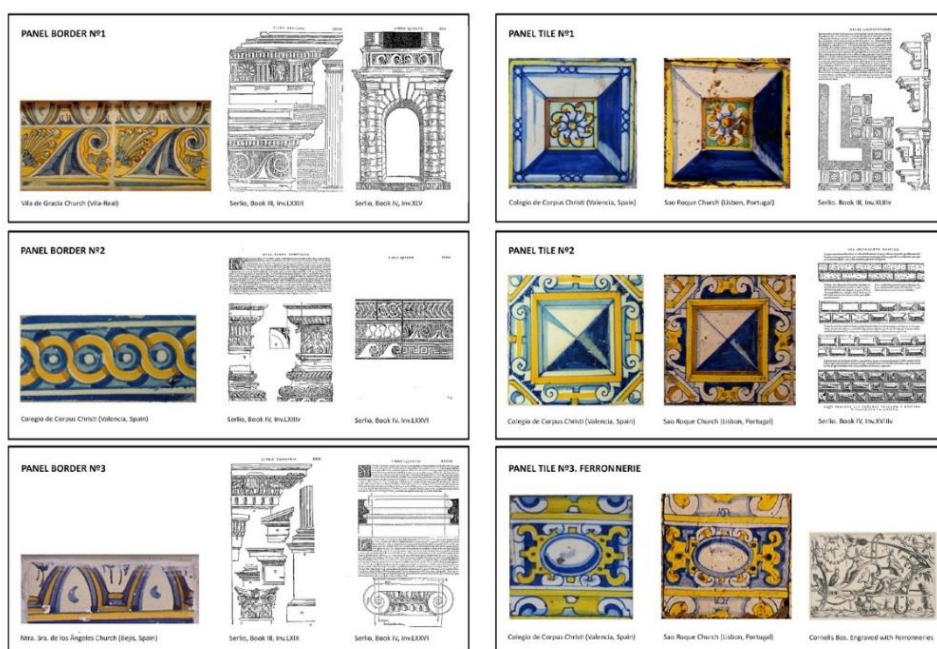

Figure 2: Panel Tiles of Serlian origin.

### The color palette

Although the morphological-ornamental repertoire is small, the possibilities for combining these tiles were almost endless, since the possibilities of variation in the distribution of the modular pieces could give rise to very diverse formal and chromatic effects (Figure 3). However, we can say that there was a standard compositional pattern, originated in Italy and invariably repeated in places as geographically remote as the Corpus Christi College in Valencia and the Church of São Roque in Lisbon.



Figure 3: From left to right and top to bottom: 1. Church of São Roque (Lisbon); 2. Old Saint Paul's College (Valencia); 3. Corpus Christi College (Valencia); 4. Chapel of the Roser (Valls); 5. Church of São Roque (Lisbon); 6. Corpus Christi College (Valencia); 7. Convent of Saint Dominic (Lima); 8. Sanctuary of the Holy Cave (Altura, Valencia) y 9. San Juan de Ribera College (Burjassot, Valencia).

In the case of tile panels of Serlian origin, dominant ranges were established and repeated almost without modifications over time. Their basic colors are obtained with a constant and reduced number of pigments, to which three main colors correspond. First, a cobalt blue pigment, which corresponds to a slightly reddish blue hue, of a certain blackness and medium chromaticity S 5040-R80B. In second place, a lead antimonate yellow pigment, corresponding to a very pure and chromatic yellow coloration that some authors describe as "lemon yellow" (Pérez 1996: 62) S 1060-G90Y. Thirdly, a tin white pigment, used for backgrounds, and to which a coloration close to S 0505-Y10R corresponds. From the mixture of these three main pigments, the ceramic color palette broadens, with the presence of blues of less blackness S 0530-R80B to delineate some figures, and a light greenish background S 2040-G40Y for the flower central. A light orange iron oxide pigment, slightly saturated and close to the ocher S 2060-Y10R, draws some isolated geometry (Figure 4). Other pigments were also known (copper for green, manganese for purple, orange and ferruginous brown), but the blue-yellow pairing clearly predominates (Pérez 1996).

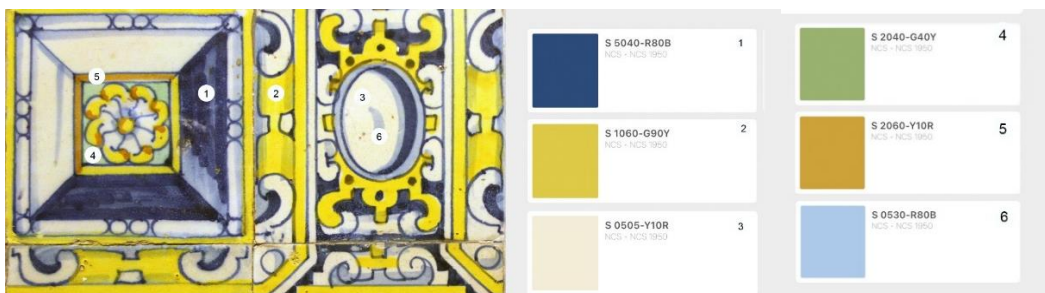

Figure 4: Color notations in NCS system referring to blue, yellow, white, green and ocher tones. Measurement made on one of the tiles that make up the baseboards of the Corpus Christi Church in Valencia.



Thus, the contrast between a very dark cobalt blue and an intense yellow is sought. The colors are flat, only the blue color presents two tones to emphasize the volumetry of the designs, (*ovas*, diamond points or incisions) simulating shadows that provide a sensation of three-dimensionality. This profiling can be found with manganese, albeit occasionally. The other base color was antimony yellow, which was used mostly in backgrounds to highlight the volumetry of the architectural elements, usually made in blue. Occasionally these two base colors were reversed, using blue for backgrounds and yellow to define the designs (Border Panel # 2), and sometimes white was used to define highlights in the designs that expanded the volumetric sensation (Border Panel # 3). As Pérez (1996: 62) points out, “the homogeneity of the chromaticism reaches the point that its link to the basic drawing is total and constant: each bounded area in a tile receives always the same color; these are neither altered nor exchanged”. The white color is not used as a background. It rather gives the drawing physicality, with the dark areas acting as proper background instead.

Despite these occasional variations, the basic bichromy defined by yellow and blue was applied to define a base architectural frame, which was used to define the wall plan. It occasionally served also as a support for other panels inserted in the frame, as for example in the Church of São Roque in Lisbon (Figure 5.3), in which independent panels, responding to different compositional and chromatic criteria, were freely inserted into the Serlian ceramic panels that framed them. On further occasions, other tile pieces of different designs were inserted, displaying floral and geometric motifs, in which the chromatic continuity was enriched by using the ochre and green ranges of the floral motifs, as in the Sanctuary of the Holy Cave in Altura (Figure 3.8). Finally, the modular nature of the pieces allowed their free play, and so they were used to frame doors and openings by means of designs that decomposed the base structure to adapt to the geometry of the covered walls, maintaining the bichromatic character of the original design.

### **SERLIAN CERAMICS AND THE NEW SPACIALITY**

The support of the Crown to this strategy of wall ornamentation based on modular tiles of Serlian origin guaranteed its wide dissemination. The use of tile panels turned into a plan to “decorate” spaces according to the criteria of architectural classicism without resorting to classic orders properly. In this scheme, color became paramount to define the architectural spatiality of the 16th and 17th centuries.

The Serlian tile designs, created in Talavera from Italian influences arrived through Seville and from Flemish influences promoted by Felipe II, spread all along the Hispanic territories through a double channel: direct exportation and the training of a staff already familiar with tile techniques, who moved and settled in new territories, establishing local schools that perpetuated iconographic and chromatic models. This diffusion strategy was carried out almost from the beginning, so that by the year 1596 Serlian architectural tiles were used in the Church of São Roque in Lisbon, probably imported from the Sevillian workshop of Hernando de Valladares (Simões 1969) (Figure 5.2). Almost simultaneously, the same tilework, based on identical designs and with identical chromatic patterns, was used in the Corpus Christi College in Valencia (Figure 5.3) by Antonio Simón, “*maestro de hazer obra de Talavera*” [master in tilework of Talaveran style] (Benito 1980). Summoned by the Patriarch Juan de Ribera, Antonio Simón settled in Burjassot near Valencia, where he had his ovens working between 1602 and 1608. Tilework is used in both cases to emphasize the wall panels, and so the spatial definition strategy relies almost entirely on the color of the tiles.



Figure 5: From left to right: 1 Palace of the Countess of Lebrija (Sevilla); 2. Church of São Roque (Lisboa); 3. Corpus Christi College (Valencia); 4. Monastery of San Francisco (Lima).

This strategy will soon spread throughout the peninsular territory, becoming a constant in the spatial definition of Spanish architecture of the time, and reaching America without almost any modifications. And so, the tiles that arrived to the Monastery of San Francisco de Lima in 1620 were almost identical to that imported from Seville to Lisbon by Valladares (Frothingham, 1969) (Figure 5.4).

## CONCLUSIONS

The present study allows us to verify how throughout the 16th and 17th centuries ceramics became a fundamental element in the definition of the new Mannerist architectural spatiality in the territories of the Spanish Empire. Defined both from formal models extracted out of the treatises of Sebastiano Serlio, as well as from the adoption of Italian techniques and models imported by the Seville tile industry, such a tilework was based on techniques and color palettes typical of Talavera ceramics, and spread throughout all the Spanish territories extremely quickly.

Its distribution was a conscious strategy, aimed at implanting Classicism as the language of the Spanish Monarchy. These ceramics allowed the transposition of forms and criteria of classical architecture into disorganized spaces without resorting to the ornamental elements typical of the classicist language, using only color and the sensation of three-dimensionality provided by the ceramic panels. This way color, through ceramics, became the main theme of Spanish architectural space between the 16th and 17th centuries, shaping the spaces according to a uniform pattern recognizable throughout the Spanish Empire, and becoming its hallmark somehow.

## REFERENCES

- Benito, F. 1980. *Pintura y pintores en el Real Colegio del Corpus Christi*. Valencia: Federico Domenech.
- Gestoso, J. 1904. *Historia de los barros vidriados sevillanos*. Sevilla: Archer M. Huntington.
- Llopis, J., J. Serra, and A. García. 2014. *La cerámica de influencia serliana en la arquitectura renacentista peninsular*. COR. Lisboa, 42-67.
- Martínez, B. 1971. Azulejos talaveranos del siglo XVI. *Archivo Español de Arte* 175: 283-294.
- Pérez, I. 1996. *Cerámica arquitectónica valenciana. Los azulejos de serie (XX.XVI-XVIII)*. Valencia: Institut de Promoció Ceràmica de Castelló.
- Pleguezuelo, A. 1989. *Azulejo sevillano*. Sevilla: Padilla Libros.
- Serlio, S. 1552. *Tercero y Cuarto Libro de Arquitectura*. Edición de Juan de Ayala, Toledo.
- Simões, J. M. 1969. *Azulajaria em Portugal nos séculos XV e XVI*, Lisboa: Fundação Calouste Gulbenkian.

# The Emerging Trend of Saturated Colour in the Contemporary Urban Environment: An Updated View of Colour

Beichen Yu <sup>1</sup>, Simon Bell <sup>2</sup>, Giorgio Ponzo<sup>3</sup>

<sup>1</sup> ESALA, The University of Edinburgh, Edinburgh, United Kingdom; aimeeyu24@gmail.com

<sup>2</sup> ESALA, The University of Edinburgh, Edinburgh, United Kingdom; s.bell@ed.ac.uk

<sup>3</sup> ESALA, The University of Edinburgh, Edinburgh, United Kingdom; giorgioponzo@gmail.com

\* Corresponding author: aimeeyu24@gmail.com

## Abstract

This paper presents preliminary findings of my PhD research on the uprising use of saturated colours in urban and landscape design between 2000 and 2008. Based on statistics, this paper identified and illustrated the influence of branding on the use of saturated colour in urban spaces. By analysing the role and impact of colour in the urban environment, this paper argues an up-to-date understanding of colour is essential for both colour design and colour study in contemporary urban settings.

**Keywords:** *Colour, Saturated colour, Urban Environment, Urban and Landscape Design*

## INTRODUCTION

When thinking of the colour of the city, many would naturally associate it with the colour of the buildings, which is often less notable and blend into the background of urban life. Colour is all around in the city, but material-based colours and pastels, rather than bright colours such as yellows, reds, and pinks, dominate in shaping the image of our contemporary cities. Therefore, the presence of strong and vibrant colours in an urban environment easily stands out and draws attention to itself. On a regional scale, colours with solid chromatic characteristics elaborate stories about the socio-cultural traditions, climate, light, and other geographical features (Lenclos and Lenclos 2004). Within the context of individual buildings and urban spaces, distinctive colours are used as a tool to generate a landmark, as in the case of La Villette's Canal in Paris, or to enliven the urban environment through festivals and urban interventions (e.g., O'Conner 2021; Boeri 2017).

However, in the last two decades, through the lens of digital media, particularly social media and design websites, more bold and expressive expressions of colour appeared in urban environments worldwide. This trend of marking urban spaces with saturated colours seems to have become a significant force that has been transforming and shaping the image of the urban landscape. Nevertheless, less than expected is known about this global uprising phenomenon. Furthermore, despite some exceptions, existing theoretical discussions seem insufficient to understand the burgeoning interest in the design of saturated colour in urban spaces and to identify the role of colour in contemporary urban contexts.

To provide insight into this design phenomenon and illustrate the use of saturated colour in urban and landscape design practice, in my PhD project, I have collected over 550 projects in urban public spaces (completed between 2000 and 2018) that feature the use of saturated colour. In my ongoing PhD, saturated colour in the urban environment is studied from two perspectives: a. colour as a design element; b. the urbanism of colour. This paper presents some preliminary findings, focusing on the changes in the interrelationship between colour and the urban environment. By analysing these findings, this paper would like to suggest that an up-to-date understanding of colour is essential for both the design and study of colour in contemporary urban settings.



**TPOLOGY OF DESIGN PROJECTS IN THIS COLOUR PHENOMENON**

Many studies suggest that vivid colours have been widely accepted as an inexpensive treatment to cheer up the environment, especially after a wide range of paint became obtainable (McLachlan et al. 2015; Whyte 2010). Influenced by the success of the Supergraphics movement in urban renewal in the 1960s (McMorrough 2007) and subsequent chromatic intervention projects, such as the city-wide colour restyling in Tirana (Pusca 2008), previous research on saturated colours in the urban environment has mainly focused on the role of colour in the urban intervention (e.g., O'Conner 2021; Boeri 2017). Nevertheless, by categorising the design intentions of the 564 projects, in addition to the urban intervention, there are three types of projects in the urban environment that frequently involve saturated colours: play and sports space, traffic space and branding.

In the process of categorisation, this study found that a design project can involve multiple uses of saturated colour, with approximately 45% of the projects (n=252) falling into more than one category. The results show that 20% of the cases applied saturated colours in the traffic environment (n=113), and this number was doubled in urban intervention projects (n=208) and places designed for play and sports (n= 204), while the use of saturated colours for branding plays a dominant role in this design phenomenon, accounting for more than 60 per cent (n=340). As shown in Figure 1, between 2000 and 2018, branding played a lead role in the increasing use of saturated colours in urban public spaces, especially after 2013. Meanwhile, the uprising trend of using colour to promote in the urban environment has fundamentally influenced other design types. During the 2000s, approximately 40% (n=30) of projects from the other three types (n=72) contained the branding intention. While between 2014 and 2018, more than 200 projects adopted a colour branding strategy, taking up over 65% of projects (n=327) from the traffic space, play and sports space, and urban intervention.

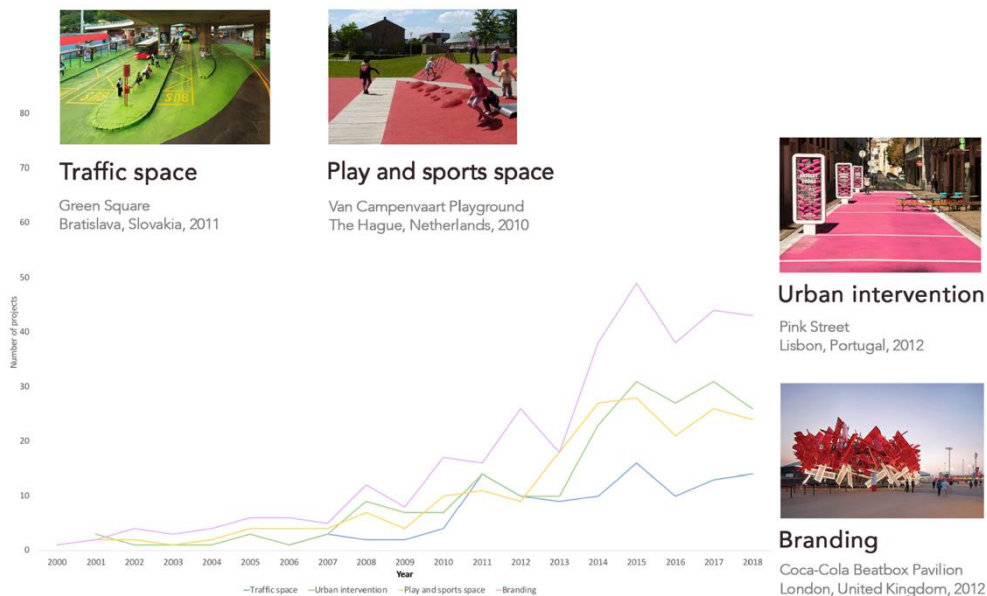

Figure 1: The line chart of project number in the four design types (2000-2018).

Statistical analysis reveals that during the study period (2000-2018), in design projects characterised by saturated colours, branding has become a vital force in urban and landscape design's colour decisions. With increasing attention on the branding aspect of colour in design projects, the presentation of saturated colour in the urban environment has undergone significant changes, making colour a new catalyst for urban development.

### **THE INFLUENCE OF BRANDING**

This study identified three scenarios that emphasise the branding aspect of colour in urban and landscape design: business branding, event branding, and city branding. One primary goal of such projects, albeit for different causes, is to reach as many audiences as possible. Unlike many community-based interventions that applied bright and colourful paint as a treatment for depressed and neglected areas, saturated colours have been brought to the centre stage of the city, especially in international cities.

Concepts based on branding and marketing served as an essential inspiration and principle for engaging saturated colours in the urban environment. As is shown in the data, over 50% of branding projects (n=177) were found in top global cities, including London, Amsterdam, Paris, and New York City. Furthermore, most projects with branding intention were in busy public spaces in the heart of the city (e.g., Figure 2 and 3). In this way, the design project is more accessible and likely to be noticed by wider audiences.



Figure 2 (left): Spark your city, London, United Kingdom, 2015. Figure 3 (Right): Pink Balls, Montreal, Canada, 2012.

"Putting the customer first" is a key slogan for any successful business (Klingmann, 2007). Companies, organisations and even city authorities that wanted to use public space as a platform for branding have adopted this principle. Influenced by the prevalence of smartphones and the bloom of image-based social media, such as Instagram, landmarks or places with unique features have become hot spots to visit and take photos. As people are keen on Instagrammable places, in many projects, eye-catching colours have been arranged to create attractive and uncommon scenes to be featured in photos. In return, to promote through pictures on social media, many design projects consciously used colour to emphasise the place's photogenicity and endow it with a unique identity. As observed in this phenomenon, more urban and landscape designs adopted colour strategy from graphic design, using a neat colour palette and geometric patterns to build an impressive image of a place (see Figure 3, 4).

The Emerging Trend of Saturated Colour in the Contemporary Urban Environment: An Updated View of Colour  
Over 40% of projects (n=233) used only one saturated colour, while most colour combinations (n=235) contained no more than five saturated colours.



Figure 4(left): Pigalle basketball court, Paris, France, 2015. Figure 5(Right): Pigalle basketball court, Paris, France, 2020.

Identifying the primary audience is one of the fundamental principles in business branding (Aaker 2014). Some design projects defined target groups and tailored the colour design according to their preference to maximise the branding effect of saturated colours. Taking the Pigalle basketball court as an example (Figure 4 and 5), those vibrant and bold colours were designed to meet the fresh and dynamic vibe favoured by the younger generation, which was reinforced by the elements from video games in the latest edition in 2020. Given the ever-changing trends in social media and urban culture, the colour design in projects with branding intent must remain responsive and reflective to contend in the game. In addition, for city and place branding projects, the chosen colour can reflect the new image and identity a city/place wants to enrich or rebrand, such as the iconic pink used in the anniversary art installation of the Gay Village in Montreal Canada (see Figure 3).

Considering the persistent fever for Instagrammable places and the speed of images broadcasting through social media, saturated colours could be a catalyst for urban transformation. In many well-designed branding projects, pictures with iconic chromatic features can help the place gain its international reputation and became a hot spot for visitors in no time. In addition to providing visual relief and positive psychological effects, as discussed in many community-based chromatic interventions (McMorrough 2007), saturated colours in branding projects can accelerate fundamental changes in urban spaces. For example, in a government-led revitalisation program in Lisbon, pink was introduced in Cais do Sodré as an aesthetic improvement of the street and a strong branding identity. The colour pink on the road and the symbolisation of pink in favour of the concept "nightlife of distinction" was the focus in the strong media branding campaign for the site (Nofre et al. 2019). The successful online branding attracted both visitors and investments to the region, completely transforming the place into what is today widely known as "The Pink Street".

## **DISCUSSION AND CONCLUSION**

From signboards, posters, billboards to digital screens, eye-catching and distinct colours play a crucial role in the branding of urban advertising. Meanwhile, significant events, such as the 1988 and 2012 Summer Olympics, also engaged saturated colours city-wide to get attention and promote (Opara and Cantwell, 2013). By investigating the rising trend of using saturated colours in urban and landscape design projects from 2000 to 2018, we can see the idea of using colour for branding has expanded from commercial spaces to urban public spaces, from special occasions to daily narratives. Motivated

The Emerging Trend of Saturated Colour in the Contemporary Urban Environment: An Updated View of Colour by branding, more decisions of colour in urban and landscape design begin to focus on users' identity and aspirations. Reinforced by the rise of social media, this transformation has made colour a proactive factor in urban design, with further implications on social, cultural, and economic activities in the urban space.

The emphasis on branding requires colour to be expressional and informative for communication in the urban settings, whether it is about a commodity or city identity. Furthermore, to maximise the effect of branding and stand out in the competition, the colour design in urban spaces is expected to follow the constantly evolving trend or even predict the trend. As it becomes more responsive and reflective to urban culture and the broader context, these "emerging colours" become a new source to understand ongoing urban trends and issues. Last but not least, the popularity of saturated colours has largely shaped the image of the urban landscape in recent years, resulting in changes in urban aesthetics.

The discovery of the rising trend of using colour for branding in urban and landscape design provides a new perspective for evaluating colour in the urban environment. We can see that the urbanism of colour has been reinforced in today's urban context, with more colour changing from a passive element to an active factor in urban transformation. Hence, it is essential to review the role of colour and its multifaceted relationships to better understand and apply colour in the urban environment.

## **REFERENCES**

- Aaker, D. 2014. *Aaker on branding: 20 principles that drive success*. Morgan James Publishing.
- Boeri, C. 2017. Color loci placemaking: The urban color between needs of continuity and renewal. *Color Research and Application*, 42, 641-649.
- Klingmann, A. 2007. *Brandscapes: Architecture in the experience economy*. Mit Press.
- Lenclos, J.-P. and D. Lenclos. 2004. *Colors of the world: The geography of color*. WW Norton and Company.
- Mclachlan, F., A. Nesar, L. Sibillano, M. Wenger di Gabriele, S. Wettstein, and I.B. WHYTE. 2015. *Colour strategies in architecture*, Basel : Zurich, Basel : Schwabe Verlag in association with Zurich : Haus der Farbe.
- Mcmorrough, J. 2007. Blowing The Lid Off Paint. *The Architectural Coverage of Supergraphics*. Hunch (Rethinking Representation), 68-77.
- Nofre, J., J.C. Martins, D. Vaz, R. Fina, J. Sequera, and P. Vale. 2019. The 'Pink Street' in Cais do Sodré: urban change and liminal governance in a nightlife district of Lisbon. *Urban Research and Practice*, 12, 322-340.
- O'connor, Z. 2021. Tactical urbanism: Colour interventions with purpose. *Color Research and Application*, 46, 516-523.
- Opara, E. and J. Cantwell. 2013. *Best Practices for Graphic Designers, Color Works: Right Ways of Applying Color in Branding, Wayfinding, Information Design, Digital Environments and Pretty Much Everywhere Else*. Rockport Publishers.
- Pusca, A. 2008. The Aesthetics of Change: Exploring Post-Communist Spaces. *Global Society*, 22, 369-386.
- Whyte, I. 2010. *Bruno Taut and the architecture of activism*, Cambridge University Press.



# A Color Inventory of and a Color Guide to Dresden's Neustadt

Ralf Weber<sup>1,\*</sup>, Kine Angelo<sup>2</sup>, Thomas Kanthak<sup>1</sup> and Maya Weber<sup>1</sup>

<sup>1</sup> Technische Universität Dresden, University Color Research Collection, Department of Architecture; ralf.weber@tu-dresden.de, thomas.kanthak@tu-dresden.de, maya\_weber@icloud.com

<sup>2</sup> Norwegian University of Science and Technology, Faculty of Architecture and Design, and Dresden Fellow (Spring 2020) at the University Color Research Collection, TU Dresden, Germany; kine.angelo@ntnu.no

\* Corresponding author: ralf.weber@tu-dresden.de

## Abstract

This paper describes the pedagogic structure and the results of a weeklong exercise at the TU Dresden, during which a color inventory of six city blocks of the Neustadt District was compiled and used as a basis for the future use of color on facades in this neighborhood. In 2020, we tested a completely redesigned project structure for the third week of the three-week intensive course which might serve as a model for future student projects and could indeed become an instrument for many city planning departments' approaches to deal with color in urban design.

**Keywords:** *Color Pedagogics, Urban Color Strategies, RAL Design System, Color Inventory*

## **INTRODUCTION - URBAN DESIGN AS PART OF TU DRESDEN'S THREE WEEKS OF COLOR**

TU Dresden's intensive course "Three Weeks of Color" in architecture is unique within the European architectural academic landscape and has in part served as an impetus for initiating color programs at other architecture schools in Europe. While architectural education usually has very little if no emphasis on color, here the students are introduced to color as an integral part of buildings and cities right at the beginning of their studies, namely in the first semester through a 150–200-hour intensive course. The first week starts with foundations, followed by a week of color in interiors and is concluded with the final week of color in buildings and urban design. Examples of projects during the third week include the color designs of facades in historical buildings, in village squares or in contemporary housing blocks. Over the past fifteen years, we have developed and constantly refined this course. We have presented the first two weeks of this course at AIC conferences in the past.

In 2020, we tested a completely redesigned project structure for the third week which might serve as a model for future student projects and could indeed become an instrument for many city planning departments' approaches to deal with color in urban design. The project is firmly anchored in a contemporary planning issue in Dresden. The Neustadt district is a large area composed of 19th century housing which was not destroyed during the World War II. It is now a very lively urban area populated with creative professionals, families, and students alike. Many of our students indeed live in this neighborhood, thus they were personally invested in the project. A source of inspiration for restructuring the third week came when we discovered the color inventories assembled by the Haus der Farbe in Zurich, for example, the inventory of the Baselbiet, a small rural district of Basel. This inventory was created as a guide for the use of color in historic preservation and for contemporary buildings in that area. Kine Angelo, from the University of Trondheim, joined the team as a visiting professor thanks to funding from the Federal Excellency Program at the University of Dresden. Professor Angelo has considerable experience in mapping city colors.

## **THE PROJECT SITE AND ASSIGNMENT STRUCTURE**

We focused on six city blocks with ca. 200 multi-story buildings in Dresden's Neustadt district. The area was divided among ca. 200 students who formed 14 workgroups. Each of these groups worked



following a procedure of clearly defined steps which began with an analysis, followed by a color inventory of the individual buildings and the entire blocks, and concluded with the redesign of the color schemes of one city block per group. The sequence of assignments was very regulated. Each eight-hour day started with a longer lecture addressing general issues of color pertaining to the project, followed by introductions to the morning and afternoon exercises. In between, students had intensive work hours where they received desk critiques and handed in their assignments in the evening. These assignments were evaluated by the teachers and critiqued in front of the students the following morning before the start of a new assignment. It is important to the process that each day a task is completed and reviewed before the next step begins.



Figure 1: Selected area of analysis in Dresden's Neustadt district, Student groups and their assignment of buildings.

**STEPWISE PROCEDURE**

**Day 1, morning. Analysis:**

The project began with an analysis of the respective streets. Each student group was given a monochrome elevation of all the houses of the block made with black and white photographs of the street. Then students recorded their first impressions of the street, the individual buildings, their tectonics, and proportion as well as interesting details by means of photographs and drawings. In a further step, they assembled a cartography of the colors of the individual buildings using the RAL Design Plus System as a means of noting the individual colors of five major elements within a facade: Principal colors of the main facade and the ground-floor zone, accent colors of sills, frames of doors and windows and the color of the main entry door. They were allowed to add two more colors if they were deemed to be important for the character of the facade. They began by holding the color charts on the facade. This way they noted down the facade's nominal colors. We use the distinction originally introduced by Karin Fridell Anter between nominal and perceived colors, the latter being the colors which the eye perceives holding the color chart at a distance from the object.

**Day 1, afternoon. Color Palettes of individual buildings:**

For each building, a color cord showing the principal colors from the analysis done in the morning had to be assembled on a paper template in postcard size. Students then worked with supplied pigments to mix the colors and then painted matching color swatches from the RAL numbers they

A Color Inventory of and a Color Guide to Dresden's Neustadt identified in their analysis. This process helped them learn how to mix pigments in different proportions to achieve a desired color. These swatches could be shared amongst the class. From these they assembled a postcard size color profile for each building. These were then placed below the black and white photographs of the matching buildings in the street elevation.

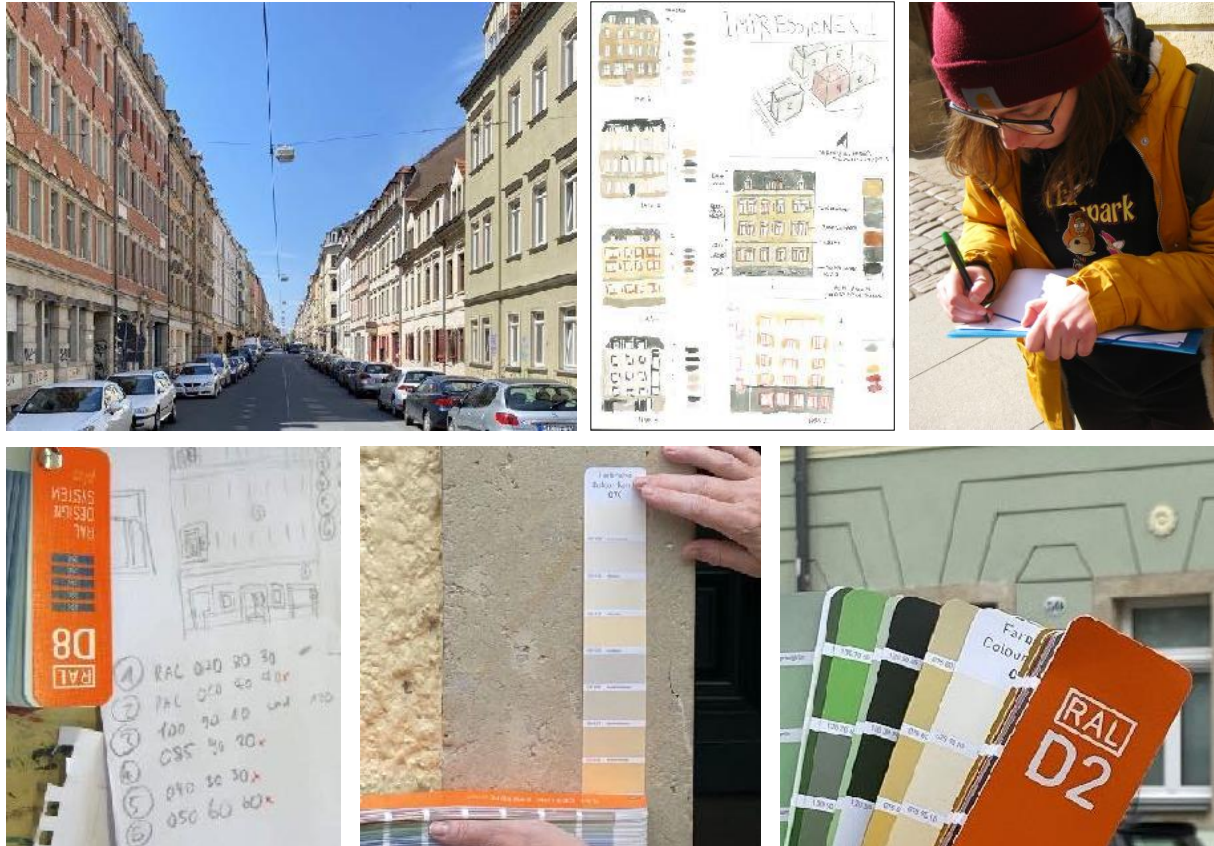

Figure 2: Analysis of the neighborhood, recording nominal and perceived colors with RAL Design Plus System.



Figure 3: Color palettes of individual buildings.



**DAY 2: Color Palettes of the entire block:**

Using the template, each student group had to assemble the colors of all buildings and arrange them according to the major tectonic zones: ground floor, main facade, sills, window frames, entry door. They assembled two color palettes. The first showed the color in equal proportion of the main zones for each adjacent building. This is called "qualitative" analysis. In a second palette they assembled the colors as they appeared in their actual proportion on the building. This is called "quantitative" analysis.



Figure 4: Color palettes of a block through qualitative and quantitative analysis.

**Day 3: Tectonic chords of individual buildings:**

As a last step before the redesign of the individual facades, the student groups had to design three alternative tectonic chords of their facades, using as a point of departure the original color scheme and then replacing some of the principal colors if deemed necessary. The color chords are called tectonic chords, because one can study the differences in appearance depending on the placement of colors. After having decided on the five major colors of the facades scheme, the students had to work with horizontal color bands which represent the major tectonic zones of the buildings. The alternative chords were designed to represent three different atmospheres. Does a color appear differently when placed on top of the chord, i.e., in the upper region of a facade? Does the ground floor zone need a "heavier" color than the upper regions? The choice of one preferential tectonic chord would become the basis for the next step - the redesign of the individual facades.

**Day 4: Revised individual building palettes and redesigned the color scheme of the entire block:**

In the next step, the groups had to negotiate with the teams for the neighboring houses to develop an amended overarching color chord for the block keeping the overall harmony of the entire block in mind.

This new overall color cord became the basis for the design of new or revised color templates for each of the facades. Guiding questions were: how much harmony is necessary; how much can the overall street gestalt tolerate individual accents; what is the overall color identity of a block? Important considerations like these were discussed and one redesigned palette for the block emerged.

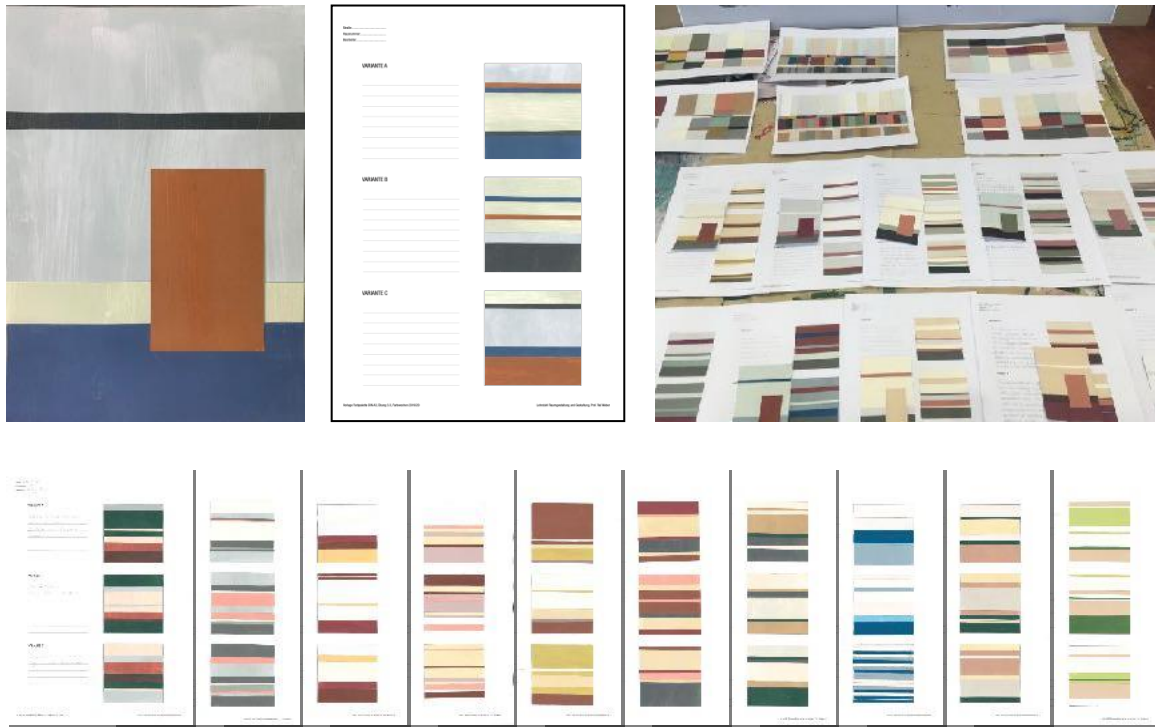

Figure 5: Tectonic cords of individual buildings - a revised or new color-theme in three variations.

**Day 5: Altered color designs for facades, the city block & final presentation:**

The starting point for this exercise was the individual postcard size color palettes of individual buildings which were derived from the commonly developed color scheme for the block. Each individual facade of the block had to be constructed using hand painted color swatches which students had produced previously. These were then assembled together in a street elevation of the entire block and presented in a final presentation to the class.

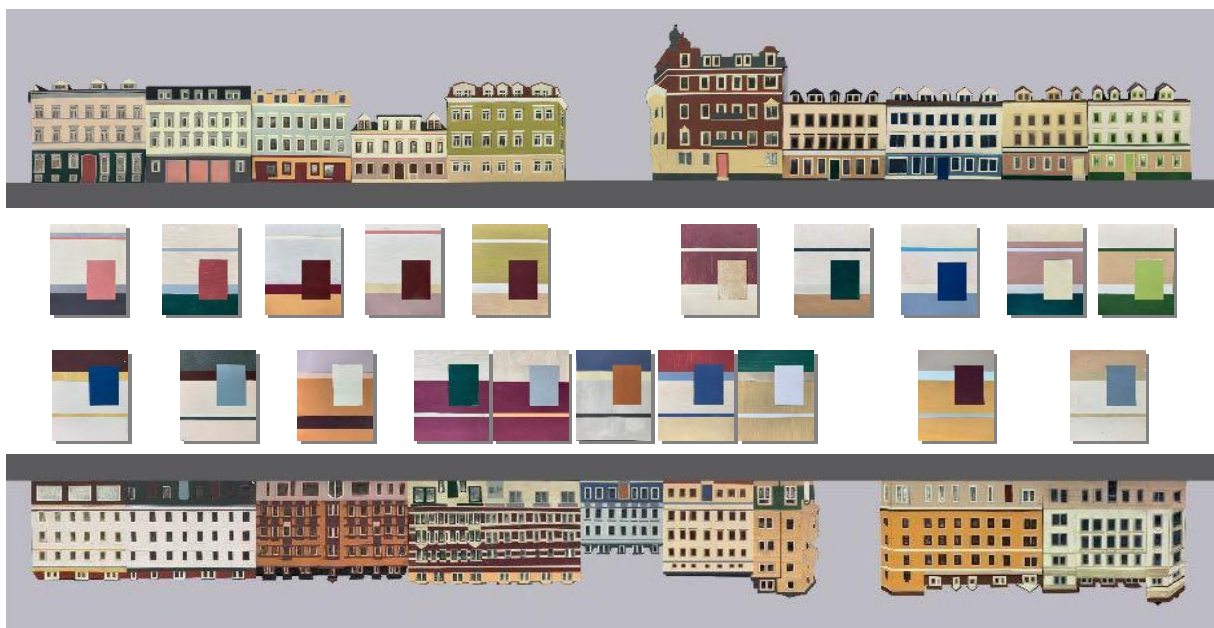

Figure 6: Part of final presentation - new color designs with color palette and hand-produced colors of facades.

The pandemic got the better of us, and our plan to present these results in City Hall to the residents of the neighborhood in our study were put on hold. However, we hope to realize this in the coming year.

## **CONCLUSION**

When the results were presented, it was stunning to see the difference between ‚before‘ and ‚after‘. The newly designed ‚collection‘ of the street showed a much greater harmony between the individual buildings, without denying each building a sense of individuality. For the beginning architecture students at the end of their first semester this was a very rewarding exercise. Not only was it the first time they were tasked to observe a part of town in detail, but the power to make harmonious improvements to it. Instead of working with a fictitious project, where color would be an after-thought at the end of the design process, the whole project concentrated entirely on the theme of color where many lived and worked.

As a result of this exercise, we feel the students learned that a building - or a color - is never experienced isolated from its surroundings or its background. Furthermore, a limited set of colors can generate a wide range of visual variations through various combinations.

Identifying the overall palette of colors and materials of a street and the visual tectonics of individual buildings in a street or area is a valuable design tool in renovating old or designing new buildings.

A valued learning outcome in this exercise was the direct connection to the material of color. It meant much more than using readymade color swatches or simply selecting colors by clicks on the computer. Each swatch needed to be hand painted, cut, and glued - and the students had to learn about the process of mixing pigments to achieve the desired result. Color thus became more than just an aspect of decoration - it became a valued integral material.

## **ACKNOWLEDGEMENTS**

We would like to thank RAL Color International for their continuous support of TU Dresden's Color Intensive Course and for supplying our students and teachers with D2 Color cards for their analysis.

We are grateful for the TU Dresden in granting a Dresden Fellowship for six months to Prof. Kine Angelo from NTNU Trondheim. We thank the Haus der Farbe in Zürich for inspiring us to begin a color inventory for Dresden and finally Karin Fridell Anter, whose concept of nominal and perceived colors played a role in the students' color analysis.

# The use of colour in the urban landscape through regeneration projects of the degraded open spaces of the city.

Francesca Salvetti <sup>1\*</sup> and Michela Scaglione <sup>2</sup>

<sup>1</sup> Architecture and Design Department dAD - University of the Study of Genoa; francesca.salvetti@unige.it

<sup>2</sup> Architecture and Design Department dAD - University of the Study of Genoa; michela.scaglione@edu.unige.it

\* Corresponding author: francesca.salvetti@unige.it

## Abstract

The recovery of the open urban spaces of the city is an increasingly topical issue that requires new reflections on the methods of reuse also through colour.

In urban areas, the resulting spaces of the connecting infrastructures, such as bridges, viaducts, overpasses, are increasingly the object of recovery, thus offering the city new places with different functions and formal solutions: the use of colour characterizes these spaces, giving personality and recognizability within the city areas.

These spaces, which were not considered central elements characterizing the urban landscape, are included in the new designs as an integral part of the project, as places of use that characterize and identify the environment. New visions and designs aimed at overturning the nature of marginal and repulsive spaces in inclusive areas, aimed at socio-cultural regeneration.

This article aims to analyze in an analytical and systematic key, both the large redevelopment projects on an urban scale and the interventions, even temporary and spontaneous, self-produced, as cultural manifestations that stimulate people to regain possession of places without identity. Places of connection and passage, without a specific identity which, through recovery projects, acquire a new role within urban dynamics, creating spaces for revitalization with new functions that integrate into the context.

The methodology used for the analysis of the identified case studies will be by comparison between projects characterized by a constitutive and intentional process of regeneration of empty spaces: from urban muralism to street art, to the use of colour for the redevelopment not only of buildings but also of marginal spaces and urban environments.

Main themes identified for the cataloguing of projects aimed at the comparative survey:

- The design of urban spaces dedicated to the recovery of the waste areas of the infrastructures: colour in the project, colour in the drawing;
- Projects for bridges areas with outdoor spaces integrated into the context;
- Projects for the recovery of degraded areas carried out through the use of colour;
- Temporary, spontaneous self-produced projects.

This article aims to understand the role of colour in the regenerative processes of the city: from design to construction of the work.

**Keywords:** Recovery, Reuse, Colour, Urban spaces

## INTRODUCTION

If the growing city always needs new urban spaces, the reuse of abandoned or abandoned spaces is a central theme in the architectural debate: in particular, the attention paid to the recovery of spaces immediately around the large road and rail infrastructures has produced numerous interventions aimed at attributing new functions to places traditionally perceived as spaces of degradation and abandonment.

If in the popular tradition under the bridge lured dangerously and harassing mythological creatures such as the Trolls of the Nordic folk tradition in more recent times Anthony Kiedis voice of the Red Hot Chili Pepper sang in "Under the bridge" his loneliness and drug addiction in a touching metaphor

The use of colour in the urban landscape through regeneration projects of the degraded open spaces of the city "(Under the bridge downtown) I could not get enough (Under the bridge downtown) Forgot about my love (Under the bridge downtown) I gave my life away".

Common was the sense of suspicion that these structures in past eras aroused: there are numerous in Italy the bridges defined as "of the devil" to which people attributed magical powers simply ignoring the static abilities of the times.

With the advent of reinforced concrete, the great works have changed the scale relationship between man and infrastructure, placing it in front of its smallness if compared to the grandeur of the road structures: in a famous sequence of the film "Fantozzi" of 1975, the protagonist is the subject of a ruinous fall from a bus running on the Roman elevated road, in a rapid sequence of images the director quickly changes the relationship of perception from human to urban, opening the image more and more and thus tragically placing us in front of our real dimensions in the urban scale and metaphorically in life.

The hunger for spaces in the city has brought to attention the possibilities that these places can offer: if their characteristic of non-places has decreed their abandonment and improper use with often illegal activities, their total absence of a traditional-historical function or identity has attracted the attention of architects and artists who have understood their great potential in the field of experimentation and urban innovation.

### **URBAN LANDSCAPES AND COLOUR: CASE STUDIES**

Le Corbusier in his essay "Towards an architecture" speaks of the beauty of the engineering work as opposed to the architectural work, the magnificence of the simple form generated by the geometry contrasts with the degradation or abandonment of these places; some of the many projects that seek to make a change in these spaces to enhance the beauty of these structural forms can be summarized in some categories:

- The design of urban spaces dedicated to the recovery of the waste areas of the infrastructures: colour in the project, colour in the drawing;
- Projects for bridges areas with outdoor spaces integrated into the context;
- Projects for the recovery of degraded areas carried out through the use of colour;
- Temporary, spontaneous self-produced projects.



Figure 1: Qingdao design collage (China) The garden of the Artists of Ateliers Jean Nouvel; photorealistic simulation of the Project Il Parco del Polcevera e il Cerchio Rosso Genova (Italy) by Stefano Boeri Architetti 2019.



The use of colour in the urban landscape through regeneration projects of the degraded open spaces of the city

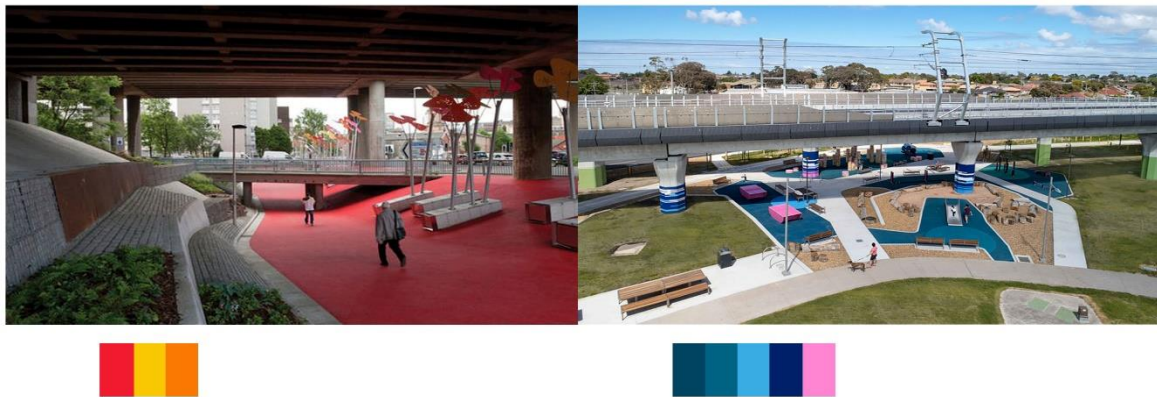

Figure 2: Project by 7N Architects + RankinFraser Landscape Architecture's Garscube Landscape for Glasgow's City Center 2010; Caulfield To Dandenong Level Crossing Removal, Melbourne (Australia) 2018 Project Aspect Studio.



Figure 3: Puente General Salvador, Santa Cruz de Tenerife (Spain) 2014; Av. Figueroa Alcorta, Buenos Aires (Argentina), 2011; recovery of railway spaces of the urban area of Cleveland (USA) 2016, MAUS Soho street art district of Malaga 2013.



Figure 4: Collective Basurama Autobarrios SanCristobal 2012 Madeira (Spain); concert an underpass of Ottawa's Queensway 2015

Colour is the element that characterizes the interventions mentioned above used as a tool capable of transforming the perception of space from a place of degradation or to a healthy environment.

The use of colour in the urban landscape through regeneration projects of the degraded open spaces of the city  
The choice of color ranges always focuses on bright saturated shades regardless of whether applied on vertical or horizontal surfaces, colours that recall the toys intended for children chosen precisely to evoke the benefits of safety and fun.

The success of these operations is also given by the reduced cost of these interventions: it is difficult, however, to think that a touch of colour, albeit artistic, can make a real change in the places, always necessary in our opinion to have this type of interventions to coordinated urban-architectural solutions that allow a real transformation of the spaces.

As in the case of the MAUS in Malaga(Spain)where a series of street art operations have been included in a complex redevelopment intervention through the incentive of openings of artists' shops and art galleries; the combined action of these interventions has triggered a virtuous process of redevelopment that has brought a significant improvement in the quality of life throughout the neighbourhood.

### **ART AND COLOUR FOR THE REGENERATION OF URBAN SPACE**

The themes on which we focus most are the rebirth of cities, in particular of common spaces through creative experiences even impromptu, to promote a positive and revitalizing social change.

Representation as a privileged methodology of drawing and the use of colour finds a privileged space in the new design proposals aimed at the recovery of these spaces.

The inseparable perception of places becomes a means of immediate communication. Colour is used in these projects as a glue as a system that visually connects areas, structures, through a compositional lightness. The function of colour as a sensory and perceptual indicator helps to distinguish objects to delineate urban spaces, providing indications for human behaviour and its orientation in space.

Its function is intimately linked to form and nature and its use in the specific artistic and architectural field has undergone considerable changes over time.

The analyzed projects underline how the colour and the interventions are not aimed only at the "cleaning" of the structures, but by a more complex study, which involves the communities and which are promoters of a new function and use of the spaces. Color, in its attractiveness, can turn an underutilized alley into a community space, as in Pacoima Beautiful's Project, in the Bradley Plaza Green Alley neighbourhood, in Los Angeles.<sup>1</sup> Even coloured micro-installations can become an example of reuse and revitalization of abandoned passage places, as in the case of small interventions implemented in the city of Wroclaw in Poland, an example of immediate simple planning, which "tries to solve problems rather than create monuments", citing the designers No Studio designer.<sup>2</sup> Mending urban parts for new functionality of spaces, as in the Phoenix Flowers project, Garscude Landscape Link,<sup>3</sup> in which the visionary ideas of the designers predicted how the redevelopment of an underdeveloped urban area, through colour and light, would reactivate a broken link with the community and positively conditioned the surrounding areas.

Among the first successful participatory urban regeneration interventions, not only from an architectural point of view but also artistic and social, is the Superkilen urban park (super wedge in Danish) located in Copenhagen in the semi-peripheral district of Norrebro. Created by the group of architects Big-Bjarke Ingels Group, Superflex artists and landscape designers Topotek 1, as a great

---

<sup>1</sup> Bradley Plaza Green Alley, ARUP, Los Angeles, California; 2020 <https://www.arup.com/projects/bradley-plaza-green-alley>

<sup>2</sup> Micro installations, No Studio, Wroclaw, Poland, 2016; <https://www.studio.no.pl>

<sup>3</sup> Phoenix Flowers Garscude Landascape Link, 7N Architects + Rankinfraser Landscape Architecture + Glasgow City Council Land Services, Glasgow, England, 2010; <https://www.7narchitects.com>

The use of colour in the urban landscape through regeneration projects of the degraded open spaces of the city precursor project of active public participation attentive in particular to the needs of the end-user, which has made possible dialogue and comparison with communities of different ethnicity, religion and culture.<sup>45</sup>

A contemporary approach to open space where different cultural influences and design intentions meet, from redevelopment to active sharing of renewal and social interaction.

Urban interventions, for the recovery and exploitation of those existing and unused spaces, according to the new vision of the future, provide sustainable solutions that are in harmony with the community and local identity realities. The approach was also used by the new edition of Manifesta (European Biennial of Art Contemporanea<sup>6</sup>. The interventions of participatory urban planning, explore how the city of Pristina can be transformed through creative experiences by the direct action of the citizens, for dialogue open to positive social change. Processes that have undergone an acceleration in recent years, in response to a health emergency that has led to the unlocking of unsustainable environments and situations. "Far from making cities obsolete, the Covid-19 pandemic has unlocked an increasingly large potential for rebirth, what economist Joseph Schumpeter has called creative *destruction* on an urban scale," said Carlo Ratti.<sup>7</sup> "The crisis has left governments with little choice but to take a frantic, trial and error approach. The extraordinary innovations that have emerged in the field of pedestrianization, public space, affordable housing and dynamic zoning, highlight the power of citizen feedback".

Experimental processes such as artistic creative design workshops drive new cultural institutionalism. The attempt at structural revision of the relationship between contemporary arts and territorial and community contexts, the systematic incorporation of the arts into educational contexts that promotes critical thinking and imagination, the democratization of the governance of cultural institutions themselves and the inclusion of artists in productive contexts ecosystems outside the art world.

## CONCLUSIONS

The research does not pursue the intent to create an exhaustive overview of this phenomenon, but to note how more and more architects, artists, administrations are re-evaluating these interventions and new methodologies are always being studied.

These spaces thus designed turn out to be facilitating spaces, using a definition of Winnicott, in the eyes of communities, are spaces that use colour as a catalyst element of an environment and social interactions. "By this expression, we mean an environment capable of facilitating the development of the individual following his multiple innate tendencies" (Winnicott 1986).

The types of intervention dealt with exploring temporary and non-temporary urban overwriting (Gaiani 2018), as an evolution of the concept of urban redevelopment, through an innovative approach with a strong expressiveness, included in a broader sense, in which the extremely dynamic

---

<sup>4</sup> Superkilen, BIG + Superflex + Topotek 1, Copenhagen, Denmark, 2012; <https://big.dk/#projects>

<sup>5</sup> Superkilen is a public space project built in Copenhagen divided into three main areas: The Red Square, The Black Market and The Green Park. While The Red Square represents modern urban life with a café, music and sports, The Black Market is a classic square with fountains and benches. The Green Park is a park for picnics, sports and walking the dog. The people living in the immediate vicinity of the park represent more than 50 different nationalities. Instead of using the city objects/furniture usually designated for parks and public spaces, people from the area were asked to nominate specific city objects such as benches, bins, trees, playgrounds, manhole covers and signage from other countries. These objects were chosen either from the country of the relevant inhabitant's national origin.

<sup>6</sup> Manifesta, The European Nomadic Biennial, originated in the early 90's in response to the political, economic and social changes following the end of the Cold War and the subsequent steps towards European integration. Since that time, Manifesta has developed into traveling platform focusing on the dialogue between art and society in Europe. <https://manifesta.org/>

<sup>7</sup> Carlo Ratti director of MIT Senseable City Lab of Boston and founder by Studio CRA – Carlo Ratti Associated with



The use of colour in the urban landscape through regeneration projects of the degraded open spaces of the city relationships of contemporary man are symbiotically linked to the frenetic transformation of urban spaces into new social realities.

These new spaces are sometimes created as meeting points in counterculture processes and generate ecosystems in which people connect, perform naturally by eliminating barriers.

Can these places be included in what Michel Foucault called heterotopias (Foucault 1994) for which their purpose as a real place corresponds to a realized utopia, places that are located outside of any place but perfectly localizable?

Although in the sharing of ideas expressed in this article, the paragraphs Art and colour for the regeneration of *urban space* and *Conclusions* are to be attributed to Francesca Salvetti, while *Introduction* and *Urban landscapes and colour: case studies* to Michela Scaglione.

## **REFERENCES**

- Boeri, C., D. Calabi, and M. Bisson. 2017. Il contributo del colore all'interno dei processi di rigenerazione urbana, in Bisson, M. (ed.), *Environmental Design: IInd International Conference on Environmental Design, Proceedings (reviewed papers) of the IInd International Conference on Environmental Design*, Mediterranean Design Association, 30-31 March 2017, Torino, Italy, De Lettera Publisher, Milano, 379–386.
- Foucault, M. 1994. *Heterotopia. Metropolitan places and non-places*. Edited by: Villani, T. In: Millepiani; Mimesis Editore.
- Gaiani, A., 2018. *Urban overwrites. Strategy and tools for the re-conditioning of cities*. Quodlibet study. City and landscape.
- Gasparini, K. 2016. *Colour and light: sustainability for urban regeneration*. Curated by Marchiafava V. In: *Color and Colorimetry. Multidisciplinary Contributions*. Gruppo del Colore – Associazione Italiana del Colore, Milan, 163-173
- Le Corbusier. 1973. *Towards an architecture*. Edited by Cerri, P. and Nicolini, P. Milano: Longanesi & C.
- Winnicott, D.W. (1986/1990). *From the place of origin*. Milan: Raffaello Cortina.

# The color in the street art of Gianluca Raro and Fabio Biodpi: Between social impact and urban periphery in Scampia

Margherita Cicala <sup>1,\*</sup> and Luciano Lauda <sup>1</sup>

<sup>1</sup> University of the Studies of Campania 'Luigi Vanvitelli'; margherita.cicala@unicampania.it;  
luciano.lauda@unicampania.it

\* Corresponding author: margherita.cicala@unicampania.it

## Abstract

The widespread phenomenon of contemporary urban art increasingly dominates the pre-existing architectural surfaces, delivering to the degraded peripheral areas a social value and recovery which is correlated with an activation of socio-economic dynamics. Within the broad considerations on street art, this essay analyses two specific aspects of this phenomenon: on the one hand the analysis of the color of the works of art produced as a determining factor for the visual perception and the emotional approach that the decorated space manages to offer; on the other hand the social factor that becomes paramount value for urban regeneration. Specifically, the two analyses of visual communication and social communication are developed around the two artists: Fabio Biodpi and Gianluca Raro.

**Keywords:** *street art, colour, visual communication, social factor, Scampia*

## INTRODUCTION

The perception of the chromatic image of a place significantly affects the mental construction of people who live in specific environments or who occasionally enjoy their sight. In this process of visual storage, the chromatic aspect assumes a superlative value that determines the reading of space and influences its rhythm. In addition, color specifies a different relationship between man and the environment built with different behavioral reactions: of rejection or acceptance of that space. Among the various widespread phenomena of staining on the surfaces of the built is significant the phenomenon of street art. The works of street art subvert the idea of simple action of representation on a wall surface where the wall does not become only a graphic support (Cirillo et al. 2020), rather an artistic intervention that assumes a value of social redemption of abandoned urban areas, enclosing within itself the dual message of visual communication able to convey emotions, from which derives a social communication of liberation of a state of places by an alleged harassment, which in turn leads to an economic promotion of degraded places (Zerlenga et al. 2018). Therefore, we highlight here how the diversified use of colors used by street artists G. Raro and F. Biodpi determine different feelings and emotional approaches and on the other hand the intrinsic social factor in the works.

## THE COLOUR SCHEMES OF THE WALL DRAWINGS BY GIANLUCA RARO AND FABIO BIODPI

Analyzing the definition of the word "color" the first meaning concerns the physiological sensation caused by lights of different qualities related to radiation of specific wavelengths. The subsequent designation of the term indicates the natural or artificial substance used by a subject to paint, that is, the chromatic pigment. The combination of the two explications allows to define the work of an artist, here in the specific of a street artist, in the complexity of his works: on the one hand the analysis of perception of colour that involves light, the eye-brain relationship, and the phenomena of absorption and reflection, and on the other hand the actual pigment used. Given this premise, the focus of the paper" studies are the drawings painted on the wall by the two artists F. Biodpi and G. Raro, street artists who have worked a lot in the Municipalities of Naples. The above choice is dictated by the different modes of use of colour that the two artistic personalities possess in the graphic-visual production of their works.

G. Raro is a street artist of Neapolitan origins very active in Scampia, his neighborhood of origin. Among his productions is significant, the work realized in association with *Poste Italiane* in Melito (NA) [Figure 1 a-b]. In it, as in other of his realizations, we can see the use of simple geometries that act as a plot of the representation, marked by the black color that acts as a contour of the same recalling those of the elementary figures traced in prehistory by man. At the same time, it can be seen how the colours used here are analogous or analogous extended, where on a background dominated by the cold shades of blue and green the warm colours of green, yellow and orange are combined. The combination of warm and cold colours on which the use of similar colours is inserted makes the representation harmonious and this is particularly expanded by the different shades of green used to campire the geometry of stylized leaves. This last characteristic is a distinctive sign of the artist who comes to life in many of his works, as in “Naturalevoluzione” [Figure 2a] or in the work in which he “gives life” to the fronts of an electric cabin abandoned in the heart of Scampia [Figure 2b]. Even in these representations the artist uses different shades of green as well as the repetition of the texture of olive three leaves. While he prefers the blue for the work “Fondali Marini” made for the shipyards of St. George, where the different percentages for the shade of blue and the tints in NCS with diversified gradations allows to create that movement that simulates the object of the representation that is the sea [Figure 2c].

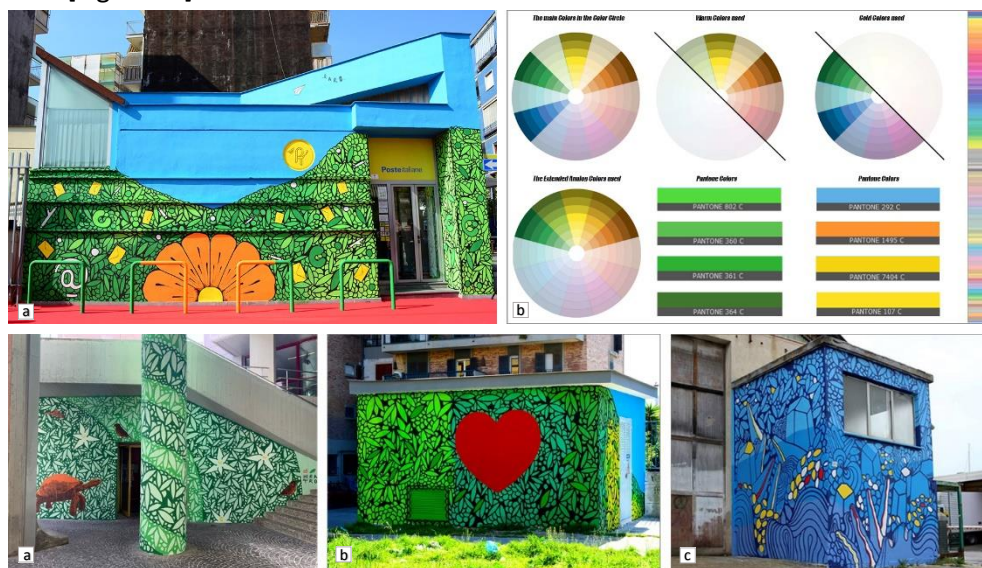

Figure 1 (a-b): G. Raro, work postal center in Melito (NA); color analysis (graphic processing by M. Cicala). Figure 2 (a-b-c): G. Raro, Naturaevoluzione, Monte S. Angelo (NA); work without title electric cockpit fronts, Scampia, (NA); Fondali Marini, Civitanova Marche, project “I see color” 2014.

In contrast, Fabio Biodpi, also a street artist of Neapolitan origin, in his works prefers a more figurative representation, characterized by sinuous and soft lines. With regard to the use of colors he prefers primary colors so as to make the representation more incisive or alternatively complementary colors, and there are combinations to two colors. As an example, in the work realized to the port of Civitavecchia [Figure 3 a-b] the representation is dominated by the primary colors: yellow, red and blue, therefore with a combination of two warm colors, where yellow dominates the background and on which the red and the blue are engraved, which, being the one warm and the other cold, balance the harmony of the tonal representation. Therefore, the contrast of pure colors is balanced by the temperature of colors, but identifying is the central representation of the work by the figurative character and gray color. In fact, if

on the one hand we find the primary colors that, for the theory of color are juxtaposed colors that give brightness and therefore complementary triadic equidistant between them in the chromatic circle (Itten 2010) when mixed they produce precisely the grey colour that identifies the central face of the representation. A second work that identifies the style of the artist is the stencil “Boom” dominated by the colors: black and magenta [Figure 4 a-b]. On the one hand, there is black, which is an achromatic colour, and without tonality that as we know is the foundation of visual perception; on the other, magenta, a subtractive primary colour, is a strong and decisive colour both visually and psychologically. The ratio of these two colors, on the one hand a “non-color” and on the other a “strong color” have the ability to generate a strong visual impact [Figure 4 a-b].

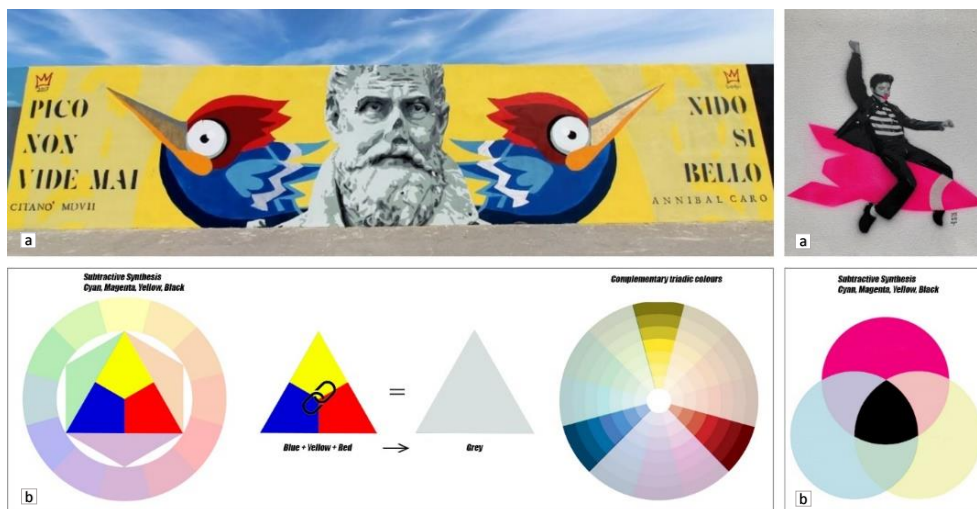

Figure 3 (a-b): F. Biodpi, Annibale Caro, the project “I see in color” 2017; analysis of the colors used. Figure 4 (a-b): F. Biodpi, stencil Boom; analysis of the work’s colours. (Graphic elaborations by M. Cicala).

From the above descriptions it is possible to deduce how stylistically the two artists turn out to be diametrically opposed, both for type of representation, both for modality of use of the color, the first with a more geometric and abstract style and dedicated to the use of harmonic colors with gradations and overlapping of analogous colors; the other with a more pictorial style defined by sinuous lines but with the use of strong colors and decided and complementary divergent between them.

### **VISUAL COMMUNICATION OF STREET ART. THE PANGEA PROJECT**

The *Pangea project* is a wide-ranging initiative developed in the territory of Scampia, north of Naples, as a path to non-violence that saw the collaboration of associations, schools, citizens, and artists, to eliminate discrimination and to redevelop the territory. Within this large project is the mural of considerable size: 130 meters approx. of extension and 3 meters approx. of height that extends along the wall of the stadium “A. Landieri”. The mural for *il Giardino dei cinque continenti e della non-violenza* consists of eleven scenes each depicting a well-known character symbol of non-violence [Figure 5]. The work was realized with the collaboration between the two street artists mentioned that have combined their stylistic differences in favour of the creation of a sensitive narrative on a “wall support”.

The graphic analysis of the mural shows that the drawing uses seven different main colors recalling those of the rainbow. The singular characteristic is that for each of the color used that distinguish each single painting, is matched in turn the use of different shades that recall the same color but obviously with different values of the same color and therefore dissimilar NCS. For example, in the tribute painting to Rigoberta Menchú the main color used is green but in detail you can see different colors and shades of the same pigment. In fact, from the analysis of the pantones it is deduced that the main ones used are: pantone 372 C, 368 C, 367 C of the green colour; to each pantone corresponds an NCS that allows to define for each the hue and therefore the percentages of black, color and white, and the rate of the two prevailing colors that determined the pigment. For example, to the pantone 372 C corresponds the NCS 0540 - G50Y that is: for the tint we have 5% of black, 40% of color and therefore 55% of white; for the tonality we would have that the prevailing color is green with 50% of yellow [Figure 5].



Figure 5: G. Raro, F. Biodpi, murale *Pangea*, Scampia. The faces of the non-violence characters; in the lower detail of the mural tribute to R. Menchú and analysis pantoni|NCS (graphic elaboration by M. Cicala).

By analyzing all the NCS of the greens used you can understand the differences of colours and shades of green visible in the work. This phenomenon is repeated in each painting for all the other six colors that characterize them. Another singular characteristic that derives from the use of different shades is the development of a geometric composition given by the breaks of the same shades of colour that define straight lines and curves dominating the paintings, peculiarities that reflects the style of Raro, but within this geometric background are inserted in the center of each picture portraits of the faces of the characters from the figurative style that instead recalls the qualities of Biodpi. At the same time, the modular repetition of the geometric design of the olive leaves, a symbol of peace, is introduced for each scene, which also identifies the graphic style of Raro. These geometries are emphasized not by the black outline, but by the color of each painting but with a stronger tone. From this analysis it is clear that from the combination of two different styles the artists were able to generate a work with strong contents through a graphic and tonal expression that highlights the strengths of the two personalities, connecting the communicative message to the geometric and artistic colours and textures, creating a graphic and visual continuum between the scenes representing a work of contemporary art.

### **EDUCATIONAL TRAINING AND SOCIAL COMMUNICATION OF THE PROJECT**

The attention paid by Michael de Certeau to places, such as the one reserved for the "minimal life" and social dynamics, enlightens us on the widespread phenomenon of contemporary urban art, increasingly recognized as a creative act able to activate significant processes of urban, social, and economic regeneration. This comment by the historian J. Revel is significant in this regard: «In the shapeless, messy space of the street, [de Certeau] sought, found the incessant invention of the social bond» (Giard et al. 1991). With de Certeau's reflections in *Invenzion du quotidien I* on cities or spaces,

we come across for the first time one of the most important notions of his anthropological studies: the distinction between strategies (of those in power) and tactics (popular). The attention to urban tactics by de Certeau is the praise to the resilience of the common man who implements them in everyday life and is therefore a political act, a reaction to power (Riggio 2016).

The tactics, as Lécrivain describes them, are none other than: «A thousand inventive practices that prove [...] that the crowd without quality [...] practices the waste in the use of imposed products, in a clandestine freedom in which each one aims to live the social order and the violence of things at its best». The urban place is then one of the most obvious cases of the possible subversion of an order that would want the common man in check. Certeau's reflections therefore present the ability of individual citizens to create their own space by appropriating places in a personal way.

In this sense, in recent years the work of street artists is assuming a social awareness linked to the spatial identity of architecture (Zerlenga et al. 2018), and is used as a tool for educational training, just as it happened in the district of Scampia with the *Pangea* Project. In fact, in Largo Battaglia, between the football fields of Arci Scampia and the football field named after A. Landieri (innocent victim of the camorra), where six flowerbeds poured in a state of neglect between the degradation of the entire area, with the *Pangea* Project was born a “new” place known today as “the garden of five continents and nonviolence”. *Pangea* is the supercontinent of two hundred millions of years ago, before the lands were divided, and the network of associations and schools involved manifest this “unified spirit”, as we read from the murales “PANGEA-SIMME TUTT'UNO” and the colorful logo of the project. Since there are five continents (and six flowerbeds), the central flowerbed is the Mediterranean, once a crossroads of civilizations, today the cemetery of those who died drowned in the attempt to emigrate, both because they want to recover its unitary function, both because the project was born from a reflection within the event Mediterranean Antiracist 2016, after it was planted in February a first symbolic plant during the *Carnival Gridas* dedicated to *Pangea*. Each flowerbed taken up for adoption by an association in combination with a higher institution of Scampia, is combined with a continent and dedicated to characters witnesses of nonviolence. Thus, this path of formation to nonviolence was born with the aim of creating the garden of “the five continents and nonviolence” in the six flowerbeds, curing the green and enriching it with colors, those of the arboreal essences of every continent and with the insertion of objects. An example of this is the yellow of *Gazania*, which is a South African plant, with which the symbol of non-violence was created in the flowerbed of Africa; the Neapolitan yellow of the tuff stones with which the inscription was made “The PEACE” in the Mediterranean flowerbed; a magenta chair dedicated to women victims of violence in Aiuola Asia has been added; etc. In the second year the project extended to elementary and middle schools that created a flowerbed of the five continents at their own school complex. Then some characters witnesses of nonviolence, following training workshops organized to create an exchange of skills between artists and young volunteers interested in creating the murals, were designed and colored on the perimeter wall of the football field A. Landieri. The murals are made by the artists G. Raro and Fabio B. with the contribution of a group of Gambiani (*Gambian Crew*) and the shapes, colors and faces are inspired, returning to the theme of the continents, the *Charter of Arno Peters*, which maintains the actual proportion between the areas of the continents represented [Figure 5]. So, *Pangea* is an educational training project, on which F. Valletti relies in his writings (Valletti 2017); *Pangea* is a work of art that makes citizens fond of the place where they live, as W. Bottaccio wanted, denouncing the choice to create a rationalist neighbourhood without a work of art (Bottaccio 2016); *Pangea* recalls the image of the “horizontal cathedral” associated with the entire Municipality VIII of Naples (Cirillo et al. 2020).



## CONCLUSION

The street art projects analyzed here highlight the artistic action of the two street artists through the analysis of the colors, shades and shades used, as a function of the revitalization of those “dark corners” of the city. They show how this ever-evolving form of art is closely related to the visual and economic-social action of deprived places where the relationship between the surface of the walls and the artistic representation assumes full identity in urban contexts, confirming the same places and establishing a new geometric and figurative relationship between the existing building.

## REFERENCES

- Bottaccio, W. 2016. *Giubileo delle periferie. Partendo da Scampia*, Napoli: Marotta & Cafiero.
- Cicala, M. 2020. *Street art as a flower in the cement for urban regeneration. Interview with the street artist Bifido*. In: A. di Luggo, O. Zerlenga (a cura di). *Street Art. Drawing on the Walls. Points of view, languages and techniques*. DISEGNARECON, vol.13, n. 24.
- Cirafici, A., and O. Zerlenga. 2011. *Representing the “places of transit”. Expressive potentials of the design in Contemporary project of railway stations*, in *Il Disegno delle Trasformazioni*, Napoli: Clean.
- Cirillo, V., and M. Cicala. 2020. *Valorizzare l'architettura religiosa attraverso l'arte di strada. Il campanile della chiesa di Maria Santissima del Carmine alle Fontanelle nel progetto PREVENT*. In: A. di Luggo, O. Zerlenga (a cura di). *Street Art. Drawing On The Walls. Points Of View, Languages And Techniques*. DISEGNARECON. Napoli: La scuola di Pitagora, n. 13, pp. 95- 121.
- Cirillo, V., L. Lauda, and I. Todisco. 2020. *Drawing on the walls of the Naples'. Social stories and technological portals*. In: A. di Luggo, O. Zerlenga (a cura di). *Street Art. Drawing on the Walls. Points of view, languages and techniques*. DISEGNARECON, vol. 13, n. 24.
- De Certeau, M. 2012. *L'invenzione del quotidiano*, Roma: Edizioni Lavoro, pp. 143-167.
- Forte, F., L. Lauda, O. Zerlenga. 2018. *Street Art in Naples in the territory of the 8th Municipality*, in *EGA XVII INTERNATIONAL CONFERENCE*, C. L. Marcos editor, Switzerland, Springer, pp. 1433-1448.
- Giard, L., H. Martin, and J. Revel. 1991. *Histoire, mystique et politique*, Grenoble, Jérôme Million, p.120.
- Riggio, G. 2016. *Michel de Certeau*, Brescia: Morcelliana, pp. 27-34.
- Itten, J. 2010. *Arte del colore*. Il Saggiatore Editore.
- Valletti, F. 2017. *Un gesuita a Scampia. Come può rinascere una periferia degradata*, Bologna: EDB.
- Yu, B. and S. Bel. 2020. *Colori emergenti: nuove tendenze, esigenze e sfide negli ambienti urbani contemporanei*, in *Colour Culture and Science*, 12 (01), pp. 32- 39.
- Zerlenga, O. 2018. *Social & cultural sustainability: street art in Naples*, in *BEYOND ALL LIMITS*, Ankara, Çankaya. University Press, pp. 785-790.
- Zerlenga, O., L. Lauda. 2018. *La Città Altra nel disegno delle e sulle Vele di Scampia*, in *La Città Altra. Storia e immagine della diversità urbana: luoghi e paesaggi dei privilegi e del benessere, dell'isolamento, del disagio, della multiculturalità*, a cura di F. Capano, M. I. Pascariello, M. Visone, Napoli, Federico II University Press, fedOA Press, pp. 1-10.
- <http://www.art-vibes.com/street-art/scampia-progetto-pangea-murale-giardino-cinque-continenti/>  
[https://www.icpertiniguanelia.edu.it/pdg/wp-content/uploads/progetto\\_pangea\\_2016-2017.pdf](https://www.icpertiniguanelia.edu.it/pdg/wp-content/uploads/progetto_pangea_2016-2017.pdf)  
<http://paint.posteitaliane.it/>; <http://www.streetness.it/speaker/gianluca-raro/>  
<https://www.produzionidalbasso.com/project/progetto-pangea-scampia/>

The author Margherita Cicala took care of the chapters: Introduction; The colour schemes of the wall drawings by Gianluca Raro and Fabio Biodpi; Visual Communication of Street Art. The Pangea Project. The author Luciano Lauda took care of chapters: Educational training and social communication of the project; Conclusion.

1 COLOR AND MEASUREMENT INSTRUMENTATION	2 COLOR AND DIGITAL	3 COLOR AND LIGHTING	4 COLOR AND PHYSIOLOGY
5 COLOR AND PSYCHOLOGY	6 COLOR AND PRODUCTION	7 COLOR AND RESTORATION	8 COLOR AND BUILT ENVIRONMENT
<b>9 COLOR AND DESIGN</b>	10 COLOR AND CULTURE	11 COLOR AND EDUCATION	12 COLOR AND COMMUNICATION MARKETING

## 9 COLOR AND DESIGN

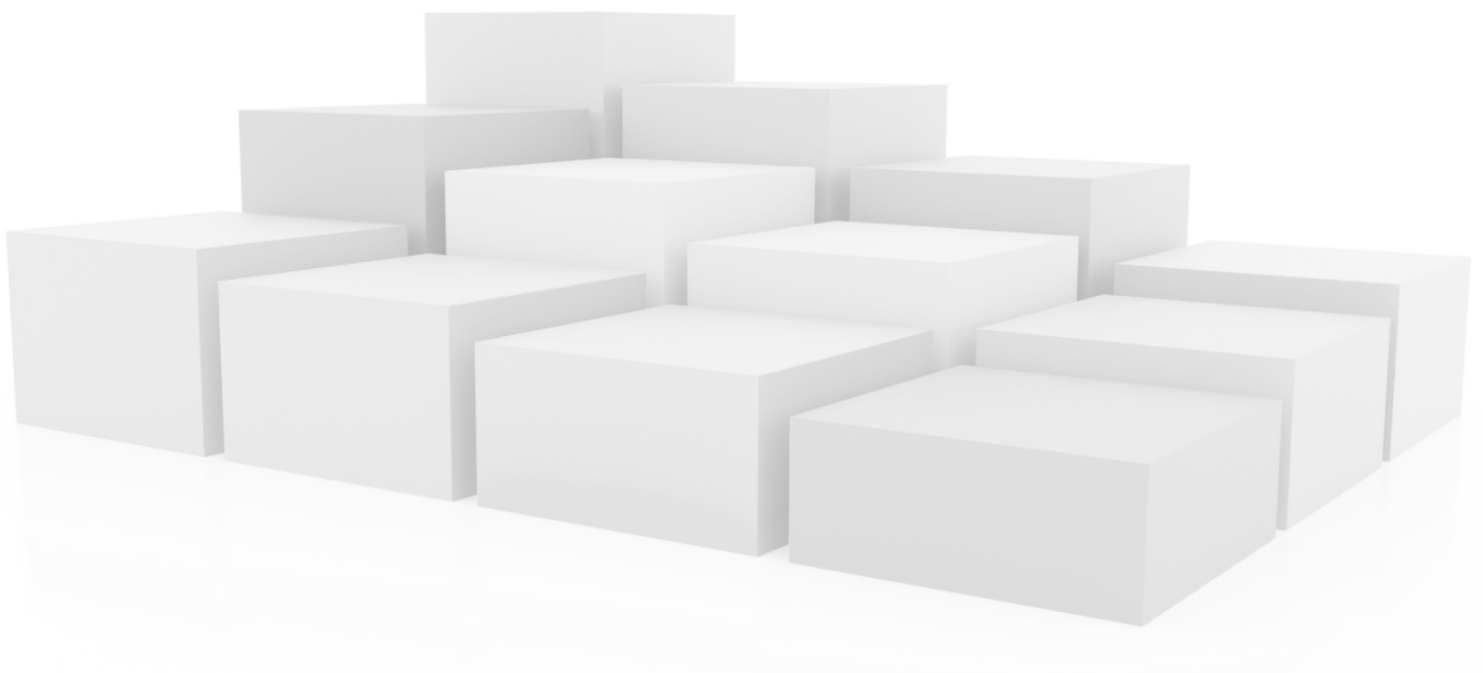





# Style Assessment of Home Appliances in Various Interiors Using Virtual Reality

Aigerim Shunayeva<sup>1</sup>, Taesu Kim<sup>2</sup>, Boykung Lee<sup>3</sup> and Hyeon-Jeong Suk\*

<sup>1</sup> Color Lab., Department of Industrial Design, KAIST, Republic of Korea; aigerash@kaist.ac.kr

<sup>2</sup> Color Lab., Department of Industrial Design, KAIST, Republic of Korea; tskind77@kaist.ac.kr

<sup>3</sup> Autodesk; bokyung.lee@autodesk.com

\* Corresponding author: color@kaist.ac.kr

## Abstract

The style assessment is critical in the product design process. We utilized virtual reality (VR) to create an immersive experience for designers to assess product style on a one-to-one scale. To investigate the values of virtual reality to assess product style, we employed four different interior styles and lighting conditions with regard to an air purifier product. We tried to observe how environmental changes affected designers' judgments. We conducted a user study with 18 designers and summarized the findings in five aspects: first, immersive design experience; second, designer's sensitivity to changes; third, changing product's properties inspired by the interior; fourth, the most frequently changed product property; and lastly, designers' thoughts while being in a virtual environment.

**Keywords:** *virtual reality, product design, style assessment, product color.*

## INTRODUCTION

The wide variety of materials and colors let designers express their ideas and bring a new look into traditional products. In that demand, product visualization medium plays an important role, allowing designers to clarify expectations about the future product prior to manufacturing. Recently AR/VR technologies have been actively adopted by global companies to envision the product aesthetics on a one-to-one scale. One of the remarkable benefits of VR in the process of product design is its flexibility to create and manipulate not only the product itself but also the product surroundings. This study intends to understand the potentials of using VR for product design assessment focusing on home appliances in various types of interiors.

## PRODUCT STYLE ASSESSMENT IN RELATION TO THE INTERIOR DESIGN

A set of product's visual characteristics that is perceived through reflection on similarity and difference with other objects could be specified as a product's style. By defining an object's style, we could specify its relation to time segment, geographical location, property, or brand (Ackerman 1962; Chan 2015). It was found that products' style was ranked as the top four aspects after comfort, price and construction quality during the furniture selection procedure (Yoon et al. 2010). The importance of the style could be explained by the desire of consumers to buy furniture that will look good with their interiors. This is also true for the home appliances that are selected to be matching with other objects in the interior.

There are cases when designers consider the environment during the design process (Lee et al. 2018). However, not many studies consider the environment as stimuli that affect product perception. Recent work found that the environment has an effect on product value perception. For example, the values of wine and milk were evaluated higher in a matching, and lower in non-matching environments (Wolfel and Reinhardt 2019). This trend might be the same for the furniture and home appliances that are perceived as a part of interior.

## VR EXPERIMENT

### Set up for the virtual interiors

Before the main experiment, we conducted a workshop with five graduate students majoring in Industrial Design in order to identify the types of interiors that would be used as stimuli in the user study. The average age of the participants was 28.80 (SD = 3.86). Participants had to sort sixty interior image cards according to the interior styles and their features. Based on the interview results we selected four interior types, and defined names based on the participants' replies: "Young Modern", "Airbnb Style", "Traditional Europe", "Industrial Loft". Regarding each interior type, we bought the interior model from Unity Asset Store shown in the figure 1, and prepared the day and the night scenes for each type using Unity.

In the main experiment, each participant was exposed to up to 8 interior conditions, consisting of 4 interiors with alternative 2 lighting conditions. We used air purifier product models to be tested in various interiors. Two kinds of air-purifiers were used: "Airmega" from Coway (South Korean company) and "Rain" from Balmuda (Japanese company). The air-purifiers were eligible for the adjustments in terms of size, form, and placement. Each participant was assigned to one of two products.



Figure 1: Interior models used for the experiment

### Setup for VR experiment

We facilitated the HTC Vive VR set that consisted of two sensors located in the opposite corners of the room. A head-mounted display connected to the computer (AMD Ryzen 5 2600 six-core processor with 16GB of RAM memory, NVIDIA GeForce GTX 1070 video card, and installed Windows 10 Pro). The session lasted for an hour and was fully recorded.

### Procedure

In the main experiment, we recruited 18 design majoring students made up of 10 males and 8 females. Their average age was 23.94 (SD = 2.86), and some of them had design experience in the industry. The experiment lasted for 1 hour per participant and consisted of the three stages. First stage consisted of introduction and signing a consent form. Stage two consisted of two VR sessions, where participants were exposed to air purifiers in various interiors and lighting conditions. The task was to take a promotional photo of the product that should highlight the aesthetics of the product at current interior. Moreover, we adopted a Wizard of Oz method, and thus participants were allowed to request for any modifications related to air-purifiers as well as the interior elements. By doing so, the participants were able to explore new circumstances differently from the initial conditions. In parallel they were asked to explain their decisions while doing a task. Lastly, we conducted a post-interview session to discuss the VR experience, and compare it with their previous experience in product assessment procedure using other methods and media.

## **RESULTS AND ANALYSIS**

Based on our observation and participants' verbal feedback, we performed a thematic coding (Braun and Clarke 2006). We derived a total of five findings, and structured it in a three-level framework.

### **Finding 1. Space for engaging work**

We noticed that designers easily concentrate on the task when they are in VR. Based on the participants answers, reasons for that are immersive nature of HMD that let participants to feel presence in the interior, and to experience the product in one-to-one scale which naturally invites him/her into the product assessment process; the opportunity to try various design options in real time, which is engaging and fun experience; and lastly no visual distractors from real world like mess on the working space, desire to check social media, and constantly changing sun position that might affect on product perception.

### **Finding 2. Highly sensitive to changes**

Participants were exposed to the same interior twice over the experiment: once in a daylight setting, and once at night setting. When participants viewed the interior for the second time in a different setting, they felt differently. We found two main reasons for that. The first reason was the change of lighting that affected the perception of visual characteristics. For example, one of the interiors looked like an office environment in day condition, while appearing as a cozy family evening at night lighting setting. The other reason is a change of focus area depending on the time. In the daytime setting, participants were looking towards the window area, because they were attracted by the window view. However, in night conditions with closed windows and curtains, participants were less dominated by the window. Thus, the time configuration seemed to be critical in the VR environment, as it directly influenced participants viewing perspectives. Furthermore, participants' responses varied much depending on their viewing perspectives.

### **Finding 3. Modification of product attributes inspired by interiors**

During the VR session, participants addressed changes of the product attributes including color, material, shape, or size. The changes were primarily guided by the common design principles like similarity, principles, and contrast with other objects in the interior to reach harmonious composition. Since participants' design decisions were affected by the interior design, at first designers thought that this approach would not work for designers. However, after having experienced the product under various interiors, the majority agreed at the effect of surrounding interior on designers' subjective judgment of product style. As a result, participants volunteered for style modifications to improve the style harmony between the air-purifiers and interior styles.

### **Finding 4. The main consideration: Color attribute**

We counted the number of changes offered by participants, and found out that participants offered color changes the most. 15 out of 18 participants offered color change at least once over the whole VR session, while material and size changes were offered only by six participants, and shape changes only two. We defined two reasons of color interest among our participants:

- Participants said that home-appliances should be blended in the environment. Color seemed to be the easiest way to ‘hide’ the product in the environment. It reminds of the chameleon that changes its colors to be seamless in the environment.
- Participants were explaining the color by defining similar objects in the room: “something dark brown like the speaker on the right”. When participants wanted new color that did not existed in the room, the color selection procedure took more time that was not convenient to the participants.

**Finding 5. The VR environment assists compassion towards the user**

Participants naturally described their impression about the interior and the air-purifier by imagining who might be living in that apartment. One of the interiors from our experiment was described in the following way: “it reminds me of people is like some ... they have creative job, and their job is related to the art, or design” (participant 13), “when I see whole interior of this room I think the user of this room will be person who have unique personality who loves to show off his identity to other people” (participant 16), “I think this is a loft apartment of some lonely person. Financier or programmer. I think he is young. He is not cares about his health much” (participant 5). Participants were telling stories of how an air-purifier appeared in this room, who bought it, and how they use it.

**DISCUSSION**

The five findings presented in the current work were summarized into the framework presented in the Figure 2. The framework describes the values of VR that were derived during the experiment when the participants assessed product’s style using head-mounted display. The structure of the framework was inspired from Don Norman’s processing levels: visceral, behavioral, and reflective (Norman 2013). Proposed framework consists of three layers, namely perception, participation, and imagination; located in the axis from basic sensorial level to higher level which is reflective thinking. Each level describes the VR experience of the designer: his perceptions and actions in the Virtual Environment.

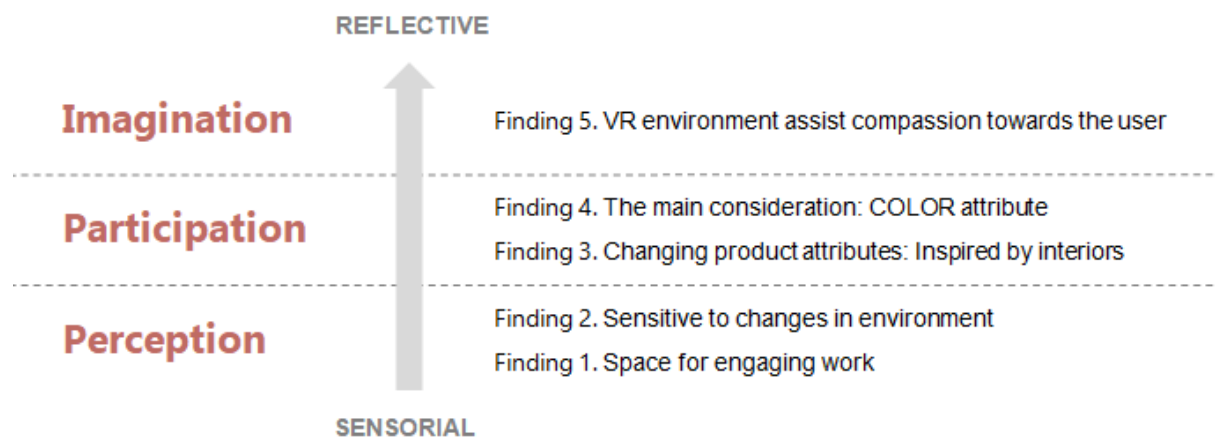

Figure 2: Framework summarizing the designer’s experience in VR during product style assessment.

Perception is the lowest level of a designer's activity in VR when she/he perceives the information through five senses with no action in response. Participation level is defined by the active action of the designer when his/her actions change the properties of the objects in the Virtual Environment. Imagination level is defined by the designer’s cognitive response to the perceived reality by thinking

beyond the visible reality. By reflective thinking, designers come up with a story about the place, objects or events inspired by the virtual environment, thus bringing new values to the virtual world.

The critical limitation of the current work is the fact that participants did not design the product on their own, instead they were offered the existing products. In addition, the task of taking a promotion photo of the product might be confusing, but it was selected to make participants naturally think about the product's aesthetics, and assess its design without feeling judged for their design decisions. Results showed that we reached this goal. However, still results are not describing the real situation when a designer makes the product, and have many design considerations throughout the design process. For the further step, we can see whether the real design process would be matching with our results. One more limitation of the current study is language barrier. Experiment was conducted in English, while the moderator and participants were from different countries including South Korea, Kazakhstan, China, etc. The diverse contingent of the participants might lead to some misunderstanding during the experiment that might influence the study results.

## **CONCLUSION**

In the current research work, we explored the opportunities that designers could get from using VR during the product style assessment. We tried to build a holistic understanding of processes happening in VR during the product assessment procedure. We identified five aspects of VR that makes it a valuable tool for designers, and presented them in a form of the framework.

VR is not only a visualization tool, it also actively involves the user into the process through immersive experience. VR could bring new experience to the designers and enrich the design process.

## **ACKNOWLEDGEMENTS**

1) The National Research Foundation of Korea(NRF) grant funded by the Korea government(MSIP) (No. 2018R1A1A3A04078934); 2) the BK21 PLUS through the National Research Foundation of Korea(NRF) funded by the Ministry of Education(MOE) (NO:21B20130011097).

## **REFERENCES**

- Ackerman, J. S. 1962. A theory of style. *The Journal of Aesthetics and Art Criticism*, 20(3):227–237.
- Braun, V. and V. Clarke. 2006. Using thematic analysis in psychology. *Qualitative Research in Psychology* 3(2): 77-101.
- Chan, C.-S. 2015. *Style and creativity in design*. Springer.
- Lee, B., J. Shin, H. Bae, and D. Saakes. 2018.. Interactive and Situated Guidelines to Help Users Design a Personal Desk That Fits Their Bodies. In: *Proceedings of the 2018 Designing Interactive Systems Conference*, 637-650.
- Norman, D. 2013. *The design of everyday things: Revised and expanded edition*. Basic books.
- Wolfel, M. and A. Reinhardt. 2019. *Immersive shopping presentation of goods in virtual reality*, 119–130.
- Yoon, S.-Y., H. Oh, and J. Y. Cho. 2010. Understanding furniture design choices using a 3d virtual showroom. *Journal of Interior Design*, 35(3):33–50.



# Is Blue still a Representative for Future Vehicles?

Gyunpyo Lee <sup>1</sup>, Taesu Kim <sup>1</sup> and Hyeon-Jeong Suk <sup>1, \*</sup>

<sup>1</sup> Color Lab, Department of Industrial Design, KAIST, Republic of Korea; gyunpyolee@kaist.ac.kr

<sup>1</sup> Color Lab, Department of Industrial Design, KAIST, Republic of Korea; tskind77@kaist.ac.kr

\* Corresponding author: color@kaist.ac.kr

## Abstract

Studies in alternative fuel vehicles identified blue as a representational color even though it is used scarcely in vehicle design. They also identified that blue usage in the vehicle's interior is minimal compared with the exterior. The study analyzes the press-released car interior photos of electric vehicles (EV) and internal combustion engine (ICE) vehicles of global automakers in identifying blue dominance by incorporating a k-means clustering algorithm with weighted color filters. The analysis resulted that blue and green are used more in EVs to represent eco-friendliness and electrification. Ford, Kia, and Mercedes Benz have statistically significant evidence with 99.5% confidence in the independent t-test for blue. Audi and Nissan have significant evidence with 99.5% confidence in green. Consequently, the study confirms that blue is the representational color for three prominent global OEMs.

**Keywords:** Color Design, Product Semantics, Future Vehicle, Interior Design

## INTRODUCTION

In recent decades with raised awareness of global warming and environmental issues caused by manufactured products, environmental issues have emerged into many corporate marketing and business strategies of going eco-conscious. Many companies accepted green as a representative color in their slogan, products, and public relations materials in response to eco-consciousness and sustainability since the boom of environmental responsibility. Studies in business and marketing have proved the green association with brand equity, brand image, and trust gained with color association presented in their products and services (Sundar and Kellaris 2017), and how color influences customers on brand image, company reputation, and moral response to such influence created upon color association (Lim et al. 2020). In line with such color connection with eco-consciousness, blue also carries a similar impression and emotional feedback toward general customers that do ethical ratings of both brands and products. Sundar and Kellaris found that although the word green appears to influence moral ratings of retail practices more than blue, visual exposure to either color evokes similar perceptions of eco-friendliness and influences toward customers (2017). They also found that blue is greener than green in conveying an impression of eco-friendliness, neglecting the fact that the frequently used word is green for most people (2016).

The automotive industry employed a similar color connection in their vehicles. Since the birth of the Toyota Prius in 1997 and the rise of hybrid line-ups, global OEMs, and new frontiers like Tesla, Rivian, and other alternative brands infused blue as design cues in both exterior and interior of alternative fuel vehicles. New technologies and innovations such as autonomous driving and electrification intensified companies to satisfy customer needs in response to global warming and governmental movements toward zero-emission. Accordingly, the previous notion of indicating alternative fuel vehicles shifted to future vehicles in brand strategy. The current trend in the industry made blue a primary color of representation in advocating the eco-conscious image and electrification. The brands will continue to create a color association with its future vehicles' public relations images to convey the brand image and message toward a greener future to their prospective customers. From the study, we identify and investigate whether blue is a representative color for alternative fuel



vehicles through image analysis by comparing images side by side with internal combustion engine (ICE) vehicle interiors. The contribution lies in providing alternative methods in determining the representative color of the future vehicle interior design and providing insights and inferential intuition behind the color association presented by the automotive companies.

### ***GREEN DESIGN CUES ON ALTERNATIVE VEHICLE DESIGN***

Until the public attention on the alternative fuel vehicles, or electric vehicles (EV), most of the studies on color association with vehicle design focus on understanding customer preferences and personalities showing through the color of both inside and outside. Whether it is green or blue, most automotive brands use it to make the statement of going ecological future in their brand image. Lee et al. (2015) have identified design elements and design characteristics that provide consumers the environmentally friendly images of the product. The study focused on identifying and investigating the design elements of the hybrid vehicles: emblem, shape, color, and finish. Even though the study mainly focuses on the exterior of the hybrid vehicle, the study reports how a color association with the design cues expresses the eco-conscious images of the brand. The color embodies the product characteristics in our associative memory by connecting the underlying values and symbols carried by the color. The color associated with the characteristics and psychological symbolism further extend to understanding the product personality as the product consumer purchases carry the same statement implied by its brand.

Govers (2004) explained that product personality is the ensemble of product aesthetics, product-driven associations, and consumer perceptions. Frank and Martin (2019), in their study on the development of green product personality for in-car user interfaces, stated that the defined aesthetics that the product reminds of in association with product personality. Furthermore, to facilitate the user with the trigger the desired associations and perceptions, design cues are often used in describing a specific aesthetic language to its users (Frank and Martin 2019). The study analyzed specific design cues implemented by German carmakers by identifying representations of alternative fuel vehicles, including hybrids and battery electric cars. It resulted that the design cues appear to be more prominent in the exterior than in the interior and the analysis of alternative fuel vehicles of German carmakers highlighted commonly shared design cues, in particular, with blue sharp-edged shapes and glowing elements that play an essential role in the visual representation of both exterior and interior of the vehicle design. Such design cues associated with the current shift in the industry focus more on user interfaces provided in the vehicle infotainment system and lighting components for creating an atmosphere.

As the main focus of these studies was to analyze design cues and examine them by each design component, they did not explain how color connection appears in the overall atmosphere of the vehicle. Also, they did not cover much on the interior design of EVs in their study. For this reason, our study takes an alternative approach to analyze the holistic interior design from the photos in identifying design cues of the EVs and understanding the design cues used.

### ***METHOD OF THE EMPIRICAL STUDY***

#### **Image collection**

To identify design cues of the representative color of the EVs, we have collected 325 car interior photos of major OEMs that produce both internal combustion engine vehicles (ICE) and electric vehicles (EV). We used press-released photos as our primary data as it contains the core concept and message of the

automaker who publishes. Furthermore, we chose to use the front row of the main cabin from the photos as it is the most prominent area of the car interior design where the driver and the first passenger interact. In addition, we collected vehicles released in the past five years and upcoming cars with the entire interior photos released for the public. Interestingly, interior photos of some OEMs were difficult as most OEMs aim to go full electrification by 2025. Therefore, we assume that these interior photos will use more range of the blue-ness in the images to give the message of electrification and the eco-consciousness image of the brand. Consequently, it is not easy to point out the blue-ness of the interior design and atmosphere presented in the photo as a whole, as found in the previous studies related to alternative fuel vehicles. Therefore, we implemented k-means clustering to understand better the usage of blue in the interior design as a representative color from the pixel level and intent to understand how color is presented in future vehicles accordingly.

### K-means clustering with weighted color selection

K-means clustering algorithm is one of the frequently used methods for extracting representative color palettes. However, since the color segmentation using the K-means algorithm employed by Weeks and Hague in 1997, many researchers have implemented the algorithm with different adaptations to improve. For example, the K-means clustering algorithm uses the requested k number of colors as a centroid for clustering and minimizes the error in finding (Lin and Hanrahan 2013). However, commonly used k-means clustering extracts and indicates colors found around the centroids dominant in its pixel level. Therefore, it is challenging to identify color palettes best represent the original image from the viewer's perspective. As shown in Figure 1, every pixel of the original image is determined in RGB spectrum and transferred into CIE Lab color space to accurately cluster them in centroids.

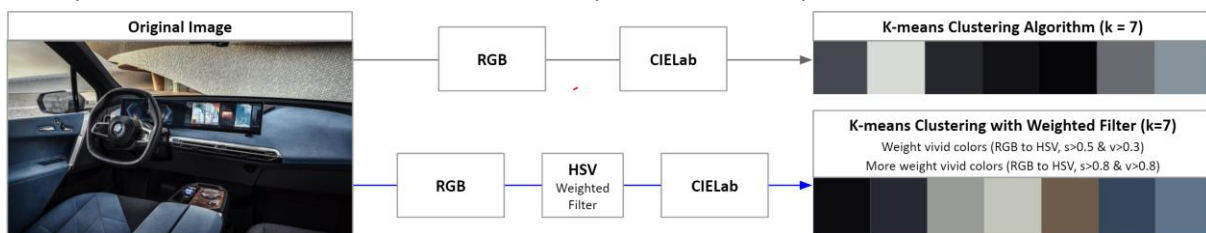

Figure 1: K-means clustering algorithm and weighted filter explanation.

For this study, we set 7 as "k", as it allows us to find enough color information from the image without being overly weighed toward on darker dominant colors found in the raw pixels of the car interior images as there are many shady areas located in the image where the leg rooms are. Therefore, we applied a k-means clustering algorithm with color weighted in terms of saturation and values. We used two filters of weighted saturations and values from the HSV color system: one is with saturation greater than 0.5 and values greater than 0.5, second is with saturation greater than 0.8 and values greater than 0.8. These filters allow us to find vivid colors found in the original image with ease. Using the modified k-means algorithm, we classified seven dominant color palettes of the interior photos of the global OEMs' ICE vehicles and EVs. We utilized this dataset for understanding whether blue is the dominant driver of the electric vehicle interiors by utilizing the statistical approach with the data.

## RESULTS OF THE EMPIRICAL STUDY

From the 325 interior photos of both ICE and EV, we have extracted seven dominant color palettes using k-means clustering with a weighted color selection filter. Then, as explained above, we applied the filter from the HSV color system into the CIE Lab color space. Next, we examined the color palettes

of 21 global automakers. However, not all automakers either produce EV and ICE cars or produce EVs in recent years. Therefore, we narrowed it down to 11 automakers to compare both "a" and "b" of CIE Lab color space observed in color palettes of two different engine types for statistical analysis. The results of the statistical analysis are as follows.

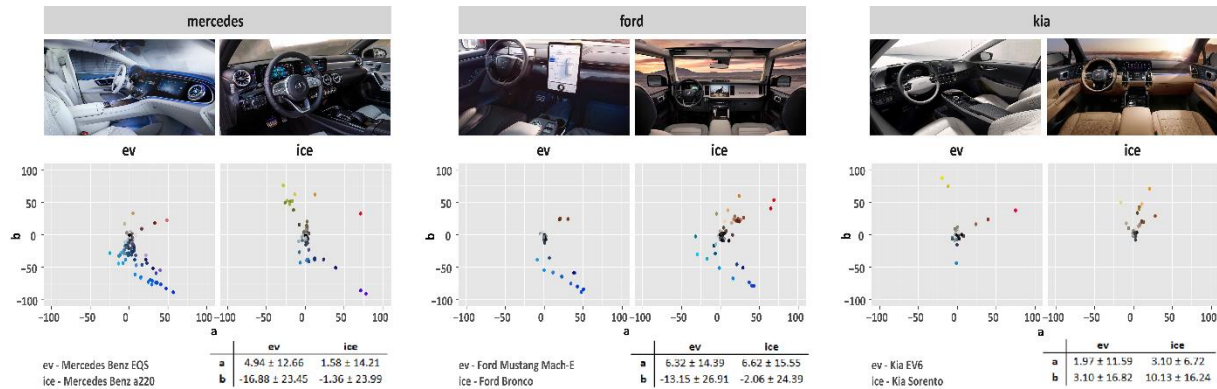

Figure 2: Example of original photo used for k-means clustering and results of color palettes from k-means clustering on both EV and ICE interior images of Mercedes Benz, Ford, Kia.

Three automakers have resulted significantly in "b": Ford, Kia, and Mercedes Benz (Figure 2). The average "b" of 56 Ford EV color palettes is -13.15, with a standard deviation of 26.91. Compared with the average "b" of 84 Ford ICE color palettes, -2.06, with a standard deviation of 24.39. The independent t-test yielded statistical evidence with 99.5% confidence [t(138) = 2.527, p < 0.05, two-tailed]. The average "b" of 63 Kia EV color palettes is 3.10, with a standard deviation of 16.82. Compared with the average "b" of 49 Kia ICE color palettes, 10.13, with a standard deviation of 16.24. The independent t-test yielded statistical evidence with 99.5% confidence [t(110) = 2.229, p < 0.05, two-tailed]. Lastly, the average "b" of 133 Mercedes Benz EV color palettes is -16.88, with a standard deviation of 23.45. Compared with the average "b" of 112 Mercedes Benz ICE color palettes, -1.36, with a standard deviation of 23.99. The independent t-test yielded statistical evidence with 99.5% confidence [t(243) = 5.104, p < 0.05, two-tailed]. The statistical results show that the EV interior design of Ford, Kia, Mercedes Benz use more blue-ness in its appearance. Among the three brands, Mercedes Benz applied a strong shift toward blue in their EV interior photos and showed significant evidence of blue nuance in their EV cars.

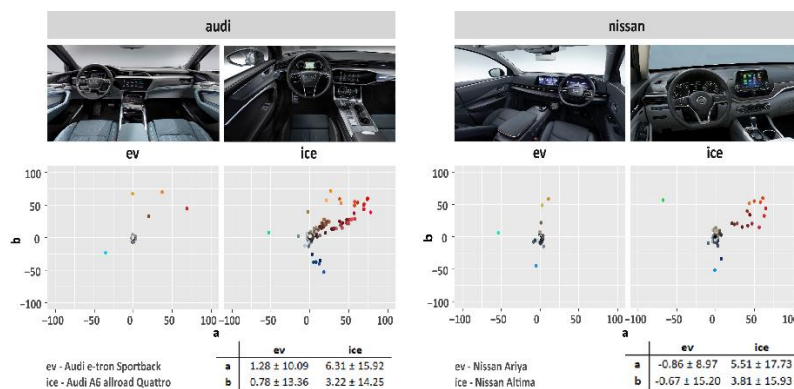

Figure 3: Example of original photo used for k-means clustering and results of color palettes from k-means clustering on both EV and ICE interior images of Audi and Nissan.

Furthermore, two automakers have resulted significantly in their "a": Audi and Nissan (Figure 3). The average "a" of 77 Audi EV color palettes is 1.28, with a standard deviation of 10.09. Compared

with the average "a" of 350 Audi ICE color palettes, 6.31, with a standard deviation of 15.92. The independent t-test yielded statistical evidence with 99.5% confidence [ $t(425) = 2.659, p < 0.05$ , two-tailed]. The average "a" of 42 Nissan EV color palettes is -0.86, with a standard deviation of 8.97. Compared with the average "a" of 112 Nissan ICE color palettes, 5.51, with a standard deviation of 17.73. The independent t-test yielded statistical evidence with 99.5% confidence [ $t(152) = 0.028, p < 0.05$ , two-tailed]. Significantly, two automakers use more green in their EV interiors than ICE interior design. However, for "a", both brands do not use greenish colors expressively in their photos.

### Findings on representative colors by major OEMs

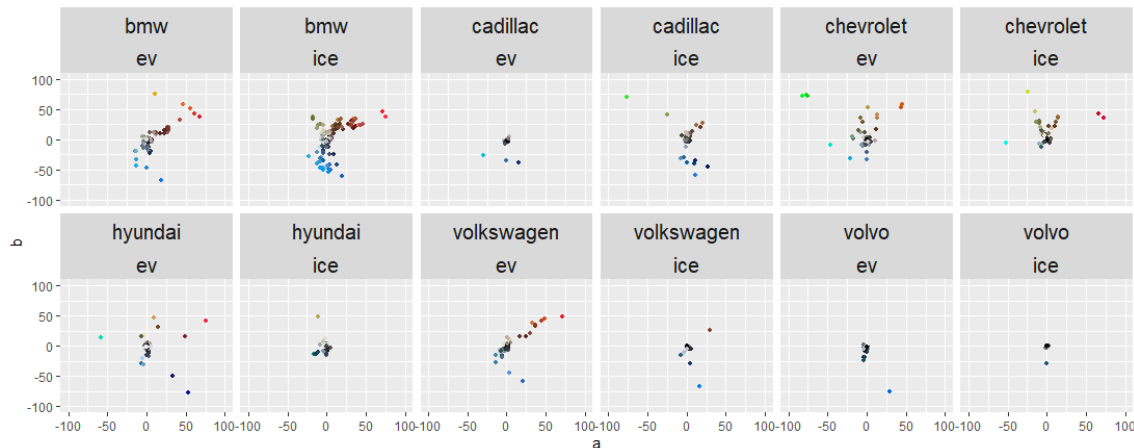

Figure 4: Results of color palettes from k-means clustering on both EV and ICE interior images from other OEMs.

A total of five automakers among 11 major OEMs shown statistically significant results in either "a" or "b" of EV interior design color palettes. As shown from the statistical results above, Mercedes Benz significantly plays with blue and green tones in their EV interior design. The current transition in their vehicle portfolio signifies that such color shifts in EV interiors toward either a blueish or greenish appearance in electrification found in the other OEMs. As shown in Figure 4, it is interesting that even though some companies like Hyundai or Volkswagen did not yield significant statistical evidence, their interior color palettes also show a similar shift. Interestingly, ICE vehicles adopt red expressively in their interior (Figure 4). As many automakers favor using red to show their vehicle's sporty feeling and performance, we can assume that blue is likely to represent EV interiors and the favored color of use in future vehicle representation.

### DISCUSSION AND CONCLUSION

Although only five automakers showed the statistical result in either blue or green on EV vehicle interior design, color association in EV vehicle interior is actively shifting. As many automakers aim to go full electrification in their vehicles, such color transition from red that represented ICE cars will shift to blue as more EVs arrive soon. Furthermore, as heritage brands like Mercedes Benz and Ford have shown statistically significant results in adopting blue usage in their vehicle, other vital OEMs will follow a similar path toward visual representation of electrification. Consequently, we identified that blue is the representative color for future vehicles through k-means clustering and statistical approach by comparing EV and ICE interior side by side.

The limitation of the study lies in the image collection. The images collected in the research strongly rely on the OEMs' intention of conveying the message of electrification make the company exaggerate

in articulating the photos to tell the specific appearance and emotional appeal. Consequently, it was challenging to identify such a shift in color solely by examining the photos. Also, it is noteworthy that there might be more blues and greens in pixel-level as most car interiors took in the outside scenery. Hence, it is essential to control such external factors from either the algorithm or the manual transformation of the original image. Nevertheless, even with such limitations, we successfully identified that many automakers favored using blue as a representative color to shift toward electrification and determined influential brands like Mercedes Benz and Ford. Thus, they lead such trends in the industry of blue appearance in the EV interior.

The brand will try to expressively advocate the message of electrification and eco-conscious brand image by using blue nuance in their press images and an accent color that creates the interior atmosphere. The study did not cover lighter values and darker values during the analysis; EV interiors will have value shifts in their color palettes due to new materials that use eco-friendly manufacturing or reusable materials to introduce new color palettes in EV interiors. In addition, automakers will advocate such a change in materials by providing lighter color usage in EV interior as some recent EVs have shown lighter color seats and instrument panels. However, the accuracy of color used in each vehicle's interior component is not prominent as the study analyzed the overall appearance of the press-released photos for color transformation from ICE to EV. Thus, the study aims to identify the representative color of EV from the overall appearance; the future study will identify from the component level and shifts in a different range of values and saturations of the EV interiors.

## **ACKNOWLEDGEMENTS**

This work was supported by the National Research Foundation of Korea (NRF-2018R1A1A3A 04078934) and the BK21 plus program through the National Research Foundation (NRF) funded by the Ministry of Education of Korea (NO.4120200913638).

## **REFERENCES**

- Govers, P.C.M. 2004. *“Product Personality”*, Dissertation, Delft University of Technology, Delft, 15 June.
- Lin, S., and P. Hanrahan. 2013. Modeling how people extract color themes from images. In: *Proceedings of the SIGCHI Conference on Human Factors in Computing Systems*.
- Lim, D., T.H. Baek, S. Yoon, and Y. Kim. 2020. Colour effects in green advertising. *Int J Consum Stud*. 44: 552– 562.
- Lee, J., B. Jung, and W. Chu. 2015. Signaling Environmental Altruism through Design: The Role of Green Cue Prominence in Hybrid Cars. *International Journal of Design* [Online] 9:2. Available:
- Sundar, A., and J.J. Kellaris, J. 2016. Blue-washing the green halo: How colors color ethical judgments. In: R. Batra, C. Seifert, and D. Brei (Eds.), *The psychology of design: Creating consumer appeal*. Routledge/Taylor & Francis Group, 63–74.
- Sundar, A., and J.J. Kellaris. 2017. How Logo Colors Influence Shoppers’ Judgments of Retailer Ethicality: The Mediating Role of Perceived Eco-Friendliness. *J Bus Ethics* 146, 685–701.
- Weeks, A. R., and G.E. Hague, 1997. Color segmentation in the HSI color space using the K-means algorithm. *Nonlinear Image Processing VIII*.

# Visualization of Chair Color Data through Network Analysis

Boram Kim<sup>1</sup> and Hyeon-Jeong Suk<sup>1,\*</sup>

<sup>1</sup> Department of Industrial Design, KAIST; ram.kim@kaist.ac.kr

\* Corresponding author: Department of Industrial Design, KAIST; color@kaist.ac.kr

## Abstract

We visualized the color combinations used in design chairs by using a social network analysis method. This paper suggests a new approach in the context of the research of how different color combinations appeal to a particular style. As chairs are meaningful in design history, 1000 chairs were chosen as an analysis material, we employed a total of 14 color categories mainly based on the basic color names. After applying the network analysis with this dataset, we visualize the network: an integrated version of the network based on color categories. According to the analysis results, nearly half of the chairs which consist of a single color and achromatic colors, such as black, gray, and white, were positioned closest to the center of the network. Through the study, we analyzed color combinations used in design chairs and visualized the relation of different colors.

**Keywords:** Color Combination, Social Network Analysis, 1000 Chairs, Color Network

## INTRODUCTION

Studies for subjective judgments of single colors have been widely addressed. Kobayashi (1981) studied distinctive colors that were often associated with categories of emotions. In the context of the color study, color combinations that affect feeling and emotion were widely used. Researchers (O'Donovan, Agarwala and Hertzmann 2011; Kim and Suk 2015; Bae and Suk 2016) tried to identify harmonious color combinations within a set of color schemes. From the studies, we derive that using color combinations can deal with sensitivity designers want or highlight the properties of the product. However, at the same time, we inquire about color combination studies that apply differently from product to situation. That is, there is a need for a general way to explore the relationship of color combination study.

One effective method to visualize relations is Social Network Analysis (SNA). The Big difference from the traditional data analysis methods including table and histogram is that the network data contains relation data, called *Edge*. *Edges* contain and visualize hidden structural connections or patterns in the relationship. Traditional data attributes are called *nodes*, having attributes and characteristics the same as the traditional data. SNA is an analysis method that focuses on the relationship and patterns formed by traditional individual variables and the variable-centric approaches (Knoke 2008).

To investigate color combinations and their effect on product design, we applied SNA to visualize and analyze color combinations. The purpose of the study was to explore color combinations in chair design with clear evidence. By examining network-level factors, we investigated how the chair color combinations were constructed and visualized the relationship between different colors.

## METHOD

### Data collection

We chose a chair as the target. Regarding the value and the meaning of the chair in the product design field, exploring the color combination on the design chair can support the design process. The book called 1000 chairs (Fiell, 2015), containing the collection of 1000 design chairs, was selected as the material, this book arranges the materials those chairs are made of and explains the context and the design value of each design chair. Among 1000 chairs, we excluded 230 chairs which are a sketch image

and a different version or original. After all, we appreciated the novelty of the book and developed the color list to generate the node and the edge data. This color list is assigned to the color labeling method for 770 chairs.

Code for 14 colors													
1	2	3	4	5	6	7	8	9	10	11	12	13	14
black	blue	brown	chrome	gold	gray	green	orange	pink	purple	red	Trans- parent	white	yellow

Table 1: Code for 14 colors.

To demonstrate the color combination graph, a list of colors for data stacking was considered. The color list is shown in Table 1, which is composed of 14 colors. Based on the 11 basic colors, we added three material colors such as gold, chrome, and transparent. Among the 14 colors, the design chair must use more than one color. When the chair has two colors, here, there is one relation data. We decide to call the most dominantly used color as prime color. The other color, which is used in a small portion relatively, we call this as a minor color or secondary color. In the case of a half-and-half color combination, we set the color which has a higher chroma value as the prime color. When the chair has more than two colors, there are more than one relation data; If the chair is composed of three colors, it means there are three relationship data. If the chair is composed of four colors, it means there are six relation data, and so on. So, if you let  $n$  as the number of colors used in the chair, then the number of possible relation data becomes  $n \times (n - 1) \times \frac{1}{2}$ . For each relation data in one chair, the color which has a relatively dominant or larger portion is called prime color, and the leftover is called secondary color, tertiary color, and so on. The example is shown in Figure 1.

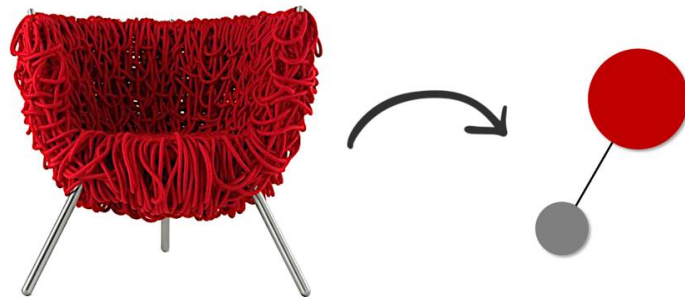

Figure 1. The color combination of Vermelha chair is transformed into prime red and secondary chrome.

**Metrics representation of the color combination graph**

*Node and link*

*Node* represents color and *edge* represents the combination of two colors among design chairs. Using the information, we generate 14 nodes representing the colors black, blue, brown, chrome, gold, gray, green, orange, pink, purple, red, transparent, white, and yellow, respectively. With the nodes, a relation metrics of color combination,  $C$ , was constructed, where element  $C_{ij}$  denoted the prime color as  $i$  and the secondary color as  $j$ . The  $C_{ij}$  represents *edge*, which means the relation data of two colors. For example, among 770 chairs, if five design chairs have prime red and secondary chrome combination, it becomes  $C_{11\ 4} = 5$  and we call *edge*, a number of relation data counted, was used to calculate density, degree centrality, and betweenness centrality.



In the study, we generated 70 nodes, which means 14 colors for each prime colors, secondary colors, tertiary colors, quaternary, and quinary colors ( $14 \times 5 = 70$ ) to see the utilization of color and the combination. The edges are designed in a non-direction mode.

*Analysis Condition*

UCINET software was used to analyze the chair network. The freeware UCINET supports various conditions and modes such as data format, duplicate ties, output options, and symmetry. The input value is a metrics with which the Data Language (DL) format is favorable. We used the relation metrics of color combination  $C$  as an input value.

**RESULTS AND DISCUSSION**

**Network Visualization with Pajek**

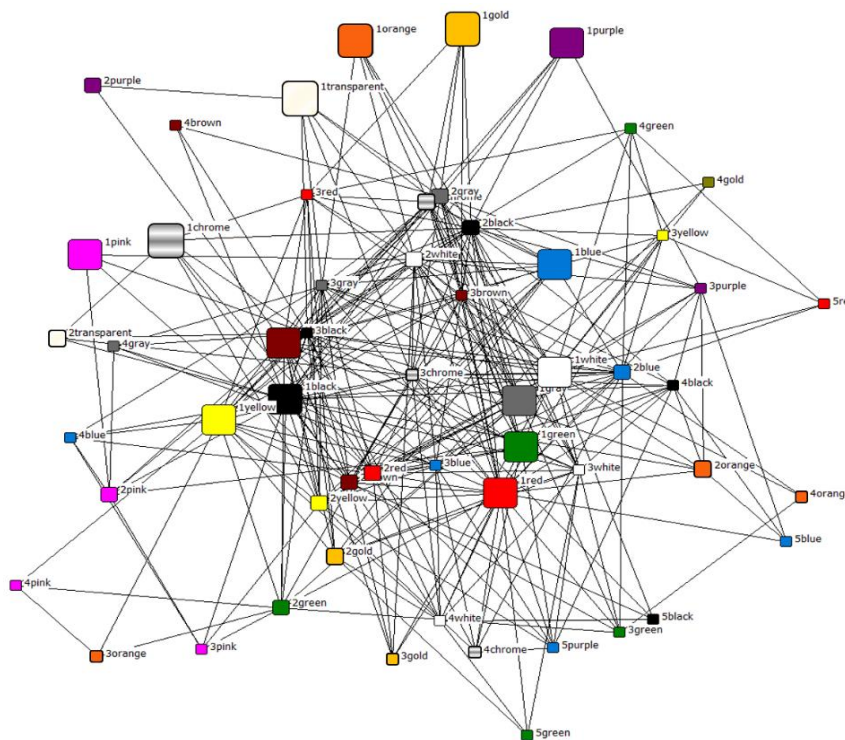

Figure 2. Visualization of color combination network with Pajek. Nodes are labeled by dominance. Header, a number in front of the color is the dominance intensity. For example, 1white means prime white, and 2red means secondary red. Edges denote color combinations and indicate that two colors have been used in at least one design chair.

We used Pajek, an SNA tool, to visualize the color combination graph. To illustrate the network measure, consider the network diagram depicted in Figure 2. The diagram indicates which is the prime color, secondary, and tertiary color. This information is depicted as nodes. A larger node size indicates the dominant of the color in chair design. The prime color nodes are the largest, the secondary color nodes are the next, and the other colors including tertiary, quaternary, and quinary colors are the smallest. From now on, we will call this network the color combination network.



There are two ways of investigating metrics. One way is observing the whole network with size, shape, density of the network and the other way is examining node and edge characteristics including the position of nodes, centrality, and connectivity.

<b>Feature</b>	<b>Colors</b>	<b>Degree centrality</b>	<b>Betweenness centrality</b>	<b>Colors</b>	<b>Degree centrality</b>	<b>Betweenness centrality</b>
<b>Prime</b>	Black	7.9	6.19	Orange	0.8	0.03
	Blue	1.4	0.38	Pink	0.3	0.06
	Brown	7.5	5.31	Purple	0.2	0.04
	Chrome	0.7	0.33	Red	3.9	10.04
	Gold	0.2	0.04	Transparent	0.6	0.78
	Gray	2.6	0.93	White	7.0	9.95
	Green	1.2	1.37	Yellow	1.9	6.32
<b>Secondary</b>	Black	6.9	6.33	Orange	0.3	0.33
	Blue	1.4	3.85	Pink	0.5	0.65
	Brown	4.8	2.97	Purple	0.1	0.01
	Chrome	4.9	1.77	Red	2.0	2.59
	Gold	0.9	0.79	Transparent	0.2	0.05
	Gray	4.9	3.59	White	7.0	6.54
	Green	1.0	2.52	Yellow	1.3	2.25
<b>Tertiary</b>	Black	3.9	6.74	Orange	0.1	0.00
	Blue	0.7	2.10	Pink	0.2	0.18
	Brown	2.0	1.06	Purple	0.5	0.92
	Chrome	2.6	3.86	Red	0.7	1.17
	Gold	0.7	0.04	White	1.8	1.57
	Gray	2.4	2.38	Yellow	0.5	0.53
	Green	0.3	0.51			
<b>Quaternary</b>	Black	0.7	0.97	Gray	0.3	0.07
	Blue	0.3	0.24	Green	0.3	0.22
	Brown	0.1	0.00	Orange	0.1	0.00
	Chrome	0.3	0.14	Pink	0.1	0.00
	Gold	0.1	0.00	White	0.5	0.87
<b>Quinary</b>	Black	0.2	0.00	Purple	0.4	0.17
	Blue	0.2	0.00	Red	0.2	0.00
	Green	0.2	0.00			

Table 2. Relative value of degree centrality and betweenness centrality of the color combination network with UCINET (Unit: %).

*Density*

Density of a graph is the frequency of connected edges relative to all possible edges. Density value tells us how the network is well connected of all possible connections. Density of the color combination network is 0.64. Sociology studies generally denote the density value  $< 0.1$  (Lee 2017) and they are usually dealing with the density values around 0.05. Though comparing other general sociological-characteristic-based networks and taking into account that the node list has only 14 colors, the color combination network is a kind of very dense network, which indicates color combination is strongly intended design process.

*Degree centrality*

Degree centrality (DC) indicates the degree of connection with other nodes by calculating the ratio of direct connections with other nodes. The high DC values are observed mostly in prime colors and secondary colors (is shown in Table 2). They were prime brown (7.5%), black (7.9%), gray (2.6%), and white (7%).

Having a high DC value among prime colors means that those colors were used as the main color of the chair, but often as a combination instead of being used alone.

High DC value among secondary colors means that those secondary colors were used as an overwhelmingly diverse combination than other secondary colors. Thus, we inferred that the designer preferred achromatic colors as secondary black (6.9%), gray (4.9), chrome (4.9), and white (7.0%), and red (2.0%) color at least twice to 20 times more than other colors in chair design. The value of DC of prime brown (7.5%) seems to stem from the material feature of the chair.

Lastly, prime green (1.2%), orange (0.8%), chrome (0.7), and transparent (0.6%) colors have low DC values. It refers to the fact that those colors were used exclusively in chair design, in contrast to the prime red. Also, secondary, tertiary, quaternary and quinary colors including blue, yellow, green, gold, pink, and purple have low DC. It shows that specific color combinations tend to be cliché in chair design.

*Betweenness centrality*

Betweenness centrality (BC) represents the bridge node of the network. High BC value color works intermediary roles in color combination. In other words, the higher the BC value, the more to be considered and favored at the three or more color combinations, and actually, it is the color that has been tried a lot in chair design.

It is remarkable that prime red has the highest BC value (10.04%) throughout (is shown in Table 2). It is higher than that of prime white (9.95%), indicating that even if the colors are not generally used in combination, they are used well with red; reds are much loved for point color. Looking further at the high BC value prime colors, there are white (9.95%), yellow (6.32%), black (6.19%), and brown (5.31%). Prime yellow and brown were used in wooden or leather. We inferred that material information is important in color combination analysis.

The color combinations were expressed and analyzed over a network. It is remarkable that a new method, network analysis, is applied to identify color study and to visualize effectively. Furthermore, we not only suggest a quantitative study method for color combination and the designer's preference but also advocate study on the importance of material colors. Material can play an important role in color combination and product design and is still unveiled.

There are some improvements. First, new data needs to be added to identify chairs or products after 1999. Since the book, 1000 chairs, only covers the chairs made before 1999, we need to consider

the way of expanding the network. Second, to investigate the color combination effectively, an improvement to graph UI is needed. We plan to develop an improved version of the network that allows interaction with one click. It will show users a series of chair images containing color combinations using R, an open-source programming language.

In the context of the color study, if more analysis and investigation proceeded, we are able to agree on two agendas. First, as the network expands over the color area, proposition can be obtained for how specific materials and color combinations work with each other. Second, color combination is centered on the achromatic color and is hierarchical. Currently, the position of minor achromatic color nodes is at center of the network. To establish the role of colors, more data is needed and should be accumulated.

## **CONCLUSION**

In this study, we visualized the color combinations used in design chairs by using a social network analysis method. From the book, *1000 chairs*, color combination data was collected according to the dominance of color and transformed into node and edge form. We found that the density of the network is 0.64, which indicates that color combination is strongly intended design process. Degree centrality and betweenness centrality value support that wooden material colors including brown, yellow and achromatic colors including black, gray, and white play an important role in color combination with clear evidence. In particular, red records the highest betweenness centrality value (10.04%). This paper suggests a new approach in the context of the research of how different color combinations appeal to a particular style.

## **ACKNOWLEDGMENTS**

This work was supported by the National Research Foundation of Korea (NRF-2018R1A1A3A04078934) and the BK21 plus program through the National Research Foundation (NRF) funded by the Ministry of Education of Korea (NO.4120200913638).

## **REFERENCES**

- Bae, H., and H. Suk. 2017. Material reconfiguration for visual exploration of product design alternatives.
- Fiell, C., and P. Fiell. 2015. *1000 chairs in the 20th century* (No. 1, pp. 1-622). Taschen Press.
- Kim, E., and H. Suk. 2015. Understanding Crowd-Sourced Color Schemes through Network Analysis. *Journal of Korean Society for Color Studies* 29, 3, 67-76.
- Kobayashi, S. 1981. The aim and method of the color image scale. *Color research and application*, 6(2), 93-107.
- Knoke, D., and Yang, S. 2008. Network fundamentals. *Social network analysis*, (154), 3-14.
- Lee, S., and Lee, W. 2017. Strategizing marriage: A genealogical analysis of Korean marriage networks. *Journal of Interdisciplinary History*, 48(1): 1-19.
- O'Donovan, P., A. Agarwala, and A. Hertzmann. (2011). Color compatibility from large datasets. In: *ACM SIGGRAPH 2011 papers*: 1-12.

# Observed changes in garment color selection of university students across normal and test periods

Terumi Konno <sup>1,\*</sup>, Koichiro Kakiyama <sup>2</sup> and Yasuhiro Kawabata <sup>1</sup>

<sup>1</sup> Department of Psychology, Hokkaido University; konno.terumi.d4@elms.hokudai.ac.jp, kawabata@let.hokudai.ac.jp

<sup>2</sup> Faculty of Design, Sapporo City University; kakiyama@scu.ac.jp

\* Corresponding author: konno.terumi.d4@elms.hokudai.ac.jp

## Abstract

The present study examined whether university students' selection of their garments would be affected by normal or test periods. An observational study was conducted on a sample of Japanese university students to measure the difference in their selection of garment colors during normal school periods (n = 580) and test periods (n = 372), and the relationship between three garment color attributes across the school periods was analyzed. The results revealed that the selection rate of achromatic colors for upper garments was 59% during the normal school periods; however, it increased to 64% during the test periods. Moreover, the proportion of the chromatic colors in the upper garments decreased during the two periods, whereas that of the achromatic colors increased during the test periods, along with the average garment lightness. Data suggest that the students might avoid stimulating or distracting salient colors to concentrate on examinations.

**Keywords:** *feeling of tension, garment color selection, normal and test periods, three color attributions, video camera recording*

## INTRODUCTION

In general, individuals are free to select their garments and belongings in daily life, although the selection criteria may differ. In this regard, this study proposes three categories for the selection of daily garments, namely, fashion, functionality, and sociality, which are defined as follows.

- Fashion is an element of garment that expresses identity and strongly reflects the will of the individual. Fundamentally, this aspect is not subject to external restriction.
- Functionality denotes dependence on the season and weather. For example, individuals prefer to wear garments with waterproof materials or colors that neutralize water splashes during the rainy season.
- Sociality pertains to social restrictions on garments, such as time, place, and occasion, which exist in the cultural background of a country/region. For example, at Japanese weddings, wearing white is taboo for female guests because it is reserved for the bride's wedding dress, while at funerals, all attendees are expected to wear black.

Regarding sociality, studies have been conducted on the impression of garments on others, especially garment recognition (Behling and Williams 1991). For example, several authors have reported that the garment choice of high school students influences the perceptions of academic ability among their peers and teachers. Related research has shown that if women wear masculine garment during a job interview, then they are more likely to be hired (Forsythe 1990), whereas if they wear feminine garment during work, then they are considered to have low ability (Maeda and Noguchi 2014). In these examples, the choice of garment is not made by an individual's free will, but by the indirect influence of those surrounding him/her.

Naito (2014) found that in regard to dressing standards, students viewed "schools" as similar to "department stores," and they obtained low scores for "functionality" and "sociality." Meanwhile, the garment preference of university students emphasized fashion. Such emphasis was based on personal

choices that strongly reflected their intention and was less influenced by external factors. According to the aforementioned classification, the study surveyed a sample of university students and found that the external factors in relation to their garment preferences were unrelated to human judgment. In terms of fashion among the students and adults, the common reasons for their choice of garment included design and fashion. However, the number of individuals who cited mental and physical conditions (e.g., moods) as reasons for their choice of garment was less than 5% (Naito 2014). Against this background, do individuals tend to consider the impressions of others in terms of their daily garment choice or do they simply wear their favorite colors?

As for individual psychological factors, moods, and physical conditions, they often influence the daily choice of garment color, except in situations where there is a clear influence from others such as co-workers. For example, when an individual is feeling ill, which garment color will he/she select to wear to the hospital? Does color selection influence an individual's behavior?

To date, few studies have investigated the relationship between mood, physical condition, and color choice. The reason may be that it is relatively difficult to limit mood and physical condition. Regarding emotions and colors, Takahashi and Kawabata (2018) reported on the relationship between positive emotions and bright colors, and negative emotions and dark colors. In other words, physical condition and mood are related to the color selection of clothes. For example, if people feel well or ill, they tend to feel positive emotions or negative ones, respectively. They might also choose bright color or dark colors, respectively. However, limited studies have argued that physical condition and mood have an effect on garment choices. Regarding tension, Iwase et al. (2015) found that when examining the psychological changes between normal school periods (hereafter referred to as "normal periods") and examination periods (hereafter referred to as "test periods") at a physical therapist training center, there was a significant difference in tension and depression, compared to normal periods. In a related study, Teradaira (2011) revealed that he felt tension, anxiety, and stress during the test period. Interestingly, based on an Internet search in Japan (performed on 5-31-2021), there are 726,000 ways to make one feel less anxious or nervous about taking an examination.

In sum, we found the following results. First, in general, students freely choose their clothes when they go to school because they are different from those worn at work. Second, negative emotions tend to influence color choices. Finally, students are usually nervous during examinations. For these reasons, the present study examined the relationship between tension and garment color selection by comparing university students' normal periods and test periods.

## **RESEARCH OBJECTIVES AND HYPOTHESES**

This study focused on the garment choices of university students during normal periods and test periods (i.e., tension periods). Since mood is limited to tension, and test periods are generally tenser than normal periods, we investigated the changes in garment during both periods. Overall, the purpose of this study was to clarify the effect of tension on university students' garment color preferences. We also hypothesized that garment color changes will occur in three attributions, namely, hue, lightness, and saturation during these two periods.

## **OBSERVATIONAL STUDY**

### **Object**

A survey was conducted on a sample of students at University S from July to August 2018. The recording time was approximately one hour (from 8:00 a.m. to 9:00 a.m.), which was the students'

Observed changes in garment color selection of university students across normal and test periods normal attendance time. In addition, in order to avoid color bias (due to weather), observations were made for four days during the normal periods and the test periods, respectively. In this case, the weather for the four days during the normal periods included two days of fine weather, one day of cloudy weather, and one day of rain, with an average temperature of approximately 20 degrees Celsius and a humidity level of 79%. As for the test periods, the weather included one sunny day, one cloudy day, and one rainy day, with an average temperature of roughly 20 degrees Celsius and a humidity level of 75.7%.

### **Procedure**

A video camera (SONY HDR-XR550V) was installed at the entrance of the school to determine the changes in the students' garment color preferences during the normal periods and the test periods. The camera was mounted on a stepladder approximately 140 cm high. The distance between the camera and the hall was roughly 6 m, while the angle was set so that the entire body of each passer-by could be photographed. Data collection occurred for four days in July (during the normal periods) and four days in August (during the test periods). Overall, we selected 580 and 372 still shots of the students during both periods, respectively. For our analysis, color information was extracted from the photographs and transferred on a computer. A PCCS color card was used to visually verify the color of garment for the upper- and lower-body during both periods (see Figure 1). The color identified on the color card was replaced with an approximate color and converted to a Munsell value. The color data was then categorized according to three attributes; namely, hue, lightness, and saturation, after which the relationship between each attribute and tension was analyzed.



Figure 1: PCCS 199a color card (JAPAN COLOR ENTERPRISE Co., Ltd.).

### **RESULTS AND DISCUSSION**

This study examined the changes in the proportions of chromatic and achromatic colors between the two periods. Specifically, it observed 13 major Munsell hues (i.e. R, YR, Y, GY, G, GB, B, PB, P, RP, W, N, and Bk), which were classified into chromatic (10 hues, i.e., R, YR, Y, GY, G, GB, B, PB, P, and RP) and achromatic (i.e., W, N, and Bk) colors. The selectivity of the chromatic and achromatic color was compared between the upper and bottom garments during the normal periods and the test periods. Regarding the upper garments, the selection rate of achromatic colors in the former was 59%, while the selection rate of such colors in the latter increased to 64%. As for the bottom garments, the proportions of chromatic and achromatic colors were both approximately 50% for the normal periods and the test periods (see Figure 2). Subsequently, a chi-square test was performed on the garment selectivity for the two periods. For the upper garments, there was significant difference ( $\chi^2(1) = 6.59$ ,  $p < 0.05$ ). This indicated that the proportion of the chromatic colors in the upper garments decreased, whereas the proportion of the achromatic colors in such garments increased during the test periods.

Regarding the bottom garments, no significant difference was found ( $\chi^2(1) = 0.21$ ,  $p = 0.64$ ) (see Figure 2). Interestingly, the chi-square test revealed a significant difference in the upper garments. Specifically, the proportion of achromatic colors in the upper garments increased during the test periods, while the selection of chromatic garment increased during the test periods, but decreased during the normal periods. This showed that since the students during the test periods were probably more nervous and stressed, they may have avoided stimulating colors and selected achromatic ones such as white.

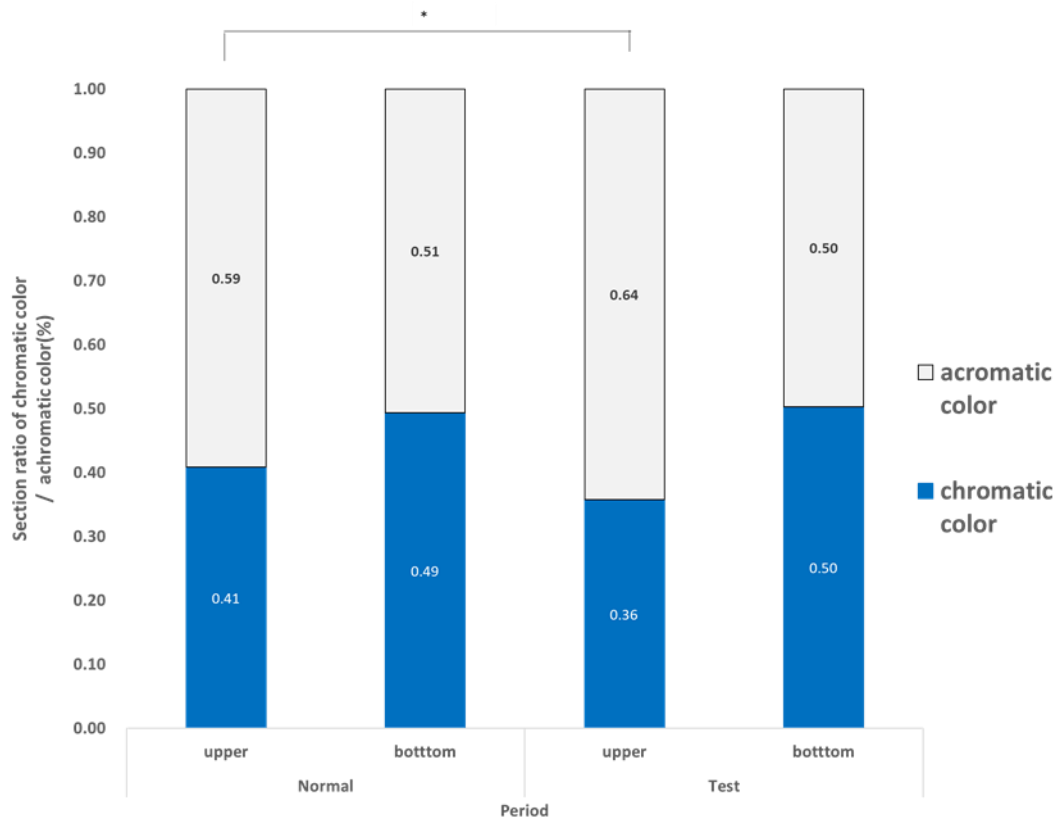

Figure 2: Tendency of garment color choices (chromatic and achromatic colors) during both periods.

Figure 2 shows that the selection rate of chromatic colors during the normal periods was 41%, but it decreased to 36% during the test periods. Meanwhile, the achromatic color selection rate during the normal periods was 59%, but it increased to 64% during the test periods. Regarding the upper garments, the ratio of chromatic and achromatic colors during the normal periods was approximately 50%, respectively, which was roughly the same as those during the test periods.

Furthermore, this study investigated the relationship between tension and other attributes such as lightness and saturation. Primarily, the lightness of the garment during both periods was compared to clarify its relationship with tension. For lightness, the data regarding the color of the upper and bottom garments was used (see Figure 3). In this regard, the unpaired t-test results ( $t = 2.68$ ;  $p < 0.001$ ) indicated that color brightness significantly increased during both periods. In other words, the students generally wore bright garment during the test periods, compared to the normal periods. We also hypothesized that brightness will increase because the proportion of students wearing white hues will increase during the test periods. However, why is white related to tension? A possible explanation is

Observed changes in garment color selection of university students across normal and test periods that body temperature tends to increase, due to the lack of sleep during test periods. Consequently, students tend to avoid warm colors with low brightness levels.

In order to clarify the relationship between tension and saturation, the latter was compared between the two periods using an unpaired t-test (see Figure 3). In terms of the mean values, those for saturation during the test periods were lower than those during the normal periods. In other words, this suggests that as the tension increases, the color preference of students is inclined toward colors with low saturation. Previous studies have proposed that individuals tend to opt for bright-colored garment when healthy and dull-colored garment when depressed/ill (Konno 2019). For example, since bright colors can be somewhat stressful when appreciating art, depressed individuals tend to avoid art exhibitions.

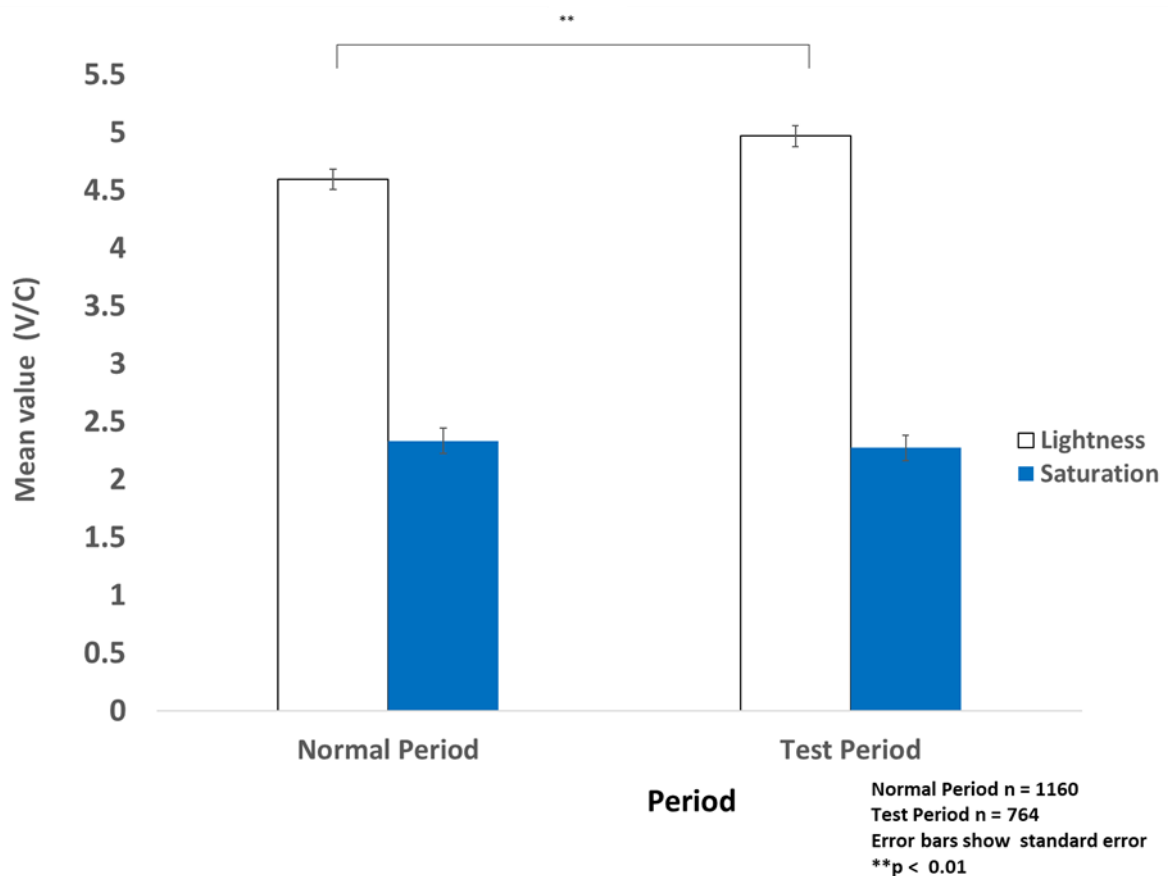

Figure 3: Lightness and saturation for the two periods.

In Figure 3, the lightness and saturation for the normal periods and the test periods, respectively, were compared by averaging the Munsell values. Based on the findings ( $t = 2.68$ ;  $p < 0.01$ ), brightness significantly increased during the test periods.

### CONCLUSION

This study focused on the relationship between color selection and tension in relation to students' garment in daily life. In terms of color preference, we conducted a survey on the relationship between color choice and tension among students in a private setting in order to omit the possible effects of external factors. Based on the results, the color of the students' clothes differed between the normal



Observed changes in garment color selection of university students across normal and test periods and the test periods when tension increased, thus supporting our hypothesis. Additionally, the influence of tension on garment color selection led to a significant difference in hue and lightness, whereas no association was found between saturation and physical condition. In terms of hue, the color white was strongly related to tension for the following reasons. First, the students may have refrained from experiencing unnecessary stimuli in order to maintain the information they possessed for the examinations. Second, the students may have subconsciously selected clothes with low levels of hue and saturation.

Overall, the present study concluded that tension influences garment color selection among university students. In other words, to reduce the level of tension during examinations and other stressful situations, students tend to choose appropriate and comfortable garment colors. Despite these findings, several limitations should be addressed. First, to generalize the findings of this study, future research should conduct an experiment in which the participants select the color of their clothes during stressful situations and relaxed situations, respectively. Second, future studies should consider the implementation method, including detailed questions such as the reason for choosing the hue of clothes. Third, future research should stimulate scenarios that induce tension and enable the participants to make their garment color and comfort preferences. Finally, since the present study limited the experiment to Japanese university students, future surveys should be conducted overseas in order to determine whether cultural factors produce similar or different results.

## **ACKNOWLEDGMENTS**

This research was supported by the graduate grant program at Hokkaido University.

## **REFERENCES**

- Behling, D. U., and E. A. Williams. 1991. Influence of dress on perception of intelligence and expectations of scholastic achievement. *Clothing and Textiles Research Journal* 9: 1-7.
- Forsythe, S. M. 1990. Effect of applicant's clothing on interviewer's decision to hire. *Journal of Applied Social Psychology* 20: 1579-1595.
- Iwase, H., K. Suganuma, H. Takada, and H. Maruyama. 2015. Comparison of term-time and end-of-term subjective and psychological stress of physical therapy vocational training school students. *Rigakuryouhou Kagaku* 30: 11-14.
- Konno, T. 2019. The research study in hue selection of clothes and nervousness. *Journal of the Color Science Association of Japan* 43: 99-102.
- Maeda, A., and A. Noguchi. 2014. Research on the attitude and consciousness on clothing selection. *Bulletin of Faculty of Education, Gunma University* 49: 193-198.
- Naito, A. 2014. Consciousness of clothing norms and educational experience about wearing in junior, senior high school, and university students. *Journal of the Japan Research Association for Textile End-Uses* 55: 38-50.
- Takahashi, F., and Y. Kawabata. 2018. The association between colors and emotions for emotional words and facial expressions. *Color Research and Application* 43: 247-257.
- Teradaira, R. 2011. Gakusei no shiken sutoresu no ōkisa o shukanteki hyōka de hakaru hōhō nitsuite no ichi kōsatsu 学生の試験ストレスの大きさを主観的評価で測る方法についての一考察 [One consideration on how to measure the magnitude of student exam stress by subjective evaluation]. *Japanese Society of Psychosomatic Medicine* 51: 272.

# Relationship Between Taste Impression and Color in Snack Packages

Masato Sakurai <sup>1,\*</sup> and Ryoma Yamamoto <sup>1</sup>

<sup>1</sup> Shizuoka Institute of Science and Technology, Fukuroi, Shizuoka, Japan; sakurai.masato@sist.ac.jp, 1718136.yr@sist.ac.jp

\* Corresponding author: sakurai.masato@sist.ac.jp

## Abstract

To reveal the relationship between taste impression and color (its combination) in food packages, especially snack packages, a subjective evaluation experiment was carried out presenting the image of snack packages commercially available. Ninety-nine images were selected from snack packages commercially available as the stimuli in this experiment. The participants were asked to evaluate the impression of basic tastes (sweetness, sourness, saltiness, bitterness, and umami) in stimuli presented to each taste on a five-point scale. In the results, the stimuli with high red color occupancy in the image of snack package were highly evaluated the impressions of sweetness and umami. Compared with the results of the previous study, it is suggested that the highest occupancy color of snack packages strongly affects its taste impression visually.

**Keywords:** *Taste impression, Color, Subjective evaluation, Snack package, Visual stimulus*

## INTRODUCTION

Colors are not only visual information but also affect taste impressions to humans. Therefore, you can imagine that it applies to a color combination of the design in food packages to encourage the purchase of the food. Previous studies have already reported that the colors of food and beverage have a significant effect on the preference and the perceived tastes (Jaros et al. 2000), and the effects of changing the color of the packaging label on the taste and impression of a popular PET-bottled tea beverage in present (Okuda 2019; Sakurai et al. 2021). And it was reported that the colors of reddish and yellowish hues visually feel sweetness and sourness with increasing chroma values, and achromatic and relatively lower lightness colors visually feel bitterness with decreasing lightness values (Sakurai et al. 2015). However, it is not clear how the color and color combination of the design in food packages affect the impression of the five basic tastes – sweetness, sourness, saltiness, bitterness, and umami, from the practical point of view.

The purpose of this study is to reveal the relationship between taste impression and color (its combination) in food packages, especially snack packages. In this study, a subjective evaluation experiment was carried out presenting the image of snack packages commercially available.

## EXPERIMENT

### Stimuli

Ninety-nine images were selected from snack packages commercially available as the stimuli in this experiment based on the survey in several sites. These images have edited the square of 1000 x 1000 px (265 x 265 mm) to consistently size each stimulus. The displayed characters were mosaicked to remove the influence of the product name. Figure 1 shows the sample image of stimuli in this experiment. The stimuli were presented by 23-inch display (Color Edge CS230, EIZO) placed in front of the observer and the viewing distance was 600 mm. They were displayed into the square at a visual angle of 24 deg in the center of the screen and set a gray as the background color.

## Procedure

After three minutes light adaption by the  $D_{65}$  fluorescent lamp in the experimental booth, the participants were asked to evaluate the impression of basic tastes (i.e., sweetness, sourness, saltiness, bitterness, and umami) in stimuli presented to each taste on a five-point scale (1: feel hardly, 2: feel slightly, 3: feel somewhat, 4: feel, 5: feel very much). The stimuli were presented randomly, and the duration time was 3 s. Then, the evaluation panel was displayed on the screen with a gray background and the participants input the value of its scale for basic tastes by the numerical keypad. In one session, the participants performed the evaluation of 99 times of all the stimuli and three sessions were carried out for one participant. It was 297 times in total. Prior to the experiment, the participants had an enough time to practice for the evaluation.

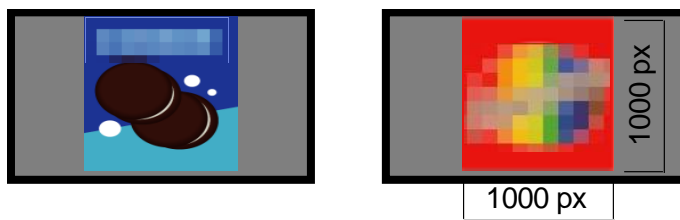

Figure 1: Sample image of stimuli in this experiment.

## Apparatus

Figure 2 shows the apparatus in this experiment. The experimental booth was covered with a black curtain. It was illuminated by the  $D_{65}$  fluorescent lamp of the light booth and the illumination of screen in the display was around 500 lx. The display was placed in front of the participant and the viewing distance was 600 mm. The participants were asked to respond with the numerical keypad when they evaluate the stimulus.

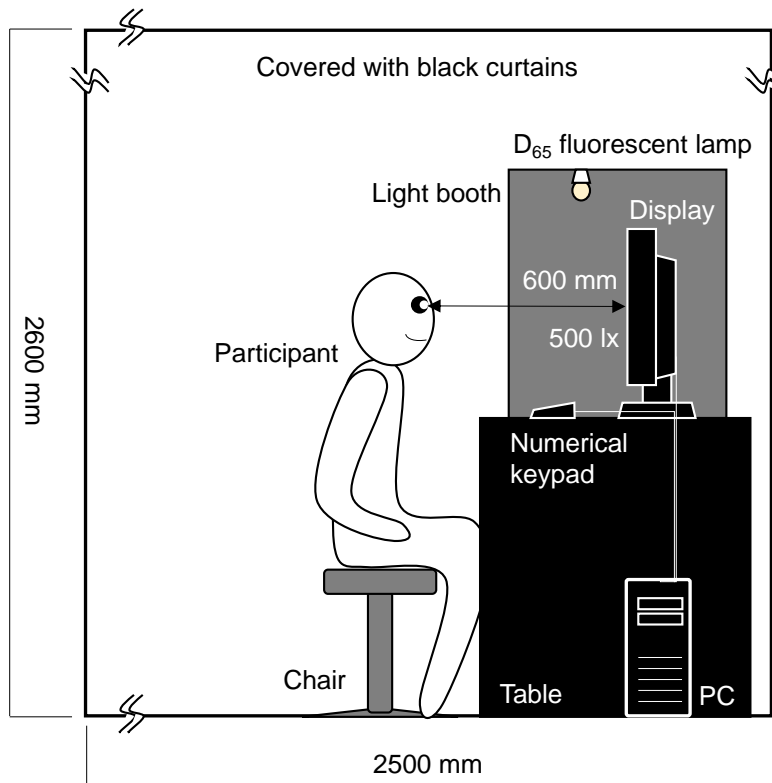

Figure 2: Apparatus.

## Participants

Eleven Japanese students participated in this experiment. They were one female and ten male students and were twenties age. It is same cultural context because they live in Japan so far. And they have the normal color vision.

## RESULTS AND DISCUSSIONS

### Taste impression in snack packages

Figure 3 shows the typical average results of taste impression for the stimuli based on all the participants evaluations. In each plot, each vertex of the pentagonal radar chart shows the subjective evaluation values of each of five basic tastes (i.e., Sw: sweetness, So: sourness, Sa: saltiness, Bi: bitterness, and Um: umami), with the further from the center, the higher values. Figure 3 (a) – (c) correspond to the results for the stimuli of each snack package shown in the left-top in each plot. Figure 3 (a) – (c) indicate the stimulus with high red, purple, and yellowish green colors occupancy in the image of snack package, respectively.

In this figure, the average values of each taste impression are different from all the stimuli. In Figure 3 (a), the values of sweetness and umami impressions are relatively higher than others so that it is considered to feel like sweetness and umami visually from its package including the colors and their combinations. In Figure 3 (b), the values of sweetness and umami impressions are not only higher but also the value of sourness is a little bit high. So, it is considered to feel like sweetness, umami, and sourness visually from its package as well as Figure 3 (a). In Figure 3 (c), the values of saltiness and umami are relatively higher than others so that it is considered to feel like saltiness and umami visually from its package as well. Although the experiences they have eaten affect the impression of taste from the packages as you can imagine, it is suggested that the snack packages including the colors and their combinations affect the impression of taste by the results in this study. It corresponds to the report of the previous studies of Okuda (2019) and Sakurai et al. (2021) even though they are beverages.

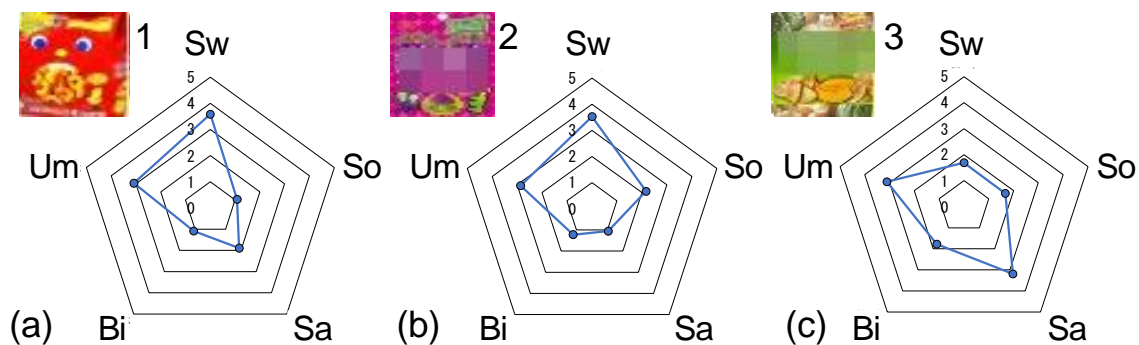

Sw: sweetness, So: sourness, Sa: saltiness, Bi: bitterness, Um: umami

\*Sources

1: <https://smashop.jp/resize/200x200/img/p/ss/4901940035786.jpg>

2: <https://tshop.r10s.jp/ecjoy/cabinet/image185/6268481.jpg?fitin=275:275>

3: [https://images-na.ssl-images-amazon.com/images/I/81lzg%2B9rgWL.\\_SX425\\_.jpg](https://images-na.ssl-images-amazon.com/images/I/81lzg%2B9rgWL._SX425_.jpg)

Figure 3: Typical average results of taste impression for the stimuli based on all the participants evaluations.

### Effects of occupancy color in snack packages from compared with the previous study

To examine the effects of occupancy color in snack packages, the results in this study are compared with the results of the previous study (Sakurai et al. 2015), which it investigates the effect on impression of the taste for color stimuli (i.e., color patches). Figure 4 shows the comparison of the results in this study and the previous study (Sakurai et al. 2015). In this figure, the configuration is the same as Figure 3. Figure 4 (a) and (b) correspond to the stimuli of Figure 3 (a) and (b), respectively. Each symbol indicates to the right of this figure. It is selected the results of the nearest color for the colorimetric values of the highest occupancy color in its snack package as the results of the previous study.

In this figure, the values of the most of taste impression for those stimuli are consistent with the results of previous study, which is single color. In Figure 4 (a), the value of sourness impression in this study is relatively different from that of the previous study because it is considered that the participants know the taste of this stimulus. Although there is the effect that they already have eaten and understood its taste, it is suggested that the highest occupancy color of snack packages affects its taste impression visually. In all the stimuli, the tendency is the same as well. Therefore, the results of this study correspond to that of previous study (Sakurai et al. 2015) so that colors affect the taste impression visually.

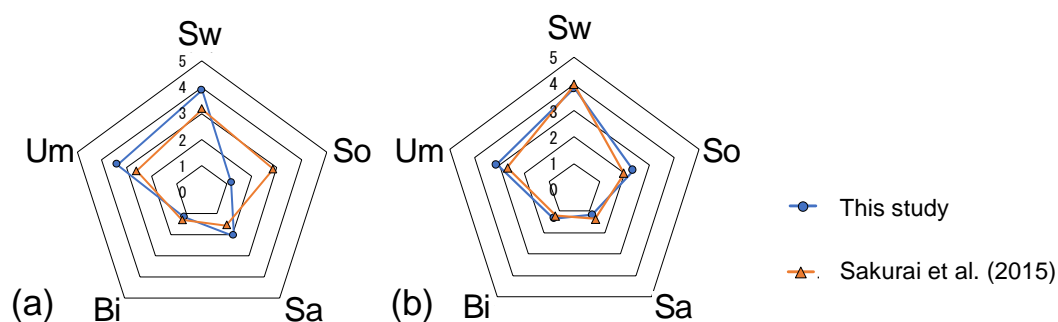

Sw: sweetness, So: sourness, Sa: saltiness, Bi: bitterness, Um: umami

Figure 4: Comparison of the results in this study and the previous study.

### CONCLUSION

To reveal the relationship between taste impression and color (its combination) in food packages, especially snack packages, a subjective evaluation experiment was carried out presenting the image of snack packages commercially available. Ninety-nine images were selected from snack packages commercially available as the stimuli in this experiment. The stimuli were presented by a 23-inch display placed in front of the observer and the viewing distance was 600 mm. The participants were asked to evaluate the impression of basic tastes (sweetness, sourness, saltiness, bitterness, and umami) in stimuli presented to each taste on a five-point scale (1: feel hard, 2: feel slightly, 3: feel somewhat, 4: feel, 5: feel very much). Eleven students participated in this experiment. In the results, the stimuli with high red color occupancy in the image of snack package are highly evaluated the impressions of sweetness and umami. Compared with the results of the almost same color with colorimetric values from the experiment with color patched in the previous study (Sakurai et al. 2015), these were same tendency. Although there is the effect that they already have experienced its taste, it is suggested that the highest occupancy color of snack packages affects its taste impression visually.

## **REFERENCES**

- Jaros, D., H. Rohm, and M. Strobl. 2000. Appearance properties – A significant contribution to sensory food quality?. *Lebensmittel-Wissenschaft & Technologie* 30: 320-326.
- Okuda, S. 2019. Delicious-Looking Package Color of Bottled Black Tea. *Proceedings of the 20th Congress of the International Ergonomics Association (IEA2018)*, AISC 827: 254-257.
- Sakurai, M., Y. Michinaka, and T. Yoshikawa. 2015. Effects on Impression of Taste in Color Stimuli. *AIC2015 Tokyo (the Midterm Meeting of the AIC (Association Internationale de la Couleur))*, 348-353.
- Sakurai, M., K. Sano, and S. Okuda. 2021. Impression of Label Color in PET Bottled Black Tea. *the 7th International Symposium on Affective Science and Engineering 2021 (ISASE2021)*, C000028.



# Effect of sensation modalities on texture evaluation of beige fabrics by Japanese and Chinese

Tomoharu Ishikawa <sup>1\*</sup>, Takumi Nakajima <sup>1</sup>, Yoshiko Yanagida <sup>2</sup>, Minoru Mitsui <sup>3</sup>, Kazuya Sasaki <sup>4</sup> and Miyoshi Ayama <sup>1,\*</sup>

<sup>1</sup> Graduate School of Engineering, Utsunomiya University; ishikawa, miyoshi@is.utsunomiya-u.ac.jp

<sup>2</sup> Faculty of Fashion Science, Bunka Gakuen University; yanagida@bunka.ac.jp

<sup>3</sup> School corporation, Monotsukuri University; mitsui@iot.ac.jp

<sup>4</sup> Faculty of Education, Utsunomiya University; sasakika@cc.utsunomiya-u.ac.jp

\* Corresponding author: ishikawa@is.utsunomiya-u.ac.jp

## Abstract

This study aimed to clarify the effect of Japanese and Chinese students' sensation modalities on their evaluation of the textures of beige fabrics. We carried out two experiments—one using both visual and tactile sensations (VTE) and another using only tactile sensations (TE)—to determine participants' evaluations of the textures of 39 types of beige fabrics. Both the TE and VTE results showed significant differences between the Japanese and Chinese groups in the texture evaluation of each fabric material. In particular, the VTE results indicated that the Japanese group could more clearly evaluate the texture of fabric than the Chinese group based on fabric attributes, such as the structure of the fabric and the thickness of its threads. Thus, the results suggest that the difference between the Japanese and Chinese groups' texture evaluation of the fabric was greater when visual information was added to tactile information.

**Keywords:** *Beige fabric, Japanese and Chinese, Sensation modalities, Texture evaluation*

## INTRODUCTION

With the increasing prevalence of Internet technologies, many people now purchase clothes online (Statista 2021). Further, the use of online shopping has increased explosively due to the COVID-19 pandemic (UNCTAD 2021). In online environments, differences between the image of clothing presented on the monitor and the actual clothing regarding impression and texture have become a major problem. To address these issues, it is important to clarify the ways in which humans evaluate fabric textures by considering differences in sensory modalities, such as visual and tactile sensations. With such clarifications, technologies can be developed for photographing and presenting fabrics in a manner that is easy to understand. Previous studies on the texture evaluation of fabrics using sight and touch found that participants' experiences and knowledge related to their environment and culture influenced their evaluations (Behery 2005; Ishikawa et al. 2017). However, few studies have compared the fabric texture assessments of participants with similar education levels but different national backgrounds. Therefore, the purpose of this study was to clarify the influence of Japanese and Chinese students' visual and tactile sensory modalities on their texture evaluation of beige fabrics. We conducted two experiments—one using both visual and tactile sensations (VTE), and the other using only tactile sensation (TE)—to determine participants' texture evaluations of 39 types of beige fabrics. The effects of the participants' sensation modalities were then analyzed based on differences between their texture evaluations of the materials through the use of VTE and TE. Texture evaluations were made by 40 participants using 13 words (in VE) and 14 words (in VTE) measured on a five-point scale. These participants were divided into two groups: 20 Japanese students (JF group) and 20 Chinese students (CF group). Both groups were majoring in fashion design and attended lectures at Bunka Gakuen University to gain experience in constructing garments and a basic knowledge of textiles.



**EXPERIMENT**

As the test stimuli, the 39 fabrics were selected with a focus on materials, woven structures, and thread thicknesses based on the conditions of purchase availability and uniformity of color (beige). These fabrics were composed of seven types of materials (cotton, hemp, fur, silk, nylon, polyester, and cupra), five types of woven and knitted structures (plain weave, oblique weave, satin weave, single, double), and three types of thread thicknesses (fine, medium, and thick). The observers consisted of 20 JF and 20 CF students, making a total of 40 participants. The equipment used for the TE and VTE experiments was the Macbeth Judge II produced by X-Rite. In the TE experiment, a blackout curtain was hung on the equipment to remove visual information, while in the VTE experiment, a standard light source (D65) was used for lighting. The experiment was carried out by randomly presenting the 39 fabrics in three sets of 13 samples. To prevent participants from memorizing the visual impression left by the fabric, the TE experiment was conducted first, followed by a 15-minute break, after which the VTE experiment was conducted. In the TE experiment, 13 words (“thin,” “thick,” “flat,” “rustic,” “crisp,” “soft,” “dry,” “wet,” “stretchy,” “warm,” “cool,” “like,” and “comfortable”) were used. In the VTE experiment, 14 words were used: all the ones above and the additional word “glossy.” These words were presented to each observer in their native language, which were translated by fabric experts in paying attention to the constancy of meaning. We used a five-point evaluation scale that was scored from 0 to 4 (0 = not at all; 1 = slightly; 2 = yes; 3 = quite so; 4 = very much so). The evaluation words were presented in random order.

**RESULTS AND DISCUSSION**

We conducted a factor analysis of the evaluation data from the JF and CF groups together and compared these in the context of the evaluation space in the TE and VTE experiments, respectively, in order to compare evaluation tendencies among the two groups as a whole.

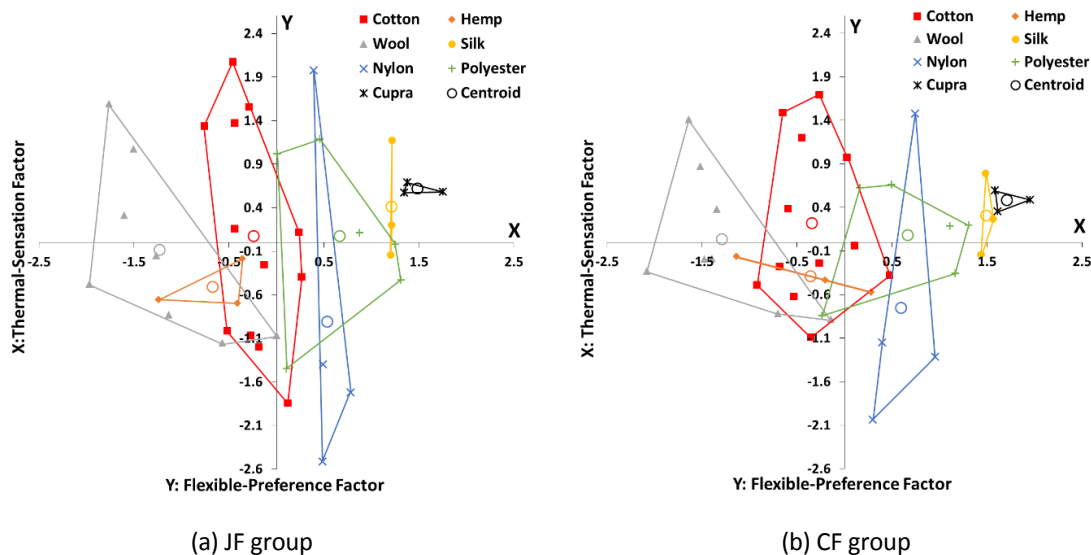

Figure 1: Results of factor analysis for fabric evaluation in TE (fabric texture evaluation space for each material).

The evaluation results of TE were structured by two factors: the thermal-sensation factor consisting of “warm,” “cool,” “flat,” “thin,” “thick,” and “rustic,” and the flexible-preference factor consisting of “like,” “soft,” “comfortable,” “wet,” “stretchy,” “dry,” and “crisp.” In contrast, the results of the VTE

evaluation were structured by three factors of the flexible-preference factor consisting of “soft,” “comfortable,” “like,” “stretchy,” and “rustic”; the thermal-sensation factor consisting of “cool,” “thick,” “warm,” and “thin”; and the surface factor consisting of “flat,” “crisp,” “glossy,” “dry,” and “wet.” Furthermore, the factor scores in the fabric texture evaluation space composed of each factor axis were compared for each textile material. Factor analysis involved the performance of a varimax rotation using the principal factor method, and two or three factors in the case of TE or VTE were extracted by extracting factors with eigenvalues of 1 or more, respectively. Here, we only present the results of the TE experiment (Figure 1). In Figure 1, the 39 types of fabrics are shown in a two-dimensional space consisting of a thermal-sensation factor and a flexible-preference factor (Figure 1a and Figure 1b show the case of the JF and CF groups, respectively). Fabrics of the same material are connected by a line, and the space surrounded by this line is the fabric texture evaluation space for each material. The symbol ○ in the fabric texture evaluation space of each material is the centroid of each material. By comparing the extent of the fabric texture evaluation space for each material in Figures 1a and 1b, we found that the extent of the JF group was greater than that of the CF group on the flexible-preference factor axis for each fabric material (cotton, wool, etc.). The extent of the fabric texture evaluation space for each material was calculated using the distance from the material centroid for each fabric. The magnitude of this distance indicates that the difference in attributes, such as the woven knitting structure and the thickness of the thread in each material, is distinguished and evaluated. In other words, the magnitude indicates the respondents' ability to judge fabric attributes.

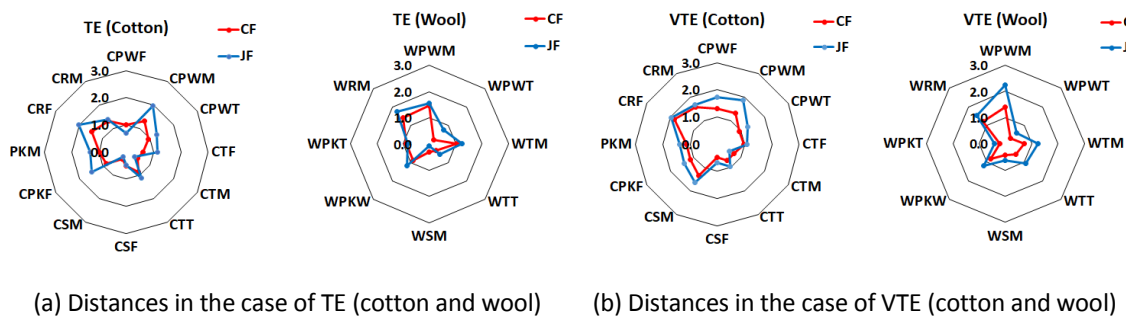

Figure 2: Result of the distances from each fabric to the material centroid for cotton and wool ((a) TE and (b) VTE).

For convenience, in order to compare participants' abilities to judge each fabric attribute in VE and VTE, the distances from each fabric to the material centroid for each material on the two-dimensional space composed of the thermal-sensation factor axis and the flexible-preference factor axis were calculated. The results of the distances of "cotton" and "wool" on TE and VTE are shown in Figure 2a and 2b, respectively. The fabric names in Figure 2 are shown by connecting the capital letters at the beginning of the alphabet in the order of material, structure, and thread thickness. For example, “WPWM” refers to wool, plain weave, and middle. Figure 2 shows that the distances from each fabric to the material centroid of “cotton” and “wool” on TE and VTE are larger in the JF group than in the CF group for many materials. The average distances for each material were calculated and compared (Figure 3). Figure 3 shows that the JF group is significantly higher than the CF group in both TE and VTE for the fabric as a whole. In particular, for each material, the results of VTE showed the same tendency for more materials than TE. Therefore, it was inferred that the JF group had a higher ability to judge the texture of the fabric than the CF group, and VTE exercises provided participants with higher abilities in more fabrics than TE exercises. These results suggest that the difference between Japanese and Chinese observers is greater in the texture evaluation of fabric when visual information is added to tactile information.

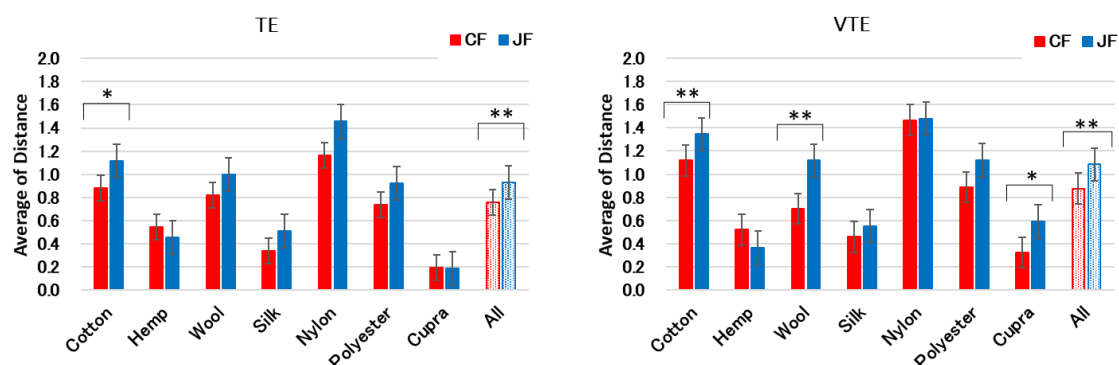

Figure 3: Result of average of distance for each fabric and the total on TE and VTE.

## CONCLUSION

This study clarified the effect of the sensation modalities of Japanese and Chinese students on their texture evaluations of beige fabrics by conducting two types of tactile evaluation experiments (TE and VTE) on 39 types of fabrics with different properties. A factor analysis of the evaluation data indicated that the results of the TE were structured by two factors: the thermal-sensation factor and flexible-preference factor, while those of the VTE were structured by three factors: the flexible-preference factor, the thermal-sensation factor, and the surface factor. In the two-dimensional space composed of the thermal-sensation factor and the flexible-preference factor, the extent of the fabric texture evaluation space for each material in the case of TE and VTE were calculated and compared. As a result, the JF group was significantly higher than the CF group in both TE and VTE for the fabric as a whole. In particular, for each material, VTE showed the same tendency for more materials than TE. Therefore, it was inferred that the JF group had a higher ability to judge the texture of fabrics than the CF group, and the VTE showed this ability for more fabrics than the TE. These results suggest that the difference between Japanese and Chinese observers is larger in the texture evaluation of fabrics when visual information is added to tactile information.

## ACKNOWLEDGEMENTS

This research was supported by Scientific Research Grants and Fundamental Research (B) [Project Number 18H03317]. We would like to express our deep gratitude to these organizations.

## REFERENCES

- Behery, H. M. 2005. Comparison of fabric hand evaluation in different cultures. In: *Effect of Mechanical and Physical Properties on Fabric Hand*, Woodhead Publishing Series in Textiles 2005 5: 124-194.
- Ishikawa, T., J. Tsunetou, M. Yanaka, Y. Yanagida, K. Sasaki, and M. Ayama 2017. Influence of knowledge about clothes and sensation modalities on texture evaluation of beige textile. In: *AIC2017 Being Color with Health, Proceedings of International Colour Association*, Jeju, OS09-6.
- Statista 2021. Retail e-commerce sales worldwide from 2014 to 2024 (in billions), *The portal for statistics*, <https://www.statista.com/statistics/379046/worldwide-retail-e-commerce-sales/>.
- United nations conference on trade and development (UNCTAD) 2021. Estimates of global E-commerce 2019 and preliminary assessment of COVID-19 impact on online retail 2020, *UNCTAD Technical Notes on ICT for Development* 18: 1-10.

# The visual effect of costume woven with peacock feathers and the symbolism in Japanese culture - Evaluation derived from gonio-photometric spectrum analysis and microscopic observation

Yumi Awano <sup>1,\*</sup> and Masayuki Osumi <sup>2</sup>

<sup>1</sup> Tokyo Zokei University; awano@zokei.ac.jp

<sup>2</sup> Office Color Science Co., Ltd.; masayuki-osumi@nifty.com

\* Corresponding author: awano@zokei.ac.jp

## Abstract

There are two types of designs on peacock feather weave costumes. We named the one characterized with the shape of the "eye" as "hilarious *DATE*", the other characterized with the change of optical anisotropy as "austere *DATE*". The "austere *DATE*" style Obi we investigated was designed that brings out the effect of optical anisotropy with an iridescence between high saturation green or dark blue and a copper brown. Among the peacock's allegory, the "eye" on the feather believed to have the versatility to see all in nature and have a mysterious power, and the ecology of fighting with poisonous snakes believed to remove disasters and dispel illnesses. There are cases of "hilarious *DATE*" in Jinbaori or Kabuto that weaved peacock feathers; it could consider a peacock feather weave costume makes enhanced the expectation as a talisman not only for performance that expresses the spirit of *DATE* with eccentricity.

**Keywords:** structural color, optical anisotropy, peacock, symbolism, costume design

## INTRODUCTION: Optical anisotropy arise sense of ethereal ("KIREI")

Woven fabrics characterized by optical anisotropy show changes in shape, lustre and shadow in time and space in response to the environment and act on the sensitivity to make them "beauty (*KIREI*)".

The origin of the Japanese word "*KIREI*" includes preferring to flip-flop as otherworldly graceful, and we speculate it is near as "ethereal" in English. The occurrence of a sense of beauty requires the decorativeness of movement, which is an unexpected change. In addition to the transition of wind and light, it also corresponds to the movement of creatures with bodies that express structural colours. We can find many expressions those using motifs a natural structural colour since ancient times around the world. Biomimicry materials and techniques that applied natural structural colours are utilized in the industrial products to add a sense of luxury and premium. Those facts appear to the evidence of aesthetic empathy existence for the structural colour appearance.

The peacock induces a sense of beauty to the viewer and stimulates the imagination from its ecology and appearance. It has been given symbolism and has become an object of worship. In Japan, peacocks are known, along with the introduction of Buddhism and overseas trade. Some unique textile woven with feathers preserves as a cultural asset. For example, peacock feather designs can be seen in Kabuto (Japanese helmet of a warrior) and Jinbaori, the combat equipment of a Busho (military commanders) of the warring states period in the 16<sup>th</sup> and 17<sup>th</sup> centuries. Jinbaori is a sleeveless campaign jacket worn over the armour to protect himself from the weather. It shows his position and power to his allies and enemies.

We investigated the actual feather and the peacock feather weaved Obi (kimono sash belt) to understand its sensitivity to artificial appearance as described above, unlike peacocks as natural, reported the evaluation obtained from the Gonio photometric spectrum analysis and microscopic observation. This paper will consider the visual effect of changes in brilliance and hue that appear with the posture, gestures, and surrounding light when humans wear the peacock feather weaved costume.

## EXPERIMENT AND RESULTS

### Observation and measurement

We investigated the spectral characteristics of structural colours of peacock feathers by microscopic observation and variable-angle spectroscopic imaging in which the illumination conditions changed from the vertical direction of the sample to three angles of 15 °, 45 °, and 75 °.

The peacock feather has a part that show a high saturation colour and a part that show a brown colour, and the surface condition of each part is slightly different (Figure 1). The profile changed continuously and significantly due to the change in angle, and the peak wavelength also shifted to the short wavelength side as the angle increased. It is a characteristic that accompanies changes in the geometrical conditions of typical structural colours.

We visualized the colour appearance range distribution at each angle calculated for each pixel in the CIELAB space from the spectral reflectance information obtained by spectroscopic imaging measurement (Figure 2). At 15 °, many appearances observed in the negative region where  $a^*$  exceeded -100. It is prevalent and shows that it develops a fairly high-saturation green colour. As the illumination angle from the sample normal direction increases, this high green saturation distribution

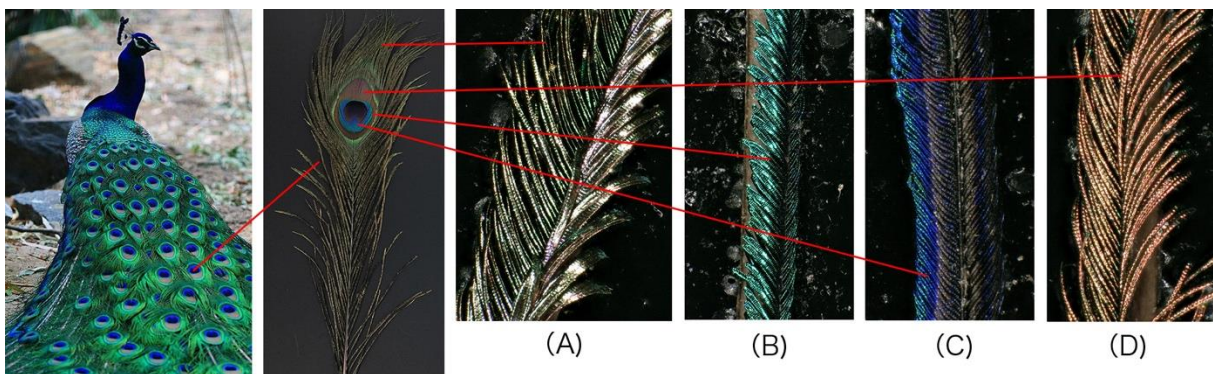

Figure 1: The tail feather of male India peacock, (A) –(D) Enlarged image on each part of different color.

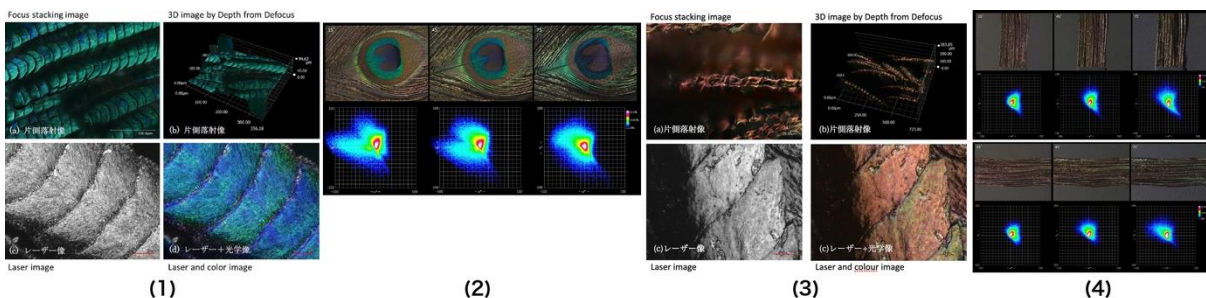

Figure 2: (1) (3) Observation of microstructure with a digital microscope (VHX-5000 manufactured by KEYENCE). Top two points: one-sided epi-illumination image, bottom left: laser image, bottom right: laser + optical image. (2) (4) Distribution map in CIELAB space imaged under the condition of D65 light source 10 ° field of view from the measurement results by the variable angle spectroscopic imaging device (manufactured by Office Color Science). (1) (2) B in Figure (3) (4) multiple juxtaposed D in Figure 1(A).



The visual effect of costume woven with peacock feathers and the symbolism in Japanese culture - Evaluation derived from gonio-photometric spectrum analysis and microscopic observation

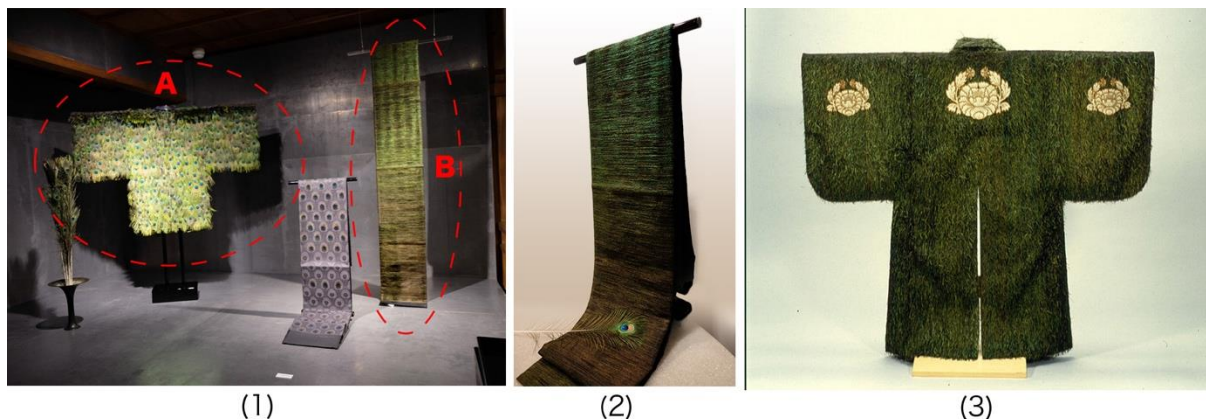

Figure 3: (1) Two types of peacock weave techniques (items surrounded by dotted circles) exhibited at the Obi master, Kondaya Genbey Gallery. Kondaya Genbey owns both. A: Jinbaori made with concentric eccentric circles part. B: Obi made with a peripheral piece of the concentric eccentric part. (2) Other style of exhibition of (1) B at Ippodo Gallery, Ginza. (3) Sendai feudal lord Date Shigemura supplies. (Collection of the Sendai City Museum, Miyagi), The characteristic pattern of concentric eccentric circles of peacock feathers is disappeared, and the surface that appears to hung by implanting feather branches extending on both sides of the wing shaft is rough. The manifestation of structural colours seems mixed.



Figure 4: (1) "Shizugatake war Folding Screen" (Nagahama Castle Historical Museum, Nagahama City). A warrior wearing a peacock Jinbaori guess as Toyotomi Hideyoshi. (2) Peacock Jinbaori that took over at the Harada family in Kaga. (Taiwa History Museum Collection), (3) Brest side of replica of the Peacock Jinbaori that said as Naomasa li received from Ieyasu Tokugawa has taken over at the li family in Shiga, that reproduced by Kondaya Genbey. (Nagahama City Yoita Folk Museum Collection). (4) Same, back side. (5) Unknown (V & A Museum collection).

region gradually shrinks, and conversely, the blue-purple region with a hue angle of around  $300^\circ$  increases. It is consistent with the change as mentioned above in the distribution of spectral reflectance. At any angle, the appearance range extends to a considerably high saturation range, and a wide Gamut is required to cover it, and it presumed that the sRGB area exceeded.

#### Design example: Two types of costume design and weaving techniques used male peacock feathers in Japanese costume culture

Among the artistic expressions in visual arts such as paintings and decorative arts, those draw a full-body image of a peacock, and many cases particularly emphasized as the concentric colour-coded parts

depicted. In other words, there is the fact that this concentric eccentric part has established as a symbol as a peacock.

Some of Kabuto and Jinbaori, the combat equipment of military commanders in the 16-17<sup>th</sup> centuries has produced with the real peacock feathers. Those can classify into two types; weave with the material of concentric eccentric parts and the other is with the peripheral or tip part around the concentric eccentric parts. The former is named "hilarious *DATE*", and the latter is named "austere *DATE*". "Hilarious" is named in light of the ease of appearance and the strength of the impact due to the concentric eccentric circles, which can be said to be a symbol of peacock-ness (figure 3(1)A, figure 4, figure 5). "Austere" was named depend on the complexity of implying the material with the microscopic feature of optical anisotropy that occurs in response to changes in light reception. It has hidden the shape of the "eye" that macroscopic characteristics of the peacock feather (figure 3(1)B, (2), (3)). "*DATE*" in Japanese means dandyism in English. The word "*DATE*" is a genealogy mental concept that has formed in Japan around the 12<sup>th</sup> and 13<sup>th</sup> centuries. The appearance of the peacock as a living thing can classify as "hilarious *DATE*", and the peacock feather weaved Obi we investigated can classify as "austere *DATE*".

The two weave techniques shown in Figure 3 (1) are a typical sample. In Figure 3 (1) A, the tip of the concentric eccentric part of the peacock feathers is woven side by side upside down. There is a part where the branches and feathers overlap slightly in the concentric eccentric part, but the almost concentric eccentric part is exposed. Figure 4 are a weaving technique similar to this. These, which have a stronger impression of shape than iridescence, are classified as "hilarious *DATE*". Though in Figure 4 (3), the lower eyeballs are hidden because the branches and wings at the tips of the concentric eccentric parts are covered, the design is aimed at suddenly appearing eyeballs through the gaps between the bamboo blinds that sway due to the wind and human gestures.

In Figure 3 (1) B, the twigs of the softest part at the tip of the concentric eccentric part are woven as wefts while being layered, so that the surface layer of the weave is short twigs. Though the tactile texture is like soft animal hair, recognize that it is different from villi due to the green to brown iridescence caused by the angle of the spotlight, as can be seen in Figure 3 (1) B and (2). These phenomena can be described in Figure 2(4); the left (irradiation 15 degrees) shows brown, and the right (irradiation 75 degrees) shows green. Since this weaving technique forms the texture of the surface rather than the shape, iridescence plays a significant role in the expression of what we call "austere *DATE*". The Obi is wrapped around the body over the kimono and tied behind to shape it. Among the women's Obi, the standard dimensions of the type (Fukuro-Obi) shown in Figure 3 (1) B are 31 cm in width and 430 cm in length, weave textures, colours, and patterns express the seasons, styles, and messages. It can be inferred that when the Obi shown in Figure 3 (1) B are worn, the intersection of iridescence occurs, as shown in Figure 2 (4). The appearance is sober and subtle, but it shows the deep and luxurious "*KIREI*".

### ***DISCUSSION: symbolism in Japanese culture and visual effects***

On the view of the function, Jinbaori and Kabuto using birds feathers can expect to be effective in the rain and cold weather by taking advantage of the water-repellent and heat-retaining performance of the material on the battlefield. During the Warring States period, a unit with uniform red colours sometimes formed, and it said that Akazonae, which stands out on the battlefield, was feared as an elite unit with great courage. It could be even more noticeable if the general in the Red Army wears a peacock colour. In the "Shizugatake War" folding screen (Figure 3(1)), a warrior wearing a peacock

Jinbaori depicted, but it is uncertain whether it is worn in the actual battle. At least many of the existing costumes and tools are thought to have been customized as rewards for the war results and as performances that express the spirit of "DATE" even in peacetime.

Then consider the relationship between "DATE" spirit and "peacock-ness". The human gaze towards the peacock is ambivalent. A crest is erected on a small head at the tip of an elongated neck covered with bright blue indigo feathers, followed by fluttering branches and feathers every time the body shakes to move. The appearance of long crests that sway with delay reflected in a gorgeous appearance and elegant behaviour. When it leaves the habitat to the west, a myth that is an allegory of femininity remains. In Japan, around 538, a peacock was recognized as Kujaku-Myo-O in Buddhism introduced; the allegory spread before it was known as a real animal through overseas trade or greeting gifts. Its appearance is exceptionally a bodhisattva-shaped female dignity for the Myo-O.

Peacocks have been resistant to small amounts of toxins and often had been witnessed wrestling with venomous snakes that kill people in their habitat. Peacock has been believed that he has the power to turn poison into honeydew from the ecology of attacking and eating snakes that symbolize "hatred", one of the three evils (greed, hatred, foolishness) in Buddhism, and revered as a beneficial bird. From this ecology, the peacock has been become believed to the merit of removing evil, fear, pain and disasters, and extended interpret as dispelling anxiety and illness. It is also a symbol of bringing rain since believed to have the ability to call water.

Another point of ability is the faith with the concentric eccentric part itself. There is much myth that attributes the concentric circles themselves to peacock feathers attribute "eyes" even in distant areas or in beliefs considered less related. Skanda in Hinduism, Mahamayuri in Buddhism (related to Hatomaraten or Kujaku-Myo-O), the peacock depicted as a heavenly vehicle that seems to escort with the eyes those fill the space. Faith with the power of the eye goes connected to wishes for "guardian", "martial luck", and "longevity".

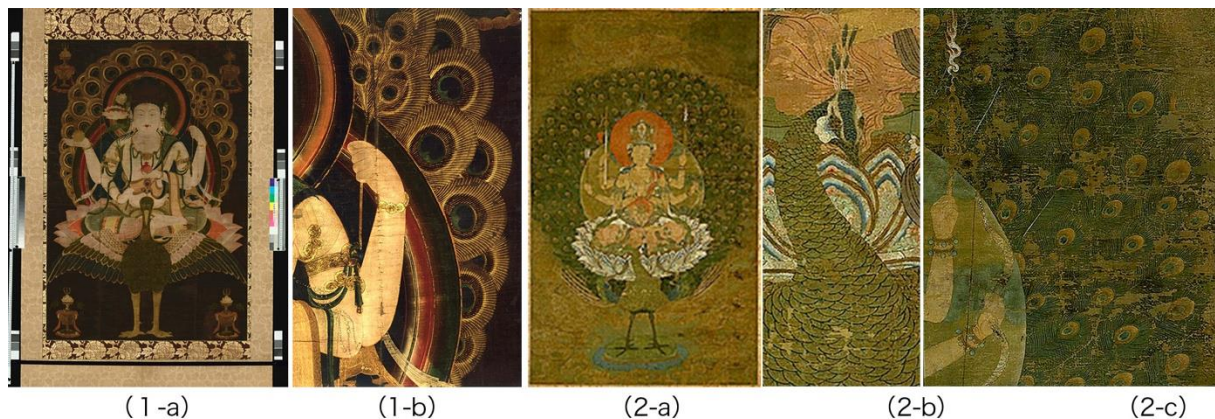

Figure 5:Kujaku-Myo-O (Mahamayuri),color on silk. (1)Tokyo National Museum Collection. (-a )Left:Whole Image. (-b) Right: Expanded image of Aureola. (2)Ninna-ji version ,Kyoto National Museum Collection. (-a )Left:Whole Image.(-b)center: Expanded image of Peacock head. (-c) Expanded image of Aureola.

## CONCLUSION

The allegory of peacock is a concept born due to exaggerating the characteristics of appearance and ecology. The peacock feather, separated from the living peacock and becomes a fibre material, is treated and transformed into the surface layer of an artificial object, becoming a " peacock-ness ". The " peacock-ness " is transformed by design.



In this paper, we tried to classify the two types of "DATE" concept as "hilarious" and "Austere" based on whether or not the concentric eccentric circles are characterized, mainly for the peacock feather weave Obi manufactured by Kondaya Genbey, and Jinbaori. The shape of the concentric eccentric circles feels "eye" similarity. It causes a stronger impression than several colour changes appear and feel "KIREI". About "hilarious DATE", the motive for the repeated production of this design is the enhancement of the ability to bounce off the evil eye from the enemy with the amount of "eyes" by giving the illusion of "stare", and these relentless shape would dominate the heart of the other person. Jinbaori has an area sufficient to determine the impression of the entire costume, is close to the face, and is an item that responds to the large movements of the upper body. Designs in which the bamboo blind (figure 4(3)) make the appearance of "eyes" random, and long barbs shake randomly, and there is a dynamism in which unexpected movements break the balance of the situation with iridescence in an unexpected moment. The warriors of the Warring States period, who were always prepared to stand on the edge of the blade, have the spirit of betting their power on a wacky design to inspire themselves with the blessing of unprecedented power and wear the power to break through difficulties. This design would be required to extract the unrealistic divinity, even though they know that the peacock is also a living thing and will eventually die. We observed the artificial "peacock", which created the appearance and texture with disassembled and reconstructed the parts of the peacock feather. Those are a discovery of "KIREI" ever not exist in the natural state of the creature, and our considering about the optical anisotropy influence to "peacock-ness" made a conceptual relation with "DATE". We conclude that the classification of "hilarious" and "austere" on costume design with peacock feather was valid and confirmed that it is necessary to consider the in-between concept. The "austere" was mentioned based on observation, measurement, and analysis of the sample assuming the Obi that manufactured by Kondaya Genbey (Figure 3.(1)B), but it presumed that the weaving technique is different for the bamboo blind (Figure 4(3)). Regarding this, it is necessary to prepare a sample and observe it microscopically and macroscopically.

### **ACKNOWLEDGEMENTS**

We appreciate Kondaya Genbey and Ippodo gallery for shown the wonderful innovative Obi and weaving technique, spirit.

### **REFERENCES**

- Awano, Y., and M. Osumi. 2021. Consideration on the symbolism and visual influence on costume design with natural constructional color. In: *The Color Science Association of Japan, Proceedings of 52th annual meeting 2021*, Vol.45 No.3.
- Awano, Y., and Osumi M.2020.Gonio-photometric spectrum analysis and texture evaluation of structural color design —Considerations on "Peacock feather weave" by Kondaya-Genbey, In: *AIC2020, Proceedings of the Midterm Meeting of the International Colour Association*.
- Dakin, R., and R. Montgomerie. 2013. Eye for an eyespot-how iridescent plumage ocelli influence peacock mating success, *Behavioral Ecology*, 2013, 24(5), 1048-1057.
- Medina, J.M., J. A. Díaz, and P. Vukusic. 2015. Classification of peacock feather reflectance using principal component analysis similarity factors from multispectral imaging data. *OPTICS EXPRESS* 10212, 2015, Vol. 23, No.8.
- Osumi, M., and Y. Awano. 2021. Consideration on the spectral characteristics and texture of peacock feathers, In: *The Color Science Association of Japan, Proceedings of CSAJ-sigCI meeting,2020,19-24*.

# A study on associative color attributes of Antonyms in Korean language

Eunji Han<sup>1</sup> and Yungkyung Park<sup>2,\*</sup>

<sup>1</sup> Ewha Womans University; hej\_102@naver.com

<sup>2</sup> Ewha Womans University; yungkyung.park@ewha.ac.kr

\* Corresponding author: yungkyung.park@ewha.ac.kr

## Abstract

Confrontation means that opinions, situations or characteristics are in opposition or contradiction. It also implies a situation of mutual opposition. The conflicting characteristics of meaning are deeply and widely spread in life and everyday life as well as human way of thinking. In this study, 50 pairs of vocabulary considered to be cognitive antagonistic in Korean language were experimented to freely select colors associated with 20 participants participating in the digital color matching experiment. As a result, the antonyms showed differences in color association. However, the color characteristics of each vocabulary varied, indicating differences in accuracy in the three attributes of color. Through this study, it can be seen that there is a difference in colors that people associate with the opposite vocabulary. Their characteristics are very complex and diverse, each resulting in the conclusion that it is inconsistent with the linguistic (national) difference. These results suggest that color associations do not show a consistent form, which should be recognized as a complex element of various characteristics of language and color.

**Keywords:** *antonym, confrontational association, color confrontation, color association*

## INTRODUCTION

Human understanding is the act of grasping the meaning of symbols such as language, and further identifying all perceptions, intuition, expressions, and phenomena and causes that make up ideas. In particular, an understanding of confrontation should be considered important for the understanding of the current era, which is sensitive or insensitive to incompatibility, differences, confrontations, and social differences. Therefore, this study aims to understand human confrontational values and to examine the nature of color associations by paying attention to the color association of the alternative language in Korean.

Color is considered to play an important role in the perception and cognition of various objects. According to Herring (1978)'s Opponent-process theory, the human sense of color is the synthesis of black-white, red-green, and yellow-blue opposing pairs of elements. Red and green, yellow and blue are incompatible symmetrical positions, for example, which is why we cannot recognize red-green, blue-yellow. It is easy to find cases in which we focus on color differences in conveying the meaning of alternatives in the nature and environment in which we live. This is often the case in which the concept of danger is conveyed as 'red', the concept of safety as 'green', or the concept of death as 'black' and the concept of birth as 'white'.

The transmission of meaning through color should be based on the correlation between color and language. Through this study, the purpose of the study was to increase the efficiency of color planning in the social delivery of alleles among various value transfer, and to increase the clarity of the actual color association and color recognition process.

## EXPERIMENT

The experiment on color association was conducted on women in their 20s and 40s who are considered to have a good sense of basic color recognition and characteristics. The experiment consisted of 50

words and 50 alternative words, a color selection experiment that selects associated colors for a total of 100 words. The 100 words were extracted based on the experimental results of a previous study by Lim Ji-ryong (1988), which revealed the cognitive semantic characteristics of the opposing word action pattern. In order to select a vocabulary with a relatively high degree of opposition, we selected the top 50 pairs from the vocabulary with the maximum conversion value of 1 as the conceptual vocabulary for this experiment.

The pairs of opposing concepts selected for the experiment are as follows.

married/unmarried(1.00), male/female(1.00), live/die(1.00), start/end(0.98), true/false(0.98), correct/incorrect(0.97), buy/sell(0.97), reward/punishment(0.97), groom/bride(0.95), sky/ground(0.93), go/come(0.93), mother/father(0.93), give/take(0.93), legal/ illegal(0.93), animal/plants(0.92), right/wrong(0.92), up/down(0.92), direct/indirect(0.92), boy/girl(0.90), maiden/bachelor(0.9), attack/defend(0.88), son/daughter(0.88), increase/decrease(0.88), expand/reduce(0.88), hot/cold(0.88), dress/undress(0.87), honest/ dishonest(0.87), singular/several(0.85), rich/poor(0.85), success/failure(0.85), sit/stand(0.85), young/old (0.85), big/small(0.85), madam/mister (0.85), fast/slow (0.83), inlandnd/seaside (0.83), war/peace (0.83), good/bad (0.83), clean/dirty (0.82), dry/wet (0.82), plenty/few(0.82), put on/take off(0.82), difficult/easy (0.82), win/lose (0.82), mountain/sea (0.82), strong/weak (0.80), black/white (0.80). active/passive (0.80), bright/dark(0.80), salty/ bland(0.80).

Using a digital color tool, 20 subjects converted each subject's associated colors into R, G, B, and values, respectively, and converted the converted R, G, and B values back to L\*a\*b\*C values, which resulted in  $\Delta L^*$ ,  $\Delta a^*$ ,  $\Delta b^*$ , and  $\Delta C^*$  values. The resulting delta values allowed various analyses and comparative analyses through  $\Delta a^*b^*$ ,  $\Delta L^*C^*$ ,  $\Delta L^*a^*b^*C$  graphs, and the L\*, a\*, b\*, and C\* values were converted to equal scales(convert by equally scaling to a minimum of 0, and a maximum of 1) to equal lines for comparison of brightness - chromaticity - hue.

## RESULTS

Among the 50 pairs of antonyms, the pair with the greatest difference in color brightness of their association is black/white(0.93), the second is bright/dark(0.80), and the third is live/dead (0.67). The pair with the lowest variation between subjects was black/white and boy/girl, former considered the  $\Delta L^*$  relatively high (0.93), and the latter perceived  $\Delta L^*$  relatively low (0.07). The pair with the greatest difference in color chromaticness of their association is salty/bland(0.51), the second is prize/punishment(0.49), and the third is hot/cold(0.43). The pair with the lowest variation between subjects was black/white and inland/seaside, considered the  $\Delta C^*$  relatively perceived as low (0.05),(0.1). The pair with the greatest difference in redness – greenness of their association are attack/defend(0.45), and correct/wrong(0.45), second is legal/illegal(0.42). The pair with the greatest difference in yellowness – blueness of their association is hot/cold(0.46), the second is prize/punishment(0.37), and the third is increase/decrease (0.37).

Notion A	A-opposites	$\Delta L^*$	$\Delta C^*$	$\Delta a^*$	$\Delta b^*$
married	unmarried	0.32	0.20	0.07	0.12
male	female	0.22	0.21	0.24	0.29
live	die	0.67	0.30	0.16	0.12
start	end	0.43	0.20	0.24	0.09

true	false	0.45	0.22	0.33	0.19
correct	incorrect	0.28	0.38	0.45	0.23
buy	Sell	0.16	0.36	0.11	0.32
reward	punishment	0.47	0.49	0.27	0.37
groom	bride	0.31	0.10	0.17	0.13
sky	ground	0.23	0.18	0.14	0.28
go	come	0.18	0.22	0.21	0.16
mother	father	0.14	0.27	0.33	0.24
give	take	0.22	0.17	0.17	0.15
legal	illegal	0.36	0.31	0.42	0.15
animal	plants	0.16	0.21	0.37	0.10
right	wrong	0.35	0.21	0.31	0.19
up	down	0.49	0.17	0.06	0.17
direct	indirect	0.16	0.35	0.13	0.23
boy	girl	0.07	0.12	0.25	0.13
maiden	bachelor	0.25	0.25	0.21	0.35
attack	defend	0.14	0.38	0.45	0.24
son	daughter	0.15	0.18	0.23	0.26
increase	decrease	0.22	0.39	0.28	0.37
expand	reduce	0.32	0.38	0.16	0.30
hot	cold	0.21	0.43	0.36	0.46
dress	undress	0.10	0.35	0.25	0.17
honest	dishonest	0.46	0.36	0.25	0.25
singular	several	0.37	0.20	0.11	0.17
rich	poor	0.36	0.34	0.07	0.28
success	failure	0.39	0.43	0.18	0.35
sit	stand	0.17	0.17	0.10	0.21
young	old	0.49	0.22	0.24	0.22
big	small	0.35	0.27	0.10	0.17
madam	mister	0.20	0.28	0.21	0.11
fast	slow	0.39	0.31	0.36	0.17
inland	seaside	0.24	0.10	0.11	0.35
war	peace	0.48	0.34	0.34	0.22
good	bad	0.42	0.26	0.20	0.15
clean	dirty	0.54	0.15	0.06	0.12
dry	wet	0.34	0.08	0.08	0.18
plenty	few	0.52	0.29	0.12	0.13
put on	take off	0.15	0.19	0.17	0.15
difficult	easy	0.54	0.23	0.19	0.15
win	lose	0.38	0.41	0.25	0.29
mountain	sea	0.20	0.22	0.24	0.36
strong	weak	0.54	0.36	0.29	0.21
black	white	0.93	0.05	0.02	0.02
active	passive	0.18	0.36	0.28	0.36
bright	dark	0.80	0.37	0.05	0.29
salty	bland	0.39	0.51	0.26	0.19

Table 1:  $\Delta L^*a^*b^*C^*$  converted average value.

Among the 50 pairs of antonyms, the top ranking with relatively high values of  $\Delta L^* - \Delta C^*$  is live/die, young/old, clean/dirty, difficult/easy, black/white', and bright/dark. Also the pair of relatively high  $\Delta C^* - \Delta L^*$  values is attack/defensive.

## **CONCLUSION**

This study is based on basic experiments on color association. As a result, we also present general characteristics of association and cognitive characteristics of the antonyms. This is based on the premise that the association of color with the concept will interact with the association of the concept itself, and purpose of this study is to analyze these correlations according to the properties of color. Considering this reciprocity, vocabulary that is considered to have a great degree of confrontation in Korean was selected as subjects of the experiment.

Studies have shown that the degree of confrontation according to color properties is shown, and it differs according to the characteristics of each concept rather than consistent. These results indicate that color associations do not exhibit a consistent form, which should be recognized as a complex element of linguistic characteristics and various characteristics of color. Also, depending on the color characteristics, the color association of the antonyms is thought to be closer to the stratigraphic confrontation, which is differentiated by the degree of difference in characteristics rather than the presence or absence of confrontation.

## **REFERENCES**

- Lim, J. R. 2015. Cognitive Semantic Properties of the Working of Opposites. *Journal of the Korean Language Society* 40: 65-100.
- Lim, J. R. 2015. Working Aspects of Opposites in the Mental Lexicon. *The Korean Language Society* 307: 171-207
- Joo, M.K.2007. Research for the Features of Color Association. *Journal of Korea Society of Color Studies* 21(2): 19-29
- Choi, W. J. 2015. A Study on Focal Colors and Color Names as a Factor Forming Memory Colors.
- Hong, J. I. 2012. A study on the color cognitive system: focused on the characteristic of the linguistic representation.

# Colour and ornament in the Polish Art Deco style.

## Karol Homolacs and his colour course at the Cracow Workshops 1913-1926

Agata Kwiatkowska-Lubańska<sup>1,\*</sup>

<sup>1</sup> Jan Matejko Academy of Fine Arts in Cracow, akwiatkowska@asp.krakow.pl

\* Corresponding author: akwiatkowska@asp.krakow.pl

### Abstract

The aim of this paper is to analyse the theory and practice of colour of the Polish painter and designer Karol Homolacs. He was the creator of the original programme of education in colour and ornamentation at the courses held at the Technical and Industrial Museum in Krakow from 1913 to 1926. Homolacs was the author of books on colour and based his colour theories on the research of Wilhelm Ostwald. The Polish artist developed his theory of colour harmony, combining it with the principles of ornament construction. The aim of this article is to present the theoretical assumptions of Karol Homolacs and their practical applications in designing batik fabrics, kilims, wooden toys and parchment paper decorated with the batik method. As only natural dyes were used in the dyeing of fabrics in the Cracow workshops, colour combinations were shown on examples of colours obtained from popular dyeing plants. Since the book by Karol Homolacs "Construction of Ornament and Harmony of Colours" (1930) was published in black and white, the result was an attempt to reproduce different types of colour combinations in the examples of ornaments described in the textbook. In the analysis of colour combinations, Polish decorative textiles created by artists and students of the Cracow Workshops, found in the collections of the Ethnographic Museum and the National Museum, as well as in the Museum of the Academy of Fine Arts in Cracow, were used.

**Keywords:** *colour systems, colour harmony, Cracow Workshops, colour education*

### INTRODUCTION

Warsztaty Krakowskie (Cracow Workshops) was an association active in Krakow between 1913 and 1926, created by young enthusiasts of the Arts and Crafts movement – painters, architects and designers from Krakow. As a result of their activities a Polish variant of the Art Deco style was formed, which was most spectacularly presented at the Exposition Internationale des Arts Décoratifs et Industriels Modernes in Paris (1925), when the Polish exhibition received the largest number of awards of all the foreign pavilions. The exhibition was also a kind of summary of the 13-year activity of the Workshops, which were dissolved in 1926. The activity of the Cracow Workshops was modelled on such associations as Wiener Werkstätte, Deutsche Werkstätte and Deutscher Werkbund, and assumed a cooperation of artists and designers with craftsmen in order to produce products which would be both well designed and perfectly made. The aim of the members of the Cracow workshop was to design interiors for public use, state institutions and flats in a new style. They also strove to give interiors a national feel, which was understandable in light of the efforts of Poles to regain their own statehood after 123 years of foreign rule. The Cracow Workshops operated the following workshops: furniture, metal, bookbinding, weaving, batik, dyeing and toy workshops. The Association organised lectures and systematic courses in various fields of design. Karol Homolacs (1874-1962) was a painter, graphic artist, theoretician of colour and ornament. He studied in Lvov, Paris and Vienna, designed furniture, metal objects, covers and illustrations as well as polychromes. He played an important role in the establishment and activity of the Cracow Workshops Association – he was a member of its authorities, participated in organisational and artistic work, as an expert in the field of colour theory and methodology of artistic teaching. He also taught colour theory and

practice at the Municipal School of the Artistic Industry in Krakow. For his method of teaching ornamentation for the art-industrial school, he received a special prize at the Paris exhibition in 1925. Boguszewska (2013: 89) He included his colour theories in his books: "Construction of Ornament and Harmony of Colours", "Study of Form, Colour and Light", "Handbook for Decorative Exercises", "Painter's Colouring". He was the first Polish author who dedicated his colour theories not to painting but to applied arts. In his books he searched for various ways of building colour harmony, and a particular field of their application was ornament - closely related to the material and technology. Homolacs, to a large extent, was inspired by Ostwald's system, but unlike the German colour theorist, he recognised that the indispensable way of assessing colour harmony was through artistic intuition and not through the exact implementation of a set recipe. "Whether a given harmony is pretty or not is decided solely by feeling. Theoretical analysis can instruct us on which way to seek to enrich, calm or enliven a given harmony.": Homolacs (1930: 234) Such a view was very close to the position of Johannes Itten, expressed in his book "The Elements of Color": "Learning from books and teachers is like travelling by carriage, so we are told in the Veda. But the carriage will serve only while one is on the highroad. He who reaches the end of the highroad will leave the carriage and walk afoot.": Itten (1970: 7).

### COLOUR ORDER IN HOMOLACS' THEORY

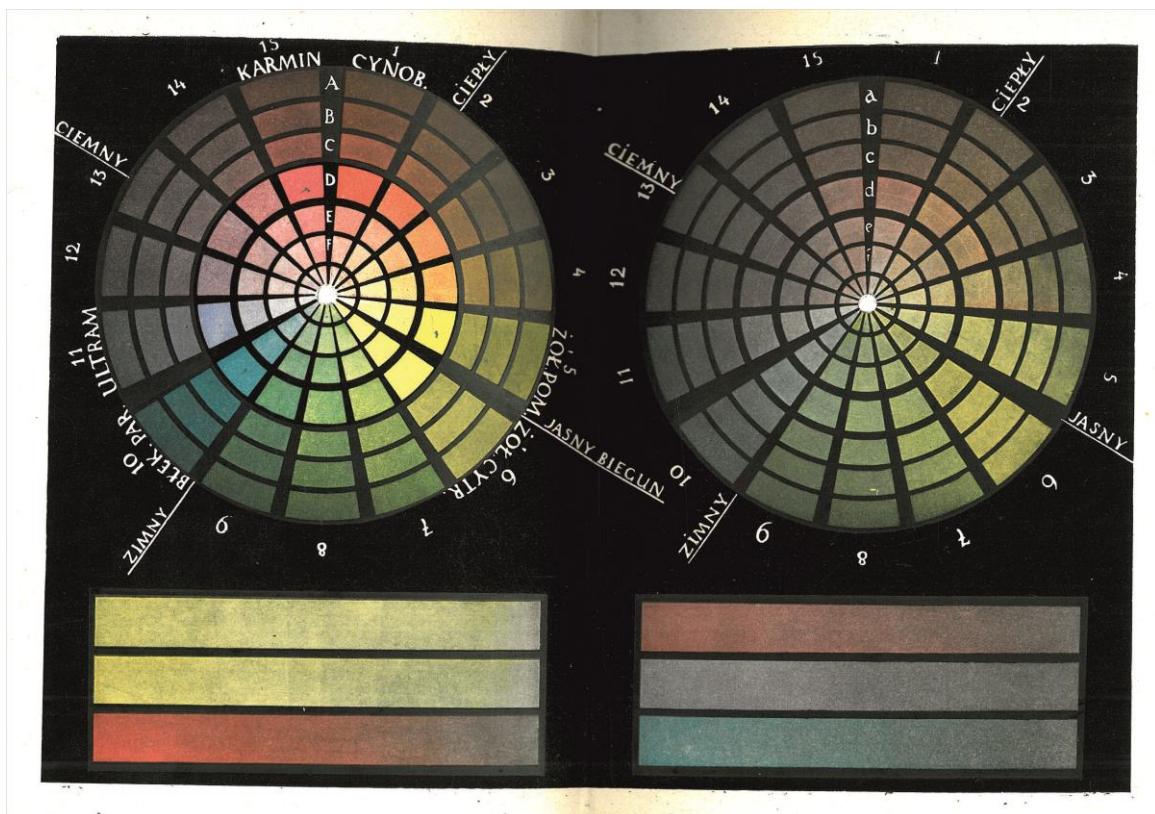

Figure 1: Colour wheel, basic axes: cold - warm, light - dark.

Homolacs believed that the first stage necessary for the understanding of colour was the ordering of colours, the separation of groups and the establishment of relationships between individual colours. To accomplish this, he built his colour system based on a cylindrical form. The basis of the order is the rainbow colour wheel. Homolacs emphasises that his point of reference are artistic paints, so in his classification he uses two types of colours: ideal colours and material colours, which

are the equivalents of the oil paint colours commonly used in the 1920s. There are three primary colours: red, yellow and blue, but their place in the colour wheel is empty due to the lack of paints that perfectly match them. The ideal yellow colour is created by mixing citric cadmium with orange cadmium. The perfect red colour is between kraplac and cinnabar, and the perfect blue colour is between Paris blue and ultramarine. In the wheel, 15 colours are distinguished and 2 axes are defined: warm – cold and light – dark (see Figure 1). The light pole is represented by yellow, which starts symmetrically with two rows of progressively darker colours until it reaches the darkest violet. In this way, pairs of colours of the same brightness can be determined. The warm-cold axis allows us to determine pairs of colours of similar temperature. After the group of rainbow colours, Homolacs distinguishes the group of pure colours. In his view, pure colours are rainbow colours to which black or white has been added. The author believes that only the simultaneous addition of black and white (greys) makes a colour broken (dirty). The group of pure colours is depicted by extending the circle of rainbow colours: inwards - towards white, and outwards - towards black. The warm-cold and dark-light axes are retained.

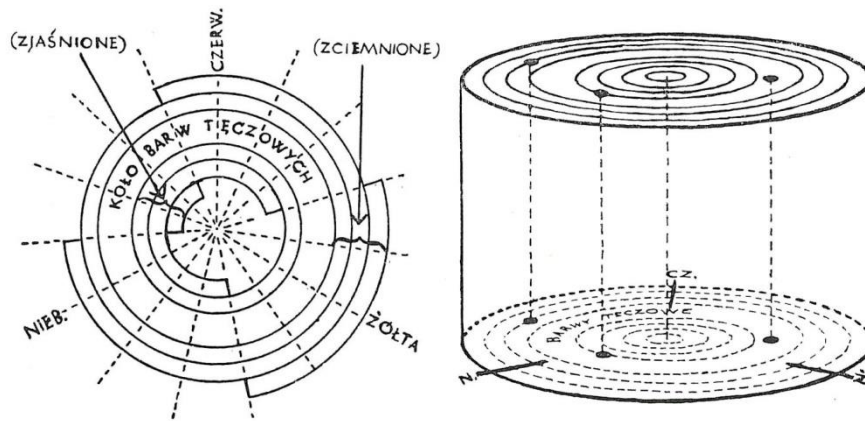

Figure 2: Karol Homolacs' system of colours - the circle of pure colours, the solid of broken colours.

Another group distinguished by Homolacs is the group of broken colours. Each pure colour (rainbow, whitened or blackened) can be broken by adding to it a grey tone of the same brightness as the colour in question. In this way a cylinder is formed, inside which are colour scales of decreasing saturation (see Figure 2). The upper surface of the cylinder is made up of grey tones of the same brightness as the pure colour scale. The central axis of the cylinder is white, and its outer surface is black. The cross sections are complementary colour scales.

### **COLOUR HARMONY**

Colour harmony is about combining contrasting values in such a way that their effect is pleasing to the eye. Homolacs likes to contrast colour tone while maintaining similar brightness and colour saturation. This is, in his opinion, particularly suitable for ornamental colour. Within the group of rainbow colours, Homolacs suggests that pairs of colours of equal brightness, symmetrically located with respect to the light-dark axis, are particularly harmonious. He considers cinnabar and green - a favourite combination in folk art – to be a particular example of such a combination. Another suggested combination are colours which complement each other or are 1/3 of the circumference of the circle (yellow - red, red - blue, blue - yellow). The principle of dominance is of great importance in colour design. According to Homolacs, in objects such as textiles or carpets, the viewer should be



able to easily determine whether an object is green or red. This is helped by the principle of dominant. The more distant the two colours are from each other, the more one of them should dominate quantitatively. If we put green and orange-yellow together, the dominant colour is the yellow contained in both colours. Harmonious combinations are also created by the triads of rainbow colours. In this case the most distinctive is the basic triad of red, yellow and blue. Close triads are also used, when three colours lie at an equal distance next to each other, on one side of the colour wheel. Homolacs stresses that in the case of an ornament, three rainbow colours are the optimum amount and adding more colours is not advisable. In the case of pure colours, similar types of colour combinations are recommended, but Homolacs advises against combining whitened colours with blackened ones. On the other hand, combining rainbow colours with blackened ones often gives very good results – for example, the combination of a saturated ultramarine with a blackened orange (brown) characteristic of Middle Eastern handicrafts. In combinations of broken colours, Homolacs recommends the use of colours of similar saturation or the use of series of colours of equal blackness or whiteness. To achieve this, he draws different types of lines along which harmonious colour scales are placed inside the cylinder's surface. He emphasises that harmony arises from a definite series of colours whose characteristics change in a regular manner. "Every noble and properly balanced ensemble has a certain fundamental tone, which can be expressed most often by a single dominant colour (blue, red, etc. or at least by the term 'warm' or 'cold')" Homolacs (1930: 268).

### **ORNAMENT DESIGN**

When choosing the colours of the ornament, the colour scheme should be matched to the form of the ornament. The important ornamental patches should also stand out in colour, but the most important factor is the relationship between the background colour and the colours of the ornament. Here Homolacs introduces the following possibilities:

- Background contrasted with ornament in terms of brightness (all elements of ornament darker or lighter than background). Ornament similar to background in terms of saturation and temperature.
- Background contrasted with ornament in terms of brightness and saturation (ornament always more saturated than background).
- Background contrasting to ornament in terms of colour, but similar in terms of brightness and saturation
- Background contrasting to ornament in colour and saturation (less saturated), but similar in brightness
- Background contrasting to ornament in colour, but similar in brightness and saturation

The above-mentioned relations between background colours and ornament are considered by Homolacs to be the most favourable, not excluding the fact that an experienced designer is able to achieve an impression of harmony by ignoring certain limitations. However, for teaching purposes, the author developed a number of ornament design exercises that allowed students to make conscious use of the relationships between colours so as to adapt the elements of decoration well to the shape of the object, its material and its function. These exercises are described in the book "Handbook for ornament exercises".

### **PUTTING THEORY INTO PRACTICE**

A number of principles formulated by Karol Homolacs concerning the construction of ornament and harmony of colours strongly influenced the work of artists who were members of the Cracow Workshop Association. Homolacs proposed analysing the structure of an ornament, understanding and consciously using it. He emphasised the independence of ornament from forms existing in nature. Also, in the field of colour he stressed the understanding and systematics of colours, on the basis of which he proposed the rules of building colour combinations. These combinations were closely related to the form and function of the object and the technology of its manufacture. Experiments in the field of plant dyes played an important role in designing colours, especially for kilims and batiked fabrics and wooden objects. Thanks to them a wealth of natural colours was achieved: ochre, burnt sienna, indigo blue, yellow, orange and red. Bronze was often combined with blue, yellow with pink or indigo with white. Excellent examples of the colour palette of the Cracow Workshops Association are the woollen kilims by Wojciech Jastrzębowski, Kazimierz Młodziankowski, Józef Czajkowski and the batik fabrics by Norbert Okołowicz, sisters Maria, Józefa and Zofia Kogut (see Figure 3) and Wojciech Jastrzębowski. Dziedzic et al. (2014: 108-111) Unfortunately, the fabrics designed by Karol Homolacs have not survived.



Figure 3: Zofia Kogut - batiked silk, shawl (belt) made in the Cracow Workshops in 1920.

### **CONCLUSIONS**

Karol Homolacs was a Polish colour theoretician and practitioner, combining design work with colour didactic activity. The principles he formulated concerning the harmony of colours in applied arts contributed to the creation of the Polish variant of Art Deco style, which was applied, among others, in interior design. The colour system created by Karol Homolacs, despite clear influence of Wilhelm Ostwald's system, has many original features which make it possible to use it in colour education. The assumptions concerning the harmony of colours in ornamental design and the exercises proposed in this field constitute an important, although little-known contribution to colour theory.

### **REFERENCES**

- Boguszewska, A. 2013. Kształcenie w zakresie grafiki w szkolnictwie artystycznym Krakowa, Lwowa i Wilna w latach międzywojennych. *Biuletyn Historii Wychowania*
- Dziedzic M., I. Huml, A. Myczkowska, A. Pleciak and Szwaja. 2014. *Warsztaty Krakowskie 1913-1926*: Kraków: Wydawnictwo Akademii Sztuk Pięknych im. Jana Matejki w Krakowie.
- Dziedzic M. 2020. Stowarzyszenie Warsztaty Krakowskie. *Formy 5*
- Homolacs, K. 1930. *Budowa ornamentu i harmonia barw*. Kraków: Miejskie Muzeum Przemysłowe.
- Homolacs, K. 1930. *Podręcznik do ćwiczeń zdobniczych*. Kraków: Miejskie Muzeum Przemysłowe.
- Homolacs, K. 1960. *Kolorystyka malarska*. Warszawa: Wydawnictwo Arkady.
- Huml, I. 1978. *Polska sztuka stosowana XX w.* Warszawa: Wydawnictwo Artystyczne i Filmowe.
- Itten, J. 1970. *The Elements of Color*. New York: Van Nostrand Reinhold Company.



# The evolution of environmental colour design in the French period

Verena M. Schindler <sup>1,3,\*</sup> and Yulia A. Griber <sup>2,3</sup>

<sup>1</sup> Art and Architectural Historian, Zollikon, Switzerland; ecd.studygroup@yahoo.com

<sup>2</sup> Smolensk State University, Smolensk, Russia; y.griber@gmail.com

<sup>3</sup> Co-Chair of the AIC Study Group on Environmental Colour Design

\* Corresponding author: ecd.studygroup@yahoo.com

## Abstract

This paper describes the third (and final) part of an analysis of the results of an on-going research project concerning the French period of environmental colour design. In May 2019, a qualitative oral history approach was used to conduct a series of semi-structured interviews in French with six colour consultants presently living in Paris: Michel Albert-Vanel, Yves Charnay, Victor Chérubin Grillo, Bernard Lassus, André Lemonnier, and Jean-Philippe Lenclos. Applying an inductive approach and implementing a thematic analysis for the interpretation and representation of the interview data revealed answers to the question “*Comment voyez-vous l'évolution de la couleur dans l'environnement?*” or, in English, “How do you see the evolution of colour in the environment?” The answers of the six colour designers carefully analyzed in the French context since the 1950s contribute to a better understanding of key aspects of the evolution of environmental colour design.

**Keywords:** *environmental colour design, colour design, semi-structured interviews, qualitative oral history approach, French context*

## INTRODUCTION

Analyzing history, current developments, and the possible future of colour in architecture and environmental design, one cannot help but notice that the specificity of knowledge about colour in environmental design in the 1950s and 1960s sparked the birth of a new profession: the colour consultant (see, e.g., Prieto 1995; Caivano 2006). In collaboration with architects, designers, engineers, town planners, and industrialists, and other professionals, colour consultants have worked in France as colour theorists and researchers addressing in their influential projects several topics such as: colour for new buildings, historical city centres, industrial architecture, and local or regional urban landscapes. Their theoretical insights and practical approach to colour have not only shaped the city, but also significantly influenced colour research, colour education, and the approach to colour in the built environment.

We conducted a series of interviews with the representatives of the first generations of French colour designers presently living in Paris to study this important French period as a holistic artistic phenomenon to better understand the ideas of the French colour consultants and to trace their influence on the traditions of contemporary environmental colour design. The idea behind this project was that these renowned French colour consultants embody unique experience and knowledge, whose value will increase over time. If this heritage is not collected and analyzed now, much will be lost forever.

The first results of this ongoing research project concerning the French period of environmental colour design were presented in 2019 at the First Russian Congress on Colour (Griber et al. 2019) and the AIC 2019 Midterm Meeting (Schindler et al. 2019). In 2020, we continued the analysis and presented the philosophy of colour in the French period of environmental colour design at the International Conference of the Color Society of Russia (Schindler and Griber 2021). This paper describes the third (and final) part of our study.

## **METHOD**

To explore subjective viewpoints (Flick 2009) and gather in-depth accounts of the experiences of persons who have contributed to the history of environmental colour design, a qualitative oral history approach was used in a series of semi-structured interviews.

Selected on the basis of the nature and design of the study, the aims and research questions, and the relevance to the theory of environmental colour design, six colour consultants were asked to participate in the study:

- Colour designer, inventor of the Planetary Colour System *Michel Albert-Vanel* (b. 1935);
- Visual artist, painter, creator of a patented colour-light device, and designer of light installations *Yves Charnay* (b. 1942);
- Visual artist, colour designer for architecture and industry *Victor Chérubin Grillo* (b. 1944);
- Landscape architect and visual artist *Bernard Lassus* (b. 1929);
- Painter, visual artist, colour researcher, inventor of patented colour tools and atlas, and colour designer for architecture and industry *André Lemonnier* (b. 1937);
- Colour designer, visual artist, colour researcher, and creator of the concept 'The Geography of Colour' *Jean-Philippe Lenclos* (b. 1938).

Our interviewees are Professors Emeritus at the École nationale supérieure des Arts Décoratifs (Michel Albert-Vanel, Jean-Philippe Lenclos, and Yves Charnay) and the École nationale supérieure d'Arts de Paris-Cergy (Victor Chérubin Grillo). Bernard Lassus taught at several different universities in Versailles, Paris, Pennsylvania, Cambridge UK, and Bologna.

All interviews took place in May 2019 in Paris at the homes or studios of the interviewees. They were conducted in French and videorecorded.

The topic guidelines for the interviews included five groups of exploratory, open-ended questions about spiritual, philosophical, and intellectual influences on their design projects and sources of their inspiration; people they considered their teachers and successors; and, their way of practicing colour.

This paper discusses findings related to one of our most important interview questions: "*Comment voyez-vous l'évolution de la couleur dans l'environnement?*" or, in English, "How do you see the evolution of colour in the environment?"

## **RESULTS**

After the videotaped interviews were transcribed, edited, and translated from French into English, we applied an inductive approach and implemented a "thematic analysis" (see, e.g., Evans 2017) for the interpretation and representation of the data collected.

As expected, relatively unstructured interviews allowed the interviewees enough space to answer on their own terms.

Landscape architect and visual artist *Bernard Lassus* asserts that the role of colour has changed since the 1950s. In his opinion, in the fifties and in the following decades colour was very important in architecture and social housing, mainly for economic reasons. Compared to other building materials and construction elements colour was more accessible and often played a decisive role in the appearance of architecture. Basically, colour was something that transformed architecture enormously and attractively while costing less than other materials.

Bernard Lassus sees strengthening the holistic approach to colour as the main force driving the evolution of environmental colour design. The holistic approach implies treating colour not as an isolated element separated from the other senses but using colour in its relationship to light, material,

movement, and many other dimensions and qualities that make up the atmosphere. Understood in this way, colour has considerable power and often is underestimated.

Colour designer *Jean-Philippe Lenclos* thinks that in today's life colour has become an essential dimension of the environment. Through communication via the press, television and social media, colour enters all areas of our lives and becomes omnipresent. Without being fully aware of it, people, and society in general, are permanently infused with colour in the living environment and landscape. On a sociological level, it can be observed that people are unconsciously being trained and gradually understand that colours are part of their life, their choice, and their mental perception of things. As a consequence, the colour designer's tasks also change. Today colour consultants are obliged to carry out long-term research projects to contribute to producing objects for the living environment in which colour plays a very specific role and corresponds to very precise expectations of the users and consumers.

Colour researcher *Michel Albert-Vanel* also believes that colour is becoming more and more important at all levels, but at the same time he sees the explanation for the omnipresence of black in fashion and architecture as the fact that people are afraid of colour. He emphasizes that this kind of chromophobia is completely alien to traditional cultures: "When you travel abroad, (...) you are immersed in the country's colours (...). In India, in particular, you cannot help but be impressed by the beautiful colours of the saris that women wear. If you go to Mexico, there are a lot of colours too; it is quite astonishing especially in the villages. And if you travel to Peru to Lake Titicaca you are welcomed by women wearing clothes of multiple vibrant colours similar to the colours of butterflies. It is really wonderful."

Colour designer *Victor Chérubin Grillo* is convinced that environmental colour design is a reflection of the society we live in: multicultural and evolving. Some architectural projects express freedom with saturated colours and polychrome façades, which have a cultural significance. Nonetheless, a certain return to the neo-Haussmannian style is taking place for example in Parisian suburbs. The shades of limestone are still a secure choice in architecture and the "ton pierre" ("stone colour") has been specified among other shades of limestone in the manufacturers' colour charts for the built environment.

Victor Chérubin Grillo emphasizes the important role of "colourists" or colour designers in the process of environmental colour design development. Grillo believes that by fulfilling the duties in line with the local authority's regulations of space, the colourist composes new variants that force the regulatory framework to evolve.

Visual artist *Yves Charnay* has been following the evolution of antipathy towards advertising and street art. In his view, colour has taken an important place in the environment over the last twenty years; firstly, through advertising in urban areas. It is an "anarchic" colour, however, whose main function is not to make life easier or pleasant, but to sell. Here colours are always shocking, strong, and aggressive. Secondly, in his view, street art in general and large-scale graffiti in particular are often created by people who do not have a sense for relationships with other people and the environment, but rather wish to impose their own signature. Charnay dislikes the multiplication of colour when colour "denatures" a landscape, city, or environment. He is convinced that colour should be included in urban projects and spaces either as artwork or colour designs based on research: "Then it is magnificent."

Colour designer and artist *André Lemonnier* delivered a surprising verdict in response to our question about how he sees the evolution of environmental colour design. He thinks that the profession he practiced in past decades does not exist anymore and now belongs to art history.

## **CONCLUSIONS**

Overall, our interviewees were far from unequivocal about the direction of the evolution of colour design in the environment. Landscape architect and visual artist Bernard Lassus asserts that the role of colour has changed since the 1950s. So does colour designer Jean-Philippe Lenclos who thinks that colour has become an essential dimension in the environment for several reasons, and that colour plays a very specific role in daily life and corresponds to very precise expectations of users and consumers. Colour researcher Michel Albert-Vanel believes that the explanation for the omnipresence of black is that people are afraid of colour. Colour designer Victor Chérubin Grillo, however, observes that the shades of limestone are still a secure choice in architecture. Visual artist Yves Charnay has been following the evolution of advertising and street art which should be replaced by artwork and colour designs in urban space. André Lemonnier even thinks that the profession he practiced does not exist anymore and now belongs to (art) history.

The answers of the six colour designers presently living in Paris, carefully analyzed in the French context since the 1950s, contribute to a better understanding of key aspects of the evolution of environmental colour design. They all agree on one thing: They are convinced of the need of a conscious and thorough application of colour in architecture and urban space and consider colour as a powerful means to modify interior and exterior built environments.

## **ACKNOWLEDGEMENT**

The conducted interviews are part of a broader project that aims to examine the French period in the history of environmental colour design and has been funded by the Mechnikov Program of the Embassy of France in Moscow.

## **REFERENCES**

- Caivano, J. L. 2006. The research on colour in architecture: Brief history, current developments, and possible future. *Color Research and Application* 31(4): 350-363.
- Evans, C. 2017. *Analysing semi-structured interviews using thematic analysis: exploring voluntary civic participation among adults*. Thousand Oaks, CA: SAGE Publications, Research Methods Datasets.
- Flick, U. 2009. *An introduction to qualitative research*. London: SAGE Publications.
- Griber, Y. A., V. M. Schindler, and M. Bouchier. 2019. Francuzskij period istorii cvetovogo dizajna sredy v vospominanijah sovremennikov [The French period in the history of environmental colour design]. *Social Transformations* 30: 48-52 (in Russian).
- Prieto, S. 1995. The colour consultant: a new professional serving architecture today in France. *Color Research and Application* 20: 4-17.
- Schindler, V. M., and Y. A. Griber. 2021. The philosophy of colour in the French period of environmental colour design. In: *The International Scientific Conference of the Color Society of Russia: Selected Papers*. Y. A. Griber, V. M. Schindler, eds. Smolensk: Smolensk State University Press, 310-318.
- Schindler, V. M., Y. A. Griber, and M. Bouchier. 2019. The French period in the history of environmental colour design. In: *Proceedings of the International Color Association (AIC) Conference 2019*. J. L. Caivano, ed. Newtown, NSW: AIC, 544-549.





## METHOD

The design process involved research in the area of individual color symbolism, color semantics and the possibility of mapping selected colors in ceramics (glaze, overglaze paints, ceramic decal). A series of tests was carried out to reproduce the colors described by the participants, and the palettes and ceramic samples were selected to enable their reproduction.

The research work was based on qualitative research (e.g. individual interviews, development of semantic graphs).

Conversations carried out with the users facilitated specifying colors evoking their associations and bringing back memories in reference to childhood objects (green surroundings, red window shutters etc.). Next, a matrix was developed and filled in – a semantic graph, into which the participants wrote all the associations connected with a given color. By means of color samples (such as color-aid booklet, pantone-postcards), they attempted to verbalize the meaning they attached to a particular color, define its hue, so that the glaze produced in the further stage of the project came possibly closest to the described color.

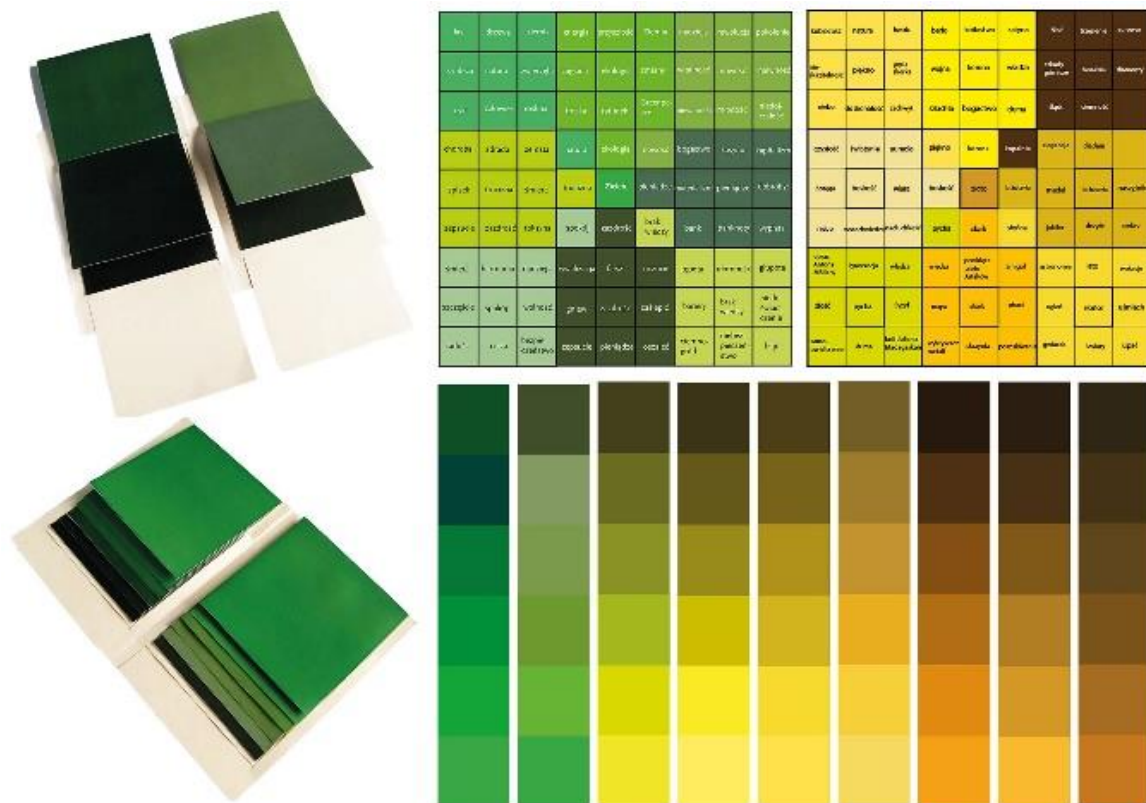

Figure 2: Methods.

The design work included the preparation of samples of textures, surfaces and colors in various ceramic techniques and translation of selected color values into the design of ceramic plates.

Beside the above mentioned experiments with color, various textures and level of gloss, dimness, homogeneity and graininess of the glazed surface were tested. As regards CMF design (color material, finish), all these elements are crucial for color perception, as they are directly connected with cultural context and individual user experience. It was especially important in the case of this project, because the colors and manner of glaze finishing were intended to connote personal memories of the project participants.

Due to the character of Silesia landscape, colors most frequently associated with memories and recalled for sentimental reasons were black and anthracite – related to the symbolic of coal, red – as element of local architecture (brick walls, window shutters), as well as green and sky blue – colors associated with nature.

The listed colors were reproduced with glazed samples in many variants, based on original recipes presented below (Table 1: Selected glaze recipes dedicated to colors described by project participants, Figure 3: Methods, glaze samples, Figure 4: Methods, glaze descriptions).

glaze		temp.	base	description
TC 7992	MK III	1220°C / 1060°C	porcelain	high / low temperature glaze
TC 8944	MK I		faience	
TC 8483	MM I		clays: pottery / chamotte / red	Predominance: cobalt and copper oxides / copper and iron oxides / crystalline zinc
TC 7992	KG I			
TC 18056	JP I			
TC 8218A	SŁ 3			
TC 9631	KM 1			

Table 1: Types and predominant content of glazes, applied bases, bake characteristics.

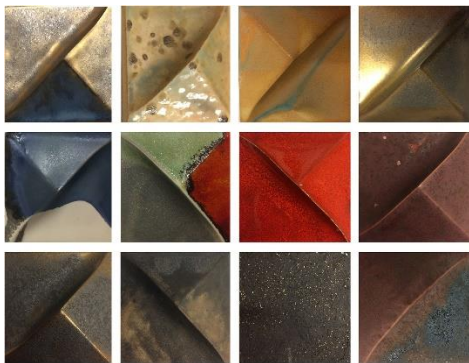

Figure 3: Methods, glaze samples.



Figure 4: Methods, glaze descriptions.

## PROJECTS RESULTS

The developed color palette was used in the original project, focusing on the idea of visualizing individual associations and images with the help of ceramics and graphics. Conducted interviews, which translated into the project, encompassed individual stories, memories of people, familiar space, colors, textures, and all the related elements that build memories. A plate or a set of plates was intended as a tangible representation, a lasting record of fading memories.

The final design solution was a set composed of:

- Graphic representation of a landscape described by the participant
- Map (street grid) of the immediate surroundings
- Words, patterns, characteristic symbols
- Round ceramic molding made in porcelain mass or color argil along with glazing – according to the color palette described by the user.

CMF in commemorative ceramics. Project of a color and texture palette on the example of “Ckliwe na szkliwie”  
Nostalgic Glaze. Personal collection of memories on ceramic plates.

The participants talked about their childhood, e.g. about the garden in which they used to play, about beautiful trees their grandfather had planted for their grandmother, family meetings in the kitchen, games around the block, their way to school and church. They described the district or city in which they had grown up, important points on the map, squares, sculptures, greenery and walking areas... They recalled the name of the street where their family house was before the war... where they moved and what they took, in their hearts, from the places in which had lived before...

Many interviewees equated home and family, children, grandchildren, the community; they attached great value to their family roots as well as expressed the desire to perpetuate the current moment in their lives.



Figure 5: Project process.



Figure 6: Project results.



CMF in commemorative ceramics. Project of a color and texture palette on the example of “Ckliwe na szkliwie”  
Nostalgic Glaze. Personal collection of memories on ceramic plates.



Figure 7: Project results.

## **CONCLUSIONS**

The research program and project activities were carried out in 2020 within the Minister of Culture and National Heritage scholarship, awarded to artists and designers by the Polish government for projects related to the dissemination of culture as well as project and research activities.

The project involved workshops carried out with users, designing a color palette based on the conducted research and production of a series of ceramic plates in partnership with Porcelana Bogucice – one of the oldest porcelain manufacturers in Poland.

It was implemented by the end of 2020 and nominated for the Śląska Rzecz 2021 – Silesian Icon 2021 award (Gołębiowska ed. 2021: 92) in the service category.

The documentation is available on the website: [www.ckliwienaszkliwie.pl](http://www.ckliwienaszkliwie.pl)

## **ACKNOWLEDGEMENTS**

I would like to thank the following institutions: The Upper Silesian Museum, Museum of Katowice History, Castle Cieszyn – I can always rely on their substantive support.

I would also like to thank all the persons involved in preparation, interviews, design and production process: Bogdan Kosak, Marek Przybyło, Piotr Grzymowski, Ms Ania “from production,” Irena and Roman Gatys, Agnieszka Pluta, Monika and Ewa Niewiadomka, Jarosław Gwizdak, Zofia Oslislo-Piekarska, Halina Bieda, Agnieszka Nawrocka, Paweł Świdorski, Kowale i Sąsiedzi, and most of all – Anna Kamieniak for the project name “Ckliwe na szkliwie” – Nostalgic Glaze.

## **REFERENCES**

- Becerra, L. 2016. *CMF Design. The Fundamental Principles of Colour, Material and Finish Design*. Frame Publishers, Amsterdam.
- Bloomfield, L. 2019. *Colour in Glazes*. Bloomsbury Publishing PLC.

CMF in commemorative ceramics. Project of a color and texture palette on the example of "Ckliwe na szklwie"  
Nostalgic Glaze. Personal collection of memories on ceramic plates.

[www.ckliwienaszklwie.pl](http://www.ckliwienaszklwie.pl) (Available on August 15, 2021).

Coloraid. <https://coloraid.com> (Available on August 15, 2021).

Gołębiewska E. ed. 2021. *Silesian Icon*. Zamek Cieszyn, Cieszyn.

NCS. <https://ncscolour.com> (Available on August 15, 2021).

Pantone. <https://www.pantone.com/pantone-postcards> (Available on August 15, 2021).

Zausznica, A. 1959. *Nauka o barwie*. PWN Warsaw.

# Colored Response: Technology, Thermo-chromic Material Systems and Human Awareness

Marcus Farr <sup>1,\*</sup> and Andrea Macruz <sup>1</sup>

<sup>1</sup> Tongji University, AUS; mfarr@aus.edu; andrea.macruz@uol.com.br

\* Corresponding author: mfarr@aus.edu

## Abstract

Design and communication have been significantly affected by color responsive technology for decades. In the 1960s, color television and photography affected our relationship with technology in ways that influenced the ability to communicate around the world. With this came new processes of color sensitization and dye responsive properties that started a dialogue between designers and technology that has expanded exponentially. With the advent of computers, our relationship with technology has become so intrinsic that it is now difficult to communicate without them. Nevertheless, because of technology, isolation and polarization are becoming socially commonplace. The link between technological innovation and social segregation presents an ongoing issue that can be addressed by designers using responsive color. Is there a way color and technology can merge in architectural environments to allow for better communication? What materials and processes are conducive to this? Can this potential be leveraged to allow for better spaces and increased empathy between people?

**Keywords:** *technology, materials, color-responsive, thermo-chromic, architecture*

## INTRODUCTION

This paper discusses the potential for meaningful connections between people and architectural space by reviewing the corresponding role between technology, color and materials in a project case study. It explores the role design can play when paired with responsive technology and material to leverage new power for future interaction design. To interrogate this as a line of inquiry we have created a spatial prototype paired with a series of color-active simulations that respond to human interaction. The project employs a color sensitive, responsive surface that combines a fluid computational pattern with temperature responsive bi-materials. These are coated thermo-chromically to change color value, and are electrically programmed with micro-controllers, and then connected to a computer code that makes readings based upon human interaction with wearable technology, which in turn changes the color of the material. The methodology allows the simulation results to be categorized into various states, such as calm or aroused, which is made visual via color. As the computational patterns and colors change, we are made aware of the relationships between human sensorium, space and technology. The methodology and results are used to frame a deeper understanding of architecture and color and discuss how we utilized a marriage of computation and physical material studies to simulate a variety of potential outcomes.

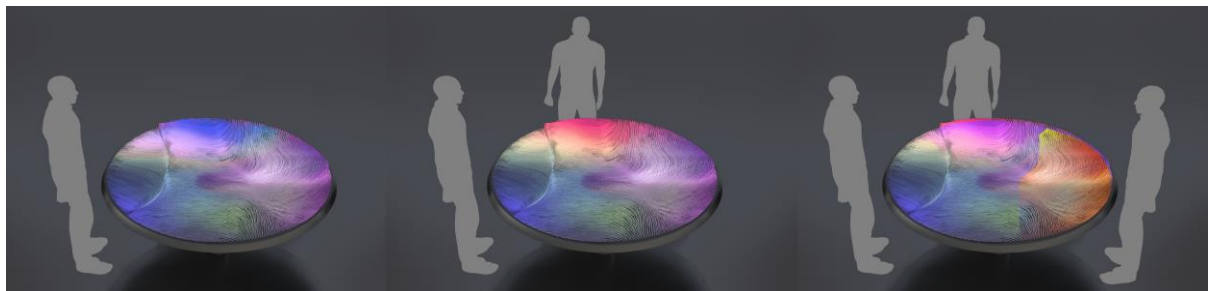

Figure 1: Simulations of ceiling surface changes with multi-person non-verbal interaction using Houdini.

**PROCESS, MATERIALITY AND SIMULATION**

In this project, the process of simulation with color aids in creating a more robust prototype. Using digital technologies such as micro-controllers, Rhino, Grasshopper, and Houdini, paired with physical testing that altered the color of material, we evaluated a workflow between computational design and material logics as related to our prototyping. Through this process, we categorized the test results into two separate morphological conditions: “Aroused States” and “Calm States”, each with color specific properties as diagnosed by the wearable Upmood sensors. As users engage with the prototype, the computational patterns and colors change, and we subsequently become more aware of the relationships between people. As simulations for the project began to expand, it became necessary to break them down into a series of categories that demonstrated how the results could impact the overall design and show how the different simulations could affect our decision-making process for future projects. To explore this further, we used a Houdini model to generate patterns responsive to color that could be simulated based upon information gained from the Upmood algorithm. It then was paired with the Rhino model to explore the capacity for responsive geometry in the process of different material states. This process required an intense amount of electronic manipulation and conversion of algorithmic data. The digital workflow allowed us to not only visualize before building but make decisions for how we wanted this expensive prototype to be built in the end, and in some ways, designing the *process* was more important than designing the finished product. Along with the simulations, we tested several versions of bi-materials, including combinations of metal sandwiched with organic material such as paper. The bi-material utilized in this project is composed of two separate metals joined together and consists of layers of different materials that vary in thickness and property. The bi-materials are useful because they convert a temperature change into recognizable form displacement, and then due to their different material properties, revert back to an initial position after the increase in temperature has subsided. The embodied energy of the materials become visual as the energy is released and absorbed, this displacement is therefore very useful for designers in working with temperatures and electronic inputs.

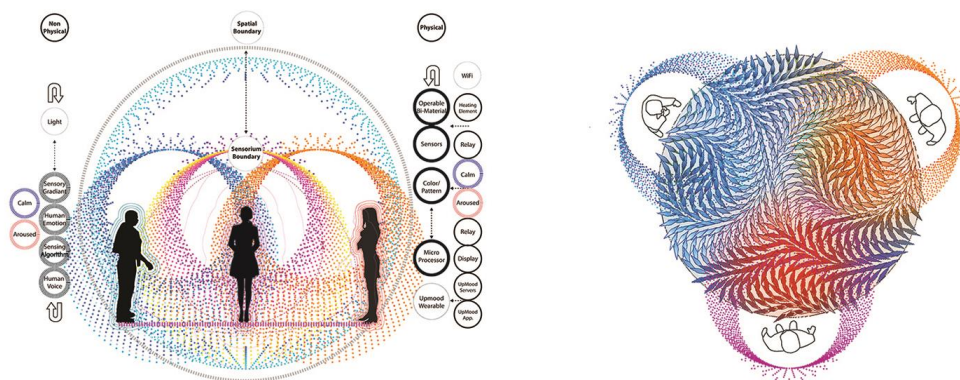

Figure 2: Operational diagrams of responsive material behavior including process of mood application, wearable sensors, algorithm, human interaction, and subsequent physical material change.

The bi-metals behaved as expected in terms of bending, however, it did not fall into our desired temperature ratios for the heating interface. Because of this, it became clear that extremely thin metal combined with an organic, paper-based product would offer the most performative value at this scale and was consistently the most successful combination. This was a significant decision

because the metal allowed for enough rigidity, and the paper-based material allowed for a more direct relationship between the thermochromic paint and the temperature differences, and consequently a very large factor in determining color change. At 500 watts the biomaterial starts to move, but in a slow rate. The higher the temperature, the more the metal deforms and the more it is responsive to the temperature.

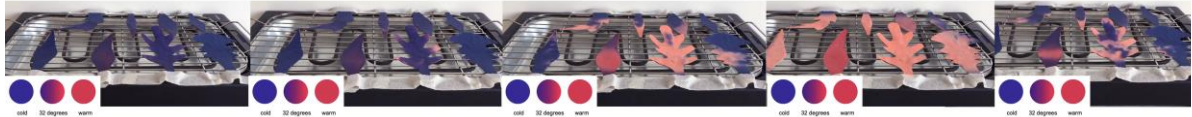

Figure 3: Material tests showing color changes of individual material units based on temperature and heat-responsive inks



Figure 4: Mechanical tests of individual control systems that connect the process of human emotional state, programming, processing, temperature change, and material response.

### **RESPONSIVE COLOR AND TECHNOLOGY**

Leuco dye can switch between two chemical forms and can be activated by heat and exposure to light which results in thermochromism. We utilized a coating of leuco water-based dye on the bi-materials because this finish allows colors to change in the presence of temperature variation. The process is reversible up to 60 degrees, and irreversible from 60 degrees onward. It allows for the mixing of shades of colors between the same turning point, but in this project no mixtures were used. The color intensity in this process depends on the designer’s needs, but the weight of the covering (paint coat) should be 2 to 3 times that of normal paint. The dyes are rarely applied on materials directly; they are usually in the form of microcapsules with the mixture sealed inside.

In order to activate the colored surfaces, users wore emotion-sensing bracelets when they visited the project. Here, we worked with Upmood technologies to begin understanding how to measure and estimate the heart rates and emotional states people have in response to a given environment. The bracelets collect biodata from the user and result in 11 different emotional states such as calm and tense. This data was continuously fed into an App that revealed the different states back to the user. The evaluations and the use of these overlapping technologies acted as a way to gain insight into a more profound human experience because the color is visible in the thermally active surfaces as the user visits the project. Through this process, the project addressed user insight relative to emotional patterns and management via color.



Figure 5: Programming of the surface with Grasshopper incorporating color change based on temperature using a coding pattern whereby straight leaves are blue, or calm, at a resting state, and leaves that undergo bending and thermo-chromic color change, such as orange and red equal a state of tension.



**WEARABLE, COLOR ACTIVATING TECHNOLOGIES**

Wearing Upmood bracelets allowed us to monitor different emotional states in real time as we interacted with the project. What we found is that the technology can be sometimes accurate and sometimes surprising, indicating that our heart rates change in different ways and can be highly situational and sometimes inaccurate. The conclusions for these findings via Upmood wearable technologies indicate that stable peaks, highs, and lows, in experience are crucial to accuracy, and variance from person to person can differ. There can also be discrepancies between what the users “thought” they were feeling, and what the technology actually indicated. Fluctuation in experience will also affect the results. However, in all cases the thermochromic surfaces were activated.

A relay module was used along with an LCD display to connect with a microprocessor and Wi-Fi, which is in turn connected to a heating element and surface hardware along with other auxiliary components. The processor was used to communicate with the Upmood server. Once emotions are received from the server by the microprocessor, they are shown on the display, and the heating element is activated or deactivated by the relay module, this then activates the surface temperature and the thermochromic values are displayed as a color range.

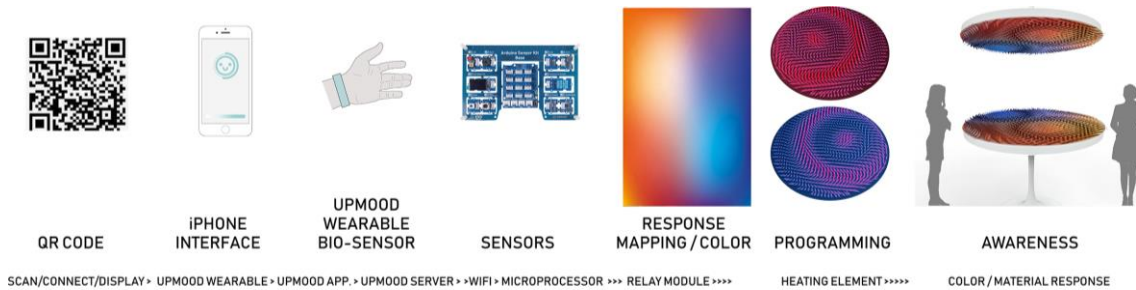

Figure 6: Operational diagram illustrating process of QR code, wearable, sensors, algorithm, server, human interaction.

**CONCLUSIONS**

In this project, we explored the potential of color relative to digital technologies and material interactions in the field of bi-material and introduced the human sensorium to a potential interaction with embodied thermal properties. We designed a small prototype which cultivated a sensory experience between users with a goal of facilitating better non-verbal communication between people by using color and employed simulations as part of our design workflow. Through non-verbal communication, the project increases empathy and encourages cooperation. Brown (2010). Throughout the process, we asked questions about the capacity to design with technology and its subsequent impact on human beings via color. This process started by employing typical parametric and computational software, thinking of the potentials between the digital and the real, and incorporated this potential by accepting the role of material manipulation and response to temperature as a way to interact with architectural space and people. The purpose was to engage people with sensory experiences that force humans to re-perceive our physical world. The outcomes imply that through research and design, stronger sensorial experiences can be used to increase awareness, perceptibility, and create new design conversations.

The connection between the brain and the sensorial channels through which we understand and perceive the world are continuously being explored by Neuroscientists. As an example, we know that touching something with a texture can change a person's mood and influence the decisions a person makes. Bradt (2010). Touch and sight also seem to be very important to a human's well-being and

have been found to convey compassion from one human to another, and the human sensorium can intensify emotional connections between people. Along with texture, light, color and shadow are very important in the human sensorium, and can be so important that they can change or alter or perceptions of communication. Technology has introduced a multitude of positive and negative effects into our lives. On one hand, it has brought forth positive impacts in keeping us more informed and connected, while on the other, it has created new disorders and diseases such as internet depression, FOMO (fear of missing out), diminished comprehension, and deep retention, affecting the morality of people, among other things. Caggiano (2018). It also has the power to help us achieve better awareness through our connection to architectural space and other people.

Because of the profundity and pervasiveness of current technology, we have a multitude of options that connect us to our daily lives, in the workplace and beyond. These offer conveniences and allow us to be almost constantly connected to technology in one form or another. According to Andy Clark, a professor of philosophy and metaphysics at the University of Edinburgh, “we are already cyborgs or human-machine hybrids” (Clark 2008), which means the physical merge of flesh and electronic circuitry without the need for wires, surgery, or bodily alterations. He argues that it is arbitrary to say that the mind is contained only within the boundaries of our brain because it has always collaborated with external, non-biological sources to solve the problems of survival and reproduction in humans. He states that, “with the advent of texts, PCs, coevolving software agents, and user adaptive home and office devices, our mind is just less and less in the head. In other words, the separation between the mind, the body, and the environment are seen as an unprincipled distinction (Clark 2008). Following this line of thought, if we are already cyborgs and technology is a major contributor to that, we have to capitalize on the positive aspects and place boundaries on the negative ones. Moreover, if the opposites enable us to boost experience and add value to a situation, it is potentially useful to incorporate this thinking into a design workflow that allows for a filtering of received input data and a balance of outputs as outcomes.

What we have learned offers a great deal of input relative to humanizing the design of everyday objects to allow a more heightened experience and relationship between human and a potential project. Although there is much work to be done and this paper only documents one sample series of prototypes, the use of this physical prototype merged with ongoing computer simulations allowed us to begin to predict and forecast how the impact of color and our design could respond to specific levels of human interaction. The use of bi-materials allowed us to create physical, colored responses that relate directly to human interaction, and the role of sensors and wearable technology allow us to further dial in and program the project in a way that illustrates human connectivity and interaction in real time.

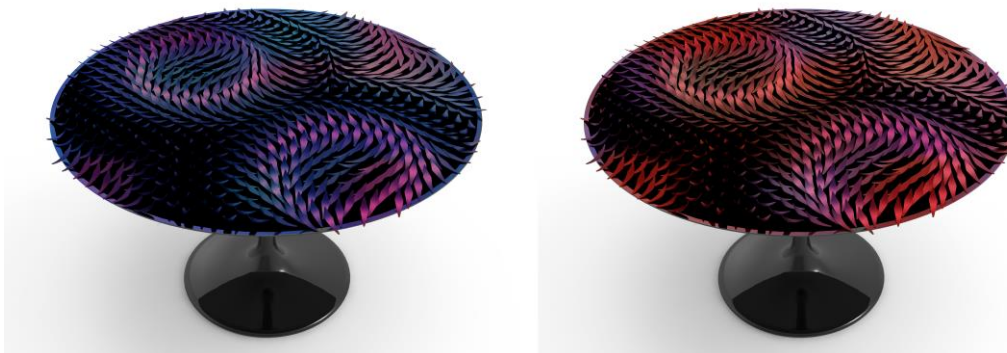

Figure 7: Images of final rendered prototype showing color and material changes.

## **ACKNOWLEDGEMENTS**

Ahmed Abdelnaby, Houdini consultant.  
Charles Kit Yi Lo, UpMood consultant.  
Arian Saghafifar, Scripting assistance.  
Alexandre Ulson, Mechanical coding.

## **REFERENCES**

Brown, B. 2021. *The Power of Vulnerability*, TED. June 10.  
Bradt, S. 2021. *How Touch Can Influence Judgments*, The Harvard Gazette. June 8, 2021.  
Caggiano, S. 2021. *Convergent Design: On the Role of Product and Furniture Design in Enhancing User Experience as The Digital and Real World Converge*, Academia. June 21, 2021.  
Clark, A. 2004. *Natural Born Cyborgs: Minds, Technologies, and the Future of the Human Intelligence*, 1st ed, Oxford University Press, UK.  
Clark, A. 2008. *Supersizing the Mind: Embodiment, Action, and Cognitive Extension (Philosophy of Mind)*. 1st ed, Oxford University Press, UK.

# The relevance of color in post COVID-19 interior design

Francesco A. Scullica <sup>1</sup>, Elena E. Elgani <sup>2</sup> and Umberto Monchiero <sup>3, \*</sup>

<sup>1</sup> Department of Design, Politecnico di Milano; francesco.scullica@polimi.it

<sup>2</sup> School of Design, Politecnico di Milano; elena.elgani@polimi.it

<sup>3</sup> Department of Design, Politecnico di Milano; umberto.monchiero@polimi.it.

\* Corresponding author: umberto.monchiero@polimi.it

## Abstract

The aim of this paper is to investigate the impact of thoughtful use of colors in post COVID-19 interior design and architecture, through the analysis of relevant case studies that challenge the definition of residential, work and hospitality spaces. Houses used to provide a private retreat from working and social activities, but in 2020 they abruptly took on new functions that once were prerogative of hotels and workspaces. This resulted in an extreme blurring of private and public spaces in the home, that can potentially have detrimental effects on the mental health and well-being of its occupants. Reconsidering essential elements of design practices, such as the chromatic definition and acoustics, could therefore help soothing the popular insecurities of the fruition of public places, well remark the role of private ones and further define new hybrid spaces, as shown by the research “Living, Working and Traveling”, curated by E. Elgani and F. Scullica.

**Keywords:** COVID-19, Interior Design, Hybridization, Home, Well-being.

## INTRODUCTION AND BACKGROUND

The last 15 months marked a deep change in the way people live and work. The emergence of a complex disease such as COVID-19 revealed imbalances within complex ecosystems comprising humans, animals and the environment (Morens and Fauci 2020), globally renewing the need for sustainable development (Alibegovic et al. 2020). An extremely notable modification is the one that took part in the constellation of interior spaces we used to live into.

For instance, traditional workspaces lost their paradigmatic role in our societies (Piardi et al. 2019); workplaces in the last 30 years gradually evolved from isolating realities to spaces that accommodate increasingly interactive tasks: the “cubicle” has slowly transitioned to a more “mobile workplace”, an idea that is also close to the contemporary model of smart-working, allowing people to work from anywhere (Elgani and Scullica, 2019), while in 2020 leaving offices empty and waiting for redesign.

At the same time, a surge in teleworking practices was often seen as a way to ensure business continuity while complying with health emergency restrictions (Corso 2020), often reconfiguring living spaces as home-workspaces; in 2020 the enclosed space of the home was abruptly asked to accommodate functions ranging from working to playing, from relaxing to taking care of one’s own health (Bassanelli 2020): the house became the space in which we focus all aspects of our daily lives. Nevertheless, this paradigmatic shift could have long-term detrimental effects on health and well being of many workers (Comella-Dorda et al. 2020), especially on younger generations that are being severely hit financially for the second time in their life (Lee, 2020) and that are missing the office more than other age groups (Allan and Miglani 2020) because it embodies an entire ecosystem essential to their productivity and social life (Kuang 2018);

Furthermore, COVID-19 has exacerbated many inequalities especially in the working lives of women: the significant burden of unpaid housekeeping works, still disproportionately carried out by women in many societies around the globe (Milliken 2020), has caused women around the globe to make up more than half of all pandemic-related job losses (Madgavkar 2020).

The integrity and the resilience of the entire humankind have been severely put to the test: psychological issues emerging from an altered work-life balance could pose a serious threat for most segments of the world population (Simon et al. 2021) (Czeisler et al. 2020). It is therefore impossible not to consider the toll on our societies that this disease took: new exemplar models of living and working must help enacting meaningful changes towards a more sustainable future of our societies, both social and environmental.

### **Perception in post COVID-19 interiors**

The use of communal spaces has greatly reduced during the Sars-CoV-2 pandemic, however it is for example safe to assume that, thanks to their fundamental values - such as people aggregation and increased productivity - office spaces will not cease to exist in the next decades, but will instead keep evolving and inspiring the people that use them.

Thus, a question naturally arises: how can post COVID-19 architectural design practices encourage a thoughtful approach of users towards reinhabiting interior spaces other than the home? An answer could lie in “perception” as a powerful design tool. Although it is impossible to know if the world population will ever go back to live public spaces in the same way as before, the perception of safety and hygiene in an interior space is just as important as the effective safety and hygiene of it.

On the one hand, it is important to consider interiors’ acoustics: a well-planned interior should not hinder communication, meant as the ability of hearing and being heard. Speech intelligibility is essential in workspaces, and acoustic privacy is vital for comfort in private dwellings (Ordieres Meré 2008): achieving acoustic comfort of an interior, by soundproofing rooms with the purpose of reducing reverberation times and achieving low noise levels and sound propagation, may be one of the first steps in feeling safe again in it: if external sounds are distant and muffled, we feel sheltered from other people and, therefore, from contaminants and pathogens.

On the other hand, color takes on an equally fundamental function; in fact, COVID has brought attention to an important element, the hygiene of the interior environment: materials with crevices and ridges, deep grout lines, and porous or uncoated ones cannot be thoroughly cleaned or treated with disinfecting detergents, thus becoming a possible mean of transmission for external pathogens (WHO 2020). Therefore, materials that naturally repel bacteria and germs, or that are easy to wash, are preferable (Schneide, 2021): this leaves room for an extensive diffusion of materials such as stoneware, ceramics, polymers and many others that also allow for the possibility of being colored by the principle directly into the paste and, therefore, colors could be increasingly present in our future homes and public spaces. In fact, we cannot forget the vast neuro-psychological relationships of colors with human well-being, so their use, whether unrestricted for the delineation of floors and walls or incorporated within materials, may prove to be one of the most effective tools at our disposal to establish a new way of living interiors post COVID-19.

### **THE RESEARCH**

While residential typologies have developed at a slower pace over the last century, offices have seen radical changes take place within them, both in terms of layout, function, and visuospatial features.

In particular, the design of workspaces in the 1900s has evolved from grand, private offices, to the era of cubicles and open-plans, and is now entering a new phase that revolves around services and employees well-being (Whitman 2020). The vast open-plan offices are soon to be a memory of the past: corporate towers might be replaced by touch-down hubs to be used as meet-up points, while most of the work could be conducted from home or Co-Working spaces (Peach 2020).

This shift is best visible when observing an historically important office, and a workplace created in the COVID era to accommodate the needs of workers without a workplace at home; on the one hand we can see how an insitutional workplace in 1939 would have looked like (Fig. 1): Architect Giuseppe Pagano Pogastchnig designed the new buildings and the interiors for Bocconi University in Milan, IT. The Dean's office (fig. 1) is a remarkable expression of rationalist design practices in Italy, where the high role of the Dean is well expressed by the ample spaces, the tall ceilings and the valuable materials used for the coatings, including walls. On the other hand we have a contemporary interior for working-class people from the Eastern suburbs of London (Figures 2 and 3): the architect Caro Lundin designed it during the first lockdown as a new way of "WNH", work near home, for those in the neighborhood who did not have the resources to adequately perform their duties from home.



Figure 1: Offices of the Dean, Bocconi University. Milan, IT. Designed by Giuseppe Pagano Pogatschnig during the 1930s, inaugurated in 1941.



Figure 2: workstations in ARC-Club Co-Working, London UK. Designed and realised in 2021.



Figure 3: Lobby, ARC-Club Co-Working, London UK. Designed and realised in 2021. Photos by Andrew Meredith ©

Even if quite dissimilar, the contrast between the two workplaces (Figures 1, 2 and 3) is particularly interesting because, although both very open and airy, the occupants' differing needs in carrying out their work highlight substantial differences: first of all, in the first one we can see the use of calming colors and a strong imprint on materiality, also to emphasize the formal atmosphere of the place, as well as being very high-rise. The second one instead feels more enclosed and is characterized by many different working typologies, ranging from private rooms to large communal tables, an informal mood, and shows a greater attention paid to the use of color as a pure element.



This use of color in Arc-Club in London well represents the dichotomy of the present times: on the one hand, the need to feel safe from contamination, expressed through reassuring tones and finished, non-porous materials; on the other hand, the drive to re-start: the splashes of bright color are enlightening and energizing for the users of the space, motivating them to rediscover their productivity and enthusiasm in a new normalcy constituted by neighborhood Co-workings and teleworking practices. It is therefore no coincidence that the Pantone company has chosen to celebrate 2021 with the choice of two colors (Boone 2020), but more significant could be a reasoning suggested by the American Coatings Association: by comparing some trends of leading wall-painting producers, we can see an emerging preference for shades of green in the domestic environment (Challener 2021).

The house in fact, during these uncertain times, should look as clean and fresh as possible; green is associated both to colors ordinarily used in health care, and to hues that recall a contact with nature. We cannot therefore overlook the neuro-psychological effect of green, both as a botanical element and as a color, on our well-being: the inclination of contemporary architectural spaces is to increasingly turn towards "biophilia", as the presence of natural living elements in domestic interiors can act as a natural filter thus limiting air pollution, also directly improving the quality of life and sleep, an essential element for a proper work-life balance; furthermore, incorporating biophilic concepts in workplaces can also help to develop positive emotional responses directly related to interpersonal relationships and productivity (Estudio Guto Ruquena 2021).

In further developments of a post-COVID-19 modernity, the well-being of the worker and the dweller should become a major focus of design research: by analyzing past shortcomings and using often overlooked tools conscientiously, increasingly better environments can be created. For instance, in the first decades of the 21st century, Europe has witnessed a disproportionate partitioning of domestic space that has favored living areas, merging them with spaces for food preparation and consumption, while disfavoring more private areas such as bathrooms and bedrooms. This approach has proven to be a failure during COVID, as it often prevents families and domestic partners from having sufficient private spaces to work and study from home, and is consequently negative for a proper work-life balance. The flexibility of furniture and spatial functions is an invaluable tool that can ensure the usability of each environment in different situations, even when small in floor space, as is often the case in small urban apartments.

In this last case as well, color can be a valuable aid to the designer: in situations where there are limitations to the physical separation of spaces; graphic connotations through the use of color, be it colored materials or paint, can better suggest the functions assigned to a certain space and thus induce the dweller to develop healthy habits in order to avoid further contamination of the interior environment, such as taking off shoes at the entrance or disinfecting electronic devices and garments.

In the final instance, we also need to remember the cultural value that can be attached to a given hue. Colors can refer to a cultural legacy and thus cheer people up, or make them reflect: successful interior design takes human comfort into account, and the careful study of chromatic selection should well be part of heritage-centered or human-centered design practices.

## **CONCLUSION**

This research is not intended to provide permanent solutions, but rather it aims to contribute with tools and suggestions for reflecting on the visual perception of interiors, whether public or private, towards a more viable and flexible post COVID-19 future.

Indeed, the attentive use of color can be an appreciable strategy to increase well-being and comfort within the places we inhabit on a daily basis, enticing us to rediscover the value of certain spaces and

heightening our awareness about the conscious use of other ones. A more conscious approach to the use of color as a powerful design tool could be a socially, environmentally and economically sustainable response to the challenges of interior design in the post COVID-19 era.

## REFERENCES

- Alibegovic, M., L. Cavalli, G. Lizzi, I. Romani and S. Vergalli. 2020. Covid 19 & SDGs: Does the current pandemic have an impact on the 17 Sustainable Development Goals? A qualitative analysis. *Fondazione Eni Enrico Mattei*, Milano. Retrieved: [https://www.feem.it/m/publications\\_pages/brief07-2020.pdf](https://www.feem.it/m/publications_pages/brief07-2020.pdf) (accessed May 2020).
- Allan, R., and K. Miglani. 2020. Research - Home and away: The new workplace hybrid?. *JLL - Jones Lang LaSalle Incorporated, Asia Pacific report*. Retrieved: [www.jll.com.au/content/dam/jll-com/documents/pdf/research/apac/ap/jllresearch-home-and-away-jul-2020-latest.pdf](http://www.jll.com.au/content/dam/jll-com/documents/pdf/research/apac/ap/jllresearch-home-and-away-jul-2020-latest.pdf) (accessed May 2021).
- Boone, L. 2020. The Pantone Colors of the year for 2021 are Ultimate Gray and Illuminating. *Los Angeles Times – Lifestyle online column*. Retrieved: <https://www.latimes.com/lifestyle/story/2020-12-09/the-pantone-color-of-the-year-for-2021> (accessed July 2021).
- Challener, C. 2021. How Covid-19 is influencing trends in painting colors. *American Coatings Association – Coatings Xperience*. Retrieved: <https://www.paint.org/coatingstech-magazine/articles/how-covid-19-is-influencing-trends-in-paint-colors/> (accessed July 2021).
- Comella Darda, S., L. Gard, S. Thareja, and B. Vasquez-McCall. 2020. Revisiting agile teams after an abrupt shift to remote. *McKinsey & Company – organization practice*. Retrieved: [www.mckinsey.com/business-functions/organization/our-insights/revisiting-agile-teams-after-an-abrupt-shift-to-remote](http://www.mckinsey.com/business-functions/organization/our-insights/revisiting-agile-teams-after-an-abrupt-shift-to-remote) (accessed May 2021).
- Corso, M. 2020. Smart working during the time of the Coronavirus. *Politecnico di Milano – School of Management*. Retrieved: <https://www.som.polimi.it/en/smart-working-during-the-time-of-the-coronavirus/> (accessed May 2021).
- Czeisler, M., R. Lane, E. Petrosky, J. Wiley et al. 2020. Mental Health, Substance Use, and Suicidal Ideation During the COVID-19 Pandemic — United States, June 24 – 30, 2020. *MMWR Morbidity and Mortality Weekly Report – CDC*. 69, 1049–1057. Retrieved: [https://www.cdc.gov/mmwr/volumes/69/wr/mm6932a1.htm?s\\_cid=mm6932a1\\_w](https://www.cdc.gov/mmwr/volumes/69/wr/mm6932a1.htm?s_cid=mm6932a1_w) (accessed June 2021).
- Estudio Guto Requena. 2021. Neurodiversity and Biophilia: the Future of the Workspace in the Post-Pandemic Era. *ArchDaily*. Retrieved: <https://www.archdaily.com/962650/neurodiversity-and-biophilia-the-future-of-the-workspace-in-the-post-pandemic-era> (accessed July 2021).
- Kuang, C. 2018. What Apple’s new office chairs reveal about work in 2018. *Fast Company*. Retrieved: <https://www.fastcompany.com/90155533/what-apples-new-office-chairs-reveal-about-work-in-2018> (accessed June 2021).
- Lee, D. 2020. The Recessionals: why coronavirus is another cruel setback for millennials. *Financial Times – Coronavirus: Free to read*. Retrieved: <https://www.ft.com/content/241f0fe4-08f8-4d42-a268-4f0a399a0063> (accessed May 2021).
- Madgavkar, A., O. White, M. Krishahn, D.Mahajan and X. Azcue. 2020. COVID-19 and gender equality: countering the regressive effects. *McKinsey Global Institute*, Mumbai. Retrieved: <https://www.mckinsey.com/featured-insights/future-of-work/covid-%2019-and-gender-equality-countering-the-regressive-effects> (accessed May 2021).



- Milliken, F., M. Kneeland and E. Flynn. 2020. Implications of the COVID-19 Pandemic for Gender Equity Issues at Work. *Journal of Management Studies; John Wiley & Sons* 57:8. Retrieved: <https://onlinelibrary.wiley.com/doi/pdf/10.1111/joms.12628> (accessed June 2021).
- Morens, D., and A. Fauci. 2020. Emerging Pandemic Diseases: How We Got to COVID-19. *Cell Journal*, 182 (5): 1077-1092. Retrieved: [https://www.cell.com/cell/pdf/S0092-8674\(20\)31012-6.pdf](https://www.cell.com/cell/pdf/S0092-8674(20)31012-6.pdf) (accessed May 2021).
- Ordieres Meré, J., E. Vergara González, F. Alba Elías and A. Pernia Espinoza. 2008. Acoustic design criteria as a relevant factor for architectural projects. *Universidad de La Rioja*. Retrieved: [https://www.arauacustica.com/files/publicaciones\\_relacionados/pdf\\_esp\\_312.pdf](https://www.arauacustica.com/files/publicaciones_relacionados/pdf_esp_312.pdf) (accessed July 2021).
- Peach, S. et al. 2020. The role of the office will be challenged – a conversation with Sevil Peach. *Vitra Magazine*. Retrieved: <https://www.vitra.com/en-it/en-us/magazine/details/the-role-of-the-office-will-be-challenged> (accessed May 2021).
- Piardi, S., F. Scullica, M. Ottomanelli, E. Elgani et al. 2019. Con Concealed interiors for production in the Age of Industry 4.0. *IE:Studio - The Hidden Interior*, 4(1), 28-32. Retrieved: <https://interioeducators.co.uk/journal/the-hidden-interior/concealedinteriors-for-production-in-the-age-of-industry-4.0> (accessed April 2021).
- Schneider, A. 2021. Materiality in a Post-COVID-19 World. *ArchDaily – Articles*. Retrieved: <https://www.archdaily.com/964664/materiality-in-a-post-covid-19-world> (accessed July 2021)
- Simon, N., G. Saxe, C. Marmar. 2021. Mental Health Disorders Related to COVID-19–Related Deaths. *JAMA – Journal of American Med. Association*. 324 (15), 1493–1494. Retrieved: <https://jamanetwork.com/journals/jama/fullarticle/2771763> (accessed April 2021).
- Scullica, F. 2019. A New Concept of Hospitality. In: *Living, Working and Travelling – New Processes of Hybridization for the Spaces of Hospitality and Work*, Elgani, E., and F. Scullica. ed. Franco Angeli:21-26.
- Whitman, C. 2020. A look into the Workplace Post-Covid-19: The “Anti-Office”. *WorkDesign Magazine*. Retrieved: <https://www.workdesign.com/2020/06/a-look-into-theworkplace-post-covid-19-the-anti-office> (accessed May 2021).
- WHO (World Health Organisation). 2020. *Cleaning and disinfection of environmental surfaces in the context of COVID-19*. Retrieved: <https://apps.who.int/iris/bitstream/handle/10665/332096/WHO-2019-nCoV-Disinfection-2020.1-eng.pdf> (accessed June 2021).

# The Odor of Colors: Correspondence from a Cross-Cultural Design Perspective

Anna Barbara <sup>1,\*</sup>, Reejy Atef Abdelatty Mikhail <sup>2</sup> and Maria Camila Álvarez García <sup>3</sup>

<sup>1</sup> Politecnico di Milano; anna.barbara@polimi.it, Associate Professor, Design Department, Politecnico di Milano

<sup>2</sup> Politecnico di Milano; eejyatef.mikhail@mail.polimi.it, Design Department, Politecnico di Milano

<sup>3</sup> Politecnico di Milano mcamila1294@gmail.com

\* Corresponding author: anna.barbara@polimi.it

## Abstract

Would a rose smell as sweet if it were blue? Perhaps not, colors and odors are associated. It is more likely that people would use the word “yellow” to describe the odor of a lemon, than the word “blue” if they were asked to use color terms for describing their olfactory experiences. The paper is a scientific and cultural exploration of color–odor correspondences, with suggested variables to be explored in design studies. The findings are considered as a protocol for designers to adopt the inclusion of the sense of smell within the design of places through synesthetic behavior assisted by the use of color.

**Keywords:** Color, Olfaction, Color–Odor Correspondences, Synaesthesia, Cross-Cultural Differences

## INTRODUCTION

People usually match strawberries smell to the color pink or red and also it is found that more intense odours correspond to darker colors. Color not only facilitates odor identification, but also it can affect judgments of intensity and pleasantness. An ambiguous combination of color and odor is not only confusing but can also lead to a sense of unpleasantness. Because of this co-occurrence of visual and olfactory experience, it should come as no surprise that cross modal correspondences between colors and odors exist.

At least 20 peer-reviewed papers have been published in the last quarter-century that have examined the consistent and non-random existence of the colors that people intuitively associate with particular familiar and unfamiliar odors in a non-food sense. Researchers have proposed several different reasons for the presence of cross-modal correspondences over the years, including mathematical, semantic, structural, and emotional-mediation accounts. The concept of 'synaesthesia' or 'syn-olfactismo' has a long history of interest in the separate literature on synaesthesia, as it is commonly called. Several artists and composers, from Cézanne to Scriabin, were involved in the correspondences that connected colors and odors in the early twentieth century.

According to neuroscience, there are two ways of exploring the modulation and association between vision and odor. A visual modulation of olfaction, that highlights the influence of color in odor perception, and an olfactory modulation of vision, that explains how an odor is able to evoke a certain color within our brain's memory.

On the other hand, color–odor correspondences are the result of learned associations in which the particular color that people choose as corresponding to a particular odor varies from culture to culture. Within each culture, it is discovered consistent trends in color choices for each odor, indicating that people make a specific color-code matches.

### Color and odor neurological correspondence

To understand how color could have an odor, the physiological relationship between vision and olfaction should be considered. Starting from the base that, contrary to what it is believed, senses do not work by themselves, they interact with each other during the process of sensation and

perception; a phenomenon explained in the concept of cross-modality by Peleteiro (2016). Furthermore, humans use information from multiple senses and the information received from one sense can modulate the information and perception of another sense. A neurological phenomenon known as synaesthesia, where the stimulation of a specific sense leads to the automatic experience and sensation of another sense as stated by Weiser (2016), for example visualizing an odor or painting with smell stimulation.

Colors are electromagnetic waves in which each wavelength corresponds to a specific color, while odors are a chemical cocktail of gas molecules with an infinite possibility for combinations. The colors can be studied based on the wavelengths and its interaction with the receptor in the eyes but also on the neural activity pattern in the human brain that Conway (2020) describes as “the brain's pantone”. Vision is processed in the occipital lobe, where stimulus that comes from the physical world such as the wavelengths are translated into neurosignals and interpreted which allows for a color recognition and given spatial and temporal features. Olfaction has a unique sensorial path from the other senses because once the chemical stimulus of the odors reaches the olfactory bulb this information is transformed into neurosignals that goes directly to the limbic system that includes the amygdala and the hippocampus that are involved in the behavioral and emotional responses as well as memory function. This gives olfaction a unique relation with memory due to the brain's anatomy and binding properties and associations as Walsh (2020) explained.

On one hand, does odor have the neural ability to modulate the perception of visual images and therefore of colors? Even though olfactory modulation of vision is not yet fully understood by neuronal studies, researches about the topic have taken into consideration event-related analysis and visual priming to analyze the neural responses towards visual objects that are associated with a specific odor. It has been forecasted that when the frontal cortex receives simultaneous visual and olfactory signals, the selective attention and cognitive load would be primarily given to the sense of vision and olfactory inputs may not be attractive or engaging enough to modulate vision as stated by Tamura, Hamakawa, and Okamoto (2018).

Olfactory inputs can modulate visual information that is stored in the memory via the limbic system as explained in the research by Tamura, Hamakawa, and Okamoto (2018) where the hypothesis assumed an ability of odor to modulate the color information that is stored in the working memory and that its associated with the odor input. The results of a study reveal that there is an olfactory modulation of colors in the working memory but that not all the odors will support and modulate the working memory of a certain color, for example, the orange color memory characteristic was lowered by the citrus-like smell while with the decanal odor was notably modulated.

On the other hand, several researches as the one by Gottfried and Dolan (2003) and Luisa Demattè, Sanabria, and Spence (2006), have shown that visual information as colors have a strong influence in odor perception; but behavioral results and neuroimaging studies have shown that the simple presentation of a visual input as for example color patches isn't enough to modulate olfactory perception. Semantically equivalent associations between colors and odors are necessary to be able to generate a modulation within the olfactory perception which for example will enhance the odor identification to be faster and accurate. On the contrary, when there is conflicting or incongruence signals coming from the nose and eyes into the brain, visual information can nullify olfactory information by neural suppression as mentioned in Tamura, Hamakawa, and Okamoto (2018).

The neurophysiological foundations of how visual inputs as colors modulates odor perception are explored in the study by Osterbauer et al. (2005), through functional magnetic resonance imaging (fMRI). The left insular cortex, the right OFC and the piriform/amygdaloid regions, all areas of the

limbic system are activated and stimulated by odors in isolation. These regions are sensitive to the perceived associations between specific odors and colors, where there was also an activation in the orbito- frontal and insular cortices, also regions of the limbic system. These neuroimaging data support the theory that color has the ability to modulate odor perception at a very late stage of the olfactory process as stated by Osterbauer et al. (2005), in several aspects including:

- Influence of color on odor identification: even when common odors like coffee, leather, or pine saw dust are presented without visual input, only around a third to half of them are accurately identified as mentioned in Desor and Beauchamp (1974) and Engen and Ross (1973). Color, in particular, can aid or hinder olfactory recognition (e.g., Davis (1981); Zellner, Bartoli, and Eckard (1991)). When the color of the odorant cannot be observed or is incorrect, we are slower and less accurate in detecting it. As a result, it is easier for us to recognize a solution as lemon if it is yellow rather than red or clear (in terms of both accuracy and speed).
- Influence of color on odor discrimination: Stevenson and Oaten (2008) conducted the sole study to look into the effect of color on olfactory discrimination. They used a triangle test to measure discrimination, which exposes a subject with three odor samples, two of which are identical. They discovered that when all of the odor samples were wrongly colored (e.g., green for cherry and strawberry odors), there were more errors in identifying two odors than when the odorous solutions were either colorless or suitably colored. The findings show that receiving the inaccurate label changes olfactory perception.
- Influence of color on odor Intensity: there is data to support that color activates an odor image, resulting in the generation of an odor percept, which, when paired with the odor being smelled, raises the perceived intensity of the odor. Water, the most commonly used odorless solution, is colorless. As a result, color-containing solutions are frequently mistaken for having an odor, even when they don't. Darker colors marginally increase the perceived strength of odorous solutions over lighter colors as explained by Dubose, Cardello, and Maller (1980) and Zellner and Whitten (1999). For example, a darker green wintergreen solution was deemed to be more intense than a lighter green solution. Similarly, the intensity of a cake's lemon smell intensified as the yellow color of the cake increased.
- Influence of color on odor pleasantness: if color elicits conditioned olfactory perceptions, the pleasantness of scents may therefore change. Odorous solutions that have been colored incorrectly, in instance, may be seen as less pleasant than odorous solutions that have been adequately colored as mentioned in Zellner (2013). It was discovered that this is correct. For example, purple grape odor is preferred than yellow grape odor according to Zellner, Bartoli, and Eckard (1991). When a solution is colored incorrectly, it may lose its pleasantness because the color-induced odor percept interacts with the actual odor, creating an unpleasant combination.

### **Cross-cultural color-odor associations**

Color-odor cross-modal associations are influenced by culture, and they are most likely formed by experience. Using the same set of 14 odors and asking participants to make congruent and incongruent color choices for each odor, a recent study by Levitan et al. (2014) investigated this question by testing color-odor correspondences in six different cultural groups (Dutch, Netherlands-residing-Chinese, German, Malay, Malaysian- Chinese, and US residents). Within each culture,

consistent patterns in color choices for each odor were discovered, indicating that participants were matching colors to odors in a non-random manner.

The researchers utilized representational dissimilarity analysis to look for differences in the patterns of color-odor correlations between cultures as shown in (fig.1) and discovered that the US and German individuals had the most comparable patterns, followed by German and Malay participants. The most significant differences were seen between Malay and Netherlands-based Chinese participants, as well as between Dutch and Malaysian-based Chinese participants. These disparities could be attributed to dietary habits, the importance of fragrance in each society, or other societal variables. The cross-cultural findings show that color-odor connections differ among cultures, despite being rather stable within a culture.

Figure 1: Color congruency for each odor in each culture. Colors per odorant per country are ordered by frequency (most frequent are shown lowest on their respective y-axis). Frequency is represented by the height of each color box; the box on the right of the figure shows the height a given box must be for there to be 10, 9, 8 etc. ratings of that color for a given odorant. Image by Levitan et al. (2014).

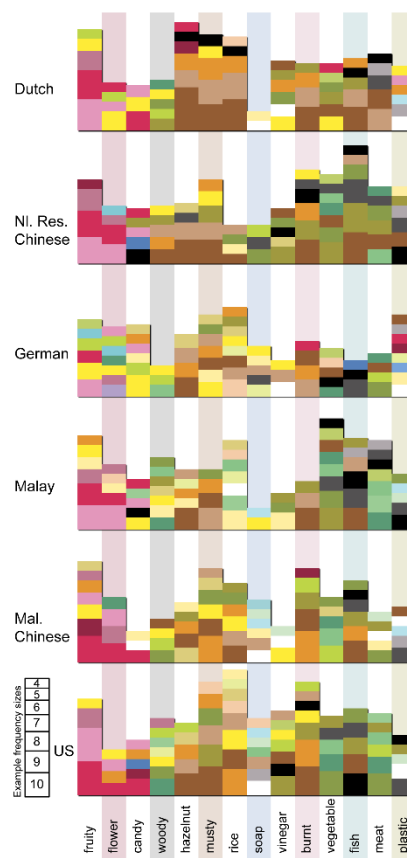

### Color\_based olfactory design in the space

The relationship between odors and colors started from the vernacular and traditional architecture, which has always used natural pigments to paint walls, oils and waxes to treat surfaces and fixing techniques mixing animal and natural substances with mortar, so colored materials with their own odor that impregnated the environments making them naturally fragrant, stated by Haverkamp (2013).

Examples of this combination color/odor can be found in the traditional architecture of every continent, such as indigo which, in addition to its typical color, has an odor that immediately recalls Indian architecture, or the white of lime whose odor is an icon of the olfactory landscape of the Mediterranean, or the black tar and red tints derived from flavonoids of Mesoamerican architecture and the resins of Egyptian architecture.

Places have always been theaters of synesthetic experiences between colors and smells, through the media of materials (especially natural materials and animals), but also of the air and its qualities. It is a multi-scalar relationship that involves culture and history, but also territories, environment, in which the materials -present in the various areas of the world- incorporated identities of entire populations as expressed by Barbara and Perliss (2006).

A project developed a few years ago by Barbara (2012), was focused on the idea to connect the chromatic qualities of the pigments, used to color the yarns of a carpet, with the olfactory qualities. The carpet, made by the women of the Jordan Foundation River (Jordan), had used spices, flowers and berries to obtain colors that gave particular bright hues. From these, the same substances have been diluted and inserted into a fringe of small pipes, to crown the carpet as an extra invisible three-dimensional olfactory decoration.

This work wanted to be a manifesto of the indissoluble relationship between colors and odors in the representation of a visible/invisible decoration. It has been placed on the way of studio Azzurro

(2002)'s explorations of the Mediterranean Sea and region, whose colors/odors were the epiphanies of the wind/light relationship in that area of the world where has to be considered sensorially unique.

It is precisely the geographical dimension in architecture that consolidates this relationship also in Peter Zumthor's works on the identity of the Swiss Alps region, where smells and colors merge through the wood resin, which indissolubly unites the smell of woods with the different coloration and seasoning, as happened in the Swiss Pavilion at the Expo in Hannover in 2000 as stated in Zumthor (2003). But also, in the Museum of Xiangjiao Liquor Factory at Shaoyang in China by Senselab where the smell and/or color are a measure of the state of aging of the liquor as described by Molinari and Visini (2020) or in the Ricola Factory by Herzog and de Meuron (2015) where an entire wall is made of production waste of balsamic herbs that therefore give the facades distinctive smell and color.

In addition to the "natural" relationship with places, there is also an artificial one, almost subliminal, which began with the provocations of Marti Guixé with the installation Pharma Food (2002) in which the colored and scented air wanted to sublimate the experience of nourishment (of evident Futurist inspiration). This line of research is radicalized with the experiments of Philippe Rahm and Jean Decoster as The Placebo Paint © that qualified psychologically the spaces beyond any visual or plastic representation. By incorporating an infinitesimal amount of ginger or orange blossom into industrial white paint, the designers seek to designate the intended purpose of a room outside the realm of any representation. It is their ambition to act on a pre-sensory level, to create a sort of infra functionalist architecture, generating its forms within the neurological and endocrine space of the body. The orange blossom floor will be relaxing. The ginger floor will be charged with eroticism as mentioned in Rahm et al. (2002).

## **CONCLUSION**

This ancient relationship between "osmic" and chromatic qualities is still to be explored. Studies about olfaction and its connections with other senses are recent, they date back to 2004, when Richard Axel and Linda Buck, received the Nobel Prize for Medicine for their studies about olfaction. From there, other disciplines have begun to deal with it and the construction of a design-oriented scientific method is just at the beginning. Research on the synesthetic relationship between smell and color and their impact on spaces is recent and still extremely pioneering. However, the awareness of the importance of the quality of the air we breathe, also due to the recent pandemic, will certainly have a fundamental impact on the development in the next years to come of a synesthetic culture that will involve the sense of smell in the design qualities of spaces where to live.

## **REFERENCES**

- Azzurro, Studio. 2002. "Meditazioni. Mediterraneo." (Silvana edizioni).
- Barbara, A. 2012. "Scent of Jordan" *in collaboration with Jordan River Foundation, Milan, Italy.*
- Barbara, A., and A. Perliss. 2006. *Invisible architecture: experiencing places through the sense of smell.* Milano: Skira.
- Conway, B. 2020. "A New Study About Color Tries to Decode 'The Brain's Pantone'." <https://www.wired.com/story/a-new-study-about-color-tries-to-decode-the-brains-pantone/>.
- Davis, R. G. 1981. "The role of nonolfactory context cues in odor identification." *Perception & Psychophysics* 30 (1): 83-89. doi: 10.3758/BF03206139.
- Desor, J. A., and G. K. Beauchamp. 1974. "The human capacity to transmit olfactory information." *Perception & Psychophysics* 16(3): 551-556. doi: 10.3758/BF03198586.

- Dubose, C. N., A. V. Cardello, and O. Maller. 1980. "Effects of Colorants and Flavorants on Identification, Perceived Flavor Intensity, and Hedonic Quality of Fruit-Flavored Beverages and Cake." *Journal of Food Science* 45(5): 1393-1399. doi: <https://doi.org/10.1111/j.1365-2621.1980.tb06562.x>.
- Engen, T., and B. M. Ross. 1973. "Long-term memory of odors with and without verbal descriptions." *Journal of Experimental Psychology* 100 (2):221-227. doi: 10.1037/h0035492.
- Gottfried, J. A., and R. J. Dolan. 2003. "The nose smells what the eye sees: crossmodal visual facilitation of human olfactory perception." *Neuron* 39(2): 375-86. doi: 10.1016/s0896-6273(03)00392-1.
- Haverkamp, M. 2013. "Synesthetic design : handbook for a multisensory approach."
- Luisa Demattè, M., D. Sanabria, and C. Spence. 2006. "Cross-modal associations between odors and colors." *Chem Senses* 31(6): 531-8. doi: 10.1093/chemse/bjj057.
- Molinari, L., and A. Visini. 2020. *The World Winery Collection: Innovative Design, Sustainability and the Landscape*: Forma Edizioni.
- Osterbauer, R. A., P. M. Matthews, M. Jenkinson, C. F. Beckmann, P. C. Hansen, and G. A. Calvert. 2005. "Color of scents: chromatic stimuli modulate odor responses in the human brain." *J Neurophysiol* 93 (6):3434-41. doi: 10.1152/jn.00555.2004.
- Peleteiro, Silvia. 2016. "How Our Senses Interact The Concept of Cross-modality."
- Rahm, P., J.-G. Décosterd, Schweiz, Kultur Bundesamt für, and Exhibition International Architecture. 2002. *Décosterd & Rahm: physiological architecture = architecture physiologique*. Basel: Birkhäuser.
- Stevenson, R. J., and M. Oaten. 2008. "The effect of appropriate and inappropriate stimulus color on odor discrimination." *Perception & Psychophysics* 70(4): 640-646. doi: 10.3758/PP.70.4.640.
- Tamura, K., M. Hamakawa, and T. Okamoto. 2018. "Olfactory modulation of colour working memory: How does citrus-like smell influence the memory of orange colour?" *PloS one* 13(9):e0203876-e0203876. doi: 10.1371/journal.pone.0203876.
- Walsh, C. 2020. "What the nose knows." *The Harvard Gazette* <https://news.harvard.edu/gazette/story/2020/02/how-scent-emotion-and-memory-are-intertwined-and-exploited/>.
- Weiser, H. 2016. "The Color of Smell: A cross-modal interactive installation for individual expression." Independent thesis Advanced level (degree of Master (One Year)) Student thesis, Malmö högskola/Kultur och samhälle.
- Zellner, D. A., A. M. Bartoli, and R. Eckard. 1991. "Influence of color on odor identification and liking ratings." *Am J Psychol* 104(4): 547-61.
- Zellner, D. A. 2013. "Color–Odor Interactions: A Review and Model." *Chemosensory Perception* 6(4): 155-169. doi: 10.1007/s12078-013-9154-z.
- Zellner, D. A., and L.A. Whitten. 1999. "The Effect of Color Intensity and Appropriateness on Color-Induced Odor Enhancement." *The American Journal of Psychology* 112(4): 585-604. doi: 10.2307/1423652.
- Zumthor, P. 2003. "Atmosphere, Path to Architecture."

# The role of colour designers in the design process

Gyeonghwa Lee <sup>1,\*</sup>, Vien Cheung <sup>1</sup> and Tang Tang <sup>1</sup>

<sup>1</sup> School of Design, University of Leeds, Leeds, United Kingdom; ml13g3l@leeds.ac.uk,  
T.L.V.Cheung@leeds.ac.uk, T.X.Tang@leeds.ac.uk

\* Corresponding author: ml13g3l@leeds.ac.uk

## Abstract

The purpose of this study is to offer an understanding and knowledge about the role of colour designers in the design process (particularly paint industry), and to discuss the required attributes and skills of colour designers in each stage of the design process. In order to achieve the goals of the research, a qualitative autoethnography was conducted based on five years of experience gained by one of the authors as a colour designer in paint companies. The experience was described in line with five-stages for a colour design framework based on the idea of general tendencies in the problem-solving process. This research provides a deeper understanding and knowledge about the work of colour designers in the practical design environment, as well as providing a clear colour design framework based on the practical activities of colour designers. The research is expected also to increase awareness of the roles of colour designers in our society. Increased awareness may lead designers to enter the colour design area and engage in colour design research.

**Keywords:** *Colourist, CMF, Colour design process, Colour designer, Paint colour*

## INTRODUCTION

Design is a creative problem-solving activity aimed at changing existing situation into preferred ones (Simon, 1969). Designers are expected to engage in problem-solving activities regardless of their area of design. In the field of design, most studies into problem-solving activities, which explore how designers think and work at each stage of the design process, have tended to ignore colour design. Instead they focus on design traditions such as industrial/engineering design (Goldschmidt and Rodgers 2013), architecture (Casakin and Goldschmidt 1999), instructional design (Ertmer et al. 2009), and so on. There are several reasons for this. Firstly, colour design is a relatively new area compared to other design traditions. In addition to this, in the design industry, there is an incorrect belief that any type of designer is capable of dealing with colour. Therefore, it is still common for an in-house designer to undertake responsibilities for colour regardless of their domain area. The low numbers of colour designers in the design industry may, in turn, explain the relative lack of research focusing particularly on colour designers.

There is little research in terms of the roles of colour designers in the colour design process, which can cause confusion especially for early career designers while creating colours. The aim of this study is to provide a deeper understanding of the roles of designers in the colour design industry, (especially in paint companies) in line with a five-step colour design framework which has been developed based on the problem-solving process. The aim is also to discuss the attributes and skills needed by designers at each stage of the colour design process.

## RESEARCH METHODOLOGY

### Qualitative Autoethnography

A qualitative autoethnography method was used in this research. Autoethnography allows researchers to use self-reflection to attain cultural understanding (Pelias 2003). Under this research technique, personal narratives are used to give personal accounts of the experience of the individual researcher (Spry 2001). For this reason, one of the researchers was used as a research instrument in



this research. Thus, the research was written based on five-years of experience as a colour designer gained by one of the authors, Lee, in the South Korean paint industry. This research, thus, reflects on the South Korean design culture where paint companies provide colours for external clients.

### **A Five-step Colour Design Framework**

Problem-solving models or approaches vary. This has been explored within diverse areas of scholarship including design but also psychology, engineering, education, marketing and management, and mathematics, among others. Although several design scholars (Table 1) suggest a range of problem-solving models and processes, these can be generalised into five-stages of an iterative process: (1) problem identification, (2) data collection and analysis, (3) development of a project plan, (4) creation of models/prototypes, and (5) testing and evaluation.

In this paper, we suggest five steps for a problem-solving framework (Table 1) in colour design. This is based on the five generalised stages mentioned above, and Lee's professional experience as a colour designer within the colour design industry, specifically in paint companies. Although application and evaluation of colours is also an essential part of the colour design process, these are not included in this research. This is because in the colour design industry, clients of colour designers select and apply colours (provided by colour designers) into their mock-up products. These colours are likely to be evaluated by the clients themselves. If clients have further requirements for the revision of colours, they tend to contact colour designers or related departments subsequently. The colour design process is generally iterative and non-linear. However, our reason for suggesting the five steps of the colour design framework is to build up a systematic narrative structure based on them. Therefore, this allows us to explore the work of colour designers, in terms of what they do and how they work.

Nini (1995)	Zande (2006)	Sancar-Tokmak and Dogusoy (2020)	Five-steps of colour design framework
Identification of a problem	Define the problem	Define the problem	1. Consulting clients
Gathering and analysis of information	Investigate and research to gather data	Discuss possible reasons	2. Gathering information and visualisation of ideas
Development of a plan	Generate ideas	Select a reason and define alternative solutions	3. Development of colour design plan
Designing a solution	Select the criteria for success	Plan design, development and implementation	4. Creation of colours
Evaluating the solution	Determine the work plan	Plan evaluation	5. Presentation of colours
Producing and introducing the solution	Make the model prototype or drawing	Report possible results/restart the process	-
Evaluating responses to the solution	Test the solution	-	
-	Evaluation	-	

Table 1: Problem-solving procedures put forward by various scholars, and the suggested five-step problem-solving framework for colour design proposed in the present research.

## **RESEARCH FINDINGS AND RESULTS**

### **Consulting Clients (Consideration of Three Major Factors)**

There are different groups of customers for colour designers. These are in-house product designers, engineers, salespeople, and so on. Different customers have different needs and expectations about colours in terms of applying colour into their products. Understanding the needs of customers is essential to provide successful colour design projects. There are three major factors that colour

designers need to keep in mind while consulting their clients: the size of the companies (large or small), types of products (automobiles, mobile phones, navigation products, bikes etc.), and characteristics of clients (designers or engineers, levels of work experience).

We offer some example scenarios here. Firstly, large companies have fewer financial restrictions on applying experimental colours provided by colour designers into their products to give inspiration to their own in-house designers. This kind of colour could be named Creative Inceptional Colours (CIC). In-house designers could be inspired by combinations of various objects with CIC which might lead to success for future design projects. However, the CIC are not likely to bring tangible business profits in general. Because of this, small companies may have financial restrictions on trying to apply the CIC into their mock-up products. Colour designers need to understand this situation in the design industry when consulting their clients. Secondly, different families of products require different levels of durability of colours for use in real-world products. Because of this, although colour designers work with engineer colourists and gain help from them while creating colours, they also need to have some knowledge of functional/technical aspects of colours to guide their clients. Lastly, designers as customer groups tend to emphasise aesthetic preference and values of colours compared to other groups of customers. In particular, this tendency is more pronounced in early career designer clients due to their lack of experience of using colours in products. For this reason, colour designers often need to convince them about why some colours cannot be used in their products.

In the consultation stage, colour designers need to consider the three factors discussed above to identify and meet the needs of clients and conduct successful colour design services for them. Thus, excellent communication skills and certain levels of knowledge about functional aspects of colours are required for colour designers in this stage of the colour design process.

### **Gathering Information and Visualisation of Ideas**

Gathering Information is intended to provide a basis for decision-making in the process of colour design. Information can be gathered in many different ways. One approach to gathering information is to utilise existing academic resources (journal articles, dissertations, and theses).



Figure 1: Creation of manual mood boards: existing colours and various objects can be used together.

In addition to this, colour designers collect colour information by themselves by going to retailers where products are on sale. Collection of brochures, talking to salespersons/individual customers in person, or investigation of displayed products in the market can be valuable sources for the collection of colour information. This can be outsourced also to research and development (R&D) companies specialised in design trends. The ability to gather, manage, and analyse colour

information is an important skill for colour designers. Based on information gathered from various sources mentioned above, designers often gain inspiration and ideas for colour design directions. However, this may be somewhat vague in this stage. To visualise their ideas, designers often create mood boards (either manually or digitally) or storytelling techniques (Figure 1). This allows designers to offer directions for customised and more concrete colour design plans. Designers' creativity plays a significant role at this stage. High levels of skill in using design programmes are essential for the visualisation of their ideas. Colour designers are expected to have skills in adjusting balance between different design elements (e.g., texture, surface, gloss, size of the object) and colours at this stage.

### Development of Colour Design Plan

On the basis of an understanding of the needs of clients, and ideas or inspiration gained through the previous stages of colour design, colour designers develop a colour design plan. The purpose of the colour design plan is to enhance the visual aesthetics of colour with combinations of texture, shape, gloss, and other elements, as well as providing a strong identity and positive impression from colours when the clients use colours in their products. The direction of colour design plans and selection of colours differs depending on whether colours are developed for unspecified or specified groups of clients or users. Figure 2 shows a proposed colour design plan called a 'Colour EQ' suggested for a Korean automobile company. It contains four sub-sections. This was planned based on the needs of the client and arose also from the data collection and idea visualisation stages.

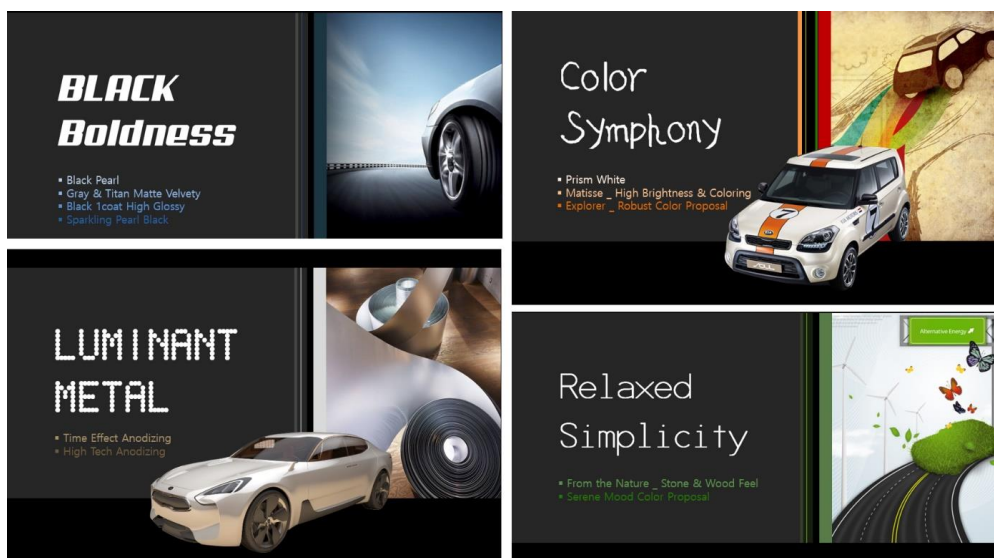

Figure 2: Colour design plan and its visualisation.

### Creation of Colours

The creation of colours can be divided into two broad categories: creative inceptional (or advanced) colours (CIC) mentioned above, and functional colours (FC). The purpose of the CIC approach is to provide insights to designers from a wide range of design areas to inspire them by presenting new colours based on understanding design megatrends and the expected future needs of customers. The CIC approach tends to occur prior to the FC, which will be described in detail shortly. Technical and functional aspects such as durability, and the cost of design tend to be ignored in the CIC approach of colour creation. This is because such aspects prevent colour designers from using their imagination to create new colours. The CIC approach is characterised as highly emotive, evocative, creative, and

associative. In this approach to colour design, designers also use their personal feelings, thought, stored memories, free association, and impression to make a conceptual plan for new colour creation. Figure 3 illustrates examples of CIC samples made using paint spray. Although colour designers lead this approach in colour design (by providing concepts and plans for colour design), colour samples are realised by chemists/technicians by creating hand sprays in a colour lab. Thus, communication skills with different departments and understanding of technical terms and aspects of colour are demanded of colour designers.

In contrast to CIC, the main purpose of colour creation within the approach of Functional Colour (FC) development is to offer colours for mass-produced consumer goods in real-life such as auto mobiles, digital gadgets, furniture, and others. The FC approach tends to progress rapidly compared with the CIC development. These colours rely on deductive reasoning based on logical, analytical, and mathematical calculation during the colour development to allow machine-spraying in the factory. Colour designers need to communicate with salespeople and technicians to adjust aesthetic values of colour against other aspects of colours such as durability and cost. This is because all these aspects need to be balanced against each other.

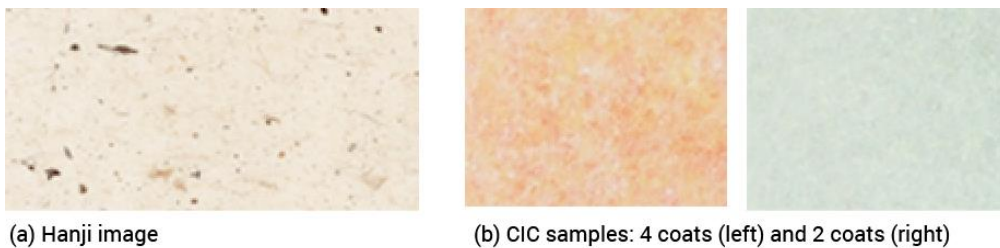

Figure 3: Creation of colour samples in CIC approach: (a) Hanji (traditional Korean paper) and (b) CIC samples created by hand spraying paint based on Hanji image.

### Presentation of Colours

Designers need to present colours to their clients both visually and verbally. Since multisensory expression is useful in the presentation of colour design, it is very helpful to utilise visual or aural materials during the presentation of colours.

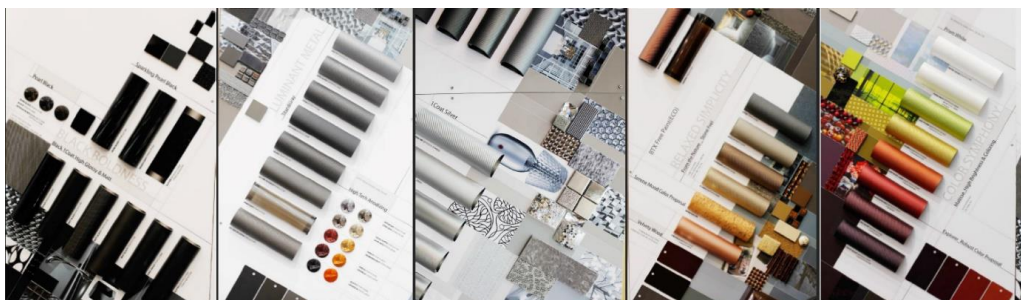

Figure 4: Examples of a display of functional colours proposed for an automobile company (3500x2100mm).

For the successful presentation of colours, the colour designer also needs to be well-acquainted with appropriate software. Also, speech and presentation skills are needed in this stage. If designers cannot explain colours and related concepts, their efforts may be underestimated, and the value of new colours may be neglected. Figure 4 shows newly developed functional colours displayed on a designed board created using Adobe Illustrator. Displaying images, various objects, and videos with



actual colour samples can engage the attention of clients. This can result in selection of colours by the clients enhancing the profits of the paint company.

### **CONCLUSIONS AND FUTURE WORK**

The work of colour designers has been described within a five-stage colour design framework based on the practical experience of one of the authors, Lee, in paint companies as a colour designer.

Overall, to carry out these five stages (see Table 1) colour designers are required to possess a range of skills. These are: (1) excellent communication skills, (2) data collection, management, and analysis skills, (3) visualisation skills using design programmes to turn intangible ideas and inspiration into the tangible, and (4) presentation skills to capture the attention of their clients, throughout the colour design process. Although five-stages of a colour design framework were described in this study, this may need to be subdivided in detail. Thus, further work is needed. The work of colour designers within a more detailed framework would provide more clear information and knowledge of colour designers roles in the colour design industry. A detailed colour design process needs to be set out using the results of in-depth interviews with large numbers of colour designers. This also would enhance the generalisation as well as reliability/validity of the research findings.

The results of this research offer deeper understanding and knowledge about the roles of colour designers in the practical colour design industry, as well as providing a clear colour design framework based on the practical activities of colour designers. From a wider perspective, the clear description of the work of colour designers during the colour design process and a detailed colour design framework will also increase awareness of the role of colour designers in our society not only among designers more broadly, but also for the general public. Increased awareness may lead designers and design students to enter the colour design area and engage in colour design research.

### **ACKNOWLEDGEMENTS**

This work was supported by the W.D. Wright Award from The Colour Group (Great Britain).

### **REFERENCES**

- Casakin, H., and G. Goldschmidt. 1999. Expertise and the use of visual analogy: implications for design education. *Design Studies* 20 (2): 153-175.
- Ertmer, P. A., D. A. Stepich, S. Flanagan, A. Kocaman-Karoglu, C. Reiner, L. Reyes, A. L., Santone, and S. Ushigusa. 2009. Impact of guidance on the problem-solving efforts of instructional design novices. *Performance Improvement Quarterly* 21 (4): 117-132.
- Goldschmidt, G., and P. A. Rodgers. 2013. The design thinking approaches of three different groups of designers based on self-reports. *Design Studies* 34(4): 454-471.
- Nini, P. 1995. What graphic designers say they do. *Information Design Journal* 8 (2): 181-188.
- Pelias, R. J. 2003. The Academic tourist: an autoethnography. *Qualitative Inquiry* 9 (3): 369-373.
- Sancar-Tokmak, H., and B. Dogusoy. 2020. Novices' instructional design problem-solving processes: second life as a problem-based learning environment. *Interactive Learning Environments* 1-14.
- Simon, H. A. 1969. *The sciences of the artificial* (1st ed.). Cambridge, MA: MIT Press.
- Spry, T. 2001. Performing autoethnography: an embodied methodological praxis. *Qualitative Inquiry* 7 (6): 706-732.
- Zande, R. 2006. The design process of problem solving. *Academic Exchange Quarterly* 10 (4): 150-154.

# Combinations of colours as an analogue model in Modern Art

Michel Albert-Vanel <sup>1,\*</sup>

<sup>1</sup> Honorary Professor at the ENSAD – Paris, Former Head of the Light at the Cité des Sciences de La Villette;  
albert-vanel@wanadoo.fr

\* Corresponding author: albert-vanel@wanadoo.fr

## Abstract

After many experiments carried out with the students of the ENSAD, it was possible to confirm the fact that the combinations of colours are reduced to only 22 fundamental sets. And the **Impressionists** were able to find a perfect place in these 22 categories.

The period of **Modern Painting**, from 1900 to 1950, prolongs this study by a transposition of colours, but also of forms. For half a century, these artists have been able to develop a revolutionary pictorial creation, which we could think developing ad infinitum...

But this is not the case, because we can show that these pictorial categories reduce to a sort of three-dimensional mandala, which is a closed universe where no formal innovation is possible!

And in the basis of this diagram, we can even detect the beginnings of a certain disarray about what will become **Contemporary Art**.

Is this the end of an art?

**Keywords:** *colour, multidimensional spaces, pictorial categories, classification, formal structures*

## INTRODUCTION

Professor **Mituo Kobayasi** was able to demonstrate that the Planetary Colour System is optimized, because it develops a combinatorics that opens out like a fan, and features the entire set of the NCS colours in combinations. This confirms its purely mathematical structure, and makes it a very powerful tool.

After many experiments carried out with the students of the **ENSAD**, it was possible to confirm the fact that the combinations of colours resume to only 22 fundamental sets, which can therefore play the role of an analogue model in multiple fields such as music, linguistics, health, architecture, painting, and the different currents of thought throughout the world...

### The Impressionists

To go further, I wanted to see if these transpositions worked as well with figurative images. For this purpose, I chose 22 paintings of the Impressionist era, which were able to match perfectly with the dominants of these 22 colour sets.

We were able to draw a series of 22 palettes of 42 boxes, representing the essentials of each of these paintings. This resulted in a virtual colour chart for the **Kéria** paints, and the possibility of processing colour combinations via the Internet, thereby eliminating the ancient colour charts on paper.

And this even results in a very operational system of classification of combinations of colours, allowing to compare schools and painters between them, to classify images such as logos, etc.

To close this study on the Impressionists, it is interesting to underline that the pointillism work of **Georges Seurat** coincided very exactly with the distribution of the **Autochrome** photos of the Lumière brothers in dotted lines of potato starch, thus freeing the painting from the concern of the representation of reality at the beginning of the 20th century. And this opened the door to multiple

innovations, leading painting to move away from the servile representation of visible reality, and move towards multiple transformations, and even attain abstraction.

### **Modern painting**

Following that, I had the curiosity to apply this structure of colour combinations to the form, in an analogical way. For this purpose, I chose 22 images representative of **Modern Painting**, still known as the “School of Paris”, which was the most innovative and liberated international model ever. And there was doubtlessly not in the history of art a period when the most extreme aesthetic tendencies were then confronted.

During the years 1900 to 1950, these artists were able to develop a revolutionary and fascinating pictorial creation. We see there the continuation of the great liberating adventure engendered by the Impressionists.

As colours can oppose as hot and cold, light and dark, shapes can also oppose or resemble each other, but on different bases. Thus the opposition is very symptomatic between the *Guernica* of **Pablo Picasso** representing essentially the form in black and white and the tragic, with the paintings of **Henri Matisse** representing the bright colour, and a certain *joie de vivre*.

It has been proposed here to transpose the colour structures into formal structures, according to the optical properties of the images revealing their hidden meanings. And it will be essentially from these meanings that the whole will be able to structure itself.

### **Formal research**

The strongest opposition will be between the **figurative** and the **abstract**, which will form the vertical axis of the diagram. Thus the somewhat naive **figuration** of **Henri Rousseau** using the *trompe-l'oeil* in a dream image, will oppose the relentless and ascetic **geometry** of **Piet Mondrian**.

This evidence will be followed by a more subtle opposition, on the horizontal axis representing, in semiological terms, the **denotative**, or what is signified, in opposition to the **connotative**, or what is suggested.

In this context, a strongly archetypal image in the form of a **sign**, by **Paul Klee** will be opposed to the **suggestive** one by **Fernand Léger**, making the forms almost palpable, with the search for depth and that of matter.

It is important to point out that the four cardinal points thus defined generate a space in the shape of a cross, which represents the unsurpassable limits.

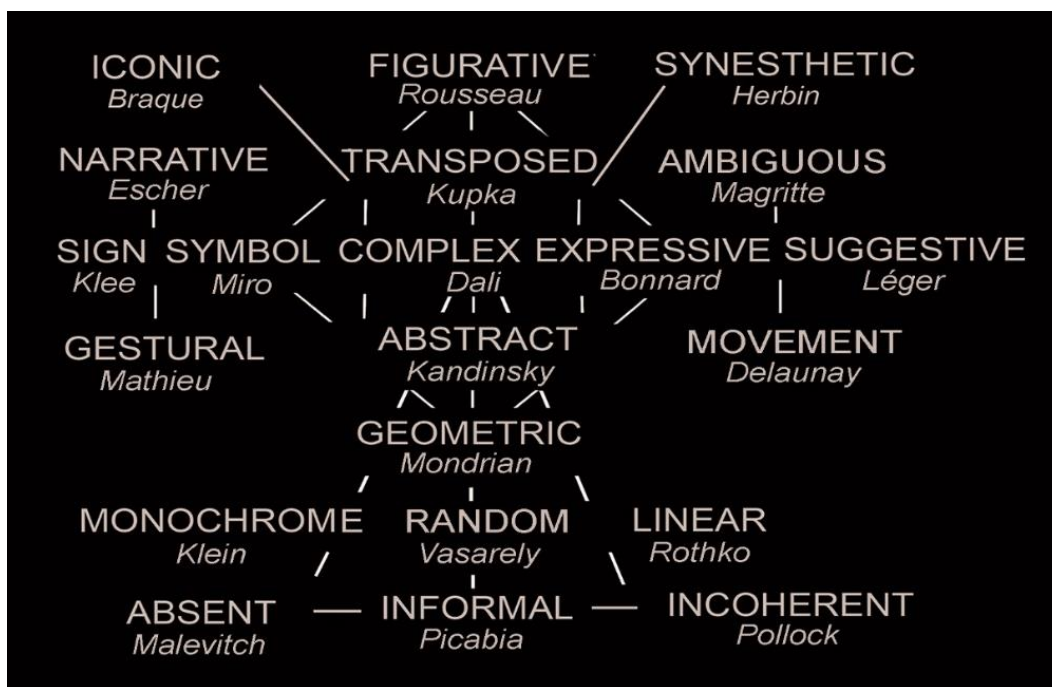

Figure 1: Signification in Modern Art.

Of course, we could have chosen other works, other painters, other terms to catalogue them, but the result would be the same.

Then we find a succession of intermediate paintings, revolving around a central point. There it will no longer be dealt so much with oppositions than with resemblance, proximity, mixing, and compromise...

Thus the **transposition** of **Franz Kupka** where the figurative and the abstract are juxtaposed, as it is shown very often. Likewise a painting by **Wassily Kandinsky**, where a face appears in profile among a network of lines, so that one can wonder whether abstraction is really possible without any figuration?

Then there will be the **narrative** of **Cornelis Escher** using mainly black and white drawing, to evoke space in a paradoxical way. And it will also be the **ambiguity** with **René Magritte** denouncing the trickery of images: the image of a pipe is not a pipe!

Likewise, we will notice the **symbol** with **Joan Miró** and its humorous profusion of various signs, playing with abstraction and figuration. And it will then be the **expressive** of **Pierre Bonnard** with his spatial suggestions, his evocations of light on the water of the sea, the clouds of the sky with its evanescent colours.

Below we will place the **gestural** of **Georges Mathieu**, reminiscent of oriental calligraphy, of which the outline of signs is accompanied by a movement of the wrist. As well as the **cosmology** of **Robert Delaunay** with the movements caused by the simultaneous contrast of colours.

Finally in the centre we will find a kind of very attractive marsh, representing **complexity** and **ambivalence** with **Salvador Dalí**. We will discover all these contradictory trends gathered in the same image, including the contradictory use of shapes and materials, such as soft watches...

But we should not forget either the transverse axes similar to those of Yellow/Blue and Green/Red, which are **the iconic** of **Georges Braque**, where as in the old orthodox icons, and in cubism, we do not represent what we see, but what we know about the object.



And the transcendence of the **synesthetic** by **Auguste Herbin**, which supposes a transposition of the different senses, such as the visual and the hearing, with the transcription of the music in colour...

All of this worked well during the fifty years of Modern Art, because there was something new and urgent to say.

So much so that it seemed this freedom could develop ad infinitum. But this is not the case, because we can show that these pictorial categories are opposed in pairs, like colours complementing each other, or come together in proximity, thus closing the circle.

And I myself had the great surprise to find that this was a closed and finite universe, in which there would be no any new plastic possibility. And it results that all the following pictorial creations would be, from the aesthetic point of view, only a variant of these previous creations.

This search for style, more than for content, seems to be the most important thing for these artists, because it is the place where their originality lies. This is all the more crucial since the philosopher **Abraham Moles** was able to state the fact that the ultimate criterion of aesthetics was based on originality...

We can therefore understand that most artists of **Contemporary Art** can be extremely distressed to learn that there is no longer any possible originality in this aesthetic field, nor any formal innovation, because everything has been tried, and everything has been said!

Another important observation about figuration and abstraction: The three major abstract artists, **Malevich**, **Mondrian**, and **Kandinsky**, were all followers of **Theosophy**. And one can fundamentally wonder whether for them, figuration did not represent only the appearances of things here below, from which it is advisable to stay apart, while abstraction represented spirituality and a new conception of society and of life, less centred on exclusively material problems?

### **Contemporary Art**

I remember that period of training, when as young artists we felt like we were going in circles, and we weren't sure why. But I can clearly see now that it is because we had nothing more to say...

Also, and although this may surprise and shock more than one, it seems to me that this perfectly explains the disarray of Contemporary Art which, after the fifties, could only subsist in the derisory, or provocation with the despair of not being able to renew itself.

The bottom of the diagram is similar to the catastrophe of colour sets, where black and white make us regret the bright colours at the top.

Because all this was foreseen in the days of Modern Painting, with the premonition of **Kazimir Malevich**, his radicalization causing him to replace the sacred icons with a simple black square, and resulting in **the absence**.

And in contrast to the tragic and desperate **informal** of **Jackson Pollock**, because reaching **confusion** in overload, because enough is enough!

We will also find the deafening silence of the optical art of **Victor Vasarely**, with the addition of **randomness**, as if the loss of meaning was not enough!

It will be the **informal** of **Francis Picabia**, and with the disrespectful and nihilistic humour of **Dadaism**.

There will remain the **blue monochrome** of **Yves Klein**, and the **linear one** of **Mark Rothko**, where colour finally finds its meaning, and can make believe in the arrival of an art escaping the form, and entirely based on colour... But unfortunately very few people seemed to care about!

Thus against the **coherent** rose window of **Modern Art**, will oppose the triangle of **inconsistency**, of **Contemporary Art**.

All of this naturally culminates in the symbolic murder of painting by **Luciano Fontana**, piercing the beloved canvas with his knife.

It was then that **Marcel Duchamp** was able to announce: « It seems painting is finished! », by proposing a urinal, his “Fountain” instead of a painting. This obviously caused a scandal, and the critics then said that Contemporary Art was nothing but an art of **Pissotière!**

And for lack of innovation, all that remains is to offer “**Cacas d’Artiste!**”

And it is obvious that all of this reflects a feeling of hopelessness.

But through the provocative gesture of Marcel Duchamp, we can also see more seriously the triumphant arrival of industrial objects such as airplanes, racing cars, space age rockets... which seem to downgrade painting to the rank of works of the past.

Moreover, **the Conceptual** tried to eradicate the material work, to replace it with its simple idea.

As a result, in France we have magnificent contemporary art museums in every major city. But they seem very empty, of both artists and visitors, because the curators only swear by **Marcel Duchamp**, so that most current artists cannot have access...

Is this the end of an art, the end of an era?

I think not, because the role of the image remains essential, and it needs to find a new breathing, to just celebrate the wonders of Creation, such as **Hans Hartung’s** cosmologies, or the dotted humour of **Roy Lichtenstein**.

## **REFERENCES**

Albert-Vanel, M. 2016. *Système Planétaire des Couleurs*, 228 p., Paris: Color Messenger.

Kira, A. 1953. *Peinture Moderne*, 340 p., Paris: Skira.

Musée d’Orsay. 2003. *Aux origines de l’abstraction*, Paris: Réunion des Musées Nationaux.

Lucie-Smith, E. 1996. *L’art d’aujourd’hui*, 360 p., Paris: Booking International.

Moles, A. 1972. *Théorie de l’information et perception esthétique*, 328 p., Paris: Denoël.

Sourjins, C. 2018. *Le mirage de l’Art Contemporain*, 215 p., Paris: Table Ronde.



# A mount-it-yourself 3D colour model for designers

Gisela Costa Pinheiro Monteiro <sup>1,\*</sup> and Robert Hirschler <sup>2</sup>

<sup>1</sup> Universidade Federal Fluminense, Brazil; giselamonteiro@id.uff.br

<sup>2</sup> Colour Consultant, Budapest, Hungary; robert@hirschler.hu

\* Corresponding author: giselamonteiro@id.uff.br

## Abstract

A three-dimensional model registered in Brazil named Colorcra<sup>®</sup> has been developed to help designers visualize colours and their relations. The model consists of a limited number, typically four or five, “cards” (sheets) corresponding to the (nearly) constant-hue pages of the colour order system it is supposed to represent. The system can be freely selected, in our paper we shall illustrate the model based on either the Munsell or the NCS<sup>®</sup> system. The structure of Colorcra<sup>®</sup> allows opposite pages (with complementary or opponent colours) to be easily assembled and disassembled, making it easier to visualise colour relations. On the model initially there are no colour swatches affixed, thus the designer or student can place the selected colour swatches into the required positions. Colorcra<sup>®</sup> has already favourably been tested, both in paper and in acrylic version, in an academic environment.

**Keywords:** *colour space, three-dimensional model, pattern cards, design, colour education*

## INTRODUCTION

Designers regularly face the challenge of having to create coloured objects; be they a piece of dyed or printed textile, a plastic toy, or a sports car (Hirschler 2010; Monteiro and Silva 2020). First the colour or colour combination is brought to the designer’s mind. These may be called abstract colours. Then comes the tricky part: realising this colour or these colours on the computer screen or on a sheet of paper; that will be the first version of the materialised colour which the designer will keep modifying until the perceived colour matches as well as possible the imagined colour. It is a daunting task for designers to turn imagined colours into reality, and pattern cards (shade cards), colour collections or colour order systems can be of invaluable help in the process – provided the designer is familiar with these tools. The final step is up to the colourist or colour engineer: reproducing the designer’s colour in the material of the final object – textile, plastic, metal etc.

Catalogues or pattern cards (shade cards) are collections of a few dozen-coloured swatches, very often made of the same material of the final product. They are fundamental in the communication between supplier and buyer, but also very often they are the inspiration for the designer to select the colours to be used in the design or the design variations (colourways). The main problem of these catalogues is that they display the colours either in a single one-dimensional sequence or they are arranged in two dimensions, and this does not help the visualisation of the colours to be selected, even less so that of the relationships between the selected colours. Physical examples (atlases, models) of three-dimensional colour systems (Munsell and NCS<sup>®</sup><sup>1</sup>, the two most popular ones) are well known, but they can be expensive and may not be available in the desired material or in the designer’s required medium.

---

<sup>1</sup> NCS - Natural Colour System<sup>®</sup> property of and used on licence from NCS Colour AB, Stockholm 2021. References to NCS<sup>®</sup> in this publication are used with permission from the NCS Colour AB.

## **HOW COLORCRIA® WAS CREATED?**

Colorcra<sup>®</sup> was born out of the necessity for designers to easily comprehend the three-dimensional nature of colour (Monteiro 2018). The basic structure was created seeing how cradle packaging separated wine bottles into some types of boxes. In general, these cradles are made up of cardboard strips with semi-cuts that fit perpendicularly to other strips, forming niches in which the bottles are placed, thus avoiding friction between one another. Looking specifically at one of the cross-shaped intersections, it was possible to make a parallel with the “central axis” of the Munsell Colour Tree. The advantage would be that in this way each card contains a pair of complementary or opponent colours. It was then that the idea to place more partitions on this same axis came up.

These dividers have cut-outs to facilitate fitting, avoiding glue or staples (making the process cheaper, ideal for making the idea feasible). In this case, more cardboard using the same axis was fitted. So, we set up on four or five cards complementary or opponent pair of colour pages, making central cuts, to create an axis. During this process, a series of fittings were tested. Figure 1 (left) shows the first mock-up made with wine cardboard. The initial idea was to make a tree using only six colours: RGB and CMY because it was considered simpler. But, when tested, it did not work well, as there were huge gaps between some colours, such as the orange colour which should be a necessary transition between the red and yellow colours. Hence, it was found better to follow the structure of either Munsell or NCS<sup>®</sup>, but any other well-known and accepted colour model will do. After that, a new tree was assembled, this time with ten colour pages (Figure 1 - right).



Figure 1: Mock-up version (left), made with wine box card and 3 cards (6 key colours).  
Second version (right), made with white paper 180 g/m<sup>2</sup>, and 5 cards (10 key colours).

## **EXPLAINING COLOUR ORDER**

For the designers (students) to understand the basic principles of organising colours in three dimensions some well-known colour order systems may be used as examples. In our case we are using both the Munsell (ASTM 2018; Munsell 2021) and the NCS<sup>®</sup> (Hård and Sivik 1981; Färginstitutet 2007) systems to teach the three dimensions of colour: Hue, Value and Chroma for the Munsell system and hue, chromaticness and blackness for NCS<sup>®</sup>.

To make visualising the three dimensions of perceived colour easier we use simplified charts as illustrated in Figures 2 and 3.

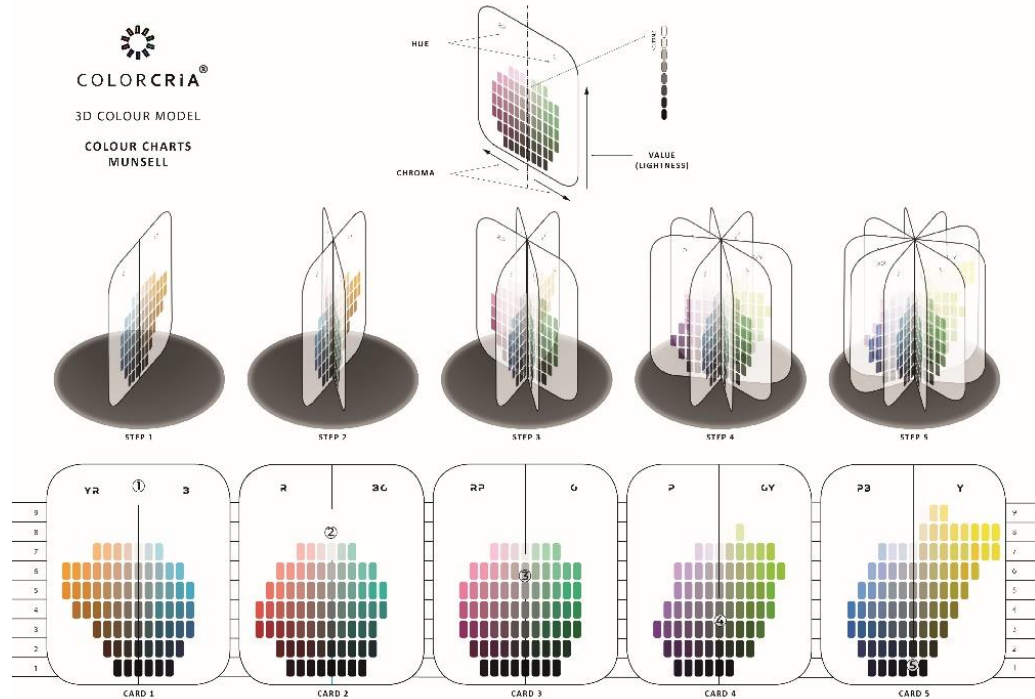

Figure 2: Illustration of the Munsell system with the Colorcra® model. Top line: single hue pages with complementary colours. Middle line: mounting of the Colorcra® model. Bottom line: the five constant hue planes (cards) of the Colorcra® model, showing the cutting lines enabling the assembly.

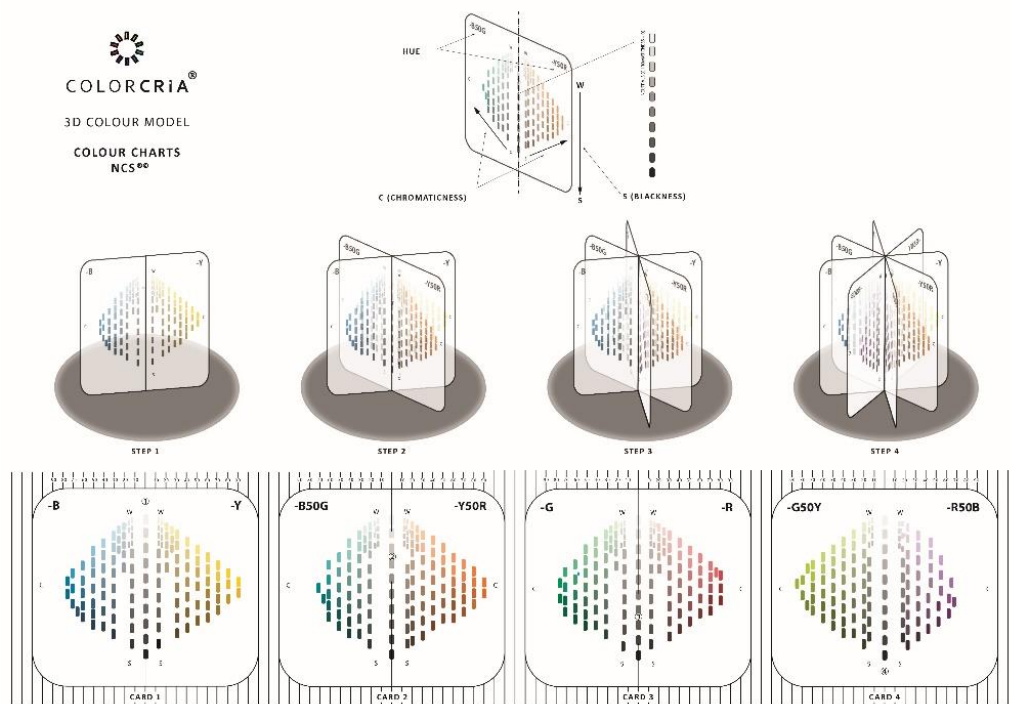

Figure 3: Illustration of the NCS® system with the Colorcra® model. Top line: single hue pages with two opponent colours. Middle line: mounting of the Colorcra® model. Bottom line: the four constant hue planes (cards) of the Colorcra® model.

The students learn the basic difference in the structures of Munsell and NCS<sup>®</sup>, particularly how the most colourful (highest chroma resp. maximum chromaticness) colours of different hues are not at the same lightness level in Munsell, but always at the 'equator' in NCS<sup>®</sup>. This is then explained in the 3D Colorcra<sup>®</sup> models (Figure 4.)

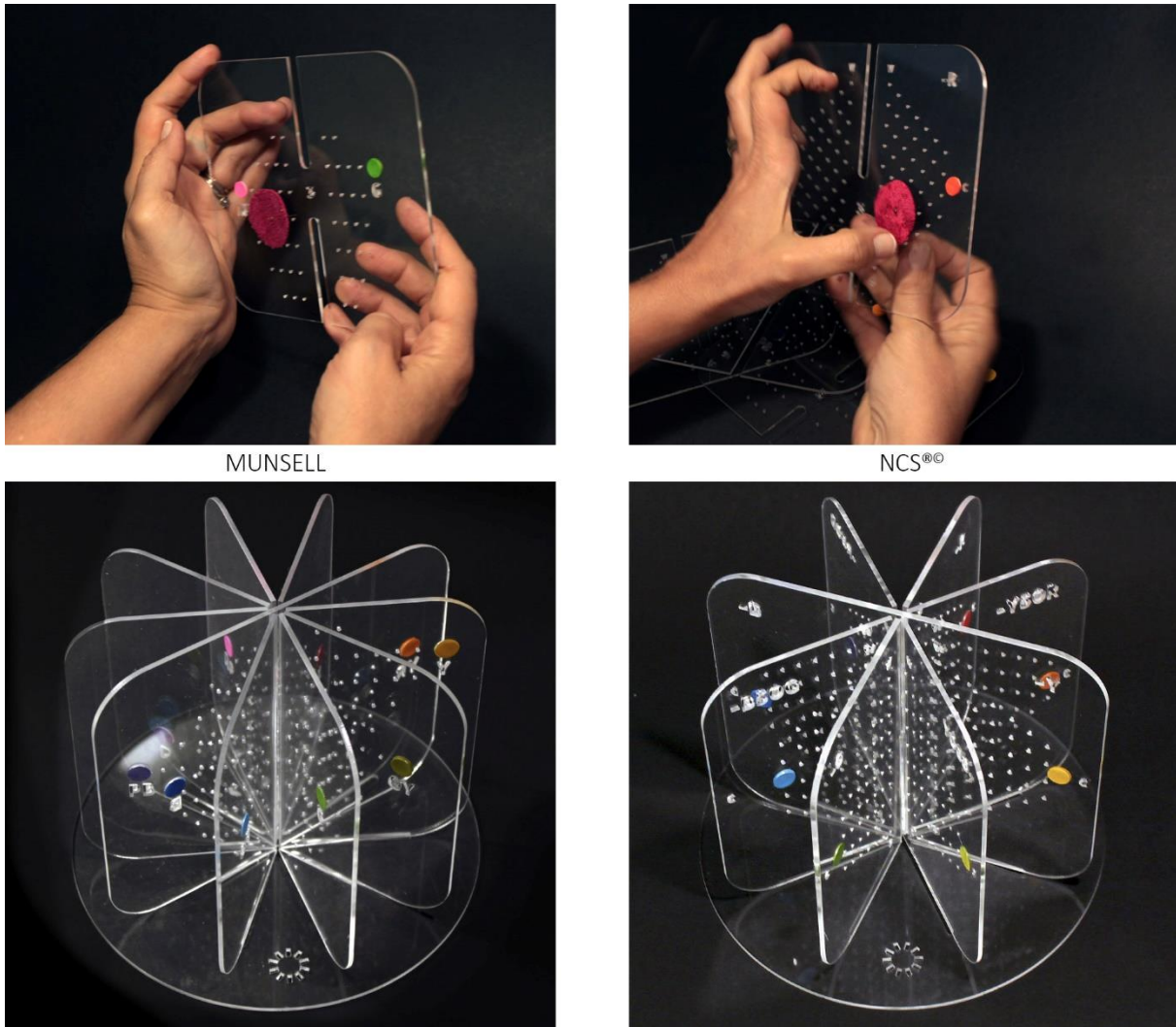

Figure 4: Single pages and mounted 3D Colorcra<sup>®</sup> models illustrating the Munsell (left) and the NCS<sup>®</sup> (right) spaces.

In addition to the systems discussed above, Colorcra<sup>®</sup> can be used to model any other three-dimensional colour system such as Ostwald or Coloroid.

### ***COLORCRIA<sup>®</sup> IN EDUCATION AND PRACTICE***

Colorcra<sup>®</sup> has already been favourably tested both in paper and in acrylic version in an on-line design course in Brazil. The students have received the templates in electronic format and printed out the blank Colorcra<sup>®</sup> sheets on paper while the professor illustrated the system and the process with the acrylic versions. The students had to extract the six representative colours of a popular design, position these on the constant hue charts (given the limitations of the system only approximately) and explain their relationships (Figure 5).



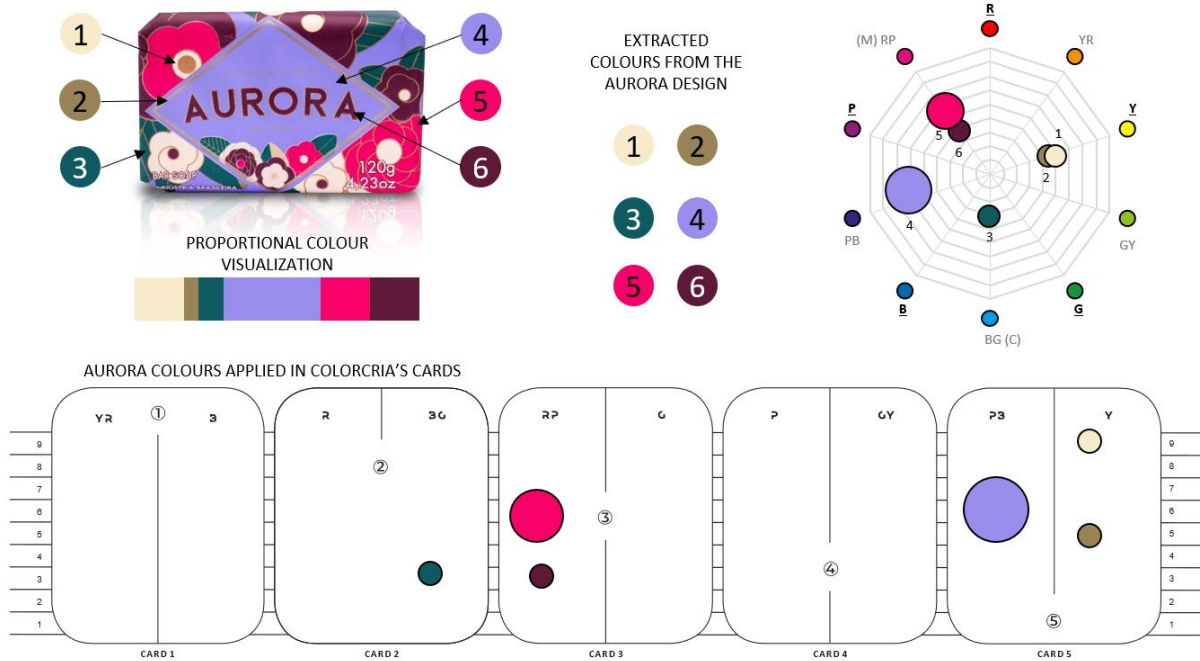

Figure 5: Positioning of six colours extracted from the “Aurora” design on constant hue planes and on a Hue/Chroma circular chart.

The objective of the exercise was for the students to understand and apply the concept of the three-dimensionality of colour. As opposed to the traditional colour circles in this exercise the Hue and Chroma dimensions had to be estimated on a horizontal cut of the Munsell colour space, and the Value and Chroma dimensions on one of the constant Hue charts. Previously the students had been made familiar with these concepts using the Munsell space as an example. Of course, the same exercise can be executed using the NCS<sup>®</sup> (or any other) colour space. Having understood the concepts, the students had to place their colour samples (be they in whatever material) on the Colorcra<sup>®</sup> model as illustrated in Figure 6 (on the next page).

**CONCLUSION**

Visualising colours in three dimensions (Figure 6) is not an easy task, yet it is fundamental in the creative design process. The traditional colour wheel (a.k.a. hue circle) is too simplistic and misleading, and the commercially available colour atlases do not lend themselves easily to interactive colour positioning in three dimensions. The newly developed Colorcra<sup>®</sup> model helps in better and more easily understand the relationship among a number of selected colours during the design process. Colorcra<sup>®</sup> is not a new colour system, but a tool which may be used in showing the relative positions of colour samples in any desired colour space. It is inexpensive and can be used in on-site and on-line colour courses as well as in the design practice.

**ACKNOWLEDGEMENTS**

The authors would like to thank Maggie Maggio for helpful comments and advise.



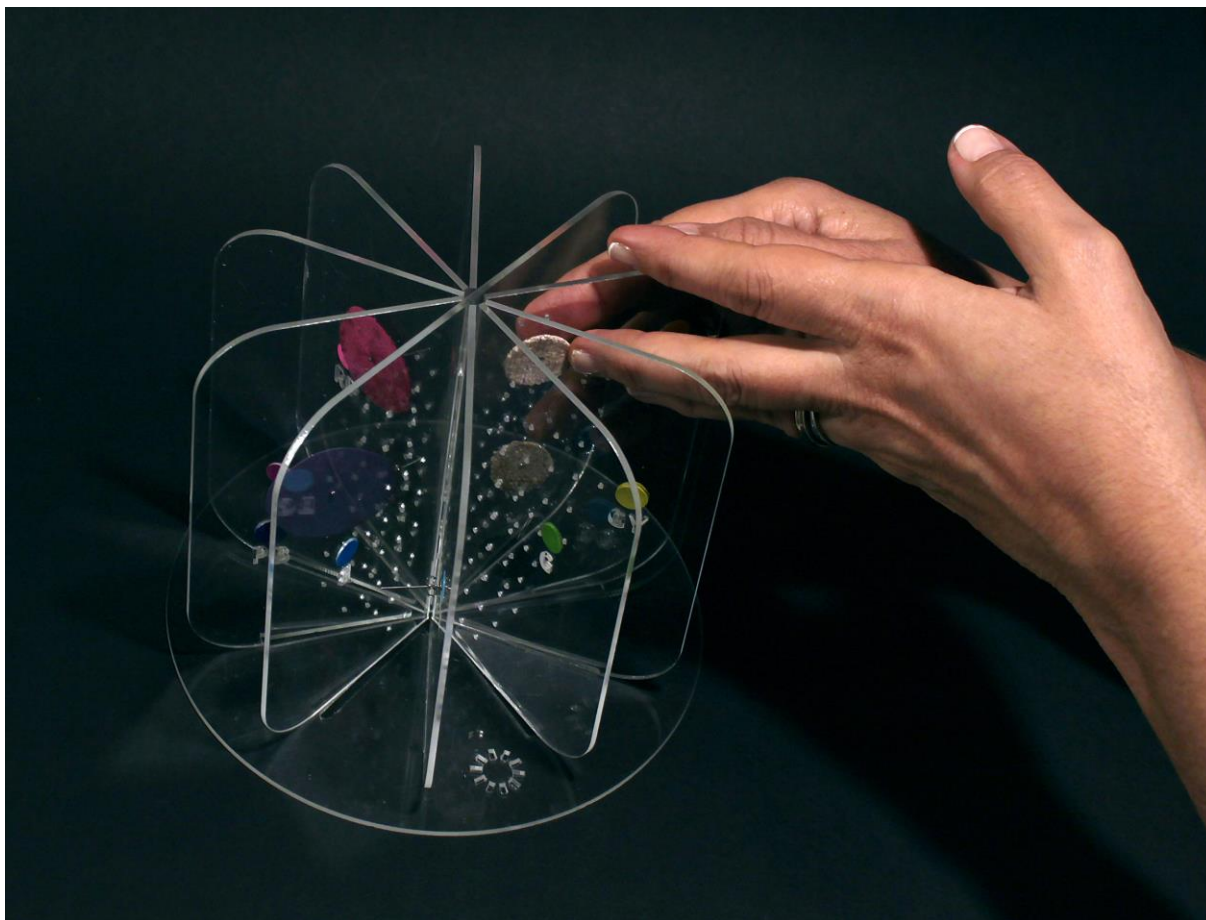

Figure 6: Positioning coloured samples onto the Colorcra<sup>®</sup> model.

## REFERENCES

- ASTM D1535-14 (2018), Standard Practice for Specifying Color by the Munsell System  
ASTM International, West Conshohocken, PA, 2018, [www.astm.org](http://www.astm.org)
- Färginstitutet Scandinavian Colour Institute AB. 2007. NCS Digital Atlas 1950.
- Hård, A., and L. Sivik. 1981. NCS-Natural Color System: A Swedish Standard for Color Notation.  
*Color Res. Appl.* 6: 129-138.
- Hirschler, R., 2010. *Colour communication in industry from design to product - with special emphasis on textiles*. in: COLOUR CODED. Parraman, C. (ed.), Bradford: Society of Dyers and Colourists, 263-273.
- Monteiro, G. C. P. 2018. *The designer as the person in charge to preserve brand identity throughout the production of fashion collections*. 2018. 445 p. Tese (Doutorado em Design) – Escola Superior de Desenho Industrial, Universidade do Estado do Rio de Janeiro, Rio de Janeiro.
- Monteiro, G. C. P., and C. A. P. Silva. 2020. *The selection of colours for fashion collections in relation to colour theory: a case study from the analysis of Brazilian ready-to-wear*. Proceedings, XVI CCdC CONFERENZA DEL COLORE 3-4 Settembre 2020, 198-205. Online:  
<https://www.gruppodelcolore.org/portfolio-articoli/bergamo-2020/?lang=en>
- Munsell Color Company. 2021. *About Munsell Color*.  
Online: <https://munsell.com/about-munsell-color/>

# The Colours of Individual and Collective Memory: Mnemosphere, a Visual Atlas of Memory, Emotions and Atmosphere of Places

Ingrid Calvo Ivanovic <sup>1,\*</sup>, Marta Elisa Cecchi <sup>1</sup>, Clorinda Sissi Galasso <sup>1</sup>, Ambra Borin <sup>1</sup>, Claudia Mastrantoni <sup>1</sup> and Martina Scagnoli <sup>1</sup>

<sup>1</sup> Politecnico di Milano, Italy - Design Department, ingrid.calvo@polimi.it, martaelisa.cecchi@polimi.it, clorindasissi.galasso@polimi.it, ambra.borin@polimi.it, claudia.mastrantoni@polimi.it, martina.scagnoli@polimi.it

\* Corresponding author: ingrid.calvo@polimi.it

## Abstract

This paper presents Mnemosphere, an interdisciplinary research project that investigates how the memory of places can be designed and communicated through experiential spaces capable of stimulating emotions. The research reflects on memory enhancement for the design of temporary exhibition spaces within the atmospheric dimension. It is approached with a particular focus on the topics of colour and emotions as one of the leading research axes. Through a visual research methodology, the project proposes the creation of 'emotional landscapes' related to the atmosphere and memory of places: rationed thematic atlases made up of images collected through a massive Open Call. The result is the translation of formal characteristics of the images (figurative, geometric, organic, abstract, among others) towards purely chromatic information by identifying the most recurrent hues of every atlas while paying particular attention to brightness and saturation, as these two colour properties are also fundamental for semantic purposes. The ultimate aim of the research is to define the morphological elements that represent the collective and individual memory in a system that could allow the further codification of parameters and guidelines for design practice.

**Keywords:** *colour semantics, colour and emotion, phenomenology of colour, memory of places, atmosphere, spatial design*

## INTRODUCTION

Memory and remembrance seem to be recurrent thoughts of our time, and therefore, the issue of memory has been addressed by different disciplines and approaches. According to Walter Benjamin (2003), memory is not a tool for exploring the past but rather a setting for it. We can preserve the emotional trace of what we experienced and trigger and convey memory through designed devices, such as images, objects, spaces, and artefacts. Hence, as the design discipline contributes to enhancing visual and material culture, it could help expand the horizon of memory studies. However, so far, this issue is still undefined and blurred. Considering 'the memory of places' as an active and dynamic concept, expanding its horizon until it enters into a design perspective is possible.

### The Mnemosphere Research Project

Mnemosphere is a research project funded by the public contest MiniFARB call of the Department of Design of Politecnico di Milano and involves PhD students and research fellows. Mnemosphere investigates how the memory of places can be activated through the atmospheric design of spaces. The project aims to dialogue between communication design for the territory and exhibition design in the atmospheric dimension, with particular emphasis on the translation of content into a system of parameters for the design and understanding of the constructed mnemonic space.

The research first proposed the articulation of a common lexicon regarding the 'memory of places', 'atmosphere of spaces' and 'atlas of emotions', among other related concepts. Then, the lexicon was shared as an open discussion by creating an *Open Call for Images* that invited artists, designers, photographers and other creative professionals to share their visual interpretation of the concepts. These actions aim to create a collective definition of Mnemosphere and a participatory visual atlas of

memory and atmosphere of places. This type of visual configuration echoes the *Mnemosyne Bilderatlas*, i.e. Mnemosyne figurative atlas, conceived by Aby Warburg in the late 1920s, consisting of a series of tables made up of photographic montages that are assembled according to different criteria. In the Mnemosyne Atlas, as in the Mnemosphere project, the arrangement of images placed side by side in such a way as to weave several thematic threads around specific themes creates 'fields of tension and provokes the viewer into an open interpretation process: the word to the image' -*zum Bild das Wort-* (Luav 2012). The research inquires for those founding threads of Mnemosphere, to open up to new experimentations from the variety of the images received during the Open Call and their designed juxtaposition: action that has been done with particular attention to the topics of colour, perception, emotions and the design of temporary spaces and services.

### **Colour and memory**

Colour is one of the fundamental elements in the design of the experience of space and memory. It functions as a powerful information channel to the human cognitive system and has been found to play a significant role in enhancing memory performance (Wichmann et al. 2002). Colours allow the physical nature of memory to emerge, which is first and foremost the result of the senses and perception and is therefore emotionally charged. Despite the usual representation of the past, memory and flashbacks scenes in the collective imagination of cinema (to name one of the most important examples of visual communication), which are generally depicted in black and white or sepia (earthy colours), researchers have shown that colour is encoded and stored in long-term memory (Hanna and Remington 1996). Additionally, studies have shown that memory recognition is more accurate for coloured than for black-and-white stimuli (Tanaka and Bunosky 1993; Wurm et al. 1993).

According to Birren (2006), colours have different emotional impacts and affect how people relate to space and memory by evoking individual and collective emotions and influencing people's behaviour and, therefore, their narrative. With all of the above, the research Mnemosphere inquires on this last issue, that is, how colours can help express inner moods to describe emotionally 'tinted' environments or atmospheres and arouse feelings in the mnemonic experience of places. When completing its research phases, the Mnemosphere project is expected to propose a series of colour guidelines to evoke or stimulate memory through the design of temporary exhibition spaces or services.

### **METHODOLOGY**

In *Mnemosphere's Open Call for Images*, more than 400 images were received among photographs, illustrations, artworks, and video. The Call was articulated by filling a form with images and text, stimulating the participants to reflect on the relationship between the lexicon words and colour. The result is a collective and participated visual archive, the Mnemosphere Atlas, in which emerges the power through which images and colours contribute to narrate personal and collective memories in the present time.

After the *Open Call for Images*, the research actions were dedicated to recognizing some common threads running through the collected images: shared morphological elements (colour and shape), recurring themes as nature, remembrance, architecture, blurred atmospheres or abstract approaches. The images were firstly organized and arranged by the research team, denoting the **spatial and atmospheric conformations** of the subjects and environments depicted and considering the

descriptions and concepts provided by the call participants. As a result of this, it was possible to define seven visual atlases presented in table 1.

Main Themes	Related Concepts	Morphological Elements (colour and shape)
AIR	air, wind, aperture, sky, flight, vastness, horizon, wingspan	openness, no borders, big long shots, low-angle shots, glance beyond
BUBBLE	focus, eyes, dimensions, habitat, fullness, closure	roundness, bubbles, nests, spheres, clear outlines inside out, focal point, light focus
DIAPHRAGM	filters, thresholds, constructs, entrances, views, portals	movement, sequences, linear paths, holes, cuts, passages, upturned reflections, over & below
HAZE	fog, overlaps, accelerations, faded, limitless, muffled, chaos	transparencies, opacity, blurred, out of focus, diffuse, dazzling, in motion, blended
COLOURFUL	chromatic, rhythms, textures, vibration, rainbows, spectrum	tones, brightness, blends, accents, shadows, intensity, contrast, harmony, iridescence
NETS	webs, connections, contact, mutation, growth, systems	organic, natural, interconnected, interlaces, nucleus, bonds, complexity
VOID	lack, loneliness, instants, nothing, ruins, silence	old portrait, industrial abandoned places, no-places, close-ups and zoom-in, textures

Table 1: Definition of the first seven visual atlases regarding the concept of atmosphere, with their recurrent morphological elements.

Additionally, regarding the **concept of memory**, it was possible to rearrange the images into four different visual atlases for the study of the main themes of: ‘individual memory’ (considering faces, human bodies, moments frozen in time, signs), ‘collective memory’ (where memory usually is placed in a specific space such as memorials, monuments, rituality, ruins, cemeteries), ‘physical environment’ (the specific memory of places considering landscapes, rural and urban contexts, façades, interior or private spaces) and, ‘abstract dimension’ (considering abstract compositions with different iconic levels and made through different techniques). An overview of some of the atmospheric atlases and the atlases related to memory can be seen in image 1.

After realising the visual atlases, it was possible to analyse the chromatic elements of every central theme. It was sought to translate the formal characteristics of the images (figurative, geometric, organic, abstract, among others) towards purely chromatic characteristics by identifying the most recurrent hues of every atlas while paying particular attention to the brightness and saturation of the colours obtained, as these two properties are fundamental for semantic purposes. The colour selection was made in two steps: first, obtaining a colour chart of 200 colours and then reducing the number of colours to a more manageable quantity of 25 colours for each visual atlas. The reduction of the original 200 colour chart was based on three criteria: [1] human perception of visual differences (by eliminating whose difference was not perceptible to the human eye,  $\Delta E < 1$ ); [2] heterogeneity, meaning keeping colours of different shades, luminosities and saturations; and [3] representativeness, that is, that the final colour chart should reflect the proportion in which colours appeared in the visual atlases, to preserve the original chromatic mood of each theme.

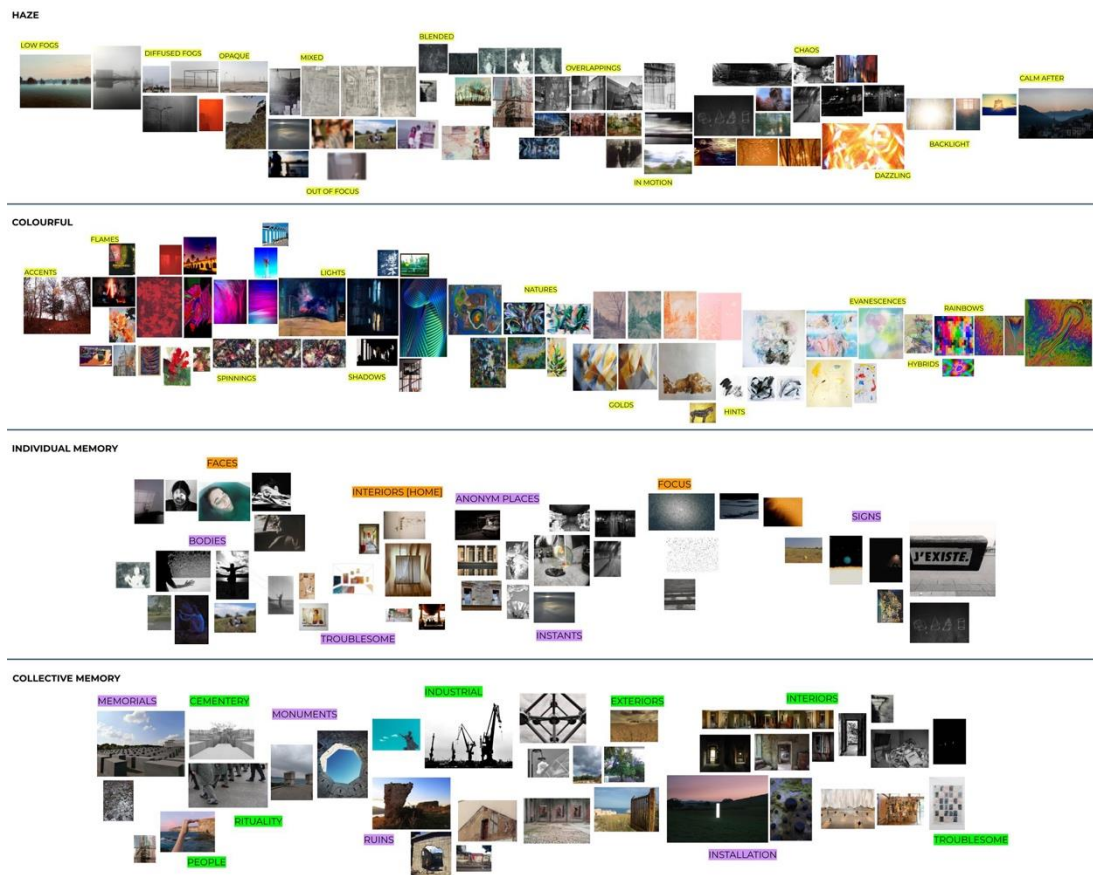

Figure 1: Overview of the visual atlases for the main themes of ‘haze’, ‘colourful’, ‘individual memory’ and ‘collective memory’.

## RESULTS

Regarding colour, the most relevant results are the 25-colours charts of every visual atlas that can be seen in image 2. The analytical observation of these charts made it possible to identify similarities and differences between the thematic atlases, as long as the recognition of harmonious and contrasting relationships and their link to the semantic poles of the Mnemosphere project.

A first noticeable chromatic similarity is found between the colour charts of individual and collective memory (image 2, right column). Both are composed of harmonious ‘earthy’ colours, from medium to low saturation. Participants' descriptions support this analogy, and it relates to the challenge of defining boundaries between personal memory (when it is linked to an environmental experience) and the collective heritage rooted in a place. The culture of a place is assimilated by individuals and their memory, as much as personal memories and experiences mix and blend with collective events and history.

Other evident similarities were found regarding the colour charts of the ‘colourful’ atmosphere and memory in the ‘abstract dimension’ (image 2, lower row). Both charts are composed of full-spectrum hues with high saturation, in complete opposition to the other thematic atlases. Thus, it is possible to define that the abstract dimension, in which an altered vision of reality is intrinsic, represents the sphere in which memory, experiences and spaces are interpreted through the visual expression of emotions and sensoriality. It is, therefore, a dimension profoundly linked to interiority and individual



perception as it is completely detached from the realistic depiction of the exterior, and it is represented solely through the colour-emotion filter. According to Simonsson, 'colour and light evoke feelings that are based not only on certain meanings but also on experiences of what can be defined as sensational analogies. These sensational analogies do involve not only colours and light but also other visual factors, tactile sensations, and sounds. [...] Colours and their nuances are not only fixed in our categorising and naming of them or their nature as mere visual perceptions; they also have other sensational effect' (2014: 32).

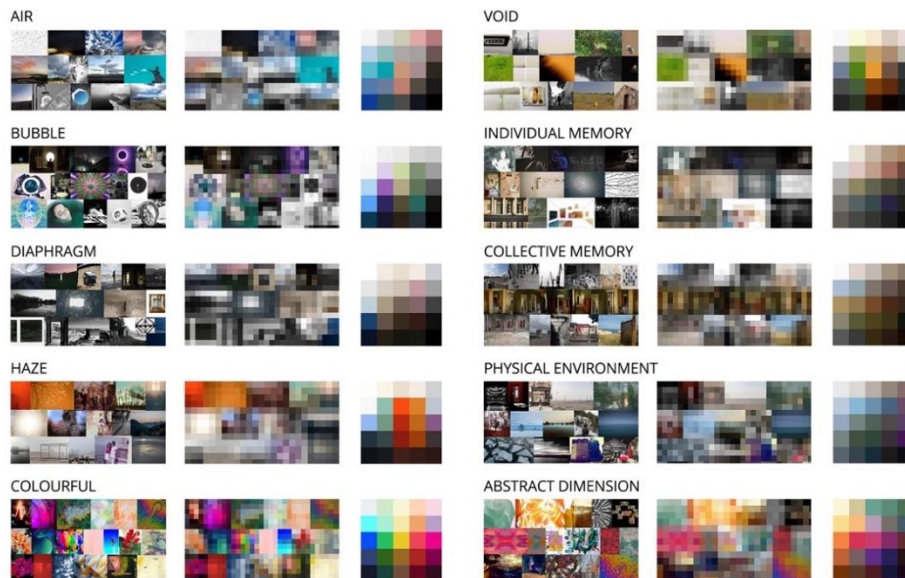

Figure 2: Overview of the process to obtain the final colour charts of every visual atlas. Every visual atlas was translated into pure colour information, to then define the colour charts with the most 25 representative colours.

The colour charts of the atmospheric atlases related to 'haze' and 'void' are composed by saturation contrasts, this is, neutral and desaturated tones can be found together with vivid and circumscribed chromatic peaks. These conformations emphasise an interesting emerging topic, namely how some environments are usually characterised by analogue colours that could be perceived as homogeneous. However, then, a unique contrasting element on the background rises and testifies the emptiness of the surroundings, as in the figure/ground Gestalt principle, or the evidence of singularity.

Most of the atmospheric-based atlases, 'air', 'bubble', 'diaphragm' and 'net', together with the 'environmental' memory-based atlas, shows a general harmony between the resultant colours. The chromatic mood is similar, having medium and low saturation and different brightness from high to low. This chromatic mood could be linked to the material characteristics of the spaces depicted in the images, which show a considerable presence of natural landscapes elements (such as wood, concrete, stone, skies, among others).

## **DISCUSSION**

Following the conclusion of this research activity, we can affirm that colours of nature and materials of specific places influence the individual or collective memory related to them. In comparison, the process of gradual incorporation of the place into the user's emotional experience alters the hues, brightness and saturation of the realistic representation of the place and landscape. In fact, 'the

sensory and affective quality of the atmosphere tinges the way we perceive our surrounding environment and the way we emotionally orient ourselves in it' (Rauh 2018). The ultimate aim of Mnemosphere, in the specific field of memory of places through the study of colours, is to be able to apply these chromatic findings in real spaces and 'turn an ephemeral message into a permanent memory' (Tumminelli 1997).

From the analysis it was possible to identify different chromatic moods related to specific atmospheres and memory that could be translated into *visual communication guidelines*, capable of evoking a particular environmental and emotional mood and by reflecting on the themes covered. The recognition of some particular characteristics of colour, such as low saturation or saturation peaks to represent specific concepts and harmonious or contrast relations to illustrate others, could be helpful to provide a route for designers when proposing a temporary exhibition space, but not only. Mnemosphere's guidelines or chromatic suggestions could also be applied to other themes, subjects or design areas. However, in the memory of places, they are of particular interest precisely because they could facilitate the visual perception of the contents displayed and narrated and allow people to be more deeply involved with the place's cultural heritage. The definition of these chromatic suggestions is one of the ongoing tasks of the Mnemosphere project and will be mainly informed by the analysis presented in this paper.

## REFERENCES

- Benjamin, W. 2003. *Opere complete. Vol V - Scritti 1932-1933*. Tiedemann, R., & Schweppenhäuser, H. (a cura di) (E., Gianni, & H., Riediger, Trad.). Torino: Einaudi Editore.
- Birren, F. 2006. *Colour psychology and colour therapy: A factual study of the influence of colour on human life*. Whitefish, MT: Kessinger.
- Hanna, A., and R. Remington. 1996. *The representation of colour and form in long-term memory*. Journal of Psychonomic Society, Memory and Cognition. 24 (3), 322–330.
- Iuav, C. Studi. 2012. *Mnemosyne Atlas*. La Rivista Di Engramma.
- Rauh, A. 2018. *Concerning astonishing atmospheres. Aisthesis, Aura and Atmospheric Portfolio*. In Atmospheric Spaces, n. 4 (p. 115). Mimesis International.
- Simonsson, M. 2014. *Displaying Spaces - Spatial Design, Experience, and Authenticity in Museums*. Print & Media.
- Tanaka, J., and L. Bunosky. 1993. *Is the object recognition system really colour-blind?* Poster presented at the Annual Meeting of the Psychonomic Society, November 1993. Washington, DC.
- Tumminelli, P. 1997. *Designing the ephemeral*. Domus Dossier, April (5), 4–6.
- Wichmann F., L. Sharpe and K. Gegenfurtner. 2002. *The contributions of colour to recognition memory for natural scenes*. Journal of Experimental Psychology Learn. 2002;28(3):509–520.
- Wurm, L., G. Legge, L. Isenberg, and A. Luebker. 1993. *Colour improves object recognition in normal and low vision*. Journal of Experimental Psychology: Human Perception & Performance, 19, 899-911.

# Analysis of Research Strategies to Determine Colour Preference II: AFC, Rank-Order and Rating

Luwen Yu <sup>1, \*</sup>, Stephen Westland <sup>1</sup>, Vien Cheung <sup>1</sup> and Guobin Xia <sup>1,2</sup>

<sup>1</sup>School of Design, University of Leeds, UK; ml1412y@leeds.ac.uk; S.Westland@leeds.ac.uk; T.L.V.Cheung@leeds.ac.uk

<sup>2</sup>School of Textile and Design, Herriot-Watt University, UK; sdgx@leeds.ac.uk

\* Corresponding author: ml1412y@leeds.ac.uk

## Abstract

Exploring an efficient research method to understanding colour preference is important to researchers and designers. This work compares three experimental methods for individual colour preference research (N-alternative-forced-choice, rank-order and rating). Three psychophysical experiments have been carried out with 338 participants. Participants were presented with six colour patches (red, orange, yellow, green, blue and purple) arranged in a random order. This work suggested orange is the strongest preferred colour and green is the weakest preferred in three individual colour preference experimental methods with six hues. The Monte Carlo Analysis method further compares the result performance for three methods, which suggests the rating and rank-order method are more stable than the AFC method when only small number participants take part in the experiment, such as for studies involving small numbers of participants, the rating and rank-order method should be preferred.

**Keywords:** *Colour Preferences, Experimental Method, Monte Carlo Analysis, Research Strategy.*

## INTRODUCTION

Colour preference *per se* has been studied by many researchers (Camgöz et al. 2002). It is concerned with which colours individual prefer (Mikellides 2012). Finding an efficient way to understand individual colour preference is important to both researchers (Jiang et al. 2020) and designers (Lee et al. 2019; Swasty et al. 2020). The previous studies have used standardised colours, multiple research strategies, and sophisticated statistical methods (Yu et al. 2021a).

From the previous studies, a colour preference research strategy includes experimental material, experimental method and experimental environment (Yu et al. 2021a). The experimental methods could be classified as N-alternative forced-choice (N-AFC,  $N \geq 2$ ), rank-order, subjective rating, affective judgments etc. In N-alternative forced-choice method, participants indicate which colour they 'prefer aesthetically' with all colours simultaneously presented on a visual display (Palmer et al. 2013). The 2-AFC is also called 'Paired-Comparison' (Ling et al. 2006), it is a simple response to indicate the preference from only two samples. The rank-order method requires participants to provide an order to all colours from the most to the least preferred for all colours simultaneously displayed (Holmes et al. 1985). The subjective rating (Adams, 1987) and affective judgment (Ou et al. 2004) methods are made by response scales for how much they prefer each single colour, such as N-point Likert scale or a line-mark rating. Other methods include description method, physical and behavioural measurements (Yu et al. 2021a) etc. This research concerned with finding an efficient research method to test individual colour preference. Three experimental methods have been chosen, AFC, rank-order and rating experimental methods. The research aim is: 1) to test the agreements of individual colour preference results between three methods; 2) to determine a lower limited number of participants with consistent and reliable results for three methods.



**EXPERIMENTAL**

For *experimental environment*, it has been suggested that there was no statistical significance between online and laboratory environments for individual colour preference test (Yu et al. 2021a). Although, the online environment is less-controlled than the laboratory environment in display technology or viewing conditions etc., the advantage is relatively easy to recruit a large number of participants, and robust estimates of individual colour preference for groups of participants (such as nationality or even socio-economic status). Thus, online questionnaire has been chosen in this research.

In this study, six colours (red, orange, yellow, green, blue and purple) were selected to determine participants’ individual colour preference (Holmes et al. 1985; Yu et al. 2021b). The colours were defined by sRGB values (please see Figure 1). Three experimental methods have been used, AFC, rank-order and rating.

Participants were presented with six colour patches (red, orange, yellow, green, blue and purple) arranged in a random order on a display. In the AFC test, participants were asked to indicate which colour they prefer most; for the rank-order test, participants were asked to give the sequence of their colour preference for the six colours from the most to least; for the rating test, participants were asked to scales the colour preference for each colour by line-mark ratings. A total 338 participants were recruited to participate, comprising of 192 participants for AFC test, 85 participants for rank-order test and 41 participants for rating test.

**RESULTS AND DISCUSSION**

The individual colour preference percentage for each colour is the number of times that each colour has been selected as the most preferred for AFC method (Yu et al., 2018). For rating method, each colour preference percentage has been averaged by participants’ rating from 0% to 100% as non-prefer to most prefer. In the rank- order method, the ordinal rank and comparative data are converted to interval-data z scores (Yu et al. 2021a). The rank-order data from each participant were combined to mean rank data and subsequently proportion values (between 0 and 1) (Westland *et al.*, 2014). The proportion values were converted to interval scale values z using the inverse of the cumulative standardized normal distribution according to case V of Thurstones Law of Comparative Judgement (Hohle 1966); additionally, the proportion of 0 and 1 are replaced with 1/999 and 999/1000 respectively when the proportions are exactly 0 or 1 (Yu et al. 2021a). In order to compare three methods, the interval scale values z have also been used on AFC and rating methods.

First, 338 responses have been collected as AFC method (the colour was placed in the first choice was considered in the rank-order method, and the colour was obtained the highest rating was counted in the rating method); 126 responses have been collected as rank-order method (the rating preference sequence was considered as a rank-order); and 41 responses have been collected in rating method.



Figure 1: The individual colour preference rank sequences from three methods.

The colour preference sequence for z scores for AFC method is blue > orange > red > yellow > purple > green; the preference sequence for rank-order method is orange > yellow > blue > red > green > purple; for rating is orange > yellow > blue > red > purple > green; which represents a similar sequence (please see Figure 2.1). However, the data were collected from different populations. In order to reduce the differentiation, the results from rating group have been re-analysed. The rank-order and rating method have a same colour preference Z scores sequence, orange > yellow > blue > red > purple > green. Also, AFC method also obtained a similar sequence, orange > blue > yellow > purple > red > green (Please see Figure 2.2).

Moreover, this study aims to explore the efficiency way on scaling individual colour preference, between experimental methods and participant numbers. The Monte Carlo simulation analysis was used to explore the level of agreement of these three methods (Yu et al. 2021a). The data from rating were used as three methods. 41 responses were sub-sampled, and sub-sample the full population repeatedly taking a different sub-sample each time. The following four steps are: subsample  $n$  of the data from *the* 41 participants randomly where  $n$  is [36, 31... 6, 1] (Step 1); calculate the individual colour preference z score for each  $n$  scale participants ( $n = 36, 31, 26, 21, 16, 11, 6$  and  $1$ ) to obtain the three distributions of individual colour preference for each  $n$  scales from AFC, rank-order and rating methods (Step 2); construct the correlation coefficient ( $r^2$ ) calculated between the individual colour preference from all the data ( $n = 41$ ) and from the sub-sampled data ( $n = 36, 31... 6, 1$ ) (Step 3, Figure 4); compare the  $r^2$  distributions between the three methods (Step 4, Figure 3).



Figure 2: The correlation for the individual colour preference between full samples ( $n=41$ ) and each the sub-sampled samples ( $n=36, 31, 26, 21, 16, 11, 6$  and  $1$ ) from AFC, rank-order and rating methods (an example illustration for Step 3).

Figure 2 and Figure 3 illustrates the steps 3 and 4, presenting the correlation coefficient values with  $n$  scale samples ( $n=36, 31, 26, 21, 16, 11, 6$  and  $1$ ). In Figure 3, the red, grey and blue lines show the  $r^2$  distributions from AFC, rank-order and rating methods; each point represents the  $r^2$  for each  $n$  scale samples. Comparing the small-scale samples tests ( $n=15, n=10$  and  $n=5$ ), the correlation coefficients hold on the high agreements) for both rating (0.84, 0.79 and 0.63) and rank-order (0.82, 0.75 and 0.60) methods. However, the correlation coefficients decrease sharply to the low agreement positions for AFC method (0.43, 0.36 and 0.1). It suggests that the rating and rank-order methods are more stable than AFC in small number of responses.

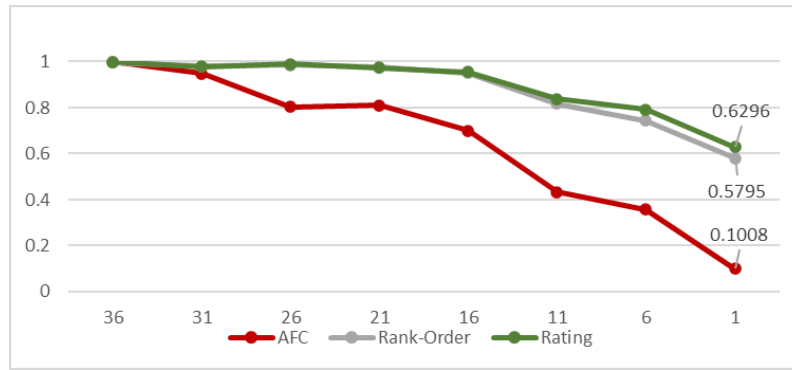

Figure 3: An example illustration for the correlation coefficient distributions from AFC, rank-order and rating methods. The vertical and horizontal axes represent  $r^2$  values and n scale samples.

The Monte Carlo comparisons evaluate the stability of the three methods, the simulation was repeated 100 times. Each simulation starts with a different random set of scale samples, and the mean correlation coefficient was used as a measure of performance. Figure 4 displays the box plots for the  $r^2$  distributions from 6-AFC, rank-order and rating methods, the vertical axes and horizontal axes represent the correlation coefficient values and n scale samples. Notice that the median for rating and rank-order methods are higher than AFC method when samples less than 11 for example, especially, for the sample size as 11, 6 and 1, shows by the red horizontal line (for the size 1,  $r^2 \sim 0.2$  in AFC method,  $r^2 \sim 0.59$  in Rank-Order method, and  $r^2 \sim 0.67$  in rating method). In other words, the results from Monte Carlo simulations suggests that the rating and rank-order methods are more relay and stable than the AFC method for individual colour preference when n is small. This suggests that, for studies involving small numbers of participants, the rank-order rating and rank-order should be considered.

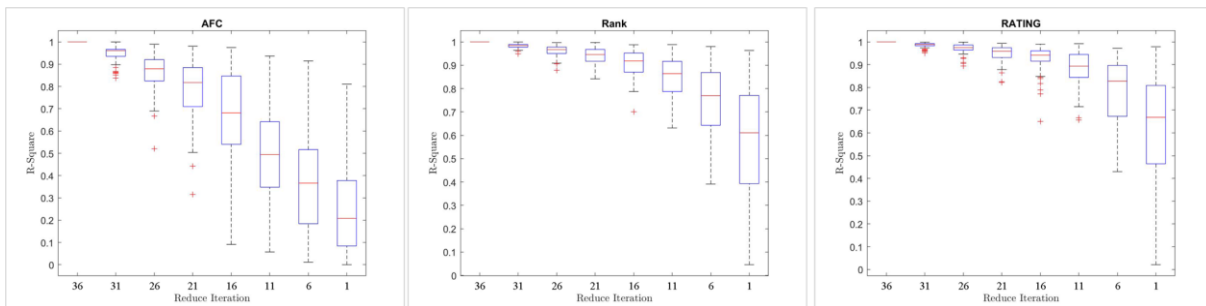

Figure 4: The box plots for the  $r^2$  distributions from AFC, Rank-Order and Rating methods.

### CONCLUSION

Colour is an important tool for products design (Gong et al. 2019), environment design (Xia et al. 2021), information design (Xia et al. 2019) etc. However, finding an efficient method to investigate individual colour preference is important for designer and researcher. The individual colour preference results from this work suggested orange is the strongest preferred colour in these six hues and green is the weakest preferred in three individual colour preference experimental methods (AFC, rank-order and rating). The Monte Carlo Analysis method also be employed to compare the result performance of the methods for individual colour preference by repeating 100 trials. The average correlation coefficients variation range for AFC method is wiled than both rating and rank-order methods in the small number of participants (less than 11 or 6). That suggests the rating and rank-order method are more stable

than the AFC method when only small number participants take part in the experiment, such as for studies involving small numbers of participants (less than 11 participants), the rating and rank-order method should be preferred.

## REFERENCES

- Adams, R. J. 1987. An evaluation of color preference in early infancy. *Infant Behavior and Development* 10 (2): 143-150.
- Camgöz, N., C. Yener, and D. Güvenç. Effects of hue, saturation, and brightness on preference. *Color Research & Application*, no. 3 (2002): 199-207.
- Gong, Han, L. Yu, and S. Westland. Simple primary colour editing for consumer product images. In *Color and Imaging Conference*, vol. 2020, no. 28, pp. 270-276. Society for Imaging Science and Technology, 2020.
- Hohle, R. H. 1996. An empirical evaluation and comparison of two models for discriminability scales. *Journal of Mathematical Psychology* 3, no. 1 (1966): 174-183.
- Holmes, C. B., H. E. Fouty, P. J. Wurtz, and B. M. Burdick. 1985. The relationship between color preference and psychiatric disorders. *Journal of Clinical psychology* 41, no. 6: 746-749.
- Liling, J., V. Cheung, S. Westland, P. A. Rhodes, L. Shen, and L. Xu. 2020. The impact of color preference on adolescent children's choice of furniture. *Color Research & Application* 45,4: 754-767.
- Gyeonghwa, L., S. Westland, and V. Cheung. 2019. Colour communication challenges: Exploring disciplinary divides. *Journal of the International Colour Association* 23: 25-35.
- Yazhu, L., A. Hurlbert, and L. Robinson. 2006. Sex differences in colour preference. *Progress in colour studies* 2: 173-188.
- Mikellides, B. 2012. Colour psychology: The emotional effects of colour perception. In *Colour Design*, pp. 105-128. Woodhead Publishing.
- Ou, Li-Chen, M. R. Luo, A. Woodcock, and A. Wright. 2004. A study of colour emotion and colour preference. Part I: Colour emotions for single colours. *Color Research & Application* 29,3: 232-240.
- Palmer, Stephen E., Karen B. Schloss, and Jonathan Sammartino. Visual aesthetics and human preference. *Annual review of psychology* 64 (2013): 77-107.
- Wirania, S., A. Mustikawan, and F. Eridani Naufalina. 2020 Visual Perception of Primary Display Panel of Coffee Packaging. *Jurnal Manajemen dan Kewirausahaan* 22, no. 1: 73-79.
- Westland, S., Y. Li, and V. Cheung. 2014. Monte Carlo analysis of incomplete paired-comparison experiments. *Journal of Imaging Science and Technology* 58, no. 5: 50506-1.
- Xia, G., P. Henry, F. Queiroz, and S. Westland. Effects of object colour stimuli on human brain activities and subjective feelings in physical environment and virtual reality. In *Proceedings of the International Colour Association (AIC) Conference 2019*. Leeds, 2019.
- Xia, G., P. Henry, F. Queiroz, and S. Westland. Effects of coloured lighting in the real world environment and virtual reality. *Journal of the International Colour Association* 27 (2021): 9-25.
- Luwen, Y., S. Westland, and Z. Li. Analysis of experiments to determine individual colour preference. *Color Research & Application* 46, no. 1 (2021): 155-167.
- Luwen, Y., S. Westland, Z. Li, and G. Xia. 2021. The effect of decision time-length condition on consumer product-colour purchase decision. *Color Research & Application*.
- Luwen, Y., S. Westland, Z. Li, Q. Pan, M. Jin Shin, and S. Won. 2018. The role of individual colour preferences in consumer purchase decisions. *Color Research & Application* 43, no. 2: 258-267.



# Making sense of free associations with PURPLE – A new coding scheme testing French speakers in three countries

Déborah Epicoco <sup>1,\*</sup>, Christine Mohr <sup>1</sup>, Mari Uusküla <sup>2</sup>, Michael Quiblier <sup>1</sup>, Maliha Bouayed Meziane <sup>3</sup>, Eric Laurent <sup>4</sup>, and Domicela Jonauskaite <sup>1</sup>

<sup>1</sup> Institute of Psychology, University of Lausanne, Switzerland, christine.mohr@unil.ch, michael.quiblier@hotmail.ch and domicela.jonauskaite@unil.ch

<sup>2</sup> School of Humanities, Tallinn University, Estonia, muuskyla@tlu.ee

<sup>3</sup> LGSDS, Ecole Nationale Polytechnique, Algeria, maliha.bouayed@g.enp.edu.dz

<sup>4</sup> LINC, University of Bourgogne Franche-Comté, France, eric.laurent@univ-fcomte.fr

\* Corresponding author: deborah.epicoco@unil.ch

## Abstract

The colour category PURPLE is strangely heterogeneous, potentially due to the use of different cognates. We asked French speakers from Algeria, France, and Switzerland ( $n = 274$ ) to produce up to three free associations with *violet* (basic term), *pourpre*, and *lilas* (non-basic terms). We counted 2,075 associations. We developed a coding scheme that i) covers nine major themes, and ii) shows high inter-rater reliability. Overall, the themes *colour terms* and *natural elements and objects* were most prominent showing that participants provided closely related associations. Finally, *violet* triggered more diverse semantic associations than *pourpre* or *lilas*. This was true for all countries. It seems that the basic term PURPLE carries more diverse associations and connotations than the non-basic terms.

**Keywords:** *Colour psychology; basic colour terms; purple; semantic network models; cross-cultural*

## INTRODUCTION

Inquire on the Internet whether colour affects us – you will find a lot to read. Numerous contributions claim that colours impact us affectively and psychologically, from colours we add on ourselves via make-up or clothing, to the paint on our walls (Moore 2021). However, systematic studies that support such claims are missing, even if for affect, we have solid evidence that conceptual colour-affect relationships are universal (Adams and Osgood 1973; Jonauskaite et al. 2019; Jonauskaite, Abu-Akel et al. 2020). For psychological effects, evidence is largely limited to RED (Elliot 2015; Meier et al. 2012). Thus, to study the psychological meaning of colour, we simply asked people to freely associate with colour terms.

Free associations (FAs) are thought to provide a window into people's thoughts and feelings (Freud 1913), whether in clinical (Lothane 2018) or cognitive (Nelson et al. 2000) contexts. Semantic network models (Collins and Quillian 1969) help interpret type and speed of FAs; assuming that concepts represented by these FA are represented as "nods". Closely related concepts in these networks have close and strong connections. Unrelated concepts have remote and weak connections. If we activate the concept of MOTHER, semantic spreading activation would co-activate closely related concepts such as FATHER or CHILD, one of the fastest and first FAs. CATERPILLAR and VEHICLE, however, are remotely related, unless you are enthusiastic about construction vehicles including those by "CATERPILLAR". In this latter case, vehicle might be one of the first and fastest FAs.

Here, we used FAs to assess the psychological meanings of colour. French speakers from Algeria, France, and Switzerland provided FAs with numerous concepts including colour terms. We focus on results on PURPLE for the following reasons. First, we expect a wide range of FAs, because this colour category yields diverse affective meanings within and between languages (Jonauskaite, Abu-Akel et al. 2020; Jonauskaite, Parraga et al. 2020). Second, PURPLE seems an inconsistent basic colour

category (Uusküla 2007). Third, PURPLE is represented by different cognates such as *purple*, *violet* and *lilac* across languages (Berlin and Kay 1969; Bimler and Uusküla 2014; Jones 2013). To make sense of FAs, we used our new coding scheme consisting of nine major themes. We tested i) the inter-rater reliability, ii) whether frequent FAs are closely related, iii) whether FAs distribute differently across themes between cognates, and iv) for shared meanings across Algeria, France, and Switzerland.

## **METHOD**

### **Participants**

We recruited 274 (36 men) French native speakers from Algeria ( $n = 66$ , 6 men), France ( $n = 55$ , 7 men), and Switzerland ( $n = 153$ , 23 men). Participants had a mean age of 24.4 years (standard deviation ( $SD$ ) = 0.71 years, range 18-74 years). Nobody was colour-blind by self-report. The study protocol was approved by the local ethics committee (number C\_SSP\_032020\_00003).

### **General procedure**

We collected FAs with 16 colour terms, 20 emotion terms, and 26 filler terms (Fitzpatrick et al. 2015) through the online platform LimeSurvey (see all words in Table S1). After receiving written study information, participants provided informed consent and demographic information (age, gender, etc.). Then, they read the following instructions:

*“On the screen, you will see one word after the other. For each word, please write down the first three words that come to your mind. For example, you see the word SUN and SKY, YELLOW, BEAUTIFUL are the first words that come to your mind. In that case, you would write these words into the word field. There are no right or wrong answers, we are interested in your personal opinion.”*

By clicking on the YES button, participants confirmed that they understood the task. Then, they saw the word list including violet, lilas, and pourpre in semi-randomized order, the colour terms never followed each other. After each word, participants provided up to three FAs. Upon study completion, they were thanked and debriefed. The entire study took about 15 minutes to complete.

### **Development of the coding scheme**

To identify recurrent themes, we used “open coding” in grounded theory (Glaser and Strauss 1967), “clustering” or “theme identification” as referred to in more eclectic approaches (Miles and Huberman 1994). A first coder (MQ) went over the word list to identify recurrent themes. Then, MQ and DJ defined six themes: *sensory experience*, *emotion*, *concrete item*, *nature*, *abstract concept* and *personal*. They could not code all FAs satisfactorily. Thus, we eliminated some themes and introduced new ones (see also Griber et al. 2018) having six themes: *experiential (sensory and affective experiences)*, *human-made objects*, *non-human-made objects*, *abstract concepts*, *colour terms*, and *personal*. MQ and DE independently coded 156 FAs achieving an almost perfect inter-rater agreement,  $\kappa = 0.888$ . However, most FAs were allocated to *abstract concepts* (37.24%) and *natural objects and elements* (32.90%), thus, the coding scheme lacked precision. Accordingly, we introduced two major modifications by i) developing more precise themes ( $n = 9$ ) and ii) adding subthemes (Table 1). Five themes had subthemes following Rosch’s categorisation principles (1978), distinguishing between meta-level concepts, concrete examples, and very concrete examples that share many attributes. For the remaining themes, we either added different subthemes or none (see Table 1). DE and MQ coded another 20% of participants’ responses. They had again a high agreement ( $\kappa = 0.848$ ) and resolved disagreements through discussion. DE coded the remaining data.

Themes	Definitions	Subthemes
1. Experiential: sensory and affective experiences (65)	People associate experiences, feelings, physical sensations (e.g., <i>smell</i> (39), <i>soft</i> (26)).	Superordinate level (Emotion) Basic level (Sadness) Subordinate level (Intense sadness)
2. Human-made objects (56)	People associate what is made or caused by humans (as opposed to nature) (e.g., <i>perfume</i> (28), <i>wine</i> (14), <i>clothes</i> (13))	Superordinate level (Furniture) Basic level (Chair) Subordinate level (Kitchen chair)
3. Natural elements and objects (408)	Everything that comes from nature, as opposed to what is made by humans (e.g., <i>flower</i> (336), <i>blood</i> (33), <i>lavender</i> (23), <i>octopus</i> (16))	Superordinate level (Tree) Basic level (Maple) Subordinate level (Sugar Maple)
4. Scenery (25)	Something complex and large, but labels visible parts of our environment, something we can point to (e.g., <i>spring</i> (25))	Visible, concrete, (Sunset) Abstract (Morning)
5. Abstract concepts (10)	An abstract idea with no form (e.g., <i>feminism</i> (10))	No other level (Christmas)
6. People (32)	Also include a group of people and fictional characters (e.g., <i>name</i> (22), <i>woman</i> (10))	Superordinate level (Woman) Basic level (Princess) Subordinate level (Catherine Middleton)
7. Colour terms (575)	Everything related to colours that do not represent an opinion, e.g., <i>colour</i> (241), <i>violet</i> (165), <i>red</i> (85), <i>mauve</i> (46), <i>pourpre</i> (25), <i>blue</i> (13)	Superordinate level (Colour) Basic level (Purple) Subordinate level (Light purple)
8. Personal (30)	Opinions or autobiographic responses (e.g., <i>pretty</i> (18), <i>beautiful</i> (12))	Opinions (Beautiful) Autobiographic responses ( <i>my room</i> )
9. Ambiguous words (82)	Every word that can have more than one meaning ( <i>lilas</i> (42), <i>rose</i> (40))	No other level (Church)

Table 1: Details of the coding system (see [Table S3](#) for complete information). Definition of the nine themes and subthemes resulting from the content analysis. We were inspired by Rosch's principle of categorisation (1978), (superordinate level, basic level, and subordinate level); but also adding other types of subthemes or no subthemes at all. In brackets, we indicate the numbers for the most frequent FAs (n), defined as those given by at least 10 participants in our data set for PURPLE (2,075 FAs). In [Table S2](#), we show the complete list and counts of FAs with PURPLE.

### Data analysis

Most, but not all participants (81.3%) gave three FAs per cognate resulting in uneven numbers. Thus, we analysed our data per FAs and not per participant. We report on sub-themes elsewhere (see [Table S2](#)). Here, we report on the frequencies with which FAs fell into the nine major themes, for cognate, and country separately. First, we used chi-square tests of goodness of fit ( $\chi^2_{GF}$ ) to establish if themes were chosen at different frequencies i) overall (Table 2), and ii) as a function of cognate (Figure 1.A, Table 2). Second, we used chi-square tests of independence ( $\chi^2_I$ ) to establish if themes were chosen at different frequencies as a function of i) cognate (Table 2), and ii) country (Figure 1.B). If significant, we used standardized residuals to elucidate which themes drove the difference. We analysed the data with R v.1.4.1106 (R Core Team 2021).



## RESULTS

### Frequencies of themes and themes by cognate

The significant  $\chi^2_{GF}$ ,  $\chi^2(8) = 1695.4$ ,  $p < 0.001$ , showed that the overall number of FAs differed between themes (see also Table 2 and complete results in [supplementary material](#)). Complementary  $\chi^2_{GF}$ s for each cognate separately were significant: *lilas*,  $\chi^2(8) = 810.33$ ,  $p < .001$ ; *pourpre*,  $\chi^2(8) = 769.85$ ,  $p < .001$ ; *violet*,  $\chi^2(8) = 450.29$ ,  $p < .001$ , showing that themes were chosen at different frequencies (Figure 1.A).

Overall		Violet		Pourpre		Lilas	
>	<	>	<	>	<	>	<
3 <sup>#</sup> , 7 <sup>#</sup>	1 <sup>#</sup> , 4 <sup>#</sup> , 5 <sup>§</sup> , 6 <sup>*</sup> , 8 <sup>#</sup>	5 <sup>#</sup> , 8 <sup>§</sup> , 9 <sup>#</sup>	7 <sup>#</sup>	2 <sup>#</sup> , 5 <sup>§</sup> , 7 <sup>#</sup>	1 <sup>#</sup> , 3 <sup>#</sup> , 6 <sup>*</sup>	1 <sup>#</sup> , 3 <sup>#</sup> , 4 <sup>#</sup> , 6 <sup>#</sup>	2 <sup>#</sup> , 5 <sup>#</sup> , 7 <sup>§</sup> , 9 <sup>#</sup>

Table 2: Standardized residuals show which themes were chosen more (>) and less (<) frequently than expected by chance (overall) or when comparing one cognate to the other two. Numbers represent themes of Table 1 (also see Figure 1). \* $p < .05$ , § $p < .01$ , # $p < .001$ .

### Association frequencies as a function of theme and cognate

The significant  $\chi^2_I$ ,  $\chi^2(16) = 246.41$ ,  $p < .001$ , showed that the number of FAs differed as a function of themes and cognates (see words and their counts in [supplementary material](#)). Table 2 shows themes that were chosen more or less frequently for one of the cognates compared to the other two cognates (for complete results, see [supplementary material](#))

### Association frequencies as a function of theme and country

The  $\chi^2_I$  failed the conventional significance level,  $\chi^2(16) = 26.01$ ,  $p = 0.053$ . Exploring country differences per cognate tentatively, we found no difference for *lilas*,  $n = 705$ ,  $\chi^2(16) = 24.14$ ,  $p = 0.086$ , and *pourpre*,  $n = 686$ ,  $\chi^2(16) = 25.07$ ,  $p = 0.068$ , but we did for *violet*,  $n = 684$ ,  $\chi^2(16) = 37.12$ ,  $p = 0.002$ . Standardised residuals on *violet* indicated that Swiss participants associated *abstract concepts* more often than Algerian and French participants, 16.3%,  $z = 3.13$ ,  $p < .01$ , and associated *experiential* less often than Algerian or French participants, 5.8%,  $z = -2.41$ ,  $p < .05$  (Figure 1.B).

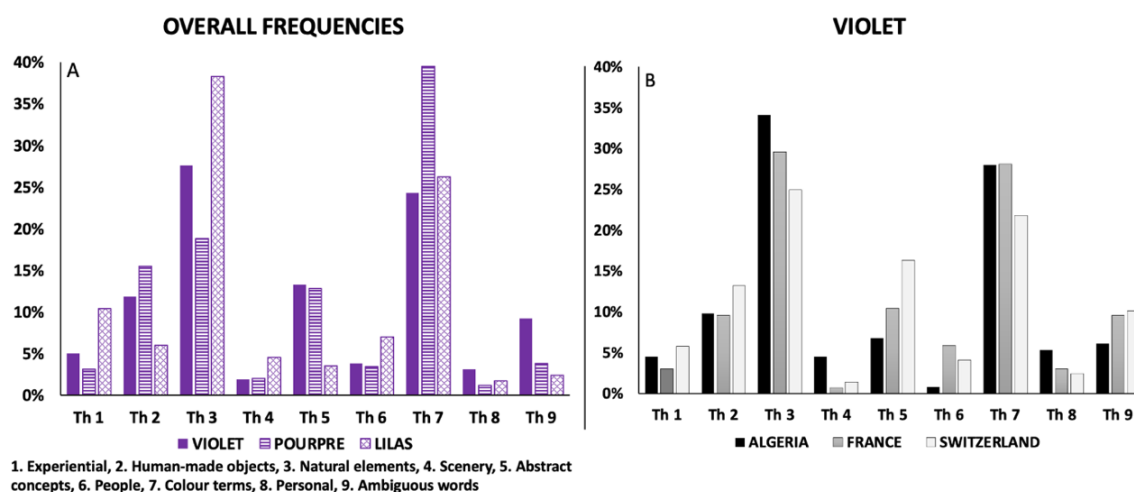

Figure 1: Percentages with which A) 2,075 FAs have been allocated to the nine major themes as a function of cognate, and B) 684 FAs with violet have been allocated to the nine major themes as a function of country (B). Significant standard residuals are coded as \* $p < .05$ , § $p < .01$ .

## **DISCUSSION**

We studied the psychological meanings of PURPLE using FAs, inspired by semantic network models. Participants from Algeria, France and Switzerland provided 2,075 FAs with the words *violet*, *pourpre* and *lilas*. Using these FAs, we developed a coding scheme consisting of nine major themes. This scheme is promising because first, we achieved high inter-rater reliability; second, frequent FAs belonged to closely related concepts (i.e., *natural elements and objects* and *colour terms*), and third, the number of FAs differed between themes, and as a function of theme by cognate. For instance, FAs were most frequently allocated to *colour terms* and *natural elements and objects*.

Looking closely at results by cognate, some themes were biased towards *lilas*: i) *natural elements and objects*, ii) *experiential*, iii) *people* and iv) *scenery*. For *pourpre* we found biases towards i) *colour terms*, ii) *human-made objects*, and iii) *abstract concepts*. For *violet*, we found biases towards i) *ambiguous words*, ii) *abstracts concepts*, and iii) *personal*. Thus, the most frequent themes were more prominent for the non-basic colour terms than the basic ones. We conclude that FAs for the basic colour term are more diverse, distributing across more themes than the FAs for non-basic colour terms. Importantly, this conclusion was true for all three French speaking countries indicating that psychological meaning is widely shared within the same language, even if spoken in different countries. This could be because basic colour terms are embedded in various living experiences, which could be more diverse than those in which non-basic colour terms are employed.

To test whether our coding scheme proves powerful to determine the psychological meaning of colour more generally, we must study FAs beyond both French speaking populations and PURPLE. For instance, *violet* is the basic colour term in Italian and Lithuanian, but in English and Bulgarian it is *purple*, and in German and Estonian it is *lilac*. Thus, if our results generalize, we should observe that FAs distribute across more themes for the basic than non-basic colour terms, irrespective of cognate or country. Finally, because themes differed between the three colour terms, the actual FAs might help understand whether inconsistent findings for the category boundaries of PURPLE (Uusküla, 2007) resulted from different cognates being basic colour terms between languages. Our most frequent FAs showed that both *lilas* and *violet* were associated with both *mauve* and *rose*, while *pourpre* was associated with *red*. Perhaps, countries using *purple* as the basic term have a mental representation of PURPLE that is more strongly shifted towards red than those using *violet* or *lilac*. Such studies might help why we observe inconsistent colour-emotion associations with PURPLE (Jonauskaite, Abu-Akel et al., 2020; Jonauskaite, Parraga, et al., 2020; Jonauskaite, Wicker, et al., 2019).

## **ACKNOWLEDGEMENTS**

This research was supported by the Swiss National Science Foundation (project grant number 100014\_182138, PI C. Mohr and POLAP1\_175055, PI D. Jonauskaite). All supplemental materials can be found in [OSF](#).

## **REFERENCES**

- Adams, F. M., and Osgood, C. E. 1973. A Cross-Cultural Study of the Affective Meanings of Color. *Journal of Cross-Cultural Psychology* 4: 135–156.
- Adams, F. M., and C. E. Osgood. 1973. "A Cross-Cultural Study of the Affective Meanings of Color." *Journal of Cross-Cultural Psychology* 4 (2): 135–56.
- Berlin, B., and P. Kay. 1969. *Basic Color Terms: Their Universality and Evolution*. Berkeley: University of California Press

- Bimler, D., and M. Uusküla. 2014. "‘Clothed in Triple Blues’: Sorting out the Italian Blues." *Journal of the Optical Society of America A* 31 (4): A332.
- Collins, A. M., and M. R. Quillian. 1969. "Retrieval Time from Semantic Memory." *Journal of Verbal Learning and Verbal Behavior* 8 (2): 240–47.
- Elliot, A. J. 2015. "Color and Psychological Functioning: A Review of Theoretical and Empirical Work." *Frontiers in Psychology* 6 (APR): 1–8.
- Fitzpatrick, T., D. Playfoot, A. Wray, and M.J. Wright. 2015. "Establishing the Reliability of Word Association Data for Investigating Individual and Group Differences." *Applied Linguistics* 36 (1): 23–50.
- Freud, S. 1913. On beginning the treatment. Standard Edition, 12. London: Hogarth Press
- Glaser, B. G., and A.L., Strauss. 1967. *The discovery of grounded theory: Strategies for qualitative research*. Aldine.
- Griber, Y. A., D., Mylonas, and G.V. Paramei. 2018. Objects as culture-specific referents of color terms in Russian. *Color Research and Application* 43 (6): 958–975.
- Jonauskaite, D., A. Abu-Akel, N. Dael, D. Oberfeld, A. M. Abdel-Khalek, A. S. Al-Rasheed, J. P. Antonietti, et al. 2020. "Universal Patterns in Color-Emotion Associations Are Further Shaped by Linguistic and Geographic Proximity." *Psychological Science*, September, 1–16.
- Jonauskaite, D., C. A. Parraga, M. QUILIER, and C. Mohr. 2020. Feeling Blue or Seeing Red? Similar Patterns of Emotion Associations With Colour Patches and Colour Terms. *I-Perception* 11 (1).
- Jonauskaite, D., J. Wicker, C. Mohr, N. Dael, J. Havelka, M. Papadatou-Pastou, M. Zhang, and D. Oberfeld. 2019. A Machine Learning Approach to Quantify the Specificity of Colour–Emotion Associations and Their Cultural Differences. *Royal Society Open Science* 6 (9).
- Jones, J. W. 2013. *German Colour Terms: A Study in Their Historical Evolution from Earliest Times to the Present*. Studies in the History of the Language Sciences. John Benja. Vol. 109.
- Lothane, H. Z. 2018. Free Association as the Foundation of the Psychoanalytic Method and Psychoanalysis as a Historical Science. *Psychoanalytic Inquiry* 38 (6): 416–34.
- Meier, B. P., P. R. D’Agostino, A. J. Elliot, M. A. Maier, and B. M. Wilkowski. 2012. Color in Context: Psychological Context Moderates the Influence of Red on Approach- and Avoidance-Motivated Behavior. *PLoS ONE* 7 (7).
- Miles, M. B., and A. M. Huberman. 1994. *Qualitative data analysis: A sourcebook of new methods*. Sage Publications.
- Moor, B. 2021. Exterior Home Paint Ideas & Inspiration. URL: <https://www.benjaminmoore.com/en-us/color-overview/find-your-color/color-families/gre/green?source=%2Fen-us%2Fcolor-overview%2Ffind-your-color%2Fcolor-families>
- Nelson, D. L., C. L. McEvoy, and Simon Dennis. 2000. What Is Free Association and What Does It Measure?. *Memory and Cognition* 28 (6): 887–99.
- Rosch, E., and B. B. Lloyd, B. B. 1978. Eds, cognition and categorization.
- R Core Team. 2021. R: A language and environment for statistical computing. R Foundation for Statistical Computing, Vienna, Austria. URL <https://www.R-project.org/>.
- Uusküla, M. (2007). The basic colour terms of Finnish. *SKY Journal of linguistics*, 20,367.

# Design Semantics Database: Towards an analytical and logical approach for meaningful design

Inez Michiels <sup>1,\*</sup>

<sup>1</sup> CITY OF 8, design semantics research association; inez.michiels@gmail.com

\* Corresponding author: inez.michiels@gmail.com

## Abstract

The present paper discusses the DSD, a design semantics database for the applied and liberal creative professions. This online application (knum.club) helps to create meaningful psychologically appealing design and to analyse whether the envisaged values, identity or emotions of a design are effectively communicated. The DSD is a scientifically based design tool that offers information on the meaning and the emotional effect of keywords, colours, colour combinations, forms and compositions, textures, tastes, and postures. A logical data structure, wherein colour functions as a classification system, forms the framework in which the keywords and design elements are classified and connected. As such the DSD offers a unique source of design information bringing intuition to the surface and enhancing it.

**Keywords:** *design, semantics, synaesthetic, intuition, emotion*

## INTRODUCTION

When in 1993 Apple's Donald Norman introduced the User-centered design, he not only shifted the focus towards the user of a product or service, but also permanently established the scientific approach to the design process. Today designers more than ever have to take into account the user's values, motives, and experience of a design when deciding on a specific course of action for their projects. To complicate things further, hundreds of research papers are published annually, each of which sheds light on specialized aspects of the relation between user and design. The DSD meets the need for practical information that paves the way for the creation of psychologically appealing, meaningful design. With a logical classification architecture that taps into the innate human language and sign system, the DSD is a unique source of information and inspiration for highlighting intuitive creativity. It is the culmination of decades of study and research that synthesizes some of the findings and insights of anthropologists, philosophers, sociologists, neurologists, biologists, A.I. scientists, psychologists, marketing specialists, graphic designers, artists, architects, and product developers in a single logically consultative application. In its present form the application hosts around 1500 keywords connected to many design elements. The database further offers quotes from over 160 books and scientific research papers.

## A THREE-DIMENSIONAL FRAMEWORK

But the DSD is not a random collection of information. What makes the database unique is the way in which the information is structured. It is based on the blueprint of the Semantic Colour Space as presented by Alpaerts and Michiels during the 2019 Buenos Aires AIC congress. The skeletal framework on which keywords, colours, shapes, compositions, textures, tastes, and postures are classified and interconnected starts from a three dimensional cube-shaped model that may be expanded (8, 8x8, 64x64,...). In this spatial model hierarchical levels, orientational meaning, and synaesthetic connections become possible.

Each dimension in the space represents one aspect of the meaning (Alpaerts and Michiels 2019). The spatial position and direction allocated to each sign or keyword is determined by the shifters front/rear, up/under, and left/right, represented by binary triplet codes (codons). E.g. "pleasant" gets

the codon 111, where the first digit indicates closeness (front), the second not dominating (under), the third stands for arousing (right). This enables the user to logically understand and situate the meaning of keywords associated with the design elements within this spatial framework. Shifts in meaning and their ramifications for a design can thus be anticipated and evaluated.

The three-dimensional model implies that the information is hierarchically arranged in levels. Each visual element and keyword has its logical place, ranging either from the simplest and most basic of tiers (dimensional level) up to the complexity of combinations of signs and meaning on the highest level (8- and 64-level). The nodes of meaning are connected both inter and cross-level through a comprehensive semantic network.

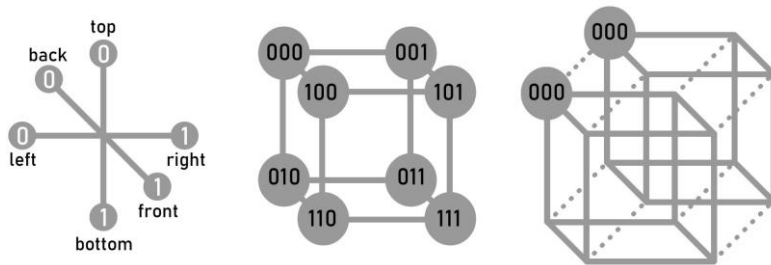

Figure 1: Levels of meaning: dimensional, 8-level, 64-level.

### The dimensional level

Within the semantic space the dimensions depth, height and breath contain the most simple keywords that always appear in oppositional pairs. Those are the basic parameters of emotion, psychology, colour, shape, composition, texture and posture such as among others cold/warm (depth), dominant/compliant (height), square/rounded (breath).

### The 8-level

The parameters from the dimensional level form the basis for the 8 primary clusters of meaning, each of which is represented by a codon. This 8-level comprises more complex words such as the basic colour names “blue”, “red”, etc., or simple words such as “earth”, and “fire”. Often these keywords also have an antonym. E.g. the antonym for “earth” is “heaven”, and for “fire” it is “water”. These 8 clusters of meaning are situated on the eight corners of the semantic cube.

### The 64-level

When doubling the cube (8x8) the distinction and the mutual relation between the first and the second cube can be compared to the relationship between nouns and adjectives. By adding an adjective to a substantive keyword, the content of the noun is modified by the adjective. E.g. the red hat, where “hat” gives the basic meaning and “red” the adjective. “Red” is a quality or a manner of “hat” and modifies the meaning. This furthers the potential for growth or refinement of signification. Semantics forerunner Charles Sanders Peirce (1839–1914) already realised how the meaning of signs can grow and become more complex by combinations of signs. The latter can be effected by using adjectives. In two-colour combinations the bottom or background colour is the noun, and the top colour is the adjective. On the 64-level we find the composed and more complex words such as “blue-green”, “azure”, “nature reserve”, “detective”, “cooking”, “law”. In its present shape the DSD offers information up until the 64-level. The model makes it inherently possible to endlessly refine meaning. Expanding it to the 4.096-level (64x64) is a future project.

## SEMANTIC NETWORKS

Each keyword in the DSD is connected by associations to other keywords. Establishing associations appears to be a primary principle of the neocortex (Edelman and Mountcastle 1982). Associations determine the context and clarify the meaning of a keyword. Moreover, the context in which a sign appears is important for the emotional value it evokes (Caivano and López 2006; Oberascher and Gallmetzer 2003). According to Brier (2015), an interpretative process involves fitting a sign into a wider set of circumstances, a context. Depending on the context a certain keyword can obtain several codes. E.g. “pure” can refer to “immaculate” (code 110), “unadulterated” (code 101) or “natural” (code 010). Within identical codons the synonyms, or words closely related to their meaning, make up the connections. Connections to words with different codons are ‘antonyms’, ‘moving-axis’ keywords and ‘comparing’ suggestions. As such the user can travel through the semantic network, and explore shifts in meaning.

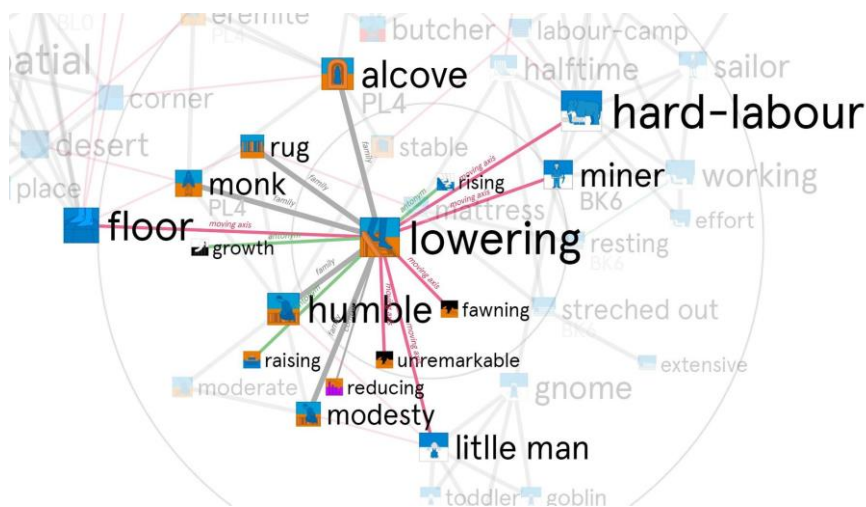

Figure 2: A semantic cluster around the keyword “lowering” with synonyms (fat grey), antonyms (green), moving axis (red) and compare suggestions (thin grey). The icons on the nodes represent an image of the meaning in its colour code.

Antonyms can appear in their coded representations in all sorts of constellations. A complete opposite of meaning is usually also a complete reversal of the digits. E.g. “water” (code 010), is opposite to “fire” (code 101). Or a reversal in one dimension: “bound” (code 001-000) and “liberation” (code 001-010). Other Antonyms may occur in codon reversals such as in “Lowering” (code 000-100), that is opposed to “raising” (code 100-000). Some antonyms have identical codes, as is the case with “love” (a heart) and “resistance” (a fist), both being classified under the code 101.

In the semantic space moving-axis keywords represent shifts in meaning that occur in only one dimension, either depth, height, or width. E.g. the meaning of “lowering” (code 000-100) can shift in the basic depth dimension to “floor” (code 000-000).

Comparing suggestions offer related keywords which may need some attention. E.g. a ‘compare’ word for “lowering” is “reducing”. By using their respective associated words the difference between these two notions and their ramifications for a design can be established.

Finally, there are cross-level connections which indicate compositions of meanings. The 64-level keyword “coffin”(code 001-000) e.g. is composed of the 8-level keywords “death” (code 001) and “container” (code 000). In this way a meaning can be traced back to its most basic features.

## ***A NATURAL SOURCE OF INFORMATION***

The DSD spatial framework allows abstract representation of meaning through 3D-coding. The signs and keywords it classifies not only refer to the outside world and to the specific, but at the same time obtain an abstract meaning within a logical organised system, wherein semantic associations, hierarchical levels, orientational meaning and synaesthetic links are part of the equipment. As such, the DSD meets the requirements for a valid semantic structure. The DSD is an approximation of the innate “language of thought” or “inner language” as described by Fodor (1983) and Pinker (1994).

Moreover, the cube-within-cube structure of the DSD reveals a striking similarity to the computer model of the human brain developed by American A.I. scientist and mathematician Marvin Minsky. His “society of mind” theory (1986) regards every naturally evolved cognitive system such as our brain as a society of simple individual processes built by genes. These fundamental entities or “agents” enable us to represent emotional and other states of mind. A likening of these agents to the eight codons from the DSD is obvious. The logical architecture of the database neatly fits in with the functioning of our cognitive system and our emotions. In that sense the DSD can be a natural source of information bringing intuition to the surface and sharpening it.

## ***COLOUR AS A CLASSIFICATION SYSTEM***

In the DSD classification system colour functions as a consequence-rich determinant. The ones and zeros of the machine language are represented by colours, offering immediate possible applications. Colours and colour combinations are extremely important to semantics because of their abstract meaning. The meaning they create in our ‘living computers’, is part of a genetically determined inner language, a world we feel better than we are able to express in words.

There is a lot of confusion about the meaning of colours. Their abstract meaning, represented in the DSD by codons, is universal because it is determined by their psychological characteristics. E.g “red” is extraverted, coming to the fore, also designated as warm, generally experienced as dominating and heavy with a strong activating characteristic. “Red” can be described as extrovert, dominant, and active and so gets its code 101. De first digit 1 (depth) represents the psychologically in-depth effect. The second digit 0 (height) offers an indication of dominance or weight. The third digit 1 (lateral) is determined by the degree of action the colour possesses.

We say the innate abstract meaning is universal. That does not necessarily mean a certain configuration is used or can be perceived in all cultures. It means, however, that this configuration is understood without the need for the traditions of others. Peirce (1839–1914) described the abstract meaning of a sign as follows: “A sign or representamen addresses somebody, that is, creates in the mind of that person an equivalent sign, or perhaps a more developed sign. That sign which it creates I call the interpretant of the first sign. The sign stands for something, its object. It stands for that object, not in all respects, but in reference to a sort of idea, which I have sometimes called the ground of the representamen.”

The abstract meaning or idea cannot, although it is sometimes very clear, be automatically translated into words. There are no strict rules, because language is an open system. The ‘translation’ is more something like putting together a tangram, the Chinese puzzle that suggests a figure. Sentences like “red means love” presuppose a strict, unambiguous relationship. “Red” does not, however, get meaning through “love”. On the contrary, it is the words that get meaning through the colours, they become emotionally coloured as in “love is red”. The abstract meaning of colours is universal, their outer meaning is culturally determined, which does not imply that it is totally conventional.

To understand a sign is to find out in which cell of the abstract codical classification it belongs. 'Understanding' or 'grasping' is fitting the idea or the concept within a cell. The reasons why a sign falls into a certain cell can often be very diverse.

The "earth" is placed under the code 000, which is the codical combination representing the colour blue. The earth is for instance referred to as the 'blue planet'. In many simple illustrations, such as logos, the earth globe is depicted in blue. In Christian images God, who is in heaven, is depicted in yellow against the blue earth he rules over. According to the colour psychologist Heller (1989), blue is the colour of the reunification with (mother) earth and creates calmness. The anthropologist Campbell (1962) explained how Buddhist meditation techniques focus the mind on colours. "The earth, then, was to be seen as lapis lazuli, transparent and radiant." In Egypt as well as in India (Shiva, Vishnu, Krishna) blue has remained the godly colour, not of a heavenly god but of an earth god.

"Earth" is in many traditions the matter from which the (earth) god created the first human being in his own image and likeness, among other the Egyptian and Islamic tradition, in the Gilgamesh-epic and in Judaism. In the book of Genesis Adam, the first man, is created from earth and is therefore called 'Adamah' (Aramaic for earth).

### ***NATURE AND CULTURE***

On the meaning of events different emphasis may be laid in different cultures. The white colour of the bridal dress in a Western wedding ceremony indicates the virginity of the bride, whereas the red colour at Chinese weddings is a reference to happiness. Black clothing that is worn at a Western funeral lays the emphasis on the bereavement, on sadness. Death is considered as a terminus. In Hinduism, people wear white at cremations, but there the emphasis is laid on the reincarnation, the new beginning. White at Muslim burials is worn because of its humility and virtue. The abstract codical meaning is universal, the experience of a specific event is culturally determined.

### ***SYNAESTHETICS***

When we address synaesthetics we are referring to a specific sensory experience that can summon a similar emotional response in a different sensory domain. E.g. experiencing the same emotion when sensing a colour, a shape or a taste. Synaesthesia occurs in the semantic space on the dimensional level. Parameters from one sensory domain transgress via the dimensions to the parameters of a different sensory domain. In the DSD synaesthetic links were forged using scientific research that demonstrated connections between certain sensory domains. E.g. researchers from different domains independently have demonstrated that light colours such as pastels are experienced as being lighter in weight than dark colours. (Meerwein 2007; Alexander and Shansky 1976; Heller 1989). Knowledge of synaesthetics is important for designers who by its application are given bigger control over the power and impact of an anticipated emotional reaction.

### ***WHAT DESIGNERS CAN DO WITH THE DSD***

For designers the DSD is a tool for analysing as well as for creating. Visual design elements can be analysed through the introduction of parameters and keywords, in order to ascertain whether values or identity are effectively communicated, whether visual elements summon those exact emotions that were envisaged. At the same time the DSD is a functional tool during the course of the design process. Designers can check the meaning and emotional effect of any proposed design option in real time. They can underpin their vision for any design proposal with quotes from hundreds of internationally renowned books and papers. Moreover, a time-saving feature is that the design team can be in unison



about the meaning of a keyword prior to the start of the actual design process. The tool can also be of use in research and education. Well-structured data from a research project will lead to better founded conclusions and prevent confusion between different levels and dimensions. In education the DSD provides important possibilities for a scientifically based design method any design student might want to look into.

### **THE FUTURE OF DSD**

This tool has been developed over more than a decade by enthusiastic volunteers. The present editorial panel consists of two people with backgrounds in the humanities, psychology, semantics, and design. The database as presented shows limitations that are of a technical and content-related nature and are mainly due to financial restraints. This makes for a user-friendliness that is not always optimal and an informational range that is not as broad as the developers would like to see. By making the DSD available today they hope to attract an audience that can offer feedback. Furthermore, they strive to make the tool self-sustainable and to expand the editorial board into a culturally and professionally diverse team.

### **REFERENCES**

- Alexander, K. R. and M. S. Shansky. 1976. Influence of hue, value, and chroma on the perceived heaviness of colors. *Perception & Psychophysics*, Vol. 19 (1), 72-74.
- Alpaerts F., and I. Michiels. 2019. The Semantic Colour Space. In: *Proceedings of the International Colour Association (AIC) Conference 2019*. Newtown, NSW, Australia: AIC, 178-183.
- Brier, S. 2015. Finding an information concept suited for a universal theory of information, *Progress in Biophysics and Molecular Biology*. <http://dx.doi.org/10.1016/j.pbiomolbio.2015.06.018>.
- Caivano J. L., and M. A. Lòpez. 2006. Can color be an antiglobalization factor? Analysis of colors in branding. *Secretaría de Investigaciones, Facultad de Arquitectura*, Universidad de Buenos Aires, Argentina.
- Campbell, J. 1962. *The Masks of God 2: Oriental Mythology*. New York: Penguin Random House.
- CITY OF 8. 2021. *Design Semantics Database*. <https://khnum.club/>.
- Edelman, G. M., and V. B. Mountcastle. 1982. *The Mindful Brain. Cortical Organization and the Group-Selective Theory of Higher Brain Function*. Cambridge: MIT press.
- Fodor, J. A. 1983. *The Modularity of Mind: An Essay on Faculty Psychology*. Cambridge, Mass: MIT Press. Print. Turabian (6th ed.).
- Heller, E. 1989. *Wie Farben wirken*. Hamburg: Rowohlt Verlag GmbH.
- Meerwein, R. M. 2007. *Color – Communication in Architectural Space*. Basel: Birkhäuser Verlag AG.
- Minsky M. 1986. *The Society of Mind*. New York: Simon & Schuster.
- Oberascher, L., and M. Gallmetzer. 2003. Colour and Emotion. *Psychology of Architecture and Design, Austria. Proceedings of AIC 2003 Bangkok: Color Communication Management*, 370-374.
- Peirce, C. S. 1866–1913. *The Collected Papers of Charles Sanders Peirce*, abbreviated CP, Vols. I–VI ed. Charles Hartshorne and Paul Weiss (Cambridge, MA: Harvard University Press, 1931–1935), Vols. VII–VIII ed. Arthur W. Burks (same publisher, 1958).
- Pinker, S. 1994. *The Language Instinct*. New York, Penguin Books.

# Interaction of colour and cotton fabric surface coated with ultrafine cellulose (UFC)

Martinia Ira Glogar<sup>1,\*</sup>, Sandra Flinčec Grgac<sup>1</sup>, Antonia Zanchi Sarwari<sup>1</sup> and Jose M. Canal<sup>2</sup>

1 University of Zagreb Faculty of Textile technology 1; martinia.glogar@ttf.unizg.hr; sflincec@ttf.unizg.hr; a.zanchi0209@gmail.com

2 Polytechnic University of Catalonia, Terrassa School of Industrial, Aerospace and Audiovisual Engineering; jose.maria.canal@upc.edu

\* Corresponding author: martinia.glogar@ttf.unizg.hr

## Abstract

In this research the influence of ultrafine cellulose (UFC) coating of cotton fabric, on the colour characteristics of a digitally printed sample was tested. Three pastes with a difference in the amount of binder and crosslinking agent were applied in the layering process. Coated cotton surfaces were digitally printed in a multicolour pattern. The synergy of the two layers (ultra-fine cellulose and pigment layer) was analysed in terms of colouristic, fastness and chemical-physical properties. Wet rubbing resistance of layered surface before printing and washing resistance of layered surface after printing were tested. The morphology of surface structure of the samples was analysed by using FE-SEM (Field Emission - Scanning Electron Microscope). Coloristic parameters were analysed by numerical evaluation and graphical representation of CIELAB colouristic values as well as in terms of CIE colour differences.

**Keywords:** *ultrafine cellulose coating, digital printing, colour characteristics, colour fastness, surface structure*

## INTRODUCTION

Surface modifications of textile materials occupy an increasingly significant scientific research space, in order to achieve functionalization and obtain materials with improved or completely new properties. In the group of renewable, environmentally friendly, nature-derived polymers for advanced material applications, recently, of the greatest interest are cellulose, lignin, starch, chitosan, protein, triglycerides, natural gums and polyphenols. Among them, cellulose is the most widely present in nature, it is renewable, biodegradable, and environmentally friendly, with great potential for the development of new applications in processes of textile fabric functionalization and design; Panchal et al. (2019). Nanocellulose offers possibilities for the future having a property of forming strong, thin and smooth films with great uniformity and flexibility. These characteristics enables nanocellulose to interpolate into woven, knits, nonwoven, and composite textile structures and to bond with hydrogen/covalent bonds and physical interlocking, making a new, functional surface of the material (Saremi et al. 2020; Gardner et al. 2008). Properties such as solvent resistance, colour fastness, air permeability, non-flammability and many others can be achieved, as well as visual and tactile surface properties in terms of aesthetic appearance. In a scope of textile dyeing and printing technologies, Sharma S. and Minko S. with associates demonstrated, that reactive dyeing of cotton with usage of NFC particles can decrease the amount of water, salts and alkali, with no change of the textile performance such as colorfastness, in compare to conventional reactive dyeing process (Kim et al. 2017; Liyanapathirana et al. 2020). However, very little research is found in the literature related to the application of nanocellulose in pre-processing of textiles for printing. In this paper the influence of ultrafine cellulose (UFC) coating on cotton fabric was examined in terms of colour characteristics of a digitally printed samples. Ultrafine cellulose is today one of the finest grade of cellulose coming from natural, renewable resources. Advantages of ultrafine cellulose include reduction of polymer binder, higher smoothness and better printability, improving abrasion resistance (Cichosz et al. 2020). The

Interaction of colour and cotton fabric surface coated with ultrafine cellulose (UFC) synergy of the two layers (ultra-fine cellulose and pigment layer) was analysed and, in addition to testing the colour parameters of the layered and non-layered surfaces of cotton fabric, wet rubbing and washing resistance were tested to determine the print quality and optimize the binder amount. Using the technique of digital InkJet printing, prepared cotton surfaces were printed in a multicolour pattern of characteristic design, which enables a comparison of the treated and untreated surface of the material in terms of colouristic, fastness and chemical-physical properties.

## EXPERIMENTAL SETUP

### Materials and methods

Fabric of 100% cotton, surface weight 226.2 g / m<sup>2</sup> was used for layering. The main component of the layering paste is Arbocel UFC 100. The other components consisted in the layering paste are Helizarin TOW binder, Luprintol CF crosslinker and Lutexal GP ECO thickener. The composition of the three pastes applied in the layering process with a difference in the amount of binder and crosslinking agent, is shown in Table 1.

Components	Paste 1	Paste 2	Paste 3
Arbocel UFC 100	40g/kg	40 g/kg	40 g/kg
Lutexasal GP ECO	11 g/kg	11 g/kg	11 g/kg
Helizarin binder TOW	/	10 g/kg	40 g/kg
Luprintol CF	/	1 g/kg	4 g/kg
H <sub>2</sub> O	949 ml	938 ml	905 ml
Σ	1000 ml	1000 ml	1000 ml

Table 1: Quantities of individual components in layering pastes.



Figure 1: Cotton fabric coated with ultrafine cellulose.

The fabric surface is directly layered using manual flat screen printing (Figure 1). After layering, each sample was dried under 3 min conditions at 110 °C in a Matis AG dryer. After drying, the samples were polymerized in a polymerization machine for 3 min at 150 °C. Layered cotton fabric printing was performed with Azon Tex Pro-Direct to Garment (DTG) ink-jet printer.

Digital printing system using 4 CMYK and 4 white colors with intelligent laser beam. The printer prints in a high resolution of 1440 dpi, at a temperature of 20 to 30 °C, and 40 to 80% relative humidity. The after-printing fixing temperature is 150 °C, with duration of 2 minutes. Wet rubbing testing was performed according to ISO 105x12, in order to determine the stability of the ultrafine cellulose layers, so it was performed on layered samples before printing. The assessment is made on the basis of a grey scale (HRN EN20105-A02 and A03: 2003 visual assessment). The grey rating scale contains a scale of 5 pairs of grey and white color palettes. Each pair of palettes indicates a different degree of contrast with 5 measures. Grades 1 - 5 (1 - large difference between processed and initial sample, 5 - no difference). The wash fastness properties were tested on samples after layering with ultrafine cellulose and printing, according to the norm EN ISO 105 - C06: 2010: Textile - Colourfastness test - Part C06: Stability of dyeing in household and commercial washing. The samples were washed using standard

Interaction of colour and cotton fabric surface coated with ultrafine cellulose (UFC) phosphate-free detergent (ECE Test Detergent 98 without Phosphate, ISO 105-C08 / C09) at 40 °C in laboratory machine Mathis Polycolor. The obtained colorations were evaluated objectively using a remission spectrophotometer DataColor Spectra Flash 600 PLUS – CT. The results are presented as colour parameter numerical values, while the fastness test results are presented in terms of the total colour difference values ( $dE_{CIE76}$ ) obtained by comparing the samples before and after washing. The surface morphology of the treated cotton fabric was examined using a scanning electron microscope (FE-SEM, Tescan, MIRA\LMU, Czech Republic). Before analysis, the samples were coated with a mixture of gold and palladium in the SC7620 Sputter Coater Emitech for 180 seconds to achieve better conductivity.

## RESULTS AND DISCUSSION

Samples coated with pastes 1, 2 and 3, which according to the recipes shown in Table 1, containing ultrafine cellulose and other components in different proportions, were tested on abrasion resistance (wet rubbing test) and the results in terms of grey scale grades are shown in Table 2.

Pastes	1	2	3
GS Grades	1	2	4

Table 2: Grey scale grades of tested samples layered with UFC based pastes 1, 2 and 3

Sample 3 applied with the paste with the highest proportion of binder has the best grade. As expected, sample 1 was rated the lowest grade 1, since the paste does not contain a binder these components in the paste cannot bind to the surface of the fabric. Only Arbocel UFC 100 is on the surface of the layered fabric, and rubbing the layered surface removes its layer.

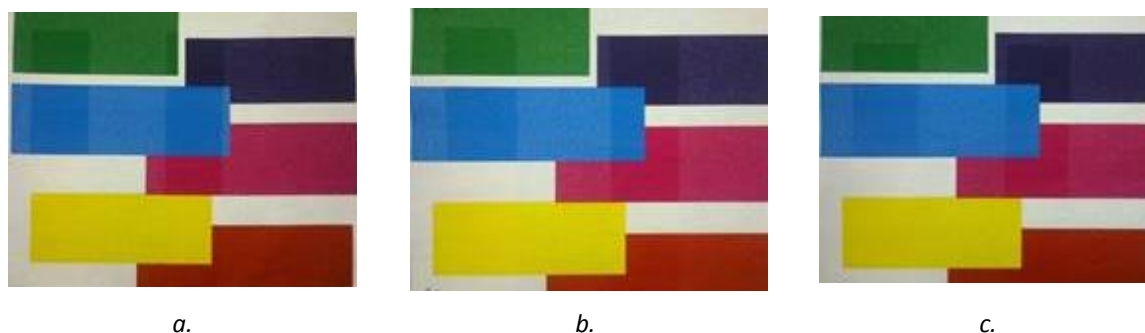

Figure 2: Cotton fabric coated with ultrafine cellulose printed in prepared scheme: a. - sample layered with Paste 1; b. - sample layered with Paste 2; c. - sample layered with Paste 3.

Furtherly, samples were printed by digital InkJet method according to the previously prepared printing scheme shown in the sample in Figure 2 (a, b and c). On all three samples, the difference in colour characteristic between the layered and non-layered surface is visible. On the untreated surface, a higher lightness is observed in all printed surfaces, regardless of the colour hue. The reason for this is the effect of lower coverage of the surface with pigment caused by the specific structure of the fabric surface and stronger penetration of the pigment into the fabric structure itself. The layering of the fabric with Arbocel UFC caused not only a change in the surface structure but also in the ability of the pigment to penetrate the fabric structure and enabled the retention of pigment on the surface, which provides a more uniform pigment layer on the surface. Namely, Arbocel UFC 100 contains insoluble particles that form a protective layer on the surface of the textile material and thus reduces the

Interaction of colour and cotton fabric surface coated with ultrafine cellulose (UFC) penetration of coloured pigment into the fabric structure, retaining the pigmented layer on the surface of the material.

After the process of digital printing and thermo fixation of prints at a temperature of 160 °C for a period of 2 minutes, a wash fastness test was performed. Objective values of individual colour parameters ( $L^*$ ,  $C^*$ ,  $h^\circ$ ) and values of colour difference ( $dE$ ,  $dL^*$ ,  $dC^*$ ,  $dh$ ) were analysed (Tables 3 and 4).

Samples	UFC Paste 1			UFC Paste 2			UFC Paste 3		
	$L^*$	$C^*$	$h^\circ$	$L^*$	$C^*$	$h^\circ$	$L^*$	$C^*$	$h^\circ$
White - non coated	92.4	3.1	86.9	92.3	3.1	87.2	92.4	3.2	88.2
White - UFC coated	93.2	5.8	88.8	93.1	6.3	89.4	92.9	6.3	89.3
Green - non coated	49.8	31.8	137.6	50.2	31.2	137.5	51.1	31.5	136.7
Green - UFC coated	37.7	29.0	142.1	37.3	30.1	141.5	38.7	30.4	140.7
Violet - non coated	41.4	24.4	295.8	40.8	24.8	296.1	40.8	23.9	263.2
Violet - UFC coated	25.9	23.6	299.8	25.1	23.2	297.4	26.8	23.8	265.1
Blue - non coated	44.7	43.3	263.7	45.9	42.5	263.2	45.5	42.8	296.7
Blue - UFC coated	41.5	45.1	265.5	41.2	45.6	265.2	42.3	43.9	295.4
Magenta - non coated	53.6	44.1	355.7	53.4	43.9	355.0	52.6	44.2	355.8
Magenta - UFC coated	44.7	49.8	6.8	43.5	51.3	9.6	44.5	50.1	7.5
Yellow - non coated	82.7	83.3	97.6	82.9	82.8	97.5	82.9	82.9	97.3
Yellow - UFC coated	84.4	95.5	92.8	84.1	95.4	93.2	83.9	95.2	93.9
Red - non coated	57.5	47.9	38.8	56.8	48.6	38.6	55.5	49.1	38.4
Red - UFC coated	48.4	61.7	40.0	47.7	61.8	38.9	48.9	61.4	38.8

Table 3: Colouristic parameters of printed samples regarding the influence of UFC coating.

It is immediately noticeable that the obtained ratio of lightness ( $L^*$ ) and colour chroma ( $C^*$ ) between layered and non-layered surfaces is in accordance with the spectral nature of the colour itself. For green and violet colour shades, although a significant difference in lightness was obtained, the difference in chroma is insignificant. In fact, for the green colour, the chroma of the layered surface of the sample is even slightly lower than the non-layered part, which differs from the results obtained for other colours. Green is a colour of naturally medium lightness, ie green, unlike other colours, is characterized by the ability of achieving maximal chroma at several medium levels of lightness (approximately  $L^*=30$  to  $L^*=50$ ). Precisely for this reason, green does not have a difference in chroma in this range of lightness. Violet is a naturally darker colour, which means that it reaches its maximal chroma at lower lightness levels up to approximately  $L^*=40$ . Therefore, the obtained results are exactly in accordance with the theory of naturally light and naturally dark colours, which was set by Henry Albert Munsell. The influence of the spectral nature of the colour is most pronounced in the yellow colour for which a significant difference in chroma was obtained between the layered and non-layered part of the sample. Yellow is the brightest and most brilliant colour of the spectrum that can achieve high chroma at the highest lightness levels and therefore yellow, with minimal change in lightness, produces pronounced differences in chroma, which arises from the difference in surface coverage and pigment surface retention due to ultrafine cellulose. In the further work, the analysis of the colour change in wash fastness testing of the printed surfaces was performed. Considering the extremely extensive analysis and the large number of obtained data, and considering that uniform differences were obtained for each individual printed colour in the pattern, colour differences between samples

Interaction of colour and cotton fabric surface coated with ultrafine cellulose (UFC) before and after wash test, are shown only for the green colour as an optimal indicator of the behaviour and changes of all printed colours (Table 4).

Standard (before wash test)	Sample (after wash test)	dL*	dC*	dh	dE
Green - non coated	Green - non coated - W	-0,67	0,13	0,16	0,7
Green - UFC coated (Paste 1)	Green - UFC coated (Paste 1) W	-0,59	0,01	0,2	0,62
Green - UFC coated (Paste 2)	Green - UFC coated (Paste 2) W	-0,43	-0,4	0,45	0,75
Green - UFC coated (Paste 3)	Green - UFC coated (Paste 3) W	0,29	0,47	-0,23	0,6

Table 4: Colour differences of printed samples regarding the UFC coating, compared before and after wash test

The results obtained by comparing the green printed non-layered surface of the sample, before and after the wash test, show minimal changes in colour, which confirms the optimal wash fastness of the print. Furtherly, results of comparison of coloured surfaces printed on parts of the substrate coated with Arbocel UFC 100 pastes 1, 2 and 3, are shown. The unwashed samples were selected as the reference sample, with which the washed samples were compared separately for each application of Arbocel UFC 100. Considering the obtained uniform colour differences with respect to the amount of binder in UFC-based pastes (Pastes 1, 2 and 3), it can be confirmed that optimal wash fastness can be obtained with even the smallest amount of binder present. Lower binder content results in a softer, thinner and more flexible layer, which has a positive effect on the visual and tactile properties of the layered parts of the sample. Figure 3 shows a comparison of samples layered with UFC-based pastes 1, 2, and 3, with respect to surface morphology and wash test. Again, the examples of green printed patches are shown. The washed samples are assigned with "W". Regardless of the uniform colour difference results obtained with respect to surface coverage and layering, images of surface morphological structure indicate a difference in layer thickness and surface coverage by UFC layer and pigment. As expected, the thickest layer with the highest surface coverage can be seen for the sample layered with UFC-based paste 3, with the highest binder content. But, as previous results have confirmed, this does not affect the colour fastness under care conditions.

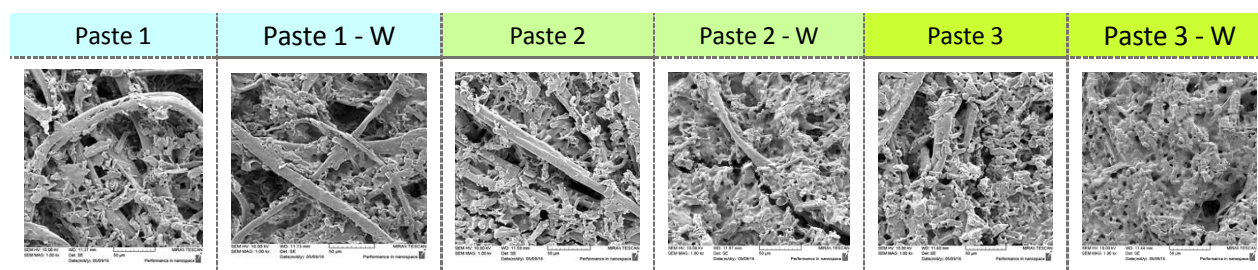

Figure 3: Morphology of surfaces of printed samples regarding the coating with UFC-based pastes 1, 2 and 3 - scanning resolution x 1000.

## CONCLUSIONS

Pre-treatment processes were carried out to modify the surface of the cotton fabric for the purpose of functionalization and design of cellulosic materials. The application of ultrafine cellulose gave the effect of a thinner and more flexible polymer layer that binds the pigment to the textile surface, with a significant matte effect that can be considered an added value, since common binders used in pigment digital printing give unnatural surface gloss. Also, the advantage of UFC is that, unlike conventional binders, it does not completely cover the natural surface structure of the textile material and thus does not negate the natural physical-mechanical and surface-structural properties of the textile. The fastness tests further confirmed that the amount of binder contained in the UFC based paste will not significantly affect the wash fastness, but has significance in the wet rubbing fastness of the UFC layer.

## REFERENCES

- Cichosz, S., A. Masek, and A. Rylski. 2020. Cellulose modification for improved compatibility with the polymer matrix: Mechanical characterization of the composite material. *Materials* 13: 2-18
- Gardner, D. J., G. S. Oporto, R. Mills, and M. A. S. A. Samir. 2008. Adhesion and surface issue in cellulose and nanocellulose. *Journal of Adhesion Science and Technology*, 22: 545-567
- Kim, Y., L. T. McCoy, E. Lee, H. Lee, R. Saremi, C. Feit, I. R. Hardin, S. Sharma, S. Mani, and S. Minko. 2017. Environmentally sound textile dyeing technology with nanofibrillated cellulose. *Green Chemistry* 19: 4031–4035
- Liyanapathirana, A., M. J. Pena, S. Sharma, and S. Minko. 2020. Nanocellulose-Based Sustainable Dyeing of Cotton Textiles with Minimized Water Pollution. *ACS Omega* 5: 9196–9203
- Panchal, P., E. Ogunsona, and T. Mekonnen. 2019. Trends in Advanced Functional Material Applications of Nanocellulose, *Processes* 7: 2-27
- Saremi, R., N. Borodinov, A. M. Laradji, S. Sharma, I. Luzinov and S. Mynko. 2020. Adhesion and Stability of Nanocellulose Coatings on Flat Polymer Films and Textiles. *Molecules* 25: 2-18

# Colour–cognitive performance interaction in Virtual Reality (VR): A study of gender differences

Guobin Xia <sup>1,2\*</sup>, Philip Henry <sup>1</sup>, Francisco Queiroz <sup>1</sup>, Stephen Westland <sup>1</sup> and Luwen Yu <sup>1</sup>

<sup>1</sup> School of Design, University of Leeds, UK ; sdx@leeds.ac.uk, P.M.Henry@leeds.ac.uk,  
F.Queiroz@leeds.ac.uk, S.Westland@leeds.ac.uk, ml1412y@leeds.ac.uk

<sup>2</sup> School of Textile and Design, Herriot-Watt University, UK; g.xia@hw.ac.uk

\* Corresponding author: g.xia@hw.ac.uk

## Abstract

The immersive qualities of Virtual Reality (VR) technologies offer an enhanced environment for design research. In this study the potential of colour to influence cognitive performance in VR is explored. A series of psychometric experiments were conducted where selected colours were presented to the participants whilst in a dark neutral VR room setting. Cognitive performance was evaluated via a series of single choice tests (i.e., tests assessing people’s logical and lateral thinking abilities) in a dark environment delivered via a HTC VIVE VR headset. A total of 18 male and 17 female Chinese students between the ages of 20–25 years participated in the experiments. The results indicate that colours delivered via a VR headset can have arousing and impulsive effects on people’s cognitive performance. Specifically, female participants made more errors with the yellow backgrounds but fewer errors with the orange backgrounds than male participants. This suggests that gender differences exist in the effects of colour stimuli on people’s cognitive performance in VR environments.

**Keywords:** *gender difference, colour psychology, arousal, impulsiveness, virtual reality*

## INTRODUCTION

This paper presents new insights from comparative experiments investigating the impacts of hue stimuli on cognitive performance between reality and immersive VR environments but focus on the analysis of gender differences in the VR session. The immersive potential of VR technologies offers a powerful tool to build on a vast range of research and applications involving entertainments, education, architecture, and healthcare (Hock et al. 2017; Bracq et al. 2019; Hayes and Johnson 2019; Li and Xu 2020), and is likely to be a significant platform in the future digital landscape. In line with these observations, this study highlights that immersion and presence as key features of the VR experience. The objective aspect of sensory fidelity of the VR technology is known as the immersion. Presence refers to a user’s subjective responses of perception of the VR environment, even when he/she is physically located in another place. However, there are questions regarding how well the immersive experience is fully understood and whether there is potential to increase the immersion and engagement? Arousal and impulsiveness are two crucial factors that regulate someone’s presence, engagement, and performance and these factors are shown to be evoked by certain colours (Zhang 2019). Significant contributions have been made by Ilie et al. (2008), Duan et al. (2018), and Xia et al. (2021) in experiments that typically have used neuropsychological cognitive measure approaches as investigative techniques. Their results demonstrate the effects of colour on people’s arousal and impulsiveness. Participants were generally shown colours through less immersive technologies such as computer monitors in dark laboratory settings in these studies. Whilst these methods deliver valuable evidence and have produced some significant design potential of colour on arousal and impulsiveness, the question of whether the same effects occur in immersive VR environments is relatively unknown.

Experimental observations concerning colour psychology also indicate that factors including age (Dittmar 2001), gender (Funk and Ndubisi 2006), and geographical region (Shin et al. 2012) may affect colour preference. Males and females have been reported to have substantial differences in



their favourite colours (Helson and Lansford 1970; McManus et al. 1981; Senju et al. 2004; Ling et al. 2006). However, conflicting opinions exist given that no gender differences were observed in their experimental works (Ou et al. 2004a, 2004b; Duan et al. 2018; Chen et al. 2020), and this lead to questions as to whether there are gender differences in relation to the colour stimuli on arousal and impulsiveness?

### **EXPERIMENTAL**

In this study, a series of psychometric experiments were conducted where selected colours were presented to the participants in an otherwise dark neutral VR room setting (Figure 1(a)(b)).



(a)

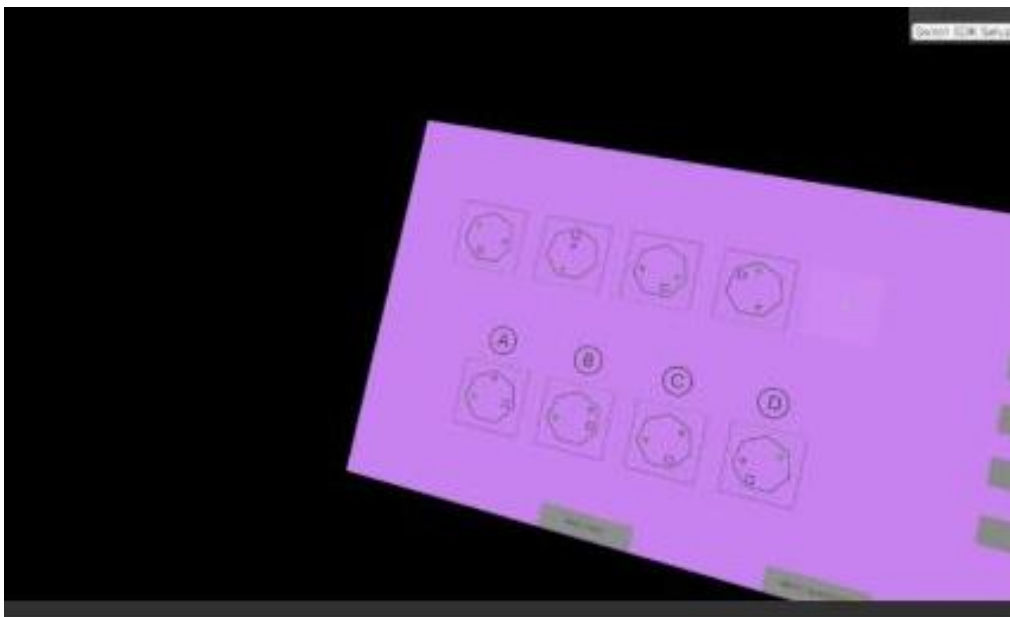

(b)

Figure 1: (a) Individual participant using HTC VIVE VR headset to complete each question; (b) An example of question displayed in the VR environment.

The six colour patches and an equally luminous white reference colour (used as a control) were used as the background colour for a series of questions and adjusted to have a similar lightness and chroma based on the CIELAB values presented through the lens of a VR headset measured by the X-rite i1 Pro in dark laboratory settings (Table 1). The six colour were selected from an Adobe HSB colour system based on former studies by Duan et al. (2018), Eysenck (1941), Yu et al. (2018) and Singh (2006). Cognitive performance was evaluated via series of single choice tests. A logic rule test and mathematics sequence test assessed logic, a spatial structure test and rotation test assessed lateral thinking abilities, and an odd one out and same detail test assessed detailed abilities. This was conducted in a dark environment via an HTC VIVE VR headset. A total of 18 male and 17 female Chinese students from the department of animation, between the ages of 20–25 years, participated in the experiments. All participants were asked to complete the Ishihara colour vision test before entering the room to confirm that they had normal colour recognition ability. After passing the test, the instructions for the experiment were given to each participant, followed by a series of sample tasks including each type of psychometric test to familiarise participants with the process before beginning the main experiment. After completing the task, participants were asked to focus on the white reference background through the VR headset for five minutes to adapt to the conditions. The main experiment began five minutes after they had adapted to the experimental conditions.

Colours	L*	C*	h	a*	b*	R	G	B
Visual								
Reference	72.12	0.49	29.67	0.22	0.19	171.27	170.01	169.86
White								
Red	70.31	70.34	32.83	25.31	34.33	244.31	121.54	103.56
Yellow	70.36	68.05	97.79	-23.83	54.80	187.82	175.99	19.87
Blue	69.32	64.87	288.17	34.01	-35.66	110.09	158.86	255.00
Green	68.89	67.15	178.62	-54.11	-4.18	62.76	193.52	156.59
Orange	69.46	67.66	69.21	-1.63	55.99	242.31	154.31	55.88
Purple	70.57	67.63	321.05	47.39	-22.38	221.76	129.76	243.86

Table 1: The characteristics of the background colours within the VR headset.

## RESULTS AND DISCUSSION

The results are evaluated in terms of participants' error rate and response time when completing a series of single choice tests. Specifically, error rate and response time have shown to be effective indicators and evidenced in a series of psychology literature to study people's arousing and impulsive state (Arnett and Newman 2000; Dickman 2000; Weafer et al. 2013; Duan et al. 2018). A multivariate analysis of variance (MANOVA) was used to analyse a total of 1470 responses (35 participants x 42 questions per participant) obtained from the experiment, and each coloured background was assessed by 35 participants 210 times (each coloured background was assessed six times by each participant). The colours of the backgrounds and the order of presentation of each question were randomised for each participant. The purpose of this was to ensure that if one of the questions were slightly harder, it would be equally likely to have any of the backgrounds and would remove bias.

The results indicate that colours delivered via a VR headset can have arousing and impulsive effects on people's cognitive performance (see Figure 2). It is evident from Figure 2 (A) and (B) that there was a general impact of colour viewed in VR on response time and error rate during the tasks.

Specifically, female participants made more errors with the yellow backgrounds ( $p = 0.030$ ) but fewer errors with the orange backgrounds ( $p = 0.002$ ) than male participants. As such, it is reasonable to suggest that gender differences do exist in the effects of colour stimuli on people’s cognitive performance in VR environments.

When it came to the response time, both male and female participants viewing the green background gave the fastest responses, while participants viewing the yellow background gave the slowest responses. When considering both the response time and error rate (Figure 2 (C) and (D)), it is clear that both male and female participants viewing the yellow backgrounds experienced the lowest arousal state, and the green and blue backgrounds caused a relatively higher arousal state. Orange, purple and red were located in the high impulsivity quadrant. Male participants experienced the highest impulsivity state with the orange backgrounds.

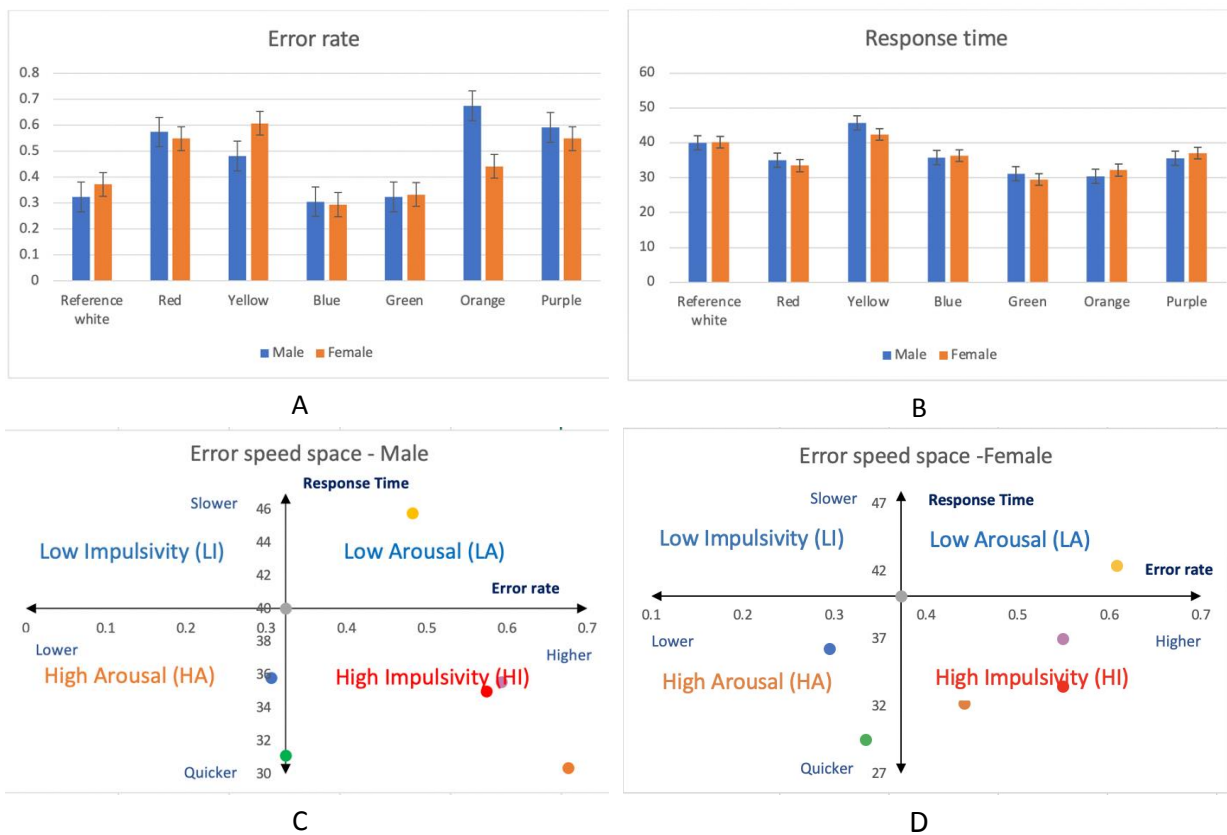

Figure 2: (A) General trend of error rate of male and female participants in completing single choice tests by background colours in virtual reality (VR); (B) General trend of response time of male and female participants in completing single choice tests by background colours in virtual reality (VR); (C) Colour impacts on male participants in VR visualized in the Error-speed space; (D) Colour impacts on female participants in VR visualized in the Error-speed space.

## CONCLUSION

This study explores the design potential of colours to create positive immersion for VR applications but emphasis on the analysis of gender differences. Psychological experiments were carried out to validate the impacts of hue stimuli on people’s cognitive performance via immersive VR equipment. The results of this study are an important contribution to the knowledge of immersive VR design. Data obtained from the experiments showed that specific colours could significantly influence people’s arousal and impulsiveness, suggesting that colour has an indirect impact on a person’s

presence and cognitive performance, in line with previous findings (Ilie et al. 2008; Zhang 2019). Moreover, we found some evidence that differences in colour cognitive performance between the genders do exist. Specifically, the results showed that male participants made fewer errors with the yellow backgrounds but more errors with the orange backgrounds than female participants. The results of this study are somehow similar to a colour preference study by McManus et al. (1981) that found that males showed a greater preference for yellow and a lesser preference for red compared to females. This suggests that the gender differences in cognitive performance may be relevant to colour preference. However, this study has certain limitations. Firstly, all participants were aged from 20 to 25, and thus the findings might not be applicable to children and the elderly. All the participants were Chinese students; therefore, culture may be considered an influencing factor. Also, since all participants involved in this study were students from the animation department and so are good at lateral thinking, it suggests that colour might have a different impact on lateral and logical thinkers. Although designed to ensure consistency, the participant choice standards could be considered a study limitation. Generally, the findings may encourage VR developers and researchers to consider the effective use of colour to create positive immersion in the experience, and to improve people's presence, engagement and performance when navigating immersive VR environments.

### **ACKNOWLEDGEMENTS**

We appreciate all participants who took part in the experiment.

### **REFERENCES**

- Arnett, P. A., and J. P. Newman. 2000. Gray's three-arousal model: An empirical investigation. *Personality and Individual Differences* 28: 1171-1189.
- Bracq, M. S., E. Michinov, and P. Jannin. 2019. Virtual reality simulation in nontechnical skills training for healthcare professionals: a systematic review. *Simulation in Healthcare* 14: 188-194.
- Chen, W., Z. Huang, L. Rao, Z. Hou, and Q. Liu. 2020. Research on Colour Visual Preference of Light Source for Black and White Objects. *Advanced Graphic Communication, Printing and Packaging Technology* 600: 43-50.
- Dickman, S. J. 2000. Impulsivity, arousal and attention. *Personality and Individual Differences* 28: 563-581.
- Dittmar, M. J. G. 2001. *Changing colour preferences with ageing: A comparative study on younger and older native Germans aged 19–90 years* 47: 219-226.
- Duan, Y., P. Rhodes, and V. Cheung. 2018. The Influence of Color on Impulsivity and Arousal: Part 1 – Hue. *Color Research and Application* 43 (3): 396-404.
- Eysenck, H. J. 1941. A Critical and Experimental Study of Colour Preferences. *The American journal of psychology* 54: 385-394.
- Funk, D., and N. O. Ndubisi. 2006. Colour and product choice: a study of gender roles. *Management Research News* 29(1/2): 41-52.
- Hayes, A., and K. Johnson. 2019. Cultural embodiment in virtual reality education and training: A reflection on representation of diversity. In: Chang, M. et al. (eds.) *Foundations and Trends in Smart Learning. Lecture Notes in Educational Technology*. Springer, Singapore, 93-96.
- Helson, H., and T. Lansford. 1970. The role of spectral energy of source and background color in the pleasantness of object colors. *Applied Optics* 9(7): 1513-1562.

- Hock, P., S. Benedikter, J. Gugenheimer, and E. Rukzio. Carvr. 2017. Enabling in-car virtual reality entertainment. In: *Proceedings of the 2017 CHI Conference on Human Factors in Computing Systems*, 4034-4044.
- Ilie, A., S. Ioan, L. Zagrean, M. J. C. Moldovan, and Behavior. 2008. Better to be red than blue in virtual competition. *Cyberpsychology and Behavior* 11: 375-377.
- Li, R., and D. Xu. 2020. Distribution of Landscape Architecture Based on 3D Images and Virtual Reality Rationality Study. *IEEE Access* 8: 140161-140170.
- Ling, Y., A. Hurlbert, and L. Robinson. 2006. Sex differences in colour preference. *Progress in colour studies* 2: 173-188.
- Mcmanus, I. C., A. L. Jones, and J. Cottrell. 1981. The aesthetics of colour. *Perception* 10(6): 651-666.
- Ou, L. C., M. R. Luo, A. Woodcock, and A. Wright. 2004. A study of colour emotion and colour preference. Part I: Colour emotions for single colours. *Color Research and Application* 29: 232-240.
- Ou, L. C., M. R. Luo, A. Woodcock, and A. Wright. 2004b. A study of colour emotion and colour preference. Part III: Colour preference modeling. *Color Research and Application* 29: 381-389.
- Senju, A., Y. Tojo, H. Dairoku, and T. Hasegawa. 2004. Reflexive orienting in response to eye gaze and an arrow in children with and without autism. *Journal of Child Psychology and Psychiatry* 45: 445-458.
- Shin, M. J., S. Westland, E. M. Moore, and Cheung. 2012. Colour preferences for traditional Korean colours. *Journal of International Colour Association* 9: 48-59.
- Singh, S. 2006. Impact of color on marketing. *Management decision* 44(6): 783-789.
- Weafer, J., M. J. Baggott, and H. De Wit. 2013. Test–retest reliability of behavioral measures of impulsive choice, impulsive action, and inattention. *Experimental and clinical psychopharmacology*, 21: 475-481.
- Xia, G., M. Li, P. Henry, S. Westland, F. Queiroz, Q. Peng, and L. Yu. 2021. Aroused and Impulsive Effects of Colour Stimuli on Lateral and Logical Abilities. *Behavioral Sciences* 11: 24.
- Yu, L., S. Westland, Z. Li, Q. Pan, M. J. Shin, and S. Won. 2018. The role of individual colour preferences in consumer purchase decisions. *Color Research and Application* 43: 258-267.
- Zhang, H. 2019. *Exploring engagement in vlogs through content, context and presence*. University of Edinburgh.

# Colour, texture, and luminance: Textile design methods for printing with electroluminescent inks

Delia Dumitrescu <sup>1</sup>, Marjan Kooroshnia <sup>1,\*</sup>, Erin Lewis <sup>1</sup> and Kathryn Walters <sup>1</sup>

<sup>1</sup> The Swedish School of Textiles, University of Borås; delia.dumitrescu@hb.se, marjan.kooroshnia@hb.se, Erin.lewis@hb.se, Kathryn.walter@hb.se

\* Corresponding author: marjan.kooroshnia@hb.se

## Abstract

Smart materials for textile printing present an exploratory design space where the traditional textile methodology of working with colours and print design needs to be revisited to exploit their expressive potential. This research explores the design possibilities presented by electroluminescent inks as printable smart materials for textile design with the aim of expanding the colour palette and its expressive range. Three conventional textile print methods – colour mixing, halftone rasterization, and overlapping – have been investigated through experimental research to expand the design potential of electroluminescent inks, and to analyse the challenges that occur in the surface pattern design process when working with this material. The result presents a set of methods that expand the possibilities of designing with this material: a method of defining diverse colour mixtures, a method for mapping colours using the RGB system, and a method for working with halftone textures.

**Keywords:** *electroluminescent printing, smart textiles, textile design, texture, colour mixing*

## INTRODUCTION

Smart materials as raw materials for design entered textile practice decades ago. Their presence has enriched the material palette traditionally used by textile designers, and the expressive language specific to the field (Kooroshnia 2017). Part of artistic (Layne 2006; Loop. pH n.d.) and research practices (Persson and Worbin 2010; Taylor and Robertson 2014; Jansen 2015), light has proven to be a highly valued design material that has been used to complement the expressive vocabulary of textile design. In these examples which combine light and textile construction methods, light sources have been embedded in the design of textile structures or added by embroidery to the textile surface, defining a new category of textiles. The intangible materiality of light combined with the physicality of textiles produces a hybrid category of expressions resulting from the mixture of these distinct material characteristics: transformative/static, sharp/soft, digital/physical, visual/tactile. These projects exemplify and expand the potential for a textile designer to embed directly light into textile structures. Yet working with light using textile printing methods, which create a flexible light-emitting surface, is still an undeveloped field.

Electroluminescent inks (EL), as a printable light material for surface applications, emit light when electric current is passed through them. While there are exemplary works using EL inks in architecture (Kretzer 2015), interaction design (Franinović and Franzke 2015), interior design (Loop n.d) and product design (Barati et al. 2018; Simon et al. 2014), their focus is on the process of creating light emitting prints, using a single colour of ink, as well as how to control the light. This leaves space for further research exploring the design potential of the raw material – printed EL ink – in terms of expanding its colour palette and aesthetic range by experimenting with textile design methods, e.g. forming diverse colour mixtures, overprinting, and halftones. Thus, this research aims to explore the properties and potential of electroluminescent inks as printable smart colours for textiles, in order to facilitate an understanding of designing with electroluminescent inks in a textile design context. The methods proposed by this research offer new resources for textile surface pattern designers to expand their creativity and craftsmanship in the printing design process.

### Set up for the experimental work

The technique of silkscreen printing by hand was used to print the EL inks directly onto a transparent, conductive surface (polyester ITO film). The size of the silkscreen mesh was 43 threads per inch. The EL ink was covered by a dielectric insulator print layer, followed by a conductive print layer. This sandwiches the EL ink between two conductive electrodes. The print cannot be illuminated to assess the design outcome until all layers have been printed and dried. To see the light range, samples were illuminated within a range of 8VDC to 20VDC through a DC/AC inverter. The 20VDC produced the maximum colour brightness. It is noted that photos taken in darkness were colour-managed to match as closely as possible the perceived appearance of the print when viewed in darkness.

Experiments were conducted using blue, green and orange EL inks (Gwent C2061027P15, C2070209P5, and C2070126P4). The colour palette was obtained with mixes of two-colour blends in 10% increments. Each colour was also printed unmixed (100%), and a 1:1:1 (33% each colour) swatch was printed to test three-colour mixing. The result in daylight was a white print, however, once illuminated with an inverter at 20VDC and viewed in darkness, the effects were different coloured lights similar to mixtures of RGB lights: 80% green and 20% blue produced cyan, 20% green plus 80% orange produced yellow light, and 80% orange and 20% blue produced magenta. The other mixes produced a smooth coloured light gradation. The 1:1:1 swatch appeared as a blue-green light and not white light. This is because white light is produced by the proper mixture of red, green and blue light. The green EL ink is perceived as more toward turquoise, while orange is far from red (Figure 1).

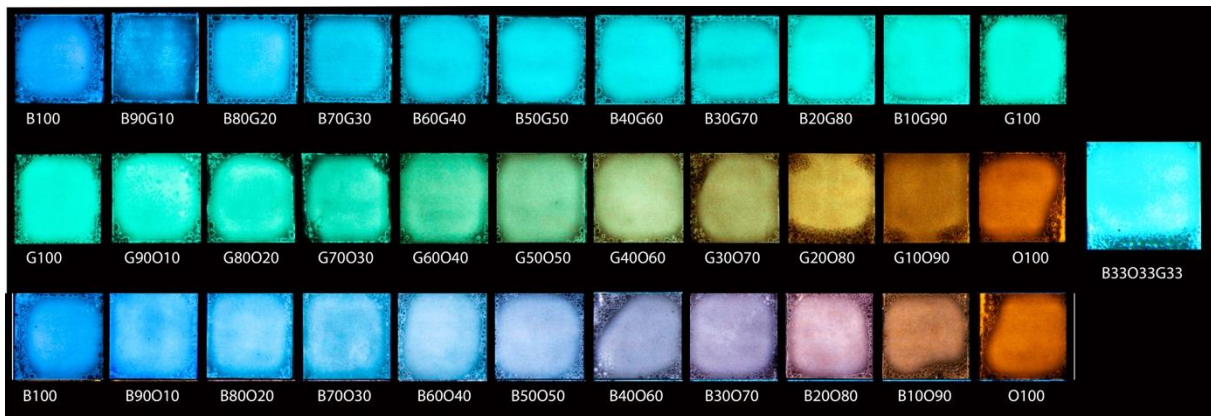

Figure 1: Three colour scales produced by mixing two colours of EL inks using blue, green and orange, illuminated with an inverter at 20VDC and viewed in darkness.

The emitted light of each mixed colour was measured using a colorimeter, resulting in CIE  $L^*a^*b^*$  values for each colour (Figure 2). This provided useful information about the gamut and range of colours available through this method. These RGB figures have been given alongside the measured  $L^*a^*b^*$  values in table 1, and can be used in graphical design software such as Photoshop when designing and preparing patterns for EL prints.



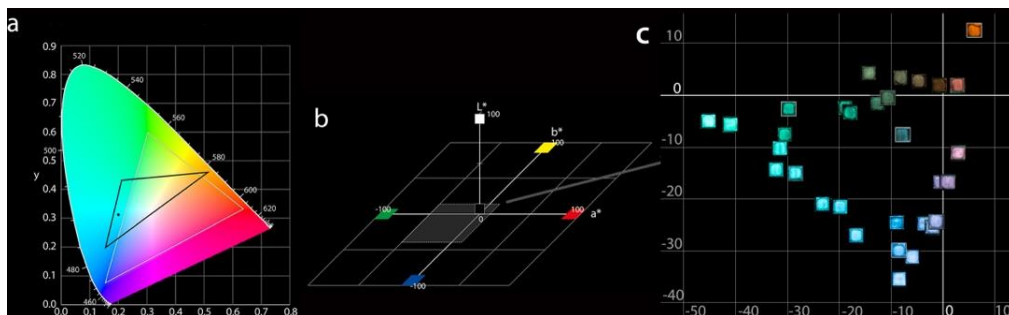

Figure 2: (a) the black triangle shows the gamut of the EL colour mixture palette, with the dot indicating the 1:1:1 colour mixture. The sRGB gamut is included (in grey) for comparison, and shows that the blue and green EL colours and their mixes cannot be represented in an sRGB environment (e.g., on-screen). (b) the CIE L\*a\*b\* colour system, used to measure the colour palette values. (c) the EL colour palette mapped against \*a and \*b values (indicated in figure b by the gray square).

Colour	L*	a*	b*	R	G	B
B33G33O33	5.12	-7.73	-7.67	83	131	140
O10B90	17.4	-8.37	-35.45	173	209	252
O20B80	17.68	-5.86	-31.21	169	201	247
O30B70	12.26	-3.62	-24.91	168	197	244
O40B60	15.31	-2.01	-25.37	174	194	238
O50B50	14.2	-1.37	-24.36	172	183	230
O60B40	10.29	-0.33	-16.8	177	175	219
O70B30	11.16	0.88	-16.56	181	169	211
O80B20	14.66	2.88	-11.04	201	162	186
O90B10	6.98	2.92	1.94	202	146	150
O100	7.64	6.2	12.46	209	113	0
G100O90	1.6	-0.53	1.95	160	115	69
G20O80	4.58	-4.69	2.82	147	133	89
G30O70	6.08	-8.11	3.4	116	121	90
G40O60	8.25	-14.34	4.21	112	129	97
G50O50	5.58	-10.63	-0.43	99	138	108
G60O40	6.05	-12.5	-1.62	92	144	114
G70O30	8.52	-18.83	-2.36	111	200	166
G80O20	8.55	-18.02	-3.3	100	207	176
G90O10	13	-30.73	-7.49	96	219	188
G100	11.63	-29.94	-2.64	90	227	194
B10G90	19.77	-41.13	-5.67	137	243	225
B20G80	23.18	-45.33	-5.03	147	244	232
B30G70	15.44	-31.54	-10.26	139	238	235
B40G60	17.83	-32.38	-14.34	136	236	234
B50G50	16.92	-28.59	-15.04	137	229	237
B60G40	15.97	-23.35	-20.92	131	221	236
B70G30	13.71	-19.99	-21.43	139	220	242
B80G20	15.53	-16.83	-27.02	154	219	248
B90G10	8.79	-9.02	-24.62	157	213	251
B100	12.47	-8.51	-29.9	167	208	253

Table 1: Measured L\*a\*b\* values, and suggested RGB values, for the EL ink colour palette.

### Overprinting

An overprinting experiment was conducted to test the potential for blending colours through overprinting the three unmixed, 100% ink colours. All possible two-colour overprints, including inversion of each overlap order, were tested. It was expected that the effect obtained by the overprinting of two different colours would result in a similar effect as if they were mixed equally and then printed. However, the results indicated that the printing order had a significant impact on the resulting colour when overprinting, with the top layer colour dominating the resulting blended colour (Figure 3). In addition, when the EL prints were activated, they showed some errors such as unwanted particle gathering and uneven paste distribution that occurred during the hand-screen printing process. This observation is important when planning and fabricating high quality designs. This also guided the experimentation towards exploring rasterization.



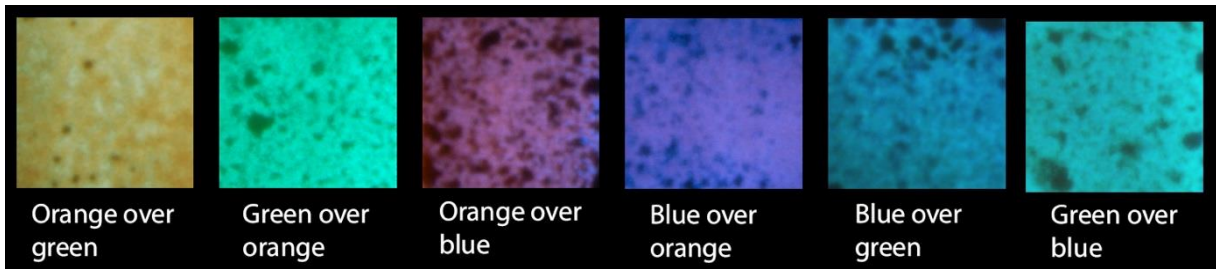

Figure 3: There was a perceivable difference in green on top of orange and orange on top of green, for example; both combinations of orange and green resulted in a different coloured lights.

### Rasterization

An experiment was conducted to determine the best resolution for rasterizing images when printing with EL inks. A stepped gradient, of 10% to 90% density, in 10% increments, was used to create ‘dot’ and 45° ‘line’ halftones, using 30, 25, 20, and 15 lines per inch (lpi). The result after activating the prints indicated that dot halftone had clear definition at low densities, across the range of resolutions from 30 lpi to 15 lpi. The 45° lines, however, were only clear at 20 and 15 lpi, even at low densities. The results of this experiment suggest that coarser resolutions of 15 or 20 lpi are more effective for producing detail, and that either only two or three densities should be used, or lower densities than were tested, to ensure visible differences between areas.

Two set of experiments were conducted to evaluate colour mixing through halftone rasterization, again using the three print paste colours unmixed at 100%. These were split into two colour groups: analogous colours – blue followed by green; and complementary colours – orange followed by blue. The first set (Figure 4, prints 1 and 2) was made using the 20 lpi dots, 15 lpi lines, and 15 lpi dots, each at 10% and 20% density, with the screen slightly offset so the two colours did not overlap and would mix optically. The second set (Figure 4, prints 3 and 4) used the same rasterizations for the first colour layer, however, the second colour layer was printed with 30% and 40% density, turning the screen 180°, so the 15 lpi dots were covered with 20 lpi dots and vice versa. The result indicated that colour mixing using rasterization is different to colour mixing through overprinting the two colours or mixing the two colours. For instance, the colour mixing of 10% blue and 40% green in print number three appeared equivalent to the 20% blue and 80% green mixture in Figure 1, and these were equal in terms of colour proportion but they represented two different coloured light mixtures (Figure 4).

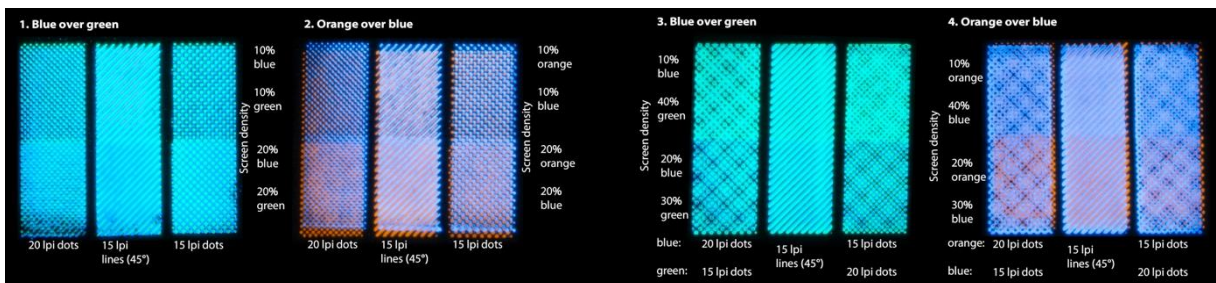

Figure 4: three-dimensional effects were observed in all the prints. In prints, number 3 and 4 moiré effects were created due to the interaction of the different rasterization lpi values for the two overlapping colours.

*Designing surface patterns using EL*

A set of patterns were designed with the aim to exemplify how the different methods for colour mixing developed by this research can be used when forming a design. The surface patterns were designed to emphasise the textural possibilities of this smart material when combined with the textile design methods explored in the experiments. Designed as two-screen prints, and knowing that the colours of positive and negative spaces were reversed in dark conditions (Kooroshnia 2014), the techniques of mixed ink colours, halftone rasterization, and overprinted areas were used to create texture in both the foreground and background of the designs (Figure 5). The results demonstrated the complex visual effects that can be achieved through applying the print and colour mixing methods in this research to EL printing.

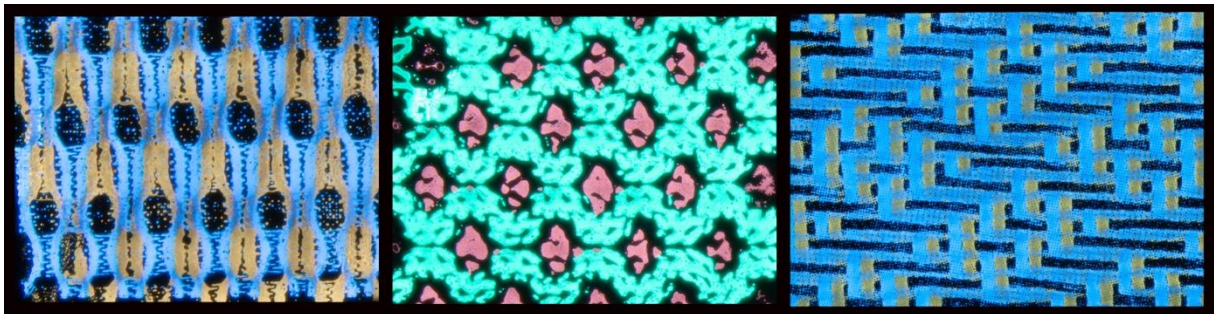

Figure 5: Similar to other surface pattern textile printing pastes, designers can use EL inks for printing light-emitting surface patterns.

**DISCUSSION**

By demonstrating the potential of EL printing when approached using textile design methods such as colour mixing, overprinting, and halftone rasterization, this research expands the design possibilities of this smart material in producing a novel, coloured, textural character to light as a material for design. We suggest digital RGB values for mixed colours, enabling computer simulation of designs, removing some of the risks from this technique, and freeing designers from the flat, monochromatic designs that characterise EL offerings currently.

The experiments were evaluated in darkness using a DC/AC inverter supplied with 20VDC to illuminate the prints. Scaling the DC voltage through 20V, 16V, 12V, and 8V dimmed the coloured lights, creating an illusion of space in the surface pattern (Figure 6). In addition, while EL printing produces static colour, it can be used in the design of segmented displays to produce transformative, digital textiles, and offers an alternative to complex multi-LED arrays, or the linear restrictions of optical fibre. It has the potential to open new territory in textile design for flexible, luminous, and dynamic textile displays with complex textures and surface patterns.

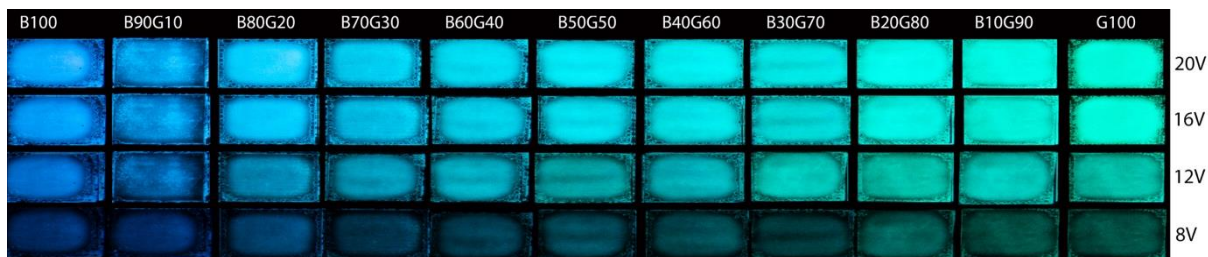

Figure 6: illuminating the prints with 8V creates the dimmest coloured lights and 20V creates the brightest coloured light.

Early experiments conducted as part of this research trialled printing with EL inks on textiles using the textile as substrate and dielectric, printing only with the phosphor ink. The printed fabric was sandwiched between a thin copper sheet as the bottom electrode, and a sheet of ITO-coated polyester film, which served as the top, transparent electrode. However, the prints would only illuminate under heavy pressure, demonstrating the need for the layers to be in close contact along their entire surface. These experiments revealed that more research is needed to improve the technology in order to support future design explorations. However, from a design perspective the replacement of plastics with textiles demonstrated more expressive potential by enhancing the haptic perception of the printed patterns.

The experiments conducted during this research suggest that the print potential of EL inks is wider than has been explored in art, design, and research thus far. Even with the limited colour range of commercially available phosphor inks, broader aesthetic and textural expressions are possible than the flat blue typical of this technology to date. Textile craftsmanship and design methods such as colour mixing, halftone rasterization, and overprinting may be applied to this smart material, and the design potential of these techniques can be used to produce light-emitting smart textiles, where the intangibility of light combines with the physicality of textiles to define a hybrid category of expression.

## REFERENCES

- Barati, B., E. Giaccardi, and E. Karana. 2018. The Making of Performativity in Designing [with] Smart Material Composites. In: *Proceedings of CHI 2018*, April 21–26, Montréal, QC, Canada, 1-11.
- Jansen, B. 2015. *Composing Over Time, Temporal Patterns: In Textile Design*. Ph.D. thesis, University of Borås. Sweden.
- Franinović, K., and L. Franzke. 2015. Luminous Matter: Electroluminescent Paper as an Active Material. *Proceeding of Design and Semantics of Form and Movement conference*, 37-47.
- Kooroshnia, M. 2017. *On textile printing with thermochromic inks*, Ph.D. thesis, The Swedish School of Textiles, University of Borås, Sweden.
- Kooroshnia, M. 2014. Designing two-phase glow-in-the-dark pattern on textiles, *Proceedings of Shapeshifting*, April 2014, Auckland, New Zealand.
- Kretzer, M. 2015. *Information Materials: Emerging Materials for Adaptive Architecture and a Didactic Model for their Architectural Education*. Ph.D. thesis, ETH Zurich.
- Layne, B. 2006. The Wall Hanging: A Site-Sensitive Cloth. *Proceedings of Special Interest Group on Computer Graphics and Interactive Techniques Conference (SIGGRAPH '06)*, New York, 145–es.
- Loop.pH. n.d. Commissions. Accessed 20 June 2021. <http://loop.ph/commissions/>
- Simon, O., M. Wessely, and J. Steimle. 2014. PrintScreen: Fabricating Highly Customizable Thin-film Touch-Displays. In *Proceedings of the 27th Annual ACM Symposium on User Interface Software and Technology (UIST '14)*, New York, 281-290.
- Persson, A., and L. Worbin. 2010. Functional styling: Exploring a textile design space. *DUCK journal for research in textile and textile design*, 1.
- Taylor, S., and S. Robertson. 2014. Digital Lace: A Collision of Responsive Technologies. In *Proceedings of the 2014 ACM International Symposium on Wearable Computers: Adjunct Program (ISWC '14 Adjunct)*, New York, 93-97.

# Color in Fashion Design: orange that changed our perception of Luxury - the use of color at Hermès Paris

Elizaveta Kushnirenko <sup>1,\*</sup>

<sup>1</sup> Polytechnic University of Milan, Milan, Italy; lizakushnirenko@yandex.ru

\* Corresponding author: lizakushnirenko@yandex.ru

## Abstract

Color is an important aspect of fashion design. Every well-known brand relates to this topic with great prudence and seriousness. Color use accompanies designer starting with choosing palette for the logo till the creation of the final product. For the analysis the author chose one of the world's best-known fashion brands Hermès Paris. Current paper is divided in a couple of sections. The first section is devoted to the use of color as a universal language for brand communication and recognition through analysis of Hermès Paris. By studying this phenomenon alternative methods of influence on customer's behaviour from the marketing point of view were discovered. The second section is based on studies made while working at Ratti, world known silk manufacturer. While executing research and development of the textile, not only the color has been taken into consideration but also such aspects as material and finishing that encompass the product design. The formerly conducted study intends to be a future handbook for designers of various disciplines and marketers due to its high applicability.

**Keywords:** *color, textile, fashion, marketing, brand communication*

## INTRODUCTION

The history of fashion is directly linked to the development of color. The two aspects go hand in hand since centuries while mirroring the socio-cultural changes that occur through the history of a human being. Today there is no secret that in ancient times it was possible to identify a person not only according to the style of the dress, but also due to the specific hue the garment was made of. Thus only members of a certain social stratum were allowed to be dressed in color, whereas commoners were dressed in plain clothes (Eiseman and Cutler 2014).

As an example, the ancient Roman story unfolds that the Tyrian purple was so expensive to be produced that a dress made in this specific hue cost loosely its weight in gold, and moreover it was permitted to be used only for Caesar. Anyone else making an attempt to present himself in clothes of this color could face death (Cage 2009: 25). That is how we start to understand that since the ancient times the necessity of color was aimed not only to give pleasure to the human's eyes and to satisfy personal tastes, but it was strictly involved in the development of the society at the particular moment and had even political connotation.

Often it is discussed why people wear what they wear, and in fact it is directly rooted in the social environment and even if today there is no such limits in color use, that is widely influenced by the fact of the technical revolution and the manufacturing advancement all over the world, still we can often question ourselves why people choose one color over the other notwithstanding the difference in the hue can be considered as relatively minor. Any type of activity related to aesthetics and high involvement of personal taste, as for product design or choosing the new hue of the wall paint for a house, is usually highly affected by the preferences and the influence by individual perception of the color, that can be rooted in cultural background and the psychological influence on a specific person.

A particular power of color was noted even by Goethe (1971), though real attention to this topic started to be noted only at the mid of the XX<sup>th</sup> century. Fast and important changes in the development of architectural styles, as Bauhaus in Germany, rapid textile development in USSR at the beginning of

Fashion Design: orange that changed our perception of Luxury - the use of color at Hermès Paris the 20<sup>th</sup> century, capitalistic economic model in the USA, all of these influenced to establish color as an international medium of communication.

In this paper, the author has decided to concentrate on the interrelation between color and fashion industry. In particular, a couple of distinct brands are going to be considered during the analysis. The author will study how color can interrelate with the brand development and market positioning, and later the complexity of the color use in textile manufacturing is going to be described.

There are a couple of examples in the fashion history that prove a significant role of color in the brand development and recognition. Speaking about the world of luxury goods it is impossible not to mention French brand Hermès Paris. Impeccable style and effortless opulence in every detail are not everything what we associate it with, it is also vivid orange packaging box and marigold Kelly bag (Eiseman 2014). Today Hermès Orange is more than just a logo color. It has become a part of the logo and incorporated in brand's perception among the public. Thus orange has not always been part of its identity.

The Hermès' history counts more than 150 years, from 1837 when harness maker Thierry Hermès opened his first workshop in Paris. Over the time, a range of products they were offering expanded and in the mids of the 20<sup>th</sup> century the fashion accessories have been added in their portfolio. Initially the packs of Hermès were of light beige color and as the history unfolds, the development of the color was linked directly to the chronicle of Paris and the Europe.

During the World War II Paris and Europe in general were facing tremendous shortage of food, goods and all the essential products. That is how once run out of the packing stock, Emile-Maurice Hermès had no other choice but to take the boxes of the color no one else wanted. Left with no option, he decided to sell goods in orange packages adding brown ribbon on the top of each box. That was the beginning of the birth of Hermès' corporate color due to the social conditions.



Figure 1: The history of the most iconic color of luxury: How the orange nuance was chosen as the symbol of Hermès.



## **COLOR PSYCHOLOGY AND BRAND DEVELOPMENT**

The brand color palette for Hermès is said to be chosen accidentally and probably the pure chance can attribute to the brand's success in a way. There can be various means the brand is manipulating the consumer's taste and behaviour, though it is worth remembering that a human being is highly responsive to the external stimulus that activate psychological and physiological responses.

As the brand is usually associated with reverberant orange, it has the vibrancy and can be seen as an energetic shot that brings joy and positivity. Being an offspring of the red hue, it still has more subtle and delicate nuance and is less aggressive. Proximity to red and yellow defines its dynamism of red and juicy radiance of yellow.

Orange is unarguably the most sociable hue - it immediately attracts attention, drives the wish for communication and enhances curiosity. Having the red's warm and reach undertones, orange has a capacity to win easily over the people in a friendly manner. It falls into the category of high-arousal color that trigger socialisation and appetite. On the physical level it foster spontaneity and creativity Eiseman (2017: 90).

The addition of the brown ribbon to the packaging played some additional role in the brand perception. Initially brown couldn't boast of the reputation of a luxurious color but with the time it has gained different connotation. Today rich brown hue is associated with refinement, coziness and delight. It is hue of delicious deep coffee smell, taste of Swiss chocolate, cashmere polo and horseback riding. So basically the synonym of tradition, elegance and impeccable style. Coming from the same color family, both Orange and Brown compose a perfect duo that bring feelings of tradition, hospitality and optimism.

The 20<sup>th</sup> century was contrapuntal not only in terms of global changes of political paradigms but also in establishment of new type of relations between manufacturer and the customer. Constructing big mills and start of massive production of goods has brought to the stage the problem of competition on the market. In the free market economy every manufacturer started to be concerned not only about the quality of goods produced but also of the need to stand out from the crowd. That was the beginning of the era of global marketing initiatives.

Literally speaking the XX<sup>th</sup> century officially sets the trend for an ideal package. Faber Birren, a real pioneer and one of the first professional practitioners of the color consultancy, had cited in his book "Selling with color" (Birren 1945: 104) a report made by a baker, pointing that the biggest amount of goods are sold in orange or red-orange shades, whereas the most satisfactory colors are warm hues as orange, red, brown, and light blue. His extensive research and analysis of experiments with customer's response to the changes in packaging colors prove that the prevalence of warm shades win attention and preference among the public.

It is worth mentioning that these results are the outcomes of the color perception by the human beings and directly rooted in neurophysiology. The approach to color use is nothing less than a methodic scientific approach to the topic. The personal viewpoint here doesn't play a significant role rather than methodical utilisation of this phenomena of the visual perceptivity.

Red is a color of high perception and preference, so its' derivatives are supposed to possess same or similar qualities depending on the inferior tones of a particular hue. The right balance of red undertones both in the box's orange and the ribbon's brown are probably the key motives for the brand's success from the visual point of view, as Faber Birren mentioned "The first duty of the package is to command the eye. Here color is perhaps vital." Once it is proved to be eye-catching, the package has to sustain in identity creation. The package should be visually pleasant and also be stimulative for positive emotions.

In case of Hermès there is a strong link to the quality of product and clients services, attention to the details and the heritage of the brand. As once Patrick Thomas, president of Hermes until 2014 said: "Not long ago a woman came to us with a saddle, complaining that it had to be sewed up. We checked our archives where we keep track of everything including product repairs and we found out that the saddle was a gift from her grandmother, bought in 1937. Of course we have repaired it." So that is how the visual image of the brand and the quality of services it provides fused in one, create a strong identity in the consumer's mind. It is about recalling memories that imply tangible aspects, as the quality of materials used for the production, but also a set of intangible aspects that reside in one's mind.

### ***COLOR, TEXTILE AND FASHION***

Focusing deeper on the topic of fashion, the author has made a research of the color use in textile production. Following the Master course in the "Color design and technology" there was executed a practical approach to the color utilisation in the fashion industry. While working at Ratti one of the most important in Italy textile production mill, the color use was observed in pattern and textile production.

The author's aim was to observe in detail the whole textile creation process, train color consulting skills and to analyze the problems of color use in textile industry with successive proposals of a problem solving strategy.

For this specific work, the author immersed in trend forecasting both for color, pattern and textile. As every marque has its own identity, it was necessary to approach with prudence and attention the color palette proposals for the pattern, inform about the creative path of the brand in the past decades and only then start working on the projects.

During this experience the main obstacles that were found were as following:

1. Textile designer is not only suggesting the textile and pattern proposals, it is a highly analytical person who very often creates the collection without working directly at the brand. Segment of the luxury brands demands good understanding of the mood of the brand, its style and opportunities in which direction it could develop. In order to be successful in this work, it is necessary to know the history of the brand, keep in mind current fashion, social and even political trends. Working with color demands high attention to the details, as the slightest discrepancy of the lightness or saturation that does not go along with the brands's vision will devalue the whole work previously executed.

2. Once again on a personal example, it was proved that the way one perceives color will never be the same the other does. Active training in color matching was a starting point in order to affirm this. As in many cases brands were sending the color palettes mixing together pieces of textiles, leather, and coloured pieces of paper in order to complete the palette. Usually brand was giving direction for the textile basis the print would have to be made on, like silk, cotton or any other. Due to the fact Ratti is specialised in silk production, most of the cases it was necessary to execute color match from paper to the silk color "pantone" (corporate jargon that refers to the colors printed on textile and possessing a numerical ordinance for the printing). While paper color is lacking any lucidity in most of the case, the "right" color hue on the textile swatch was difficult to find because the perception of color on silk was changing attributive to the light source, matt or sheen structure of the textile. The more brilliant textile was always bringing sense of confusion. It was changing not only during the day time, but also after changing the focus point at the material for a couple of centimetres.

3. The textile basis, like silk, lycra, polyester all possess different characteristics, so specific method of the print has to be found. There are predefined printing procedures by the reason of different

Fashion Design: orange that changed our perception of Luxury - the use of color at Hermès Paris material. The behaviour of the color changes due to the textile composition. As, for example, printing on viscose was very often lacking brightness and it had tendency to shift versus darker, even dirty hues sometimes.

4. In many cases brands were developing the same print but on different base. Like the same print could be intended to be done both on silk and polyester. So for both of those textiles colors had to be checked before starting printing trials. Very often the hues possessing the same number on the textile color swatch could have completely different tonality or even minor hues.

5. Complex patterns had to be "projected" keeping in mind how the colors are going to work in tandem. Specialising in silk accessories, it was essential to create right pattern and realise it in a right color palette. Color mixed with the right design is a winning strategy for creating a desirable product. Once the those two principles marry together, the success is granted to the item.

## **CONCLUSION**

Coming to a conclusion, it is worth saying that color is a powerful medium of non-verbal communication that conveys information better than verbal means. Color language is a unique and universal tool that is transversal and spreads influence far beyond one culture. In this work the author aimed to combine both practical approach to the color use in fashion by analysing the personal experience of working in the color consulting field, and by interpreting the color use in the brand strategy and communication. The findings mentioned below would be useful for everyone who is interested in color communication, marketing and color use in fashion are.

## **REFERENCES**

- Birren, F. 1945. *Selling with color*. New York: McGraw - Hill Book Company.
- Gage, J. 1999, *Color and Culture: Practice and Meaning From Antiquity To Abstraction*. California: University of California Press.
- Cage, J. 2009. *Color and culture: Practice and Meaning from Antiquity to Abstraction*. New York: Thames and Hudson.
- Eiseman, L. 2007, *Color: Messages and Meanings, a Pantone Color Resource*. Pantone.
- Eiseman, L. 2007, *Color: Messages and Meanings, a Pantone Color Resource*. Pantone.
- Eiseman, L., and E. P. Cutler. 2014. *Pantone on fashion: a century of color in design*. San Francisco: Chronicle Books.
- Goethe, J. W. 1971. *Theory of colors*. New York: Dover Book.
- Faber Birren First Edition. 1945. *Third Impression*. New York. McGraw-Hill book company, inc. York, PA: The Maple Press Company.
- Monsef, D. A. 2011. *Color inspirations*. Ohio: HOW books.





# The meaning of blue-green tiles on roofs of the Qinzheng Hall complex at the Summer Palace

Xuechang Leng <sup>1,\*</sup>

<sup>1</sup> The University of Edinburgh; s1792966@ed.ac.uk

\* Corresponding author: s1792966@ed.ac.uk

## Abstract

Blue-green, also known as Qing in Chinese, is a distinctive colour. On roof tiles, it appears as a dark-grey colour, which has a slight bluish-greenish tinge. All of the roofs of the buildings of the Qinzheng Hall complex at the Summer Palace (Beijing, China)—built by the Emperor Qianlong (1711-1799)—were covered with the same unglazed blue-green ceramic tiles. A core function of this complex was to manifest the hierarchical relationships of the people in the Imperial Court, such as the Emperor, high officials, and imperial guards, etc. While colour was used in other building elements to indicate status, the use of identical blue-green colour, however, did not make this differentiation. By looking into historical materials, this study suggests that the intention for the adoption of blue-green was to express the Confucian virtue of simplicity as a subtle reinforcement of the imperial power.

**Keywords:** *blue-green, emperorship, simplicity, roof, Garden of Clear Ripples*

## INTRODUCTION

As imperial power in China became firmly consolidated during the Qianlong Reign (1735-1796), the Qing Empire achieved a prosperous period (Liang, 2012: 156). To manifest his supremacy, reinforce his emperorship, display his achievements, as well as strengthen Qing institutions, the Emperor Qianlong (1711-1799) built the Garden of Clear Ripples known as the Summer Palace in Beijing. Among the complexes of this extensive palace (of around 3000 buildings), the Qinzheng Hall complex (of around 17 buildings)—burned down during the Second Opium War in 1860—was built for the Emperor to manage the governmental affairs, and to meet the secretaries and foreign envoys. The exact completion date of this complex is unknown, according to Zhou (1984), it was completed before the 19th year of the Qianlong Reign (1754). The meaning of Qinzheng Hall is the ‘hall of diligent government’. However, despite the name, there is little evidence to show that any governmental affairs were handled in these buildings during the Qianlong Reign. In comparison with the Forbidden City and the Old Summer Palace, the Summer Palace was primarily ‘a place to have a rest and cultivate emotions’, as the Emperor himself mentioned in the poem titled *A Piece of Writing for the Longevity Hill and Garden of Clear Ripples* (PM 2000: 343). But this does not mean the Qinzheng Hall was insignificant. The hall was built for applying the ‘rites of the Imperial Court’ just as the three main halls of the Outer Court in the Forbidden City (Guo 2018: 182).

In terms of the use of colour, the most anomalous phenomenon for the Qinzheng Hall complex is that all roofs of the buildings—from the Emperor’s hall to the guardhouses—were covered with the same blue-green ceramic tiles as seen in the painting *Longevity Blessing* (Wu et al. 1761, Figure 1). It is one of the four hand-scrolls, which were titled by the joint name *Birthday Celebration of the Empress Dowager Chongqing*. All these hand-scrolls were documentary ones, which were made for the Emperor and his mother. The painting process was fully under the Emperor’s supervision according to the recent research done by Liu (2019: 12-16) on the archives of the Imperial Household Agency related to this painting. Further more, both the buildings’ locations and forms in the painting were in accordance with the records in the *Imperial Endorsed Study of Old News Under the Sun* compiled by Yu et al. (1787a: 1-2), who were the high secretaries of the Imperial Court in the Qianlong Reign. Therefore, this painting very likely re-iterates the colour of Qinzheng Hall complex.

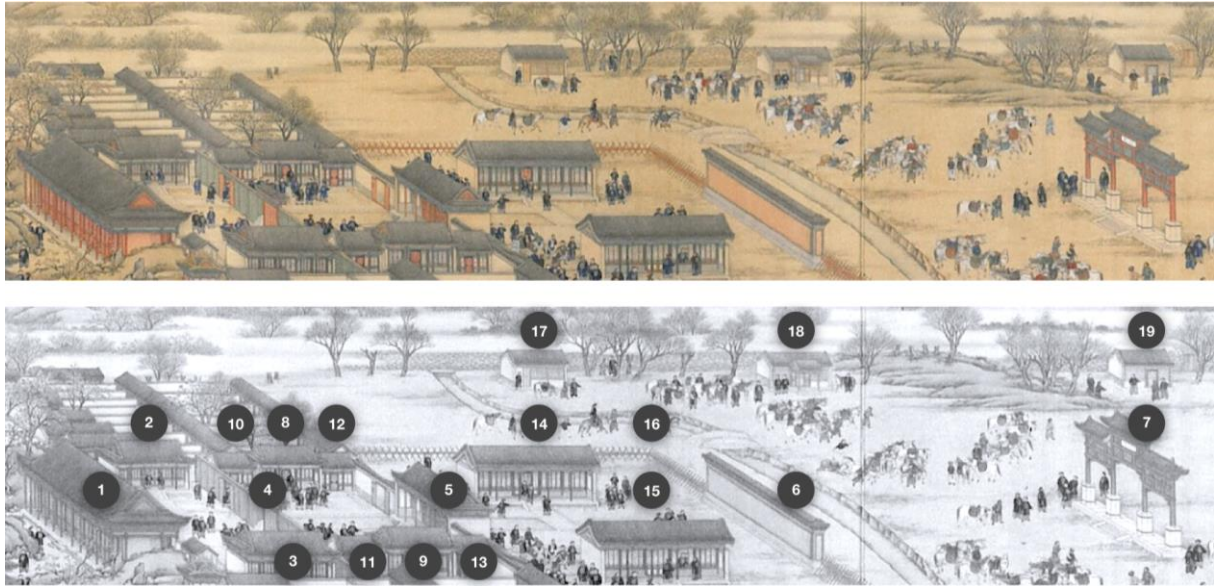

Figure 1: Detail view of Longevity Blessing [1 Qinzheng Hall, 2-3 side halls of Qinzheng Hall, 4 second palace-gate, 5 east palace-gate, 6 screen-wall, 7 gateway, 8-9 main halls of the North-south Nine-ministers-halls, 10-13 side halls of the North-south Nine-ministers-halls, 14-15 North-south Court-halls, 16 barricades, 17-19 guard houses], Palace Museum, Beijing.

### **THE FORMATION OF BLUE-GREEN**

In China, the usage of blue-green tiles on roofs has a long history, the earliest evidence can be found from the relics of the Zhou Dynasty's (1046-771 BC) palaces (ATZS, 1979). In the Qianlong Reign, the production of blue-green tiles became an established and common technique, this kind of pottery tile and brick was also widely used on civilians' houses (Li and Xu 2004: 608). Normally, the blue-green tiles were produced in the kilns located at the suburbs of the capital, as the archive named *Values of Various Materials for the Inner Court, Longevity Hill and Old Summer Palace* recorded that, 'the pottery bricks and tiles were transported to the capital from east kilns' (Wang 2009: 915).

The production process for the blue-green tiles can be seen from the 1987 survey of a functioning traditional pottery kiln—4 meters in diameter and 4 meters in height—by the archaeologist Xiong Haitang. To produce the blue-green ceramics, after the mud tiles and bricks have been prepared, the first step is to ignite the fire of the kiln with wood kindling, after which coals are used as the main heat source; when the temperature inside the chamber has reached around 1,000-celsius degree the amount of air inflow is minimised. The ceramics potteries are finally completed by the reducing flame with low oxygen; once the bricks or tiles are all completely fired, both the chimney and the stove opening are be sealed; then, 80 shoulder-poles<sup>1</sup> of water are poured into the concave container on the top of the kiln; gradually, the water seeps into the chamber and turned into vapour; simultaneously, a great quantity of carbon is also produced in the chamber; then, the carbon mixed in the vapour penetrates into the potteries because of the high pressure of the chamber; eventually, the blue-green colour is created because of the carbon infiltration (Xiong 1995: 135). The same production process is also recorded on one woodcut print in the encyclopaedia named *Exploitation the Works of Nature* (Song 1637: 6, Figure 2).

<sup>1</sup> In traditional China, the shoulder-pole was a pole for carrying load with two buckets on each end. Thus, the 80 shoulder-poles equals to 160 buckets.



Figure 2: Production process of blue-green ceramics, *Exploitation the Works of Nature*.

These tiles are all dark-grey, they usually appear a blueish-greenish tinge on the surface, especially when there is simultaneous contrast caused by the surrounding red walls and yellow glazed tiles. Therefore, the blue-green was named because of this blueish-greenish tinge. Although the Qing government had a strict quality control on tiles, as an architectural material that was produced in large quantities, the colour code of each blue-green tile varied. Blue-green as a common name, nevertheless, surpasses all variations. The representative NCS colour code for these blue-green tiles is S5005-B20G (see Figure 3) ascertained by the author from tile samples<sup>2</sup> collected from the Summer Palace.

<sup>2</sup> The surfaces of these tile samples have an earth yellow tinge, which is caused by the penetrated dirt.



Figure 3: NCS colour code of Blue-green tiles [left] and tile samples [right] collected by the author.

### ***SIMPLICITY AS THE ESSENCE OF BLUE-GREEN***

According to the archives recompiled by the archaeologist Wang (2009: 911)—and related to the values of architectural materials for the Longevity Hill in the Garden of Clear Ripples period—each first-rank blue-green semicircle-tile was worth 4 Lis of silver, which was equal to 0.125 grams of silver. In contrast, a yellow glazed semicircle-tile was worth 1 Qian and 9 Fens of silver, which is equal to 5.018 grams of silver (917). Nevertheless, this does not mean that the Emperor could not afford to use yellow tiles to cover the roofs of the Qinzheng Hall complex, for the yellow glazed tiles were used on other buildings with lower statuses than the Qinzheng Hall complex in the Summer Palace, for instance, the Tower of Prosperous Literatures. Also, the choice of the unglazed pottery blue-green tiles was not completely based on physical function, for unlike the yellow glazed tiles, these unglazed pottery tiles would absorb water and add weight to buildings. Moreover, because roofs of the Qinzheng Hall complex and the roofs owned by the civilians shared the same blue-green, it was impossible for a unique psychological association to be established between this colour and the emperorship. Consequently, the blue-green could never provoke in the people the same sense of subservience and humility that the yellow glazed tiles of the Forbidden City—the official residence of the Qing Emperors—did.

While there were usually differences in the forms, patterns, and forms of the tiling on the roofs of buildings according to the hierarchy, the hand-scroll named *Longevity Blessing* (see Figure 1) does not differentiate between the roofs of the Qinzheng Hall complex. It is possible that the artists consciously neglected to represent these details—patterns and forms. Even if in reality there were some differences on the roofs, these dissimilarities were imperceptible from a distance by the observers standing on the ground or on the Longevity Hill. Thus, the blue-green was the main visual appearance for all roofs. Compared with the yellow glazed tiles, the blue-green tiles did not attract anyone's attention. All of the dull roofs were camouflaged by the adjacent environmental colours: looking down from the Longevity Hill, the blue-green was surrounded by the colours of the trees, walls, nearby roofs, pavements, and earth; looking up from the ground, the blue-green was surrounded by the colours of the columns, walls, trees, hills, and sky.

It would seem that rather than any economic, physical functional, psychological, or visual purpose, the use of blue-green tiles on roofs was mainly to express the virtue of simplicity, which is highly valued

The meaning of blue-green tiles on roofs of the Qinzheng Hall complex at the Summer Palace by the Confucian philosophers. The virtue of simplicity in architecture was advocated by the Emperor Qianlong, as he wrote in the *Poem for the Jianfu Hall*:

A thousand gates and ten thousand doors the palace of the Han Dynasty had,  
I scorn these Han institutions which were too extravagant.  
The thatched roofs and earth steps the Emperor Yao's palace had,  
I admire his highness' simplicity which should be advocated.<sup>3</sup>  
(Yu et al. 1787b: 20)

In this poem, the Emperor Yao is a legendary Monarch who was regarded as one of the ancient moral models by the Confucianism. Yao's simple lifestyle and ruling method were highly admired by the Emperor Qianlong. However, the Emperor Qianlong himself never lived a simple life in reality: on the contrary, he lived a luxurious life and ruled the empire in a lavish way. As Xiao (2004: 357) stressed, Qianlong held many extravagant Birthday Celebrations, conducted more inspection tours than his predecessors, and continuously abused military power—the expenses for those wars were above 120 million taels of silver which are about 4.4772 billion grams of silver. Therefore this symbolic use of a commonplace blue-green tile for the Qinzheng hall complex suggests that the Emperor may have intended to give an outward expression of morality to his secretaries and other subjects. The ultimate goal for advocating the virtue of simplicity was to develop national strength, by which the imperial power would be further reinforced. As the influential Confucian philosopher named Xun Kuang (ca. 313-231BC) put it in one chapter of his book titled *Enrich the Country*: 'The ways of enriching the country are as followings: reduce expenses, enrich the people, and maintain a favourable balance. The expenses will be reduced by the application of Rites; the people will be enriched by the implementation of good policies'<sup>4</sup> (Xun, n.d.: 3). In the view of Confucianism, simplicity could be realised by the application of the Confucian Rites and therefore simplicity was an important way to enrich the empire.

## **CONCLUSION**

As a moral model of simplicity, therefore, the use of unglazed, blue-green tiles was an intentionally unassertive colour for the Emperor, that did not make a distinction of hierarchy in the buildings and between people in the Qinzheng Hall complex. To some extent, the blue-green also indicated the Emperor's own humble status in contrast with the celestial beings, in comparison to the many religious temples that were covered with yellow or green glazed tiles in the Summer Palace.

## **ACKNOWLEDGEMENTS**

Thanks to Professor Fiona McLachlan and Iain Boyd Whyte for their guidance.

---

<sup>3</sup> This paragraph was translated by the author from Chinese.

<sup>4</sup> This paragraph was translated by the author from Chinese.

## REFERENCES

- ATZS (Archaeological Team of Zhouyuan Shanxi). 1979. Shan xi qi shan feng chu cun xi zhou jian zhu ji zhi fa jue jian bao [Excavation report for the architectural relics of the West Zhou Dynasty in Fengchu village Qishan city of Shanxi province]. *Wen wu* 10: 29-39.
- Guo, D. 2018. *Yuan shi de hui huang yuan ming yuan jian zhu yuan lin yan jiu yu bao hu [The disappeared glory: the research and preservation for the Architecture and Landscape Architecture of the Old Summer Palace]*. Shanghai: Shanghai ke xue ji shu chu ban she.
- Li, S. and J. Xu. 2004. *Zhong guo shou gong ye jing ji tong shi ming qing juan [Economic history of Chinese craftsmanships: volume of the Ming Dynasty and Qing Dynasty]*. Vol. 4. Fujian: Fu jian ren min chu ban she.
- Liang, Q. 2012. *Liang Qichao lun zhong guo fa zhi shi [History of Chinese legal system in the view of Liang Qichao]*. Beijing: Shang wu yin shu guan.
- Liu, L. 2019. *Shi ba shi ji jing hua sheng jing tu [Magnificent view of the capital in the 18th Century]*. Vol. 1. Beijing: Gu gong chu ban she.
- PM (Palace Museum). 2000. *Qing gao zong yu zhi wen [Collected works of the Emperor Qianlong]*. Vol. 1. Hainan: Hai nan chu ban she.
- Song, Y. 1637. *Tian gong kai wu [Exploitation the works of nature]*. Vol. 2. n.p.: n.p.  
<https://gallica.bnf.fr/ark:/12148/btv1b52505781g/f170.item> (accessed March 12, 2021).
- Wang, S. 2009. *Qing dai jiang zuo ze li [Rules and cases for craftsmanships in the Qing Dynasty]*. Vol. 2. Zhengzhou: Da xiang chu ban she.
- Wu, W., D. Xu, F. Gu, H. Gu, W. He and D. Zhao. 1761. *Longevity blessing*. Ink and colour on silk. Palace Museum, Beijing.
- Xiao, Y. 2004. *Qing dai tong shi [History of the Qing Dynasty]*. Vol. 2. Taipei: Shang wu yin shu guan.
- Xiong, H. 1995. *Do ya yao ye ji shu fa zhan yu jiao liu shi yan jiu [A study of the development and exchange history of the kiln technology in East Asia]*. Nanjing: Nan jing da xue chu ban she.
- Xun, K. n.d. *Xunzi*. Vol. 6. n.p.: n.p.
- Yu, M., L. Ying, S. He, G. Liang, B. De, Y. Liu, R. Qian, L. Fu, J. Hu, C. Jiang and C. Liu. 1787a. *Qin ding ri xia jiu wen kao [Imperial endorsed study of old news under the sun]*. Vol. 84. Beijing: Nei wu fu.
- Yu, M., L. Ying, S. He, G. Liang, B. De, Y. Liu, R. Qian, L. Fu, J. Hu, C. Jiang and C. Liu. 1787b. *Ri xia jiu wen kao [Imperial endorsed study of old news under the sun]*. Vol. 16. Beijing: Bei jing gu ji chu ban she.
- Zhou, W. 1984. Qing yi yuan shi lue [History of the Garden of Clear Ripples]. *Yuan ming yuan xue kan* 3: 131-142.

# Application of Color in Domestic Interior Design: an analysis of the 1960s, 1970s and 1980s

Rebecka Pires <sup>1,\*</sup>

<sup>1</sup> Faculty of Architecture of the University of Lisbon, Lisbon, Portugal; rebeckamotta\_@hotmail.com

\* Corresponding author: rebeckamotta\_@hotmail.com

## Abstract

This article aims to analyze how colors were applied in domestic interior design, from the analysis of color temperature, in 1960s, 1970s and 1980s in Sweden, acting as influencers of the psychological environment. Therefore, a literature review was carried out, obtaining an understanding of what color is, its dependence of light, effects caused on the user and its symbology. Once understood, they were analyzed as the covers of IKEA Store Catalog, with Sweden as a special reference, according to specific knowledge in the literature. As a result observed: in the 1960s as the predominant color palettes were cold, with a predominance of blue and green; in the 1970s there was also a predominance of cool tones, blues and greens, in addition to neutrals, black and white; and in 1980s there was a greater presence of warm colors, such as red, yellow and orange.

**Keywords:** *Color, Color and Light, Psychological and Physiological Effects of Color and Light, Symbologies, Color Temperatures*

## INTRODUCTION

Color can be understood as a sensation from the light that works as a stimulus and the eyes are the receivers that decipher the luminous flux, changing it or decomposing it through the retina selector function. In this way, the colors that the individual believes to see through the eyes, are in reality, interpretations created by the brain through the electromagnetic spectrum, generated from the eyes, providing the perception and interpretation of the color. Therefore, color is seen by the brain and not by the eyes.

However, it is necessary to emphasize that colors are not only seen by the eyes through the brain, but also interpreted and felt, generating emotions and sensations that can influence the well-being that a given environment causes in the individual, since it influences also cognitive processes. Thus, the psychological reactions generated by colors are capable of causing changes not only in emotional terms, but also in the individual's attention to a particular space or object.

Given the context presented, this article aims to analyze how colors and their temperatures impacted domestic interior design in the 1960s, 1970s and 1980s, acting as influencers in the psychological and physiological environment. For this, a brief review of the literature on colors is presented, followed by the presentation of the methodology adopted, the experiment carried out, its analysis and conclusions obtained.

## LITERATURE REVIEW

### Colors in the Psychological and Physiological Environment

The vision, responsible for enabling the interpretation of the color and light phenomenon which can be understood in different ways and which allows the perception of essential elements with shape, color, brightness and shadows. Therefore, the conditioning factors present in the environment refer to the perception of light and dark, in addition to the application of colors. Thus, it can be said that light has expressiveness where the color seen can be used not only as an expression of emotion, but also as an activator of it through its application.



Still the eye owes its existence to light, since the eye is formed in light and for light, so that the internal light meets the external light. In this way, it can be understood that internal and external communication takes place through the eyes, being responsible for receiving stimuli and generating interpretations through its connection with the brain, enabling the understanding of what color is from light that falls under a specific body or object.

Thus, when applied to interior environments, color not only helps with aesthetic enrichment, but also causes the creation of psychological effects in this space, making it possible to connect or not to the individual. It also has the ability to generate physiological effects that connect to physical and biological effects so that muscle tensions and brain waves are generated, thus culminating in sensations, feelings and responses.

### **Domestic Interior Design**

Interior design can be understood as the organization of space from its beginning, with the design of the project until the moment it is completed, with the choice of furniture and elements that will be part of it, in order to generate sensations and feelings those who will live there (Gomes Filho 2006:21). Also, interior design has as its purpose the functional improvement, aesthetic and psychological enrichment, improvement of the quality of life in interior spaces.

It is important to highlight that the elaboration of the interior space goes beyond the simple idea of decorating since it superimposes purely aesthetic issues and seeks to elaborate a communication in such a way that there is an understanding of the meaning of the environment as a whole, being the great challenge of maintenance of virtues from the moment the barriers are removed. Therefore, it can be said that it is something philosophical, where there it is a mixed search for rationality and emotion.

Therefore, the need for attention to the application of color in interior design is evident, as it needs to achieve an appropriate interaction as the medium to which it is inserted so that it can be an element of comfort to the user, thus favoring the feeling that that's your place in the world – in the case of home interior design.

### **Methodology**

This study is part of a literature search for literature review, developed with the purpose of providing an overview of a given fact. The period used for the investigation was informal, in which it sought to understand the factors that influence the situation that constitutes the object of research, in this case, the analysis of IKEA catalog covers in Sweden, from 1960s to 1980s.

After understanding the phenomenon that allows the visualization of color, its direct relationship with light, its psychological and physiological effects in the application of environments, especially the domestic one, it becomes relevant to understand the specific characteristic of colors as well as their effects psychological in the use of each one of them. For that, the seven colors of the visible spectrum - orange, red, yellow, green, blue, indigo and violet - will be analyzed - obtained through Newton's experiment, which proved that the rainbow is composed of the seven existing colors. The categorization of the effect of colors on people will also be used in the analysis, with red, orange and yellow being hot and blue, green and purple being cold and neutral colors, represented by black, white and gray, which when combined with the main colors lead to a lack of color.

## Experiment

In order to understand colors, those were analyzed as to their temperature, conceptualization of authors and effects generated in environments from such use. From this analysis, it is expected to classify these according to their predominant temperature, applications on walls and floors and, finally, the elaboration of the color palette that will be the representation of this year's style, according to the company IKEA. Soon, a table will be presented that indicates the temperature, comment from authors - Chiazzari and Martel - and effects generated in the environments from their applications.

Colour	Temperature	Authors	Effect
Red	Warm	1. Chiazzari (1998) Vivacity, power, warmth, sensuality, affirmation, anger, and impatience. 2. Martel (1995) Passion, liveliness, heightens alertness.	It negatively affects the perception of time, elevates sleep disorders, decreases anger control. Used in small portions to attract attention.
Green	Cold	1. Chiazzari (1998) Harmony, relaxation, peace, silence. 2. Martel (1995) Productivity, life, growth, nature, wisdom.	It provides a relaxing, calming, and refreshing effect due to its association with nature.
Purple	Cold	1. Chiazzari (1998) Spirituality, intuition, innocence. 2. Martel (1995) Authority, chaos, death, dedication and love.	Widely used in ancient times; in a dark tone it can create a depressing atmosphere and in a light tone it can represent the well-being of the flowers.
Yellow	Warm	1. Chiazzari (1998) Happiness, rational stimulus, optimism. 2. Martel (1995) Single color that increases the power of the muscles.	Associated with daylight, it leaves the environment active, providing the illusion of increased space.
Orange	Warm	1. Chiazzari (1998) Joy, security, creativity. 2. Martel (1995) Symbol of balanced power, intuition and pure happiness, optimism.	It provides a curious and disturbing, stimulating atmosphere; makes the environment brighter when applied to the wall and ceiling.
Blue	Cold	1. Chiazzari (1998) Tranquility, breadth, breadth, hope, belief, faith and acceptance. 2. Martel (1995) Seriousness, broad thinking and sadness.	Provides the feeling of calm and relaxation as it is the color of the sky.

Table 1: Characteristics of Colors and Applications.

It is also necessary to emphasize that only covers referring to the composition of interior spaces will be analyzed, so that those with only furniture, without demonstrating where it is inserted will not be evaluated in this study. Thus, the table below shows the covers of the catalogs of the 1960s:

Application of Color in Domestic Interior Design: an analysis on the 1960s, 1970s and 1980s



Figure 1: Selection of IKEA covers catalogs from the years 1961, 1962, 1963, 1964, 1965, 1966 and 1969.

Year	Temperature	Wall	Floor	Furniture	General Color Palet
1961	Cold				
1962	Cold				
1963	Cold				
1964	Warm				
1965	Cold				
1966	Cold				
1969	Cold				

Table 2: Characteristics of the aforementioned IKEA covers with their chromatic analysis.

From the chromatic analysis made on the covers in Figure 1 and characterized in Table 2, it can be noted that the 1960s was marked by the predominance of environments composed of cold cores, with green and blue tones in evidence, in addition to the use of wood. It is also necessary to emphasize that these applications in common living spaces are assertive, as they provide relaxation and harmony (Chiazarri, 1998) and tranquility and serenity (Martell, 1995). However, it is necessary to highlight that the cover referring to the year 1969 represents the colorblock, a mixture of yellow - warm - and a cold color - blue. Therefore, although there is a strong representation of cool colors, there is still a presence of tones that refer to warm colors. As for the decade of 1970, the table follows:



Figure 2: Selection of IKEA covers catalogs from the years 1971, 1974, 1976, 1977 and 1978.

Year	Temperature	Wall	Floor	Furniture	General Color Palet
1971	Warm				
1974	Cold				
1976	Warm				
1977	Cold				
1978	Cold				

Table 3: Characteristics of the aforementioned IKEA covers with their chromatic analysis.

The representations of interior spaces from the 70s show a predominance of cold tones, with varying shades of blue in their tones. There is still the presence of warm tones with a predominance of yellow and orange, as well as their variations.

It is important to highlight the presence of neutral tones - black and white - in the composition of the spaces, sometimes to highlight the furniture, sometimes to compose the environment so that they are balanced and balanced in chromatic terms.

With regard to the 1980s, it follows:



Figure 3: Selection of IKEA covers catalogs from the years 1983, 1984, 1985, 1986 and 1987.

Year	Temperature	Wall	Floor	Furniture	General Color Palet
1983	Warm				
1984	Warm				
1985	Cold				
1986	Warm				
1987	Cold				

Table 4: Characteristics of the aforementioned IKEA covers with their chromatic analysis.

Finally, in the 1980s, it is possible to notice that the predominant color temperature in the analyzed environments is hot, represented by the years 1983, 1984 and 1986, from the considerable presence of red and yellow, although there are also cold elements, such as blue and green.

It is also possible to note the existence of monochromatic environments, as in 1985, and environments with spotlights given through the application of colors in the furniture as a prominent element, as in 1984. It is also noted that the environments are harmonious in their applications of colors, be it in structure, such as walls and floors, as well as in furniture in a way that allows the well-being of the user.

## CONCLUSION

In view of the exposed elements, the images and analysis tables, it was possible to verify the influence of colors in the internal environments, their quality and meaning when applied, whether on walls, floors or in the use of furniture.

In the 1960s, it was possible to notice the predominance of cool tones, especially blue and green, creating an intimate atmosphere in the domestic interior so that well-being is guaranteed from such uses, in addition to the existing harmony between colors and tones. used in the compositions. In this way, it was possible to see the environments that provide relaxation, calm and a feeling of freshness, essential in the internal domestic environment.

The 1970s were marked, through analysis, by the duality between cool and warm tones, where yellow and green are the most used nuclei in compositions, although there is also the use of blue. The environments are also seen as harmonious, with the exception of the latter, which presents a

composition of cores that can generate discomfort for the user. Therefore, it is understood that environments composed of warm tones are more stimulating and can generate feelings of anxiety, expansion of space, in addition to aiding in awakening by presenting the color yellow - the color of the sun. Environments composed of cool tones generate sensations of greater comfort, being better known in the intimate areas of the house.

The 1980s, in turn, was marked by warm tones, where cores were used in order to enhance the furniture in use. To this end, we chose to use floors and walls with light or very dark tones, thus creating harmony not only in the application of colors, but also in the design of the space. Thus, it is clear that the spaces can generate greater encouragement for those who live and live there, in addition to being applicable to common and social spaces, helping in the relationships that exist there. It was also noticed, after analyzing the covers of the catalogs from the 1960s, 1970s and 1980s, that there is a predominance of cool tones in relation to warm tones. It is also necessary to add that the furniture used and the application of light and color in the environments under analysis were informed in order to generate greater physical and psychological well-being, at a time when their tones provide greater comfort and relaxation.

Thus, the significance of care when applying light and color in the home environment is evident, due to its influence in psychological and physiological terms, essential for ensuring well-being. Therefore, the meaning of this knowledge is perceived for applications in interior design and architecture, being essential for human well-being and quality of life.

## **REFERENCES**

- Chiazzari, S. 1998. *The Complete Book of Color*. Elements Books Ltd., Boston.
- Ertek, H. 1994. *İç Mekan Temel Tasarım İlkelerine Bir Yaklaşım*. Unpublished MA Thesis, Hacettepe University, Ankara.
- Goethe, J. W., Von. 1993. *Doutrina das Cores. Apresentação, Seleção e Tradução Marco Gianotti*. São Paulo: Nova Alexandria.
- Gomes Filho, J. 2006. *Design do Objeto: Bases Conceituais*. São Paulo. Escrituras.
- Vodvarka, F. and J. Malnar. 1991. *The Interior Dimension*. Inc. USA.
- Zelanski, P. and M.P. Fisher. 2003. *Color, Fourth Edition*. Prentice Hall Inc. New Jersey.

# Procedure to obtain trustful colors in renderings produced by BIM

Gianluca Guarini <sup>1,\*</sup> and Maurizio Rossi <sup>1</sup>

<sup>1</sup> Politecnico di Milano; gianluca.guarini@polimi.it, maurizio.rossi@polimi.it

\* Corresponding author: gianluca.guarini@polimi.it

## Abstract

The BIM methodology offers the various professionals involved in the design phase a database of information relating to the project's various components. Among this information, colour can be reported in two ways: at the level of digital data to be inserted in the database and at the level of representation in the visualization design images, which are the renderings. Although having to follow standard and specific procedures depending on the device used, the correct acquisition of the colour to be used in the project and its insertion as data is an overall linear process. Instead, the discussion on maintaining the consistency of colour between reality and its representation in the renderings is more complicated and open. This article presents a general and as effective as possible study regarding resolving this problem, analyzing the various criticalities, and proposing possible solutions using the tools currently offered by BIM software with the help of external plug-ins.

**Keywords:** *colorconstancy, BIM, rendering, colorprofile, virtualcameracalibration,*

## INTRODUCTION

The BIM methodology offers to various professionals an accessible database of the project to be carried out and subsequently maintained. Among the various information available and to be foreseen in the design phase, the colour of the finishes to be used is of fundamental importance. In the BIM area, the designer can return colour in two ways. The first consists of attributing a particular colour to a particular architectural element. The second involves using renderings, predictive photorealistic synthesis images that communicate in a photometrically correct way the colour rendering of that architectural detail within the project environment.

In the first case, to maintain a consistency of the colour that the designer wants to use between a particular sample and its attribution to the element as information to be returned to those who consult the project database, presupposes the use of a series of standard rules and procedures to follow and respect carefully (Guarini and Rossi 2019). In the second case, maintaining this colour consistency appears highly complex as the factors that influence the final image are numerous and sometimes complicated to reproduce precisely.

## PREMISE

Colour management is necessarily influenced by the devices used, in the acquisition and in the display phases. A correct procedure has a necessary and not sufficient preliminary condition: the periodic calibration of all the instruments involved. In the acquisition phase via scanner, this calibration must be carried out using professional software and reference colour tables (Guarini 2020). In this way, it will be possible to scan an image together with a corresponding ICC profile.

In the acquisition phase via camera, the shots of the material sample must be accompanied by shots in which there is a Color Checker colour table (Rodney 2005) (Guarini and Rossi 2021), in order to generate a colour profile associated with that particular device and those particular light conditions in which the shots were taken.

In both cases, the scanned images are converted to the sRGB colour space, the standard for CAD systems. Even the output devices, printers and monitors, must all be calibrated appropriately. Especially when working and viewing on the monitor, even the surrounding environmental conditions

must follow specific rules so that the colours returned comply with the sRGB standard ('A Standard Default Color Space for the Internet - sRGB' n.d.).

## TEXTURE INPUT

Most CAD systems are unable to manage colour spaces. When inserting a texture inside a slot of a particular property of a material, it is assumed that it complies with the sRGB standard (Nielsen and Stokes 1998). On images downloaded from the internet, this may be as true as it may not be. A check should always be done through programs capable of managing colours. However, it is always preferable to enter textures whose origin is certain and obtained through professional and correctly calibrated devices. Before being imported, they should be converted into the sRGB colour space. Even in the software used in the BIM methodology, among which we can mention Autodesk Revit (*Autodesk Revit* 2021), Colour Management is not provided, so when the application receives a raster image as data, it assumes that this is with an sRGB colour profile (Nielsen and Stokes 1998). The use of specific plugins for rendering, such as V-Ray for Revit (*V-Ray for Revit* 2021), allow some more options when attributing textures and choosing the sRGB space (see Figure 1).

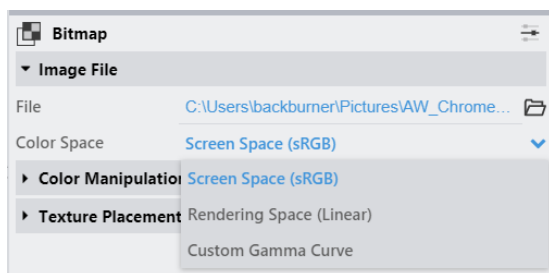

Figure 1: Choice of the Colour Space when loading textures in V-Ray Materials.

## MATERIALS

The choice of finish type also affects the color represented in the forecast rendered images. A material that reflects diffuse light will certainly look different than one that reflects specularly. It is therefore important to choose an appropriately set source material from the BIM library. It would be even better to start by building the material from scratch by setting the various properties as correctly as possible and respecting the law of conservation of energy, according to which a material cannot reflect or transmit more light than it receives.

Both the generic material supplied with Revit, and the native generic material of the V-Ray plug-in, divide, albeit with different vocabularies, the light that interacts with the surface into: diffuse reflected light, specularly reflected light and refracted light. We focus here to avoid contradictory input in the generic V-Ray material. The user can individually set, using a slider or with the "Value" parameter of a chosen colour, the quantity of light reflected in a diffuse way (Diffuse) (Rossi 2007b), the quantity of light reflected in Specular mode (Reflection) (Rossi 2007a) and the amount of light transmitted (Refraction). To use a physically correct material, the sum of these individual components, expressed as a measure from 0 to 1, must never be equal to or greater than 1 in total. For example, a white plaster wall has a very high percentage of diffuse reflection, about 85%, and a low percentage of specular reflection, maybe 1%, and a zero percentage of refraction.  $0.85 + 0.1 + 0 = 0.95 < 1$ .

Suppose the chosen finish is not of a homogeneous colour but has a texture such as the grain of wood or marble, a surface of a fabric, a series of bricks with the relative joints. In that case, it is necessary to use a texture image obtained through acquisition with calibrated tools and then to



Procedure to obtain trustful colors in renderings produced by BIM

convert it to the standard sRGB colour space mentioned in the previous paragraph. In the case of the V-Ray plug-in, changing the value of the Diffuse parameter is irrelevant, as the quantity of light reflected in a diffused way is given by the Color Value, which varies from pixel to pixel as it is not homogeneous. Hence the importance of entering the texture with the correct colour space and compliant with the standard for CAD systems, namely sRGB. In the image (see Figure 2), it is possible to observe how, if a texture is used for the Diffuse property, the diffuse parameter itself is irrelevant since the amount of Diffused light changes according to the Value (Brightness) of the selected pixel that is sampled.

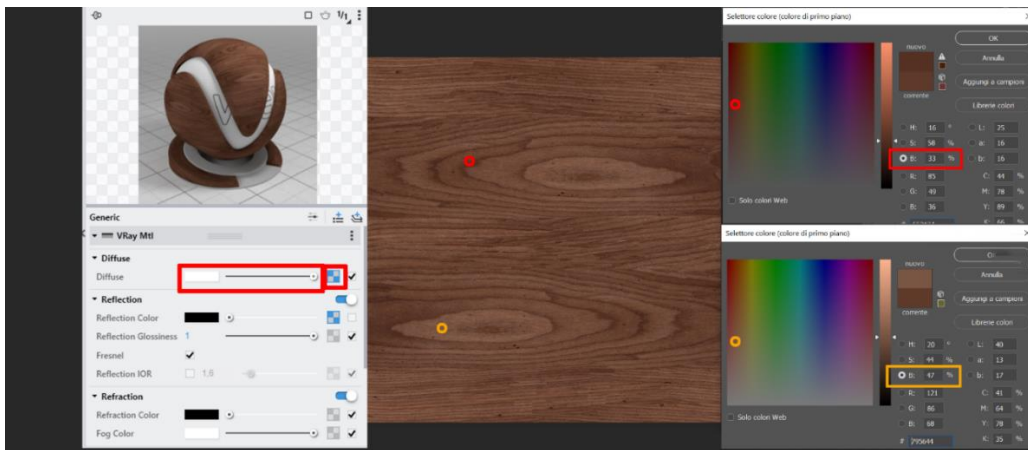

Figure 2: Texture loaded into the Diffuse slot in the V-Ray Plugin Material.

## ILLUMINATION

The rendering of the colours chosen in the design phase can change radically depending on the type of lighting present. There are two possible scenarios: natural light (day or night) and artificial light.

Regarding the first, the Autodesk Revit software can simulate the light coming from the sun and the celestial vault in a few simple steps, allowing the user to set the geographical position of the project, the orientation of the North, the time and the date of the simulation. The use of the V-Ray plug-in, also assisted by the use of its proprietary materials, shortens the calculation times and presents more refined results. However, as regards the position, orientation, date and time, it still relies on the settings set in Revit. The second case that of artificial light, is instead more complex to manage. The reason is that each luminaire that the designer wanted to use in the project emits light in different ways, which are difficult to reproduce in the software except by relying on specific data that can only be retrieved from the supplier who made that luminaire. Among the various photometric quantities characteristic of light, two are fundamental for the correct reproduction of how light propagates from a particular device: the colour temperature and the luminous intensity (Choudhury 2014). The first can be easily inserted in the majority of three-dimensional modelling software and BIM software. It is sufficient to read the value from the product data-sheet and report it in the corresponding field given by the software. On the other hand, the second cannot be entered by hand since it is a three-dimensional spatial distribution of a quantity that varies in direction and size. However, this distribution can be measured by special laboratory instruments. A "goniophotometer" can measure and replicate the diagram of light intensities in 3D. This diagram can be distributed to designers in the form of a text file that contains a three-dimensional coordinate table. This file has the \*.IES extension and can be read and displayed in 3D by particular viewers. It can also be inserted into modelling software as a property of artificial lights (Mangkuto and Soelami 2017).



Therefore, it would seem simple, once the correct colour temperature value obtained from the technical data sheet has been entered and the \*.IES file of the light intensity distribution has been obtained from the supplier, to replicate the light coming from a given luminaire correctly. However, there are several cases in which the interactions between the photometric measurements taken in the laboratory and the 3D geometry that simulates the device itself can significantly interfere with the correct simulation of the light distribution. The reason is that what is measured in the laboratory using the goniophotometer is the distribution of the light intensity coming out of the device, that is the set of physical geometries that make it up, including the lamp itself. The resulting distribution has a particular starting point, the so-called photometric ZERO. Suppose you want to associate the photometric file with the 3D geometry that replicates the physical geometry of the lighting fixture. In that case, it may be necessary to position the photometric zero within the 3D geometry itself. The light intensity distribution could be hindered by the geometry, thus interfering with a correct photometric simulation (Siniscalco and Guarini 2018) .

BIM software does not have tools to solve this problem, but the V-Ray for Revit plug-in offers as a solution an option that disables the casting of shadows from selected material. In this way, if a V-Ray material with this option disabled is associated with a particular 3D geometry, the geometry itself will not hinder the distribution of intensities given by the imported \*.IES file, thus allowing the light to diffuse correctly in the scene.

### **WHITE BALANCE AND EXPOSURE:**

The production of a photorealistic preview image is, in fact, comparable to a real photographic shot of an existing environment. Concepts typical of photography are therefore involved, such as white balance and the choice of the correct exposure to not chromatically distort the final result. It is, therefore, necessary to replicate in the software all the procedures that should be followed in a real shot.

Concerning white balance, BIM software allows you to set a colour temperature before making each rendering. To enter correct values, it is essential to know the colour temperature of the light sources involved. In the case of a simulation with natural light, it is necessary to know with which climatic conditions the designer wants to preview the project, whether with a wholly covered sky, with some clouds or clear. A good choice, in this case, is to use the settings given by the illuminat of the CIE D50, D55, D65 or D75 series, corresponding respectively to 5000K, 5500k, 6500K or 7500K ('A Method for Assessing the Quality of Daylight Simulators for Colorimetry | CIE' 1999).

In the case of a scenario with artificial light, it is, instead, necessary to know the colour temperatures of the intended luminaires. If they all have the same colour temperature, enter that value in the software before rendering. If this were not the case, a weighted average of the various values involved should be used. This average would depend on multiple factors, including the number of sources present, their intensity, and which sources are closest to the camera from which the rendering is to be calculated.

The other important parameter to set for the correct colourimetric rendering of the simulation is the exposure. The parameters of a real camera that affect the clarity of the image (film sensitivity, aperture, shutter speed) are not always referred to in the BIM software interfaces. Most of the time, a single dimensionless parameter is used, generally referred to by the term "Exposure", but that could also vary considerably the result depending on the software or even the plug-in used. The fact that the range of values that can be entered varies from software to software and from plug-in to plug-in contributes to increasing the inhomogeneity in the results obtained.

Given the large number of parameters involved, a good practice to obtain accurate colourimetrically corresponding images consists, as a first step, in trying to set all the parameters described above in the best possible way: the replication of the materials, the setting of the lighting and the exposure and white balance before processing the image. Then, a further refinement can be implemented in Postproduction, bearing in mind that some plug-ins, such as V-Ray for Revit, allow dynamic adjustments even before saving the final image. These adjustments are the same as those found in photo editing programs, including exposure and white balance, which can then be further refined with respect to the values set before the calculation. Furthermore, it is also possible to act on the curves, on the tonal values, on the hue, the saturation, and the colours' balance. Moreover, the V-Ray for Revit Framebuffer works by default in the sRGB space, but the plug-in also allows importing a specific ICC colour profile. However, having set the entire process chain so that the sRGB standard is respected, it would be counterproductive to adopt a different profile in the final step.

A possible aid in the final adjustment of the exposure and white balance levels could consist in positioning a fictitious object that represents a Macbet Colorchecker sRGB (see Figure 3) within the scene to be rendered. At that point, one could operate like in postproduction on a photograph of a real scene with a real Color Checker table inside it, using the notches of the gray scale as a reference. By keeping these last adjustments in the Frame buffer's memory, it is possible to exclude the dummy ColorChecker from the scene and proceed to final processing of the image, which will finally be saved.

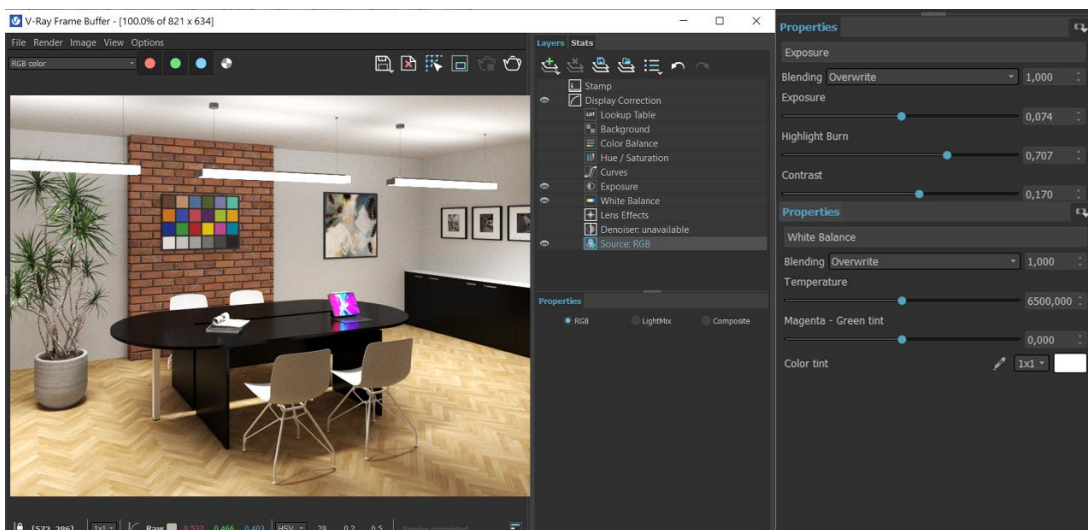

Figure 3: Postproduction changes to exposure and white balance with the aid of a dummy ColorChecker directly within the V-Ray for Revit Plug-in.

An alternative to this last step carried out directly in the plug-in is to export the rendered image in a high dynamic format and then import it into a photo editing software, where it will also be possible to work in postproduction on the white balance and exposure levels.

## CONCLUSIONS

In this article, we illustrated that, within BIM software, maintaining consistency of colour between the choice of an actual finish and its representation in the design visualization images is possible. Still, the topic involves numerous and complex aspects. The acquisition of the materials must be standardized, and their replication must comply with the law of energy conservation for a correct simulation of the interaction with light. The natural light and the artificial lights must be replicated correctly. About the

artificial lights, the use of data provided by the manufacturers of the devices is an essential condition for a correct calculation. Finally, a proper exposure setting and white balance are indispensable conditions for a faithful representation of the colours perceived by the observer. These last two operations are recommended both before processing the rendering and subsequently in postproduction. Furthermore, at present, BIM software must also be supported by specific plug-in rendering engines to solve problems of interaction between light and matter and assist in the postproduction process.

## REFERENCES

- 'A Method for Assessing the Quality of Daylight Simulators for Colorimetry | CIE'. 1999. 1999. <https://cie.co.at/publications/method-assessing-quality-daylight-simulators-colorimetry>.
- 'A Standard Default Color Space for the Internet - sRGB'. n.d. Accessed 12 July 2021. <https://www.w3.org/Graphics/Color/sRGB.html>.
- Autodesk Revit. 2021. Autodesk. <https://www.autodesk.com/products/revit/overview?term=1-YEAR>.
- Choudhury, A. K. R. 2014. 1 - Characteristics of Light Sources. In: A. K. R. Choudhury (Ed.), *Principles of Colour and Appearance Measurement*, 1-52. Woodhead Publishing. <https://doi.org/10.1533/9780857099242.1>.
- Guarini, G. 2020. *Nuove Frontiere Della Progettazione BIM per l'illuminazione*. Santarcangelo di Romagna (RN): Maggioli. Vol. 222. <http://hdl.handle.net/11311/1156284>.
- Guarini, Gi, and Mo Rossi. 2019. An Introduction to Colour Management in BIM Projects. In: XV B:33–38. Macerata. <http://hdl.handle.net/11311/1119344>.
- . 2021. 'A practical procedure for obtaining calibrated material colors for CAD Systems'. In: M43:196-201. Smolensk. <http://hdl.handle.net/11311/1166002>.
- Mangkuto, R. A., and F. X. Nugroho Soelami. 2017. Photometric and Colorimetric Measurements of Luminaires Using Goniometer and Spectrophotometer in a Dark Chamber. *Engineering Physics International Conference 2016 – EPIC 2016* 170 (January): 226-33. <https://doi.org/10.1016/j.proeng.2017.03.054>.
- Nielsen, M., and M. Stokes. 1998. The Creation of the sRGB ICC Profile. *Color Imaging Conference 1998*.
- Rodney, A. 2005. Chapter 5 - Building Camera Profiles. In: A. Rodney (Ed.), *Color Management for Photographers*, 159-83. Boston: Focal Press. <https://doi.org/10.1016/B978-0-240-80649-5.50008-5>.
- Rossi, G. 2007a. I materiali: riflessione speculare e diffusa. *Luxemozione* (blog). 14 October 2007. <https://www.luxemozione.com/2007/10/i-materiali-riflessione-speculare-e.html>.
- . 2007b. Superfici Lambertiane: Riflessione Diffusa Uniforme • Luxemozione. Luxemozione. 4 November 2007. <https://www.luxemozione.com/2007/11/superfici-lambertiane-riflessione.html>.
- Siniscalco, A., and G. Guarini. 2018. Digital Visualization of a Luminaire: From Blueprint to Photorealistic Representation. *Cultura e Scienza Del Colore - Color Culture and Science* 9 (0). <https://doi.org/10.23738/ccsj.i92018.05>.
- V-Ray for Revit. 2021. <https://www.chaosgroup.com/vray/revit>.

# Color and Sustainability in Fashion Design: DUARTE, Portugal

Ana Paula Pinheiro <sup>1,\*</sup> and Rui Duarte <sup>2</sup>

<sup>1</sup> CIAUD Lisbon School of Architecture; apprbd@gmail.com

<sup>2</sup> CIAUD Lisbon School of Architecture; rbdapp@gmail.com

\* Corresponding author: apprbd@gmail.com

## Abstract

Color is a constant presence in fashion design which has been greatly explored by highlighting tones, brightness, opacities and transparencies. The combination of these factors integrated into a palette makes the research concern marking a plastic and communicational meaning that takes advantage of sustainability, technique and used technologies. Besides the importance of color in fashion, communication is also symbolic, a way of explaining the theme being used to mark ecological messages, call attention to relevant and critical aspects of the world we inhabit. The environmental references combined with the technical and sensitive process of design are always present in the Duarte brand who draws the attention to the preservation of our planet. The brand has a sustainability rate (4 out of 6), being part of the “Sustainable Brand Platform”. Ana Duarte, the founder and head of design of the sustainable Portuguese streetwear brand DUARTE, won the C.L.A.S.S. Icon Award 2021.

**Keywords:** Color, prints, communication, fashion, sustainability

## INTRODUCTION

Color is a constant presence in fashion design but it is fundamental for Duarte. Its prints are unique, whether it uses its drawings or joint ventures with other artists. In this case, the drawings are reinvented by changing scale, color and composition, creating textures (Figure 1).



Figure 1: SS18 Voyage: Print by Duarte, using drawings of Taj Mahal made by Rui Barreiros Duarte (left). Lisboa Fashion Week. Photo: Ugo Camera (right).



Some trends vary according to the seasons and to the thematic narrative that is wished to be transmitted. Creativity is essential in this context, equating to material sustainability, as this is an important domain of complementary research.

The designer's imagination and personal experience explore the narrative colors that translate the sensitivity and emotions he/she captures in each place. Thus, he/she takes advantage of natural views, human and cultural experience of different regions, spiritual states as well as social and environmental criticism.

The colors express emotions filter the chromatic intensities and the combinations of tones, like a painting. As of, a pallet of materials is created, an expressive impressionism that registers chromaticism, light and backing support.

Nevertheless, it is essential to have into account that the fabrics that get the impression of color also change them and so it is necessary to experiment and correct the changes caused by the materials.

We are in the presence of an aesthetics' world that relates the character with the personality and the communicational impact of the design. There are essential tones that must be explored as not to lose the authenticity of the messages.

The question is how the collections combine the colors, the environmental impact and the values that they transmit in the trends.

### **HOW THE COLLECTION STARTS**



Figure 2: AW18 Prohibition. Print by Duarte, using drawings of Chicago and New York made by Rui Barreiros Duarte (left). Lisboa Fashion Week. Photo: Ugo Camera (center and right).

The first action is the choice of theme, as it is associated with the narrative which transmits the message to the target (Figure 2). This will be the sender of the environmental message, an unchanged feature of Duarte's collections which is positioned in the market by expressing its civic conscience

through fashion design. This theme targets a wider sportswear and streetwear public, without being radical.



Figure 3: SS21 Maui: Lisboa Fashion Week. Photo: Ugo Câmara (left). Photo: Tomás Monteiro for Portuguese Soul (right).

As the prints and colors of the diverse components of clothing and trimmings can be combined in diverse ways, they express the possibility for users to creatively hijack the message.

The environmental and sustainability concerns are always present, not only on the theme but also on the fabrics and materials chosen. The patterns and motives explore the aesthetic beauty that represents the wonderful planet we live on (Figure 3).

Nevertheless, talking about this matter is different than capturing the development of the process, as well as the analyses of any topic encompass mainly the duty but do not predict the imponderable. The mathematicians call it probability and the structuralism coincidence. The conceptual availability that comes from the Pop movement, decontextualizes and changes the referents, a principle from which one can evaluate the expression, the way of selectively register patterns and colors. We have to have in mind that communication also involves emotion and fashion design, like a Piece of Art involves an overcome. This is defined as “Author’s Piece”, represented by different narratives, materials and aesthetics bringing authenticity and innovative design.

## **THEMES**

The themes selected in this article emphasize two aspects: the aesthetic and creative component of the different narratives that are reflected in its shades, materials and prints; the type of thematic incidence: memories (Voyage and Prohibition), discovery of paradises (Maui), call of attention to



climate changes (Third Pole), the need of the planet earth preservation (Reef), DUARTE's latter collection (Figure 4).



Figure 4: AW21 Reef: Lisboa Fashion Week. Photos: Ugo Camera.

These are temporal and qualitative steps that arise from the life experience of each individual and create global expectations about the future. This is the trip. “Grand Tour” confront us with the responsibility of acting consciously, critically, with solidarity while always betting on quality. There is only a need to redefine principles and strategies and create an alternative imaginary without abandon fantasy. We have to evaluate the impact of the dreams we follow. The method involves the evaluation of tools we use with imagination and effectiveness that are translated into images that encompass the idea, structure, composition and colors.

### **FASHION DESIGN**

“DUARTE brand intends to redefine the concept of sustainable streetwear, creating a cool lifestyle” (Duarte 2021).

Due to practicing judo since she was four-years-old, Ana Duarte pays special attention to the body and its movement, being Duarte's aesthetic marked by a sporty vision, with ergonomic and comfortable pieces, of excellent quality.

In a general way, the collections are inspired on trips - made or imagined - and the designs are a colorful sporty interpretation of the mood board, which serves as a base for all the investigation.

It is intended to combine both the creativity of the prints with the cutting of fabrics, in a way that allows to explore its potentialities, especially when there are figurative representations - there is always a first mock-up to mix both and study their bonded effects.

## DESIGN THINKING

The methodology used is Design Thinking. There are a set of sequential steps that contribute to the clarification of the creative process.

According to The Stanford d.school the Design Thinking process is constituted by five stages: Empathize (with the users); Define (the users' needs, their problem, and your own insights); Ideate (by challenging assumptions and creating ideas for innovative solutions); Prototype (to start creating solutions); Test (solutions) (Dam and Siang 2020).

Nevertheless, we have to take into consideration that this principle refers to a rationalization of the process in which emotion and expression should be essential factors of creation. This system is not developed by opposites but by complementarities. Thus, the interactive connections and the serendipity form a wide universe of availability open to the selective action and also critic that evaluates the creation process. Furthermore, Duarte values "The Power of Storytelling" which is one of the Design Thinking approaches.



Figure 5: AW20 Third Pole. Photo: Ruben Branches (left and center). Photo: Ugo Camera Lisboa Fashion Week (right).

Take this collection as an example: FW 20/21 Third Pole that is a call out for attention to climate change and extinction. "The Himalayas store more freshwater than anywhere in the world except for the North and South Poles, being known as Third Pole" (Duarte 2019). It was a partnership with the street artist Edis One, known for his Extinction project. Duarte selected five animals that are endangered in the Himalayas and asked Edis One to make his graffiti. To use those drawings, Duarte changed their scale and made a new composition. It combined the five animals with the colors of the mountain and subtropical forests that exist in its base to create a powerful print. This way, it warns about the extreme contexts issue and the implications it has in the animals with the change of their natural habitat (Figure 5).



## **SUSTAINABILITY**

“The world is changing, and that is part of Nature. But what if we can slow down and revert some of that change for a positive environmental impact?”. This is the question that Duarte tries to solve in the collections, selecting themes and colors that warn about the issue and choosing sustainable materials and techniques.

The prints are combined bearing in mind the optimization of results. The control of images is an essential key to obtain the desired effect. The use of pattern fragments in diverse types of applications monetizes the material and avoids waste (zero waste), taking into consideration an ecological and economic impact during the whole process.

Duarte uses natural yarns, recycled materials, waterproof technical fabrics and upcycled marine plastic by Seaqual Initiative. The logistics and supplying of materials are concentrated in Portugal, on a 300km distance (reducing environmental footprint).

The brand has a sustainability rate (4 out of 6), being part of the “Sustainable Brand Platform”.

## **C.L.A.S.S: ICON AWARD 2021**

Ana Duarte is the founder and head of design of the sustainable Portuguese streetwear brand who won the C.L.A.S.S. Icon Award 2021, an international sustainability prize. “For Duarte, sustainability means durability, fair work practices, recycled materials and zero waste.”

According Poletti, Marketing & Communication Director White, she “renews streetwear in an artistic way blending together an outerwear soul and unique and exquisite prints”. Albin, CEO Idee Brand Platform adds “she brings the coolness and freshness of streetwear together with responsibility”.

## **CONCLUSIONS**

Color and Sustainability are very important in Fashion Design but for DUARTE, Portugal they are crucial.

DUARTE wants its colorful prints to tell a story, drawing attention to respect for ecology and to the preservation of our planet. Ana Duarte won the C.L.A.S.S. Icon Award 2021, an international sustainability prize and according to Albin she brought “the real Fashion’ 4 dimensions: mixing Design, Innovation, Sustainability and Communication”.

## **REFERENCES**

- And the C.L.A.S.S. ICON AWARD 2021 goes to... DUARTE, sustainable streetwear from Lisbon and beyond. - C.L.A.S.S. Online: <https://www.classecohub.org/archives/11451> [accessed 20 June 2021].
- Dam, R.F, Siang, 2020. What is Design Thinking and Why Is It So Popular?  
Online: <https://www.interaction-design.org/literature/article/what-is-design-thinking-and-why-is-it-so-popular> [accessed 3 July 2021].
- DUARTE. Online: <https://www.modalisboa.pt/en/designers/duarte> [accessed 3 July 2021].  
<https://www.duartebrand.com> [accessed 20 June 2021].
- Misciagna, M., 2020. Project: Vogue Union | Ana Duarte, do Judo à Moda  
Online: [https://www.vogue.pt/ana-duarte-entrevista?photo=Malha\\_SaraSampaio.jpg&fbclid=IwAR1fZLOSv4jP\\_ZQUdIuqqOeIUqs8MqBcE8yxuEJr9wbJOSWXsPnOr6x8x3g](https://www.vogue.pt/ana-duarte-entrevista?photo=Malha_SaraSampaio.jpg&fbclid=IwAR1fZLOSv4jP_ZQUdIuqqOeIUqs8MqBcE8yxuEJr9wbJOSWXsPnOr6x8x3g) [accessed 1 July 2021].
- Sustainable Brand Platform. Online: <https://sustainable.ideebrandplatform.com> [accessed 20 June 2021].

1 COLOR AND MEASUREMENT INSTRUMENTATION	2 COLOR AND DIGITAL	3 COLOR AND LIGHTING	4 COLOR AND PHYSIOLOGY
5 COLOR AND PSYCHOLOGY	6 COLOR AND PRODUCTION	7 COLOR AND RESTORATION	8 COLOR AND BUILT ENVIRONMENT
9 COLOR AND DESIGN	10 COLOR AND CULTURE	11 COLOR AND EDUCATION	12 COLOR AND COMMUNICATION MARKETING

## 10 COLOR AND CULTURE

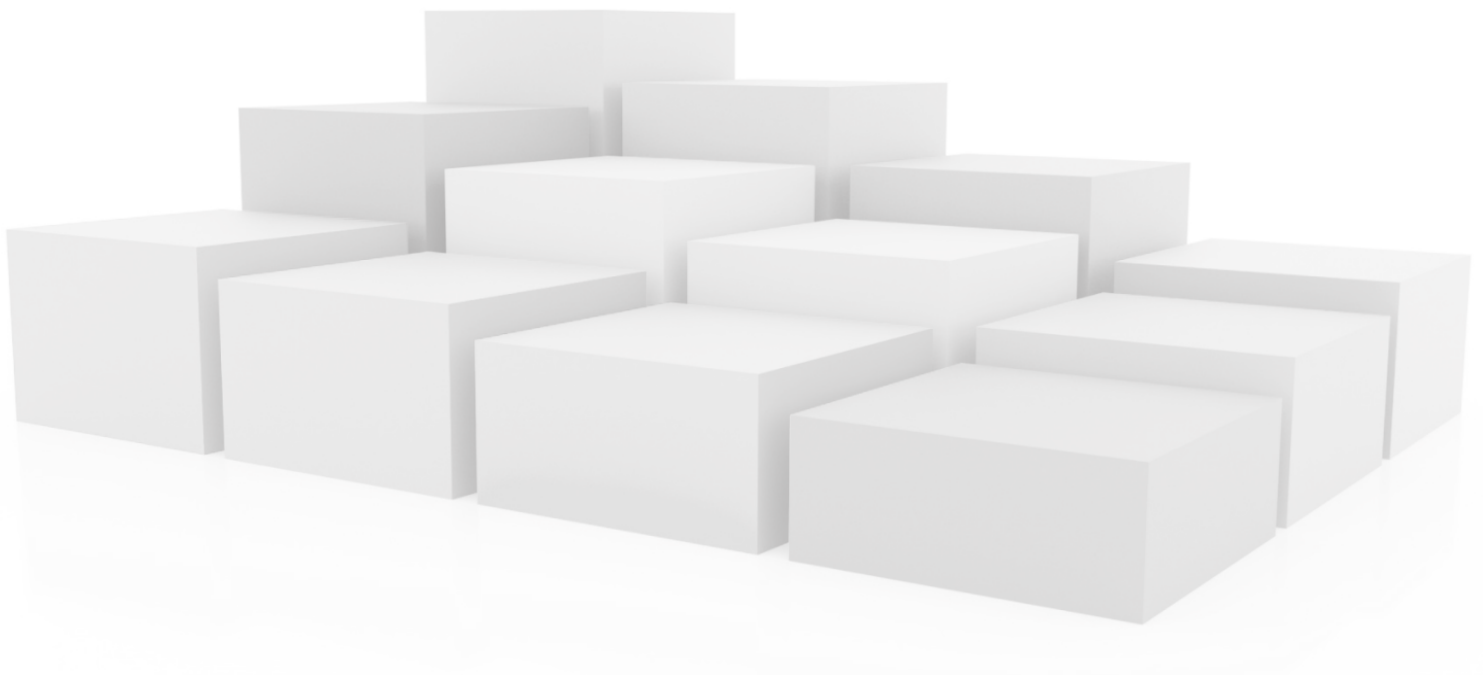

AIC 14<sup>th</sup> Congress Milano 2021 - August 30<sup>th</sup>– September 3<sup>rd</sup> 2021



# Colour, material and prototyping for architecture

Martino Pavignano <sup>1,\*</sup> and Ursula Zich <sup>2</sup>

<sup>1</sup> Department of Architecture and Design, Politecnico di Torino, Italy; martino.pavignano@polito.it

<sup>2</sup> Department of Architecture and Design, Politecnico di Torino, Italy; ursula.zich@polito.it

\* Corresponding author: martino.pavignano@polito.it

## Abstract

Starting from the critical reading of an architecture by Michael Graves, the paper proposes an analysis of the intertwined relationships between architectural geometries, colours and tangible models obtained by rapid prototyping systems (laser cutter and some specific materials).

The proposal is framed into a wider research project focused on the applicative interconnection between architecture and mathematics through geometry, here intended as a shared and common language. This work is the prosecution of a previous research on models of mathematical surfaces where colour was specifically used as a communication tool to enhance the comprehension of shapes, clarifying that color could guide us to grasp their geometric properties. In this new case, colour acts as a qualifying perceptual element of the architectural shapes.

**Keywords:** *Architectural colours, Shapes, Physical models, Prototyping, Michael Graves' St. Coletta School*

## INTRODUCTION

This study finds its roots into a wider research project focused on the analysis of applicative interconnections between the two sciences of architecture and mathematics. It primarily deals with geometry intended as a shared and common language able to expose and support these interconnections. Within this context, we have identified the role of physical models as effective media to promote a critical debate between the two disciplines, due to their explicit and implicit geometrical soul (Pavignano and Zich 2020). We offer our critical approach to the use of tangible models as tools to understand and communicate the architectural shape (Cumino et al. 2017; Cumino et al. 2020). Here, we highlight the connection between architectural shape, its modeling and prototyping process that leads to effectively building such artifacts. We discuss the role of colours during the prototyping process, both as a conventional language, aimed at designing the technical supports used to interact with computer and prototyping machinery, and as possible parameter influencing the final outputs.

## MICHAEL GRAVES' ARCHITECTURAL SHAPES AND COLOURS

Michael Graves (1934-2015) was an American architect and designer, best known for being part of the New York Five Architects during the 70's (Drexler et al. 1975) and a member of the Memphis Group of designers in the 80's. He was one of the main actors of Postmodernism (Frampton 2020: 342-344).

Apart from his early projects, the most of Graves' architectures are characterized by the use of simple volumes, sometimes linked to Classical revivalism with kitsch implementations (i.e. Disney headquarters building, Burbank-CA, 1986; Walt Disney World Swan, Orlando-FL, 1987; Museum of the Shenandoah Valley, Winchester-VA, 2005) (Frampton, 2020).

In these projects, the use of colours is always related to the use of such volumes and we could assert that Graves used chromatic parameters to define a theoretical perceptual hierarchy, thus guiding the reading of his building. In this sense, Graves' architectures are media that act as geometric messages, to say it with McLuhan (1974: 17-18).

## OBJECT OF ANALYSIS

We apply our procedure by analyzing and modeling Michale Graves' St. Coletta School of Greater Washington building (2001-2006). The project for St. Coletta School is one of his last designs and it was clearly influenced by the Author's postmodernist masterpieces, as well as by his outstanding modernist origins. Even if this is not the occasion to discuss Graves's professional path between the two architectural souls, we must state that, somehow, this project also recalls the Five's ideas of performing against the postmodern kitsch mix of shapes and colours by sharing an allegiance to modern architecture and pure form as stated by Le Corbusier (Tarajko-Kowalska 2014: 698), by using simple shapes defined by simple colours. In this case, Graves replaced the pure white with just seven plain colours. Sited in the Greater Washington municipality, St. Coletta School is a structure for children and young adults with intellectual disabilities (St. Coletta). In an interview related to this project, Graves said that, while he did not think about himself as a specialist designer of schools, «this was about doing something for society at large and making a paradigm for these schools», thus he had to design a building that considered its users' special needs (Van Mourik 2007).



Figure 1: St. Coletta School of Greater Washington. a) on the 2019 Orthophotography in Web Mercator (DC GIS, CC BY 4.0); b) north elevation, the 'houses' (www.michaelgraves.com).

The building has a north-south orientation, and its block is constrained between Independence Avenue, Southeast Boulevard and the 19th Street SE in the RFK Stadium neighborhood (Figure 1). Its main north elevation faces Independence Avenue, and it is the most recognizable part of the building, due to its specific structure made by five connected blocks (Figure 2b). Each one has its entrance from a common area and contains classrooms dedicated to a group of students and is characterized by one colour and one simple geometric shape. Other two colours identify the common basement and the connecting upper level. The rest of the building contains other classrooms, offices, a pool and a gym. Our critical analysis considers only the north portion of the building. These five 'houses' have been described by one Graves' associate as «color-coded» structures. In fact, they are painted with a clear palette of five different colours, to be identifiable and to «allow the students to identify their 'house'» (Van Mourik 2007). In this sense, the use of colour can be of assistance to the students when they need to reach their classrooms. The same happens to the specific shapes used to design the houses. Also, the interiors have been designed to follow this coloured-coded idea. In fact, colours and their patterning further identifies the different rooms of the school: «each of the common rooms has an identifiable checkerboard pattern in the themed color of the house» (Figure 3). Moreover, from the architectural point of view, the simple and clear hierarchy of the plan does assist students in their daily use of the structure (Van Mourik 2007). Here, the connection between architectural shapes, colours and their semiotic reading can be also analysed from the point of view of Arnheim's approach to Perception and Visual Thinking (1955,

1969). In this sense, simple shapes may be easily perceived by humans, even by those with special needs. In this case, the role of meaning and signifier in the architectural context, as stated by Marotta et al. (2017) stands out: in fact, here both shapes and colours become explicit hints of ideas that inspired the design process. In other words, colours and shapes are the materialization of the signifier, while acting as explicit meaning. i.e.: the cube shape does represent the second 'house' from the left and so is the light brown colour.

### **PHYSICAL MODELS TO READ, COMMUNICATE AND SHARE ARCHITECTURE**

Within this theoretical framework, we need to focus our attention both on the meanings and functions of tangible architectural models and on the most up to date technical processes that can become tools to express the contributions of physical and digital tools into creating new meaningful artifacts with specific educational/perceptual functions. Physical model draws its origins from the material representations used for religious ceremonies, magical rites, or reductions to the celebratory-votive-playful dimension of everyday life scenes or using reduced architecture as homes for the dead. The architectural physical model is the result of a complex process of critical analysis and synthesis, even eidetic, both of the architectural project or of the built space, as well as being the outcome of the process or as an example to be reproduced or implemented (Scolari, 2005: 131-132). Model arose de facto to the role of physical representation, which can be explored by means of our sight. There is also no shortage of cases in which the model itself was or is to be understood as a real self-contained architectural project, or as the final expression of a process of critical and creative mediation between archè and téchne (Smith 2002). Even if the actual debate considers the digital model the undisputed protagonist (Carpo 2017), as an element for the strengthening of intersections between the developments of the «project understood as form of communication» and albeit already strong links between «spatial intuition and the image that concretizes it» (Albisinni 2011: 71). Within this context, the roles of the physical, tangible model come to light and allow us to use them as tools to communicate and share Graves' St. Coletta.

### **COLOURS FOR RAPID PROTOTYPING**

We now discuss the role of colours within the prototyping process. In fact, they assume different meanings during different steps. First, we choose the process that would lead us to realize our models. We opted for laser beam machining (LBM), a kind of subtractive prototyping technique which provides the possibility to engrave and cut by thermal means a sheet of material.

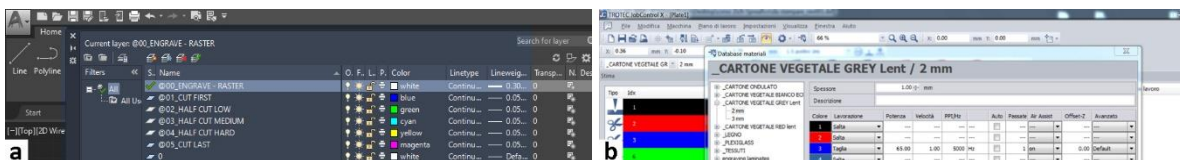

Figure 2: Colours used to control the prototyping process. a) designing the prototype with AutoCAD® software; b) coding colours functions in the JobControl® software.

To do so, we must discretize designed artefacts through their projection and/or development in the plane, or their simplification to section planes/flat surfaces, to be joined together. Thus, the language/graphic standard of the digital support containing design information must consider the expressive possibilities linked to LBM. In fact, it is possible to obtain incisions (generally with area =

0), removal of material like abrasions (with area > 0) and cuts (with area = 0) (Ylibas, 2018). Moreover, this process helped us to geometrically control the design process and to define its geometric analysis (Tagliari and Wilson 2013). We used a Totrec Speedy 400 LBM, controlled by JobControl® software. A vectorial file is the base for this prototyping. It contains all the geometric information guiding the LBM. We designed this vectorial file using AutoCAD® software. This file must be organized with different layers of different and codified colours, so that the JobControl® can read the project. This procedure involves a set of sixteen RGB coded colours that can be used in the JobControl® software to define cuts and engravings so that vectorial geometric entities acquire their own meaning (except for their line thickness, since its variable is only functional to choose between engrave or cut). Geometric entities involved can then assume the typical characteristics of 2D technical drawing, becoming now dashed lines, now filled with geometric patterns, to produce the expected expressive values.

### **MODELING ST. COLETTA**

We now present the results of the prototyping process which led to building four different models of the St. Coletta north section. The models were developed within a university course (third year of architecture) with a focus on geometric modeling and communication of architecture through digital and physical artifacts. In this context, it was necessary to move educational activities online (due to Covid-19) thus the need to support students in the optimization and creation of artifacts arose. Parallel to the LBM process we also worked on other types of prototyping such as origami, 3D printing and digital models, but we have chosen to discuss laser cut models as they can be reproduced even in the absence of adequate tools and because they are more subtly linked to the chromatic parameter digital models is easily implemented, as well as in 3D prints).

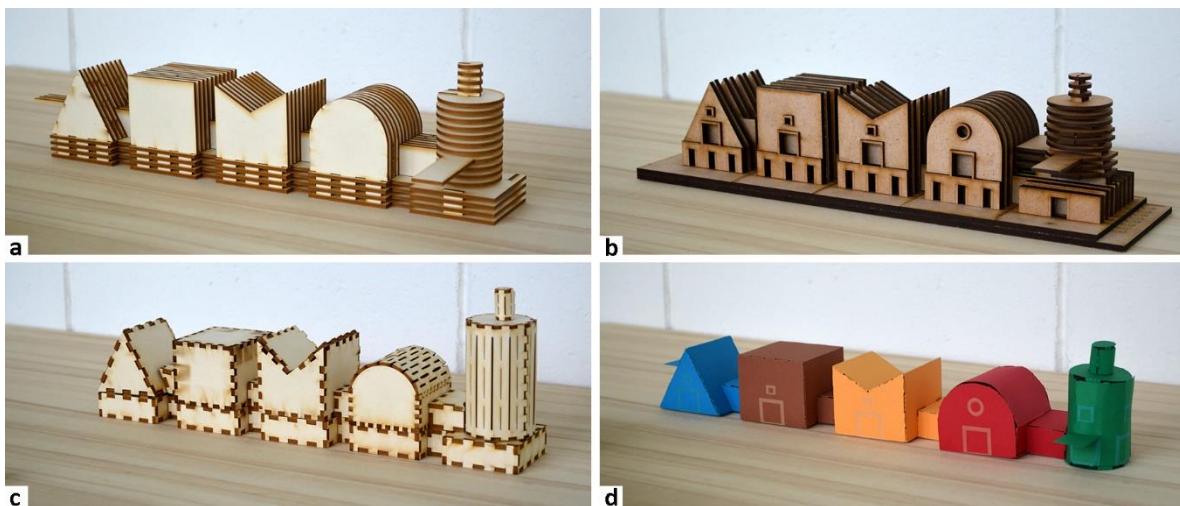

Figure 3: St. Coletta models elaborated by students. a) S. Lacché, E. Pagliano, B. Sperati, M. M. Toniolo, M. Ugolini; b) C. E. Barbero, M. Buffa, H. Hanafi, C. Massimi, L. Ribaud; c) A. Andreacchio, Z. Bourhil, A. Frola, L. Gandaglia, A. Taramazzo; d) D. Bionaz, F. Cafforio, A. Catanossi, M. Santo, L. Treves.

The first two examples show similar models realized by discretizing architecture through vertical and horizontal sectioning planes (2 and 4 mm MDF). In both cases models help the user in reading and understanding geometries that withstand each single house. In fact, from left to right we can clearly recognize four horizontal prisms with triangular, squared, M and barreled shapes, completed

by a couple of vertical circular superimposed cylinders. Even if no information relates to real architecture colours, the perception of architectural volumes is easy and can clearly happen also when observing the models from a non-frontal point of view.

The third example shows the creation of a model defined by a set of boxes (1, 2, 3 mm cardboard) that highlights each house geometries by reproducing their volumes. In this case, the model provides the best solution for perceiving the complexity of the building, clearly identifying each single functional element (basement, 'houses', connecting volumes), but still does not provide any information related to the coloured code of the architecture. On the contrary, the joint corner technique generates an opposition between cut and uncut material that may affect the final perception of shapes. The fourth example shows an origami inspired model built with card stocks (220 g/m<sup>2</sup>) of different colours, clearly chosen to ideally match that of the original building. The model is designed by developing the volumes of each house onto a planar surface. This solution is the best one to communicate the ensemble of the architecture because the combined use of colours and volumes makes it easy to perceive it. Nonetheless, this example may be misleading, because each connecting portion block assumes the colour of the prism, which is the coloured one, and the basement is missing, because not used.

### ***DISCUSSION AND CONCLUSIONS***

We focused our analysis on the St. Coletta School by entering in the deep of the critical reading of Graves' architecture, thus recognizing the building as a complex system of different semiotics (Gay 2020): the one related to the meaning of shapes, the one related to the meaning of colours and the last one related to the building in its whole construction. This critical reading is functional for defining a set of tangible models capable of communicating both the geometrical and the colourful language of Graves' building. With this respect, we analyze the deep connection between the original public face of the building and its reduced tangible artefact counterpart. In this sense, we may confirm that the role of colours in St. Coletta building cannot always be easily portrayed when we need to describe its geometries by using physical models. Of course, we can provide models with colours by painting them, but in the specific cases, discretizing the architecture by means of vertical cutting planes or by reproducing its volumes can define good tools to analyze its architectural geometries. In fact, the modeling workflow is based on extrapolating such geometries, elaborating them for the rapid prototyping process and providing their material representations. In this sense, our methodology takes into consideration the practical experience to enhance the analytical process, by providing visual and haptic tools. The need to create tangible models respecting colours clearly contrasts with the possibility of modeling 'with colours', because we need to deal with limits imposed by tools and materials). This critical point is interesting because the selection of information that is useful to maintain the meaning needs to deal with shapes that could be deprived of their chromatic component. Further research will compare these kinds of prototyping and will undergo an evaluation through direct testing with different targets of possible users.

### ***ACKNOWLEDGEMENTS***

The contribution was developed within the research project MAG.IA 2019-2020. We thank: G. Berruto (DAD - PoliTo, ModLabArch) for his technical assistance in producing the models; M. L. Spreafico and A. Tomalini (other teachers with us) and students of the course Modellazione Geometrica in Architettura, a.y. 2020/2021 for their effort in analyzing and designing the models of St. Coletta School.



**REFERENCES**

- Albisinni, P. 2011. L'analisi grafica dell'architettura: dall'analogico al digitale. In: *Architettura disegno modello. Verso un archivio digitale dell'opera di maestri del XX secolo*. P. Albisinni, and L. De Carlo, eds, Roma: Gangemi, 65-76.
- Arnheim, R. 1954. *Art and Visual Perception. A Psychology of the Creative Eye*. Berkeley (CA): University of California Press.
- Arnheim, R. 1969. *Visual Thinking*. Berkeley (CA): University of California Press.
- Carpo, M. 2017. *The second digital turn: design beyond intelligence*. Cambridge (MA): The MIT Press.
- Cumino, C., M. Pavignano, and U. Zich. 2020. Paper models of architectural surfaces: images for implicit and explicit geometries. *IMG Journal*, 2(2), 86–115. doi.org/10.6092/issn.2724-2463/11116.
- Cumino, C., M. L. Spreafico, and U. Zich. 2017. From museum education and entertainment to daily life edutainment: tools for understanding geometric shapes. In: ICERI 2017. Proceedings of the 10th annual International Conference of Education, Research and Innovation, Valencia: IATED, 4447-4454. doi: 10.21125/iceri.2017.1199.
- Drexler, A., C. Rowe, K. Frampton, P. Eisenman, M. Graves, C. Gwathmey, J. Hejduk, R. Meier, and P. Johnson. 1975. *Eisenman, Graves, Gwathmey, Hejduk, Meier*.
- Frampton, K. 2020. *Modern Architecture. A Critical History*. London: Thames & Hudson (1<sup>st</sup> ed. 1980).
- Gay, F. 2020. *A ragion veduta. Immagine progettuale, rappresentazione e morfologia degli artefatti*. Alghero: Publica.
- McLuhan, M. 1974. *Gli Strumenti del Comunicare*. Milano: Garzanti (1<sup>st</sup> ed. 1964).
- Marotta, A., R. Spallone, M. Lo Turco, U. Zich, M. Vitali, E. T. C. Marchis, and M. Pavignano. 2017. Visual Images and Language in Architecture: Signifier Semiotics and Meaning Semiotics. *Proceedings*, 1(9). <http://dx.doi.org/10.3390/proceedings1090964>.
- Pavignano, M., and U. Zich 2020. Colore tra forma e materia dei modelli fisici per lo studio della Geometria. In: *Colore e colorimetria. Contributi multidisciplinari. Vol. XVI A*, V. Marchiafava, and M. Picollo, eds., Milano: Gruppo del Colore – Associazione Italiana Colore, 398-405.
- Scolari, M. 2005. *Il disegno obliquo: una storia dell'antiprospektiva*. Venezia: Marsilio
- Smith, A. C. 2004. *Architectural Model as Machine. A New View of Models from Antiquity to the Present*. New York: Elsevier-Architectural Press
- Tarajko-Kowalska, J. 2014. White Colour in architecture and built environment – Facts, myths and contemporary application. In: *AIC 2014 Color, Culture and Identity: Past, Present and Future, Proceedings of the Interim Meeting of the International Colour Association*, G. Ortiz, C. Ortiz, R. Ramirez, eds. Oaxaca: AIC, 683-703.
- Tagliari, A., and W. Florio. 2013. Digital fabrication of physical models to analyze unbuilt projects using laser cutter. In: *High Value Manufacturing: Advanced Research in Virtual and Rapid Prototyping*, M. K. Todd, ed., London: CRC Press, 385-398.
- Tarajko-Kowalska, J. 2014. White Colour in Architecture and Built Environment - Facts, Myths and Contemporary Application. In: *AIC 2014 Color, Culture and Identity: Past, Present and Future, Proceedings of the Interim Meeting of the International Colour Association*, G. Ortiz, C. Ortiz, R. Ramirez, eds. Oaxaca: AIC, 683-703.
- Van Mourik, J. 2007. *Bringin Building Blocks to Life. Blueprints Spring*. Available here: <http://nbm.pub30.convio.net/about-us/publications/blueprints/st-coletta-school.html> (last check: 30 June 2021).
- Yilbas, B. K. 2018. *The Laser Cutting Process: Analysis and Applications*. Amsterdam: Elsevier.
- St. Coletta: [www.stcoletta.org](http://www.stcoletta.org) (last check: 30 June 2021).

# Digital reproduction of colors and materials used in pottery: a case study from the ancient Picenum

Enrico Zampieri <sup>1</sup>, Vincenzo Baldoni <sup>2</sup>, Simone Garagnani <sup>2,\*</sup>, Andrea Gaucci <sup>2</sup> and Michele Silani <sup>3</sup>

<sup>1</sup> Sapienza University of Rome; enrico.zampieri3@gmail.com

<sup>2</sup> Alma Mater Studiorum - University of Bologna; vincenzo.baldoni@unibo.it, simone.garagnani@unibo.it, andrea.gaucci3@unibo.it

<sup>3</sup> Università degli Studi della Campania Luigi Vanvitelli; michele.silani@unicampania.it

\* Corresponding author: simone.garagnani@unibo.it

## Abstract

Digital replicas of pottery, due to their many benefits in terms of sharing opportunities and visualization, recently became popular in museum exhibits, often introducing virtual expositions for pieces belonging to collections all over the world. However, the accuracy of digital duplicates plays a paramount role in the perception of shapes and colors, since the most minute feature could easily lead to identify unexpected clues of an object (e.g. its precise time of production or even its author). This is particularly true of pottery, whose materials, manufacturing techniques and decorations have been subject to dedicated research throughout history. This paper introduces some of the specific outcomes of a research program, oriented to the quick digital acquisition, 3D replication and accurate visualization at the different scales of the Davanzali necropolis in Numana, a settlement of ancient Picenum (Marche Region, Italy).

**Keywords:** *Picenum pottery, 3D digital modeling, color acquisition for archaeology, digital photogrammetry*

## INTRODUCTION: THE DAVANZALI NECROPOLIS IN NUMANA

During the first millennium B.C., the settlement of Numana raised in the Southern part of the Conero promontory and soon became one of the most important trade harbours along the Western Adriatic coast. Our knowledge on the pre-Roman Numana mainly refers to data coming from excavations conducted in different necropolises, spread all over its territory. The largest one is known as Quagliotti-Davanzali, excavated in the 20th century and connected to other funerary areas recently discovered nearby. A research project has been developed on this pivotal context since 2016 by a group of scholars of the University of Bologna, in cooperation with the *Soprintendenza ABAP* and the *Direzione Regionale Musei* of the *Regione Marche*. The project, still running, aims to study a considerable group of burials (241 tombs) located at the center of the Quagliotti-Davanzali area. The research introduced in this contribution is part of a wider project, named "*From the finding to the landscape, archaeological analysis and virtual modelling of Picenian necropolises in Numana*", which was focused on digital replication of the Davanzali necropolis, at the different scales of the finding (with particular attention to pottery) and the landscape (considering all the tombs).

A few tombs have been published so far, thus the new research project on this area offers the chance to examine for the first time a consistent and homogeneous group of tombs of the ancient Picenian center. Results of the study, which is now in its final stages, offer significant keys to analyze historical, economic, social and cultural aspects of the pre-Roman Numana, considering that the Davanzali area was used from the 9<sup>th</sup> to the 2<sup>nd</sup> century B.C. (on the research project and its perspectives, see Baldoni and Finocchi 2019). During the maximum development of this emporium (6<sup>th</sup> to 4<sup>th</sup> century B.C.), Numana built up trade and cultural networks with many areas from the Mediterranean to Europe: this wide range of contacts is well documented in the Davanzali necropolis by many objects deposited in the grave goods, whose pottery is the most abundant.

Therefore, we focused on the investigation of the several types of vases found in tombs, ranging from coarse ware to fine pottery. Amongst the fine pottery, there is a considerable number of decorated vases, especially red-figured ones, produced in Numana (the so-called *Alto-Adriatic* pottery) and from Greece and Western Greek colonies (*Attic* and *Italiote* pottery).

### **THE POTTERY: TYPES, PRODUCTION AND THE MEANING OF COLORS**

Through the interpolation of the available data from the documentation produced at the time of the excavation and the new surveys carried out in the field, traditional studies on the funerary assemblages led to the production of three-dimensional models related to the main phases of exploitation of the necropolis, useful to read the ancient landscape and its modifications during the considerable period of its use (9<sup>th</sup> to 2<sup>nd</sup> century B.C.).

A detailed model was created for a specific portion of the necropolis (Baldoni and Finocchi 2019), in an attempt to reconstruct the state of the burials at the time of the excavation in the 1970s, with the aim of making this model a tool as much for the archaeological analysis of the context as to its enhancement. The chosen sector falls into a central area of the necropolis, close to one of the oldest tombs in the whole settlement, and it is characterized by a notable superimposition of graves, which persisted in the same area for a long period, namely from 6<sup>th</sup> to 3<sup>rd</sup> century B.C. This circumstance provided a convincing test field for 3D reconstructions in a complex stratigraphic context, and it led to the documentation of whole funerary assemblages, characterized by rather heterogeneous objects. Excluding metal objects and focusing mainly on pottery, it has been possible to digitally acquire both locally produced fine vases, characteristic of the different phases of the Picenum culture, and many vases with figures, imported especially from Athens and Magna Graecia. This is fundamental to better understand the role of Numana in the Adriatic trade, especially during the 5<sup>th</sup> and 4<sup>th</sup> centuries B.C. The analysis of this type of materials using photogrammetric and laser-scanning techniques is part of a rather recent but already consolidated tradition of studies (Trinkl 2013): the digital documentation of these finds opens up new possibilities to investigate Attic and Italiote productions, allowing researchers at first an objective analysis of the morphological aspects of a single vase. There are also numerous perspectives to consider when referring to the decoration of vases, especially in the red-figure pottery (Bursich and Pace 2017), certainly well represented in the contexts of Numana. Recent investigations demonstrated the usefulness of digital documentation and archaeometry in the study of multiple characteristics of the figured decoration of vases, as well as in determining their state of conservation (Vak 2013). Further attention to the Picenum area is paid to the local production of red-figure pottery, starting from the second half of the 4<sup>th</sup> century B.C., the so-called *Alto-Adriatic pottery*, which is still interested by a limited number of analytical studies on the decoration and the colors used.

Due to these premises, the Davanzali necropolis in Numana is an interesting context for a large-scale experimentation of digital techniques to reproduce the finds, as well as, hopefully, a paradigmatic case study for other similar contexts in pre-Roman Italy and beyond.

### **THE POTTERY VIRTUAL RECONSTRUCTION**

Vases, and particularly figured ones, are some of the most relevant archaeological artifacts to consider and their accurate representation was paramount to share 3D models throughout scholars, archaeologists or museum visitors, who are targeted users interested in the detailed analysis of the pottery. The resulting representation of the shape at the object scale, dealing with the thickness of the surfaces and the definition of materials and their colored details, required to fix precise critical issues, mostly related to the geometric 3D morphologies, whether they are preserved in their entirety or

found in portions then to be reassembled. Following a precise taxonomy made of noticeable peculiarities, useful to scholars and restorers to pinpoint details to better identify the original painters and their techniques, a specific four-staged acquisition methodology was applied.

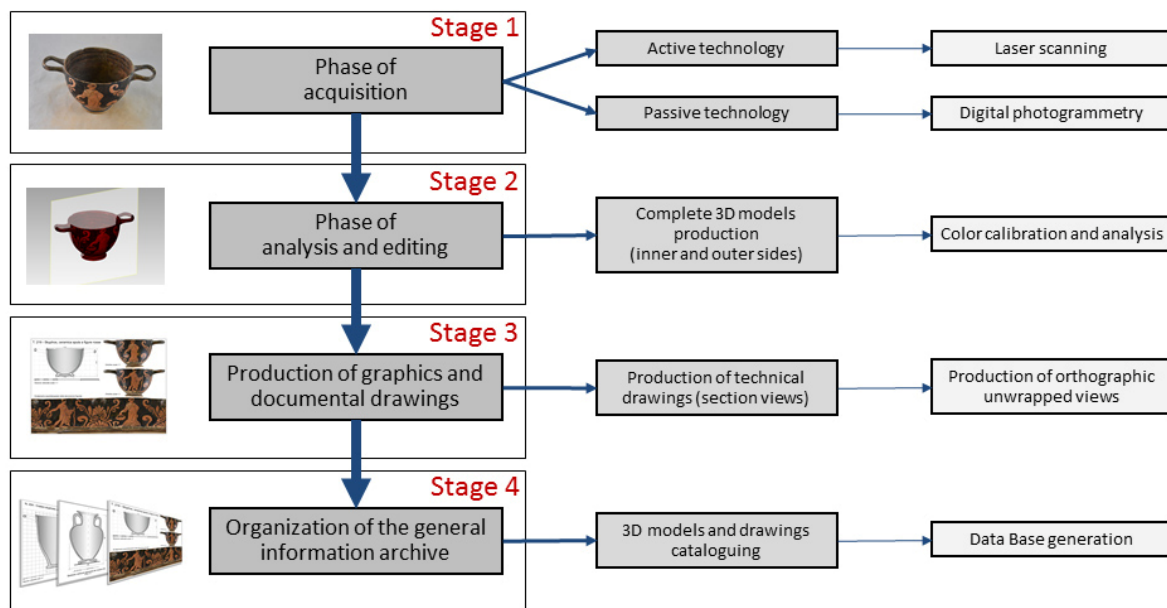

Figure 1: The general workflow adopted to produce digital colored replicas of the imported pottery found in the Numana necropolis.

### The digital workflow adopted

To ensure the acquisition of a huge number of ceramic findings in a reasonable time, the proposed methodology originates from photogrammetric surveys and terrestrial laser scanning (TLS). Although laser scanning devices were initially tested, photogrammetry was privileged due to the ease of use, the relative cost-effectiveness and the versatility in contexts where an active acquisition would make survey operations more complex. In the end, the general "workflow" for the digital replication of the artifacts was organized as follows (Figure 1):

- acquisition stage for artifacts, where samples under examination are digitized from time to time using color-calibrated photography;
- phase of analysis and editing of the digital model inferred, with definition and optimization of the surfaces of the models, their informative enrichment relevant to the decorations and figured parts;
- production of the graphic and documental drawings stage, in which the three-dimensional models are treated for the realization of explanatory drawings according to traditional rules of representation;
- organization of the general information archive, where models and analytical documents are collected in digital archives aimed at disseminating knowledge deriving from the analysis of the finds.

#### *The acquisition stage*

A standard and consolidate photogrammetric pipeline (Schonberger and Frahm 2016) was adopted. The camera equipment can be easily used by common, non-expert users too, increasing the number of artifacts acquired in this stage. Vases were placed on a rotating table, which was previously prepared

Digital reproduction of colors and materials used in pottery: a case study from the ancient Picenum with the application of a set of *Ringed Automatically Detected* targets (RAD) printed upon stickers, then applied to the circular flat surface bearing the artefact to be digitized. Every artifact was captured rotating the table at equal angles (about 18 degree each), shooting with locked camera settings. At least 60 pictures of every vase were taken, changing the height of the shooting position and carefully turning objects upside down (Figure 2).

These parameters grant overlapping for every shot, taken at a reasonable distance from objects illuminated by diffuse lights, placed outside of a photographic illumination box. Vases were initially documented using a Nikon D7000 DSLR camera with a fixed 50 mm. lens kit placed on a tripod.

#### *Analysis, editing and color calibration*

To faithfully replicate the color appearance of the digitized vases, single shots used for the photogrammetric reconstruction were color-calibrated, framing a standard color target in images. A common solution for target-based color characterization (McCamy et al. 1976) relies on the ColorChecker Classic produced by X-Rite, which shows standardized patches with known reflectance. A proper depth-of-field value was chosen to prevent diffraction blurring, while fine tuning for colors considered the issues expressed by Simone et al. (2021). The photogrammetric 3D reconstruction, in terms of *bundle adjustment*, camera orientation, sparse cloud and dense one generation, was carried out following two different pipelines, in order to evaluate the final outcomes of a commercial workflow (using the Agisoft Metashape software) and that of an open source ones (COLMAP for the *Structure-from-Motion* and *Multi-View Stereo* point cloud reconstruction pipeline and OpenMVS for the final 3D mesh generation). Some custom scripts were also developed to better identify the base plane orientation through RAD targets (Figure 3). Once successfully produced, textured 3D models were studied and analyzed following traditional representation methods to isolate decorations and figures. They can be decomposed, in fact, into their basic cognitive elements, displayed under different synthetic sources of lighting, unwrapped in cylindrical projection views to facilitate an in-depth iconographic, stylistic and shape analysis (Mara and Sablatnig 2006).

To ease these operations, 3D models were catalogued to identify geometric invariants, such as local symmetry or internal rotation axes. 2D drawings were later inferred from 3D models slicing them with suitable section views produced through simple calculations of arithmetic means between the coordinates of the bounding box planes surrounding single models, and symmetrically calculated on the reference system adopted in the reconstruction.

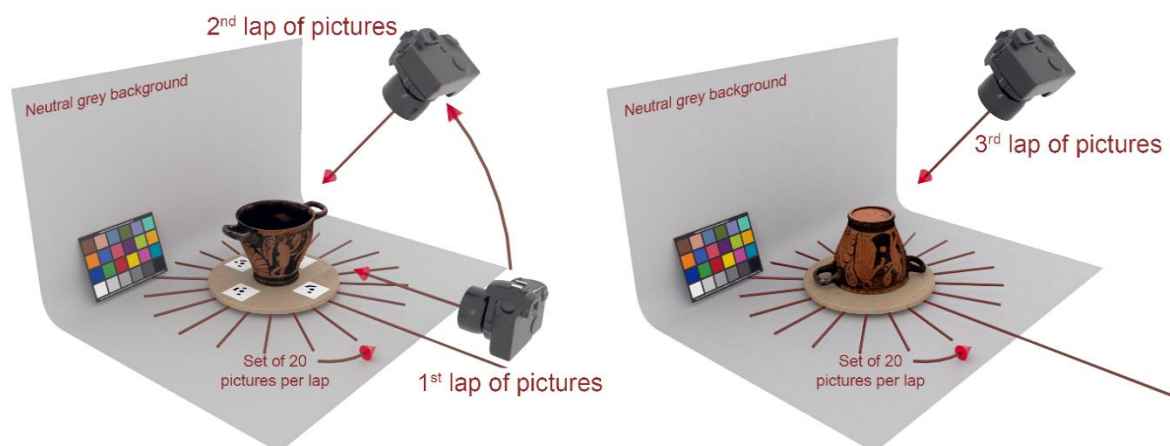

Figure 2: The general acquisition sequence, with 3 laps of pictures shot around every ceramic.

For circular or elliptical rotational geometries, where the inner side was often difficult to capture, we went back to the ideal geometry, minimizing the sum of the square distances of the axis searched for from contour points identified on the models' surfaces (Gander et al. 1994).



Figure 3: A digital reconstructed of an Attic red-figure skyphos from Davanzali necropolis (T.216, inv. 27356). On the left (a) the Agisoft Metashape 3D model from color calibrated raw images, on the right (b) the same photoset processed with COLMAP + openMVS.

#### *Production of graphics and documental drawings*

Once the virtual geometry and its references were defined, digital models were sliced to get views passing through the planes identified as by Mara (Mara et al. 2007). This process leads to produce a faithful representation of the ceramic thickness, with a maximum error deviation never exceeding 2.1 mm when compared to reference ground models acquired with active technologies.

Where it was simply not possible to identify the internal surface of the vases, additional sectional elements were drawn offsetting external surfaces inward according to values as far as known. The section profile was then exported from the three-dimensional model to CAD software, where two-dimensional drawings were perfected.

Thence, attention was paid to the graphic representation of figured parts. For some time now there have been contributions in the literature that suggest analytical expressions to obtain cylindrical projections of the mappings pertaining to the figures in historical pottery (Karras et al. 1996). More recent works hypothesize the use of triangular strips adapted to the surface of arbitrary objects to unfold them more easily through unfolding algorithms (Massarwi et al. 2007).

Although the cylinder is the simplest geometric primitive to carry out a representation arranged on a curved surface, we decided to use spherical primitives to obtain an equirectangular projection of the textures of the photogrammetric model, to facilitate the interpretation of figures and decorations with a final rendition much more similar to traditional manual drawings (Rieck et al. 2013).

#### *Organization of the general information archive*

During the research work, many samples were collected and digitized following the approach introduced: files and data were gathered into repositories organized in a hierarchical way. 3D final models, 2D drawings and color metadata proper of the digitized objects such as their geographical location and place of conservation were collected. These data may, in the future, be linked to museums or public institutions databases, in which 3D models will act as graphical indexes to provide users with easy access to much more detailed information. The overall methodology proved to be a significant resource for enhancing the vast cultural heritage of the pre-Roman Numana.

## **ACKNOWLEDGEMENTS**

This project was developed thanks to the “Almaidea” founding program of the University of Bologna. Authors would like to thank the *Soprintendenza ABAP* and the *Direzione Regionale Musei of the Regione Marche* for the valuable support during surveys and excavations.

## **REFERENCES**

- Baldoni, V. and S. Finocchi. 2019. Nuove ricerche sui contesti funerari di Numana: temi, metodi e prospettive di ricerca. In *Dialoghi sull'Archeologia della Magna Grecia e del Mediterraneo. Atti del III Convegno Internazionale di Studi. Paestum, 16-18 novembre 2018*, III.3. Paestum: Pandemos: 631-642.
- Bursich, D. and A. Pace. 2017, Ripensando il «metodo Beazley». *Ceramica attica e fotomodellazione 3D: il caso del Painter of Syracuse 19861. ACalc* 28: 73-91.
- Gander, W., G.H. Golub, and R. Strebel. 1994. Least-squares fitting of circles and ellipses. *BIT* 34: 558-578.
- Karras, G. E., P. Patias and E. Petsa. 1996. Digital monoplotting and photo-unwrapping of developable surfaces in architectural photogrammetry. *Int. Arch. Photogramm. and Remote Sensing XXXI Part B5*: 290–294.
- Mara, H. and R. Sablatnig. 2006. Determination of Ancient Manufacturing Techniques of Ceramics by 3D Shape Estimation. In: *Proceedings of 12th International Conference VSMM Interactive Technologies and Sociotechnical Systems (VSMM'06)*. H.Z.Z. Pan, H. Thwaites, A.C. Addison and M. Forte, Berlin: Springer, 349-357.
- Mara, H., M. Kampel, F. Niccolucci, and R. Sablatnig. 2007, Ancient Coins & Ceramics – 3D and 2D Documentation for Preservation and Retrieval of Lost Heritage. *Int. Arch. Photogramm. and Remote Sensing XXXVI-5/W47*.
- Massarwi, F., C. Gotsman, and G. Elber. 2007. Papercraft Models using Generalized Cylinders. In: *Proceedings 15th Pacific Conf. on Computer Graphics and Applications*. Maui, USA:148–157.
- McCamy, C.S., H. Marcus, and J. Davidson. 1976. A color-rendition chart. *J. Appl. Photogr. Eng.* 2: 95–99.
- Rieck, B., H. Mara, and S. Krömker. 2013. Unwrapping highly-detailed 3d meshes of rotationally symmetric man-made objects. *ISPRS Ann. Photogramm. Remote Sens. Spat. Inf. Sci.* II-5/W1: 259–264.
- Schonberger, J. L., and J. M. Frahm. 2016. Structure-from-motion revisited. In: *Proceedings of the IEEE Conference on Computer Vision and Pattern Recognition*, Las Vegas, NV, USA, 27–30 June 2016: 4104–4113.
- Simone, G., M. Gaiani, A. Ballabeni, and A. Rizzi. 2021. Complex process of image color correction: a test of a target-based framework. *J. Opt. Soc. Am. A* 38: 663-674.
- Trinkl, E. 2013 (Hrsg.). *Interdisziplinäre Dokumentation - und Visualisierungsmethoden, Corpus Vasorum Antiquorum Österreich, Beihefte I*. Wien, Österreichische Akademie der Wissenschaften.
- Vak, B. 2013. *Auf der Suche nach dem Original. Anwendungen und Illustrationen naturwissenschaftlicher Diagnostik an attisch igürlich bemalter Keramik aus der Antikensammlung des Kunsthistorischen Museums*. In: Trinkl, E. 2013: 41-72.

# Polychromy from the Atacama Desert (South America). An interdisciplinary approach for an archaeology of color

Marcela Sepúlveda<sup>1,2,\*</sup>

<sup>1</sup> Pontificia Universidad Católica de Chile, Escuela de Antropología, Chile; e-mailmsepulver@uc.cl

<sup>2</sup> UMR8096 ArchAm (CNRS-Paris 1), France.

\* Corresponding author: msepulver@uc.cl

## Abstract

Two archaeological pieces with polychromy from the Atacama Desert of northern Chile in South America are presented for the first time. These pieces show colors (red, yellow, black, blue, green, and white), which demonstrate not only the mastery of their authors but also the knowledge associated to raw materials available in their environment. From an interdisciplinary perspective, we resume the pigments used and discuss the color technologies developed by the desertic populations, between approximately 1,000 and 1,550 AD. Results presented are not only unprecedented for the Atacama Desert, but also for a vast region in the south of the Andean area, as well as showing the existence of a wide chromatic palette rarely observed in the archeology of the South American continent. Together these data are inserted into a broader investigation encompassed as "Archeology of Color" defined to considering color through the study of its materiality.

**Keywords:** Color, Polychromy, Archaeology, Archaeometry, South America

## INTRODUCTION

This research provides, through a case study, an interdisciplinary proposal which we synthesize as an archeology of color (Jones and MacGregor 1999). We propose the study and interpretation of color from archaeological contexts by means of the combination of information given not only from archeology, but also from ethnohistory, chemistry and geology, among other disciplines. We reinforce the necessity to conceive color as material culture, that is to say, from its materiality (physical, tangible, representational features and material properties) as a result of the ideas of people inserted in a particular socio-historical and cultural context, but more importantly whose social value in itself lies in the active role that occurred in social interactions established between individuals-materials, but also between them and their environment (Appadurai 1986; Gage 1999; Meskell 2005; Miller 2005; Feaser et al. 2016; Waburton 2019; Young 2006). Thus, it is not only to characterize the materials used in the production and obtainment of a varied color palettes, or to ponder about their origin and the different forms of consumption and/or multiple meanings, but also to understand their value and role in different contexts in which they were inserted from their materiality. In the South-Central Andean area, various ethnohistoric and material sources make it possible to ensure that the exploitation and circulation of mineral pigments not only were equally important to nourish an entire American colonial pictorial artistic production (Siracusano 2005). Juan de Betanzos in 1551 points out that in pre-Hispanic times the "colored powder" mines in the Lipez area in southwestern Bolivia were highly sought after by the Inca empire, including minerals and colored powders paid to the empire, feeding wide circulation networks along the way:

*"What they had were mines of many very fine colors to paint and of all those colors that we have [...] these [Indians] sent [Tupac Inca Yupanqui] to pay those colors" (Betanzos [1551, ch. XXXVI] 1987: 164, in Siracusano 2005).*



In the same sense as ethnohistoric sources, recent archaeological studies in pre-Hispanic sites on the western slope of the Atacama Desert have compelled the traditional understanding of mining commonly limited to its exclusively metallurgical field to be broadened (Salazar and Vilches 2014), and to understand that the exploitation of mineral sources was also aimed at obtaining and producing pigments (Salazar et al. 2011, Sepúlveda et al. 2019). In addition to the exploitation of iron oxides (Salazar et al. 2011, Sepúlveda 2014a, 2019), there is evidence related to pigments produced from the extraction of manganese (Sepúlveda 2013a, 2015), minerals of copper (Sepúlveda et al. 2013b, 2014b), jarosite (Sepúlveda et al. 2013c), orpiment and cinnabar (Ogalde et al. 2014, 2015) to thereby create a palette nourished of colors used on different supports. However, even nowadays we do not know the sources of origin of most of these pigments except for the case of the El Condor Mine (Sepúlveda et al. 2019). The exploitation of gypsum evidenced in certain locations in the desert could be used as a load in the paint recipe (Blanco 2013, Blanco et al. 2017).

We present 2 unpublished archaeological pieces from the Atacama Desert painted with 5 colors. Additionally, preliminary results obtained by portable X-ray fluorescence are presented, which are discussed in the light of previously published data.

### **POLYCHROMATIC OBJECTS FROM THE ATACAMA DESERT**

The pieces presented in this occasion are currently deposited in the National Museum of Natural History of Santiago de Chile (Table 1).

	<b>Code</b>	<b>Material</b>	<b>Locality</b>	<b>Responsible</b>	<b>Colors</b>
Pieces 1 y 2	2013.1.944	Pumpkin	Chiuchiu	-	Red, yellow, green, black and white
Piece 3	9473	Wood	Quillagua	Ricardo Latcham 1932	Red, yellow, green, black and white

Table 1: Synthesis of archaeological objects analyzed.

The two archaeological pieces come from two locations in the interior of the desert: Chiuchiu and Quillagua, both located in the hydrographic basin of the Loa River, the only watercourse that crosses the driest portion of the Atacama Desert, in an east-west direction. From the high foothills to the Pacific coast (Figure 1). Both locations have a long research tradition (Gallardo and Odone 2019; Castro et al. 2016). In summary, although there are no direct C14-AMS dates, the available evidence tentatively allows these pieces to be ascribed to the Late periods, between 1,000 and 1,550 AD (Latcham 1933, Mostny 1952, Spahni 1963, Thomas 1978; Uribe 1999-2000).

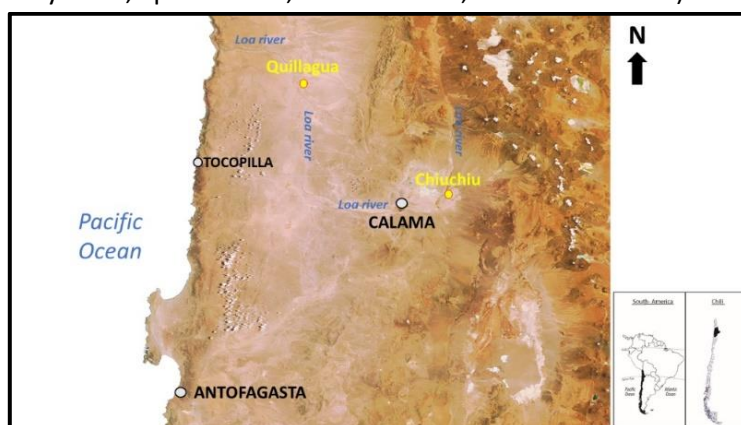

Figure 1: Map of the localities studied in the Atacama Desert from northern Chile.

The first two pieces come from Chiuchiu and consist of two parts made from pumpkin fragments (Figure 2a). Both are rectangular in shape and have on one of their longer sides, cuts in the wood that together form a kind of serrated or zigzag. In terms of decoration, the background is mostly green with a red stripe along one of the narrower sides. In the center is a motif made up of 4 fields separated by relatively thin white lines which define a double-specular symmetry. Each of these fields in turn presents sub-fields of two colors: black-green or red-yellow, separated in turn by another white line in a scaled manner. The interesting aspect is the composition produced by the symmetry and distribution of the color fields (Figure 2b). Additionally, a specular symmetry is observed between the two pieces of pumpkin, whose shapes and colors then appear completely opposite (Figure 2c). This intentional symmetry allows us to suggest that these two pieces were undoubtedly manufactured to be used together. Although we do not know their exact function, due to the two small perforations present in the red band located at one of the narrower ends, we think that they could be used hanging possibly as part of a personal ornament attached to some textile or leather clothing.

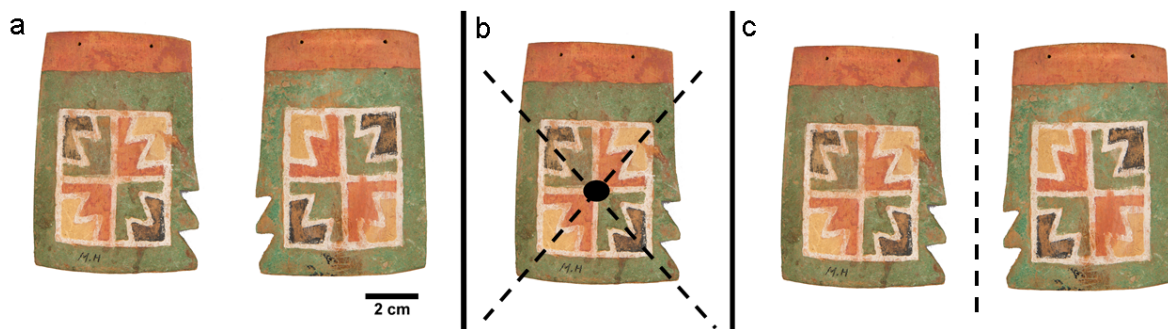

Figure 2: Pieces 2013.1.944. Two polychromatic objects made of pumpkin material.

The third piece comes from Quillagua (Figure 3), that is, approximately 119 km from the place where the first two pieces previously described were found. Although this object has morphological and decorative characteristics identical to those of Chiuchiu, it has the particularity of having been made of wood. Like the pumpkin, its decoration was made with the same 5 colors: green, black, white, red and yellow.



Figure 3: Pieces 9473. One polychromatic object made of wood.

### **CHEMICAL COLOR ANALYSIS**

As a preliminary analytical approach to determine the composition of the paints, we carry out a measurement using portable X-Ray Fluorescence (XRF). These were carried out in situ with a Bruker

Polychromy from the Atacama Desert (South America). An interdisciplinary approach for an archaeology of color brand equipment, model Tracer III-SD, using an energy of 40 KV and a current flow of 37.8uA for 200s. The S1PXRF, ARTAX 7, Origin programs were used to analyze the spectral information. Table 2 summarizes the main chemical elements identified in the different pieces studied here. At an elementary level, in synthesis, certain differences are observed, as well as similarities resulting from two important limitations of this analysis that it is important to highlight. Despite some restrictions, we observe (Table 2) that both red and yellow were obtained from iron oxides, while green mainly presents copper. Black did not generate a clear elemental signal, so we interpret the probable use of some organic dye. Finally white presents essentially the elements of calcium and sulfur.

Code of pieces analyzed	Colors				
	Red	Yellow	Green	Black	White
2013.1.944	Fe, Ca	Fe, Ca	Cu, Fe	Ca, Cu	Ca, Cu, S, Fe
9473	Cu, Fe	Fe, Cu, Ca	Cu, Ca, Fe	-	Cu, Ca, S, Fe

Table 2: Synthesis of principal elements identified with XRF.

## **DISCUSSION AND CONCLUSIONS**

The color palette used in the cases analyzed here shows profound similarities with that identified in the rupestrian art of the same region (Cabello et al. 2022). Additionally, it shows similarities in terms of the material production of the colors, by specifying the use of iron oxides, calcium sulfate (gypsum), and copper minerals (Sepúlveda et al. 2013b, 2014b).

The use of five colors refers to the arrangement of five different preparations with different raw materials, a particular dedication limited only to some objects or representations. Although we do not know the reason for this specific and restricted use, its presence demonstrates a particular feat, rarely observed in the Andes, except in the mural painting of several monumental constructions on the coast and mountains in Peru. Thus, the knowledge related to its obtaining and production, as well as the deployment of a particular polychromy allow to highlight a particular handling of colors by the pre-Hispanic populations of the Atacama Desert in northern Chile. Ratified knowledge of historical sources indicates that the extraction and circulation of pigments from this region were integrated into the colonial circulation and market from the seventeenth century (Siracusano 2005), which also circulated without doubt previously during pre-Hispanic times.

This preliminary research allows us to recognize and value a particular polychromy scarcely observed in the pre-Hispanic Andes. The unpublished pieces presented here demonstrate an unusual practice and a display of specific knowledge in relation to pigment production. A local traditional technological development that was undoubtedly highly valued in late and early historical times as evidenced by various historical references.

The scarce number of polychrome pieces identified so far, together with the motifs represented, forces us to think not only about their meaning, but also about the value of these objects, the colors and the role with which they invested in their bearers. Questions that we will think over continuously within the framework of an archeology of color currently underway in the Atacama Desert of northern Chile.

## **ACKNOWLEDGEMENTS**

Project FONDECYT 1190263 provided funds for the work described here. Thanks to Sebastian Gutierrez from LAIA at Department of Anthropology- Universidad de Tarapacá and to Cristian Becker and Francisco Garrido for their reception and support at Museo Nacional de Historia Natural.

## **REFERENCES**

- Appadurai, A. 1986. *The Social Life of Things. Commodities in cultural perspective*. Cambridge University Press, Cambridge.
- Betanzos, J. de, 1987 [1551]. *Suma y Narración de los Incas*. Madrid: Imprenta de Manuel G. Hernandez.
- Blanco, J. 2013. *La extracción prehispánica de recursos minerales en el internodo Quillagua-costa, Desierto de Atacama*. Undegraduate thesis of Archaeology, Departamento de Antropología, Universidad de Chile.
- Blanco, J., I. Correa, C. Flores and G. Pimentel. 2017. La extracción prehispánica de recursos minerales en el internodo Quillagua-Costa, desierto de Atacama. *Estudios Atacameños* 56: 77-102.
- Cabello, G., M. Sepúlveda y B. Brancoli. 2022. Embodiment and fashionable colours in the rock art paintings from the Atacama Desert (northern Chile). *Rock Art Research* 38(1). In press.
- Cobo, B., 1890 [1653]. *Historia del Nuevo Mundo*. Sevilla: Imprenta de E. Rasco.
- Feeser, A., M. Daly Goggin and B. Fowkes Tobin. 2016. Introduction: the value of color. In: *The materiality of color. The production, circulation, and application of dyes and pigments, 1400-1800*, A. Feeser, M. Daly Goggin and B. Fowkes Tobin, eds. London and New York: Routledge, 1-13.
- Gallardo, F. and C. Odone. 2019. El oasis de Quillagua- una nota sobre fronteras entre picas y atacamas. *Revista Antropologías del Sur* 6(12): 175-187.
- Gell, A. 1998. *Art and Agency*. Oxford: Oxford University Press.
- Jones, A. and G. MacGregor. 2002. Introduction: Wonderful things-colour Studies in archaeology from munsell to materiality. In: *Coloring the past. The significance of colour in archaeological research*, A. Jones and G. MacGregor, eds. New York: Berg publishers, 1-21.
- Latcham, R. 1933. Notas preliminares de un viaje arqueológico a Quillagua. *Revista Chilena de Historia Natural* 34: 130-138.
- Meskel, L. 2005. Introduction. Object orientations. In: *Archaeologies of Materiality*, L. Meskel (Ed.), pp. 1-17. Blackwell Publishing.
- Miller, D. Materiality: An Introduction. In: *Materiality*, D. Miller, ed. Durham: Duke University Press, 1-50.
- Mostny, G. 1952. Una tumba de Chiuchiu. *Boletín MNHN* 26: 1-33.
- Ogalde, J.P., C. Salas, N. Lara, P. Leyton, C. Paipa, M. Campos- Vallette and B. Arriaza. 2014. Multi-instrumental identification of orpiment in archaeological mortuary contexts. *Journal of Chilean Chemistry Society* 59(3): 2571-2573.
- Ogalde, J.P., B. Arriaza, C. Paipa, P. Leyton, M. Campos-Vallette, N. Lara, C. Salas and P. Tapia. 2015. Multi-instrumental characterization of two red pigments in funerary archaeological contexts from northern Chile. *Interciencia* 40 (12): 875-880.
- Salazar, D. and F. Vilches. 2014. La arqueología de la minería en el centro-sur andino: balance y perspectivas. *Estudios Atacameños* 48: 51-21.

- Polychromy from the Atacama Desert (South America). An interdisciplinary approach for an archaeology of color Salazar, D., D. Jackson, J.L. Guendon, H. Salinas, D. Morata, V. Figueroa, G. Manríquez and V. Castro. 2011. Early evidence (ca. 12.000 BP) for iron oxide mining on the Pacific coast of South America. *Current Anthropology* 52(3): 463-475.
- Sepúlveda, M., V. Figueroa y J. Cárcamo. 2014b. Pigmentos y pinturas de minerales de cobre en la región de Tarapacá, norte de Chile: nuevos datos para una tecnología pigmentaria prehispánica. *Estudios Atacameños* 48: 23-37.
- Sepúlveda, M., V. Figueroa and S. Pagés- Camagna. 2013b. Copper pigment making in the Atacama Desert (northern Chile). *Latin American Antiquity* 24(4): 467-482.
- Sepúlveda, M., F. Gallardo, B. Ballester, G. Cabello and E. Vidal. 2019. El Condor mine: prehispanic production and consumption of hematite pigments in the Atacama Desert, northern Chile. *Journal of Anthropological Archaeology* 53: 325- 341.
- Sepúlveda, M., S. Gutierrez, M. Campos-Valette, V. Standen, B. Arriaza, J. Cárcamo. 2015. Micro-Raman spectral identification of manganese oxides black pigments in archaeological context in Northern Chile. *Heritage Science* 3: 32. DOI 10.1186/s40494-015-0061-2.
- Sepúlveda, M., H. Rousseliere, E. Van Elslande, B. Arriaza, V. Standen, C. Santoro and P. Walter. 2014a. Study of color pigments associated to Archaic chinchorro mummies and grave goods in Northern Chile (7.000- 3.500 B.P.). *Heritage Science* 2: 7
- Sepúlveda, M., H. Rousseliere, E. Van Elslande, J. Cárcamo and P. Walter. 2013c. Caracterización de bloques amarillos del sitio Playa Miller 7 (costa norte de Chile). In: *Patrimonio cultural: la gestión, el arte, la arqueología y las ciencias exactas aplicadas*, C. Vázquez, O. Palacios and N. Ciarlo, eds. Buenos Aires: CNEA, 263-270.
- Sepúlveda, M., D. Valenzuela, L. Cornejo, H. Lienqueo and H. Rousseliere. 2013a. Óxidos de manganeso en el extremo norte de Chile: abastecimiento, movilidad y producción del color negro durante el período arcaico. *Chungara* 45(1): 143-159.
- Siracusano, G., 2005. *El poder de los colores. De lo material a lo simbólico en las prácticas culturales andinas. Siglos XVI y XVII*. Buenos Aires: Fondo de Cultura Económica.
- Spahni, J.-C. 1963. Tombes inédites du cimetière atacaménien de Chiu-Chiu (Chili). *Bulletin Société Suisse des Américanistes* 26 : 2-9.
- Thomas, C. 1978. Estudio arqueológico del poblamiento prehispánico tardío de Chiu-Chiu. *Revista Chilena de Antropología* 1 : 85-105.
- Uribe, M. 1999-2000. La arqueología del inka en Chile. *Revista Chilena de Antropología* 15: 63-97.
- Warburton, D. 2019. Value of colour: introduction. In: *The value of colour. Material and economic aspects in the ancient world*, S. Thavapalan and D. A. Warburton, eds. Berlin: Edition Topoi, 9-34.
- Young, D. 2006. The colours of things. In: *Handbook of Material Culture*, C. Tilley, W. Keane, S. Küchler, M. Rowlands and P. Spyer, eds. Londres: SAGE Publications, 173-185.

# The hidden history of woad blue: a path through technology and diffusion of “European indigo” in 18<sup>th</sup>-century technical literature

Camilla Tartaglia <sup>1,\*</sup>

<sup>1</sup> Department of Architecture and Urban Studies, Politecnico di Milano; camilla.tartaglia@polimi.it

\* Corresponding author: camilla.tartaglia@polimi.it

## Abstract

Woad, the famous “European indigo” plant, still hides some unknowns in its long history. This study wants to contribute to a better understanding of woad’s diffusion and use in Italy throughout the 18<sup>th</sup> and first half of the 19<sup>th</sup> century, by analysing the technical-agricultural literature of this period. The research allowed to collect some information on the “geography” of Italian woad, on its processing techniques and on its relation to “rival” Indian indigo, showing that Italy still had some relevant woad-producing centres at the time, and that woad was still acknowledged to have a significant dyeing function.

**Keywords:** dye plants, woad, indigo, technique, eighteenth century

## INTRODUCTION

Since the beginning of the second millennium, the art of dyeing in blue has always been of special importance to European industry. Up to the whole Medieval period, dyers all over Europe used to dye their cloths in a gorgeous blue colour with a colour-yielding plant that goes by the name of *Isatis tinctoria*: woad. Until then, the foreign “cousin” of woad, Indian indigo, coming from the East and yielding a more intense blue, was imported into Europe only in small quantities. Italy, which was at the forefront in Medieval woollen cloth production, had several praised dyeing centres that made great use of woad, and just as many woad cultivation areas which supplied them. The end of the 15<sup>th</sup> century, though, was a game-changer: the pioneer voyages undertaken by European navigators allowed to discover new trade routes to the East Indies, resulting in more and more indigo reaching the Old Continent. The praised Oriental dye had an enormous success, and woad, so far the undisputed queen of European blues, started a relentless downfall.

In contrast to what is sometimes assumed, though, the decline of woad was not abrupt. Several studies nowadays contribute to this evidence, but a precise measure of woad’s use and diffusion after the spread of indigo is still lacking, especially when it comes to the 18<sup>th</sup> and first half of the 19<sup>th</sup> century.

In Italy, in particular, the diffusion of woad in this period has been little investigated by now. Some studies have allowed to gain a better understanding of “late” woad cultivation and production in certain territories, such as the precious contributions of Brunetti (1994), Palombarini (1995-98) and Petrongari (1994) respectively in relation to Piedmont, Marche, and the area of Rieti. Franco Brunello also discusses woad-related processes in 18<sup>th</sup>-century dyeing industry of the Venetian Republic, and Guarino et al. (2000) deal with woad in the Kingdom of Naples in this period. On the whole, however, many issues still remain unclear. Most importantly, it is difficult to estimate to what extent Italian woad was actually used, and therefore how important it was in the productive setup of early industrial times.

To get insight into this topic, the technical literature of the 18<sup>th</sup> and early 19<sup>th</sup> century is a privileged means of knowledge. The Age of Enlightenment was characterized by the pursuit of everything that could prove useful for the progress of humankind: its striving for “scientific” and “technological” improvement was conveyed by a literary production that embraced all fields of human knowledge, including several topics related to the art of dyeing. As to the Italian technical literature, specifically, only a limited part of it has been investigated by now in relation to dye plants and dyeing-related

processes. Therefore, this study wants to take advantage of this peculiar literary production to get some glimpses into the “hidden” history of woad blue throughout the 18<sup>th</sup> and early 19<sup>th</sup> century.

### **THE “PLACES” OF ITALIAN WOAD**

The rush for systematization and improvement that marked the Age of Reason also involved the fields of botany and agriculture, resulting in a considerable number of dictionaries, periodic journals and monographs concerning agriculture being published in Italy between the second half of the 18<sup>th</sup> and the first half of the 19<sup>th</sup> century. Most botanists and agronomists were not specifically interested in dyeing processes, but dealt with dye plants in relation to agricultural issues: bearing in mind that providing the reader with an accurate “geography” of woad was not the authors’ main aim, and that the lively exchange of knowledge between different intellectual environments across Italy and Europe may have sometimes led to reporting second-hand information, the Italian technical-agricultural literature can still offer some precious clues about the diffusion of woad. We hereby examine the points of view of various Italian regions: through the eyes of some selected authors, we can get a firmer grasp of Italy’s woad cultivation, production and trade in this period.

By the second half of the 18<sup>th</sup> century, the glorious Republic of Venice had long lost its former economic power and was facing its imminent end. In the field of dyeing, as thoroughly discussed by Brunello (1968), *La Serenissima* remained mostly anchored in ancient – and sometimes obsolete – treatises. Nevertheless, one of the first Italian attempts to echo the innovative European (mostly French) approach towards the art of dyeing comes from a Venetian treatise: Pietro Arduino, Professor of Agriculture at the University of Padua, gathers information and makes new experiments on dye plants that converge in his treatise, “*Memorie*”, published in Padua in 1766. From Arduino we learn that the woad used by dyers in the Venetian Republic at that time could be either imported from Germany and from Lombardy, or home-grown. *Ça va sans dire*, local woad is said to be the best.

A later author from Veneto, who is interesting to consult since he draws most of his information from earlier sources, is the agronomist Francesco Gera. His agricultural dictionary, “*Nuovo dizionario universale e ragionato di agricoltura*”, published between 1834 and 1850, is a colossal work that summarises current European knowledge on agricultural topics. As late as the mid-19<sup>th</sup> century, Gera decides to devote two articles to woad, in Vol. XII (1840) and in Vol. XXII (1844), describing its cultivation modalities as well as its processing techniques and uses: the very need to explain how to cultivate and use woad is an important clue, and is in all likelihood a sign of an actual and still diffused practice. Concurrently, the author also gives a brief geographical description of woad’s diffusion at the time: he says that it is still cultivated in Germany, in England, both in northern and southern France in the surroundings of Caen, Valenciennes, Castres, Albi, Toulouse and Avignon (Vol. XXII), and that it is still extensively cultivated in many parts of Italy (Vol. XII), although he does not specify where.

Moving to Milan, a city that was at the forefront in Italy’s enlightened literary production, we find another dictionary, the “*Dizionario universale economico-rustico*” written by the Milanese priest Glicerio Fontana under the pseudonym of Creneo Insubre and first published in Milan between 1773 and 1791. In its second edition, published in Rome, this agricultural dissertation devotes a long article to woad (“*Guado, Gualdo, Glasto, Pastello, Isatide*”) in Vol. IX (1794), providing a detailed description of cultivation modalities and processing techniques of woad in Italy. The reader learns that at the time this plant was not sufficiently cultivated in Italy, and particularly in Lombardy, to supply local dyers’ needs, with the result that many provinces had to resort to importing expensive foreign woad.

Nevertheless, two areas in Italy still grew and traded fine and renowned woad: Castel nuovo Tortonese (likely to be identified nowadays with Castelnuovo Scrivia, in the heart of Piedmont’s historical woad-growing area) and Rieti, part of the Papal States, today capital of the homonymous province in the region of Lazio. Other minor woad-production centres were also Borgo San Sepolcro and Città di Castello in the Valtiberina, another historically important Italian woad area. The author says that Rieti’s “*pastello*” in particular was so renowned, that its trade all across Italy and Europe was a major income for the territory at the time: the main trade destinations were the towns of Matelica and Norcia in the Papal States and, above all, Capodimonte in the Kingdom of Naples. The information about the importance of Rieti’s woad production supports the idea that Italy still had important woad centres in the late 18<sup>th</sup> century, which not only supplied many Italian regions, but also other European countries.

An insight into Tuscany’s agriculture is given some years later by doctor and botanist Ottaviano Targioni Tozzetti, member of a notable Tuscan family of scholars. Among his various works on agricultural topics, his *Lessons on agriculture (“Lezioni di agricoltura specialmente Toscana”)*, published in six volumes between 1802 and 1804, give a special account of Tuscany’s cultivations. A lesson on dye plants is reported in Vol. II (1802) and a specific dissertation on woad in Vol. VI (1804): the author states that woad is still cultivated in Borgo San Sepolcro, in the Marche region and in the surroundings of Cortona, although not as extensively as in the past times of great Tuscan wool industry (Vol. II). The extension of such cultivation must have been especially limited in the *Cortonese* area, though, if we give credit to canon Andrea Zucchini, author of several botanical and agricultural writings related to Cortona: in a dissertation held in 1778 he states that woad, as well as madder, has “*fallen into total oblivion and disuse*” in Cortona (“*da molt’anni indietro andarono in totale oblio, non che in disuso*”).

Finally, a collection of issues concerning Italian agriculture was printed in Milan between 1809 and 1814 in the scientific periodical that goes by the name of “*Annali dell’agricoltura del Regno d’Italia*”. Its eminent author, Filippo Re, at that time Professor of Agriculture at the University of Bologna, was one of the Italian agronomists whose works had most widespread circulation across the country.

When dealing with woad, Re’s *Annals* are surely influenced by Napoleon’s Continental Blockade, which in those years notably endorsed woad reintroduction as a consequence of the lack of indigo import. Nonetheless, several articles included in the *Annals* are prior to the Blockade-induced “woad rush”. Not only do they mention the contributions of Arduino, Fontana and Targioni Tozzetti (*Annali*, Vol. IX), but also other dissertations on woad are reported. From a record written by the Friulan botanist Giovanni Brignoli, Professor of Botany and Agriculture in Urbino (Vol. IX), we learn that at the time woad was documented to grow spontaneously in many parts of Italy (in mountainous regions of Piedmont, in Valle d’Aosta, in the surroundings of Urbino, and all across the Kingdom of Naples), but it was also cultivated on small scale in Friuli. The author states that such cultivations were meant for local use: a certain Cesari, dyer in Udine, is said to have been cultivating woad for 40 years to meet the needs of his personal dyeworks, and the author himself asserts to have been supplying self-grown woad to local dyers for 10 years in the surroundings of Udine.

### **SOME OBSERVATIONS ON WOAD’S PROCESSING TECHNIQUES**

The authors discussed above also provide accounts of how woad was prepared and used, which allow us to delve deeper into woad manipulation described from the point of view of Italian sources.



Overall, we learn that the main steps of the processes were more or less the same everywhere (in Italy as well as in Europe). Harvested woad leaves were ground in woad mills, and the resulting paste was arranged in heaps and composted. After some weeks, or sometimes one or two months, the paste underwent a second grinding step and was then shaped into loaves or elongated balls: when these woad loaves were dry, they were broken up again and sprinkled with liquid (usually water) to reactivate fermentation. The coarse powder obtained in the end was finally ready to be sold and used. The whole process, from the first harvest to the final product, took several months (even over a year according to Targioni Tozzetti). Such descriptions, aligned in their main steps, are spiced up with little details of “local taste” that probably stand for actual local processes: for example, Targioni Tozzetti is the only one to call “*barca*” the heap of woad paste, and to write that the “*barche*” are disinfected by sprinkling them with the juice of fresh woad leaves (*Lezioni*, Vol. VI).

Until now, records of eminent agronomists and botanists have been discussed. But the scientific literature of that period passed on to us also some singular, precious accounts of real woad growers and dyers: this is the case of Gioachino Cesari, dyer in Udine. Cesari must have been quite popular at his time, according to the different notices about him reported in Filippo Re’s *Annali*: he is cited in the letter by Giovanni Brignoli mentioned above (*Annali*, Vol. IX) and a thorough description of his work is given in Vol. X (1811). The latter, in particular, is an interesting dissertation on woad cultivation and dyeing processes written by the Secretary of the Agrarian Society of Aquileia. While writing an account on local woad growers, he examines the case of Gioachino Cesari, reporting and discussing a sort of “interview” in which the dyer speaks about his work.

First of all, we learn that Cesari cultivated woad for the purpose of supplying his own dyeworks, so we are dealing with a rather small-scale cultivation intended for local use. When it comes to the description of woad’s cultivation modalities, we get to know that some little differences occur between Cesari’s ways and the methods recommended by scholars. This is probably due to a factor that distinguished Cesari from most of the authors: experience on the field.

As to woad preparation for dyeing purposes, on the contrary, it is said that between Cesari and the “authors” there are no significant differences but one: Cesari’s process is simpler. It might be interesting to analyse this detail. It seems logical that woad cultivated for use on small and local scale was prepared in a different way than a product that was destined for sale and trade. Scholars’ treatises usually give account of large-scale processes, since these were considered the most relevant ones for the welfare of society and economics, which was a key target of the enlightened enthusiasm for scientific progress. As a drawback, we rarely get to know small-scale processes like this one.

Specifically, Cesari only macerates woad, and after leaving it to rest he directly uses it in the vat; he does not make woad loaves or use any particular additives. What must have been most interesting for intellectuals of the time, longing for a replacement of Indian indigo, is Cesari’s claim that – sadly – woad alone is not sufficient to make a beautiful blue tint: woad is used to get a solid basis, but an unspecified “*calculated dose*” of indigo needs to be added to gain in brightness and preciousness.

### **The relation between woad and indigo**

The previously mentioned words of Gioachino Cesari are one of the “hints” the ancient literature gives us to estimate the relation between woad and indigo at the time, and similar information is hidden in other discussed sources. Almost all of them, when talking about woad, mention the fact that its blue colour needs to be combined with indigo, and the practice of mixing the two blue dyes in “woad vats” in that period is already well known today. Indeed, several authors nowadays wonder whether woad

balls were still used for their colour-yielding function at the time, or if their role in the vat was only to activate fermentation, thus creating the reducing conditions which are necessary to dye with indigo powder.

Pietro Arduino is very clear about woad: it is one of the most important dyes and forms every possible shade of blue and green, and it can be used either alone or combined with indigo, although the latter solution is said to be much better. In 1844, Francesco Gera writes that woad is mixed with indigo to increase the fastness and intensity of the latter: this statement seems to mark woad as the “best” colour between the two of them, in contrast to what other sources say, although later authors like Gera might be biased because of the enthusiasm for woad that arose during the Blockade years.

Fontana’s dictionary provides us with interesting information on the relative prices of the two dyes. At the end of his article, he states that woad yields an excellent, very colourfast deep blue colour, which is used as a base for obtaining many other colours and also to “fix” indigo on cloths: “*woad* – he continues – *was once preferred to indigo [...], but now indigo has prevailed over woad because it is more beautiful and maybe because it is cheaper than woad itself*”. Thus, if we give credit to Fontana’s words, the convenience and the availability that marked woad’s success over indigo during the Middle Ages had been turned around in favour of indigo at this point.

Overall, it appears that woad was still acknowledged to have a relevant dyeing function. The specific role of its blue colour was frequently mentioned. However, it was barely used alone by then: it mainly seems to have been used as a “base” or in mixtures, above all with its long-time rival indigo. In the eyes of today’s reader, it seems that scholars and small-scale dyers had an important point in common: woad was still said to be an important dye, but indigo was an indispensable ingredient in the vat.

## **CONCLUSIONS**

A selection of 18<sup>th</sup> to early 19<sup>th</sup> century technical literature dealing with woad in Italy has been presented. Although this sort of brief “review” does not claim to be exhaustive and will be enriched with other sources in the future, it can still lead to some conclusions.

A first observation is that woad was still a relevant topic at the time. Several different “intellectual environments” across Italy were interested in providing and discussing information on this plant. The very need to explain how to cultivate and prepare it most likely indicates an actual need for guidelines and a practical outcome: indeed, today’s reader must bear in mind that enlightened authors mostly wrote about what was actually useful.

From the “geographical” analysis, we can conclude that the importance of several historical Italian woad-producing centres had changed. The major Medieval woad area of inner Tuscany seems to have significantly declined by then, whereas Piedmont’s production was still quite renowned and supplied several Italian regions with “Lombard woad”, although we learn that neighboring Lombardy also needed to import some woad from abroad. The area of Rieti, on the other hand, which was as well a historical woad area but had always been less important than the former two, was now at the forefront in Italy’s woad production. A measure of Reatin woad’s importance is given by its trade routes, which not only supplied many Italian areas, but even reached other European countries. The Kingdom of Naples, in particular, seems not to have grown enough woad within its boundaries to meet the needs of the factories promoted by the Bourbons, and had therefore to turn to Rieti’s supplies.

Overall, we get to know that the trade of Italian woad was still quite intense at the time, both between different Italian regions and outgoing towards Europe. But we also learn that woad had an important local dimension, being cultivated on small scale for local use. As to this last topic, the

literature of this period – typically searching for the useful – provides us with some precious records of authentic working procedures like the ones of Gioachino Cesari, “hidden” within learned dissertations.

In conclusion, the collected information shows that Italy still had some relevant woad-producing centres between the second half of the 18<sup>th</sup> and the beginning of the 19<sup>th</sup> century, which in some cases reached out to European trade routes. It seems that this woad was not just a supporting component in indigo vats, but that it still had an active role in dyeing in blue, although its combination with indigo was unavoidable. Finally, further insights into the trade of woad in Italy and additional observations about the following steps of woad’s productive cycle – that is, the processing procedures that lead from the colouring matter to the final application product – will be discussed in future contributions.

### **ACKNOWLEDGEMENTS**

This study has been conducted with the contribution of DASTU “Fragilità Territoriali” Research Project funded by the Italian Ministry of Education, Universities and Research (MIUR), within the Departments of Excellence Initiative 2018-2022.

### **REFERENCES**

- Arduino, P. 1766. *Memorie di osservazioni e di sperienze sopra la coltura, e gli usi di varie piante che servono, o che servir possono utilmente alla tintura, all'economia, all'agricoltura, ec.* Padova: Stamperia del Seminario.
- Balfour-Paul, J. 2011. *Indigo. Egyptian mummies to blue jeans.* London: The British Museum Press.
- Borlandi, F. 1959. Il commercio del guado nel medioevo. In: *Storia dell'economia italiana. Saggi di storia economica vol. 1*, C. M. Cipolla, ed. Torino: Edizioni Scientifiche Einaudi, 263-284.
- Brunello, F. 1964. L'arte della tintura a Venezia nel secolo XVIII. In: *Cultura e Scuola*, 10, ed. Roma: Ente Nazionale per le Biblioteche Popolari e Scolastiche, 270-275.
- Brunello, F. 1968. *L'Arte della Tintura nella storia dell'umanità.* Vicenza: Neri Pozza Editore.
- Brunetti, A. 1994. Il gualdo lombardo. In: *Beiträge zur Waidtagung*, 4/5 (1-3), H.E. Müllerott, ed. Arnstadt: Thüringer Chronik-Verlag, 64-66.
- Cardon, D. 2007. *Natural dyes. Sources, tradition, technology and science.* London: Archetype Publications.
- Fontana, G. 1793-97. *Dizionario universale economico-rustico. Seconda edizione corretta ed aumentata.* Roma: Michele Puccinelli.
- Gera, F. 1834-50. *Nuovo dizionario universale e ragionato di agricoltura.* Venezia: Giuseppe Antonelli.
- Guarino, C., Casoria, P., and Menale, B. 2000. Cultivation and use of *Isatis tinctoria* L. (Brassicaceae) in Southern Italy. *Economic botany*, 54(3), 395-400.
- Palombarini, A. 1995-98. Il Guado ed altri vegetali nell'economia delle Marche in Età moderna. In: *Actes/Papers/Beiträge. 2ème Congrès international “Pastel, Indigo et autres Teintures naturelles: Passé, Présent, Futur”*, D. Cardon & H.E. Müllerott, ed. Arnstadt: Thüringer Chronik-Verlag, 161-68.
- Petrongari, A. 1994. Produzione e commercio di guado a Rieti nei secoli XVIII° e XIX°. In: *Beiträge zur Waidtagung*, 4/5 (1-3), H.E. Müllerott, ed. Arnstadt: Thüringer Chronik-Verlag, 67-72.
- Re, F. 1809-14. *Annali dell'Agricoltura del Regno d'Italia.* Milano: Giovanni Silvestri.
- Targioni Tozzetti, O. 1802-04. *Lezioni di Agricoltura Specialmente Toscana.* Firenze: Guglielmo Piatti.
- Zucchini, A. 1778. *Sopra la Luteola sativa. Pianta, che sotto il volgar nome di Bietola gialla da tempo immemorabile si coltiva, ed è in commercio per la Tintura nell'Agro Cortonese.* Sine loco.

# A Study on the Color of Miao's Badai Culture in Fenghuang County of China

Qian Huangge <sup>1,\*</sup>

<sup>1</sup> School of Architecture, Hunan University; huangqian@hnu.edu.cn

\* Corresponding author: huangqian@hnu.edu.cn

## Abstract

This paper takes the color of Badai culture, the indigenous religion of the Miao in Fenghuang County of China, as the object of study and analyzes its symbolic meanings in the context of religion. Through fieldwork and NCD color system, this study analyzes the meaning and function of colors in sacrifices, ritual artifacts, and religious clothing.

**Keywords:** Miao nationality religion, color translation, NCD color system

## INTRODUCTION: Introduction to the Indigenous Religion in Fenghuang County

Fenghuang County is located in the southwest of Hunan Province, situated between 109°18'-109°48'E and 27°44'-28°19' N. It is home to mostly the Miao people, with Hong Miao (Red Miao) exerting the biggest influence (Ling and Rui, 2003). The indigenous religion, Badai (Miao: *baxdeib*), has a history of more than 5000 years.

In Fenghuang County, Badai is also the indigenous term for ritual specialists, a career for men only, which generally falls into three categories: Badaixiong (Miao: *baxdeibxongt*); Badaizan (Miao: *baxdeibruanx*), and Badairuan. The first two types are most common that can be seen in almost every village.



Figure 1: *Chizhu* (Eating a Pig) Ritual Performed by Badaixiong and Badaizan together in Kejia Village, Heku Town.

Badaixiong is the prototype of Badai, worshipping deities and original ancestors with rituals performed in the Miao language. They usually work as scholar-officials who are rational and communicative to inform ancestors.

Badaizan, on the other hand, is another branch combining Badaixiong and Taoism, worshipping ghosts with rituals performed in Han Chinese using written texts to keep record of divine words and ritual processes. They usually work as military officials and the rituals they perform mainly belong to the Han system.

## Badai Rituals and Color Symbolism

One of the most important rituals in Badai culture is *zhuiniu* (literal meaning: killing the buffalo with a spear). During the ritual, a water buffalo is made to get drunk, jump wildly and then sacrificed under a spear. Apart from the animal sacrifice, the Miao people also celebrate the heroic acts of their ancestors

and pray for their blessings. As for the religious clothing, Badaixiong is in dark colors, and females and hosts are all fully dressed up, with flags of five colors hanging on the altar, which once again proves the grandeur of this ritual from the color alone (He 2011).

The Ghost Festival of the Miao lasts from July 7th to July 15th of the lunar calendar. Apart from preparing wine and food, burning joss paper and lighting incense to worship ghosts and spirits, the Miao people in Fenghuang County also release water lanterns made from red paper on the last day of the festival as a symbol of releasing the wandering spirits.

*Dazhu* (literal meaning: beating pigs) is one of the rituals that are performed within the family, with slight differences in the form according to different purposes. One way is to kill pigs with blood slashing, usually using slaughtering knives. It is often performed when something good happens, such as making a fortune, childbirth etc., as a way to inform the ancestors and pray for their blessings. The other is to kill pigs without spilling blood, usually by knocking them to death with certain tools. The ritual is often performed in this way when the family is having bad luck, for instance when family members are sick or in disaster. From different ways of performing *dazhu* and their associated meanings, it can be seen that the color of red is a symbol of luck.

The color of the sacrifices vary from rituals to rituals too. According to *Xiangxi Miaozu Shidi Diaochabaogao* (Field Reports on the Xiangxi Miao) by Shi Qigui (2008), cattles and pigs are used as the sacrifices, with colors ranging from white, black to spotted (having a white head and tail). Another ritual is called *zhuojigua*, divination through chicken parts. In this ritual, the specialist plants flags of five colors on the ground, burns joss paper, hits bamboo tubes, and then cooks the chicken and reads fortune from its bones by using bamboo sticks to measure the depth of the bone holes. The five colors of the flags are red, yellow, black, green, and white, placed in different positions as required. From these two examples, it can be seen that color plays an important role in sacrifices and rune paper in Badai culture.

### **Color Symbolism of Ritual Artifacts in Badai Culture**

#### *Color Symbolism of Badaixiong's Ritual Artifacts*

Badaixiong's ritual artifacts feature various types and shapes, used to connect human and celestial beings, cast out demons, and command gods and ghosts. These include *xintong* (a tube-shaped musical instrument), *lingmai* (a copper bell), *gua* (divinatory instruments), and *shaola* bowl (containing wax to burn). Most of them have the color of the material itself.

*Jinling*, (*kenmai* in the Miao language), has a copper clapper inside that rings when struck. It is mainly used for supplicating ancestors. The number of cloth strips on the bell stands for the length of employment, and the color for the degree of satisfaction, with red and the alike (such as brown red and brick red) indicating a high degree, while black and the alike (such as dark blue and dark green) a relatively low one.



Figure 2: The Symbolic Meaning of Colors of the Cloth Strips on Jinling.

### Color Symbolism of Badaizan's Ritual Artifacts

There are seven kinds of Badaizan ritual artifacts, namely *mabian* (a linen whip), *liujin* (a kind of cloth strips), *kang* (divinatory instruments), *denggun* (a double-edged knife), a token, *gainian*, and a seal. In some places, *Chiyou* Stick is added to the list (Zhang 2011). Similar to Badaixiong's, these artifacts (except for *liujin*) also have the same color as their materials'.

Among them, *liujin*, a kind of cloth strips used to expel and entertain ghosts, covers the largest area and plays the most important role in assisting body language. The color of *liujin* has a high level of saturation, a variety of hues and a balanced distribution in the color wheel. These cloth strips, together with clothing such as the highly-saturated red robe and the phoenix hat (see more details in the next section), accentuate Badaizan's power through color, building up a carnival atmosphere in the Miao rituals.

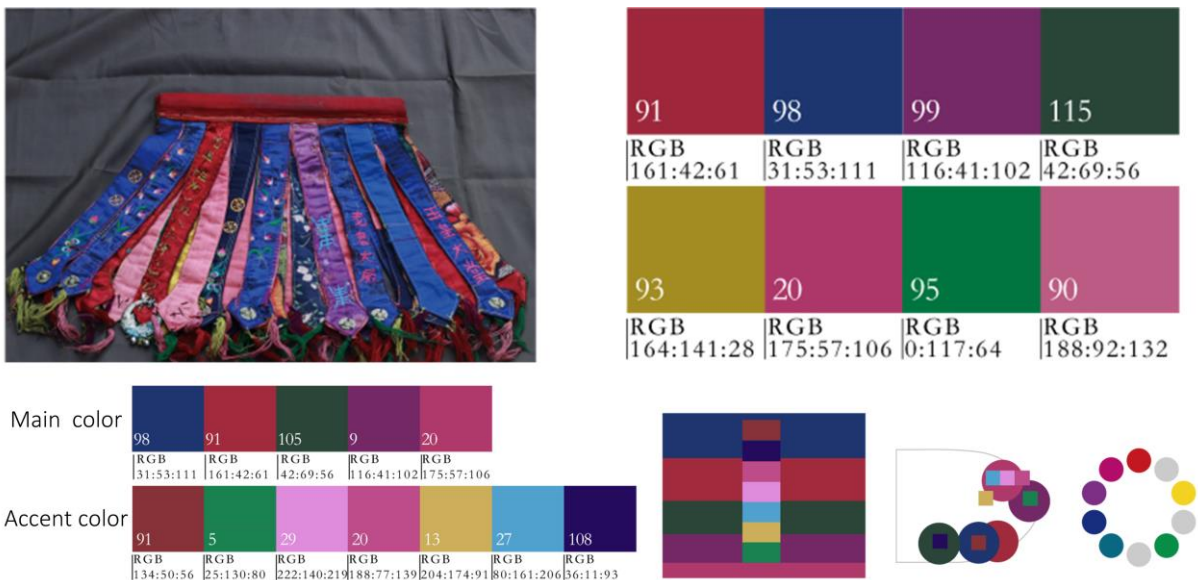

Figure 3: Color Analysis of *Liujin*.



## Color Symbolism in Religious Clothing of Badai Culture

### *Color Symbolism in Religious Clothing of Badaixiong*

Although Badaixiong's religious clothing is also of daily use, it should be in green and *duijin* style (with buttons in the middle). Also, Badaixiong wrap their heads with linen in shades of black, so as to differentiate themselves from secular men.

The color of Badaixiong's religious clothing is mostly blue, with a low value (brightness), saturation, and contrast. This color combination gives an impression of solemnity, awe and authority, which goes hand in hand with Badaixiong's main duty to communicate with ancestors.



Figure 4: Color Analysis of Badaixiong's Religious Clothing.

### *Color Symbolism in Religious Clothing of Badaizan*

Badaizan's religious clothing is mostly red, a color of strength, excitement and aggression, one of the hues that occupy the greatest energy. This is also related to Badaizan's main duty. As the Miao

attribute bad things such as diseases, infertility problems, and short-lived livestock to evil ghosts, Badaizan is often invited to expel them by force, and red is a symbol of strength.

In specific, Badaizan wears a red robe, a red headscarf, and a phoenix hat. The red robe is also known as Celestial Master Robe, or *aox qini* in the Miao language. It is a deep V-neck cardigan robe, reaching down to the ankle, which facilitates them expelling evil ghosts. The red headscarf is wrapped around the head which should hide hair but not ears (Yi 2016: 38-41).



Figure 5: Color Analysis of Badaizan's Religious Clothing.

The hat of badaizan is known as Phoenix Crown, or *guand nhal* in the Miao language. It is made of sturdy and thick kraft board, painted with the image of gods and ancestors. Based on the color analysis,



there exists a pattern in color: it becomes cooler and brighter towards the middle, with the two sides being colorless with a low value (brightness).



Figure 6: Color Analysis of Badaizan's Headgear Phoenix Crown.

The color analysis of the paintings indicates a range of five traditional Han colors, namely black, white, red, green and yellow. Among them, blue and green are most widely used, for they are more perceivable to the Miao compared with other hues and are thus their favorite colors.

In conclusion, Badai culture constructs the unique collective unconscious of the Miao in Fenghuang County, Xiangxi of China. The color of the ritual artifacts and religious clothing indicates a division of labor among ritual specialists and symbolizes the supernatural powers endowed.

### Reference

- Ling, C. S. and Y.F. Rui. 2003. *An Ethnographic Report on the Miao People in the Xiangxi Area*. Beijing: the Ethnic Publishing House.
- He, S. L. 2011. *A Study on the Aesthetic Awareness of the Miao Ethnic Group*. (Doctoral dissertation). Available from CNKI.
- Shi, Q. G. 2008. *Xiangxi Miaozu Shidi Diaochabaogao* [Field Reports on the Xiangxi Miao]. Changsha: Hunan People's Publishing House.
- Zhang, Z. W. 2011. *Xiangxi Jiju Xisu* [Customs of Ancestor Worship in Xiangxi]. Changsha: Hunan Normal University Press.
- Yi, Z. Q. 2016. *Fenghuang Miaozu Jisi Fushi Quyufenlei Yanjiu* [A Study on Religious Clothing of the Miao in Fenghuang County]. *Yishu Shenghuo-Fuzhou Daxue Xiamen Gongyi Meishu Xueyuan Xuebao* (4) 02: 38-41.

# Reading Medieval Colour. The Case of Blue in the *Canterbury Tales*

Zoriana Lotut<sup>1,\*</sup>

<sup>1</sup> University of Warsaw; zoriana.lotut@student.uw.edu.pl

\* Corresponding author: zoriana.lotut@student.uw.edu.pl

## Abstract

Contemporary readers struggle with the terms of colour in medieval literary texts due to the difference in our colour systems. The current dominant colour model is hue-based. The approach of this model is to perceive colour as part of the electromagnetic radiation, which is measurable in wavelength. Therefore, elementary colour terms in contemporary language predominantly correspond with prismatic colours. As a result, interpreting medieval colour terms with a contemporary hue-dominated perspective creates numerous misunderstandings. In the Middle Ages, the fundamental guidelines for colour perception were luminescence, surface reflectivity, and colour intensity. In medieval literary texts, colour terms frequently described the materiality of the colour, the tactile qualities of the colour, and the general appearance (e.g. glittering or matt). In the *Canterbury Tales* by Geoffrey Chaucer, as discussed in this paper, there are four terms used to describe the colour blue, of which only one can be identified as a hue term. Accordingly, this paper will analyse the terms that portrayed blue in the *Canterbury Tales* from the perspective of medieval colour measures and explain how they are different from the colour blue, as we know it today.

**Keywords:** medieval colour, brightness/saturation, hue, blue, *Canterbury Tales*

## INTRODUCTION

All colours can be described through the aspects of hue, brightness, and saturation. Hue is a term that describes colour as being different from another colour (e.g. blue as being different from yellow). The definition of colour in this sense relies on the measurement of wavelength (Roque 2018: 27). Hue corresponds to prismatic colours, which is the property of light determined by spectral positions (Casson 1997: 224). Brightness defines a colour in terms of the degree of its luminosity – its lightness as opposed to its darkness. Brightness is occasionally defined as an indication of the ‘degree of surface reflectivity’ present in the object of any hue (Casson 1997: 224). Finally, saturation describes a colour in terms of the degree of its intensity and brilliance. Saturation reflects the ‘relative dullness-vividness of a hue, determined by the amount of its admixture with either white or black’ (Casson 1997: 224). Saturation primarily relates to the pigmentary colour. It depends on the tinctorial qualities of pigments and colourants, their colourfastness, their durability, and the degree of the intensity of the colour irrespective of the hue. It is well-established that ancient and medieval textile dyeing processes, which used natural colourants, could result in all sorts of colour hues.

In most contemporary languages, basic colour terms describe a colour as a hue and coincide considerably with prismatic colours, which is the reason why the prevalence of hue terms is often blamed on Newton. However, the idea that colour was equal to its hue was rooted in the Renaissance (Roque 2018: 32). In the Middle Ages, most colour terms in Indo-European languages defined colour by either brightness or saturation and rarely by hue (Roque 2018: 33). Medieval treatises spoke of pigmentary colour, and the recipes focused on the processes of pigment preparation. On the contrary, Alberti's treatises from the Renaissance proposed colour systems: the colour of fire (red), air (*perse*<sup>1</sup>), water (green), and the earth (ashes).

---

<sup>1</sup> *Perse* is most frequently interpreted as blue.

### The Difficulties in the Interpretations of Historical Colours

Michel Pastoureau repeatedly stressed that there was no place for blue, which only emerged around the twelfth century, in the colour systems that dominated the Antiquity and the Middle Ages. Pastoureau depicted this fact through the lack of interest (*désintérêt*) in blue in the Antiquity and the Middle Ages periods. However, blue was widely used as a pigmentary colour at the time, and some blue pigments (i.e. lapis lazuli and indigo) enjoyed enormous prestige (Roque 2018: 30). Additionally, uncertainty exists around the translation of most Biblical colour terms (Pastoureau 2000: 19). These complexities originated from the interpretations of historic colours as hues. All efforts to determine the essence of the historic colour – through identifying its meaning at the hue level – have been anachronistic and misleading.

Similarly, the ancient Greek colour terms are misinterpreted when approached with the current hue-dominated perspective. In his *Studies on Homer and the Homeric Age* (1858), Gladstone was one of the first to realise that we were far from ‘being able to render the language of the ancients for colour into our own with the confidence, which we can feel in almost every other department of interpretation’ (Gladstone 1858: 458). The chromatic language of ancient Greece inclined towards ‘the vast predominance of the most crude and elemental forms of colour, black and white, over every other’ and the predilection to use ‘the same word to denote not only different hues or tints of the same colour but colours which, according to us, are essentially different’ (Gladstone 1858: 458). Upon further analysis, Gladstone noticed that some colour terms ‘refer to light, and not to colour, and bear the sense of sparkling’, while others ‘indicate a dark hue but cannot be referred to any one of the known principal colours’ (Gladstone 1858: 472). Gladstone’s study has highlighted how the ancient Greeks perceived colours on the darkness/lightness axis and focused on the aspects of brightness and saturation. Furthermore, intensely coloured objects of different hues were categorised using the same colour term.

Contrary to the current widely accepted approach of perceiving colour as a hue, in earlier periods, languages used words that described the ‘complex sensation of colour’ (Lerner 1951: 246). Therefore, interpreting historic colour words in a contemporary language often requires descriptions that involve chromatic aspects but are not limited to them e.g. ‘a dark murky hue’ for *fuscus*, ‘chestnut colour’ for *spadix*, ‘brown with a touch of gold’ for *fulvus*, and ‘something between red and black’ for *rubidus* (Lerner 1951: 246–247). The abovementioned Latin colour terms can be loosely interpreted as brown in today’s hue-dominated colour naming system. Ancient Greeks and Romans were not colour-blind – as claimed by some evolutionary theories – they were hue-blind (Lerner 1951: 247).

### The Evolution of the English Colour Vocabulary

#### *General Aspects of Historic Colour in English*

Historic English colour terms experienced a similar path of evolution as described above. This is evident through the existence of the lightness–darkness opposition in Old English literature (Mead 1899: 175), which often acquired metaphysical dimensions of symbolically evoking heaven and hell, joy, and sadness, respectively (Barley 1974: 17).

For the Anglo-Saxons, colours were the visual attributes of objects – many Old English words that were typically interpreted as colour terms – were ‘appearance’ words (Barley 1974: 18). In addition to the lightness–darkness scheme, another significant factor in colour perception in the ancient and medieval periods was surface reflectivity. The characteristics included in the chromatic term were the ‘tactile, light-reflecting (or light-absorbing) qualities, specifying whether it is fully saturated, dappled,

glittering, or shiny’ (Pulliam 2012: 5). For example, the colour term *brun* was specifically used with reference to well-polished metal surfaces as well as ‘helmet, a sword-edge, the waves of the sea, the feathers of the Phoenix and an Ethiopian (*brune leode*)’ (Lerner 1951: 247). These objects did not have the ‘brown’ colour in common. The common factor was the quality of glistening in the sunlight/brilliance (i.e. a high level of surface reflectivity).

The contemporary hue-based colour perception is substantially disconnected from the materiality of colour, which was another factor utilised in the historic colour naming process. Since all medieval colours originated from natural sources, their hue aspects were unstable and inconsistent (Pulliam 2012: 5). Therefore, medieval colour terms often referred to the material source of colour (i.e. pigment, dyestuff, colourant) rather than the hue potentially obtainable from it. Treating fabric with natural dyes often resulted in a variety of hues.

Chronologically, the semantic shift from the brightness/saturation terms to hue colour terms started in the Middle English period (Casson 1997: 223–224, 232). Of course, some of the Old English (c. 600–1150) colour terms were ‘minimally conceptualised’; however, hue domination started to manifest itself more prominently in the Middle English period (c. 1150–1500) (Casson 1997: 225). The association of the brightness aspect was phased out from the Old English colour terms (with a few exceptions) and was converted to predominantly hue terms in the Middle English period.

### *The Evolution of Blue*

The Old English term *haewen* (often interpreted as blue) was practically absent from Middle English, where it was replaced by *blew(e)*. The etymology of the term was traced back to the Old French *blau* (or *blo*), descended from the Latin *blavus*, which in turn derived from the Germanic *blewaz*, and, earlier still, from the Indo-European *bhle-wo* (Casson 1993: 230). Although the Latin language used the term *caeruleus* for blue, the Vulgar Latin introduced to the people conquered by the Roman Empire absorbed a Germanic term *blaveus* (*blavius*, *blavus*). The vernacular form of *bleu* resulted from the influences of Gallo-Romance, Germanic languages, and possibly the introduction of Old Norse *blá-r* (blue, dark) (Sayers 2021: 122). In her study of English colour terms, Alice Pratt also suggested that there was an influence of the Old Norse. She believed that the colour term *blo* was not a French borrowing and was used to describe pale bluish, greenish, or greyish shades, often applied to the complexion of a bruised or ill person, or smoke: ‘Langland’s vocabulary ... contains ... no real blue, for “*blo*” as used by him means “livid” – Old Norse *blar*, not Old French *bleu*’ (Pratt 1898: 2).

The Middle English *blew(e)*, or *bleu*, was first introduced as a basic term shortly before the year 1300 (Casson 1993: 230). There were numerous spelling forms of the Anglo-French *bleu* (e.g. *blau*, *blew*, *blieus*, *bliu*, *bloe*, *blou*, *blu*, *blue*, *bluef*, *bluw*, *blwe*, *blef*, *bleif*, *blief*). Furthermore, the chromatic range of this colour term was all equally varied and disconnected (e.g. discoloured, livid, bluish, blue, azure; blue-grey, ashen, grey, pale, unstained; fair, golden, tawny; dark, stern, gloomy) (Sayers 2021: 123). It remains uncertain as to whether this was a pure hue term. The term was occasionally used – depending on the context – as a brightness term referring to paleness and discolouration. The reference to the blue colour is evident in the uses of *blewe* or *bleu*, which as Middle English hue terms were applied to all sorts of blue-coloured objects like ‘flowers, pigment, dye and enamel, cloth and clothing, and skin or complexion affected by a blow or severe cold’ (Casson 1997: 230).

### **CHAUCER’S COLOUR VOCABULARY**

Chaucer’s use of colour words highlights many features that support the abovementioned outline of the evolution of colour terms from brightness/saturation to hue terms. His literary works are also

notable, chronologically, because they were created during the shift to hue colour terms. While most of the Old English poetry displayed a mastery in the usage of colour terms, which described the aspects of pale and dark, by Chaucer's time, it was a widespread practice for French, Italian, and English poets to choose basic colour terms to 'create a riot of color' (Biggam 1993: 45). Chaucer's usage of certain colour lexemes illustrated their decline in Middle English, as compared to Old English – words like *dun* and *falow*<sup>2</sup>, which were quite popular Old English brightness/saturation terms, occurred only several times in Chaucer (Biggam 1993: 42). Statistically, Chaucer used most of his hue adjectives in poetry (Biggam 1993: 48). Chaucer's basic colour terms and most frequently used colour words in the *Canterbury Tales* were hue lexemes of English origin – *whit*, *reed*, *grene*, *blak*, *yellow*, and *grey*. The extent of his colour vocabulary was exceptional. A study by Alice Pratt (1898) revealed that while Langland had only used 12 colour terms, Gower had used 15 terms, and Chaucer had used 42 terms (Pratt 1898: 4). As a colourist, Chaucer occupied the leading position among his contemporaries, with his colour vocabulary only lower than Elizabethan writers (Pratt 1898: 4).

Chaucer's categorisation of blue was unusual for many reasons. The colour, blue, in the *Canterbury Tales* was represented exclusively by French borrowings: *asur*, *blew*, *pers(e)*, and *waget*, which should not be surprising considering the author's French origin and familiarity with the court life of England, where the French language was influential at the time (Biggam 1993: 41–42). Chaucer's contemporary, Gower, who was equally familiar with the French language, used 'from the Romance languages only 4 of his 14 colour terms, as contrasted with Chaucer's 17 Romance words out of 42' (Pratt 1898: 3). According to Biggam's study (1993), Chaucer used an average of five synonyms per one colour category (43). Since Old English terms for blue (*haewen*, *waeden*, and *blaewen*) were generally abandoned by the speakers of Middle English, Chaucer's use of French loans allowed him to fill the category of blue with approximately the same amount of colour terms as other colour categories. He also used at least one or two French colour terms in other colour categories (Biggam 1993: 45).

The development of heraldry, sumptuary laws, guilds, and a centralised religious and secular government 'stabilised' the symbolism of medieval colours in the Romanesque and Gothic period (Pulliam 2012: 7). One of the blue terms used by Chaucer – *asure* – was a well-established heraldic colour code in Europe. On one occasion, Chaucer used it in the description of the wedding gift in *The Clerk's Tale* (line 254–5): *Of gemmes, set in gold and in asure, / Brooches and rynges, for Grisildis sake*. On another occasion, it was used in the colourful description of the Chauntecleer (rooster) in *The Nun's Priest's Tale* (line 2862–64). This line was remarkable since Chaucer's general descriptions of wild birds, hunting birds, or domestic fowl are conventionally monotonous throughout his oeuvre. It was suggested that Chauntecleer's colours allude to the heraldic codes of Henry Bolingbroke, Duke of Hereford (Biggam 1993: 47). This seems like a reasonable conclusion as in the description of Chauntecleer the term *asure* is closely followed by gold – its typical heraldic colour opponency.

If the colour terms were not heraldic codes with clear allusions to the values attached to them, or dyestuff terms with the obvious reference to the saturation and colourfastness of high-quality textiles, colour symbolism within medieval literary texts should be analysed through the prism of its brightness/saturation. A positive symbolism is attributed to brightness/saturation colour terms, while a negative symbolism is connected to paleness/darkness colour terms. For example, a yellow colour often had a negative connotation due to its connection to Judas and has been used as a stigmatising code since medieval times. In medieval literary texts, yellow often indicated jealousy. On the other

<sup>2</sup> The word *dun* was used in line 334 of the *Parliament of the Fowls* and in line 2908 of *Troilus and Criseyde*. It was used in the sense of a brownish grey colour describing the appearance of hair or feathers. The word *falow* was used in line 1364 of the *Canterbury Tales* (the *Knight's Tale*) and in line 1936 of the *House of Fame*, meaning dusky, pale, faded; reddish or brownish yellow.

hand, yellow hair combined with brightness indicated beauty in both men and women. When deprived of the quality of brightness, however, yellow hair indicates ill health or ugliness. Similarly, the augmented surface reflectivity of the object establishes the positive symbolism to it, irrespective of the hue. The shininess factor could reverse an otherwise established symbolism; therefore, grey can also be attractive when shiny (Biggam 1993: 51–52).

Colour terms connected to garment descriptions, names of dyestuffs, and coloured textiles were one of Chaucer's favourite subjects (Pratt 1898: 4). In this sense, the *Canterbury Tales*, a 'parade of many varied characters' was certainly remarkable (Biggam 1993: 48). Statistically, the most frequently used colour terms regarding clothing were *blak* (18 occurrences), followed by *grene* (16), *whit* (14), and *reed* (8 occurrences, five of which describe hose), black, green, white, and red respectively (Biggam 1993: 47). Since textile colour terms in medieval literary texts were closely connected and often synonymous with dye terms, symbolically, they suggested wealth and a high status (Biggam 1993: 47). The following is a list of the four descriptions of blue-coloured garments in the portraits of four different characters in the *Canterbury Tales*, which illustrates the use of saturation and hue colour terms to highlight the symbolic hierarchy of characters:

- In **sangwyn** and in **pers** he clad was al, (General Prologue, v. 439, describes Doctor of Medicine)
- A long surcote of **pers** upon he hade, (General Prologue, v. 617, describes Reeve)
- Al in a kirtel of a lyght waget, (The Miller's Tale, v. 3321, describes Absolon, the parish clerk)
- A whit cote and a **blew hood** wered he, (General Prologue, v. 564, describes Miller's garment)

In these descriptions, the reader can observe the gradation in the saturation of the textile colour. Considering the functioning and symbolism of medieval coloured garments, such gradation can be related to the social status of the wearer. Textile colour terms *pers* and *waget* describe the most expensive fabrics of intense blue, purplish-blue, or dark blue hues dyed with woad (*Isatis tinctoria*). The first garment description pertains to the portrait of the *Doctor of Medicine*, a wealthy, respectable member of society. The description of the highly saturated blue garment of the Doctor is heightened by another medieval textile colour term (*sangwyn*) equally connected to fabrics of intense colour (red). *Reeve*<sup>3</sup>, a person lower in rank to the *Doctor of Medicine* but also quite wealthy, wears the garment described by the word *pers* – a high saturation textile colour term. The gradation is observable in both the saturation of the coloured textiles, expressed by the dyestuff colour terms, and in the quantity of coloured fabric. The *Doctor* is fully clothed ('clad was al') in highly saturated red and blue garments, while *Reeve* has only one garment item ('a long surcoat') of saturated coloured fabric. The *parish clerk named Absolon* wears the *kirtel*, and the textile colour term which describes it – *waget* – is preceded by the word light ('lyght'), which presumably tones down the chromatic intensity of the fabric described. The Miller, the fourth *Canterbury Tales* character dressed in blue, wears a 'blew hood'. This garment item is not described by a textile colour term. The colour term *blew*, as previously mentioned, was a predominantly hue term of Middle English.

## CONCLUSIONS

In conclusion, brightness and saturation can change the appearance of a colour, irrespective of the hue. The contemporary colour perception assumes that hue and colour are identical. However, if we imagine a pale green cloth and the bright green of spring verdure, we will understand how these two are different visual sensations. Since colour words in modern languages refer almost exclusively to hue, yellow and green are perceived as different colours. Figure 1 shows the word 'colour' in yellow

---

<sup>3</sup> Historically a senior official like a town magistrate or the supervisor of the landowner's estate.

written on the green background. Indeed, yellow and green look different if their saturation/brightness is maximised (Figure 1, right). However, when it is minimised (Figure 1, left) and if seen from a distance, the inscription will be practically indistinguishable, and the two different hues will look almost identical.



Figure 1: The words 'colour' written in yellow on a green background with varying saturation levels.

Therefore, the hue-dominated colour perception diverts our attention from other aspects of colour (saturation, brightness, surface reflectivity of coloured objects, and colour materiality) and makes us overlook the fact that colour is a complex sensation.

### REFERENCES

- Barley, N. F. 1974. Old English Colour Classification: Where Do Matters Stand? *Anglo-Saxon England* 43: 15-28 *JSTOR*, [www.jstor.org/stable/44510646](http://www.jstor.org/stable/44510646). Accessed 22 March 2021.
- Biggam, C. P. 1993. Aspects of Chaucer's Adjectives of Hue. *Chaucer Review* 28.1: 41-53.
- Casson, R. W. 1997. Color shift: evolution of English color terms from brightness to hue. *Color categories in thought and languages*, Ed. Hardin C. L. and Maffi L., Cambridge: Cambridge University Press: 224-239.
- Chaucer, G. 1987. *Works. The Riverside Chaucer*. Ed. Benson L. Boston: Houghton Mifflin Co.
- Gladstone, W. E. 1858. *Studies on Homer and the Homeric Age*. Oxford: Oxford University Press. *ARCHIVE* <https://archive.org/details/studiesonhomerho03glad>. Accessed 15 June 2021.
- Lerner, L. D. 1951. Colour Words in Anglo-Saxon. *The Modern Language Review* 46.2: 246-249. *JSTOR*, [www.jstor.org/stable/3718566](http://www.jstor.org/stable/3718566). Accessed 22 March 2021.
- Mead, W. 1899. Color in Old English Poetry. *PMLA* 14.2: 169-206 *JSTOR*, <http://www.jstor.org/stable/456571>. Accessed 30 May 2021.
- Pastoureau, M. 2000. *Bleu. Histoire d'une couleur*. Paris: Edition du Seuil.
- Pratt, A. 1898. *The Use of Colour in the Verse of the English Romantic Poets*. Chicago: The University of Chicago Press. *ARCHIVE* <https://archive.org/details/usecolorinverse00pratgoog>. Accessed 30 May 2021.
- Pulliam, H. 2012. COLOR. *Studies in Iconography* 33: 3-14. *JSTOR*, [www.jstor.org/stable/23924264](http://www.jstor.org/stable/23924264). Accessed 22 March 2021.
- Roque, G. 2018. *Quand la lumière devient couleur*. Paris: Editions Gallimard.
- Sayers, W. 2021. Chaucer and the Color Adjective *blew*. *The Chaucer Review* 56.2: 119-124.

# Identifying the colour of Longquan Celadon Porcelain

Xiaochan Ge <sup>1,\*</sup>, Xue Mao <sup>2</sup> and Jie Xu <sup>3</sup>

<sup>1</sup> China Academy of Art; xiaochan321@163.com

<sup>2</sup> China Academy of Art; 502950699@qq.com

<sup>3</sup> China Academy of Art; jgt\_marsh@hotmail.com

\* Corresponding author: xiaochan321@163.com

## Abstract

Although research has been done showing that Longquan celadon porcelain is inevitable for China's ceramic culture in the history, lacking systematic research on how to identify the colour in a qualitative way. As an initial stage of a colour research project on Longquan celadon porcelain, this particular paper demonstrate the process of generating, classifying and analyzing the colour data, which is from 111 pieces of antique porcelain samples in South Song Dynasty. As a result, the colour samples show a constant and similar range of volume in LAB and RGB colour mode, which add to previous research in the filed of porcelain colour identity. Further research in this area is needed for a more complete methodology and techniques in colour measurement, data interpretation, and documentation.

**Keywords:** *Longquan celadon colour, porcelain colour analysis, colour identity*

## INTRODUCTION

Longquan celadon, as the world's intangible cultural heritage, is well-known for the trademarks and national geographical indication products in China. In addition to its unique soil, glazing method and firing process, colour is an indispensable element of celadon that has been developed since the Han Dynasty. The distinguish glaze demonstrates subtle green of the mountains and waters. Especially Fenqing and Meiziqing are the most representative colour for Longquan porcelain which is produced a thickly and milky layer and a jade-like texture.

However, in the existing literature, there is a lack of specific research on the colour of Longquan celadon. The dicription of colour is often inconsistent, and the characteristics of colour are ambiguous. This research thus aims to clarify the colour characteristics of Longquan celadon from a qualitative perspective. The study conducts a colour measurement of ancient Longquan porcelain samples and the color range reveals the unique color characteristics of Longquan celadon.

This research project is strongly supported by a local based company— Zhejiang Dongdu Cultural Creative Inc. and Longquan government that enable the research team to sustain the project and explore more possibilities for historical and cultural heritage protection and development.

## METHODS AND DATA ANALYSIS

The colour measurement of the first batch of ancient porcelain pieces was carried out, 111 pieces of ancient Southern Song Dynasty porcelain were selected (Figure 1), and the colour data were collected in three methods: colour measurement instrument, colour chart comparison, and photography, recording the color value and saturation in Lab and RGB colour mode. Through analysis, reliable 100 data are sorted out to form the celadon colour spectrum, which provides a colour range for establishing a colour standard.





Figure 1: 111 pieces of Longquan porcelain samples.

This experiment was conducted indoors and a total of 110 valid data were recorded. In the later data collation process, 100 sets of stable data were kept for analysis (14 suspicious and abnormal data were ignored) (Figure 2). Two colours of RGB and Lab are similar on the screen. The data analysis shows that most of the data shows stable and regular variables, the result can be summarized:

- RGB colour range: R: 100-149 G: 92-159 B: 67-160
- Lab colour range: L: 33.7-67.7 a: -8.9-8.3 b: 1.1-26.7

编号	标本照片-正面	测点颜色值-正面	标本照片-反面	测点颜色值-反面	年代	尺寸	测制方式	测制描述	测色值#1 (Lab)	测色值#1 (RGB)	测色值#2 (Lab)	测色值#2 (RGB)	测色值#3 (Lab)	测色值#3 (RGB)
O-S-0038		R: 101 G: 130 B: 123		R: 86 G: 111 B: 110	南宋	3727*	测制内缘外缘轴		L: 41.2 a: -9.6 b: 3.9	R: 91 G: 111 B: 100				
O-S-0048		R: 104 G: 129 B: 126		R: 112 G: 140 B: 143	南宋	5932*	测制内缘外缘轴		L: 49.6 a: -4.2 b: 3.9	R: 110 G: 122 B: 112				
O-S-0066		R: 114 G: 134 B: 132		R: 126 G: 146 B: 145	南宋	3736*	测制薄轴		L: 58 a: -6.6 b: 6.9	R: 131 G: 143 B: 129				
O-S-0067		R: 93 G: 116 B: 122		R: 85 G: 105 B: 109	南宋	4830*	测制薄轴		L: 50.8 a: -6.1 b: 1.9	R: 110 G: 122 B: 116				
O-S-0061		R: 93 G: 118 B: 122		R: 86 G: 124 B: 125	南宋	4034*	测制薄轴		L: 53.1 a: -6.3 b: 3.9	R: 114 G: 130 B: 119				
O-S-0083		R: 93 G: 101 B: 101		R: 93 G: 113 B: 112	南宋	3630*	测制薄轴		L: 54.3 a: -8 b: 6.4	R: 119 G: 120 B: 118				
O-S-0088		R: 111 G: 126 B: 123		R: 105 G: 125 B: 126	南宋	4035*	测制薄轴		L: 63.7 a: -4.6 b: 6.6	R: 149 G: 157 B: 142				
O-S-0087		R: 99 G: 123 B: 125		R: 117 G: 141 B: 145	南宋	6240*	测制上下缘轴		L: 59 a: -6.4 b: 3.1	R: 133 G: 146 B: 137				
O-S-0086		R: 82 G: 98 B: 95		R: 86 G: 108 B: 109	南宋	6149*	测制薄轴		L: 45.5 a: -5.3 b: 7.9	R: 104 G: 115 B: 95				
O-S-00101		R: 113 G: 135 B: 130		R: 108 G: 138 B: 137	南宋	6237*17	测制薄轴		L: 57.6 a: -5.4 b: 6.1	R: 135 G: 142 B: 126				
O-S-00103		R: 129 G: 160 B: 155		R: 121 G: 142 B: 137	南宋	6936*	测制薄轴		L: 63.5 a: -5.8 b: 4.6	R: 148 G: 158 B: 149				
O-S-00106		R: 109 G: 126 B: 120		R: 128 G: 142 B: 141	南宋	6737*25	测制薄轴		L: 59 a: -5.3 b: 6.7	R: 138 G: 144 B: 130				
O-S-00106		R: 122 G: 147 B: 144		R: 128 G: 153 B: 150	南宋	8043*	测制薄轴		L: 67.8 a: -6.4 b: 3.4	R: 153 G: 170 B: 160				
O-S-00107		R: 112 G: 134 B: 131		R: 128 G: 160 B: 147	南宋	7945*11	测制薄轴		L: 57.2 a: -6.3 b: 4.5	R: 128 G: 140 B: 128				
O-S-00108		R: 118 G: 139 B: 132		R: 143 G: 160 B: 152	南宋	7454*21	测制内缘外缘轴		L: 63.1 a: -5.8 b: 7.3	R: 145 G: 156 B: 140				

Figure 2: Partial data list.

## ***FINDINGS***

This research is based on 111 ancient Southern Song porcelain pieces with a systematic colour measurement. Two specific colour measurement methods are used. One is to use a colorimeter to measure representative colours and a large area of color on the exterior of the porcelain. The data obtained is the LAB colour system. The second is to use photography methods to photograph the porcelain in daylight, and then use Photoshop software to pick colours.

The two methods each recorded 111 sets of data, but after the comparison, it was found that extreme data was generated. That is, the data screening method was used to sort out 100 sets of reliable and credible data, which is convenient for later data comparison and analysis. In the process of analysis, the following two laws and phenomena were mainly highlighted, and the extension analysis is carried out here.

### 1. Celadon has a stable colour range

By examining the 100 sets of colour samples collected, no matter which method is used, it was found that its colour has a certain pattern. The value of the colour changes within a certain range.

### 2. Color difference caused by colour measurement methods

This research shows that the colour data measured by different colour measurement methods have systematic differences.

Colour measurement instrument: (1) The point selection of colour measurement may cause different descriptions of the same colour; (2) The colour measurement area may cause differences in the description colour (3) The difference in color measurement instruments may cause the colour difference.

Photography: (1) The light conditions of the shooting may cause the colour difference; (2) The photography settings may cause the colour difference; (3) The point of colour picking is the cause of the colour difference.

Comparing the difference between the two sets of data reveal the difference in value. Through the naked eye comparison, the photography may be closer to the original porcelain colour.

## ***DISCUSSION***

The research is to investigate the image shaping from the colour as the starting point, which is based on the important understanding of colour. Image analysis can start from many aspects, but the lack of in-depth research on the colour may miss the important visual clues. From the above point of view, chromatics is fundamentally related to image shaping and visual communication.

The establishment of the color perception is not only determined by professions, but also based on an in-depth understanding of visual meaning. Colour is not only a component of vision, but also a component of visual connotation. This research not only explains what colours are, but also explores why and how colours produce specific meanings. How can a kind of cyan produce a differentiated interpretation under different historical, social, and cultural environments? And why does it cause different levels and depths of understanding? These issues are breakthroughs and challenges to the inherent colour concepts and meanings. It will also provide a wider range of thinking and discussion in different aspects for the study of colour culture and visual culture.

The use of extensive visual materials to highlight changes and developments over a long period of time is another feature of this research. The addition of a century of time dimension to the research, boldly placing Longquan celadon and colour in a panoramic historical perspective, has become another innovative point of this research. This research can provide more detailed content and draw

more convincing conclusions. The image of celadon in each period cannot represent a consistent image, because the fact is that all visual images are dynamically changing, and only by presenting its development process in a complete way can it be possible to restore the full picture of history.

Partial analysis and research can only be an annotation of a certain historical period, and overall image research requires a broader research. In this sense, this research can expand the scope of colour time and space, use the axis of the century to connect the colour memories scattered in various historical stages, and try to weave into a magnificent picture drawn by the colour lineage of Longquan celadon that has never been achieved before.

## **CONCLUSION**

This research explores the colour pallet of celadon, and its essential problem is to answer how to restore a colour identity of Longquan celadon and become a acceptable image to the public. In such a long historical stage, how did the visual image and communication of Longquan celadon adapt to the needs of each historical stage, so as to achieve the ideal communication effect. This problem may still relevant to what role does colour play in the image-building process of Longquan celadon? How does colour help the visual image to achieve its development with the times? These key questions will become the leading clues throughout the research, and the answers can contribute to the research of color science and other related topics.

As a conclusion, this study clearly shows that the colour of celadon is in a certain colour range, which helps us to identify the colour of celadon. In the recognition of celadon, it can be identified from the most characteristic colours. On the other hand, in the process of making celadon, it is necessary to consider the characteristics of its colour, and to match and fire the glaze colour in the established colour range.

# The colors of feminine beauty between the middle Ages and the Renaissance

Lia Luzzatto <sup>1,\*</sup>

<sup>1</sup> Fondazione Accademia di Comunicazione Milano; Accademia del Lusso, Milano; Raffles Istituto Moda e design, Milano; luzzattolia@gmail.com

\* Corresponding author: luzzattolia@gmail.com

## Abstract

A research on the evolution of beauty standards in the feminine between the Italian Middle Ages and the Italian Renaissance, with particular attention to the colors that expressed them and that represented this historical period so full of social and cultural changes. It's been taken into consideration, with the cosmetic matters and dyehouses, the influence that culture and religion had on the way of appearing of women and men belonging to dominant classes, social and symbolic values and expressive codes. That is how the clothing's colors, the ones of makeup and hair were expression of moral, social and hygienic virtues, on how religion and philosophy have influenced their usage and have conditioned the aesthetic choices. It's not left out a mention of the wars and of the trade routes which have widespread pigments and trends and it's underlined how aesthetic, not in a very different way from today, was considered an integral part of medicine and of the physical well-being. The work underlines how, contrary to what people may think, the meeting between different civilizations and the "rising" bourgeois have been springs and have forged also through the person's colors the moral, the beauty and the poetry values.

**Keywords:** *Color, identity, beauty, history*

## INTRODUCTION

Even Neanderthal man applied colored pastes to his face, both to protect himself from insects and to appear more beautiful (Borellini 2015). The search for beauty has crossed the centuries, interweaving the concept of beauty and good, as if physical beauty was a guarantee of morality and value, by using cosmetic techniques, makeup and therefore also color.

On what did the choice of certain color gradations in a given historical moment depend? A question that this work tries to answer, starting from the assumption that the choices made are never random, but from time to time can represent the visual compendium of an era, its aesthetics, its ideological, cultural and social conditions, as well as economic and commercial, of course, all variables that contribute to determining and defining the concept of culture.

The research was based on visual evidence, on texts of philosophy, medicine and literature of the time, limited to the colors of beauty as it was meant in Italy in the historical period between the late Middle Ages and Humanism<sup>1</sup>, in other words, between the eleventh and fifteenth centuries, which was chosen as a 'cultural model' for the complexity of ideas, dispositions, actions and transformations, suitable to demonstrate how the color has represented and witnessed the way of perceiving the world and themselves in the society that inhabited it<sup>2</sup>.

## FROM THE 'ANGEL' TO THE 'EARTHLY' WOMAN

Among the many political and social transformations that took place starting from the year 1000 and culminated in Humanism - along with the newfound dominance of the Mediterranean and cultural and commercial exchanges, favored by the Crusades and the birth of a capitalist and wealthy bourgeoisie - there were numerous inventions that concerned not only the productive sphere but also the domestic

---

<sup>1</sup> Cultural movement that started in Italy around the second half of the XIV century and lasted throughout the XV century.

<sup>2</sup> <https://www.docsity.com/it/antropologia-culturale-harris-marvin/2373586/>

The colors of feminine beauty between the middle Ages and the Renaissance one, which included not only clothing but also self-care, to which also contributed the spread of soap, presumably introduced by the Arabs.

The aesthetical standards of both male and female beauty were strongly influenced by the Catholic Church that tried above all to repress in the female universe, both popular and noble, the desire for worldly beauty considered ephemeral and dangerous.

The religious culture indeed still accounted for the warnings of the Founding Fathers including the ones of San Cipriano and San Girolamo that warned young girls and their mothers.

Tascio Cecilio Cipriano (210-258), a Roman bishop, warned:

*It was the devil who first taught the use of coloring the eyebrows, putting on artificial colors, applying makeup on the cheekbones and even changing the color of the hair, changing with these evil deceptions the reality and appearance of the whole head and even the face (Anselmo 2020).*

And Sofronio Eusebio Girolamo (347-420) reiterated:

*Your daughter should not be accustomed to pronounce half-words; and to trifle in gold and purple, of which one harms the tongue, the other the customs (...) beware not to pierce her ears, and not to paint her face to Christ consecrated with white lead and blush, not to keep gold and gems around her neck, not to load her head with precious stones, not to make her hair red<sup>3</sup>.*

However, although the clergy stretched out an oppressive and despotic hand, women of the wealthy classes never gave up the pursuit of personal care and beauty and followed, as much as possible, the aesthetic guidelines of their time, which required large, round eyes, arched eyebrows, small mouths and fair skin. The crusaders brought back from the East the use of perfumes and cosmetics, which the church had strictly forbidden in the first centuries of Christianity, and female practices such as make-up.

The cosmetics of the late Middle Ages were nothing but the continuation of the Roman one and the palette of makeup provided, for the bravest, blue and green tones for the eyelids, black-smoke to blacken eyelashes and eyebrows, orangey-pink for the mouth and cheeks. For the colors were used clay powders of different types, diluted in water, the minium and saffron to color the cheeks and lips, sage to whiten teeth and the 'cerussa'<sup>4</sup> to whiten the skin.

"To apply make-up" was called "to paint" or "to smooth oneself", since the makeup was called "smooth" and the poet Ugucione da Lodi (XIII sec.) refers to this custom when in an ironic description of this custom he writes that the woman will look like an image when she will be "well painted" in white and red (Anselmo 2020).

Women dedicated themselves to a long cosmetics to lighten the face for which they used white lead, so as to confer it brightness and gentle candor, as in the words of the poet Guido Guinizzelli (1237-1276), considered the initiator of the Dolce Stil Novo:

*Face as white as snow, tinted with carmine, eyes bright cheerful, full of splendor (Contini 1995: 2-2 Dolce Stil Novo).*

And from those of Guido Cavalcanti (1258-1300), who presents the ideal woman as a shepherdess focusing on the color of her hair and cheeks:

*Beautiful more than a star, with blond and curly hair, eyes full of love and skin of rose (Cavalcanti, Rime in Contini 1960).*

The face was in fact brightened by the reddening of the cheeks and lips, a custom deprecated by Dante, when in the XV canto del Paradiso he shows his preference for the sober and modest woman (...) without a painted face, like Beatrice who in the Vita Nuova appears to him (1265-1321):

---

<sup>3</sup> L'epistole di Girolamo Sdrignese, scelte, e divise in tre libri. Per opera di Pietro Canisio teologo. In Venezia MDCLXXXV.

<sup>4</sup> Ceruse or white lead is a basic lead carbonate extracted from cerusite, a complex process already known in ancient Egypt.

The colors of feminine beauty between the middle Ages and the Renaissance

*Dressed in the noblest color, humble and honest, sanguine, girded and adorned in the manner that suits her very young age* (Alighieri 1932).

It may seem strange that the Supreme Poet in these verses refers to the color of Beatrice's robe as a 'noble, honest and humble' red, but it is no longer so if we take into consideration that the chromatic taste for strong and saturated tonalities met with the theological theme of the 'metaphysics of light', that current of thought, whose major exponent was the English theologian Roberto Grossatesta, who saw in the brightness of colors the 'Splendor', that is, the presence of the divine, as shown by the studies carried out by Renata Pompas and myself for the books '*I colori del vestire*' and '*Colori e Moda*' (Luzzatto and Pompas 2018).

This philosophical assumption is expressed in various forms, even affecting the taste for clothing. Thus the saturated and contrasting shades of clothing came to compete with the splendor of the stained-glass windows of Gothic cathedrals, which lit up on sunny days, allowing rays of colored light to penetrate the aisles. The purity of the glass material made it possible to experiment with a range of bright colors, with combinations of reds and light blues, greens and purples, blues and yellows<sup>5</sup>, the same tones that painting made shine when combined with the splendor of gold (Luzzatto and Pompas 2018). A theological message not written, but represented; a dense light, sustained by color and divine<sup>6</sup>.



Figure 1, 2: Ambrogio Lorenzetti, The Annunciation. Image source: Lorenzetti Ambrogio (1344), The Annunciation, Siena: National Gallery, Wikimedia Commons.

The ideal woman was described by the troubadours, called the poets of 'Amor Cortese', in the French territory and by the poets of the 'Dolce Stil Novo'<sup>7</sup> in the Italian territory, surrounded by a beauty that emanated spirituality, with a sensual but moderate body, long golden hair (blond) styled

<sup>5</sup> The term Splendor in the metaphysics of light indicates the splendor of terse objects made brilliant by the light of God.

<sup>6</sup> For more details: Michela Beatrice Ferri, <https://www.jerusalem-lospazioltre.it/la-luce-splendore-del-vero-percorsi-arte-architettura-teologia/>.

<sup>7</sup> The Dolce Stil Novo, also known as Stilnovismo, Stil novo or Stilnovo, is an important Italian poetic movement developed between 1280 and 1310.

The colors of feminine beauty between the middle Ages and the Renaissance in ringlets or braids, blue eyes and clear skin: in fact a celestial creature who radiated brightness and celebrated in her colors the theological myth of light radiating all things to which were attributed the qualities of the spirit in opposition to the darkness and opacity of sin<sup>8</sup>.

That of blond hair, possibly curly, was a slow revolution of taste brought to Italy by the barbarian invasions and already sung in the poems of Mary of France, the famous French poetess who around 1100 described in this way the ideal of female beauty, which was well suited to the representation of the inner light of the woman angel:

*Her body is well built, her hips narrow, her neck whiter than snow on a branch. Her eyes are grey-blue, her face very clear, her mouth pleasant and her nose regular. She has brown eyebrows, a wide forehead, curly and very blond hair (...) brighter than gold (Onelli 2020).*

To circumscribe the face with a halo of golden light were used lightening dyes with a variety of recipes handed down from generations or using those written by Trotula de' Ruggero, the famous physician of the prestigious school of Salerno, author of the medieval treaty on cosmetics *De Ornatu Mulierum*, that for the innovative ideas, for the skills and the popular esteem she had, was considered between the XII and XIV century, the highest authority in matters of health, hygiene and female beauty (De' Ruggiero 2014).

A blond color exalted again by Francesco Petrarca, considered the founder of Humanism, when in the *Canzoniere* (composed on several separate occasions between 1304 and 1374) he describes Laura at their first meeting, *with her golden hair scattered in the wind that wrapped it in a thousand sweet knots.*

*Erano i capei d'oro a l'aura sparsi/che 'n mille dolci nodi gli avolgea,/e 'l vago lume oltra misura ardea/di quei begli occhi, ch'or ne son sì scarsi (Petrarca 1964).*

Even Giovanni Boccaccio sings about this ideal of feminine beauty in the 'Decameron' (written between 1349 and 1353) describing Fiammetta with her frizzy, long, golden hair, her round face with bright white skin as lilies and cheeks and the mouth the color of roses.

*La fiammetta, li cui capelli eran crespi, lunghi e d'oro e sopra li candidi e dilicati omeri ricadenti e il viso rotondetto con un color vero di bianchi gigli e di vermiglie rose mescolati tutto splendido, con due occhi in testa che parean d'un falcon pellegrino e con una boccuccia piccolina li cui labri parevan due rubinetti (Boccaccio 2013).*

## **FROM THE LATE MIDDLE AGES TO HUMANISM**

While the Church consolidated its temporal rule and tried to maintain its spiritual one, the spread of culture, once assigned almost exclusively to the monastic orders, found different channels - from Academies, to artists' workshops, libraries, universities - and moved towards a more earthly dimension, people began to observe and study nature in its manifestations dictated by natural laws and to rediscover classical Greek and Latin literature. "The awakening of reason enriched man's awareness of his place in nature and the aesthetic canons that came from it, based on number and balance, gave life to an exceptional artistic proliferation (...) in painting the search for a luminosity radiating from the color itself was replaced by an external and grazing luminosity that softened and melted, through the thickness of the air, the combinations of different tints" (Luzzatto and Pompas 2018). The brilliance of the previous colors, enhanced by the proximity of gold began to fade, the skies became blue and the colors began to decline in what will be the typical humanistic-classical palette of

---

<sup>8</sup> A current of thought, whose greatest exponent was the English theologian Roberto Grossatesta who saw in light "the first form in the first created matter" perhaps inspired by the texts of Agostino who a few centuries earlier had spoken of God in terms of infinite and immaterial light, the source of all other created lights.



The colors of feminine beauty between the middle Ages and the Renaissance pinks, pastel greens, yellows, light blues, lactated whites and purples, modulated by intermediate shades combined with harmony.



Figure 3, 4: Botticelli, *Venus and the Three Graces Presenting Gifts to a Young Woman*. Image source: Botticelli Sandro (1483-1485), *Venus and the Three Graces Presenting Gifts to a Young Woman*, Firenze, Villa Lemmi, Wikimedia Commons, author: 2016, Sailko.

A chromatic change in art and clothing that we can admire in the frescoes and which, however, had little influence on the canons of female beauty that remained almost unchanged, except for a freer and more accentuated use of the colors of makeup: the forehead remained high and shaved, the eyebrows shaved and thin repassed with charcoal, the skin white, shiny and soft.

The only exception was the 'red hair' which, regardless of ecclesiastical reprimands, appeared again, turning the gold of the hair towards the coppery blonde typical of Venetian women.

Even in the XV century the woman, as suggested by Ludovico Ariosto (1474-1533), to be beautiful had to have the colors of Fairy Alcina: *blond hair and shiny as gold, rosy cheeks and mouth. The forehead, teeth, neck and chest white as milk.*

*Con bionda chioma lunga et annodata:/oro non è che più risplenda e lustrì./Spargeasi per la guancia delicata/misto color di rose e di ligustri;/di terso avorio era la fronte lieta,/che lo spazio finia con giusta meta./Sotto quel sta, quasi fra due vallette,la bocca sparsa di natio cinabro;/quivi due filze son di perle elette,/che chiude et apre un bello e dolce labro:/Bianca nieve è il bel collo,/(...) e 'l petto latte (Ariosto 2012).*

The pink veil on the cheeks, however, became a little more accentuated as that on the mouth, often the upper eyelids were outlined with black and shading of the eyes was a custom. Thus in a novel by Franco Sacchetti (1332/1400) we can read that: *“the Florentine women are the best painters in the world, who know how to transform every figure from diabolical to angelic and know how to make ugly faces beautiful in a wonderful way.”*

*Le donne fiorentine con loro sottigliezza sono i migliori dipintori del mondo, e ancora quelle che ogni figura diabolica fanno diventare angelica, e visi contraffatti e torti maravigliosamente dirizzare (Sacchetti 1970).*

A conquered freedom, use of color that, freed from the Splendor, underlined the new conscience that was being formed, to which the woman also adhered with more independent participation in culture and art: an active woman dedicated to moral virtues but also to worldly ones.



## **CONCLUSION**

The analysis of the changes that took place between the late Middle Ages and Humanism shows how the choice and the taste for chromatic tonalities and their combinations accompanied the evolution of social customs and how the color of beauty and costume can be considered, like others, a visual document in which to read the philosophical, economic and social changes of the era that expressed them. So, returning to the initial question, we can say that the chromatic choices are not casual, but that they are produced and manifested as a consequence of the events of the society to which they belong.

## **REFERENCES**

- AA.VV. 1992. *Con gli occhi di Piero. Abiti e gioielli nelle opera di Piero della Francesca*. Venezia: Marsilio.
- AA.VV. a cura di J. Le Goff (Ed.) 1993. Bari: Laterza.
- Anselmo, S. 2020. *Storia del trucco e dei cosmetici, dall'antichità all'Ottocento*. Milano: LSWR.
- Alighieri, D. (Barbi, M. Ed.) 1932. *Vita Nuova*. Firenze: Bemporad. LiberLiber, accessed 2021. <https://www.liberliber.it>.
- Ariosto, L. 2012. *Orlando Furioso*. Milano: BUR Biblioteca Universale Rizzoli.
- Barasch, M. 1992. *Luce e colore nella storia artistica del Rinascimento*. Genova: Marietti.
- Barni, G. and G. Fasoli. 1961. *l'Italia dell'Alto Medioevo*. Torino: UTET.
- Boccaccio, G. 2013. *Il Decamerone*. Milano: BUR.
- Borellini, U. 2015. *La divina cosmesi. La bellezza e la moderna cosmetologia*. Milano: Mondadori Electa S.p.A.
- Brunello, F. 1968. *L'arte della tintura nella storia dell'umanità*. Vicenza: Neri Pozza.
- Cardini, F. 1981. *Alle radici della cavalleria medievale*. Scandicci: La Nuova Italia.
- Cavalcanti, G. 2011. *Rime*. Roma: Carrocci.
- Contini, G. (Ed.) 1995. *Poeti del Duecento, 1*. Milano: Classici Ricciardi Mondadori.
- Contini, G. 1960. *Poeti del Duecento, 2*. Milano, Napoli: Riccardo Ricciardi. LiberLiber, accessed 2021. <https://www.liberliber.it>.
- De' Ruggiero, T. 2020. *L'armonia delle donne. Trattato medievale di cosmesi con consigli pratici sul trucco e la cura del corpo*. Lecce: Piero Manni.
- Levi Pisetzkzy, R. 1900. *Storia del costume in Italia*. Milano: Istituto Editoriale Italiano.
- Luzzatto, L., and R. Pompas. 2018. *Colori e moda*. Milano: Bompiani.
- Onelli, A. M. 2020. *AforiSmart. L'Amore e la Bellezza*. Youcanprint.
- Petrarca, F. (Contini, G. Ed.) 1964. *Il Canzoniere*. Torino: Einaudi. LiberLiber, accessed 2021. <https://www.liberliber.it>.
- Piccolomini, A. 2001. *La Raffaella, ovvero Dialogo della bella creanza delle donne*. Roma: Salerno. Von Eschenbach.
- Sacchetti, F. (Faccioli, E. Ed.) 1970. *Il Trecento novelle*. Torino: Einaudi. LiberLiber, accessed 2021. <https://www.liberliber.it>.
- Sanudo, M. 1989. *Le vite dei Dogi*. Padova: Antenore.
- Von Eschenbach, W. 1993. *Parzival* Torino: Einaudi.

# Chagall e Malevič: colors of the imagination and colors of the absolute

Renata Pompas <sup>1,\*</sup>

<sup>1</sup> Accademia del Lusso, Milano (Italy); renata.pompas@gmail.com

\* Corresponding author: renata.pompas@gmail.com

## Abstract

I have had the opportunity, at different times, to visit the art works of Marc Chagall and Kazimir Malevič, in important European exhibitions and museums,<sup>1</sup> and have recently read the autobiographical memoirs of both, beside seeing the beautiful feature film by Alexander Mitta.<sup>2</sup>

Neither Chagall nor Malevič were Russian-speaking, and their upbringing was a mixture of Eastern Jewish background of one, and Polish cultural background of the other, with the popular peasant tradition of late 19th century villages, although the former due to social proximity and the latter to emotional proximity. Both had a religious upbringing which is reflected in the biblical references in many of their works and, as we shall see, both had as purpose of their art and teaching the renewal of painting and opposition to academicism, which they would express by placing color at the centre of their interests. They participated in the outbreak of the Russian Revolution, sharing in its ideals, and initially playing important cultural roles in art and teaching.

I will present the years around the second decade of the 20<sup>th</sup> century, when Marc Chagall and Kazimir Malevič were teaching in Vitebsk at the *Popular School of Art* founded by Chagall and comparing their theories on art and teaching,<sup>3</sup> from which emerge two opposing conceptions of art and color, for each a central feature of their own artistic expression, in the name of spirituality and Revolution, which led to a dramatic falling out between them.

**Keywords:** *Color, art, theories, disputes*

## THE HISTORICAL CONTEXT

From the beginning of the 20th century, great turmoil was sweeping across Europe and Russia, where political and social upheaval had an interesting impact on art and education.

During this turbulent period in Russian art schools, different positions on art education were at odds: on the one hand there were the “traditionalists” devoted to a conventional, conformist art and/or national folklore, and on the other hand there were the “modernist movements” that turned their eyes to what was happening in Europe where the great political, intellectual and artistic turmoil of the time found a cultural epicenter especially in France with the historical avant-garde, and in Germany with the establishment of the Bauhaus, and where academics and anti-academics challenged and fought each other with great scandal and clamor.

---

<sup>1</sup> *Musée national Marc Chagall*, Nice (France). *Marc Chagall*, Fondation Maeght, Saint-Paul de Vence (France). *Kazimir Malevič una retrospettiva*, GAMeC- Galleria d'Arte Moderna e Contemporanea, Bergamo (Italia).

<sup>2</sup> Marc Chagall, *La mia vita*. SE, Milano, 1998. Kazimir Malevič, *Scritti*. Mimesis Edizioni, Milano (Italia), 2013.

<sup>3</sup> Martinovich su Lampe, Chagall, Lissitzky, Malevich: The Russian Avant-garde in Vitebsk, 1918-1922. In: <https://networks.h-net.org/node/166842/reviews/3811016/martinovich-lampe-chagall-lissitzky-malevich-russian-avant-garde>.



Marc Chagall, *The Birthday*, 1915.

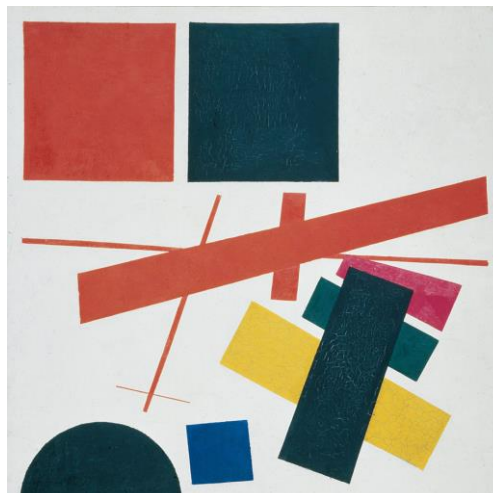

Kasimir Malevič, *Suprematism. Non-objective*, 1915.

### **ART EDUCATION IN RUSSIA**

In Russia, the most important and traditional Academies of Fine Arts were located in Moscow and in St. Petersburg, but an interesting role was played by the school founded in 1918 by Marc Chagall in Vitebsk, his hometown, where he invited to teach, among others, Kasimir Malevič, on whom this work focuses. It was a revolutionary school that overturned the aesthetic canons of the 19th century, seeking the new in all its expressions, to the point of feeling the need to manifest art in the social and economic revolution.<sup>4</sup>

Initially both Chagall and Malevič showed an interest in the rural world and esoteric currents such as Rosicrucian Freemasonry, Theosophy and Anthroposophy,<sup>5</sup> hence their interest and activity turned to the creation of a new revolutionary language, which both expressed through color.

### **MARC CHAGALL: THE COLORS OF REALITY AND IMAGINATION<sup>6</sup>**

Marc Chagall was born in 1887 in the poor Jewish quarter of the peasant village of Vitebsk (now in Belarus), characterized by the typical colored wooden houses that would recur in all his paintings. He spent the first eighteen years of his life there with his modest family, strictly observant of the Chassidic religion and of traditional customs. In 1905, at the age of eighteen, he went to St. Petersburg (a city where Jews were allowed to enter only with special permission) to study at the Academy of Fine Arts, where he encountered Léon Bakst, a cosmopolitan artist who designed the costumes and sets for the *Ballets Russes* and was a bridge towards the Parisian avant-garde. Chagall writes:

*Something in his art remained foreign to me. The fault was perhaps not his own, but that of the artistic society "The World of Art" of which he was a member and where stylization, aestheticism, all sorts of worldly stylistic devices and mannerisms flourished. (...) All discoveries, gimmicks and 'novelties' were filtered and polished to obtain a worldly, graceful and sparkling style.<sup>7</sup>*

In 1911, he decided to go to Paris, where, despite living amidst hardships that bordered on starvation, he was able to paint and learn about the effervescent transformation of languages carried

<sup>4</sup> Chagall, Lissitzky, Malevich: *The Russian Avant-Garde in Vitebsk, 1918-1922*. In: [www.studiointernational.com/index.php/chagall-lissitzky-malevich-the-russian-avant-garde-in-vitebsk-1918-1922-review-jewish-museum](http://www.studiointernational.com/index.php/chagall-lissitzky-malevich-the-russian-avant-garde-in-vitebsk-1918-1922-review-jewish-museum)

<sup>5</sup> Angela Dioletta, *Sentimento religioso e struttura confessionale nella Russia pre-sovietica*.

<sup>6</sup> Renata Pompas, *Marc Chagall: i colori della felicità*. <https://www.karmanews.it/4392/il-colore-della-felicit/>

<sup>7</sup> Renata Pompas, *Marc Chagall: i colori della felicità*. <https://www.karmanews.it/4392/il-colore-della-felicit/>

out in those years by hundreds of artists from all over the world. He visited the Salon des Indépendants, the Louvre and the Art Galleries and wrote:

*Down with naturalism, impressionism and realist cubism! (...) Personally, I don't think the scientific trend is a good thing for art. (...) Art seems to me to be above all a state of mind.*<sup>8</sup>

He stayed abroad for four years, including a brief stop in Berlin, returned to Russia in St Petersburg and at the outbreak of the First World War he went back to Vitebsk. When the October Revolution broke out in 1919, he was summoned by the government and appointed "Commissioner for Fine Arts" for the entire region and founded the *People's School of Art*. The characteristic of this atypical school is that it is:

*Open to all without class distinctions, without age limits, without a mandatory course curriculum and free of charge.*

Its didactic system was based on the abolition of an artistic hierarchy of expression and the equality of all contemporary movements. From the very beginning, when he and his students, to celebrate the first anniversary of the revolution, decorated the streets of the village with large colorful posters in which they reproduced his whirling animals in impossible spaces of pure color, relations with the communist leadership did not look easy: "why is the cow green and why is the horse flying in the sky? What is the relationship with Marx and Lenin?", asks the military commissar, a nineteen-year-old teenager.

In his openness to all anti-academic expressions, he invited El Lissitzky (1890-1941) to teach architecture and visual arts and Kazimir Severinovič Malevič (1879-1935) to teach painting. In this way he unknowingly decreed his own end: in fact, El Lissitzky adhered to Malevič's supremacist theories and together they founded a patriotic association of students and professors to support the Revolution, which would oppose Chagall's vision.

Chagall believed in the truth of art, and painted the emotion of his own memories and experiences: the community of the village of Vitebsk, with men and animals living in communion and harmony; an image in which memory is transfigured into a dream by fauve and unrealistic colors, reinforced by complementary counterpoints. He creates a hymn to love and joie de vivre, making bodies rise in the air and coloring the countryside, the characters, the animals, the houses, the Synagogue and the numerous Jewish religious symbols, seasoned with his trademark sense of humor and blended with a mystical-esoteric inclination. He wrote:

*You may be wondering why I painted flying goats and fish, green-faced violinists perched on rooftops, houses floating upside down in the sky, lovers flying over the city... I have painted my world, my life, what I have seen and what I have dreamed, I have painted my Russia and my Vitebsk where I was born, the neighborhood of poor Jews where I grew up, as I saw it when I was still a child.*

Works that create a free, sincere, uninterrupted, sentimental, dreamlike narrative, whose colors are exuberant and joyful, juxtaposed in an affectionate embrace, because:

*All colors are the friends of their neighbours and the lovers of their opposites.*

Chagall is committed to the socialist reconstruction of society, which in his teaching takes the form of teaching his pupils freedom and authenticity of expression, in opposition to the claim of a "revolutionary" style as advocated by Malevič in the next room, which he experiences as new academicism.

---

<sup>8</sup> Marc Chagall, *op.cit.*

### **KAZIMIR MALEVIČ: THE COLORS OF NON-REALITY AND THE ABSOLUTE<sup>9</sup>**

Kazimir Malevič was born in Kiev (now Ukraine) in 1879 to well-off, noble Catholic parents and spent much time among the peasants and in the countryside around the estate, fascinated by peasant culture in its artistic and spiritual expressions.

In 1906, at the age of 27, he moved to Moscow where he studied at the Academy of Fine Arts.

He became interested in Oriental philosophies, yoga, esoteric doctrines and theosophy; he took part in avant-garde exhibitions, developing a painting style that was somewhere between Cubism and Futurism. In those years, in Moscow, the scientist and presbyter Pavel Aleksandrovič Florenskij (1882-1937) held a series of lectures and conferences on the philosophy of the icon. I have found no documentation of direct contacts, but what is certain is that in the development of his conception of art, Malevič arrived at the abstract and radical two-dimensionality of pure color with an attitude of interpretation of the role of art as a spiritual and political vocation.

A drastic and definitive turning point in his artistic activity occurred in 1915 in the staging of the play *Victory over the Sun* – were the sun representing conformism and sentimentalism to be opposed - won by a black square from which he made all other forms derive by rotation and distortion, a work that is celebrated today as “the degree zero of figurative painting”.

When Malevič arrived at the Vitebsk School in 1919 he had already founded *Suprematism* with the poet Majakovsky, which amounted to utterly obliterating figuration for pure abstraction; his words, his painting and his teaching were absolute, definitive and radical:

*Suprematism has come to the object-less to build a new world of spirit and praxis. We can and should create a formidable history of this because it contains within itself the development of the New Testament of the world.*

For Malevič, Suprematism (1913-1918) is divided into different stages: the black period, the colored period, and the white period [in which]: black is a sign of economy, red a sign of revolution, and white pure action.<sup>10</sup>

Belonging to the “black period” is the path that generates new forms from the static nature of the square, thus adding dynamism. The dynamic and polycentric works belong to the “Colored Period. In these works, Malevič imagines that the square has exploded and scattered throughout the world, in a white space that represents a new world where there is no longer any force of gravity, no more top and bottom, no more right and left, and where colors create energy fields between free forms and he states:

*Painting is color, hue, it is embedded in our organism. Its flushes are great and demanding. They color my nervous system. (...) A colored plane is a real living form. Suprematism is the semaphore of color in its infinite abyss.*

The “White Period” represents with the colorless monochrome the infinity that detaches itself from earthly materiality towards new values of spirituality. He writes :

*I won the colored envelope of the sky. I tore it and in the bag that formed I put the color and tied a knot. Sail! The white free abyss, the infinite, are before us.*

As Bartolomeo D’Emilio has written, the “Nothingness” of his Suprematist paintings was also influenced by the mystical-esoteric currents and philosophical concepts of Florensky, who opposed the Western naturalist tradition and its system of perspective with the frontality of Byzantine icons,

<sup>9</sup> Renata Pompas, *Kazimir Malevič: il colore suprematista*. <https://www.karmanews.it/10252/kazimir-malevic-il-colore-suprematista/>

<sup>10</sup> Bartolomeo D’Emilio, *Kazimir Severinovič Malevič, Appunti di Storia dell’arte contemporanea*. [www.doccity.com/it/kazimir-severinovic-malevic/4522829/](http://www.doccity.com/it/kazimir-severinovic-malevic/4522829/); [www.abafg.it/wp-content/uploads/2011/2012/2012/01/PARTE-2-Malevic.pdf](http://www.abafg.it/wp-content/uploads/2011/2012/2012/01/PARTE-2-Malevic.pdf)

Chagall e Malevič: colors of the imagination and colors of the absolute highlighting the difference between two ways of seeing reality: on the one hand, the existing, the everyday and the visual, and on the other - in the icon - the invisible and the vision, something that constitutes the other of the visible, its beyond.<sup>11</sup>

And *Malevič* was the painter who created the new icons, of pure color, for the 20th century.

## **CONCLUSIONS**

The group of Suprematist teachers and students - taking advantage of Chagall's absence, who had gone to Moscow to obtain funds for the school - decreed his immediate expulsion. Chagall, who was to leave Russia for good, wrote in his memoirs:

*Neither Imperial Russia nor Soviet Russia needs me. I am incomprehensibly a foreigner to them.*<sup>12</sup>

In the evolution of the paths of the two artists, I have compared works and theories, conceptions of art and didactics that have led to an irreconcilable conflict. Yet both were enthusiastic supporters of political change, of the socialist ideal and of the Soviet revolution; both had an education with many points in common; both devoted themselves with a sincere impetus to contributing to artistic renewal; finally, both were disappointed by later developments that saw Chagall move to Paris and Malevič be disowned and obliterated.

Two visions animated by the same patriotic, idealistic, mystical and revolutionary spirit in which color was the primary subject of expression, which failed to find a point of contact.

---

<sup>11</sup> Bartolomeo D'Emilio, *op. cit.*

<sup>12</sup> Marc Chagall, *op.cit.*



# Synonymy in the Language of Colour

Dimitris Mylonas <sup>1,\*</sup>, Alexandros Koliouisis <sup>1</sup> and Mari Uusküla <sup>2</sup>

<sup>1</sup> New College of the Humanities, Northeastern University, UK; dimitris.mylonas@nchlondon.ac.uk, alexandros.koliouisis@nchlondon.ac.uk

<sup>2</sup> School of Humanities, Tallinn University, Estonia; muuskyla@tlu.ee

\* Corresponding author: dimitris.mylonas@nchlondon.ac.uk

## Abstract

We explore synonyms in colour naming within and across three languages, British English, Estonian and Greek, using data collected from a crowdsourcing experiment. We identified 30 common lexical colour categories in British English, 41 in Estonian and 29 in Greek, where no one category was fully contained within others. The synonymy analysis within languages revealed that the highest degree of overlapness was found for a pair of dark reddish loanwords in English (maroon and burgundy) and in Greek (*bissini* and *bornto*) that were absent in Estonian. The synonymy of two purplish categories in Estonian (*lilla* and *tumelilla*) and Greek (*mov* and *lila*) was also prominent but in English purple and lilac were more separated. The investigation of synonymy across languages revealed similar graph properties for all pairs of languages (British English – Estonian; Estonian – Greek; Greek – British English). Our results suggest that the degree of synonymy in the language of colour is influenced by cross-cultural transfer of loan words.

**Keywords:** colour, naming, synonyms, loanwords, cross-cultural

## INTRODUCTION

In natural language, a colour can often be named by two or more synonymous words. Synonyms that share exactly the same colour category are exceptionally rare but near synonyms, with an extent of overlapping colours, are numerous. From an onomasiological perspective, when a large, well-established colour category (e.g., red), contains a smaller colour category (e.g., crimson), the two colour names are considered synonyms. But from a semasiological perspective, their relation would be that of hyponymy, because the crimson is a sub-category or hyponym of red, whereas red contains crimson hues and is therefore a hypernym of crimson (MacLaury 1997). Therefore, the standard synonymy test of substitution, where one word can be replaced by another word without changing its meaning, is not appropriate for colour naming: we can say that crimson is a kind of red, but we cannot say that red is a kind of crimson

The problem of finding synonyms is even more complicated when we consider languages with a different number of colour categories and their corresponding basic colour terms. For example, Greek and Italian both contain at least 12 basic colour terms (Athanasopoulos 2009; Uusküla 2014). But in English, as a counterexample, Mylonas and MacDonald (2016) suggested the augmentation of the English inventory from the 11 basic colour terms (Sturges and Whitfield 1995) to 13 terms, adding lilac and turquoise. The underlying processes for developing colour naming systems remain unsettled, with no consensus as to whether lexical colour categories are formed under the influence of perceptual mechanisms (Berlin and Kay 1969/1991) or cultural communication needs (Davidoff 2015).

In this study, we focus on quantifying the degree of near synonymy between colour names from a semasiological perspective for a set of three colour languages. Our synonymy methodology comprises two steps: (i) map common colour names to distinguishable colour categories, where no one category is fully contained within others; and (ii) identify overlapping categories in colour space as synonyms in name space, thus quantifying the degree of near synonymy.



## **METHODS**

### **Data Collection**

A crowdsourcing colour naming experiment (<https://colournaming.com>) was designed to collect unconstrained names for 600 in total samples from the Munsell Renotation Data set, including eleven achromatic samples (Mylonas and MacDonald 2010). Participation was voluntary and anonymous. Colour stimuli subtending a visual angle of about 3 degrees at a viewing distance of about 50cm were presented sequentially against a mid-neutral background with a black outline of 1 pixel in random order. Typed responses along with the typing onset delay were recorded. Each participant was free to use any colour descriptor, either a single word, or a compound, or term(s) with modifiers or qualifiers. All participants were screened for possible colour vision deficiencies with a web-based Dynamic Colour Vision Test (Barbur 2004).

In this study, we consider 10,000 raw responses from 500 British English (EN), 10,000 responses from 333 Estonian (EE) and 10,000 responses for 532 Greek (GR) participants. We exclude disruptive observers offering incomplete, numerical and responses written in languages other than the language of the instructions, and observers with possible colour deficiencies (EN: 9.6%, EE: 2.8%, GR: 18.7%). Typographic conventions were replaced with spaces, leading and trailing spaces were removed, and all multi-character spaces were reduced to single spaces. Capitalisation was ignored. Common spelling errors (e.g., 'fusia' instead of 'fuchsia') were corrected with supervision. To measure the synonymy of colour terms we restrict our analysis to single word colour names which were produced at least 10 times in our data to give us confidence in their distribution. This filtering resulted in a dataset comprising 443 English, 276 Estonian and 343 Greek speaking respondents with a mean age of 32 (SD=12), 41 (SD=11), 31 (SD=9) years, respectively.

English and Greek are both Indo-European languages, belonging to different branches of that language family. However, Estonian is a Finno-Ugric language and its word-formation rules are different from English and Greek. For example, English and Greek both contain more object-derived colour names (Athanasopoulos 2009; Mylonas and MacDonald 2016) and therefore translating between English and Estonian can sometimes cause confusion (Uusküla 2019). There are also orthographic differences: in English and Greek modifiers are separated by a space but in Estonian, modifiers are used as compound names. Due to rich word-formation in Estonian, Estonian subjects tended to offer more colour terms per subject. This is a common feature of all Finno-Ugric languages in which colour naming has been studied (Uusküla et al. 2012).

### **Data Modelling**

We establish common colour names in each language that are reliably distinguishable from other names in colour space using a probabilistic model based on Maximum a Posteriori (MAP) (Mylonas and MacDonald 2016). More than one colour names may be offered for a colour, but the MAP model favours a colour name with the highest frequency among observers to maintain congruence between observed and predicted data. So, colour names that correspond to larger and more consistent colour categories tend to subsume smaller and inconsistent sub-categories.

To identify synonyms for colour names, the first relationship we explore is the conditional probability  $P(C/n)$  that describes the likelihood of a given colour stimulus  $C$ , being referred to by each distinguishable colour name,  $n$ . We can then express the degree of near synonymy between colour names as the amount of overlap between pairs of probability distributions using the Hellinger distance ( $H$ ). Hellinger distance is symmetric and obeys the triangle inequality.

The metric space defined by Hellinger distance borrows itself to a network view. We can view the colour naming space of a given language as an undirected weighted graph where nodes are centroids of colour names in CIELAB; and the weighted edge between two colour names is their Hellinger distance. Our network view enables us to analyse the colour naming space both within and across languages. Within a language, we can use measures of centrality (e.g., degree and closeness) to rank nodes and identify key infrastructure nodes. For example, closeness centrality (Bavelas 1950) allows us to identify a subset of colours that are closer to all other colours. Across languages, we can use graph edit distance measures to identify how similar two graphs are. In this work, we focus primarily on node edit distance, defined as the distance between two synonyms across languages in CIELAB

## RESULTS AND DISCUSSION

### Synonymy within languages

Using the MAP procedure, we identify 30 distinguishable lexical colour categories in English, 41 in Estonian and 29 in Greek. Our results agree with previous estimates on the number of 30-50 distinct colour names, as identified by native speakers, that fit within colour space (Chapanis 1965; Derefeldt and Swartling 1995; Griffin and Mylonas 2019). The larger number of Estonian common colour names reflects that Estonian speakers use modifiers as compounds in single word forms. Figure 1 shows these common colour terms in English, Estonian and Greek as graph networks. Synonyms with each language are connected with lines and the width of each line corresponds to their degree of synonymy. In British English, the strongest degree of synonymy was found between maroon and burgundy (Hellinger distance,  $H=0.6$ ), followed by peach and salmon ( $H=0.5$ ) and cyan and turquoise ( $H=0.5$ ). Both maroon (*marron*) and burgundy are loan words from French and Latin describing a dark reddish colour region. French is also the origin of peach (*pêche*) and salmon (*saumon*) referring to pale orange-pinkish colours. Cyan (*kyano*), originating from Greek, and turquoise (*turquois*), originating from French meaning Turkish, both refer to greenish-blue colours. The degree of synonymy between lilac and purple is considerable smaller in British English than in Estonian and Greek supporting the candidacy of lilac as a basic colour term (Mylonas and MacDonald 2016).

In Estonian, *hallikassinine* (bluish grey) and *sinakashall* (greyish blue) terms were the strongest synonyms ( $H=0.6$ ), followed by *sinepikollane* (mustard yellow) and *rohekaskollane* (greenish yellow,  $H=0.5$ ) and *lilla* (purple) and *tumelilla* (dark purple,  $H=0.5$ ). The synonymity between *hallikassinine* and *sinakashall* is predictable given that are compounds of the same words in different order. However, given that the two colour terms refer to different areas in colour space – one to grey and the other one to blue – these are not full synonyms. *Sinepikollane* and *rohekaskollane* both refer to the same base colour: yellow. However, *sinepikollane* has a slightly brownish overtone and *rohekaskollane* refer to a greenish yellow colour. *Lilla* and *tumelilla* both belong to the same colour category: purple. *Tumelilla* (dark purple) is a specification of *lilla* (purple), because you can use the modifier *tume* (dark) to specify the type of purple.

Similar to English, in Greek, the closest synonyms were a pair of dark reddish colours named as *bissini* and *bornto* ( $H=0.7$ ), followed by two whitish terms *aspro* and *lefko* ( $H=0.6$ ) and two purplish terms *lila* and *mov* ( $H=0.5$ ). *Bissini* ( $\beta\acute{\upsilon}\sigma\sigma\omicron\varsigma$ ) comes from ancient Greek while *bornto* (*bordeaux*) is a loan word for wine red from French. *Lefko* is an ancient Greek word that is used more often to describe whitish objects with some specular component (e.g., hair) while *aspro* is a more general term that comes from Latin. *Mov* (mauve) comes from French while *lila* from Turkish.

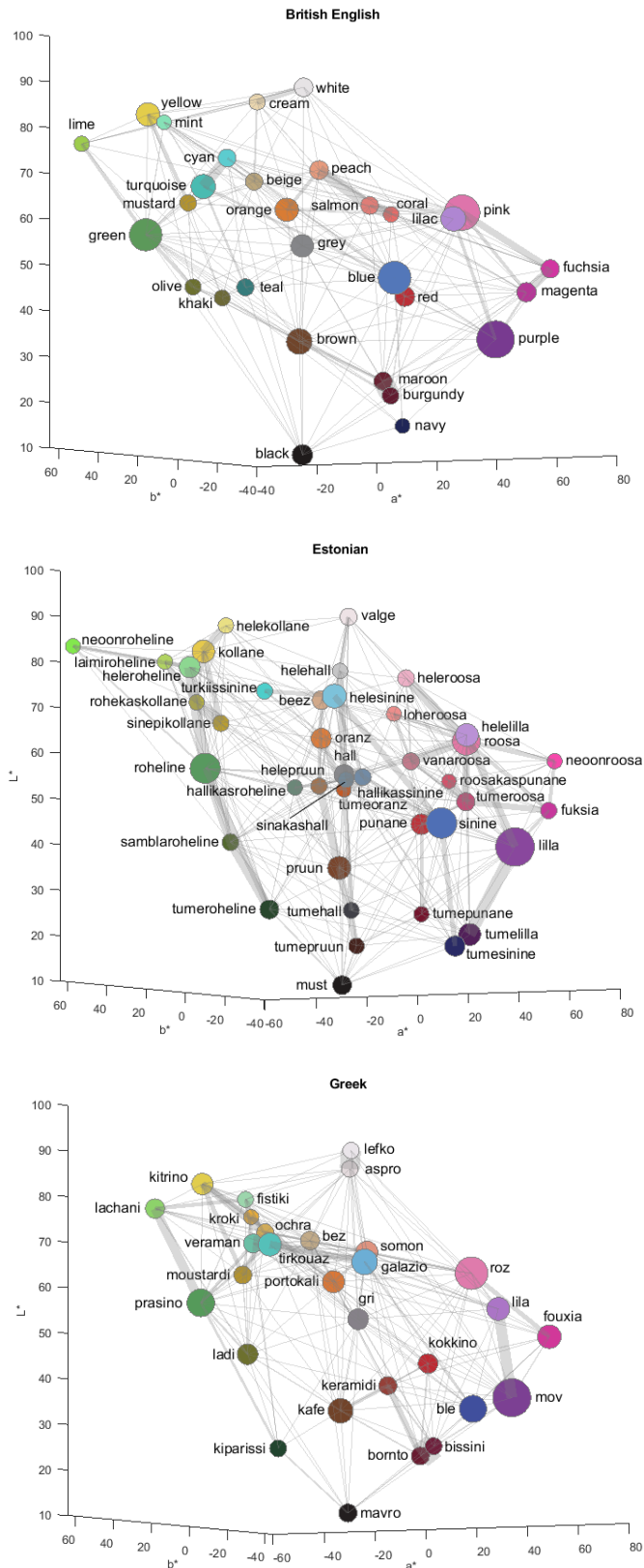

Figure 1: Common colour names in British English (top,  $n=30$ ), Estonian (middle,  $n=41$ ) and Greek (bottom,  $n=29$ ) in CIELAB. The colour and location of the discs corresponds to the coordinates of the centroids of the colour categories. The size of the discs corresponds to their frequency in the online experiment. The grey lines between the discs link colour categories that share common colour samples. The width of the lines indicates the degree of overlapness between pairs of colour categories.

In terms of closeness centrality within languages, greyish categories were ranked first in British English (grey; 0.88) and in Estonian (*hall*; 0.83) while in Greek was ranked 3rd (*gri*, 0.82) because of their central position in colour space, they were closer to all other nodes. The greenish categories were also found at the top of the ranks (green-EN: 0.83; *roheline*-EE: 0.75; *prasino*-GR: 0.78): because of their relative larger volume in colour space. An interesting finding was that beige-ish categories were found at the top of the ranks too (*bez*-GR: 0.91; beige-EN:0.72; *beez*-EE: 0.68) due to the large number of colour names (e.g., peach, salmon, cream) offered to name this region.

### Synonymy across languages

Using the same procedure of measuring the overlapness between pairs of categories we were able to determine the similarity between pairs of graphs of each language (British English – Estonian; Estonian – Greek; Greek – British English). The average degree of synonymy between British English and Estonian was  $H=0.21$  ( $SD=0.19$ ), while against Greek was  $H=0.19$  ( $SD=0.2$ ). The mean synonymy between Estonian and Greek was  $H=0.19$  ( $SD=0.16$ ).

In terms of node edit distance defined as the mean CIEDE 2000 colour difference between synonyms across languages, the British English language of colour is closer to Greek ( $DE00=5.01$ ,  $SD=5.25$ ) than to Estonian ( $DE00=5.65$ ,  $SD=4.81$ ) while the Estonian is closer to Greek than to British English ( $DE00=5.23$ ,  $SD=3.45$ ). Yet the differences are small and not significant indicating that our three languages have similar graph properties.

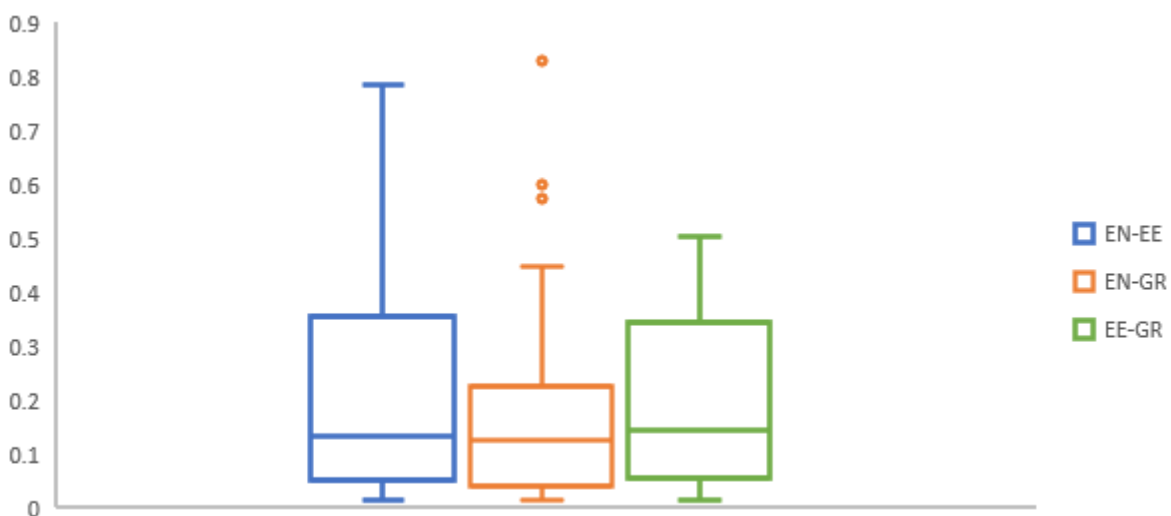

Figure 2: Degree of synonymy across pairs of languages, left: British English-Estonian, middle: British English-Greek, right: Estonian-Greek.

### CONCLUSIONS

In summary, the referential meaning of colour names can be mapped on colour space where we can determine the degree of synonymy between colour names based on the overlapness of their corresponding categories. Our investigation of colour synonymy using colour naming data in British English, Estonian and Greek from a crowdsourcing experiment revealed that synonymy within a language of colour is stronger when loanwords for object colours are introduced in their colour lexicons. In contrast, the analysis of synonymy across languages showed consistent variability with similar graph properties for all pairs of languages. On the whole, our findings suggest that synonymy in the language of colour is modulated by cross-cultural transfer of object colours.

**ACKNOWLEDGEMENTS**

We thank all volunteers who have contributed to this study as participants in the online experiment. Dimitis Mylonas and Alexandros Koliouisis were supported by a TIER 1 Seed Grant from Northeastern University. Mari Uusküla is thankful to Tuuli Järmut for help in data collection.

**REFERENCES**

- Athanasopoulos, P. 2009. Cognitive Representation of Colour in Bilinguals: The Case of Greek Blues. *Bilingualism: Language and Cognition* 12 (01): 83-95. <https://doi.org/10.1017/S136672890800388X>.
- Barbur, J. L. 2004. Double-Blindsight Revealed through the Processing of Color and Luminance Contrast Defined Motion Signals. *Progress in Brain Research* 144: 243–59. [https://doi.org/10.1016/S0079-6123\(03\)14417-2](https://doi.org/10.1016/S0079-6123(03)14417-2).
- Bavelas, A. 1950. Communication Patterns in Task-Oriented Groups. *The Journal of the Acoustical Society of America* 22 (6): 725-30. <https://doi.org/10.1121/1.1906679>.
- Berlin, B., and P. Kay. 1969/1991. *Basic Color Terms: Their Universality and Evolution*. The David Hume Series. Stanford, Calif.: Center for the Study of Language and Information.
- Chapanis, A. 1965. Color Names for Color Space. *American Scientist* 53: 327-46.
- Davidoff, J. 2015. Color Categorization across Cultures. In: *Handbook of Color Psychology*, ed. A.J. Elliott, Mark D. Fairchild, and A. Franklin, 259-78. Cambridge: Cambridge University Press.
- MacLaury, R. E. 1997. *Color and Cognition in Mesoamerica: Constructing Categories as Vantages*. Facsimile edition. Austin: University of Texas Press.
- Mylonas, D., and L. MacDonald. 2010. Online Colour Naming Experiment Using Munsell Samples. In: *5th European Conference on Colour in Graphics, Imaging, and Vision and 12th International Symposium on Multispectral Colour Science*, 27-32. Joensuu, Finland: IS&T.
- Mylonas, D., and L. MacDonald. 2016. Augmenting basic colour terms in English. *Color Research & Application*, 41(1), 32–42. <https://doi.org/10.1002/col.21944>.
- Derefeldt, G., and T. Swartling. 1995. *Colour Concept Retrieval by Free Colour Naming. Identification of up to 30 Colours without Training*. *Displays* 16 (2): 69–77.
- Griffin, L. D., and D. Mylonas. 2019. *Categorical Colour Geometry*. *PLOS ONE* 14 (5): e0216296. <https://doi.org/10.1371/journal.pone.0216296>.
- Uusküla, M. 2014. Linguistic Categorisation of BLUE in Standard Italian. In: *Colour Studies: A Broad Spectrum*, ed. W. Anderson, C. P. Biggam, C. Hough, C. Kay. Amsterdam/Philadelphia: John Benjamins, 67-78.
- Uusküla, M. 2019. Translation of colour terms: An empirical approach toward word-translation from English into Estonian. *ESUKA - JEFUL* 10-2: 69-84.
- Uusküla, M., L. Hollman, and U. Sutrop 2012. Basic colour terms in five Finno-Ugric language and Estonian Sign: A comparative study. *ESUKA - JEFUL* 3-1: 47-86.
- Sturges, J., and A. Whitfield. 1995. Locating Basic Colours in the Munsell Space. *Color Research & Application* 20 (6): 364-76.

# Brides in black widows in white. Semantic evolution of the social and cultural meaning of colours

Letizia Bollini <sup>1,\*</sup> and Martina Falta <sup>2</sup>

<sup>1</sup> Free University of Bozen-Bolzano; letizia.bollini@unibz.it

<sup>2</sup> University of Milano-Bicocca; m.falta@campus.unimib.it

\* Corresponding author: letizia.bollini@unibz.it

## Abstract

The paper follows the evolution of cultural significance of the symbolism and meaning of black and white thanks to the iconographic evolution of the European visual history. In particular, it focuses on the wedding and funeral dresses, as key social and existential transitions, focusing on the historical moment in which the meaning of the two colours was semantically inverted, and critically considering, the phenomenon and its exceptions.

**Keywords:** *History of colours, Cultural and Intangible Heritage, Visual Design, Iconography*

## INTRODUCTION

Colours have strong symbolic and shared meanings that are deeply rooted in the social evolution of a culture. The objects produced by material culture, such as the inhabited environment, artistic and visual artifacts, costume and clothing have always communicated cultural values that are deeper and more complex than mere aesthetic, to the point of being considered, as stated by Luzzatto and Pompas in *Colori e moda* (2018), a true historical document that reflects the characteristics and orientations of the society in which they have been created. In fact, by analysing preferences for certain colours and relating them to historical and cultural evolution, it is possible to trace the precise ideological, economic and social factors that shaped them (Luzzatto and Pompas 2001). In human history the fundamental role of rites of passage (Han 2020), celebrating the change of an individual inside a community or phase of the life cycle, has been enriched by the use – in intangible as well in material expressions – of colour.

The research follows the evolution of cultural significance of the symbolism and meaning of black and white – darkness and light – thanks to the iconographic evolution of the European visual history as a tool for reconstruction of the meaning. In particular, it focuses on the wedding and funeral dresses – as key social and existential transitions – of the higher social ranks, especially the nobility and, in more recent times, the bourgeoisie, investigating their iconographic and chromatic expressions thanks to past customs traditions as the sources that have survived to the present day: the written ones, such as literary and legislative documents – as the *Sumptuary law* – but, above all, the surviving imagery and material garments, which are of fundamental importance for investigating the history of costume and society in previous periods. Photographs, pictures, films and social media based on images – e.g. Instagram – also helped to reconstruct more recent history, showing the reality of the time in which, they were produced more faithfully or abundance (Bollini 2020) than paintings. Only those cultures of which we have direct knowledge – having been born and brought up in Western, i.e. European, culture and therefore having first-hand experience and training in historical and cultural terms – have been considered, aware that the complexity of other cultures and local developments – often grouped under overly broad labels that do not capture the complexity of reality such as the pre-Columbian societies, Andean, Asia and African cultures – goes beyond the boundaries of this research work.

## LE ROUGE ET LE NOIR

Following the traces of ancient Mediterranean civilisations, however limited the historical evidence may be, it seems that the duality of meaning – which would later be attributed to the contrast

Brides in black widows in white. Semantic evolution of the social and cultural meaning of colours

black/white – is instead signified by the duality of red and black, concrete references to existential and material experience at the same time. On the one hand, there is the red of blood and passion, but also the red of the terracotta used to make vases and other everyday objects, and purple to dye fabrics (Pastoureau 2017) – such as the *flammeum* worn by Roman brides during the wedding ceremony – on the other the shadow and the darkness of unknown, the black of peribility connected with mythologies or religious visions of the afterlife, as well as the *pullus*, the grey-brown colour of burned materials and of death (Luzzatto and Pompas 2019). The symbolic values of these tints, which seem to transcend their primordial production of meaning, traverse the evolution of the Western cultures to become archetypal references. In the novel *The Red and the Black*, Stendhal sublimates its evocative power.

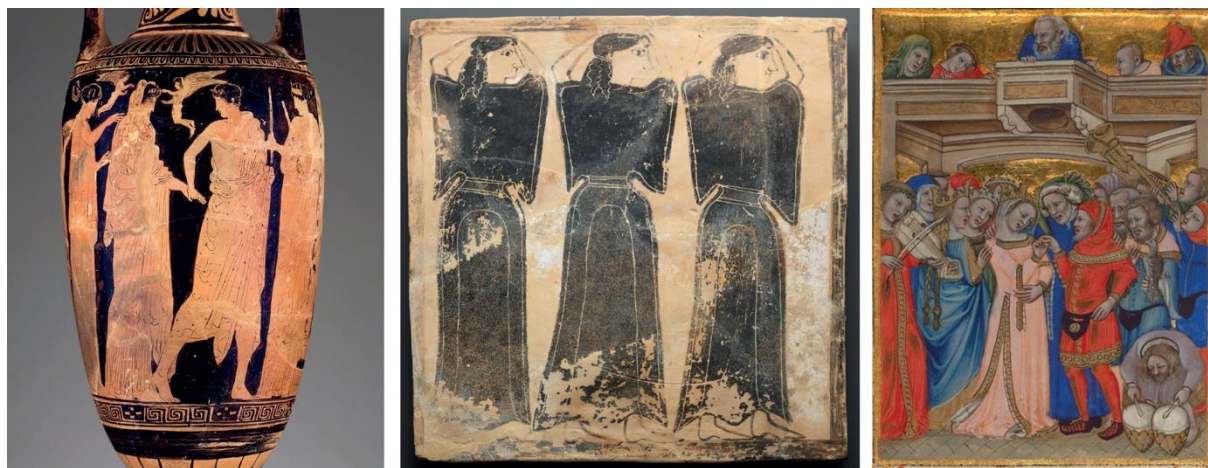

Figure 1: a) Ioutrophoros: nuptial procession, c. 450-425 BC; b) funerary plaque: Three women in mourning, 625-610 BC; c) Niccolò da Bologna, The wedding; The bride's kiss (capital letter P) Miniature on parchment, c. 1350.

The symbolism of red, which evokes passion, transfigures its meanings into blood and crime, creating a sort of short circuit with death and, therefore, with black. While black is worn by the clergy, as a synonym for the mortification of the mundane, material and carnal dimension of existence, red, on the other hand, evokes military life, the ambitious and heroic dimension of public stage. Between these two existential opposites, the action of the novel's protagonist Julien Sorel unfolds, emblematic of a generation and an era, but also of a conception of the world that finds part of its formal expression in the semiotic value of colour.

### **(A WORLD IN) BLACK & WHITE**

If ancient cultures used only the three three “polar” colours, white, red and black, by the Middle Ages “colour is a thing given is something that is given together with the things that possess it, and possessing it and concerns the ontology of matter, that is to say, its essence” (Falcinelli 2017: 67) and further increasingly transfigured by its use in figurative art and costume. With the spread of new materials and the art of dyeing, clothes were enriched with the most varied tones, which allowed the symbology of colours into daily life. As Michel Pastoureau explains in *Black: History of a Colour* (2008), colours, symbolising social divisions, increasingly sophisticated and rich became a means of representing the economic possibilities and social class of families. Rites of passage and ceremonies were therefore tinged with new variations. Brides usually chose blue, a symbol of chastity and royalty, yellow or green, but more commonly red, a symbol of fertility, love and power. The chromatic and dichotomous uniformity to which we are accustomed today has not yet been codified. The first



documented white wedding dress in Western history was worn in 1406, when Princess Philippa of England married Erik of Denmark. On her wedding day, Philippa wore a tunic with a white silk cloak, trimmed with squirrel and ermine fur. The use of wearing white on one's wedding day, however, took hold much later. On the other hand, in the Middle Ages black and white were not considered to be actual colours, while the other colours were attributed a divine significance: "even as belonging to other universe: in black and white on the one hand, in colour on the other" (Pastoureau 2018: 11). In addition, over the years, black lost its positive connotation, being increasingly regarded as the colour of the Devil, death and pain. The ancient tradition of wearing black during periods of mourning, mandatorily prescribed by Pope Innocent III in *De Sacro Altaris Mysterio* (c. 1200), in which he placed purple black with purple as the colour of the priestly garments to be used in the Catholic liturgy for funeral rites. An example of this is embodied by Philip the duke of Burgundy, who after the death of his father John the Fearless in 1419, he decided to wear black clothes all his life as a symbol of his eternal sorrow. However, the available iconography shows that in France, during the Middle Ages, a contrary trend developed: while French kings wore mourning in purple, the queens broke with tradition by starting to wear white, which white, which recalled hope and faith in immortality. and faith in immortality and resurrection: hence they were called "white queens".

The development in the Renaissance period of both dyeing technology and cultural symbolism increasingly extended to aspects of private life. A courtly code of colours was born, the expression of most intimate feelings and passions. The main colours symbolising love were green and blue: *hopeful love* – worn, for example, by Giovanna Cenami on her wedding day to Giovanni Arnolfini, as seen in the portrait depicted by Jan van Eyck (see Figure 2a) – the second sign of a faithful love of a *faithful love* that is not subject to temptation. Brides also used dark tones, brown or black, or red, which was worn by Louise of Lorraine (1575) to indicated love, passion and a high social class.



Figure 2: a) Jan van Eyck, Ritratto dei coniugi Arnolfini (1424); b) Lorenzo Lotto, Ritratto di Marsilio Cassotti e della sua sposa Faustina, (1523).

Nevertheless, the colourful and opulent wedding dress, a sign of the family's wealth, would later be worn again. It was therefore inadvisable to choose a white dress as the fabric would become easily soiled and quickly yellow. To show off her prestige and wealth, Mary I Tudor, daughter of Henry VIII, married Philip II of Spain in 1554. On their wedding day they both wore white and gold robes to emphasise their personal and political union. In particular, Mary's dress consisted of a cloak of gold



cloth covered with ermine fur and decorated with large white pearls, while the petticoat was made of white satin with silver embroidery. Unfortunately, few paintings of this event have survived, and we can mainly rely on written records to reconstruct it historically. One of the most famous white dresses is the one worn by Mary Stuart of Scotland when she married the heir to the French throne, Francis II, for the first time on 24 April 1558 (see Figure 3a). Before the wedding she asked permission to wear white: on her wedding day she wore a large white silk and velvet gown adorned with diamonds and other precious gems, causing a scandal among the public. It was unthinkable that the colour of mourning should be worn on a royal wedding day. In 1565 Mary Stuart, after the death of her husband, remarried her fourth cousin Henry Stuart Lord Darnley and became Queen of Scots. To show her grief at the loss of her first husband, she wore black on her wedding day, the colour of mourning in Scotland (see Figure 3b). Mary Stuart finally married a third time in 1567, to James Hepburn, Earl of Bothwell. As he was the murderer of her previous husband, the wedding took place in secret, with a short ceremony and no celebration afterwards. According to a painting by James Drummond, the Queen is said to have worn a light-coloured dress, probably white, but the painting dates from the 19th century, so Mary may have been painted in a white dress for purely artistic purposes. A further documented case of a white wedding is that of the marriage of Maria de' Medici and Henry IV, celebrated on 6 October 1600. On that day, as can be seen in the paintings of their wedding by Jacopo di Chimenti da Empoli, she wore a white dress, richly ornamented and embroidered in gold. As mentioned, during the Middle Ages the tradition arose for French queens to wear the so-called *deuil blanc*, the white mourning. This tradition remained in France and in the countries with French monarchs until the 16th century. One of the last white queens was Mary Stuart. Her white mourning is evidenced by a painting made between 1559 and 1560 by François Clouet (Figure 3c), the official painter of the French court. The painting and its sketch date back to the previous year of her husband François II death in 1560. They were mistakenly attributed to her husband's bereavement, as the Queen had to deal with several mourning in the period: her father-in-law, Henry II and her mother too. Following whose death, she wore white mourning for forty days, in accordance with tradition, before marrying for the second time.



Figure 3: a) Unknown Artist: Mary Stuart in her wedding dress wedding dress (1558); b) Scottish School: Mary Stuart in her wedding dress of the second marriage (1565); c) François Clouet Mary, Queen of Scots (1559); d) Portrait of Caterina de' Medici (1580).

Elizabeth of Austria, Queen of France from 1570 to 1574, was another of the last white French queens. After losing her husband, Charles IX, she too wore white mourning for the official 40 days in 1574. White queens also included Louise of Lorraine-Vaudémont, wife of Henri III de Valois, who was assassinated in 1589 by a Catholic extremist. After the death of her husband Luisa, devastated despite her unhappy

marriage, took up the white mourning of queens, which she kept until her death: for this reason, she was nicknamed the “white queen”. The French tradition of white mourning was first broken by Anne of Brittany, who was so affected by the death of her husband in 1498, she decided to wear a black dress for the period of mourning. The iconography of Anne of Brittany is very scarce, but we have several testimonies concerning the mourning of Catherine de Medici. For a long time, Catherine, Queen Consort of France from 1547 to 1559, was tortured by the great jealousy she felt towards her husband Henry II, with whom she was very much in love, since he showed great passion for his mistress, Diana of Poitiers. On the occasion of Henry’s death in 1559, the mistress wore white widow’s clothes, while Catherine decided to wear black, going against the tradition of French mourning and sorrow for her dead husband, but also to give her a matronly, austere and chaste appearance. From the paintings of François Clouet (see Figure 3d), Rubens and other painters, we note that the queen wore black clothes for the rest of her life, adorned with a white collar, and a typical headdress, also black. Other black queens include Maria de’ Medici and Anne of Austria. As a result of these events, black gradually consolidated the courts as the dominant colour of mourning, symbolising despair and grief, but also of respect, experienced as a departure from the glitz and polychromy of worldly life. In a short time, the use of black as a mourning colour spread throughout Western Europe, even among the bourgeoisie up to present.

### **YELLOW IS THE NEW BLACK**

An exception – to be further investigated as possible development of this research – is Spain, where it seems that the mourning was apparently not black or white, but yellow. On 7 January 1536 Catherine of Aragon, wife of the King of England Henry VIII until 1533, when he got a divorce and remarried the young Anne Boleyn, died. In her book *The Six Wives of Henry VIII* (2007) Alison Weir recounts how on 9 Jan, two days after the death of the former queen, Anne and Henry wore yellow robes as a sign of respect for Catherine of Aragon, assuming for this reason that that yellow was the colour of royal mourning in her native Spain. That Anne Boleyn and Henry VIII wore yellow dresses is certain: in Hall’s *Chronicle* (dating back from 1547), an English lawyer and historian, we read that on 8 January, the day after Catherine’s death “Quene Anne ware yelowe for the mournful” (Hall 1809: 818). Further evidence from the collection *Letters and Papers of the Reign of Henry VIII*, edited by James Gairdner, in which Eustace Chapuys, ambassador of the Holy Roman the Holy Roman Empire to England, reports that Henry was dressed all in yellow, with a white feather tucked into his cap. However, there are no verified sources mentioning yellow as a symbol of mourning in Spain. The hypothesis that Anne wore this colour for another purpose. According to what we have said so far, it was black that had the mourning colour in all the courts of Europe, as evidenced by the king’s offer, when Chapuys was invited to Catherine’s funeral, to send him and his servants black robes. Also Antonia Fraser, in *The Six Wives of Henry VIII* (1992) writes of the yellow worn by Anne and Henry as the colour of joy, not mentioning any use of it as a traditional colour of mourning. Alison Weir herself, in *her The Lady in the Tower: The Fall of Anne The Fall of Anne Boleyn* (2009) corrects the misconception that yellow was the colour of Spanish Royal mourning: “Anne’s choice of garb was no less than a calculated insult to the memory of the woman she had supplanted” (Weir 2007: 18). A second interpretation of this event emerges, according to which Anne Boleyn and the king wore yellow not to mourn Catherine’s death but to celebrate her a bright and joyful colour may have been to emphasise the fact that Henry had no reason to mourn the death his ex-wife, nor Anne Boleyn, who could finally be queen. Chapuys in support this hypothesis tells us of the climate the court of England after the news of the death: “You could not conceive the joy that the King and those who favour this concubinage have shown at the death of the good Queen” (Gairdner 1887: 51). A further interpretation of the royal couple’s is proposed by Retha

Warnicke in *The Rise and Fall of Anne Boleyn* (1991). Retha wonders whether Hall, in writing about Anne dressed in yellow as a sign of mourning, was he really referring to the death of Catherine of Aragon: since in Hall's Chronicle wrote of Anne dressed in yellow just before talking about her miscarriage the following month, the author speculates that this statement may have been a postscript to the statement regarding the abortion and not Catherine's death. This hypothesis is supported by the posthumous republication of Hall's Chronicle by Richard Grafton, which misunderstood the original author's notes, leading to a misunderstanding that has survived until today. This hypothesis does not, however, explain the account of Chapuys' account of Henry dressed in yellow, just as it does not explain why Anne would have worn dressed in yellow to mourn her son, as yellow was not the tradition colour of mourning in the sixteenth century.

## **CONCLUSIONS**

The historical excursus presented in the paper with particular reference to black and white and the ambivalence of the symbolic and social use of colours – especially in certain rites of passage such as weddings and mourning – aims to underline the polysemanticity and cultural variability of the chromatic value within the visual and expressive language of the history of costume. It represents a preliminary study, in terms of historical-temporal periodization of the evolution of the two opposing colours black and white within the evolution of western culture and is intended to open up further investigation both in terms of periods and cultural contamination.

## **ACKNOWLEDGEMENTS**

Although the paper is the results of the conjunct work of the authors, Bollini is in particular author of paragraphs 1, 2, 3 and 5 and Falta of paragraph 4.

## **REFERENCES**

- Bollini, L. 2020. Ephemeral Memories. The Paradox of Images' Abundance in the Age of Digital Mortality. In: *International and Interdisciplinary Conference on Image and Imagination 2019*, E. Cicalò, ed. Cham: Springer, 419-431.
- Falcinelli, R. 2017. *Cromorama. Come il colore ha cambiato il nostro sguardo*. Torino: Einaudi.
- Han, B. H. 2020. *The Disappearance of Rituals: A Topology of the Present*. Cambridge: Polity Press.
- Fraser, A. 1992. *The Six Wives of Henry VIII*. London: Weidenfeld & Nicolson.
- Gairdner, J. 1887. *Letters and Papers* (Vol. 10, pp. 47-64). London: Her Majesty's Stationery Office.
- Hall, E. 1809. *Hall's chronicle*. London: Printed for J. Johnson.
- Luzzatto, L. and R. Pompas. 2019. *Black, white and red: archetypes and symbols*. In AIC Midterm Meeting Color and Landscape. Buenos Aires. Online: <https://www.color-and-colors.it/wp-content/uploads/2020/05/Black-white-and-red-archetypes-and-symbols.pdf>
- . 2018. *Colori e moda*. Milano: Bompiani.
- . 2001. *Il significato dei colori nelle società antiche*. Milano: Bompiani.
- Pastoreau, M. 2018. *Dizionario dei colori del nostro tempo*. Firenze: Ponte delle Grazie.
- . 2017. *Red: The History of a Color*. Princeton: Princeton University Press.
- . 2008. *Black: The History of a Color*. Princeton: Princeton University Press.
- Weir, A. 2007. *The Six Wives of Henry VIII*. New York: Grove Press.

# Age-related differences in richness and diversity of Russian color lexicon

Yulia A. Griber <sup>1,\*</sup>, Dimitris Mylonas <sup>2</sup> and Galina V. Paramei <sup>3</sup>

<sup>1</sup> Smolensk State University, Smolensk, Russia; y.griber@gmail.com

<sup>2</sup> New College of the Humanities at Northeastern University, London, UK; dimitris.mylonas@nchlondon.ac.uk

<sup>3</sup> Liverpool Hope University, Liverpool, UK; parameg@hope.ac.uk

\* Corresponding author: y.griber@gmail.com

## Abstract

In the present study, we investigated age-related differences in richness and diversity of color lexicon in Russian native speakers. Color names were elicited in 2018–2020 in an ongoing web-based psycholinguistic experiment (<https://colournaming.com>). An unconstrained color-naming method was employed. A final dataset contained responses of 1,967 native Russian speakers (1,280 females, 677 males, 10 non-binary), from various locations of the Russian Federation, aged 16–98 years. Participants were stratified into seven age groups (years): 16–19 ( $M=17.59 \pm 1.19$ ), 20–29 ( $M=24.86 \pm 3.11$ ), 30–39 ( $M=35.04 \pm 2.89$ ), 40–49 ( $M=45.18 \pm 2.86$ ), 50–59 ( $M=55.63 \pm 2.90$ ), 60–69 ( $M=65.05 \pm 2.87$ ) and  $\geq 70$  ( $M=78.20 \pm 4.97$ ). To estimate heterogeneity of color lexicon in each age group, we applied the Margalef and Simpson indices broadly used for measuring ecological diversity. The indices enabled gauging richness of color lexicon, i.e., the number of word types in the dataset, and color-term evenness, i.e., the relative abundance of different color terms. Our analysis of synchronic variability provides evidence that color vocabulary develops actively throughout the entire adult life and remains relatively stable in both richness and diversity up to the old age. Respondents of the three younger groups, under 40 years, revealed the greatest color lexicon diversity. In comparison, in the 40–59-year-old the diversity index was lower, and decreased dramatically in respondents of 60 years and older. The apprehended dynamics reflects intergenerational differences as such, but even more so dramatic changes of sociocultural reality in the post-Soviet era (after 1991).

**Keywords:** color naming, Russian, age-related differences, richness of lexicon, diversity of lexicon

## INTRODUCTION

Aging is known to affect various levels of language processing including but not limited to mental lexicon (Wulff et al. 2019), language variation (Pichler et al. 2018), lexical diversity and vocabulary size (Brysbaert et al. 2016), object naming ability and lexical retrieval (Connor et al. 2004).

Yet, there is surprisingly little research that explored variation of color lexicon in speakers of different age groups in a certain language. Among rare exceptions is a study of Zaręba (1954), who explored intergenerational differences of color names in Polish dialects. For non-industrialized cultures, Kay (1975) and Dougherty (1977) found convincing evidence that younger speakers use more color terms and manifest linguistically more refined color space partitioning than older speakers. More recently, in older Udmurt speakers Ryabina (2009) recorded many more elaborate color terms – qualified basic color terms (BCTs), non-BCTs or qualified fancy terms. For Swedish speakers, Vejdemo (2018) revealed that older Swedes used many more modifiers and color compounds than younger speakers; moreover, there was an intergenerational flux in labeling basic color categories, with lexical replacement demonstrated by younger speakers.

In the present study, we investigated age-related differences in richness and diversity of color lexicon in Russian native speakers.

## MATERIALS AND METHODS

### Web-based psycholinguistic experiment

Color names were elicited in 2018–2020 in an ongoing web-based psycholinguistic experiment (<https://colournaming.com>). Color stimuli (N=606) were approximately uniformly distributed in the Munsell color space. An unconstrained color-naming method was employed: observers were presented with randomly ordered stimuli, one at a time, and asked to name the color by typing their responses in Russian using Cyrillic alphabet. Respondents were free to use any color descriptor – either a single word, or a compound, or term(s) with modifiers or qualifiers (for further details see Mylonas and MacDonald 2010; Griber et al. 2018; Paramei et al. 2018).

### Participants

A final dataset contained responses of 1,967 native Russian speakers (1,280 females, 677 males, 10 non-binary), from various locations of the Russian Federation, aged 16–98 years (Table 1).

	Total	16–19	20–29	30–39	40–49	50–59	60–69	70+
Female	1,280	74	324	253	179	165	165	120
Male	677	19	127	139	101	88	121	82
Other	10	2	2	1	2	1	2	0
Total	1,967	95	453	393	282	254	288	202

Table 1: Number of participants of different genders, in the total sample and stratified into seven age groups.

Participants were stratified into seven age groups (Table 2).

	Total	16–19	20–29	30–39	40–49	50–59	60–69	70+
Mean age	42.54	17.59	24.86	35.04	45.18	55.63	65.05	78.20
SD	17.71	1.19	3.11	2.89	2.86	2.90	2.87	4.97

Table 2: Mean (SD) age of participants, in the total sample and stratified into seven age groups.

The refined dataset contained 55,516 responses that undergone linguistic analysis (Table 3).

	Total	16–19	20–29	30–39	40–49	50–59	60–69	70+
Number of responses	55,516	2,175	11,581	10,287	7,107	7,297	6,192	3,864
Number of word types	3,128	354	1,299	1,034	840	740	385	209

Table 3: Number of unique responses and word types.

### Diversity indices

To estimate heterogeneity of color lexicon in each age group, we applied the indices broadly used in ecological studies (where diversity of species is crucial for evaluating health of ecological systems).

The diversity indices can be of two types: those that assess species' (1) richness (the number of species), and (2) evenness, or dominance (the distributive number of individual organisms among the species).

Analyzing individual color names by analogy with biological species, we used diversity measures of both types, to account for color lexicon richness (the number of color terms, or word types, present in the dataset), as well as color term evenness (relative abundance of the different color terms) for each age group.

To assess color lexicon richness, we applied the Margalef (1958) diversity index that captures system's entropy. Here, to calculate the diversity index for each age group, we used the formula suggested by Iglesias-Rios and Mazzoni (2014):

$$R = (s-1) / \ln N, \quad (1)$$

where  $s$  is the number of word types, and  $N$  is the total number of responses in the sample.

The Margalef index enables to capture the number of different color names (word types) in the dataset of the participant sample. The more word types are present, the 'richer' is the sample's color lexicon. Note that the Margalef index does not take into account the number of responses in each word type: it allocates equal weight both to those color names that occurred very rarely and those that occurred frequently among participants' responses. For instance, color name *belosnežnyj* 'snow-white' offered by a single participant has as much influence on the richness measure as BCT *fioletovyj* 'purple' offered thousands of times.

To assess evenness, i.e., relative abundance of different color names in the dataset, we implemented the Simpson index (Simpson, 1949) defined as:

$$D = 1 - \sum(n_i(n_i-1)) / N(N-1), \quad (2)$$

where  $n_i$  is the number of responses of the  $i_{th}$  word type, and  $N$  is the total number of responses in the dataset.

Thus, the Simpson index takes into account not only the number of word types present in the dataset, but also the number of occurrences of each word type. Its value ranges between 0 and 1, and presents the probability that two responses randomly selected from the dataset will contain different types of color names.



Figure 1: The Margalef (left) and Simpson (right) diversity indices for the seven age groups.

## RESULTS

Our apparent-time analysis (or synchronic variability), gauged by the two indices of diversity, provides evidence that color vocabulary develops actively throughout the entire adult life and remains relatively stable in both richness and diversity up to the old age (Figure 1).

Since the Margalef index is highly sensitive to the sample size (here: size of the age group), we calculated it, in addition, for each year-of-life cohort, to measure color lexicon diversity of the 16-year-old, 17-year-old and so on (Figure 2).

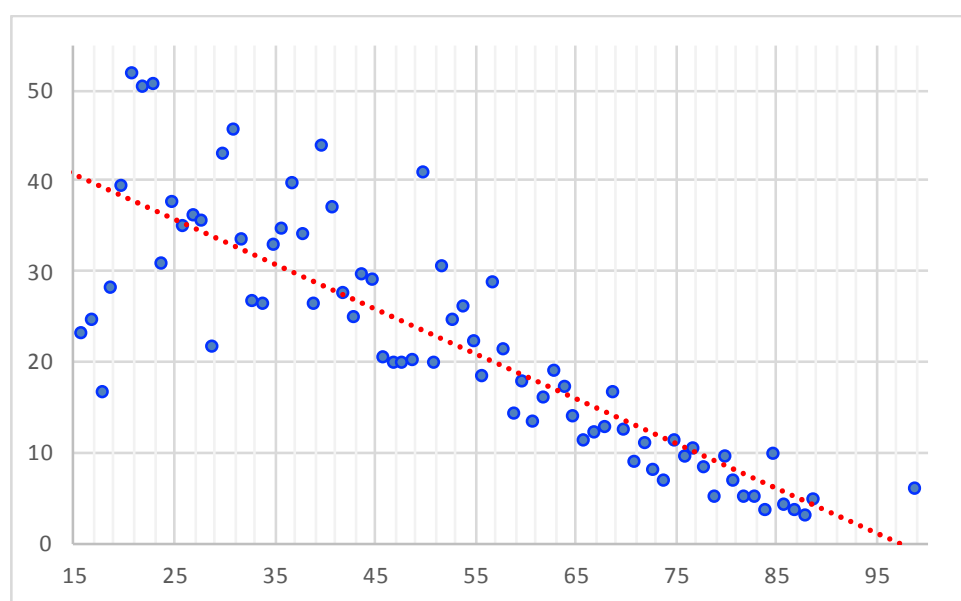

Figure 2: The Margalef diversity index estimated for each year-of-life cohort in the sample aged 16–98 years old.

The Simpson index (Figure 1, right) indicates that respondents of the three younger groups, under 40 years, revealed the greatest color lexicon evenness. Furthermore, color inventories of the 16–19-year-old and of those in their 20s and 30s are rather different from color inventories of other age groups. In particular, along with 12 Russian BCTs, the younger groups' color vocabulary was richer and more variegated, and included abundant monolexic non-BCTs, modified and compounded color terms.

In comparison, in the 40–59-year-old the Margalef richness index was lower, and decreased dramatically in respondents of 60 years and older (Figure 1, left, Figure 2). The decline in both richness and evenness of color lexicon observed here in mature speakers is in accord with the findings of general waning, with age, of the vocabulary size and lexical diversity (see, e.g., Brysbaert et al. 2016).

Beyond the diversity measures, we observe further ongoing juniority effects of color lexicon enrichment. For younger Russian speakers, these effects have three main manifestations:

- (i) Augmenting of the inventory of basic color terms;
- (ii) Active lexical refinement of four basic color categories, PURPLE, GREEN, BLUE and PINK, and, as well, of “hard-to-name” areas of color space at the boundaries of BLUE-GREEN, YELLOW-GREEN and ORANGE-BROWN categories;
- (iii) Qualitative differences in younger generations' lexicon, specifically: accruing of novel terms whose object references emerged in the last three decades; an increasing use of idiosyncratic terms that serve an expressive rather than informative function.

## CONCLUSIONS

Our results provide evidence of intergenerational differences in color lexicon in the representative sample of native Russian speakers characterized by a significant age span, from 16 to 98 years old, and stratified into seven age groups.

The Margalef and Simpson diversity indices were applied for analyzing color term inventories for individual age groups. In tandem, the diversity indices enabled gauging and comparing richness of color lexicon (i.e., the number of word types) and color term evenness (i.e., relative abundance of different color terms) in each of the seven age groups.

We found both quantitative and qualitative differences in the color word types between younger generations (aged 16–39 years) and those aged 40 and older: color inventory of the former is both richer and more diverse. The apprehended apparent-time dynamics, namely, the juniority effects of color-term incrementation, reflects intergenerational differences as such, but even more so dramatic changes of sociocultural reality in the post-Soviet era (after 1991), whereby Russian speakers became greatly impacted by globalization of trade with new market product arrivals. This resulted in elaboration of novel (frequently loan) terms, especially by younger speakers, for efficient communication about perceived color of the chromatic environment significantly enriched by coloration of new diverse products.

## ACKNOWLEDGEMENTS

Y.G. was supported by the Grant 17-29-09145 of the Russian Foundation for Basic Research. D.M. was supported by a FY22 TIER 1 Seed Grant from Northeastern University (US). Support of Tatjana Samoilova, Alexei Delov, and Karina Zyganova in data processing is gratefully appreciated. The authors are also grateful to all participants for their time and good will.

## REFERENCES

- Brysbaert, M., M. Stevens, P. Mandera, and E. Keuleers. 2016. How many words do we know? Practical estimates of vocabulary size dependent on word definition, the degree of language input and the participant's age. *Frontiers in Psychology* 7: 1116. doi: 10.3389/fpsyg.2016.01116
- Connor, L. T., A. Spiro, L. K. Obler, and M. L. Albert. 2004. Change in object naming ability during adulthood. *The Journals of Gerontology, Series B* 59(5): 203-209.
- Dougherty, J. W. D. 1977. Color categorization in West Futunese: Variability and change. In: *Sociocultural dimensions of language change*, B. G. Blount, ed. New York: Academic Press, 143-148.
- Griber, Y. A., D. Mylonas, and G. V. Paramei. 2018. Objects as culture-specific referents of color terms in Russian. *Color Research and Application* 43(6): 958-975.
- Iglesias-Rios, R., and R. Mazzoni. 2014. Measuring diversity: Looking for processes that generate diversity. *Natureza & Conservação* 12(2): 156-161.
- Kay, P. 1975. Synchronic variability and diachronic change in basic color terms. *Language in Society* 4(3): 257-270.
- Margalef, R. 1956. Información y diversidad específica en las comunidades de organismos [Information and specific diversity in communities of organisms]. *Investigación Pesquera* 3: 99-106 (in Spanish).
- Mylonas, D., and L. MacDonald. 2010. Online colour naming experiment using Munsell samples. *Proceedings of the 5th European Conference on Colour in Graphics, Imaging, and Vision – CGIV 2010*, 27-32.



- Paramei, G. V., Y. A. Griber, and D. Mylonas. 2018. An online color naming experiment in Russian using Munsell color samples. *Color Research and Application* 43(3): 358-374.
- Pichler, H., S. E. Wagner, and A. Hesson, A. 2018. Old-age language variation and change: Confronting variationist ageism. *Language and Linguistics Compass* 12(6): 1-21.
- Ryabina, E. 2009. Sex-related differences in the colour vocabulary of Udmurts. *Wiener elektronische Beiträge des Instituts für Finno-Ugristik (WEBFU)*.  
<http://webfu.univie.ac.at/texte/12Ryabina.pdf>
- Simpson, E. H. 1949. Measurement of diversity. *Nature* 163: 688. <https://doi.org/10.1038/163688a0>
- Vejdemo, S. 2018. Lexical change often begins and ends in semantic peripheries: Evidence from color linguistics. *Pragmatics & Cognition* 25(1): 50-85.
- Wulf, D. U., S. De Deyne, M. N. Jones, and R. Mata. 2019. The Aging Lexicon Consortium. New perspectives on the aging lexicon. *Trends in Cognitive Sciences* 23(8): 686-698.
- Zaręba, A. 1954. *Nazwy barw w dialektach i historii języka polskiego [Color names in dialects and history of the Polish language]*. Wrocław: Ossolińskich (in Polish).

# Knowledge as a project parameter: comparative colour theories

Anna Marotta <sup>1</sup>, Rossana Netti <sup>2,\*</sup>

<sup>1</sup> Politecnico di Torino; nannarella.marotta@gmail.com

<sup>2</sup> Politecnico di Torino; rossana.netti@polito.it

\* Corresponding author: rossana.netti@polito.it

## Abstract

The "Colour Theory" does not exist! We still see publications that talk about the "Colour Theory" as if there were only one or even mention the elementary convention between additive and subtractive synthesis, forgetting that there are dozens of them in the specialist literature.

Similarly, the images flooding the web - a scope where the problem of validating the scientific sources and data on which the various contributions are based has not yet been resolved - often report erroneous attributions of theories and models.

In countertendency and in order to obviate such unjustified errors and lacks, the contribution will systematically propose again results of investigations already published in *Policroma* (Marotta, 1999) with 48 chromatic theories (and as many Authors, models and related rules and parameters), collected and compared in an interdisciplinary and international dimension, through a synopsis configured as a real "icon" of the Chromatic Culture, which met the interest and approval also of Rudolph Arnhem (in 1999). With these methodological premises, in the imminent second edition of the volume (by Anna Marotta and Rossana Netti), a broader reflection on the possible definitions of the specific concept of "colour theory", also in the "comparative" chromatic version, will be deepened in a rigorous manner, with more precise verifications and applications. Therefore, not a banal and uncritical tool merely for application, with rigid and sterile automatisms from which to mechanically derive rules and standard solutions, but complex and integrated disciplinary approaches, criteria, parameters, rules, to arrive at procedures and mental maps.

**Keywords:** *Colour Theories and Models, Authors, Colour Culture, Applications, Digital Models*

## INTRODUCTION: A 'COMPARATIVE MOSAIC' FROM POLICROMA

On a scientific-speculative level, we cannot any longer speak (as unfortunately still happens) of "Colour Theory" or "Colour Model" as if it were an amorphous, "neutral" and undifferentiated entity or reality, lacking a specific place in highly specialised cultures. In this sense, a methodological premise should be made explicit: the concept of "Theory of Colour" (when not better specified) appears to be meaningless, since it is now widely established that there are many comparable and comparative theories, pertinent to different disciplinary approaches, diversified, well characterised and identifiable through specific and univocal parameters and criteria (Marotta 1999): it is therefore sufficient to orient knowledge, planning and operability in a selectively critical and alert way. In 1899, for example, a "simple" mural painting manual such as Ronchetti, cited theories like those by Rood, about variation of colours according to light (Ronchetti 1947).

### **Policroma, the icon of a method: comparative Theories and their models, protagonists, modes and fields of application**

Based on the methodological premise that colour is a true filter (considering history and knowledge as inalienable elements) with which to "read" and evaluate different realities, phenomenologies and relative outcomes (material and immaterial) and, more indirectly (but no less effectively), defined periods and cultural matrices of belonging, the synoptic table in figure 1 has been designed with the intention of systematising and making comparable - first and foremost visually - chromatic models produced from the Middle Ages to the present day, presented in chronological order. Therefore, at a single glance, the density and articulated stratification of chromatic culture seems to reveal itself

qualitatively and quantitatively, confirming it as a specialist discipline, characterised by its own processes, methodologies, parameters and languages, to be read and applied in rigorous terms and in precisely identified contexts, never undifferentiated or neutral. It highlights the potential of vision, considered not only as a physiological-perceptive process of an instinctual nature, but also as a cognitive, cultured, creative and critical verification (Marotta 2012). Conceived in this way, the synopsis itself is configured as a true "icon" of chromatic culture from the Renaissance onwards, between Europe and America, making the periods, the Authors, the geometric-formal configurations of the models, the artistic and scientific matrices and so on immediately comparable.

The synoptic framework of the models is the visualisation (icon) of a systematic comparison by periods, which confirms itself as a precious methodological tool to clarify the phenomena related to the Chromatic Culture, with the possibility of hypothesising and clarifying relations and contacts between Authors of the various theories, to highlight similarities and differences in the relative outcomes. But it also allows academics of various disciplines to observe and monitor the developments of the various studies and research over time, to discover their mutual intersections and influences, as well as being a privileged laboratory to establish and compare (integrate) specific disciplinary dictionaries, which certainly cannot be declined (in a decontextualized way) in improper or unconscious terms and meanings.

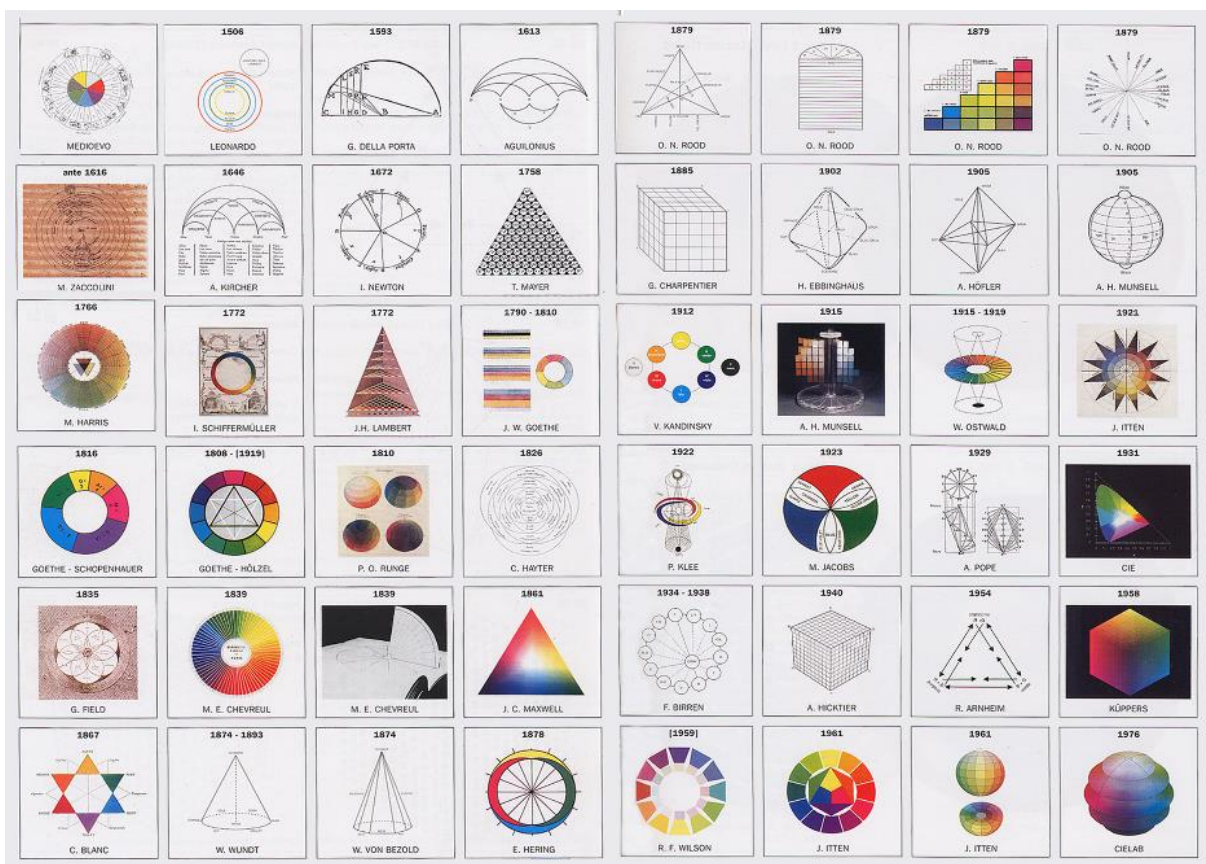

Figure 1: Comparative table of colour models (Marotta 1999, pp. 54-55).

This tool therefore assumes a strong and effective practical value for the possibility of communicating the fundamental data of these theories, together with the various Authors, in a direct and correct way, but also the applications of these theories, both at the level of design and of analytical

investigations, in any field. However, the highest objective - for everyone - is to educate to a "way of thinking colour" and to a Culture of colour.

### ***Meaning and representation in models***

In the past, to represent, display and symbolise their theories, models of colour have been an indispensable tool for communicating theories, for their intellectual development, for experimentation and the use of design criticism, a tool still recognised today for a conscious and specialised approach to colour culture (Marotta 2019). Among the disciplinary fields involved we have Representation, Physics (optics), Philosophy, Semiotics, etc., while among the more applied fields of interest we could mention the Phenomenology of Image and Perception, Psychology, Art, Painting, Architecture, etc.

The models of colour can be charts that represent algebraically determined functions (for example, a wavelength that generates a colour, in its tone). Colour schemes designed to express the symbolic meanings of colour, assuming the shapes of the models themselves connotations and denotations signifiers very important are the geometric invariants, with his parameters of reading: in addition to the chronological reading, models of colour can be read and classified according to invariant, which constitute at the same time interpretive key and generating principle. To explain the close relationship that exists between a theory of colour and its pattern, it seems useful to recognize in the first instance, the geometrical invariants of the latter not only as such, but also as a symbolic representation and signification of more detailed and extensive content, or of specific phenomena. Among the most characteristic invariants it is possible to recognise the following: the type of configuration of the model (general macrostructure); the value of centrality (which in many cases coincides with the central colour of the model); the presence of axes and diameters representing visual or theoretical-symbolic oppositions and polarisations (high/low, right/left, clear/dark, light/ darkness, life/death); the relationship between geometric form and parameters represented; the quantitative and qualitative topological aspects of the distribution and composition of colour within the model (Figure 2).

### ***AN ELEMENT OF COMPLEXITY: DEFINITIONS AND CONVENTIONS***

In *Policroma*, the chapter on the name of the colour proposes a method of first approach to arrive at a possible schematization, useful for the nomenclature of the colours and for the relative filing and comparison. The tabulations collect the names of the colours (limited above all to those most in use in the tradition) with the relative etymological derivation, the material composition, the historical phase to which they belong and finally some documented areas of application. At the basis of this position there is obviously the conviction that colour, even in its lexical implications, is a complex phenomenon - therefore not banally framed in schematisations or automatisms - culturally, geographically and ethnically differentiated, historically stratified and from time to time identifiable according to the areas and disciplines in which it is applied.

As operators and specialists in the various sectors are well aware, the "name", thus conceived, can characterise and identify in a precise manner not only colour as "hue" in its broadest sense, but also the most specific chromatic expressions: both those generated and recognised in the most detailed technical-scientific components of colourimetry (the quantity of light, wavelength, etc.), as well as those originating from specific executive technologies, from historical-artistic or aesthetic-symbolic, emotional, psychological values and so on.

The same work also includes a comparative dictionary that brings together entries and definitions related to colour and its main processes, taken from critically selected sources, for an initial

comparative synthesis. The comparison reveals, in some cases, gaps, inconsistencies and contradictions (see, for example, the definition of "primary or fundamental colour"), highlighting the need to return to the conventions relating to the terms most in use in current practice. It is also evident that references to chromatic models (such as the "triangle" for the definition of the term "colorimetric") are often cited without any historiographical or disciplinary reference to the theories from which they appear to be derived. This can lead to misunderstandings or disorientation. If, for example, one speaks of "opposite" colours in the definition of complementary, the concept is not complete if one does not state the type of "opposition": if one refers, for example, to diametrically opposed colours on a circle, one should specify whether the referential model is Goethe's circle, rather than Chevreul's, or Rood's contrast diagram, or others. The vocabulary presented in this book is not to be considered exhaustive, as it was created to provide the most elementary and immediate conventions for a more conscious consultation and a clearer use of the language of colour.



Figure 2: Geometric invariants of models (Marotta, in publication 2021).

### CONCLUSIONS: A NEW MODEL FOR ANALYSIS AND PROJECT

The "lesson" that can be drawn from the Theories of Colour and their History, is to rediscover their intellectual and scientific continuity and confirm their topicality. The help of an original "Design Model", visible in figure 3, could allow (outside of rigid automatisms) to put in critical relation disciplinary approaches, criteria, parameters and rules, but above all to start cross comparisons, multi



and transdisciplinary, for analysis and design. A further advantage could be to enable scholars from different disciplines to observe and monitor the development of studies and research over time, in order to discover their mutual crossings and influences, or to be able to establish, compare and integrate specific disciplinary dictionaries. But the highest objective can certainly be considered that of re-proposing the system of Comparative Theories as a tool to "educate" to the Colour Culture, to the "Colour Thought" (in analogy with Rudolph Arnheim's "Visual Thought") and as a *Weltanschauung* for a more conscious approach to colour: in experience, analysis and project (Arnheim 2002).

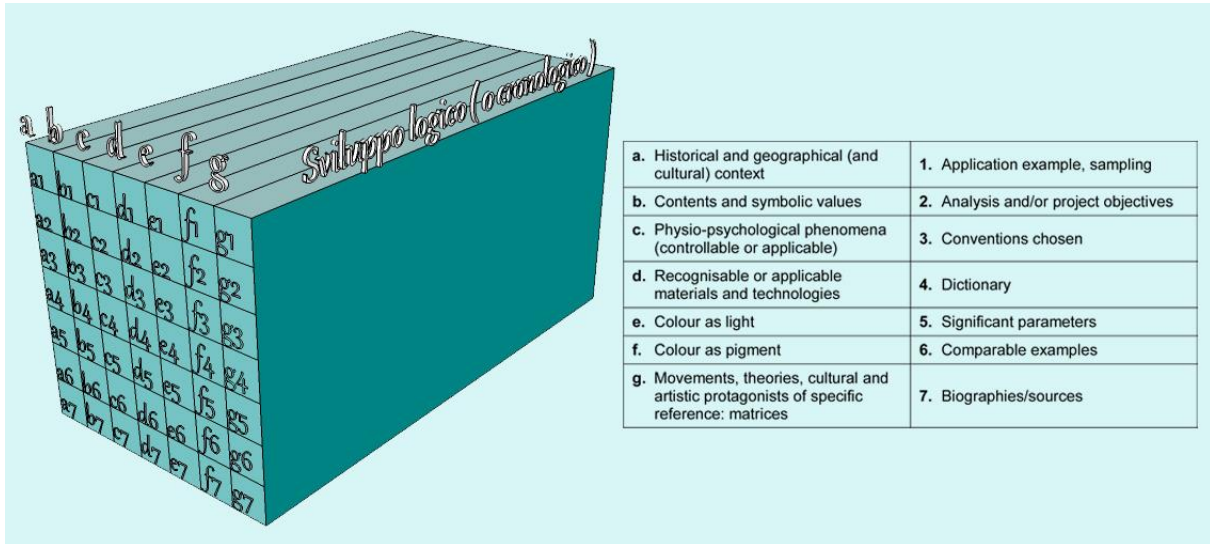

Figure 3: Anna Marotta, "Policroma Model". The image intends to visually communicate the possibility of relating some of the parameters that can be adopted in the design choices, in an alphanumeric relationship. The "third dimension" may include developments by themes or periods (Marotta, in publication 2021).

***From a very ancient past to a present almost... future. From matter to digital, from pigment to pixel***

Throughout history, the use of colour has developed in parallel with the evolution of the arts, culture, commerce and the expansion of exchanges and knowledge of materials, binders, soils and painting and construction techniques; therefore, it can be stated without hesitation that there is no surface, volume or body in general that is not affected by chromatic conditioning and that every period can be identified and framed through a particular manifestation of colour (Netti 2019).

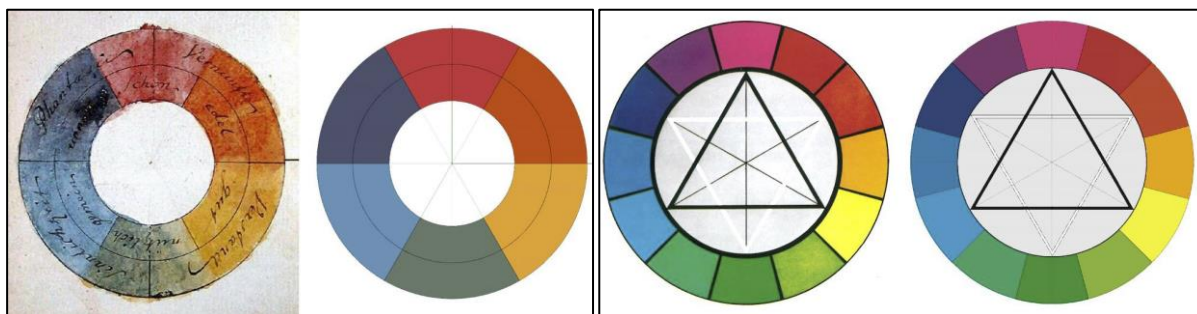

Figure 4: Left: comparison of Goethe's 'Rose of Temperaments', in its version in the Deutsches Hochstift - Frankfurter Goethe-Museum, and its digital transposition; right: comparison of Hölzel's Chromatic Circle of 1919 composed of twelve colours, and its digital transposition (Marotta, Vitali, 2017, p. 498).

If we move towards the present day, our attention tends to focus, given its effectiveness, on the digital and its formal language in all its expressions (including colour) and this entails the inevitable

encounter of certain problems that often accompany the reproduction of images on the web, such as difference in terms of colour rendering. In this case too, "colour models", reconfigured in a digital key (Figure 4 and Figure 5), can help us in reading and validating sources, not only from a qualitative point of view, but rather in terms of the quantity of digital parameters linked, for example, to tint, brightness and saturation (Marotta, Vitali, 2017).

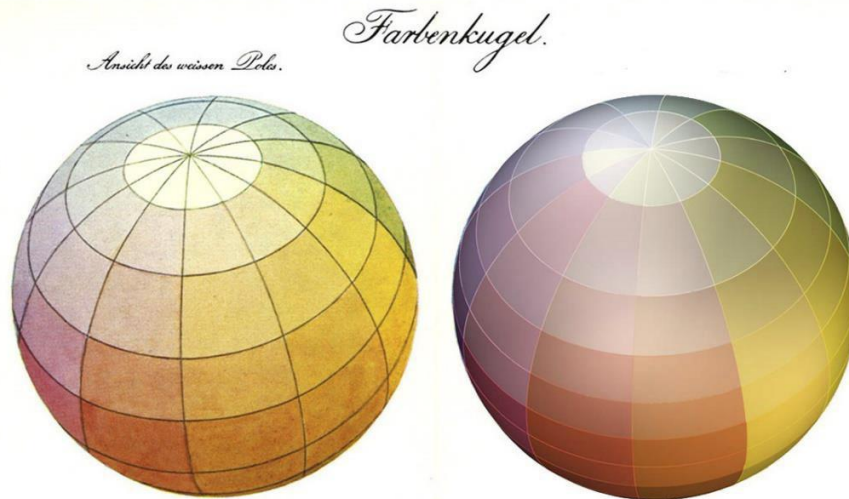

Figure 5: Runge's Sphere of Colours (Runge, 1810) in an excerpt from the original compared with a digital version, constructed from the sections depicted by the author in the same table (Marotta, Vitali, 2017, p. 498).

## REFERENCES

- Arnheim, R. 2002. *Arte e percezione visiva. Nuova versione*. Milano: Feltrinelli.
- Marotta, A. 1999. *Policroma. Dalle teorie comparate al progetto del colore*. Torino: Celid.
- Marotta, A. 2012. *Teorie comparate del colore nella cultura della visione*. In *Elogio della teoria*, UID Roma, 34° Convegno Internazionale dei Docenti della Rappresentazione, Roma: Gangemi Editore, p. 433.
- Marotta, A., Vitali, M. 2017. *La modellazione tridimensionale come espansione concettuale dei modelli del colore*. In: Marchiafava V., Valan F. (edited by), *Colore e colorimetria. Contributi multidisciplinari*, Gruppo del Colore – Associazione Italiana Colore, Vol. XIII A, pp. 493-504.
- Marotta, A. 2019. *Two theories for a model: the "querelle" between Klee and Ostwald*. In: *Cultura e Scienze del Colore / Color Culture and Science*, ISSN 2384-9568 - Elettronico - Vol. 11, 02 (2019), pp. 63-72.
- Marotta, A. In publication (2021). *Colour not by chance. Culture of Vision for a conscious chromatic project*. In Plutino A., Simone G., Rizzi A. *Color Design & Technology - A Multidisciplinary Approach to Colour, Research Culture and Science Book (RCASB)*, published by Gruppo del Colore – Associazione Italiana Colore.
- Netti, R. 2019. *The colours of the ancient Greek architecture*, in *Cultura e Scienze del Colore / Color Culture and Science*, ISSN 2384-9568 - Elettronico - Vol. 11, 02 (2019), pp. 14-24.
- Ronchetti, G. 1947. *Pittura murale. Fresco, tempera, stereocromia, pittura ad olio, encausto*. Milano: Hoepli.
- Runge P. O. 1810. *Farben-Kugel oder Construction des Verhältnisses aller Mischungen der Farben zueinander, und ihrer vollständigen Affinität, mit angehängtem Versuch einer Ableitung der Harmonie in den Zusammenstellungen der Farben*. Hamburg: Friedrich Perthes.

# Scientific basics in art from the Theories of Colour: Authors, methods, rules, applications

Anna Marotta <sup>1,\*</sup>

<sup>1</sup> Politecnico di Torino; anna.marotta@formerfaculty.polito.it

\* Corresponding author: anna.marotta@formerfaculty.polito.it

## Abstract

In the “chromatic way of thinking”, between Art and Science, between the Nineteenth and Twentieth centuries, colour played an essential role: between Romanticism and Modernism, between Impressionism, Post-Impressionism, Neo-Impressionism (and other derivated movements). This complex phenomenon (with its experiences and manifestations) is connected programmatically to the equally complex phenomenon of the Theories of Colour, which has to insert in the debate about contemporary artistic theories. In a broad cultural and scientific territory, starting from the qualified literature and from the publications of the time, the analysis methodology addresses the relationships between institutions, and the exchanges between individual theorists and protagonists, paying attention to the artists that have punctually and consciously applied and experimented those theories, up to the examples in executive techniques, practised in relation with their training. It is consistent with my thirty-year investigations on 48 chromatic beliefs, collected and systematically compared (Marotta 1999). The critical rereading of the treatises and works through their interrelated cultures and experiences confirms a system of knowledge stratified and verified in practise, in an international and interdisciplinary dimension, all to be explored.

**Keywords:** *Theories of Colour, artistic movements, Impressionism, treatises and publications, techniques*

## INTRODUCTION

Part of the contemporary “chromatic way of thinking” is rooted openly and continuously with some theories from the past (or, on the contrary, in strong dissent with them): the intuitions and observations of figures from the Eighteenth and Nineteenth century, such as Goethe and Runge, have been fruitfully resumed (from various points of view and with a significant increase in the scientific field) by Michel-Eugène Chevreul, Charles Blanc, from James Clerk Maxwell to Ogden Nicholas Rood, up to Ludwig von Helmholtz and Wilhelm von Bezold throughout the Nineteenth century (for images of the relevant Models see Marotta, 1999). Nevertheless, it is confirmed how much the aforementioned contributions have exercised decisive influences in the formation of artistic movements that have been decisive for the Nineteenth-century culture, such as those linked to Impressionism (in all its variants): works by painters such as the French George Seurat and Paul Signac, or the Italians Gaetano Previati and Giovanni Segantini, are born programmatically from the comparison and application - between science and art - of the same theories just mentioned.

### 1. Between science and art: Chevreul’s theories in Monet’s experience

Our journey begins with the relationship (a little examined) between Monet and the French chemist Michel Eugène Chevreul (Marotta 1999) - above all according to the rule of simultaneous and subsequent contrast - in the representation of gardens (a passion and an artistic practice by Monet) content of famous pictorial cycles. Chevreul’s experience also includes a wide range of applications to the complex universe of vision, involving different material objects and behaviours, as specified in the title: *De la loi du contraste simultanee des couleurs et de l’assortiment des objets colorées (...)* from 1839, (Marotta 1999). For the elaboration of his scientific theories, Chevreul had Goethe as his first inspiring basics, but also the essay by Claude-Antoine Prieur-Duvernois, *Considerations sur les couleurs et sur plusieurs de leurs apparances singulières* (Prieur-Duvernois 1805). He was the Director



of the dyeing department at the Gobelins tapestry shop and took an interest in the theory of colour and texture because of his work of controlling the preparation of the dye, which led him to discover that the bigger problems of this procedure did not derive from processes of chemical nature but of optical nature, since the false perception of colour was often due to the influence of the colours in the adjacent context, rather than to innate blemish in the pigments themselves. Particularly interesting (and generally less known) is the part of the book dedicated to the design and care of gardens. Starting from the belief that colour is the most appreciated and evocative part of the plant world, Chevreul applied the principles of simultaneous and subsequent contrast to the choice and combinations of the various plants, indicating the rules to follow to determine a chromatic harmony, in the temporal succession of the various months and seasons of the year. The colour of flowers and leaves, with contrasts, similarity, range, shades, but also size, shape, repetition, variety of landscape, symmetry and correspondences are the fundamental elements of his idea of a garden. His prescriptions are detailed, broad and precise from a botanical point of view too, with a competence that Chevreul had acquired working since 1804 in the Nicolas Buckwellin's Chemistry Laboratory at the Musée National d'Histoire Naturelle in Paris, of which he will be the director from 1864, after the employment at the Gobelins since 1824 (Marotta 1999).

Chevreul's way of thinking about the chromatic harmony of plants turns out to be a rich starting point for the history of art: he approached with an experimental method the representation of nature, which was usual for the time not only in painting but also as part of the recent expansion of private and public gardens (such as the Chamois and Bois de Boulogne parks in Paris). Gertrude Jekyll, a painter and gardener was already famous in the early 1900s for her borders directly inspired by Chevreul's theories. Her most significant innovation is the practice of the tonal theory of colours to informal ranges of plants: *'the creation of paintings with living plants'*. For the above-mentioned observation, the relationship between Monet and Chevreul about gardens still needs to be explored (Figure 2a).

## 2. Between Science and Art: Blanc, Seurat and the others

On the same themes and methods, I was able to deepen - in part - the developments in the close relationship between the theories of colour between science and art, especially between Seurat and Blanc. Founder of the *Gazette des Beaux-Arts*, historian and critic, first professor of Aesthetics and Art History at the College de France, Charles Blanc (Marotta 1999, Zimmermann 1989) is the author of a scientific treatise about optical phenomena (inspired by Chevreul's theory): *Grammaire des arts du dessin: Architecture, sculpture, peinture* (1876), with the attached model called "Rose of Colour" (Marotta 1999, which had an enormous influence (Song, 1984) also on Georges Seurat (Fénéon 1966, Herbert 1968, Furthermore, many of the works that the painter later read (not only those by Chevreul and D. P. G. Humbert de Superville) were mentioned by Blanc, while some principles for the analysis and experience of colour, light and shadow have been guided by Thomas Couture's ideas, set out in his most important text, *Methode et entretiens d'atelier* (Couture 1867). It is essential to remember how Blanc coherently interpreted traditional art (such as Eugène Delacroix's) through Chevreul's theories, an attitude shared by Seurat. He is a pioneer of Neo-Impressionism, but he also confronted with Post-Impressionism, Neo-Impressionism, Pointillism, a name rejected by the involved group (also called *pointillistes* or *confettistes*) who chose the term "divisionism". Up to Chiarism, Chromoluminism (and more). In particular, from the years 1880-1882 Seurat marked the transition from a *romantic* to a *scientific Impressionism*: by partly overcoming Chevreul's laws on accurate lighting and background shading, he thus realized a new stylistic phase. There is a

“technical” reason for it (Cullen 1983): in previous drawings (as with *Bathers*), George had observed that his method of lightening or darkening the background to surround an element of value through its opposite, creating halos or *auréoles* (theorized by Chevreul), was exalted in the reflections of the water (according to the observations already intuited by Goethe) (Marotta 1999). In the liquid substance, the contrast of the halos around the figures is noticeably clearer and brighter than in the grass.

As stated in the essential text already mentioned, Couture distinguished two ways in which painters treat colour. The first, used by a group he called “the colourists”, engaged in the harmony of colours with natural tones. The second, used by the “luminarists”, sacrificed the exact shade of nature to the magic of light: he considered Rembrandt as the “supreme luminary” and Veronese as the “supreme colourist” (Couture 1867, pp. 222-226). Signac (Figures 1c-2c) also contributed to lay the foundations of the new artistic expression (*Divisionism*), underlining the need for precise operations (to perceptually “divide” the colour before the material) based on luminosity and harmony: optical mixing of pure pigments (all the “prismatic” colours and their shades), the separation of the various elements (such as “local colour”, lighting colour, their optical reactions), the balance of these elements and their proportion according to the laws of contrast, degradation and irradiation. The developments of Seurat’s art concerning scientific culture (especially the part derived from Blanc) confirm the numerous principles that have become the theoretical basics of Neo-Impressionism: the distinction between shade and colour, the idea of optical mixing inducing on the retina vibrations obtained by combining different tones of the same colour.

In this sense, further confirmation came from another very participating theorist in the debate and in the studies of the protagonists of the time: the American Ogden Nicholas Rood with his work on *physiological optics, Modern chromatic*. He, too, argued that optical mixtures of coloured light rays, which were reflected from the pictorial surface and merged into the observer’s retina, would have been much superior in brightness to the effects obtained from the conventional, dull mixes of the palette. Actually, in Seurat’s painting, the rays of coloured light coming from each separate stroke or “dot” of coloured pigment were not intended to obtain optical mixtures of greater intensity than their original individual components. Nor were they destined to merge completely on the retina, because they were generally too far apart to do so: it was rather expected that by observing the painting at the right distance - calculated as three times the length of the diagonal of the paintings - the incomplete fusion of the individual brushstrokes would have generated a “vibrant” optical sensation (perception). This was because, as the influential Symbolist critic Félix Fénéon acutely observed in 1886 (confirming Goethe’s intuition, later taken up by Philipp Otto Runge), “the retina, which expects distinct groups of rays of light to act upon itself, perceives in very rapid alternation both the dissociated coloured elements and the resulting colour (optically A.D.)”.

That Seurat’s chromoluministic conception based on a profound sensitivity and optical knowledge is attested by Paul Signac too in the following description of the artist at work: “in front of the subject, George Seurat, before placing a touch of paint on a small flap of canvas, observes, compares, tries to glimpse the play of light and shadows, to perceive contrasts, distinguish reflections, fighting with the argument as he fights with nature; then he draws from the small columns of different pigments according to prismatic colours, different coloured elements constituting the tonality destined to best express the mystery that he has discovered. From observation to execution, from brushstroke to brushstroke, the painting is realized” (Figure 1d) (Cullen 1983).

A tool to translate chromatic theories for more specific applications is the one shown in figure 2a: a *Complementary Harmony palette*, published in 1889 by Ernest Victor Hareux (Hareux 1900)

conceived as a popular version of the typical Impressionist and Neo-Impressionist palette, confirmation of the expansion that these artists' ideas were reaching. The scarce space grant does not allow to report of a precise list of the individual colours.

A brief but significant methodological reflection, aiming at integrating other methodological approaches of a geometric-mathematical nature - beyond the one on the theories of colour - is necessary here. It should remember that George drew inspiration not only from numerous research on *physiological optics*, such as Rood's - already mentioned - but also from *Les phénomènes de la vision* by David Sutter, a critic from Geneva (Sutter 2018), intent on comparing mathematics and musicology. From the latter, a teacher of Aesthetics at the Ecole des Beaux-Arts from 1865 to 1870, attentive to the construction of figures according to precise geometric patterns, Seurat confirmed (after 1886) the tendency to systematize a visual project more attentive to the geometric composition of the whole and the spatial rendering, also according to the perspective principles (moreover already clearly participant in Blanc's treatise). This conviction reinforced Charles Henry's pseudo-scientific theories (Henry, 1889) based on the principles (fashionable at the time) inspired by the physiology of the nervous system (Maffei 2008). Based on this, in 1887 George conceived the work *La Parade*, (Figure 2b) with a strict geometric-mathematical structure (between cognition and unconscious) derived from the theories on Dynamogenicity by the scientist.

### 3. Previati and the Scientific Basics of Divisionism

The influence of Seurat and Signac on some Italian painters became evident in the First Triennial in 1891 in Milan. Led by Grubicy de Dragon, and codified later (in 1906) by Gaetano Previati in his *Principi scientifici del divisionismo (la tecnica della pittura)*: it is an emblematic title establishing and expressing the programmatic and not casual relationship between scientific way of thinking (also in the chromatic field) and expressions of art, in a relationship known and addressed in all its complexity.

Some painters - mainly in Northern Italy - experimented with these techniques at various levels: they combined Neo-Impressionism with Symbolism, creating paintings (not only realistic) using a divisionist method.

Previati designed his book as a broad and articulated review of critically presented treatises and Authors, in the concrete possibilities and application methods too, in an interdisciplinary dimension. In one of the first chapters, *La percezione normale dei colori* (p. 56) he talks about the importance of the perceptual whole: "Furthermore, to make a colour right and natural, it is not only the accuracy of its copy from life, as a separate colour, but how much the harmony of the adjacent colours contributes", underlining "the difficulty of arousing an aesthetic balance, completely independent by methodical considerations".

To give examples - among many others - about the brightness of colours, Previati compared Helmholtz (p. 187) to Bellotti (Bellotti 1886, p. 93) with Rood's "rotating discs", of which he punctually reported the values in percentage (pp. 211-212). Among the authors, he then cited Otto Runge and Chevreul, demonstrating a more attentive knowledge of Maxwell and Rood (p. 238).

Chevreul - he noted - used a circle divided into three equal parts by a triangle resulting from three rays by an angle of 120°. For each angle, he placed the typical red, yellow and blue of the solar spectrum and between these he introduced three intermediate shades, thus constituting the first circle of pure and intense colours to the maximum degree, then continuing the description with the "second circle". Keeping on with the comparisons, he stated that even Rungen (sic)"tried to solve this difficult problem, as the Chevreul's chromatic hemisphere (instrument of mediation between

Maxwell's triangle and Rood's one, an unsurpassed monument of the tenacious belief of the practical advantage of a systematic ordering of colours among scientists". But this means (it is still Gaetano's way of thinking) "it could not be a guide for the painter, if not when the knowledge about colours and the means to analyze them and those to reproduce them - as Rood opines - respond to a truly scientific classification and execution plan and it is not subject to any arbitrary ideas". The possibility of experimentation for the research of complementary colours is more optimistic with the application of the "rotating discs", or Maxwell's discs, based on the mixture obtained from the rotation of different colours.

#### 4. Conclusions

In chapter XII about *Divisionism* (p. 281), Previati arrives at first partial reflections: "The breakdown of colours tends to obtain luminous vibrations, as well as from the overall shade of the painting, from every single element with visible derivations from Mile's method, it is enlightened only in the *pointilliste*, to assume a definitive systematic character in Segantini's works, in particular in the great triptych *Vita, natura e morte*, a milestone of the glorious journey of art in the conquest of luminous objectivity, the goal of the breakdown of colours".

Previati concludes the argument thus: "as long as more detailed investigations into the priority of the practice of the breakdown of colours in painting will come from art historians, we must therefore reserve to Mile the possession of the hitherto unknown property of an unknown colouring substance, that is being able to reproduce the additions of light through a methodically minuscule separation of complementary colours, which today takes the name of divisionism in art.

These last words confirm how much comparative chromatic theories are an essential approach for a correct context of the birth and development of artistic movements, starting from Impressionism onwards. They constitute the *Fil Rouge* linking the protagonists of science and art of the chromatic culture of the time - by analogies or differences: as we have experienced and proved (authentic organic system to analyze and learn), they can enrich the culture of chromatic vision (understood as *Weltanschauung*, that is a complex and interdisciplinary vision of the world) which can still be full of new developments and reflections, in a renewed awareness.

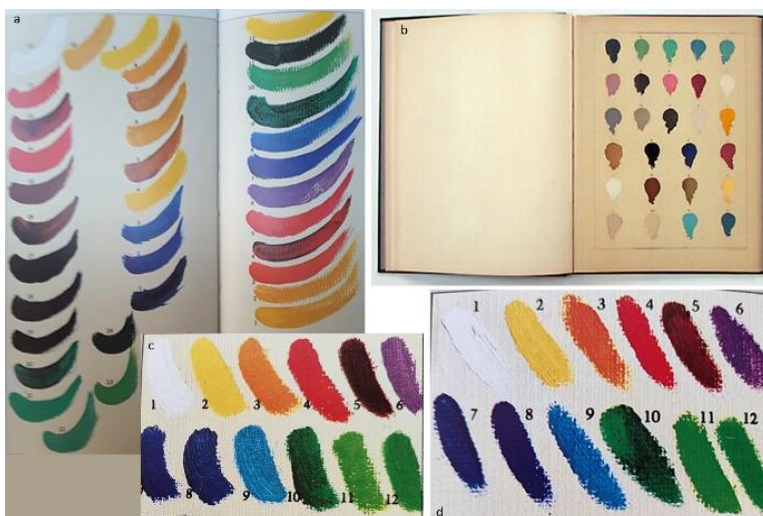

Figure. 1: Colour palettes: **a.** Hareux, *Palette of "complementary harmony"*, 1889; **b.** Hareux, *Le melange des couleurs*, 1889; **c.** Paul Signac, *"Prismatic" palette*; **d.** Georget Seurat, *Palette*.





Figure. 2: a. Claude Monet in the garden; b. George Seurat, *The circus*, 1891; c. Paul Signac, *La Salle à manger*, 1886/1887.

## REFERENCES

- Bellotti, G. 1886. *Luce e colori*. Milano: Edizioni Hoepli.
- Blanc, C. 1876. *Grammaire des arts du dessin: architecture, sculpture, peinture*. Librairie Renouard.
- Birren, F. 1965. *History of the color in painting*. New York: Van Nostrand Reinhold Company.
- Cage, J. 1987. *La tecnica di Seurat: una rivalutazione*. *The Art Bulletin* 69: 448-454.
- Couture, T. 1867. *Methode et entretiens d'atelier*. Paris: Typ. de L. Guérin.
- Cullen, A. 1983. *La tecnica degli Impressionisti*. Rusconi Libri.
- Fénéon, F. 1966. *Au-delà de l'impressionisme*. Paris: Hermann.
- Giorgi, G., and M. Rosati. 1928. *Sulla teoria dei colori*, in "Atti della R. Accademia Nazionale dei Lincei", Città di Castello, s. VI, (1928-29), 149-51.
- Guaita, L. 1905. *La scienza dei colori e la pittura*. Milan: Hoepli.
- Hareux, E. V. 1900. *Le mélange des couleurs enseigné par l'exemple: Leçons données sur les fac-similés des oeuvres et des palettes*. Paris: Librairie Renouard, Laurens éditeur.
- Henry, C. 1888. *Reporteur esthétique de Charles Henry: notice sur ses applications à l'art industriel, à l'histoire de l'art, à l'interprétation de la méthode graphique, en général à l'étude et à la rectification esthétiques de toutes forms*. Paris: G. Séguin.
- Herbert, R. 1968. *Neoimpressionismo*, New York: Solomon R. Guggenheim Foundation.
- Humbert de Superville, D. P. G. 1827. *Essai sur les signes inconditionnels dans Part*. Leyden.
- Kemp, M. 1994. *La scienza dell'arte: prospettiva e percezione visiva da Brunelleschi a Seurat*. Florence: Giunti.
- Marotta, A. 1999. *Policroma. Dalle teorie comparate al progetto del colore*. Turin: Celid.
- Previati, G. 2012. *Principi scientifici del divisionismo: la tecnica della pittura*. Florence: Nabu Press.
- Prieur-Duvernois, C. A. 1805. *Considerations sur les couleurs et sur plusieurs de leurs apparences singulières*.
- Rood, O. N. 1881. *Theorie Scientifique des couleurs*. Paris: Felix Alcan.
- Rood, O. N. 2009. *Modern Chromatics: With Applications to Art and Industry [1879]*. Cornell Univ. Library.
- Song, M. 1984. *Art Theories of Charles Blanc 1813-1882*. Ann Arbor: Mich., UMI reserach Press.
- Sutter, D. 2018. *Philosophie des Beaux-Arts Appliquée A la Peinture: Contenant l'Esthétique, Ses Applications, la Loi des Opposants Harmonieux des Couleurs Etc*. Forgotten Books.
- Zimmermann, M. E. 1989. *Seurat, Charles Blanc, and Naturalist Art Criticism.*, Vol. 14, No. 2.

# The building materials of Luis Barragán: light and colour

Cristiana Bartolomei <sup>1</sup>, Cecilia Mazzoli <sup>2</sup> and Caterina Morganti <sup>3,\*</sup>

<sup>1</sup> Alma Mater Studiorum University of Bologna; cristiana.bartolomei@unibo.it

<sup>2</sup> Alma Mater Studiorum University of Bologna; cecilia.mazzoli2@unibo.it

<sup>3</sup> Alma Mater Studiorum University of Bologna; caterina.morganti4@unibo.it

\* Corresponding author: caterina.morganti4@unibo.it

## Abstract

The aim of this contribution is to investigate the potential offered by a design approach in which light moulds matter and colours reveal the beauty of forms and spaces. In this context, Luis Barragán is certainly the one who, more than anyone else, has masterfully experimented with the use of colour to transform spaces. His architecture employs a language in which the daring use of colour is correlated with an ever-increasing degree of awareness, starting from the earliest conception and realisation. Light and colour do not only play an ornamental role but actually represent his building materials. The paper seeks to show how colour is able to strongly characterise architecture, through the analysis of some of his projects: the Casa Barragán in Calle Ramirez, (1947-48), the Capilla de las Capuchinas in Tlalpan (1952-1955), the Torres de Satélite (1958), the Los Clubes complex (1964-1969), and the Casa Gilardi (1975).

**Keywords:** *Light, colour, architecture, Mexico*

## INTRODUCTION

Colour in architecture contributes to a greater comprehension of the built environment and can be analysed from three possible perspectives: optical, psychic-expressive and symbolic-constructive.

All these components can be found in Luis Barragán's design approach. Colour, material and light are important elements of his architectural language and serve to give material qualities to walls and plasticity to spaces.

The architecture of Luis Barragán, which reveals a very strong chromatic and material component, is the result of a clear evolutionary path over time.

In fact, his architecture, originally inspired by Mexican vernacular architecture, later moved towards a more modernist style, then detached from it and finally arrived at a unique style in which light, colours and materials are the main protagonists.

Barragán masterly controlled light, showing a preference for direct filtered natural light, and loved the colours that came from his land and that we still find today in Mexican handicrafts and textiles: blue, pink, red, purple, yellow and green. The latter has actually never been used by him, because he left them to nature, as he liked to say.

Passionate about colour theory, influenced by Surrealist painting, his works can be equated with three-dimensional paintings, with planes and depths in warm or cool colours, made unique by the use of natural light. Barragán learned to control the behaviour of light in his works through observation during the construction of his works.

Once the colours had been decided, he commissioned a painter to apply the coloured paint to large sheets of cardboard, which were attached to the walls to be tinted. He would leave the coloured panel in the same position and observe it for several days, at different hours of the day.

Then he moved it to other positions or changed the colour until he was sufficiently convinced. Therefore, the choice of colours for Barragán took place during the construction phase and the walls were conceived as real canvases to be painted. The brick walls are never smooth but are always made of coarse textures of mortar of pebbles and gravel, allowing for irregular surfaces on which to apply the colour (João Durão, 2010).

### **LIGHT AND COLOUR IN THE BARRAGÁN'S ARCHITECTURE**

By examining some of his most significant projects from 1947 to 1975, it is possible to clearly illustrate the interaction between colour, light, space, and structure in the architecture of Barragán. The creative chromatic process adopted by the architect in his works is almost always by adjacency of colour. Only in his first and last projects, respectively Casa Barragán in Calle Ramirez and Casa Gilardi - which will be discussed later - it is also by colour contrast.

In all projects, however, the creative process is conducted according to a clear pattern of knowledge of colour theory. Casa Barragán in Calle Ramirez, built between 1947 and 1948, may be identified as the first work of Barragán's maturity in which he fully addressed the theme of colour, basing his colour choices on both adjacency and contrast theories. Indeed, the exterior walls of the roof garden, that were originally conceived entirely in white, were subsequently modified: first the colour of one wall was changed to orange in order to make the contrast with the colour of the paving evident; then two other walls were painted in pink, showing the architect's interest in colour adjacency (Figure 1).



Figure 1: Luis Barragán House and Studio in Mexico.

This interest is even more evident inside the house, where the walls bordering the staircase, originally intended to be white, turned pink and, at the top of the staircase, a panel in a warm colour between red and orange was installed (Figure 2, on the left). The house reflects the colours of popular architecture, of old convents in Mexico, and also of contemporary architecture. The space is conceived through the modulation of light with a system of pathways leading to very bright and semi-dark areas (Riggen Martínez, 1996). The entrance to the house is dominated by the blurred light produced by the yellow of the glass, which turns to a more intense yellow at the foyer, where the rays of light hit a golden surface and are reflected on the pink walls, creating a pale pink shadow on the white of the staircase. The colour yellow is present in many rooms and also in construction and decorative elements, because it is the colour that undoubtedly reflects most light (Figure 2, in the middle). The importance of the use of yellow also emerges in the design of the Cappella de las Madres Capuchinas

in Tlalpanm, built between 1952 and 1955. The architect's aim was to create an atmosphere of calm and spiritual meditation (Ambasz 1976). The chapel is not visible from the street and when you enter it through a courtyard you are surrounded by a yellow light that produces different shades of caramel yellow on the interior elements. The chapel is sober, with rough textures and intense ochre colours on walls and wooden floors. The Tlalpan Chapel is perhaps the most symbolic project in terms of its use of tone adjacency. In the Chapel, in an alcove to the left of the altar, an orange-red wooden crucifix is set against a wall of the same shade, so that in the absence of direct sunlight the crucifix seems to dissolve against this wall, whereas when light strikes the wall the crucifix seems to acquire consistency (Figure 2, on the right).



Figure 2: The stair of Luis Barragán House and Studio in Mexico (on the left); yellow in Luis Barragán House and Studio in Mexico (in the middle); Tlalpan Chapel in Mexico (on the right).

The external light source enters the chapel through a yellow stained-glass window, placed in continuity with a wall painted yellow, thus amplifying the tone (Figure 3, on the left). In addition to its high capacity for reflecting light and its symbolic representation of the sacredness and spirituality of the space, yellow was probably chosen by Barragán because it is the lightest colour in the spectrum, and therefore capable of conferring lightness and symbolising brightness. If for the Cappella de las Madres Capuchinas the adjacency of colour served precisely to sublimate a symbolic-constructive project, in the Satellite City Towers (today in blue, white, red, black, and yellow) Barragán shows his best representation of the technique of colour adjacency. In the original design of 1956, carried out with the artist Mathias Goeritz, the five towers were painted in typical Aztec colours with contrasting shades of cream, yellow, terracotta and blue. Following the painting work, which was carried out every two years - due to the strong Mexican sun, which fades colours very quickly - Barragán decided to abandon the contrasting colours in favour of colour matching. For this reason, the towers became red, red-orange and orange (Figure 3, on the right), as if to sanction that the yellow, cream and blue could be eliminated because the contrast in tone was ensured by the Mexican blue sky. Barragán's profound knowledge of colour theory is also documented in the Los Clubes project.

The Los Clubes complex is a ranch built between 1964 and 1969 for the Folke Egerstrom family in northern Mexico City. The ranch consists of several buildings with different functions - spaces for the family and spaces for horses - and Barragán plays on the relationship between warm and cool colours to distinguish the built elements from the natural ones.





Figure 3: Lights in Tlalpan Chapel in Mexico (on the left); Satellite City Towers in Mexico (on the right).

Casa Egerstrom is the building intended for the family, painted in cream colour, as if to remain neutral in relation to the spaces for horses in La Fuente de los Amantes and La Cuadra San Cristóbal. The latter are partially enclosed courtyards bordered by warm-coloured surfaces, with purple and pink walls contrasting with the cool colours of the surrounding nature. The use of coloured walls contrasts with the intense blue of the sky and the green of the trees and the ground (Riggen Martínez, 1996).

In the semi-open courtyard of La Fuente de los Amantes, depending on the point of view from which they are observed, it is possible to have very different perceptions of the relationship between colours: the statues and the fountain of neutral brick colour, with the pink wall and the green of the trees, show a juxtaposition of colours ranging from warm to cool or vice versa. In fact, the fountain and the statues, having a neutral colour, can appear either warm or cool depending on the background on which they stand. If the background is the pink wall, the statues appear cool because pink is warmer than brown; if they are observed from a viewpoint where the background is the sky and trees, they will appear warm (Figure 4). In Cuadra San Cristóbal, which is the main part of Los Clubes, Barragán also plays with this juxtaposition of elements characterised by shades of colour with different temperatures. Large pink walls, mediating between warm and cool colours, surround the courtyard on two sides and are joined by a small wall in warm purple (Bahamón and Álvarez 2010). In the centre stands the swimming pool with its orange-red fountain, which makes the pink colour of the walls cold but, if the complex is viewed from a viewpoint where it contrasts with the blue background of the sky, it becomes warm again (Figure 5). The contrast of colours is expressed very distinctly in one of the architect's last projects, that is the Casa Gilardi, built on a very narrow and deep lot of 10x36 metres. The house is divided into two blocks: a front block and a rear block. The front block, which faces the street and has three floors, is painted with the 'Mexican pink' colour, the colour of Jacaranda flowers. The single-storey rear block encloses the swimming pool area and serves as a dining room (Frances Dias and João Durão, 2014). The two blocks are connected by a corridor and the central patio, which are the core of the project. Although the corridor is white, the light coming from the vertical openings in the wall facing the patio, filtered by yellow opaque glass, makes it look like the yellow of the Madres Capuchinas Chapel. The entrance to the pool is announced by a red pillar and the wall in the background, together with the adjacent wall, is coloured blue.



Figure 4: La Fuente de los Amantes in Mexico.

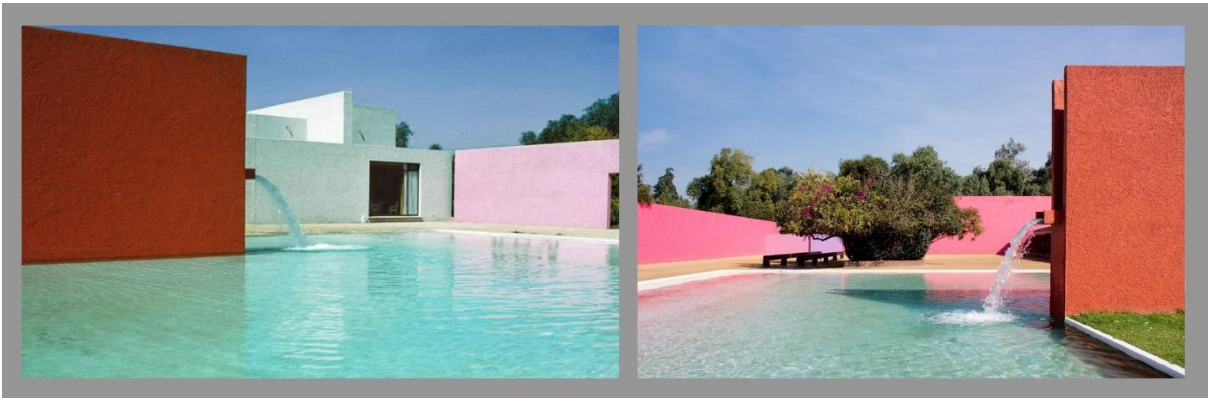

Figure 5: Cuadra San Cristóbal in Mexico.

The pool is pierced by light thanks to an opening in the ceiling that generates a suggestive play of light (Figure 6, on the left). We thus move from a monochromatic and directional space, consisting of a single plane of colour (the wall containing the openings with the coloured glass), to another which, on the contrary, uses colour to identify and dissociate a series of formal elements: the pillar, the blue-coloured corner, and the pool. At the point where the corridor begins, the interaction between yellow and blue is already visible. This interaction produces a more pronounced effect of depth because the blue - a cool colour - has a delayed spectral component, giving the sensation of being further away than it really is.

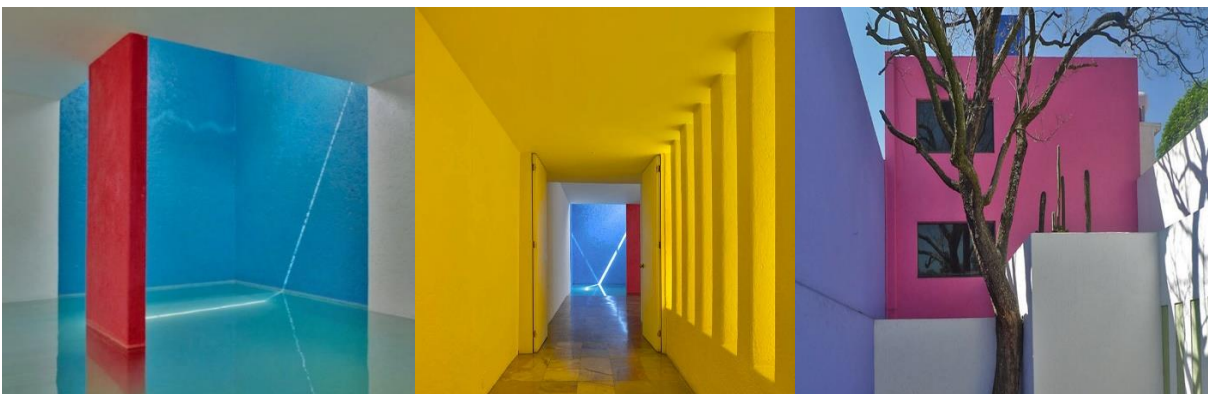

Figure 6: Pool in Casa Gilardi (Mexico) (on the left); Casa Gilardi (Mexico) (in the middle); Patio of Casa Gilardi (Mexico) (on the left).

In this chromatic choice, therefore, Barragán uses the triangle of the three primary colours - yellow, red, and blue - thus being able to reproduce and master the totality of the colours, controlling their tones to achieve chiaroscuro effects (Figure 6, in the middle). The patio of the house, on the side opposite the yellow corridor, has a large purple wall, while the adjacent wall is again Mexican pink, like the front block (Figure 6, on the right). Here, however, the architect opts for a chromatic choice which uses the complementary colour when contrasting the yellow with the purple and the analogous colour when combining the purple with the Mexican pink, thus creating an intense perceptual harmony (Pauly, 2008). The Casa Gilardi is undoubtedly the most significant building for expressing the power of colour in Barragán's architecture and his education: on the one hand, the pink and purple of the exterior façades are undoubtedly the result of the influence of Mexican vernacular architecture, while on the other, the colours chosen for the pool area contain references to the modernist period.

## **CONCLUSIONS**

The analysis of Barragán's works shows that the interaction between colour, light, space, and structure is the result of numerous studies and on-site experiments by the architect, which represented the only way for him to define the exact light, the final textures, the relationship between the dimensions, and the effects produced by volumes. The architect only chose colours when the space was already built, as he himself stated in his *Ensayos y apuntes para un bosquejo* of 1985: «Colour is a complement to architecture, it can be used to widen or enclose a space. It is also imperative for adding that touch of magic to an area. I use colour, but when I draw I don't think about it. I usually define it when the space is built.

Then I visit the place constantly at different time during the day and start to "imagine the colour", imagining the craziest and most incredible colours. I go back to my painting books, to the work of the Surrealists, especially De Chirico, Balthus, Magritte, Delvaux, and Chucho Reyes. I scroll through the pages, look at the pictures and paintings and suddenly identify some colours I had imagined and then select it». Therefore, light and colour become for Barragán the genesis of a strong emotional effect, but also a means of enhancing the plasticity and dynamism of the built environment (Itten, 1974).

## **REFERENCES**

- Ambasz, E. 1976. *The architecture of Luis Barragan. Exhibition catalogue*. New York: Museum of Modern Art.
- Bahamón, A., and A. M. Álvarez. 2010. *Luz color sonido: efectos sensoriales en la arquitectura contemporánea*. Barcelona: Parramón Ediciones.
- Frances Dias, S. and M. João Durão. 2014. Significance And Creation: Emotion And The Primacy Of Colour In Art (Architecture And Painting). In: *Proceedings of AIC 2014 Interim Meeting Color, culture and identity: past, present and future*, G. Ortiz Hernández, ed. Oaxaca: AMEXINC, 74-92.
- Itten, J. 1974. *The Art of Color: The Subjective Experience and Objective Rationale of Color*. Hoboken: John Wiley & Sons.
- João Durão, M. 2010. Colour as Pathway of Light: Searching the Shadow in Luis Barragán. *JAIC - Journal of the International Colour Association Colour: Design & Creativity* 5: 1-15.
- Pauly, D. 2008. *Barragán: Space and Shadow, Walls and Colour*. Basel: Birkhäuser.
- Riggen Martínez, A. 1996. *Luis Barragán: Mexico's Modern Master, 1902-1988*. New York: The Monacelli Press.
- Riggen Martínez, A. 1996. *Luis Barragán: 1902-1988*. Milano: Electa.

# Tili Wiru Tjuta Nyakutjaku:\* Towards an Extensive Cultural Paradigm

Joaquim Santos <sup>1,\*</sup>

<sup>1</sup> Universidade Lusíada de Lisboa. Faculdade de Arquitectura e Artes

CITAD - Centro de Investigação em Território Arquitectura e Design;marcelino.c.santos@gmail.com

\* Corresponding author: marcelino.c.santos@gmail.com

## Abstract

“Looking at lots of beautiful lights”\* may take us to experience infinity because they are thousands, because they are light and colour and infinite stars twinkle above us. We are especially focused on the perceptual world we live in, the world of experiences and affection. Although, humankind also has a deep desire for the invisible. Finite and infinity seem to meet and construct the realm of experiences, of knowledge and beliefs. However, it seems infinity is difficult to become acquainted with and difficult to represent. Infinity challenges philosophy and art, and especially painting. Also, mathematical experience implies that there are infinite types of infinity which automatically makes a comprehensive pictorial experience impossible in a finite length of time. However, Bruce Munro and Tiepolo as well as Australian aboriginal art may takes us to a *cosmos* where colour and infinity meet. Dream time stories embody the material, the immaterial as well as finitude and infinity.

**Keywords:** *Colour, light, infinity, art, culture*

## INTRODUCTION: BEYOND THE WORLD WE FASHION

Infinity seems too opposed to sensory experience because we experience finite material things which have forms, shapes and colours. Besides, combining things with infinity may not seem reliable. Infinity? An object? A place? A Thing? A number? Something so big that turns out to be impossible to be perceived within a finite lapse of time and therefore we can never perceive whatever infinity is made of. Actually, being a thing implies some kind of boundary and therefore we cannot even imagine such an infinite thing because it fails both in sensory terms as well as in logic. All together it sounds senseless in phenomenological terms as well as in art representation. An image of what, we can ask. Sensing what? Some unseen construction that cannot even be a thing? But we seem to enjoy speaking of infinite colours! Do we actually know what we are speaking about? Do we talk about what we can conceive and not yet sense?

### Infinity, construction and imagination

In the long-term different ideas mingle from different sources. It is hard to determine what idea of infinity the Greeks had, and it is most likely that they had none. Distinguishing the huge from infinity might not be a necessity unless questions of mathematics and logic had come to a point where we must place attention on new problems. We may or we may not read the 23rd definition of Euclid as acquaintance with infinity. Parallel lines meet at infinite distance; Sjöstedt (1968: 15, 17, 39-43, 53-55).

But there is also another experience beyond sense experience. We assume that we see those parallel lines, here and now given by our sensory experience and we assume that the same happens somewhere beyond our vision, beyond our bodily experience. There seems to be something alive beyond the horizon of events. The realm of imagination is by no means smaller than the sensory world and it seems able to settle roles beyond the realm of direct sense experiences and returns back to its own flesh and bone.

Thus, to speak of infinity in the realm of finite things and experience of those things reveals some sense. In their own right, Merleau-Ponty makes a criticism of metaphysical infinity and Sartre critiques imagination. Territory of imagination and human freedom seem to mingle and extend our senses and, insofar as consciousness is the working territory of being, the image and construction of an image may not be disclosed to one another. And the artwork can be the ultimate creation that is expressed by images.

### **Between experience and metaphysics**

Perceiving a thing might not be quantifiable, but, perhaps, we can say that the sense of finitude gives the perceived a sense and completeness equivalent to that of quantification, a thing-ness that bounds our acquaintance with the material world of things as such. And colour is a quality that contributes to such quantification.

But time, by allowing the perception of the same thing more than once and different things one after the other, gives a notion of repetition, eventually *ad infinitum*, and creates a sense of *past-present-future*. As far as these things and events in which we perceive things might be represented by numbers such as natural numbers (integers) we may fall into the perception of a type of mathematical infinity which departs from finite things. We may not need to start acquaintance with some type of mathematical infinity by being acquainted with rational, or irrational quantities.

Perhaps, we can then assume that acquaintance with metaphysical infinity of some kind might not need such a complex mathematical basis, but just a primary sense of existence beyond the here and now, which is experienced by my body as a thing among things. That is, a construction beyond my sense experience. Nonetheless, there seems to be a sense of completeness, of *continuum*, given by a growing sense of events that happen one after the other that, if represented by numbers, may take us to an initial perception of mathematical infinity that is, by these means, a construction that may have some echo on our existential sense of being.

### **The unity of science and the unity of nature**

“The issue is not science but the nature of the world”; Trigg (2015: 119). Unity of science and unity of nature are two different things where upon the former represents the latter to some extent; Amsterdamski (1975: 150-151). As a created thing, science aims to have a system of permanent rules that make it understandable. Furthermore, taking physics as using mathematical tools, we have combined two different worlds that may combine into an *imago mundi* that must absorb properties of those worlds; Cohen et al. (1934: 352-362). Probably, one of the most important achievements of phenomenology was to drive our attention simultaneously to the world and to us and thus settle us on the origins of knowledge and imagination as well as on the ontological nature of knowledge and imagination; Bronowski (1979: 10, 14-15, 118).

The acceptance that there might not be a world out there apart and independent of us, in which even our sophisticated technologies are nothing, by way of extending our senses and of determining what is actually important to us, opens the way to metaphysical reasoning despite the growing intolerance regarding this realm “beyond” reality. Indeed, as Roger Trigg explains the growth and success of science, “This does not result from any discovery but from the interpretation of discoveries. Decisions about the reducibility or otherwise of levels of explanation is an intrinsically metaphysical decision.” (Trigg 2015: 120).

### **Finitude: the cloudy stormy sky hanging over the eidetic reduction**

Sensory experience opens doors through which we enter the world, and the world enters us, but the eidetic reduction seems to close down a wide-ranging set of possibilities to the essence of a thing, of being a thing despite all connections that the thing might have in relation to the world and to us. In some sense, eidetic reduction tends to finitude. Following Merleau-Ponty lines, we do not perceive blue, nor yellow, but the blue on that wall, the yellow of that flower. There is a sense of finitude even in time and the thing-ness bounds the materiality of being a thing except, perhaps, for the principle that human metaphysical infinity might have in perception by constructing the *thing-in-me-to-myself*.

However, Merleau-Ponty (1960: 179-187) and A. W. Moore (1990: 226-233) disagree on human metaphysical infinity, the latter assuming that our finite life determines a metaphysical finitude. In any case, infinity seems hard to perceive and to conceive and we may think of a sense of infinity given to us either by direct experience of space and time or by intellectual construction. That distant place where everything may exist including nothing, seems hard to determine where it is. Imagination extends human senses perhaps to infinity and a vast land where we may look around for miles and may be a vehicle to intellectual and artistic constructions that may take us a bit closer to infinity.

In the realm of sense experience, we may say that experiencing Uluru and the desert of the central Australian outback is an experience of infinity or, at least is an experience that relates to both a sense of *geometrico-mathematization* of infinity and metaphysical infinity.

### **Aesthetic experience: the natural world and the art work**

Aesthetic experiences of the natural world and of the artwork meet magically under some circumstances where the artist can determine and invite us to participate. This seems to be the case with “Looking at lots of beautiful lights”. A whole engaged experience in Central Australia given by an infinite desert landscape and 50.000 lights and an infinite time-directed experience in both directions past and future. Nonetheless, we may think of hyperbolic perceptual space as creating a sense of finitude giving a measurable order to the space we live in and experience directly, apart from metaphysical assumptions; Heelan (1983: 98-128).

Perceptual experiences of the daily sky give a sense of the blue being a background to the sun at a finite distance despite the fact that the sun is remarkably far away from that blue; Heelan (1983: 92-97). And the star light spots seem to all be at a similar distance in a black canvas being smaller or larger. The idea that different light sizes are given by distance – many spots are galaxies – is an image given by astronomic inquiry. But millions of years of human evolution has resulted in sense experiences being developed in another way.

Indeed, survival depends on an entirety that exists at finite measurable steps, days, weeks, or seasons. Thus, acquaintance with infinity might not be a basic need for humankind. Perhaps that explains difficulties in figuring out what infinity is and how to represent it if needed. What we can realize points us to the direction of sense experience of finitude even if we can ascribe infinity to that finitude. Representations of deities and God rely on the figurative rather than the abstract. Even the medieval concept of *lux continua* and *lux mirabilis* is materialized through colourful glazed windows in cathedrals. God as light needs to be tangible and that implies finitude; Norberg-Schulz (1993: 98).

### **Natural and artificial colours mingle at the core of the aesthetic experience**

Changing natural colours at dawn and the soft rise of pure artificial colour will mingle with the upper sky of the Great Emu. Infinite variation of colour poses a huge word challenge if one has to describe simple things that acquaintance makes clear. Digital camera capture may be a way to communicate a visual method of describing that phenomenology may accept when challenges to ground complex



human activity arise. The artwork – the light field installation – provides us with references and strategies regarding colour in a way that any other object or method may convey. In this sense, the field of light describes heavens and makes land blossom and is also an artwork and, simultaneously, stimulates us to feel and think within a context of the infinity that surrounds that experience.

Natural colours *versus* artificial colours as well as colour systems and acquaintance with colours require deep reflection which must include a criticism about finitude *versus* infinity and art *versus* science. Metaphysical infinity seems to engage the rational, the sensory, the spiritual, acquaintance with the working forces of nature and what they display in relation to our bodily material life, but also with art creation and aesthetic experience. We may then expect some expression in art and colour.



Figures 1, 2: Uluru and *Tili Wiru Tjuta Nyakutjaku*. In acknowledgement of all First Nations Peoples of Australia, past, present and future and their connection to Lands, Waters and Cultures. ©Joaquim Santos

### **The long lasting colours of Uluru**

“The 50,000 year-old Aboriginal cultures are believed to be the oldest continuous cultures in the world. Since the night sky seems to play an important role in them, it is sometimes said that they include the earliest traces of astronomy”; Norris et al. (2009: 2). Without written records, the characteristic oral wisdom was selectively transmitted only to the initiated and still is that which makes important cultural aspects of knowledge inaccessible to a wider public. The rock carvings incorporate the ochre that was widely used, including in body painting and carries out a geological time of great magnitude that engages land, people and their expressions.

“Each Aboriginal person’s totem and conception site or Dreaming is determined by the place in the Landscape where the mother experiences her first symptoms of pregnancy. At this place, the unborn fetus is animated by the spirit of a totemic ancestor – water, possum, goanna, old man – which he will be reunited with at death, in the land.”; Bardon (1991: x). Thus, life cycles embody and combine land and all living creatures. There is, we can say, a sophisticated metaphysical construction that is revealed by art and oral tradition. The magnitude of space and of time is vast. Perhaps we may connect with infinity more comprehensively and more deeply than the one we may see in the geometrico-mathematization of the 23<sup>rd</sup> definition of Euclid’s Elements. The ochres themselves, are pure material-colours and embody a sense of journey in relation to infinity as there is a sense to be given to us, such as the light of sun, of moon, of stars.

Just as we question unity of science and nature we may question art. Jonathan Webber makes clear that “Etchings, woodcuts, caricatures and schematic line drawings may have very little in common with the things they depict, and may differ from them in a great many respects. A depiction need share neither shape, nor colour, nor texture, it seems, with the thing it depicts.”; Sartre (2004: xv). The

argument regarding Australian Aboriginal culture and sense of infinity may be difficult to inquire, not because it might not be there, but because our conception of infinity comes from a western, classical tradition.

In western art infinity seems to be expressed by a double manifold. We have figurative representations of God, Christ and the Holy Spirit and infinity would belong to their meta existence, beyond creation of material things such as us mortals. On the other hand, we have geometry, either given by geometrico-mathematical concepts, or by representation by perspective created after Alhazen's (965-1038) schemata on optics and perception; Nagel (1979: 253-276). Thus, pictorial representation of perspective may express infinity which means that, from its outset, it may need no colour, or, either, colour had to follow colour-free alien rules to be framed into pictorial expression regarding depth that could eventually be explored into infinity.

### **Tiepolo, colour, infinity**

A problem posed by perspective is the superimposition of a geometric diagram onto canvas which, unlike natural perspective is a *quantum continuum*; Panofsky (1997: 30-31). And this is how it began from the Renaissance onward. However, we can find devices in representation that suggest that the artist would be acquainted with this problem and had been innovative in solving it. This system was also limited regarding representation of infinity which came alive during the Baroque when Newton's gravitational laws implied a sense of existence beyond our site. No longer the parallel lines, but the cosmological laws needed the same approach of combining rationality and imagination into a complex *imago mundi*.

Unlike Raphael's architectural based pictorial space, whose depth relies on geometry and direction of light through the scene, Tiepolo's depth became more complex by combining a sense of natural and artificial perspective into a new spatio-temporal atmosphere. At the Kaisersaal, Residenz, Würzburg, Tiepolo's the trompe-l'oeil fresco "The Investiture of Bishop Herold as Duke of Franconia" (1752), constructs an intense and continuous spatio-temporal cosmos from the place where we stand into the foreground of the scene, into the background, into infinity; Krückmann (1996: 67-81). Colour is the device that orders the depth of space and colour defines where perspective given by architectural representation takes place. Also, natural elements, the tree, clouds and flying birds inform about unknown distances. Space does not converge at a centre as Raphael would create. And it is colour free from the earlier concept of form as contour that created infinity which, inclusively does not have an axial suggestion as André Le Notre would create.

### **The triumph of colour and infinity – a conclusion**

The problem of finitude versus infinity may not seem related to colour and yet we can believe that it is a phenomenon that exists between experience and metaphysics and has expressions in mathematics, physics, theology and in the image of deities, psychology and our awareness of ourselves and, last but not least in art. In all those fields we confront the problem of representation and analysis of what can be commensurable, or, either is incommensurable. In art and especially in painting this problem seems difficult to be acquainted with and expressed because the representation of what is incommensurable goes far beyond the material limits of the pictorial space.

We may be happy that colour systems may give us a sense in infinity concerning chroma, hue and value variations, but this type of infinity seems little compared with what colour can provide in expression regarding finitude versus infinity. And this expression of colour may take us to the extensive cultural paradigm of the individual and of the human group. Thus, there is an extensive cultural



paradigm of each individual, of the artist, and also an extensive cultural paradigm of the group that combines all of them. The existential discourse of Merleau-Ponty on metaphysical infinity may be a way by which we can meet incommensurability in human existence and find grounds to understand how science and art settle in human creation.

## ACKNOWLEDGEMENTS



This work is financed by national funds by FCT Foundation for Science and Technology, under the Project UIDB/04026/2020.

## REFERENCES

- Amsterdamski, S. 1975. *Between Experience and Metaphysics. Philosophical Problems of the Evolution of Science*. Boston: D. Reidel Publishing Company.
- Bardon, G. 1991. *Papunya Tula. Art of the Western Desert*. Victoria: Penguin Books.
- Bronowski, J. 1979. *The Origins of Knowledge and Imagination*. London: Yale University Pr.
- Cohen, R. Morris, and Nagel, Ernest. 1934. *An Introduction to Logic and Scientific Method*. New York: Harcourt, Brace & World, Inc.
- Heelan, P. A. 1988. *Space-Perception and the Philosophy of Science*. Berkeley: University of California Press.
- Huyghe, R. (ed.). 1968. *Larousse Encyclopedia of Renaissance and Baroque Art*. Middlesex, UK: The Hamlyn Publishing Group.
- Isaacs, J. 2000. *Australian Dreaming. 40,000 Years of Aboriginal History*. Sydney, Australia: Lansdowne Publishing Pty Ltd.
- Krückmann, P. O. 1996. *Heaven on Earth, Tiepolo Masterpieces of the Würzburg Years*. Munich: Prestel-Verlag.
- Merleau-Ponty, M. 1960. *Éloge de la philosophie*. Paris: Éditions Gallimard.
- Moore, A. W. 1990. *The Infinite*. New York: Routledge.
- Nagel, E. 1979. *The Structure of Science. Problems in the Logic of Scientific Explanation*. Indianapolis: Hackett Publishing Company.
- Norberg-Schulz, C. 1993. *Meaning in Western Architecture*. New York: Rizzoli Int. Pub. Inc.
- Norris, Cilla, and Norris, Ray. 2009. *Emu Dreaming. An Introduction to Australian Aboriginal Astronomy*. Sydney, Australia: Emu Dreaming.
- Panofsky, E. 1997. *Perspective as Symbolic Form*. New York: Zone Books.
- Sartre, J.-P. 2010. *The Imaginary. A phenomenological psychology of the imagination*. New York: Routledge.
- Sjöstedt, C. E. 1968. *Le Axiome de Paralleles. De Euclides a Hilbert. Un Probleme Cardinal in le Evolution del Geometrie. Introduction e commentarie de C. E. Sjöstedt*. Lund: Interlingue-Fundation, Uppsala and Bokförlaget Natur och Kultur, Stockholm.
- Trigg, R. 2015. *Beyond Matter. Why Science Needs Metaphysics*. West Conshohocken, PA: Templeton Press.

# System for Visual Assessment of Wine Color

Mark D. Fairchild<sup>1,\*</sup>

<sup>1</sup> Program of Color Science / Munsell Color Science Laboratory, Rochester Institute of Technology, Rochester, NY USA; mdfpph@rit.edu

\* Corresponding author: mdfpph@rit.edu

## Abstract

This paper presents a color chart explicitly designed for the color assessment of wines as a part of a more comprehensive hedonistic or analytical tasting systems. The chart is based on visual, colorimetric, and *in situ* evaluations of existent wine color and the techniques for its assessment in wine tasting. The system is specified in Munsell coordinates and corresponding sRGB values. Its derivation and use is described and a photographic-based system for measurement-based implementation of the system is also introduced.

**Keywords:** *Wine Color, Visual Assessment, Standard System, Reference Color Chart*

## INTRODUCTION

Color perception is an integral part of the enjoyment of foods and beverages. Consumables with outstanding aromas and flavors often cannot overcome a negative first impression, based on visual perception, to be thoroughly enjoyed. The significant impact of visual perception on the overall perceived quality of wine is well recognized and systematic processes for sensory wine analysis usually start with an assessment of color and other visual attributes. In his book on *neuroenology*, Shepard (2016) explains that all wine descriptive language is organized around prototypical wine types and that sensory properties are not separately analyzed, but rather compared collectively with cognitive associations of wine color, aroma, and taste to recall words previously used to describe the same category of wine. Color takes on a primary role in this process because it is normally among the first perceptions of a wine sample. Additionally, it has been observed that color is, in fact, the only common category among expert tasters. In other words, color is likely the only independent perception of the wine and it is relied upon heavily to stoke the memories of the category of wine, which then helps generate appropriate words to describe the other sensory attributes for that particular category.

Unfortunately, the color descriptors used in wine analysis are often unclear and confusing to experts and novices alike. For example, the Court of Master Sommeliers (2017) uses terms such as water-white, straw, yellow, gold, purple, ruby, and garnet while the Wine and Spirits Education Trust (WSET, 2019, 2016) suggests lemon-green, lemon, gold, amber, brown, pink, salmon, orange, purple, ruby, garnet, and tawny in their level 2 and level 3 assessment systems. Many of these terms are ambiguous at best and some are not color names at all. For example, lemon, straw, and even garnet evoke different color perceptions in various observers. Additionally, lightness and saturation dimensions are often ignored or somehow combined into pale, medium, and deep descriptors of terms defined as either concentration or intensity.

This paper introduces a new system to describe wine color with the objectives of being based on sound color science, being made up of unequivocal color terms, and being simple to explain and use. The hope is that such a system might help bring more consistency to sensory analysis of wine and better quantify the relationships between color, expectations, and flavor. The system was developed through a systematic analysis of wine colors in the CIELAB space that indicated that wine colors tend to follow a single path through the color space as they vary in hue, lightness, and saturation simultaneously. Taking hue as the most important dimension, it becomes clear that the remainder of the variation can be explained with saturation (which also correlates well with lightness changes as suggested by the traditional terms of intensity or concentration). Once the path of wine colors through

color space was understood, representative samples were created as visual reference points for a scaling system. These reference points were ultimately specified systematically using the Munsell system and secondarily specified in sRGB coordinates.

The system is based on scaling the primary hue as either yellow, orange, or red and then a secondary hue as either green or orange for the yellow primary hue, yellow or red for the orange primary hue, and orange or purple for the red primary hue. Once the hue is established the saturation (or depth) of the color is then specified on a three point scale (low, medium, high) that is also represented with reference color samples. The system is embodied both as a reference color chart and as part of a systematic wine assessment grid. This paper will present the derivation of the system, its specification and embodiment, and a photographic system designed to allow automated specification of wine colors in addition to visual assessment.

### **THE COLORS OF WINE**

The colors in wine are produced in complex and not fully understood ways. The main colorants in white wines are flavonoids that are responsible for coloration in many plants, while red wine colors are largely produced by anthocyanins, a particular class of flavonoids. However the exact colors in a given sample of wine depend on the grape variety, enological practices such as skin contact and other extraction techniques, other chemical constituents in the wine, wine pH, age, storage conditions, and ultimately the viewing or measurement techniques. Boulton (2001) provides an excellent review of many of the variables involved. In addition, Fairchild (2018) reviewed the colorimetry of wine and the important and significant influence of illumination color on the perception of wine. Unfortunately, illumination is often completely ignored in even sophisticated wine evaluation protocols, judging, and competition and this can result in wide ranging color assessments and conclusions for the same wine. For example, two extremely experienced sommeliers evaluated the same wine as “deep purple” and “garnet” (orangish-red). Careful analysis of the wine indicated that it was simply “red” with no hints of purple or orange. The large discrepancy results in very different interpretations of the wine and is likely caused by differences in illumination, but individual differences in color vision can also contribute.

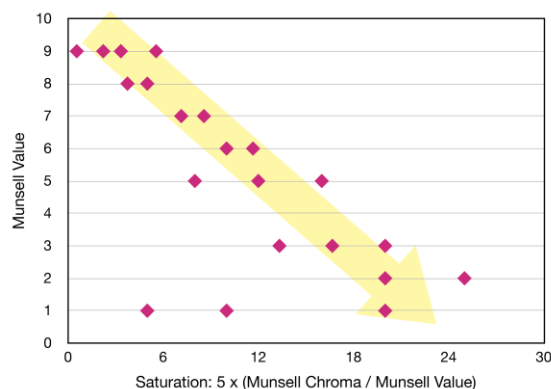

Figure 1: Munsell Value and saturation (computed as 5 times Munsell Chroma divided by Munsell Value) for the wine color reproductions rendered in the Color of Wine poster.

An exhaustive colorimetric evaluation of wine colors is prohibitive in both cost and time. To get an initial sense of the color ranges found in wine, the author referred to three sources. The first was a collection of tasting notes in which a wide variety of wines were analytically evaluated over a long time period. The other two are widely distributed posters that have been carefully designed and colored to represent the range of wine colors. In essence these represent “color order systems” for wine. The

Bouchard Aîné & Fils (undated) example illustrates a range of 74 wine samples and the Wine Folly (2019) chart includes 36 samples. Neither should be considered accurate colorimetric samples of wine, but both have been carefully visually assessed for accuracy and are representative of normal wine colors. The colors of the 36 samples from the Wine Folly chart are plotted in Munsell coordinates in Figure 1. It is clear from Figure 1 that most wine colors follow a one-dimensional path through the value-saturation space in which low value is correlated with high saturation. This agrees with visual assessment of real wine samples and indicates that a full three-dimensional color space need not be sampled to produce an effective representation of wine color. Instead, all that is needed is first a classification of hue, from greenish-yellow, through orange, to purplish-red followed by a second dimension representing the depth of color, which is the combined variation of lightness (value) and saturation represented in Figure 1.

### **DEVELOPMENT OF A WINE COLOR REFERENCE CHART**

The wine reference chart was developed by selecting Munsell samples representative of the the three main wine hues, yellow, orange, and red and then variants of those in the directions of green and orange for yellow, yellow and red for orange, and orange and purple for red. These “medium-depth” samples are represented as the middle strip of colors in Figure 2. Then samples for more (deep) or less (light) depth were selected for the main primary hues. These are represented to the immediate left and right of the main strip of color samples. Figure 2 includes three copies of the chart. One labeled with color names, one unlabeled, and one labeled with Munsell designations.



Figure 2: The representative samples from the proposed wine color reference chart on a light gray background. The set on the left includes descriptive color names for white (yellow), orange, and red wines and the set on the right includes the nominal Munsell designations of the reference samples.

The chart itself is not necessary once the simple process of naming wine color by primary hue (yellow, orange, red), secondary hue (green, yellow, orange, purple), and depth (light, medium, deep) is understood. However, wine color can also be scaled directly relative to the chart using the form illustrated in Figure 3. The Munsell samples on a light gray background are used on the left side of the chart while a uniform white area is used as a background to the wine glass on the right. Wine samples should be viewed in a tasting glass tilted toward the observer such that the thinnest part of the wine sample can be viewed directly rather than through the top glass surface if possible. Illumination should be natural daylight or a high quality daylight simulator (*e.g.* color rendering index of 95 or greater) at

an illuminance level on the order of 1000 lux. Observations are recorded by first naming the primary hue present in the sample: Yellow, Orange, or Red. Then if any secondary hue is present (e.g. Orange or Purple for red wines), it is also named. Thus wine hue is recorded as a one- or two-word simple hue name as illustrated in Figure 2. Lastly, a decision is made on whether the color depth in the wine is light, medium, or deep. Ultimately, these categorizations result in a simple set of 27 color categories for wine samples. While intermediate points could be used for more precision, even the most highly trained wine evaluators cannot consistently name wine colors with precision exceeding these 27 points, often not even agreeing on hue. In addition, color variation in wine is sometimes important. In such cases, this scaling procedure can be used separately for the body of the wine and the edge of the sample (known as rim variation and often recorded as a separate color).

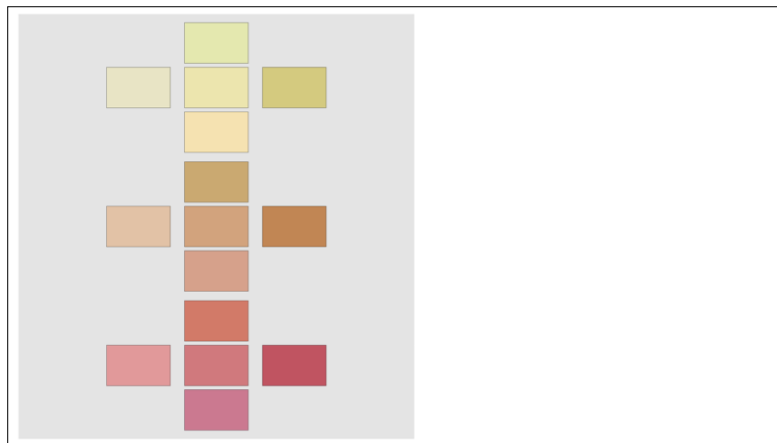

Figure 3: The wine color reference chart as it should be used with the samples on the left side of a page on a light gray background and a blank white area to the right over which the wine samples can be viewed *in situ*.

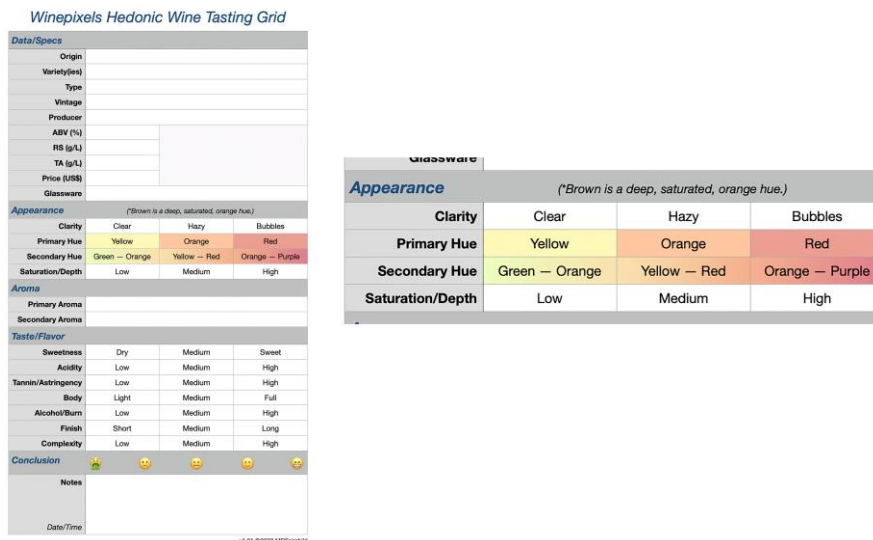

Figure 4: An example of a custom wine-tasting grid that includes the proposed system for wine-color specification (zoomed on the right).

Figure 4 illustrates this wine color naming system incorporated into a full, customized hedonic (rather than analytical) wine tasting grid. Tasters can simply circle their responses for the clarity, primary hue, secondary hue, and saturation/depth of the wine. This system is far easier for tasters, especially those with little training in wine tasting systems, to make consistent, repeatable, and

understandable color assessments of their wines. Thus, simply put, such a color naming system is more useful than the non-intuitive systems used by experts that require training and use non-color terms to scale color appearance (thus requiring consensus definitions). This system should also be easily translatable into other languages.

### **IMAGING-BASED SYSTEM IMPLEMENTATION**

While the wine color chart was designed for use as a visual reference for direct comparison or through memory matching, it would also be desirable to design and implement an image-based measurement system that could be used to photograph wine samples and then assign them to one of the 27 categories. As such, a photographic system was designed, implemented and tested. This is a non-trivial task as the accurate hue-reproduction of wine photographs is known to be notoriously difficult. This is due to the observer-metameric properties of wine spectral reflectance/transmittance distributions, variations in illumination color and spectra, and variations in camera color responsivities relative to one another and relative to human observers. Nonetheless, the challenge was taken.

The system was constructed using a special holder for ISO tasting glasses such that they could be photographed from above while tilted at a significant angle with a consistent volume of wine. This simulates visual wine assessment and allows various wine thicknesses to be simultaneously imaged. The samples were illuminated from the two sides using LumeCube 2.0 professional lighting systems (5600K daylight at approximately 1500 lux). Images were collected with a dedicated Nikon D5100 DSLR built into the copy-stand system. Raw images were collected and then white balanced and linearized using an X-Rite ColorChecker Passport system and Adobe Photoshop. Images were then converted to calibrated sRGB values. A set of eight wines, white, orange, and red, were used to calibrate the system.

Figure 5 shows one example image from the system. As illustrated on the right side of Figure 5, a fixed circular area near the rim of the wine outside any surface reflections was selected, averaged, and sampled to provide a single representative color signal for indexing into the standard system. A simple linear model (sRGB in the image to sRGB in the chart) applied on R, G, and B, independently was used to correct the samples. Figure 6 illustrates the typical results for the worst case (Pinot Noir) and a typical case (Zinfandel). These predictions are just barely good enough to index into the system with digital value errors typically less than 10 out of 256. However it is clear that the metameric properties of the wine samples results in a typical hue shift (toward orange for red wines) in the photographs. This can be corrected with a more sophisticated color correction algorithm that has showed good promise in producing accurate renderings and will be the subject of a future paper.



Figure 5: Examples of a wine sample in an ISO taster glass photographed in a calibrated illumination system. The right image shows the sampled area that was averaged to create an automated classification system (and also provides a nice example of simultaneous contrast; the circular area is physically uniform).



Figure 6: Examples of the worst (Pinot Noir) and typical (Zinfandel) automated classification of the wine samples.

## CONCLUSIONS

The careful and consistent observation and recording of wine color is known to be critical for both analytical and hedonistic wine tasting, review, and judging. Historically the systems for recording wine color appearance are very imprecise, use non-color terminology, and are implemented in substandard and uncontrolled viewing conditions. This paper has introduced a simple, easy to use, intuitive, precise, accurate, and easily communicated wine color specification system along with a standard chart for reference purposes. It is hoped that such a system can bring clarity and consistency to the all-important judgement of wine color by wine lovers, enthusiasts, experts, and professionals alike and ultimately increase the enjoyment of wine while facilitating perceptual observation of the the other dimensions of aroma, flavor, and taste. In addition the first steps toward automating the system photographically were introduced as a work in progress.

## ACKNOWLEDGEMENTS

This work was supported by the RIT Munsell Color Science Laboratory. The author thanks his many instructors in the world of wine analysis and winemaking, especially Lorraine Hems of the RIT Department of International Hospitality and Service Innovation who has been a true inspiration.

## REFERENCES

- Bouchard Aîné & Fils. (undated). Les Couleurs duVin. Online: [https://www.bouchard-aine.fr/en/e-shop.r-355/our-wine-posters.r-109/les-couleurs-du-vin.p-10.html?valid\\_legal=1#.YN9DWC1h2Zw](https://www.bouchard-aine.fr/en/e-shop.r-355/our-wine-posters.r-109/les-couleurs-du-vin.p-10.html?valid_legal=1#.YN9DWC1h2Zw).
- Boulton, R. 2001. The copigmentation of anthocyanin and its role in the color of red wine: A critical review. *American Journal of Enology and Viticulture* 52: 67-87.
- CMS: Court of Master Sommeliers. 2017. CMS Deductive Tasting Format. Online: <https://www.mastersommeliers.org/sites/default/files/ES%20Tast-Deductive%20Tasting%20Format%20March%202017.pdf>.
- Fairchild, M. D. 2018. The colors of wine. *International Journal of Wine Research* 10: 13-31.
- Shepard, G. M. 2016. *Neuroenology*. New York: Columbia University Press.
- Wine Folly. 2019. *Complete Wine Color Chart*. Online: <https://winefolly.com/deep-dive/complete-wine-color-chart/>.
- WSET: Wine & Spirits Education Trust. 2019. WSET Level 2 Systematic Approach to Tasting Wine. Online: [https://www.wsetglobal.com/media/6916/wset\\_l2wines\\_sat\\_en\\_may2019.pdf](https://www.wsetglobal.com/media/6916/wset_l2wines_sat_en_may2019.pdf).
- WSET: Wine & Spirits Education Trust. 2016. WSET Level 3 Systematic Approach to Tasting Wine. Online: [https://www.wsetglobal.com/media/3119/wset\\_l3\\_wines\\_sat\\_en\\_jun-2016.pdf](https://www.wsetglobal.com/media/3119/wset_l3_wines_sat_en_jun-2016.pdf).

# Algorithmic Color Methods of Media Arts

Petronio Bendito <sup>1,\*</sup>

<sup>1</sup> Patti and Rusty Rueff School of Design, Art, and Performance – Purdue University; pbendito@purdue.edu

\* Corresponding author: pbendito@purdue.edu

## Abstract

The paper describes a framework for systematically exploring the RGB color model for generating color palettes based on six algorithmic methods. The framework was implemented as a foundation to produce algorithmic color palettes for visual expressions while exploring the intersection of mathematical principles of geometry, color, and code. We examine how algorithmic color palettes relate to culture, history, and other artistic practices. An application of the methodology is presented.

**Keywords:** *digital culture, media arts, algorithmic color, RGB color model*

## INTRODUCTION

Computer technology has introduced new color selection tools. Colorists, artists, and designers have always used systematic approaches to develop color palettes. For example, the color wheel is a color organization method that makes it easier to build color combinations based on linear and 2D geometric structures (e.g., monochromatic, analogous, triad, tetrad, etc.). In the last decades of the 20<sup>th</sup> century, as computer technology became more central to art and design practices, digital color selection methods also increased. New ways of working with digital colors happened concurrently with the emergence of Media Arts.

### Media Arts

The National Core Arts Standards for Media Arts, which was proposed by the National Art Education Association in 2014, defines Media Arts as artistic expressions based on the integration of technological processes. The standards explain that Media Arts promotes “a fundamental understanding of the mediums of analog and digital media to integrate digital technologies with traditional forms of artistic expression.”<sup>1</sup>

For colorists, artists, and designers, digital technology provides new ways to work with colors on the computer screen. Graphical User Interfaces (GUI) were introduced to facilitate the selection of digital colors. However, we also notice increased use of code to generate algorithmic color palettes. Algorithmic art and color palettes based on the RGB and HSB color models were popularized by Processing, a JAVA-based programming language. Like 3D color models used by traditional artists, designers, and colorists, the RGB and HSB color models function as cognitive tools for developing color palettes. For teaching and learning purposes, both the RGB and the HSB color models are integral to developing digital color literacy<sup>2</sup>.

## METHODOLOGY

Digital color aesthetic is a chromatic expression native to digital processes. It is based on digital color models, such as the algorithmic color palettes derived from the framework presented in this paper.

---

<sup>1</sup> <https://www.davisart.com/blogs/schoolarts-room/what-is-media-art>.

<sup>2</sup> This is the terminology that the author implemented based on visual literacy to discuss issues relevant to digital color in the classroom.



Here we also discuss a five-step creation process, ranging from the RGB color model as source material to its application in the context of Media Arts.

### Five-Step Color Implementation Process

The steps presented in the diagram (See Figure 1) are explained below:

- **RGB Model:** The process began with adopting the RGB color model as the starting point of exploration for developing algorithmic color palettes.
- **Code:** In the second phase, algorithms were developed in Processing based on geometric configurations within the RGB color model, following the framework described in the next section.
- **Output:** hundreds of algorithmic color palettes were produced using parametric methods and applied to test patterns. The color palettes were cataloged.
- **Discovery and Analysis:** The *Discovery and Analysis* phase comprises two subcategories. The Subjective and Objective subcategories. In the Subjective aspect of discovery, the artist selects color palettes to be implemented as art projects. In contrast, the Objective Discovery aspect is a process of associating the algorithmic color palettes with nature and culture. For example, an algorithm may produce a color palette that resembles a natural phenomenon (e.g., sunset) or a cultural product (e.g., color palettes of pre-existing artworks).
- **Application:** in this phase, the color palettes are implemented. The photo depicts works exhibited in a solo show at Butler University, USA<sup>3</sup>.

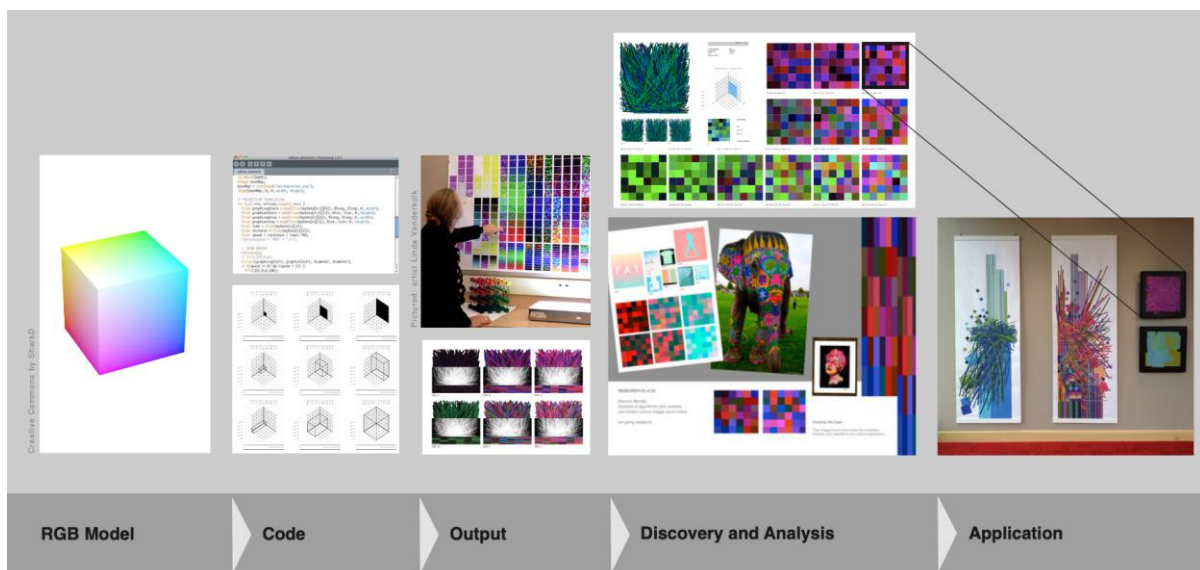

Figure 1: Five-step color implementation process of media arts projects.

The methods used by artists to produce algorithmic color palettes are relevant to the history of art and design, society, our understand of nature and science. They are also critical to foster digital color literacy and an understanding of digital color aesthetics<sup>4</sup>. For the research presented here and developed as part of the author's Color Code series, algorithmic palettes were selected and

<sup>3</sup> Color Code: Algorithms and Expressions. Bendito's Solo Exhibition – 2014. Schrott Center at Butler University, Indiana.

<sup>4</sup> The author presented a paper at AIC in 2005 exploring this topic.

implemented based on their expressive qualities and a sense of historical relevance. Color palettes generated algorithmically may present themselves as distinct expressions of digital culture.

### **SIX ALGORITHMIC COLOR PALETTE FRAMEWORK**

This section examines the intersection of mathematical principles of geometry, color, and code to create algorithmic color palettes. We present six fundamental methods that form the research framework (Figures 2 and 3).

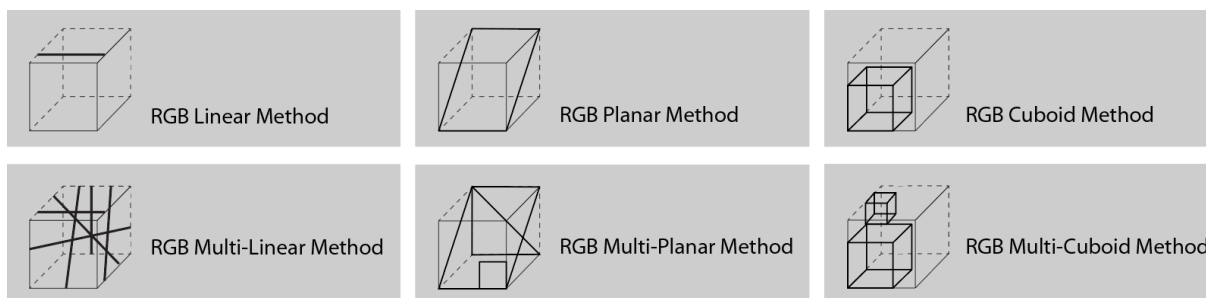

Figure 2: Six fundamental methods to generate algorithmic color palettes based on the RGB color model.

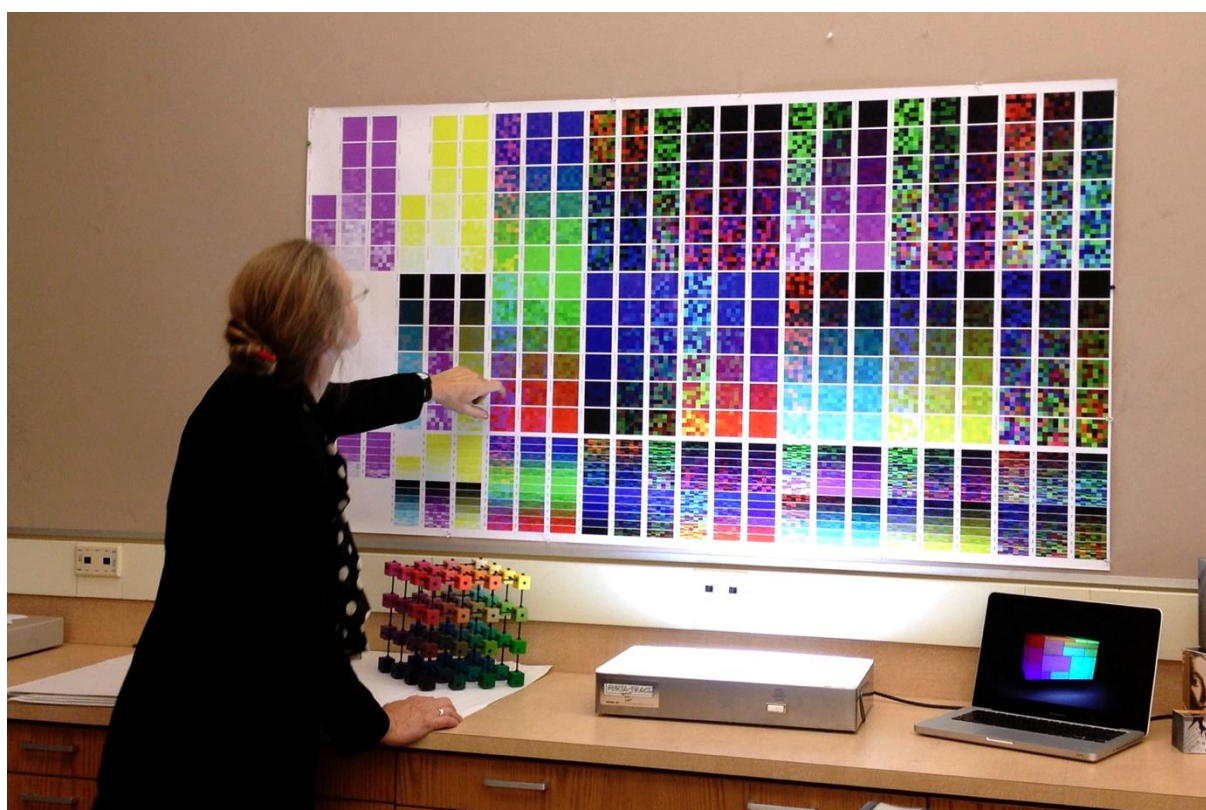

Figure 3: Faculty member examines test patterns of the algorithmic color palettes generated based on the Six Algorithmic Color Palette Framework. Purdue University.

**RGB Linear Method:** The color palette is derived from an algorithm that samples colors from a line segment that is created inside the RGB color model defined as  $R=X$ ,  $G=Y$ ,  $B=Z$ . The size and placement of the line determine the range of possible colors. For example, a line can produce a grayscale, a monochromatic color palette, or a color gradation; **RGB Planar Method:** The color palette is derived

from an algorithm that samples colors from a plane that was created inside the RGB color model defined as  $R=X$ ,  $G=Y$ ,  $B=Z$ . The size and position of the plane determine the range of possible colors; **RGB Cuboid Method**: The color palette is derived from an algorithm that samples colors from a cuboid that is created inside the RGB color model defined as  $R=X$ ,  $G=Y$ ,  $B=Z$ . The size and position of the cuboid determine the range of possible colors; **RGB “Multi” Methods**: These are combination methods that create the opportunity to combine multiple Lines, Planes, and Cuboids to generate color palettes. Besides multi-linear, multi-planar, and multi-cuboid combinations, there are other combination possibilities (not depicted in Figure 2) such as RGB Linear+Planar Method, RGB Linear+Cuboid Method, and RGB Planar+Cuboid Method.

The matrix shown in Figure 3 illustrates the results of various methods. Algorithmic color palettes can be controlled parametrically by varying Red (R), Green (G), and Blue (B) values; therefore, a progression of color combinations can be achieved (see Figure 4). The matrices produced for the research create a random sample of colors found within the boundaries of the predefined geometry of the method.

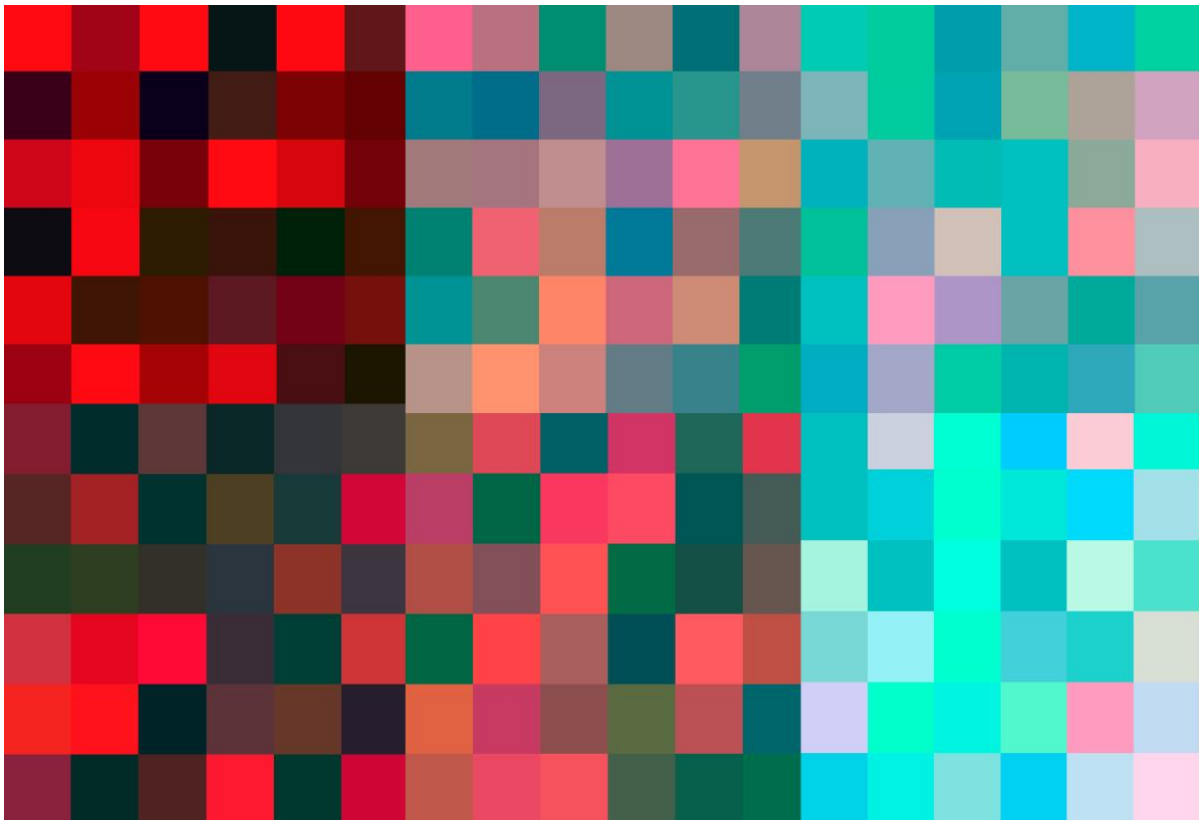

Figure 4: *Untitled*. Petronio Bendito. Six color palettes generated by the algorithms and placed side by side. It is possible to create gradations among color palettes by varying RGB values through a parametric process of creation.

### **APPLICATION EXAMPLE**

The algorithmic color palette methods discussed in this paper have produced a wide range of art and design projects and have been exhibited in the US and abroad. A list of works by the author can be found at <https://www.colorcodeart.net> and can also at Bridges Mathematical Art gallery online.<sup>5</sup>

<sup>5</sup> <http://gallery.bridgesmathart.org> (Google: Petronio Bendito | Mathematical Art Galleries)



Here we present documentation images of the *RGB to CMYK: Test Patterns* (2012) by the author and its installation at Purdue University's Rueff Gallery (See Figure 5).

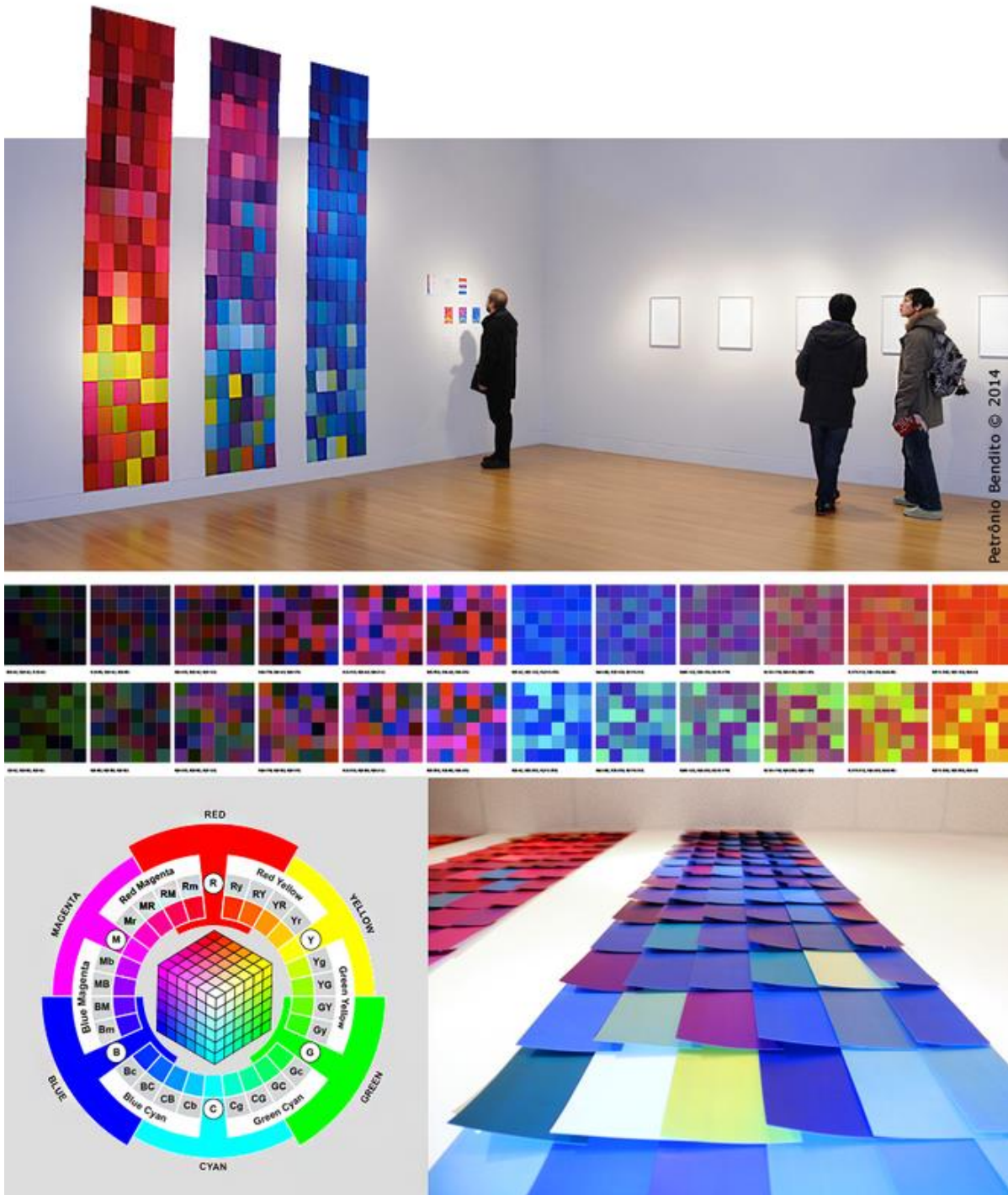

Figure 5: *RGB to CMYK: Test Patterns* (2012) by Petronio Bendito. Algorithm, paper, ink. Size and shape variable. Purdue University / Rueff Gallery, installation view; middle: color palettes from which nine color palettes were selected to build the work; lower left: RGB/CMY Digital Color Wheel based on the RGB color cube (Bendito); lower right: printout of the color palettes.

For this work, nine algorithmic color palettes were combined. Each color was individually printed and hang according to a predefined visual configuration. The color palettes were devised algorithmically using Processing (Java). Here's an excerpt from the artist's statement: "Color algorithms were produced, and an RGB color matrix was assembled and printed in CMYK. These three test patterns examine the subtleties of color relationships inherent in computational color processes (...) As part science, part art, this work challenged me to reflect on my own understanding and assumptions about digital color. By turning the work itself into a visual experiment, here I test the expressive role of color algorithms in the gallery space—an experience that I extend to the viewer."

## **DISCUSSION AND CONCLUSION**

Algorithmic art is essentially a set of instructions given to a computer to execute commands for artistic self-expression. Historically, before the integration of digital technology into the arts, conceptual artists also created a set of instructions to create artistic expressions. Artists wrote instructions carried out by others<sup>6</sup>, and Process Art focused on the process and outcome together as an artistic expression<sup>7</sup>. What is most relevant to the discussion here is how the uses of colors were implemented.

It is vital that media arts education and digital color literacy acknowledge traditional color formulations, 'art as instruction,' and Process Art as foundational concepts to the evolution of digital color aesthetic and media arts. Methods to develop algorithmic color palettes will continue to be developed and play a significant role in media arts and design practices in the 21<sup>st</sup> century.

## **ACKNOWLEDGEMENTS**

College of Liberal Arts' Margo Katherine Wilke Program and Linda Vanderkolk, Senior Continuing Lecturer, both at Purdue University.

## **REFERENCES**

- Dossin, C. Et al. 2014. *Petronio Bendito: Digital Color, Algorithm, and Expression*. West Lafayette, In: Art Museum of Greater Lafayette.
- Bohnacker, H., B. Gross, J. Laub, and C. Lazzeroni. 2012. *Generative Design*. Amsterdam: Amsterdam University Press.
- Holtzman, S. R. 1996. *Digital mantras: The languages of abstract and virtual worlds*. Cambridge, MA: MIT Press.
- Norman, R. 1996. *Electronic color: The art of color applied to graphic computing*. New York: Van Nostrand Reinhold.
- Reas, C and B. Fry. 2014. *Processing: A programming handbook for visual designers and artists*. Cambridge, MA: MIT Press.
- Rodman, G. R. 2001. *Making sense of media: An introduction to mass communication*. Boston: Pearson.
- Weinman, L and Heavin, B. 1997. *Coloring Web graphics 2*. New Riders Pub.

---

<sup>6</sup> See <https://www.flavorwire.com/261098/artists-who-make-instructions-for-others-to-make-their-art> for an overview of this topic.

<sup>7</sup> <https://inculture.microsoft.com/arts/sol-lewitt>

# Investigation into the colours of the DunHuang murals from the Tang Dynasty

Zhaohua Lei <sup>1</sup>, Elza Tantcheva-Burdge <sup>2</sup> and Vien Cheung <sup>3,\*</sup>

<sup>1</sup> Poli.Design, Italy; lzhdesign2018@gmail.com

<sup>2</sup> Independent Art Historian, UK; etan711@talktalk.net

<sup>3</sup> School of Design, University of Leeds, UK; t.l.v.cheung@leeds.ac.uk

\* Corresponding author: t.l.v.cheung@leeds.ac.uk

## Abstract

In 1961 the site of the MoGao cave temples was recognised as one of the State Priority Protected Sites by the State Council of the People's Republic of China and was put under the protection of the national laws including the Law on the Protection of Cultural Relics. In 1987 UNESCO added the MoGao Caves to its protected World Heritage Sites as one of intrinsic unmatched historic value to humanity. The present paper assesses the appearance of colours in the representational system of the murals from the Tang period (618-907 AD) with a view to gaining a deeper understanding of the DunHuang murals as emblematic of Chinese civilisation. Thus the use of colour will be discussed in the context of the traditional 'five colour system'.

**Keywords:** *DunHuang murals, Ancient Chinese art, Colour appearance, Chinese culture, Wuxing*

## INTRODUCTION

DunHuang is a Buddhist centre on the ancient Silk Road, in the Gansu province of China, known as the Caves of the Thousand Buddhas, consisting of 735 cells and temples, constructed over 1,000 years (366-1386 AD). The centre is famous for its MoGao cave temples of which 495 survive in a relatively well-preserved condition. It is accepted that the first caves were carved into the rocks in the fourth century AD and the most recent are from the fourteenth century AD.

The DunHuang centre was modelled on the existing Kizil caves Buddhist centre and the influence of the Kizil style was at its strongest in the earlier periods of the development of the MoGao temple caves. Scholars consider Kizil to be the earliest major Buddhist cave complex in China, with development occurring between the third and eighth centuries AD. It comprises a set of 236 cave temples excavated into the rocks and extending for some two kilometres in a general east-west direction. As in the case of DunHuang it is situated on the Silk Road. At the time of their creation the Kizil Cave temples were part of another Buddhist Kingdom, that of Kucha (or Kuche), though its territories are now part of the Aksu Prefecture, Xinjiang, China. However, the Tang Dynasty ruled Kucha after 658 AD and this caused a reversal, with its Central Plains culture increasingly influencing the paintings in the Kizil cave temples, evidenced by the adoption of styles and colours found in the seventh and eighth century decoration of the MoGao temple caves (Li 1994: 83-85).

All the Kizil caves are elaborately decorated with murals and it is considered that the influences shaping the art of the Kizil caves came from the cultures of South Asia, India, Iran, and the coastal areas of China. This was aided by the fact that Kucha was an important commercial centre on the Silk Road. This enabled Kucha, and in particular the Kizil Buddhist centre, to play a major role in the dissemination along the Silk Road of Buddhism and its art.

As in Kizil all the MoGao caves are elaborately decorated with murals, the total area being about 45,000 square metres, and over 2,000 coloured sculptures. In some of the temples the decoration covers not just the walls but also the ceilings. Because of the wide time span through which the complex was developed and its good level of preservation, the MoGao caves are considered, both nationally and internationally, to provide a compendium of Chinese art, particularly evidencing the evolution of Buddhist art in the north-west region of China.

The aim of this paper is to make an initial assessment of the appearance of the colours in order to evaluate the relative constancy in the use of colour in these caves throughout the Tang Dynasty period. Our hypothesis is that the number of colour hues used will be relatively constant. This is not just because of the limited number of pigments available, but also because of the influence of Taoist cosmology within the Chan (Zen) School of Buddhism. This School is directly associated with the Tang period.

### **COLOUR OF THE MURALS FROM THE TANG DYNASTY**

The methodology used for this investigation was designed to overcome the constraints imposed by the Covid-19 pandemic by conducting the study using images created for the virtual museum of the MoGao caves (Dunhuang Academy, 2020). Generally, historians recognise four major stages in the development of the Tang Dynasty: (1) the Early Tang period (618-712 AD); (2) the High Tang period (713-766 AD); (3) the Middle Tang period (762-827 AD) and (4) the Late Tang period (828-907 AD). To carry out our investigation, those murals considered by scholarship to be particularly significant examples of Buddhist art from each period will be selected. Each colour in the selected digital images is then identified as the nearest match within the Pantone Colour System using its digitalised version. The use of colour will be discussed in the context of the traditional 'five colour system'.

#### **Wuxing and the Chinese Traditional Five-Colour System**

The Chinese term *Wuxing* (usually translated as 'five processes', 'five phases' or 'five elements') is used for a conceptual theory that has been a constant feature of traditional Chinese thought and culture. The five elements were considered to be independent, but at the same time interlinked. Before the Han Dynasty, when the initial idea was formed, the elements were associated with natural phenomena and seasonal changes, bringing an understanding of the workings and development of the Universe. These five elements were: Wood, Fire, Earth, Metal, and Water (see Figure 1a and Table 1).

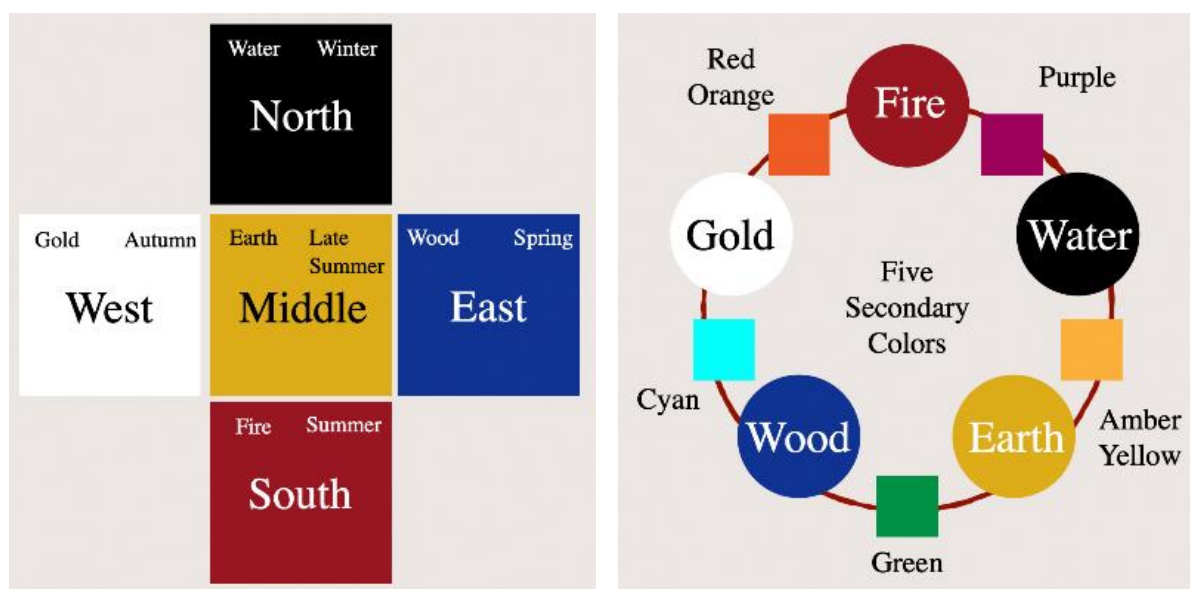

Figure 1: Relationship between the "five-colour system" and (a) direction; (b) secondary colours.

Element	Fire	Wood	Earth	Metal	Water
Colour	Red	Blue	Yellow	White	Black
Direction	South	East	Centre/middle	West	North
Season	Summer	Spring	Change of season	Autumn	Winter

Table 1: Relationship between the "five-colour system" and colour, direction and season.

The first proposed universal use of the 'five elements' conceptual system is found in "Book of Documents", one of the "Five Classics" written during the Zhou dynasty (1046-256 BC). In those texts were associations with directions, colours, spirits, and proper rituals that were later enshrined in the Confucian classics, in particular the books *Shijing* (Classic of Poetry) and *Rites of Zhou* (2<sup>nd</sup> century BC), dating respectively from the 11<sup>th</sup> to 7<sup>th</sup> centuries BC and the 2<sup>nd</sup> century BC. Those were used initially to regulate early Chinese dyeing techniques for the production of maps and paintings during this period thus leading to the development of the traditional Chinese 'five-colour' system (Tseng 2003: 192-197). Moreover, *Wuxing* assisted in describing, analysing or regulating the relationship of the elements within different spheres of human life - political, social and cultural. For example it assisted in complying with rituals and numerous hierarchical regulations such as those relating to the use of colour in people's clothing or the colours of their ornaments. Thus colours began to occupy an important place in all aspects of Chinese culture (Chen 2015: 369).

In brief, the five colour system includes three chromatic colours and two achromatic ones: red, blue, red, yellow, white, and black. In a broad sense they are independent sets of colours. There does not seem to be a suggestion of their optical qualities and thus no interest in the visual interrelationship between them. Moreover, the three colours occupy only part of any western colour system, but instead mirror the *Wuxing* conceptual system (Xiao 2013: 185-187).

A relationship between the five colours and the five phases or elements in *Wuxing* was developed gradually. By its overarching nature *Wuxing* established a defining association between the five colours and natural phenomena and also concepts of space and time amongst others (Xiao 2013: 191-195).

In painting, the mixing of pigments or the presence of natural impurities could result in 'secondary' colours, which are employed and are also considered within the 'five-colour system'. For example, green (blue + yellow), cyan (blue + white), red orange (red + white), amber yellow (black + yellow), purple (black + red) as shown in Figure 1b. In the case of the mixing of chromatic and achromatic colour usually the chromatic one is the defining 'element'; in case of the colour green it is associated in tandem with the blues and cyans with Wood (Chen 2015: 368-369).

Research shows that a number of mainly inorganic but also some organic pigments were used in creation of the DunHuang murals from the Tang Dynasty period (Xu 2007). For greater clarity the list of the pigments so far identified is presented here in tabular form (see Table 2).

Colour	Red	Blue	Green	Yellow	White	Black
Pigment	Haematite, Cinnabar, Red lead	Lapis lazuli, Azurite	Malachite, Verdigris	Ochre, Orpiment, Gold leaf, Organic pigments	Calcite, Kaolin, Basic Lead, Oyster shell, Gypsum	Vegetable black, Black lead

Table 2: List of pigments identified for the creation of the DunHuang murals from the Tang Dynasty period.



This would have allowed the creation and use of the above mentioned 'secondary' colours. However, in at least one such case, green, it appears that green-coloured pigments were used. This leaves open the question about the use of any other secondary colour(s), which will be determined in the next part of this investigation.

### **Appearance of the colours in the main palette of the DunHuang Tang murals**

The construction of the DunHuang Buddhist centre began in the Early Tang Dynasty (618-712 AD). Over its 94 years 46 caves were dug. The walls were then plastered using local iron-rich clay and the mural colours were applied over that, thus helping to create compositions with a warmer tone overall compared to those from the later periods. Nevertheless, because of natural variations in the chemical composition of the plaster base and perhaps because of the interplay between adjacent colours the final appearance of the various murals from the early Tang Dynasty also varies, but only to a limited extent.

The image that was analysed for the purposes of this paper is the central composition on the south wall of Cave 322 (Figure 2a). Initial examination indicated that all the general hues in the traditional Chinese 'five colour system' were used in this mural, together with one of the 'secondary' colours, green. Moreover, a new combination of gold and earth yellow had been added. However, because of the specific optical properties of gold, for the purposes of this investigation only the appearance of the colour yellow was considered. Despite the already mentioned foreign influences on the DunHuang style, especially in the Early Tang period, it has to be stressed that the choice of colours is considered to have been primarily influenced by the local Chinese colour preferences (Zhou 2000).

Over the High Tang period (713-766 AD) the DunHuang style was established. It is considered that 97 caves were excavated and decorated during this period. The mural on the north side of Cave 217 (Figure 2b) is well preserved and is one of the outstanding masterpieces of the murals executed at the most prosperous time of the Tang Dynasty. The overall tone of the whole painting is again warm, but more intense than that of the murals from the early Tang period as the colours were made with less mixing of pigments, thus appearing more saturated and vibrant (Zhou 2000). Moreover there could be noted an even wider use of gold, compared to the previous period. Research considers that to be a result of the increase in the influence of Buddhism as a defining force in the structuring and maintenance of Chinese Imperial power. As a result gold leaf and vibrant, 'secular' colours perceived as 'colours of wealth' began to be widely used in paintings (Meng, 2008).

During the Middle Tang period (762-827 AD) 55 new cave temples were created. This was a period of continuous internal and external struggles as there were countless wars, battles and skirmishes with the Tibetan Empire (618-842 AD) resulting in considerable territorial losses. The political and economic instability in the period impacted on the production of art and the opulence and refinement of the murals made in the Early and especially in the prosperous High Tang Period was lost. The early golden and vibrant tones were replaced by a mainly lighter, paler palette. These light paints appear to have been thinly applied, with a dominance of flat green and yellow, and outlined with ink (Meng, 2008).

An example of the Middle Tang period mural art is the image of the central mural on the south wall of Cave 159 (Figure 2c), where more obvious changes in the use and the appearance of colour can be noted. Green was used on a much larger scale either as a single colour or in a number of very similar adjacent tones, though red and other warmer tones could also be found in the compositions. The base undercoat of the murals was now white earth and the intensity of the colours of the murals appeared to be greater. It could be argued that those changes are to some extent a consequence of periodic changes in the *Wuxing* rules in general and those relating to art and its production in particular. At the

same time there were still some murals from the Middle Tang period that were painted over an iron-rich undercoat, as in the previous two periods (Meng 2008).

In the Late Tang period (828-907 AD) DunHuang saw the excavation of 71 caves. This period saw a continuation of the style of the Mid-Tang Dynasty that was dominated by light blue and green tones, as is illustrated in a mural from the decoration of Cave 12 (Figure 2d). The influence of Tibetan religious art is still noticeable but there are stylistic changes. They have been attributed to the growing cross-fertilisation between the previously separate aesthetics of secular art found in the Western Regions of the Late Tang Empire and that of the existing style of religious paintings. Scholars concluded that this, on the one hand, revitalised the paintings from the period, compared to the Mid-Tang period and, on the other hand, prepared the foundation for the emergence of the style of the Western Xia Dynasty (1038-1227 AD) and its significantly different use of colour (Meng 2008).

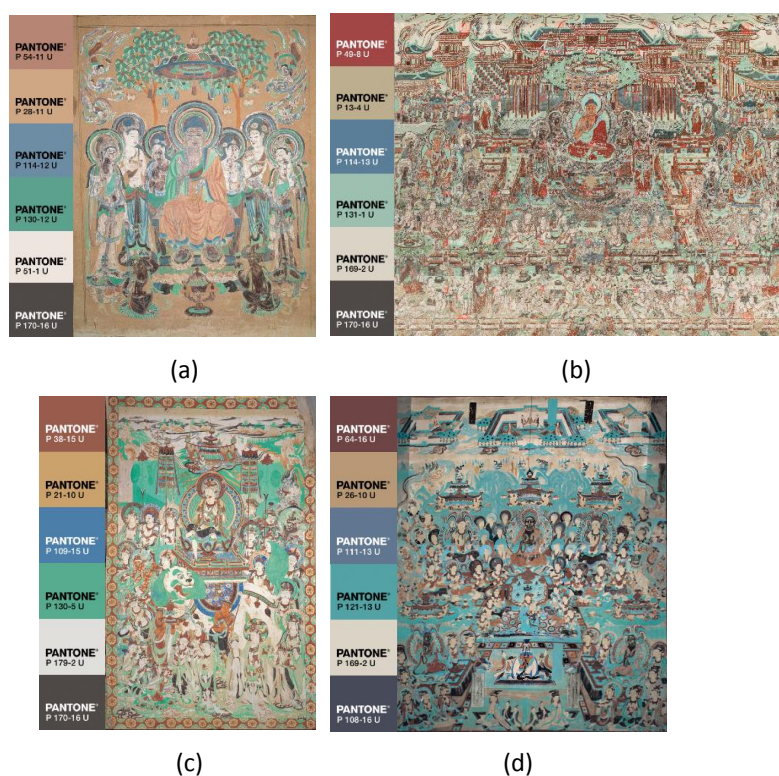

Figure 2: Colour palettes used in (a) Cave 322 in the Early Tang Period (618-712 AD), (b) Cave 217 in the High Tang Period (713-766 AD), (c) Cave 159 in the Middle Tang Period (762-827 AD) and (d) Cave 12 in the Late Tang Period (828-907 AD).

Our findings are summarised in Table 3.

Colour	Red	Yellow	Blue	Green	White	Black
<b>Cave 322</b>	P 54 - 11 U	P 28 - 11 U	P 114 - 12 U	P 130 - 12 U	P 51 - 1 U	P 170 - 16 U
<b>Cave 217</b>	P 49 - 8 U	P 13 - 4 U	P 114 - 13 U	P 131 - 1 U	P 169 - 2 U	P 170 - 16 U
<b>Cave 159</b>	P 38 - 15 U	P 21 - 10 U	P 109 - 15 U	P 130 - 05 U	P 179 - 2 U	P 170 - 16 U
<b>Cave 12</b>	P 64 - 16 U	P 26 - 10 U	P 111 - 13 U	P 121 - 13 U	P 169 - 2 U	P 108 - 16 U

Table 3: Colour palettes, presenting in the closest match of the PANTONE® CMYK Uncoated guide set, of the DunHuang murals from the Tang Period.

## **DISCUSSION**

From an examination of the existing scholarship on the use of colour in Chinese art and, in particular, the DunHuang murals from the Tang period it became apparent that thematically and stylistically the compositions of the MoGao caves absorbed many influences from Buddhist art mainly of Central Asia, India, Iran and Tibet. Moreover, throughout the Tang period the use of colour changed. Whereas in the Early and High Tang period the palettes were dominated by reds and yellows, with the added use of physical gold, by contrast in the Middle and Late Tang periods the palettes became dominated by light blues and greens.

Nevertheless, research indicated that the palettes were always constructed according to the *Wuxing* conceptual system that ruled every part of the human life. Therefore, in every period of the Tang Dynasty, the palette followed the traditional Chinese 'five colour system' without deviation. Furthermore, despite the considerable number of pigments found to have been used in the DunHuang cave temples, there is only one 'secondary' colour which, it must be stressed, does appear to be part of the extended 'five colour system'. Even for that a separate pigment was used, rather than creating the colour by mixing two other pigments. This leads to the conclusion that the intensity and vibrancy of colours was of a special significance at that period.

To conclude, the present work is yet another step towards building an understanding and appreciation of the significance of the DunHuang complex as emblematic of Chinese civilisation and the Tang Dynasty Buddhist art in particular. Moreover, the results of this work prepare the ground for further investigation into the aesthetics of the representational system of these murals, as part of the national and world cultural heritage.

## **REFERENCES**

- 陈彦青 著《观念之色》，北京大学出版社，2015 年版 <Chen Y. 2015. *The Colour of Ideas*. ISBN: 9787301258873>
- Dunhuang Academy (2020), <https://www.e-dunhuang.com/> - last accessed 14 June 2021
- 李广元 著《东方色彩研究》，黑龙江美术出版社，1994 年版 <Li G. 1994. *Oriental Color Research*. ISBN: 9787531802570>
- Meng J. 2008. Study on colour of DunHuang murals of Tibet Period. *Masters Thesis*. Lanzhou: Northwest Minzu University.
- 曾启雄 著《中国失落的色彩》，耶魯國際文化出版，2003 年版 <Tseng C-H. 2003. *The Lost Colours of China*. ISBN: 9789578323452>
- 肖世孟 著《先秦色彩研究》，人民出版社，2013 年版 <Xiao S. 2013. *Pre-Qin Dynasty Colour Research*. ISBN: 9787010121703>
- Xu Y., 2007. Research significance on materials and techniques for the DunHuang murals, *Doctoral Thesis*. Lanzhou: Lanzhou University.
- 周大正 著《敦煌壁画与中国画色彩》，人民美术出版社，2000 年版 <Zhou D. 2000. *DunHuang Murals and the Colours of Chinese Paintings*. ISBN: 9787102021317>

# STRAW/LIGHT – COLOUR

Henriette Jarild-Koblanck <sup>1,\*</sup> and Monica Moro <sup>1</sup>

<sup>1</sup> Studio Koblanck; henriette.jarild-koblanck@morbylanga.se, monikamoro@yahoo.it

\* Corresponding authors: henriette.jarild-koblanck@morbylanga.se, monikamoro@yahoo.it

## Abstract

This project is about the colour of straw, one of the most ancient materials used by humankind. Using as inspiration some of Latour's and Krippendorff's design theories, we find a possible application of the colour in community events.

**Keywords:** *straw, colour, design, culture, communication*

## INTRODUCTION

Here is the story behind the ideas we have been working on for a longer period. So, it all began some years ago, when Henriette entered a larger room, a hall on a farm down in the south of the Swedish major island named Öland. *"The impression of the room was overwhelming ... the walls were covered with wallcoverings woven in lengths, made of rye straw and the light created a feeling of being in a golden room. The room is no longer there, unfortunately later owners have torn down the wallcoverings..."* She was deeply impressed by the **rich colour** full of light, precisely as Goethe did in Venice. He described his experience in his Italian Journeys, where on the 3rd of October in 1786,- the day he visited the Renaissance architect Palladio's Il Redentore, the Church of the Most Holy Redeemer-, he tell us that *"Going nearer, I discovered an ingenuos deception. All that I had taken for gold was, in fact, straw pressed flat, and glued upon paper, according to some beautiful outlines, while the ground was painted with lively colours."* In fact , the minor Franciscan order of the Capuchins used unexpensive and humble materials to achieve a strict observance of their rule.

The idea of the straw colour as focus of this essay was strengthened by the many issues brought about by the pandemic period we have lived in recent times. We have fairly all been living longer times at our homes and the fact of having to stay inside have put the attention also on the materials and colours that can create a better, not expensive and ecological, but also cherishing and cheering environment. Straw is one of the oldest materials known to us human beings and it has especially used in basketry but also as building or insulating material to be hidden. Since ancient times, straw from different species has been used all over the world for everything from roofs, carpets and handicrafts up to today's fine arts.

The concept of straw, design and beauty, is vast and worldwide. You can find countless connections with this simple material, between colour, material, texture and light, as it is an incredibly **living material, changing in colour and tone sparkling in the different patterns** and darkening or lightening in the textures. That's why, around the world there are so many contemporary artists, artisans and craftsman are still passionate about and working with this material, to which several specialized museums are dedicated.

## THE IDEAS AROUND "COLOUR - LIGHT/MATERIAL – HERITAGE"

The straw colour is a shade that is natural and organic, or also a "native" colour as Clino Trini Castelli would define it, meaning that it is at its natural state. Straw has quite always been part of the chromatic world of human beings. We note that also the colouring or dyeing techniques to obtain different hues or nuances is also as old as human beings.

If we look at the world of fashion, straw colour has always been very popular probably because it is so familiar to us, and the most iconic object is probably the hat made of straw, and the famous leghorn, with slight differences of nuances, patterns and textures is in all cultures part of human outfits, clothing and accessories. This happens since so long that it is lost in the mists of time. You have, also figuratively, evidence of this in many works of art and paintings.

In the same way it is also an aesthetic element of the “constructed” environment of humankind, and it is nearly always handmade as you must work it or put it together by hand in a thought and geometrical manner, both as furniture especially mats, or as an element of sitting or further as building components.

This is true both historically in traditional craftsmanship, in our case there is a very ancient and important basketry tradition both in Italy and in Sweden. For basketry, we mean the basket weaving or making, as the process is the one of weaving or sewing natural vegetal materials that are pliable into flat or three-dimensional artefacts. Basketry is made from a variety of fibrous or pliable materials—anything that will bend and form a shape. In the Italian region of Florence the hat making and in the Island of Sardinia the basket making, are important activities and the Sardinian Sinnai baskets are made in the same way they did in ancient Egypt. Sweden has also many basketry activities and especially linked with the Yule, the Christmas tradition and in Öland there is a tradition of straw roofs, Öland has a UNESCO World Heritage Site in Southern Öland (see Figure 1).

At the beginning we came up with mixed ideas, but naturally with the intention to focus on the world heritage and beautiful Öland.

We were fascinated by braids, knots etc. including the “nodi d'amore e di fortuna”, the traditional and wide spread love knots and the lucky knots, plus also by the Japanese giant braids, of the beautiful Shinto Temples, as in fig We thought that our work was a wandering around creating form from chaos, composing it in an orderly “room”.

During the pandemic, an Italian startup has done a design project on theatres in the open built with straw bales fig., which we thought was inspiring.

In this project we wanted to “weave” together the four approaches above, Colour - Light/Material – Heritage, and ultimately aimed to some kind of design, something larger that would reflect the four approaches into a whole. We saw possibilities for something that would create spatiality or part of spatiality e.g. walls/furniture/ movable hanging ornament or a piece of art with different textures in straw and light. We are referring to Bruno Latour’s idea that things carry a history with them and also as to Klaus Krippendorf’s idea that the viewer creates his history in the encounter. In his book *The semantic turn, A new Foundation for Design*, he suggests the way of designing within a human-centered design framework. In his philosophy of design his main axiom is that “Artifacts never survive within a culture without being meaningful to their users”.

On the other hand, Bruno Latour looks at society as composed by networked actors that are both humans and non-humans and where it is their association that leads to a collectivity.

Then we had also the essential components of the light, the importance of the experience/object, and spatiality etc.

Step 1. The first choice we encountered in the design process, which we would soon discover was a real issue, was that we had to decide between weaving with the material or using by means of piling it in some type of pattern and model that would be suitable to express our idea about the straw colour and its many variations under the different kinds of light. As mentioned above, we nearly immediately found out that it was not possible to weave anything in straw in a traditional way because there was no availability of straw in whole long straws at that time of the year. Henriette

really “vacuumed” the whole country of Sweden. However, wheat straw was available in bales which could not be woven but it could be used in aggregation, a little bit like the works of the Campana brothers in Brazil. So, our starting point was straw from bales. Now, our following step was how to think out a significant object that would be our communication piece that would express features of our design project.

Step 2. We found there was the possibility, based on the concept of **Communication pieces**, to make a number of tall cones, 150 cm high, which could be built from chicken wire mesh and lined or covered with straw, ordered in different ways to give different shades... with such a material you could even add colour if you wanted. The starting point was the abstract’s discussion of history and Latour’s discussion of the artefact’s carrying of memories and Krippendorff’s open possibility of intervention.

Then, the study of the colour of the straw began. Here are four pictures showing straw separated from the grains that Henriette cleaned (see Figure 2). This kind of material was the starting point for the **“gestalt” design** and it worked well, our link with the material is very deep. You can see in the images how the perception of colour is dependent on light and how the reflection of the straw emanates from the hard surface.

Step 3. After further sketching of a possible design that would be the basis for the exhibition, and sketches about possible patterns and decorations, and thinking about the cones, about 1.5 m high (see Figure 3); they could be:

A) standing on the floor; B) hanging from the ceiling; C) which is a motor that makes the cone slowly spin around like decorations in the Christmas tree; D) is an imaginary placement of 6 cones standing on the floor, and where the cross marks show the placement of hanging cones. In addition, all the cones have different patterns of straw, which are related to craft traditions but innovative (fig) You can, look at the arrows in the pictures, walk through this installation which requires a large space, as for example the Blue Hall of Stockholm City Hall, where the Nobel Banquet (Nobelfesten) the annual Nobel prize dinner held on 10 December is held (see Figure 4).

Moreover, the lighting varies in intensity from early dawn to late evening, so the following steps were:

1. experimenting with the angle of incidence, which in turn produced different colours/reflections. In this case threshed wheat was used, which meant that many of the straws were flat giving a surface that gave higher reflection than round straws.
2. Looking at “wheat colour” according to NCS the values of the palette end up around S0515 Y, S0520Y, and wheat grey 2611 - Y08R, a possible colour would also be Ocra-yellow.
3. The image with the red ribbon shows the connection to tradition/decorations in straw and also Communication Piece. The thought is that there are a number of cones standing on a longer table, like at the Nobel party, where the flower arrangements can be seen as just Communication Pieces.

As for the installation/exhibition, it is also meant to function as a wandering in a past, the link is also with Öland’s landscape and tradition, but also as a contemporary landscape and the connection to “what is sustainable” based on Latour’s thoughts about things in a cautious Prometheus.





Figures 1 and 2: Öland landscape, working of the straw.





Figures 3 and 4: Öland landscape, working of the cones, Nobel banquet setting.





Figure 5: Niklas Petersson from Öland.

### **CONCLUSION**

At this point two cones were made and fully installed to experiment with and photographed. The idea was that colour and light/reflection should be in focus. This meant that the pictures were close-ups of the threshed straw in different light conditions, showing changes in the perceived colours. The pictures show different types of how grasses are joined together, two hat-boards and a landscape picture. The connection to the World Heritage was intended to be an experience that will be composed of colour, of the reflection of light creating a movement that, if possible, will give an experience of how a field moves in the wind, to that is added a piece of musical work that is based on the sound of the field and the grain. Our partners the farmer Niklas Petersson, with his knowledge about straw and using it, the Composer and Conductor Hans Gurstad Nilsson and when it comes to the lighting the curator is the Professor and Lighting Designer Jan Ejhed.

It was a lot of work to produce a sketch model... but great fun and there was a good photographer to take the pictures.

### **ACKNOWLEDGEMENTS**

We want to warmly thank our special and precious collaborators the farmer Niklas Petersson, for his knowledge of the material, Jan Ejhed for the light, Hans Gurstad Nilsson for the music and Sven Arrelöv for the photo of the finished model.

### **REFERENCES**

- Jarild-Koblanck, H., and M. Moro. 2017. Colours of designed nature: Growing seeds from a cultural think-thank, artistic readings on colour and nature in Sweden. In: *PICS 2016 Progress in Colour Studies Conference*, UCL London, and in *JAIC – Journal of the International Colour Association*, Volume 19
- Krippendorff, K., 2006. *The Semantic Turn; A New Foundation for Design*, Taylor & Francis CRC, New York.
- Latour, B., 2008. A Cautious Prometheus? A Few Steps Toward a Philosophy of Design (With Special Attention to Peter Sloterdijk). In *Fiona Hackne, Jonathn Glynne and Viv Minto (editors) Proceedings of the 2008 Annual International Conference of the Design History Society – Falmouth, 3-6 September 2009*, e-books, Universal Publishers, pp. 2-10.
- <https://www.youtube.com/watch?v=Jvas-E5pVys> <https://sodraoland.com/en/olands-world-heritage/>  
<https://teatrodiapaglia.wordpress.com/come-costruirlo/il-format/>

1 COLOR AND MEASUREMENT INSTRUMENTATION	2 COLOR AND DIGITAL	3 COLOR AND LIGHTING	4 COLOR AND PHYSIOLOGY
5 COLOR AND PSYCHOLOGY	6 COLOR AND PRODUCTION	7 COLOR AND RESTORATION	8 COLOR AND BUILT ENVIRONMENT
9 COLOR AND DESIGN	10 COLOR AND CULTURE	11 COLOR AND EDUCATION	12 COLOR AND COMMUNICATION MARKETING

# 11 COLOR AND EDUCATION

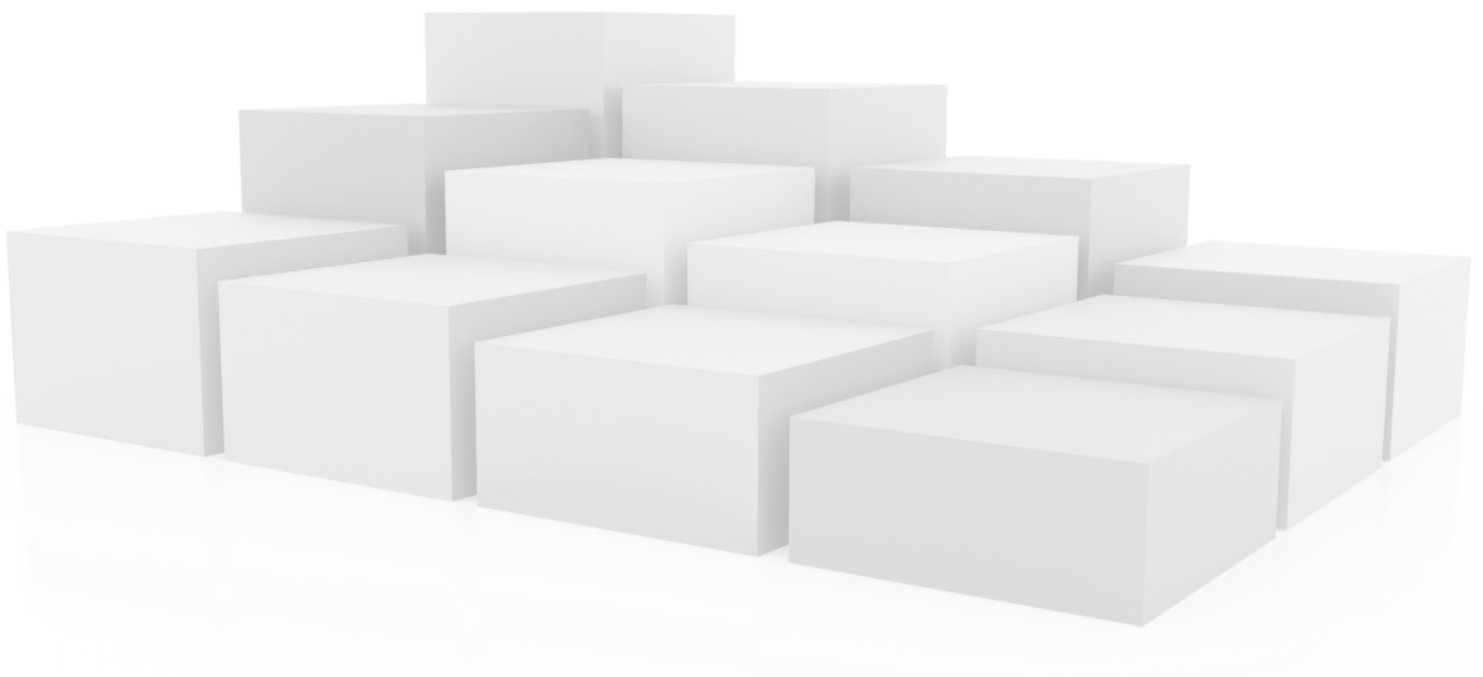

AIC 14<sup>th</sup> Congress Milano 2021 - August 30<sup>th</sup>– September 3<sup>rd</sup> 2021



# More than Three Dimensions: Communicating the Attributes of Colour Perception in Colour Education

David Briggs<sup>1,\*</sup>

National Art School, Sydney, Australia; djcbriggs@gmail.com

\* Corresponding author: djcbriggs@gmail.com

## Abstract

Colour education typically describes colour as having three attributes or dimensions, usually listed as (1) hue, (2) a term for lightness such as "value", "greyscale value", or "tone", and (3) a term for chromatic intensity, usually either "chroma" or "saturation", and generally meaning chroma as defined by the CIE. The remaining CIE-defined attributes of saturation (*sensu* CIE), brightness and colourfulness are rarely emphasized in colour education, despite being well-suited to the task of describing the colour appearance of illuminated objects. The writer has devised illustrations and explanations to help communicate these and related concepts during many years of teaching colour in art and design courses, and the paper presents selected examples of these that help to communicate the concepts of modes of colour appearance, brightness, colourfulness, saturation, brilliance and blackness.

**Keywords:** *perceived colour attributes, CIE International Lighting Vocabulary, colour perception, modes of colour appearance, colour education, colour terminology*

## INTRODUCTION

The CIE *International Lighting Vocabulary* (ILV) recognizes and defines six attributes of perceived colour: *hue, brightness, lightness, colourfulness, chroma* and *saturation*. A minimum of five such attributes are required for complete specification of color appearance (Fairchild 2013: 94), and most colour appearance models include predictors of all six. Just three attributes suffice to describe colour as long as we only consider a single *mode of colour appearance* (see Note 2, CIE e-ILV 17-22-040), for example perceived colours of objects, which can be described in terms of the CIE attributes of hue, lightness and chroma, or alternatively in the *Natural Colour System* (NCS) in terms of *hue, blackness* and *chromaticness* (relative chroma). More than three attributes come into play when we describe the appearance of illuminated objects, where we may be concerned in addition with the perceived colours of (1) any light sources visible, (2) the illumination on the objects, and (3) the light reflected to the eye from different areas of each object, all of which can be described in terms of *hue, brightness* and either *colourfulness* or *saturation*. For example, an architectural designer must consider colours of lighting as well as colours of materials and may need to differentiate between the uniform colour in which a wall is painted and its nonuniform appearance at different distances from a light source. A painter depicting the wall would in addition have to consider the varying object colours of the paints she uses to evoke the light reflected from different areas of the wall. Furthermore, digital colours can be considered both as colours of light and as object colours, and graphics programs specify colour using dimensions aligned with relative brightness and saturation (*sensu* CIE) in addition to others aligned, to varying degrees of refinement, with lightness and chroma (Briggs 2020).

The six CIE attributes and their definitions are based on work published in the late 1970's by R. G. Hunt (1977, 1978), and have been essentially stable from the 4<sup>th</sup> edition of the CIE ILV published in 1987 through to the current edition, published in late 2020. But despite this long period of stability of the standard nomenclature, colour is still typically presented in colour education as having just three attributes, usually listed as (1) hue, (2) a term for lightness such as "value", "greyscale value", or "tone", and (3) a term for chromatic intensity, usually either "chroma" or "saturation", and generally meaning chroma as defined by the CIE. I have observed that the distinctions between the remaining three CIE-

defined attributes are often poorly understood even by very experienced colour educators, and indeed, that these distinctions can sometimes be *more* difficult to grasp initially for those with firmly established ways of thinking about colour than for students who are relatively new to the subject.

Several additional factors could also have contributed to the delayed reception of these concepts in colour education. The ILV has always been expensive and relatively limited in distribution, and its definitions only became freely available online in 2012 as the [CIE e-ILV](#). In addition, the terse verbal definitions in the ILV can be difficult to understand for non-specialists, and although this issue has been addressed with excellent verbal explanations and examples provided by Hunt, Fairchild and Kuehni in particular, I would like to share a selection of the illustrations and explanations that I have found very useful in this regard in more than twenty years of teaching colour in art and design courses.

### **LIGHTNESS, BRIGHTNESS, CHROMA AND COLOURFULNESS**

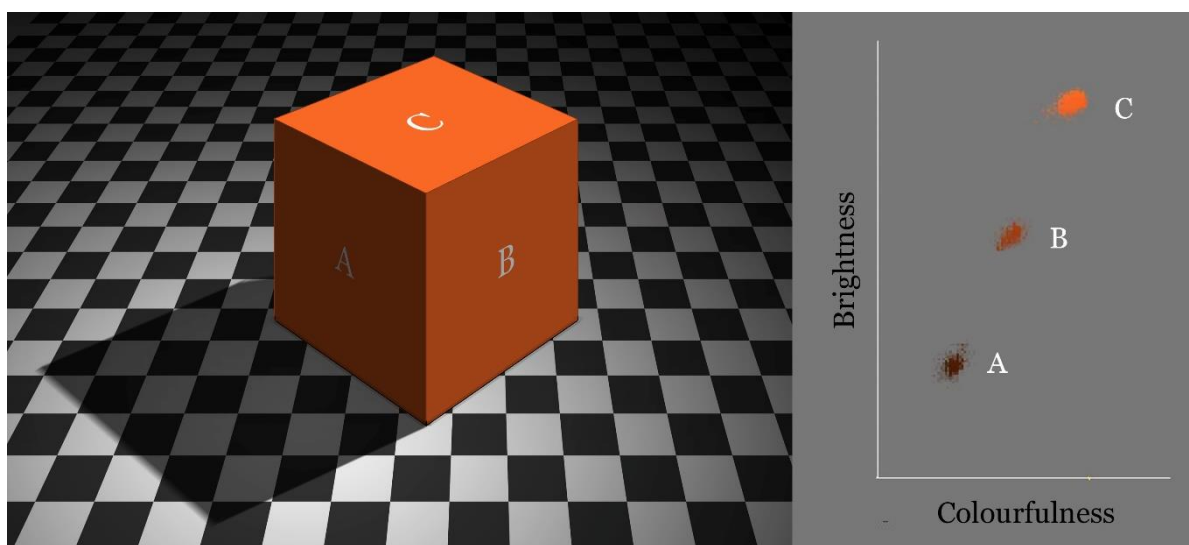

Figure 1: Left: the cube is perceived to have a uniform orange colour, as if it was painted all over with the same paint but appears progressively brighter and more colourful on its left, right and top planes (A, B and C). Right: brightness and colourfulness of planes A, B and C, as quantified by the lightness ( $L^*$ ) and chroma ( $C^*$ ) respectively in CIE  $L^*a^*b^*$  colour space of the image areas used to depict these planes.

The cube depicted in Figure 1 is perceived to have a uniform orange colour that could be described in CIE terms as having a uniform hue, lightness and chroma ( $h = 49$ ,  $L^* = 63$ ,  $C^* = 49$  in the CIE  $L^*a^*b^*$  colour space, or 10R 6.1/14.7 in Munsell dimensions), or in NCS terms as having a uniform hue, blackness and chromaticness (NCS S 0580-Y70R). Although it is a perception, this object colour is seemingly located outside of us in the object itself, as in this physically nonexistent cube. A perceived colour seen as belonging to an object is called an *object colour* (CIE e-ILV 17-22-042), or in painters' terms, a *local colour*, and is said to be perceived in the *object mode* of colour appearance (CIE e-ILV 17-23-029). Under favorable viewing conditions the attributes of this object colour are fairly reliable indicators of specific aspects of the intrinsic spectral reflectance of the object, including the overall direction of imbalance among its long, middle and short wavelength components (its hue) and the object's overall efficiency as a diffuse reflector of light (its lightness, a perfect diffuse reflector of light being seen as pure white) and as a *spectrally selective* reflector of light (its chroma). Of these three attributes, only hue also applies to colours of light *perceived as light*.

The object colour attributes of lightness and chroma are effectively communicated using sorting exercises available in print (Long 2021) and online (<http://stephenwestland.co.uk/app/demos.htm>), and similar sorting exercises illustrating blackness and chromaticness are produced for the NCS.

Now note that the left, right and top planes of this uniform cube, A, B and C, appear progressively *brighter and more colourful*. Similarly, although the lighter-coloured areas of the floor are all perceived as objects *having* the same object colour of the same lightness (i.e as *being white things*), these areas appear brighter in some parts of the floor than others. These colour attributes of *brightness* (CIE e-ILV 17-22-059) and *colourfulness* (CIE e-ILV 17-22-072) relate to the appearance of the *light reaching the eye from different areas of an object*, as opposed to the colour seen as belonging to the object itself.

As this is an *image* rather than an actual illuminated scene, there is a third level of colour perception involved, that of object colours belonging to the *image surface*. The variations in brightness and colourfulness of the light perceived to come from different areas of the virtual cube are depicted using areas of the physical image surface that can be perceived as having object colours with their own lightness and chroma (Figure 3, middle). This might be clearer if the image was painted or printed, but even though it is self-luminous, a computer screen is normally seen as an illuminated page rather than as a light source, and thus areas on it are readily seen as having lightness (greyscale value) and chroma.

### OBJECT AND ILLUMINATION MODES OF APPEARANCE



Figure 2: Left: orange, black and white object colours perceived in the scene depicted in the rectangular image in Figure 1. Right: pattern of illumination of varying brightness perceived superimposed in the same image.

Our orange cube can also be used to elucidate object and illumination colour perception. Within the rectangular image in Figure 1 we have perceptions of orange, black and white object colours (Figure 2, left), yet within the same rectangle we also perceive a pattern of illumination, comprising areas of light and shadow (Figure 2, right). Illumination colours can be described in terms of hue, brightness and either colourfulness or saturation, but this illumination is perceived as achromatic, varying only in brightness. Note that we experience these perceptions of object colour and illumination superimposed, as if the object colour is seen *through* the illumination. The two perceptions arise without conscious analysis: we automatically, instantly, and seemingly effortlessly resolve the scene into perceptions of spectral reflectance (as object colour) and illumination. It is only because of this remarkable capacity of our visual system that we perceive objects as *having* a relatively constant and seemingly intrinsic lightness and chroma, and not just constantly varying brightness and colourfulness.

## SATURATION

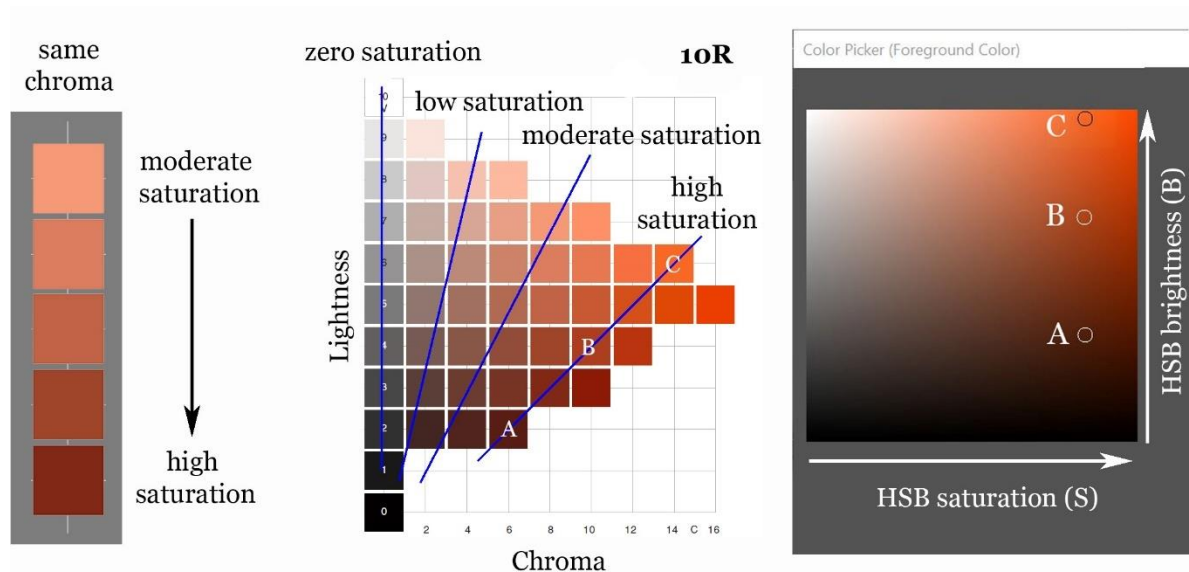

Figure 3. Left, middle: chroma 8 column and full 10R hue page from The Digital Munsell (Gernot Hoffman), latter showing shadow series of approximately uniform saturation, and approximate locations of image colours A, B and C from Figure 1. Right: Detail of Adobe Photoshop colour picker showing A, B and C in relation to S and B of HSB.

The word “saturation” is often used as a generic term for chromatic intensity in contexts where chroma, colourfulness and saturation are not distinguished, but in CIE terminology saturation has a specific meaning, defined as the “colourfulness of an area judged in proportion to its brightness” (CIE e-ILV 17-22-073), or in other words the perceived balance of chromatic and white components in the light from the area. Figure 3 helps to communicate the distinction between chroma and saturation as defined by the CIE. A column of digital swatches of uniform chroma can be seen to range from lighter swatches emitting a large amount of relatively whitish light to darker swatches emitting a smaller amount of less whitish/relatively more chromatic and thus more saturated light (Figure 3, left). Swatches exhibiting similar saturation lie along lines that *radiate* from near the zero point on the value scale, in contrast to the *vertical* lines of uniform chroma, and thus chips A, B and C all exhibit similarly high saturation, but vary considerably in chroma (Figure 3, middle).

A note to the e-ILV definition of saturation reads: “For given viewing conditions and at luminance levels within the range of photopic vision, a colour stimulus of a given chromaticity exhibits approximately constant saturation for all luminance levels, except when the brightness is very high”. Chromaticity is a measure of the overall balance of long-, middle- and short-wavelength components in a light, and this would stay constant when a uniform object reflects uniform illumination varying only in luminance (intensity). Thus in Figure 1, proceeding from A to B to C the colourfulness of the light reflected from the cube increases in proportion to its brightness, or in other words the light does not become either more or less whitish, and so the saturation remains the same.

We might thus expect to *depict* the increasing brightness and colourfulness of planes A through C with paint whose chroma increases in proportion to its lightness. While this rule holds roughly true, Centore (2011) showed that lines of uniform chromaticity or “shadow series” projected on to a Munsell hue page curve slightly and irregularly, and that their lines of best fit converge on a point on average about one value step below zero on the Munsell value axis. Corresponding lines in CIE  $L^*a^*b^*$  converge towards a point 16 units below zero on the 100-unit  $L^*$  lightness axis (Figure 4, right).



The dimension called “saturation” (S) in the widely used digital colour space HSB is a crude predictor for saturation (*sensu* CIE) relative to the maximum possible for digital colours of a given hue. Image areas A, B and C in Figure 1 have the same HSB saturation (Figure 3, right). (“Brightness” (B) in HSB is a nonlinear measure of luminance relative to the maximum possible for a given H and S).

Saturation seems likely to be important in the capability of our visual system, discussed previously, to disentangle object colours and illumination. Hue and saturation together are the way in which we perceive chromaticity, and uniform chromaticity provides our visual system with a clue as to which patches of the visual field represent the same stuff, and based on that, which variations in luminance are likely to be due to illumination. Figure 4 (left) shows how readily we perceive light of uniform hue and saturation and varying brightness as uniformly coloured objects under varying illumination.

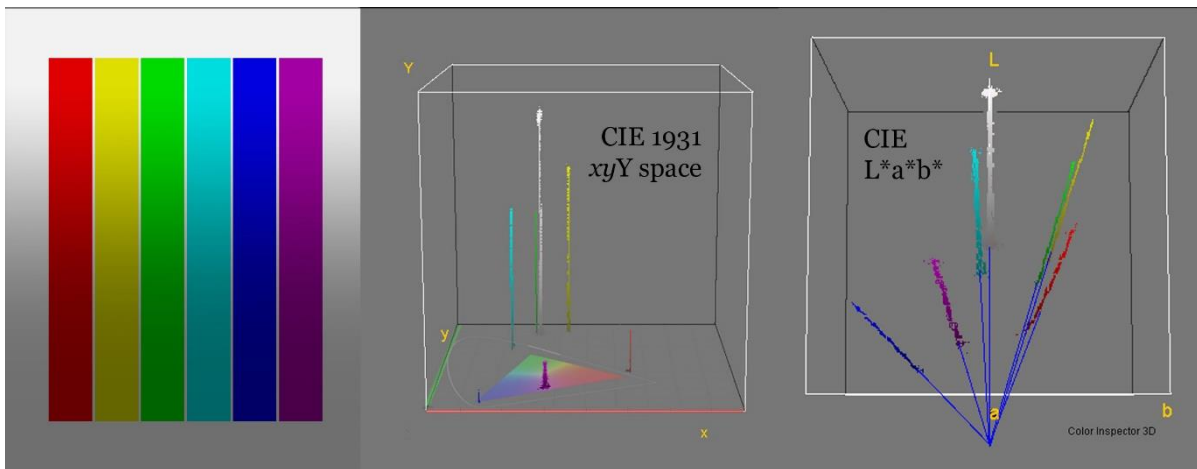

Figure 4: Left: seven fields (including the achromatic surround) of uniform chromaticity and varying luminance are readily perceived as uniformly coloured objects under varying illumination. Middle and right: the same fields plotted in the CIE 1931 xyY and CIE L\*a\*b\* colour spaces, using the Color Inspector 3D plugin in Image J.

### BRILLIANCE AND BLACKNESS

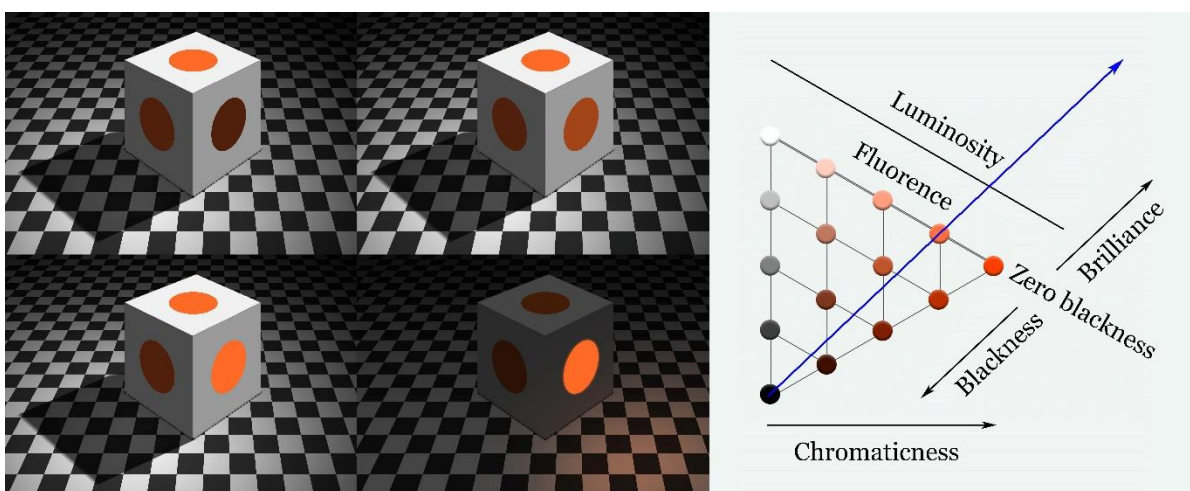

Figure 5: Left: the circle on the right face of each cube maintains the same chromaticity (perceived as hue and saturation) and varies in luminance relative to its environment, following the path of the blue arrow in the right-hand diagram. Right: object colour hue page subdivided according to blackness and chromaticness (relative chroma), diagrammatically showing relationship to perceptions of fluorence and luminosity.



*Brilliance* is a scale of colour appearance investigated in detail by Evans (1974) and assessed as important by Fairchild (2013, p. 407). If a light stimulus of fixed chromaticity increases in luminance from zero to very high in relation to its surroundings, it passes through a consistent series of stages, appearing black until a “black threshold” is reached, and then passing through decreasing degrees of *blackness* (called *grayness* by Evans) to a point of *zero blackness* (called  $G_0$  by Evans) and then going on to appear *fluorent* (fluorescent looking) and ultimately self-luminous. The circle on the right face of the cube in Figure 5 (left) illustrates four stages of this sequence. At low luminance (the same as for the circle on the left face), the circle exhibits a high degree of blackness (top left). At a certain luminance relative to its white-appearing surround, the circles on all three faces exhibit approximately zero blackness (top right). At a somewhat higher luminance (the same as for the circle on the top plane), the circle exhibits fluorence (bottom left). At a much higher luminance relative to the environment (but in absolute terms the same as in the third image), the circle appears self-luminous (bottom right). Evans suggested that brilliance may be considered negative for blackness (“grayness”) and positive for fluorence, or as simply continuous from the black point (Evans, 1974, p. 100).

The attribute of blackness has since become well known through its use in the NCS, in which object colours are conceived as being made up of black, white and chromatic perceptual components, as illustrated in Figure 5 (right). As these components are considered to add up to 100, it is only necessary to specify two of them: black content (*blackness*) and chromatic content (*chromaticness*).

Evans showed that perception of zero blackness (his  $G_0$ ) occurs at a luminance that varies greatly depending on the chromaticity of the stimulus. Correspondingly, zero blackness in the NCS Atlas occurs at a varying lightness levels, tracking just above the top of the range of physically realized paint chips. Brilliance thus seems to be a perception of luminance relative to the maximum luminance possible or unconsciously expected for light-reflecting objects of a given chromaticity.

## **CONCLUSION**

The six perceived colour attributes defined in the CIE ILV, along with brilliance and NCS blackness, are well suited for describing and appreciating the intricacies of the appearance of illuminated objects, which entails co-occurrent perceptions of a seemingly intrinsic object colour, a pattern of illumination, and a pattern of patches of light reflected to the eye from different areas of each object. Confusion about these colour attributes can be addressed using suitable illustrations and explanations.

## **REFERENCES**

- Briggs, D. J. C., 2020. Chapter 9, Colour spaces. In: *The Routledge handbook of philosophy of colour*, D. H. Brown and F. MacPherson eds, Routledge, London and New York.
- Centore, P., 2011. Shadow series in the Munsell system. *Color Research and Application* 38 (1): 58-64.
- CIE, 2020. *CIE S 017:2020 ILV: International Lighting Vocabulary* (2nd edition). Commission Internationale de L’Eclairage.
- Evans, R., 1974. *The perception of colour*. John Wiley and Sons, New York, London, Sydney, Toronto.
- Fairchild, M., 2013. *Color appearance models, 3<sup>rd</sup> edition*. John Wiley and Sons, UK.
- Hunt, R. W. G., 1977. The specification of colour appearance. I. *Concepts and terms, Color Research and Application* 2: 55–68.
- Hunt, R. W. G., 1978. Colour terminology. *Color Research and Application* 3: 79–87.
- Long, J. T., 2021. *The New Munsell Student Color Set*, Sixth Edition. Fairchild Books, New York.

# Analysis and Application of Artwork Color – Awakening Students' Color Aesthetics and Narrative Ability through Artworks at the National Palace Museum in Taipei

Ching Chih Liao <sup>1,\*</sup>

<sup>1</sup> Department of Commercial Design, Ming Chuan University, Taoyuan, Taiwan; ccliao@mail.mcu.edu.tw

\* Corresponding author: ccliao@mail.mcu.edu.tw

## Abstract

As many observe, aesthetic experience and awareness of color aesthetics is rather limited among new university design students, and their frequent use of mobile phones and social media erodes their narrative ability. Therefore, units for a required Color Theory course were designed based on cultivating the color aesthetic experience and narrative (storytelling) ability of these students. Peers evaluated naming a theme and theme story narration, self-portrait drawing, color naming and color matching, as well as completed a self-evaluation of their own learning. Research results show that this instructional design helps to improve students' color association and color matching abilities and enhances their aesthetic experience, with significant highly positive correlations. However, the correlation between narrative ability, color matching and color association abilities, and aesthetic experience is relatively weak. The former suggests a future direction in the teaching of Color Theory, while the latter illustrates a need to further bolster narrative ability.

**Keywords:** *Color matching, Aesthetic experience, Narrative ability, Peer evaluation*

## INTRODUCTION

Aesthetic experience is essentially an emotional and perceptual experience (Lin 2009). Considering new university students have been living under the pressure of being accepted at a tertiary institution for a long time, their aesthetic experience and stimulation from color aesthetics in daily life is often rather limited. If students lack aesthetic experience and low perception in daily life, how can they start thinking creatively and create a moving brand story? Therefore, educators have the responsibility to design appropriate teaching materials for the learning process, so that university freshmen can truly observe daily life, regain their sensitivities, and awaken color awareness.

Furthermore, there is concern that the new generation uses electronic telecommunications products frequently and their reading is reduced, so narrative ability suffers. Good expression and communication skills are qualities that a good designer should have, so curriculum design should foster these as well as allow design students to experience daily beauty; awaken color perception and color matching acuity. Cultivating the ability to express thoughts in written words or oral communication is extremely important, especially in the face of the artificial intelligence trend. As human beings, it is essential for designers to cultivate abilities that cannot be replaced by machines.

Therefore, in order to initiate the freshmen aesthetic experience, color ability and enhanced narrative ability are set as the teaching basis of this Color Theory course. Storytelling and peer evaluation are introduced as the teaching method and evaluation strategy. The purpose of this teaching research is to observe: 1. whether this instructional design helps to improve students' narrative and color matching abilities and aesthetic experience; and 2. whether there is a correlation between narrative (storytelling) ability and color matching performance ability.

### Narrative Ability and Storytelling

According to the current Taiwan Ministry of Education's plan to integrate professional knowledge and narrative ability, comprehensive competence in listening, extracting, reading, writing, oral

Analysis and Application of Artwork Color – Awakening Students' Color Aesthetics and Narrative Ability through ... presentations and communication is the goal (Taiwan Ministry of Education 2016). Narrative ability is the basic method for human thinking and organizing knowledge; people think, express, communicate and communicate in a narrative way in daily life as a means to understand people and events. However, not everyone has good narrative skills to cope with study, work or life. Some are unable to integrate what they have learned into daily work or life (Berryman 1991), which has gradually attracted the attention of scholars since the late 1990s.

Therefore, scholars have successively applied narrative or narrative analysis to different fields, such as visual narrative research to explore the causes of low modeling creativity in ceramic art (Lee 2019). Some have also applied these methods to cross-disciplinary learning, hoping to train students to have the aesthetic narrative ability for creative expression and humanistic care (Wang 2012). Others have integrated marketing expertise into narrative training, based on the story map style theory to guide students to design story marketing (Tsai 2020).

Narrative analysis is a methodology that studies the narrative logic of people telling stories, as storytelling is a specific action of narrative behavior. According to Livo and Rietz (1986), a story is a reorganized daily experience; through which people understand and remember things more easily.

### **Aesthetic Experience**

Silverman (1997) noted that aesthetic experience in learning is a cognitive function that combines emotion and cognition, while Broudy (1988) stated that aesthetic experience permeates everywhere. Whatever can foster students' feelings and performance abilities is their experience. Eisner (2002b) pointed out that changing the core values of school education to include more emphasis on inquiry rather than discovery allows aesthetic experience to be practiced in school education.

Aesthetic experience has different characteristics in each subject (Lin 2009, 2012; Zhou 2011). This teaching research was initiated in order to understand the characteristics of aesthetic experience in a Color Theory course. The project focuses on the stimulation of color perception, inspiring students to observe and explore extensively, and then attain the experience of multiple color matching.

### **Color Matching Theory**

Van Gogh once said: "There is no bad color, only a bad combination," which illustrates the importance of color matching. The ultimate goal of color matching is to harmonize, and harmonization refers to making two or more adjacent colors appear to produce a pleasant effect (Judd and Wyszecki 1975). Bottomley and Doyle (2006) noted that when the emotional value of product positioning and the feeling about a product are linked, the higher the color consistency, the more the sales rate can be increased.

Goethe, Chevreton, Munsell, Itten and others have all had their own differing but close views on color matching. Fusion of their views, especially Chevreton's, has become the generally accepted modern color matching principle (Wei et al. 2019). Color matching skills also involve changes in harmonizing attributes, such as area, association interaction, etc., as these also affect color matching, which can follow theoretical principles or be compiled through experiences such as savoring the aesthetics of life.

## **METHOD**

### **Teaching Design and Research Design**

This teaching plan comprised three units: (1) color theory; (2) topic discussion; and (3) practical color application. This research focused on a specific unit of practical training in Color Theory in which students chose a Taipei Palace Museum artifact or painting for color analysis and learn to name colors. Before analysis, they were to read and understand the era and creator of the work as well as background information related to the piece. Then, each student proposed a self-portrait theme, narrated a theme story, and applied color to their self-portrait according to the proportions of various colors on the artifact or painting. For experience sharing of color matching methods, students responded in the discussion area of the E-teaching platform provided by the university. The volume of information in the discussion area was so large that it was not included in the scope of this paper.

Finally, a total of 10 student works were selected for production of a questionnaire divided into two parts: self-portrait evaluation and self-learning evaluation. Referring to Lin's (2012) scale on the development of learning indicators in the field of aesthetics in the syllabus of Taiwan's kindergartens, quantitative measurement for the content of the two parts of the questionnaire was drawn up. The total of 12 questions covered aesthetic attitude, color matching performance (including color awareness, color emotion, color association), narrative ability (including color naming, theme proposal, story writing), and self-learning evaluation topics. The collected data was tested by the repeated measures ANOVA, one sample t-test, and Pearson correlation coefficient test.

### Participants

Most of the participants were first-year Commercial Design students, with a small number from other departments. There were 63 students in total, with an average age of 19.23,  $SD=0.83$ .

### Stimuli

The works of 63 students were divided into three levels: high, medium, and low performance. Two research assistants selected three works from each of the three levels (four where there were more excellent works). A total of 10 works (Figure 1), numbered from No.1 to No.10, were combined with 7 questions evaluating the works to design a questionnaire as a data collection tool.

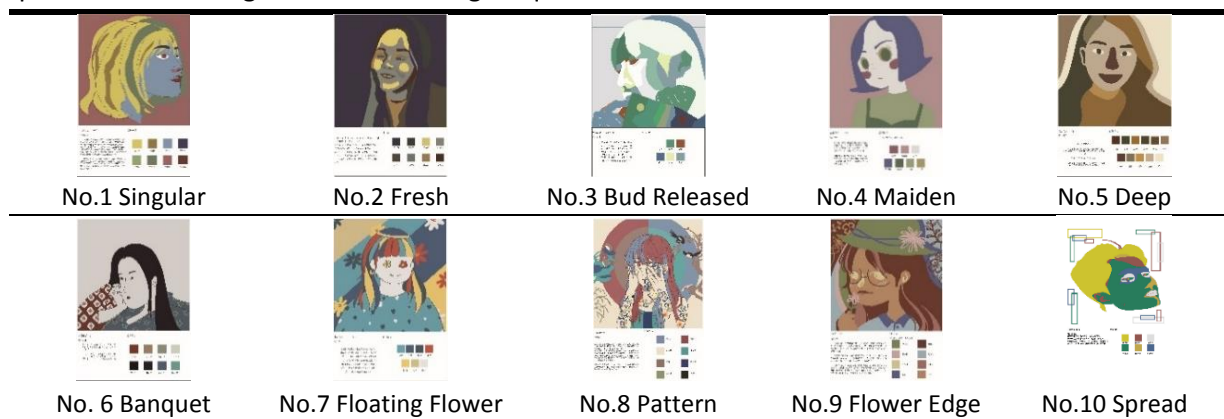

Figure 1: Experiment Sample Set.

### Questionnaire Design

The operative definition of narrative ability used herein is the ability to name colors, propose a theme, and develop a story along a theme. A total of 7 items were drawn up for the evaluation of the work, using a quasi-quantitative measurement referring to the scale used by Lin (2012): Q1- creativity of proposed theme; Q2- creativity of story narrative; Q3- fluency of story narrative; Q4- creativity in color

naming; Q5- drawing skill on self-portrait; Q6- alignment of color use on self-portrait with the artistic conception of the story; Q7- harmony of color matching on self-portrait. In addition, there were 5 items for self-study evaluation: Q8- Improvement of my color matching ability through the analysis of artifacts and self-portrait drawing (can reflect impressions of harmony and coordination); Q9- Improvement of my color association ability through the analysis of artifacts and self-portrait drawing; Q10- Stimulation of narrative ability of storytelling through the analysis of artifacts and self-portrait drawing; Q11- Stimulation of narrative ability of color naming through the analysis of artifacts and self-portrait drawing; Q12- Enhancement of color aesthetics experience through the analysis of artifacts and self-portrait drawing. The selected self-portraits were combined with the first seven items, followed by the five self-evaluation items, on a Google form, measured using a Likert 7-point scale, with 1 as lower degree of affirmation and 7 as higher degree of affirmation.

### Procedure

For the scoring, participating students viewed the theme, story narration, color names, drawing skills, and color matching of each work to be evaluated, which appeared randomly. The evaluation of the 10 works was completed first, then students engaged in the self-study evaluation.

### RESULTS

A total of 63 data sets were collected, among which four participants had flaws in their data, so they were discarded and not included. Finally, 59 data sets were analyzed. The data was divided into two parts: work evaluation and self-evaluation. The analysis results are as follows.

#### Evaluation of works

It can be seen from Table 1 that the performance of the 10 works yields  $F(9,522)=22.87$ ,  $p<0.001$ , partial  $\eta^2=0.28$ , meaning there is a significant difference between at least two works. After Scheffe post hoc test, based on averages it is found that S8, S6, S3, S5, S9> S4, S1, S7, S2> S10; S8, S6, S5, and S9 scores are higher. Notably, the two works S8 and S6 performed better on the seven items on average. The relatively low average of S10 shows weak performance in all aspects; but it is still over four points of verification value. In other words, following this color practice exercise, the self-portrait works produced under the course design can lead to students being generally affirmed by their peers for theme proposal, theme narrative ability, color naming, image drawing and color matching ability.

From the results of using these seven items for evaluation (Table 1),  $F(6,348)=17.58$ ,  $p<0.001$ , partial  $\eta^2=0.23$  shows a significant difference between at least two items. According to Scheffe post hoc test, it is found that Q7> Q6, Q1, Q5> Q3> Q4, Q2 based on averages. The performance on these seven items is substantially affirmed, with Q7 having the highest average score, meaning that the 10 works are all highly affirmed on Q7- harmony of self-portrait colors. Relatively lower average scores are attained on Q3- fluency of storytelling ability, Q2- creativity of storytelling and Q4- creativity of color naming; that is to say, students honestly reflect that there is still room for improvement in naming colors and storytelling skills.

Effects	Sum of Squares	Df	M Square	F	p	Partial $\eta^2$
A. Samples, $n=10$	364.913	9	40.546	22.877	.000***	.283
std dev	925.159	522	1.772			
B. Evaluation Items, $n = 7$	130.895	6	21.816	17.582	.000***	.233
std dev	431.791	348	1.241			

Table 1: Works and questionnaire items ANOVA.

\*\*\*  $p<.001$

### Self-evaluation

For the five self-evaluation items, a one sample t test analysis is conducted first, then five points are used as the test standard to test each item one by one. The analysis results for students' self-evaluation can be seen in Table 2. The  $p$ -value for response to all items is  $<.001$ , reflecting that the participating students highly confirm and accept that they were trained through the assignment; they agree that it improved their abilities in color matching, color association, story narration, color naming, and furthered their aesthetic experience.

	<i>t</i>	<i>d</i>	<i>p</i>	mean dev
Q8- Color matching ability	10.077	58	.000	1.118
Q9- Color association ability	10.991	58	.000	1.152
Q10- Narrative ability of storytelling	3.763	58	.000	.525
Q11- Narrative ability of color naming	7.300	58	.000	.966
Q12- Enhancement of color aesthetics experience	11.079	58	.000	1.237

Table 2: Self-evaluation one sample t test.

The data then underwent analysis for Pearson Correlation Coefficient, the results of which are shown in Table . In general, only color association, enhanced aesthetic experience and color matching ability have a significant and highly positive correlation; color association and enhanced aesthetic experience have a significant moderate positive correlation. It can be seen that narrative ability is relatively weakly correlated with color matching ability, color association and aesthetic experience.

	1. Color matching ability	2. Color association ability	3. Narrative ability of storytelling	4. Narrative ability of color naming
1. Color matching ability	-			
2. Color association ability	.70***	-		
3. Narrative ability of storytelling	.40**	.34**	-	
4. Narrative ability of color naming	.30*	.47***	.42**	-
5. Enhancement of color aesthetics experience	.71***	.64***	.38**	.44***

Table 3: Correlation matrix between the five self-evaluation items.

\* $p<.05$  \*\* $p<.01$  \*\*\* $p<.001$

### DISCUSSION AND CONCLUSION

Through this teaching activity of using cultural relics to awaken students' color aesthetics and narrative abilities, students analyzed colors on artifacts or paintings, then applied the same colors in like ratio to their own self-portrait. Following, they engaged in peer evaluation and self-evaluation. According to the analysis results, overall color matching application ability was greatly improved. It is assumed that since the color matching is based on the analysis of the readily viewable museum works, this can increase students' proficiency as reflecting on the creations of others is one way to learn color matching. As students were encouraged to browse the National Palace Museum website carefully, reading about and viewing the cultural relics to choose an image for analysis, this was an eye-opener for freshmen. Therefore, the participants affirmed that such an experience was good for them and significantly enhanced their aesthetic experience.

In comparison, there was no significant effect on students' narrative ability, because that was not within reach in the brief duration of this experiment. Cultivating narrative ability requires extensive reading, training in abstracting and communication practice over time to see the desired effects.

Although there is a correlation between narrative (storytelling) ability and color matching ability, it is not a high correlation. This needs to be strengthened for enhanced imagination and creativity.

In summary, color association ability is significantly and highly positively correlated with the enhancement of aesthetic experience and color matching ability. In future teaching, color association and aesthetic experience can be strengthened to improve color matching ability. The highly positive correlation between enhanced aesthetic experience and color association ability may stimulate students to have more diversified daily life or color experiences to improve their color association ability. Teaching activities such as this one can also stimulate students' motivation to browse through museum collections. What they learn is not only color experience, but also shape and composition, because form and color are inseparable.

### **ACKNOWLEDGMENTS**

Thanks to all the first-year students of Ming Chuan University Commercial Design Department who participated in this teaching activity and provided their works as experimental materials.

### **REFERENCES**

- Bottomley, P. A., and J. R. Doyle. 2006. The interactive effects of colors and products on perceptions of brand logo appropriateness. *Market Theory* 6(1): 63-83.
- Broudy, H. S. 1988. *Aesthetics and the Curriculum*. In W. F. Pinar (Ed.), *Contemporary curriculum discourses*. Scottsdale, AZ: Gorsuch Scarisbrick. pp.332-342.
- Eisner, E. W. 2002b. What can education learn from arts about the practice of education. *Journal of Curriculum and Supervision* 18 (1): 4-16.
- Judd, D. B., and G. Wyszecki. 1975. *Color in business, science, and industry*. New York: Wiley-Interscience.
- Lee, Z. P. 2019. A Study of Using Visual Narrative to Analyze the Reasons and Evolutionary Form of Low-Creativity Ceramic Throwing Learner from Creative Self-Efficacy Approach. *Journal of National Taiwan College of Arts* 104: 53-79. (in Chinese)
- Lin, M. C. 2012. The Development on the Learning Indicators of Aesthetic Domain for Kindergarten Curriculum in Taiwan-Using the Construction of Drama Indicator and Scale as Example. *Contemporary Education Research Quarterly* 20(4): 1-44. doi:10.6151/CERQ.2012.2004.01 (in Chinese).
- Lin, S. C. 2009. The Inquiry of Aesthetic Experiences and the Implication for the Construction of Curriculum Aesthetics. *Tung Hai Education Review* 3: 43-70.
- Livo, N. J., and S. A. Rietz. 1986. *Storytelling: Process and practice*. Littleton, CO: Libraries Unlimited.
- Silverman, J. 1997. The aesthetic experience of learning: Sketching new boundaries. *Journal of General Education* 46(2): 73-95.
- Taiwan Ministry of Education. 2016. *Innovative Group Curriculum Program for the Integration of Professional Knowledge and Narrative Ability*. Online: <https://www.edu.tw/focus/Default.aspx>
- Tsai, L. L. 2020. Evaluation of Learning Effectiveness of Integrating Narrative Training into Commercial Courses. *Journal of Innovation and Business Management* 9(1): 51-65. doi: 10.6270/JIBM.202006\_9(1).0005 (in Chinese)
- Wang, M. 2016. A Program design of multiple-fields learning in terms of narrative-as an example of culinary and image-inspired by instinctive aesthetic. *Takming University Journal* 14(1): 65-76.
- Wei, S. T., H. S. Chen, M. C. Hsu, W. Y. Lee, T. J. Hsieh, R. C. Wu, and P. L. Sun. 2019. *New Color Theory*. Taipei: Wu Nan Publishing (in Chinese).

# Factors that Influence Color Choice – A Study of Cultural, Symbolical and Synesthetic Behaviors

Woon Lam Ng <sup>1,\*</sup>

<sup>1</sup> Nanyang Technological University: ngwoonlam@ntu.edu.sg

\* Corresponding author: Woon Lam Ng: ngwoonlam@ntu.edu.sg

## Abstract

This paper is a study of color choice based on cultural, symbolic, or emotional context. This contextual background further connects to basic and strong synesthetic behaviors. There was minimum statistical proof of any universal human response that has a closed relation to cultural or emotional context. The only exception is the basic synesthetic behavior that connects to people's common experiences. The findings suggest that there are diverse decisions made based on every contextual background. The research findings serve the pedagogical design that includes the teaching of color application related to the cultural, symbolic, or emotional context. The training of color application has to be bound by the pre-defined contextual background. Some basic synesthetic responses may be taught. Extensive discussion of the synesthetic connection between color and other sensing responses should be avoided.

**Keywords:** *Color, Cultural, Symbolical, Synesthesia, Pedagogy*

## BACKGROUND INFORMATION

In practical color theory training for art students or artists involves two main aspects of knowledge. First is the visual response of human eyes which is common to everyone. For example, yellow has a lighter tone than black which is universally true to everyone. Therefore, the construction of any scientific color theory framework is a process to identify the independent parameters that affect the final human visual response. The most common independent parameters are hue, lightness (or tone), and chroma (or saturation - based on the difference in the definition of how measurements are carried out).

However, the second set of factors, the cultural, symbolical, or emotional choice of colors have issues. There are too diverse meanings of colors across cultures. In a cross-cultural study related to the meaning of colors, out of 23 samples, a researcher accepted up to 5 exceptions and used this to determine the affective meanings of each color. Thereafter decided if each color meaning analyzed was 'universal'. 5 out of 23 is not a number that can be ignored and hence this has indicated it is harder to have universal agreements related to the affective meanings of colors (Adams et al. 1973). Moreover, there are colors that carry very opposite meanings which creates more confusion. Naz's study of college students related to color and emotion (2004) also presented the same colors that carry opposite meanings. Red and green were examples used by other researchers' studies that had similar discrepancies (Davey 1998; Mahnke 1996; Saito 1996). A study also shows that color preferences are highly associated with age, racial groups, and cultures (Adams et al. 1973; Eysenck 1941). Even across different geographical regions within the same country, colors do not carry common meanings (Naz et al. 2004). This is further supported by studies done across distinct cultures. Colors are arbitrarily associated with certain meanings across different cultures (Osgood et al. 1957; Young 1971).

Among the three attributes of color, tone (lightness), hue, and chroma, Gao's study found that lightness and chroma are correlated to two extreme ends of emotional response while hue could be correlated to a certain extend. The results are also independent of cultural background (2007). Emotional associations were also found to be correlated to brightness and saturation. Brightness and saturation are equivalences to lightness and chroma respectively with slightly different mathematical definitions. A yellow object presents a cheerful outcome only because it is light and saturated. It is not because of the hue (D'Andrade et al. 1974).



It is not difficult to understand this fact. Lightness, a measurement of our visual response to the strength of light, and chroma, the purity of a hue are both connected to the physical response of human vision. Therefore, these two factors are easily correlated to the speed of visual response. The speed of visual response can be linked to two ends of emotion. For example, slow responses are generally related to cozy, comfortable, relaxed, meditating, or any subtle modes while a fast response is likely related to aggressive, strong, impulsive, or any fast and immediate modes. On the contrary, the hue is not a measurement of any physical strength of our visual response, therefore, it could not be correlated.

Italians relate lower chroma colors to softness while Swedes differentiate them through hues; seeing red and yellow as soft and blue as hard. No quantification is possible for these two cases. It is contextually dependent (Gao et al. 2007).

In a syllabus of 'Special Topics in Graphic Design: GD 390-501' from Depaul University, it specifies that students learn how colors affect people emotively using color choice in branding as an example (Quinn 2015). However, in another training syllabus, another instructor indicates that there is no universal relation between colors and emotions (Leong). Leong discussed basic synesthetic responses of colors, covering color representations of seasons, environment and human behaviors. Some representations even fall into both positive and negative realms.

### **CULTURAL, SYMBOLIC AND EMOTIONAL REPRESENTATIONS WITH COLORS**

Cultural, symbolic and emotional representations are three major areas of application of colors connected closely to human activities. In cross-cultural research related to the symbolic meanings of colors, Yu (2014) looked into color symbolism that covered cultural, mythical, historical, religious, political, and linguistic connections. The research data showed that ancient color symbolism largely derived its reference from nature. For example, blue would stand for the sky, and it was further connected to spirit and truth. However, the interpretations may be different for diverse cultural environments (Yu 2014).

*'For the ancient Mayas of Central America, the directions east, north, west, and south were associated with red, white, black, and yellow, while in ancient China east, south, west, north, and center, with blue, red, white, black, and yellow. Religion often overlaid this with other significance (Yu 2014).'*

For indications of directions, the research findings above did not indicate the reasons for the choice. However, the findings clearly indicate the subjective difference from culture to culture. A similar difference is also seen in religion; where the Buddhists use yellow as the color of humility while in Christianity, white is the color used to indicate purity. The difference also extends to different geopolitical locations (Yu 2014).

Some examples of symbolic representation differences of color are shown. Yellow means 'deceit' or 'cowardice' in Northern Europe, while it carries positive meaning in Chinese culture and Buddhism, representing imperial quality and humility or renunciation respectively (Yu 2014).

The author believes that a cultural elite dominates the meaning of color over time which restricts the creativity of the human mind. However, I will argue that it has nothing to do with that. It was just a creative choice of any culture at that moment of definition because there is no universal truth about color meaning. This is different from the universal property of color, for example, black is darker than white. No one in this universe could see white darker than black, or else we have to rethink how to use or teach color. The author chose three very concrete examples between the English language and Chinese language as tabulated below (see Table 1) (Yu 2014).

English	Chinese
Black Tea	Red Tea (红茶)
Brown bread	Black bread (黑面包)
Green-eyed	Red-eyed (眼红)

Table 1: Comparing the difference in color representation between English and Chinese language, of the same subjects (Yu 2014).

Bradfield found that even internet culture today could start to influence meanings of color (2014). One interesting finding by Dixon is the nomenclature difference between cultures which further complicates the issue.

'...for instance, Blue and Green are not distinguished in the languages of some peoples, while others confuse Dark Blue with Black. Not that the difference between the colors is not recognized, but that the principles of color-nomenclature are different. ...(Dixon 1899).'

Dixon concluded that diversity and non-uniformity are the characters of color-symbolism. The meanings lie in people's choices based on their diverse cultural backgrounds.

### **COLORS AND SYNESTHESIA**

Synesthesia is a kind of sensory association between color and other human senses. Synesthetic phenomena commonly observed and studied are the association between colors, musical notes, alphabets, or even weathers (Lone et al. 2003). A neuro-history and arts research listed scientists, artists, writers, and musicians who carried this synesthetic experience, namely Charles Baudelaire, Arthur Rimbaud, Alexander Scriabin, Vassily Kandinsky, Vladimir Nabokov, Sergei Eisenstein, David Hockney, and Richard Feynman. The syndrome of synesthesia is an individual's complex sensual response. When one receives a stimulus in one sense modality, at the same time, one experiences a sensation in another (Lone et al. 2003). Kandinsky is probably the most interesting one as he was the Bauhaus master who attempts to teach the meanings of colors in relation to music equivalence (Kandinsky 2005).

*'Keen lemon-yellow hurts the eye in time as a prolonged and shrill trumpet-note the ear, and the gazer turns away to seek relief in blue or green (Kandinsky 2005: 28).'* In Kandinsky's research and teaching, he indicated the psychic effect of colors.

*'For example, red may cause a sensation analogous to that caused by flame, because red is the colour [sic] of flame. A warm red will prove exciting, another shade of red will cause pain or disgust through association with running blood. In these cases, colour [sic] awakens a corresponding physical sensation, which undoubtedly works upon the soul (Kandinsky 2005: 28).'*

Kandinsky's experience of 'colored hearing' was a common form of synesthesia. His efforts to relate colors with music were connected to his personal experience from his synesthetic response of cross-modal sensitivity. This genetic response only appears in some people. Therefore, his effort of generalizing cross-sensual exchange could not function in a larger population (Lone et al. 2003). Hence, Kandinsky's idealistic approach at the Bauhaus to scientifically correlate artistic responses to visual elements and visual approach had failed (Jones 1929).

Interestingly, the art critic Clement Greenberg thought that Kandinsky had drawn too many connections between painting, music, and mathematics (Berry 1995). However, he probably did not realize that this quality was flowing in the blood of the artist as a genetic response. Another also

confirmed that synesthesia was caused by a genetic mutation of neural sensory (Ramachandran et al. 2001).

In a sampling study of 358 fine art students, 84 (23%) reported synesthetic experience. The research was trying to address the relationship between creativity and synesthesia since early data showed that a list of artists, writers, and musicians experienced synesthesia (Dailey et al. 1997; Lone et al. 2003). Creative and less creative participants had different levels of associations to perceptual correspondences. More creative people are inclined towards color-emotional associations while less creative people are inclined towards judgmental associations (Ramachandran et al. 2001).

The basic synesthetic response does exist in people at large as illustrated by the example below where kiki with sharper voice is thought to be connected with a sharper shape on the left while bouba as a rounded shape on the right as shown in Figure 1 (Ramachandran et al. 2001). This is an indication of cross-wiring of our brains. It further explains that artists, poets, and writers may have a high level of synaesthesia in general as compared to people at large.

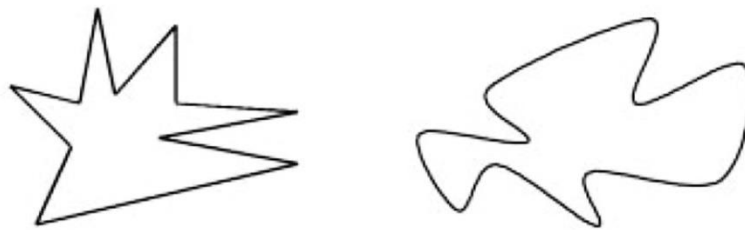

Figure 1: Demonstration of kiki and bouba. On the left, the sharper shape is generally (95%) connected with kiki while bouba is thought to be the shape on the right with more rounded edges. This is a synesthetic relation of shapes and voices (Ramachandran et al. 2001).

Another study of our positive emotional responses to green color is another evidence of common synesthetic response. The green color commonly suggests feelings of relaxation, calmness, happiness, comfort, peace, and hope (Saito 1996). In our living environment, a green color is generally associated with nature and the most positive season, the spring (Hemphill 1996). Hence, it directly builds a positive synesthetic response visually.

In film-making research, colors were studied against different sensual responses. The study suggested that the color application in the film was connected with senses of feeling (Yumibe 2009). Tinted colors were found to be more continuous while high chroma colors generated more discretions, affecting visual continuity (Jones 1929). However, these are just more generic responses that are commonly developed from human experiences. However, these generic qualities do not require any effort or education. It comes naturally from daily experience. For the case of tinted colors, naturally, our eyes see them as more continuous against a strong jump of high chroma colors that contrast each other in color attributes. However, it is too optimistic to simply generalize towards a lot of more complex situations. Therefore, the synesthetic connection could not be derived easily.

Similar to the objective of Kandinsky at the Bauhaus, more recent research was carried out to generalize color responses synesthetically to emotions (Cowan 2015). First, more generic examples like warm colors (red, orange, and yellow) are compared against cold colors (green, blue, and violet). Followed by colors mixed with white and color mixed with gray, the author referred to another source to suggest emotional responses (Kalmus 1935).

*'Grouping the colors in another manner we find that colors mixed with white indicate youth, gaiety, informality. Colors mixed with gray suggest subtlety, refinement, charm. When mixed with black, colors show strength, seriousness, dignity, but sometimes represent the baser emotions of life (Kalmus 1935: 143).'*

Looking at Kalmus's statement above, it not only could not be measured, but it could also further carry a subjective personal judgment. I may ask, "how dark the gray do I have to add to my pink to make it show seriousness or dignity?" This could hardly be answered. Intensive and focused teaching of color symbolism runs the risk of a problem similar to focusing on a synesthetic response that does not exist in everyone genetically. Another danger is also reflected in Kalmus's study of color consciousness. Red was pointed out to represent both positive and negative experiences in human life. It indicates love, happiness, physical strength, wine, passion, power, excitement, turmoil, tragedy, cruelty, etc. (Kalmus 1935). No way we can derive any systematic connection between a specific red to a specific emotional state. Therefore, it is dangerous to construct a pedagogical approach to teach these inconclusive responses. Practitioners in the field selectively learn these experiences and accepted them as norms in their particular industry. Norms in different industries may have some differences, which is acceptable. Within the same industry, practitioners can communicate without conflicts.

### **SUMMARY OF COLOR, CULTURE, EMOTIONAL RESPONSE AND SYNESTHESIA**

The discussions have suggested that color-cultural or color-emotional connections derived naturally through shared experiences of people at large and are acceptable as simple synesthetic responses. However, any attempt to extend this to a sophisticated and subtle relationship will not function well. Some generic responses are just common norms that do not need any extensive training. Hence, it is not advisable to focus on formulating a structural approach to teach students these topics. Practitioners pick up the specific meaning only when they join a particular industry. The focus on art students' training should be placed on universal qualities of colors in applications.

### **ACKNOWLEDGEMENTS**

The research is supported by School of Art, Design and Media, Nanyang Technological University, Singapore.

### **REFERENCES**

- Adams, F. M., and C. E. Osgood. 1973. A cross-cultural study of the affective meanings of color. *Journal of cross-cultural psychology* 4(2): 135-156.
- Berry, K. 1995. A Personal View on Greenberg and Kandinsky. *Journal of Aesthetic Education* 29(4): 95-103.
- Bradfield, E. L. 2014. *The Diversity of Color: an Analysis of Cross-cultural Color Symbolism*. (Honors), Andrews University, USA. Retrieved 03 Jan 2018, from <https://digitalcommons.andrews.edu/honors/90> (90)
- Cowan, P. 2015. The Democracy of Colour. *Journal of Media Practice* 16(2): 139-154.
- D'Andrade, R., and M. Egan. 1974. The colors of emotion 1. *American ethnologist* 1(1): 49-63.
- Dailey, A., Martindale, C., and J. Borkum. 1997. Creativity, Synesthesia, and Physiognomic Perception. *Creativity Research Journal* 10(1): 1-8.
- Davey, P. 1998. True colours. *Architectural Review* 204(1221): 34-35.
- Dixon, R. B. 1899. The Color-Symbolism of the Cardinal Points. *The Journal of American Folklore* 12(44): 10-16. doi:10.2307/533763
- Eysenck, H. J. 1941. A critical and experimental study of colour preferences. *The American Journal of Psychology* 54(3): 385-394.

- Gao, X. P., J. H. Xin, T. Sato, A. Hansuebsai, M. Scalzo, K. Kajiwara,... and M. Billger. 2007. Analysis of cross-cultural color emotion. *Color Research & Application: Endorsed by Inter-Society Color Council, The Colour Group (Great Britain), Canadian Society for Color, Color Science Association of Japan, Dutch Society for the Study of Color, The Swedish Colour Centre Foundation, Colour Society of Australia, Centre Français de la Couleur* 32(3): 223-229.
- Hemphill, M. 1996. A note on adults' color–emotion associations. *The Journal of genetic psychology* 157(3): 275-280.
- Jones, L. A. 1929. Tinted Films for Sound Positives. *Transactions of the Society of Motion Picture Engineers* 13(37): 199-226.
- Kalmus, N. M. 1935. Color Consciousness. *Journal of the Society of Motion Picture Engineers* 25(2): 139-147.
- Kandinsky, W. 2005. Concerning the Spiritual in Art.
- Leong, L. Unknown. *Syllabus: Basic Principles of Color Theory*. In: Missouri, USA: College of Arts and Science, University of Missouri.
- Lone, A., and C. Tyler. 2003. Was Kandinsky a Synesthete? *Journal of the History of the Neurosciences*, 12(2): 223-226.
- Mahnke, F. H. 1996. *Color, environment, and human response: an interdisciplinary understanding of color and its use as a beneficial element in the design of the architectural environment*: John Wiley & Sons.
- Naz, K., and H. Epps. 2004. Relationship between color and emotion: A study of college students. *College Student J* 38(3): 396.
- Osgood, C. E., G. J. Suci, and P. H. Tannenbaum. 1957. *The measurement of meaning*. Univer. In: Illinois press Oxford, UK.
- Quinn, H. 2015. *Syllabus: Special Topics in Graphic Design*: GD 390-501. In: Chicago, IL, USA: Depaul University, College of Computing & Digital Media, School of Design, Graphic Design.
- Ramachandran, V. S., and E. M. Hubbard. 2001. Synaesthesia--A Window Into Perception, Thought And Language. *Journal of Consciousness Studies* 8(12): 3-34.
- Saito, M. 1996. Comparative studies on color preference in Japan and other Asian regions, with special emphasis on the preference for white. *Color Research & Application* 21(1): 35-49.
- Young, D. E. 1971. Color Preferences, Self-Concept and Role Expectations. *Western Canadian Journal of Anthropology* 2: 44-72.
- Yu, H.-C. 2014. A cross-cultural analysis of symbolic meanings of color. *Chang Gung Journal of Humanities and Social Sciences* 7(1): 49-74.
- Yumibe, J. 2009. 'Harmonious sensations of sound by means of colors': Vernacular colour abstractions in silent cinema. *Film History: An International Journal* 21(2): 164-176.

# Parametric Design Studio in Interior Architecture Education: A Case of Integration of Colour Design

Gülru Mutlu Tunca<sup>1</sup>, Saadet Akbay<sup>1,\*</sup> and Güler Ufuk Demirbaş<sup>1</sup>

<sup>1</sup> Department of Interior Architecture, Faculty of Architecture, Çankaya University, Ankara, Turkey;  
gulru@cankaya.edu.tr, akbay@cankaya.edu.tr, udemirbas@cankaya.edu.tr

\* Corresponding author: akbay@cankaya.edu.tr

## Abstract

This paper aims to disclose the alternative ways in which the interior architecture students integrate their colour design decisions as one of the main determinants of the project from the beginning of the design process. This revised approach is proposed in the third-year interior design studio course mainly specialises in the parametric design approaches in interior spaces. This paper outlines how colour design is integrated into stages thoroughly in the parametric interior design studio. The main motivation is to maintain a procedure that will make colour design decisions evolve through the whole design process as an integral part of it. This study suggests that producing colour charts from the initial stages of the design process, making colour design decisions for interior environments in 3D visualisations at all stages are critical for improving the student projects and helps them to envision and effectively reflect their atmosphere creations.

**Keywords:** *parametric interior design studio, colour design, colour decision making, 3D visualisation, interior architecture*

## INTRODUCTION

Colour has always been considered a significant denominator of atmosphere creation in interior architecture projects. Colour knowledge is perceived as students' liability in the design studios, yet they mostly attach their decisions at the final stage of the design process (Patera, 2009). Although students consider the importance of colour usage in their projects, as Pile (1997) claims, they prefer to work on the plan layouts, sections, and detailing rather than developing colour design decisions. This belated adaptation leads to a lack of intrinsic coherence in ambience and atmosphere creation in architectural space both in conceptual and practical phases. This paper concerns the alternative ways in which the interior architecture students integrate their colour design decisions as one of the main determinants of the project from the beginning of the design process and aims to disclose the transformation in terms of colour adaptation throughout the studio course. This revised approach is proposed in the second semester of the third-year interior design studio course. INAR 302 Interior Design Studio IV, abbreviated as 'Studio 302', mainly specialises in the experimentation of parametric design approaches in interior spaces, focusing on the design of complex identities and functional needs. Coined as a 'parametric interior design studio,' students mainly focus on form-finding experimentations, which suppresses other dynamics of atmosphere creation in interior spaces, such as colour and material selection. Thus, this paper discusses the integration of colour into the parametric interior design studio by analysing selected student projects and exploring the instrumentality of using colour charts to synthesise digital design and colour interpretations into interior architectural education.

## EDUCATIONAL CONTEXT

The Department of Interior Architecture within the Faculty of Architecture, Çankaya University, aims to provide students with a creative identity and technical knowledge of building science and

environmental issues. Students receive a Bachelor of Science Degree in Interior Architecture after a 4-year program. The design studios that contain diverse topics, specified according to function variety, architectural program complexity, and scale differences from small to extra-large constitute the curriculum's core. The educational strategy is studio and project-based learning. Design stages with cumulative requirements aim to develop the students' interpretations and solutions to a given problem.

As the form-finding and presentation methods shift from hand drawing to computer-based techniques, the third-year design studios concentrate on the digital strategies of form generation in interior space. Students encounter computer-aided design applications for the first time in Studio 301 and improve their skills in Studio 302, offered in the sixth semester. Technical knowledge to succeed at these studios is covered in theoretical and practical courses on the fundamentals of CAD applications, colour theory, and practices in 2D and 3D abstract designs. Concurrently with Studio 302, the curriculum offers a compulsory theoretical course (i.e., INAR 346 Colour Principles), which emphasises the communicative value of colour in interior architectural environments. Discussing the physiological, psychological, aesthetical, and functional use of colour in interior space and its role in visual ergonomics allows students to experience and apply colour in 3D visualisations of immersive interior spaces.

### **Studio 302 Project: Design Hub-Çankaya University—Parametric Rhizomes under a Futuristic Shell: Social Spaces for Pandemic Architecture**

'Parametricism' refers to generic design via algorithms (Schumacher, 2008; 2009). The parametric design process requires an algorithmic thinking system based on variables and evolvable parameters, measures, and rules (Jabi, 2013; Woodbury, 2010). Incorporating parametric design into the design studios in Turkey is a relatively new endeavour of interior architectural departments. Studio 302 has been devoted to the utilisation of parametric design and has employed the metamorphosis of parametric forms and colours concerning functional requirements on the interior architectural scale for the last five years. The design process is initiated with the analysis of environmental, architectural, and urban context to unveil the complex web of relations for deriving form-finding parameters adapted to the rhizomatic evolution of interior space.

In response to the COVID-19 pandemic, Studio 302 was held synchronously online using Zoom meetings with five instructors during the 2020-2021 spring semester. The studio course ran for eight hours per week for 14 weeks. The studio project was the re-functioning of an existing steel structure, located at Çankaya University Balgat Campus, as a design hub, accommodating social spaces of campus life. Located under an adaptive shell, cast by environmental factors and post-pandemic essentials, the design hub proposed to provide indoor and outdoor social zones for the meeting, studying, and conversation functions. Colour studies were integrated from the beginning of the design process until the end to overcome the suppression of colour decision-making and design by form-finding experiments. As the semester consists of three stages, each comprising a different phase of the project, the students tackled the colour design problem at different levels of consciousness.

#### *Stage 1: Preliminary research and conceptual development*

In Stage 1, the instructors launched to supervise preliminary analyses of the students on the proposed function and evaluate initial form-finding experiments. As the integration of the shell and the existing steel structure was an expectancy, the students drew the preliminary 3D diagrams for functional

allocation and circulation in correlation with the variety of environmental, urban, and social factors shaping the conceptual development. In addition, students developed the initial ideas of their colour design graphically through a colour chart, divided into slices, scaled according to the construction area of the architectural zones. This colour chart enabled the students to assign colours for each function via an inspiration image and perceive the connections, conflicts and overlaps between them regardless of context and material. It facilitated students to ponder whether the intensity and proportions of selected colours reflected the overall ambience they imagined. Figure 1 shows the students' initial colour design decisions for Stage 1 of their projects.

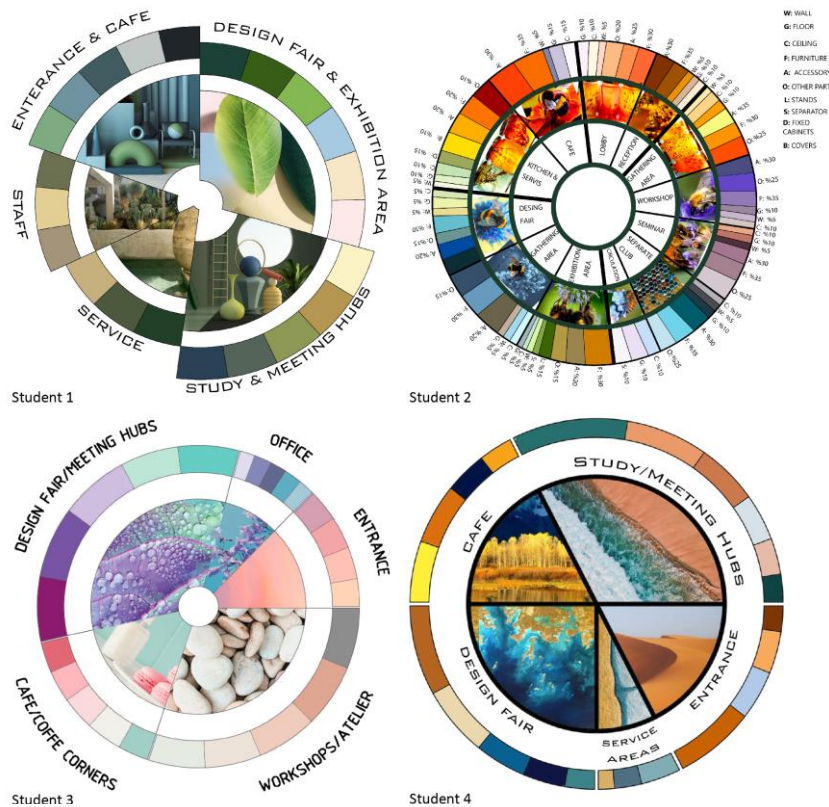

Figure 1: Colour chart examples from Stage 1.

*Stage 2: Interior design*

In Stage 2, the students started to work on the plan layouts and sections and continued developing the 3D visualisations of their project in line with studio critiques. They practised video rendering programs such as ‘Twinmotion’ and ‘Lumion’ to apply abstract colour selections on walls, floors, ceilings, and furniture/fittings. The video renderings remained symbolic since the material and lighting selections were undecided; yet they experienced reconstructing their theoretical depictions as practical ones and viewed the ambience they created in real-time renders. Figure 2 displays the outcomes of this stage.



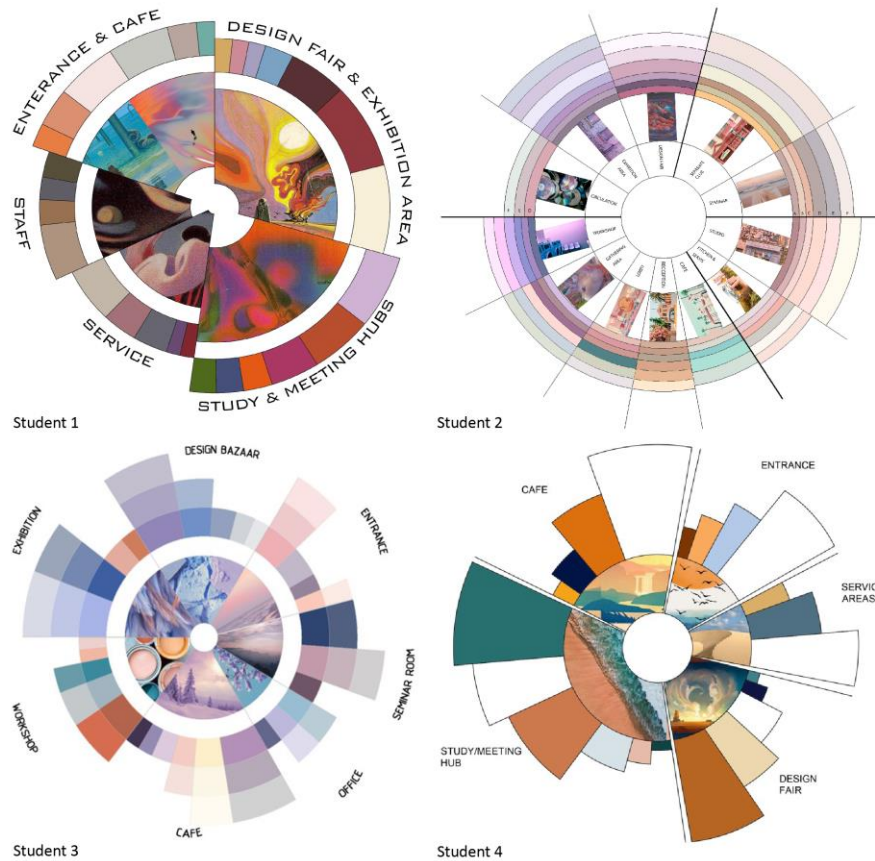

Figure 2: Colour chart examples from Stage 2.

*Stage 3: Detailed design of interior spaces*

In Stage 3, the students started to work on the detailed design of each function week by week. In addition to orthographic drawings such as plans, and sections on the scale of 1/50, they continued developing 3D video renders by encrypting materials, lighting elements, HVAC, and fire systems and prepared a material file. They also studied the system details of selected furniture or finishing with their immediate surroundings. In this phase, instructors expected the students to finalise their material and lighting decisions in the spaces and make alterations on the colour chart they first designed if necessary. Figure 3 presents the outcomes of the third and final stage.

**DISCUSSION**

This paper outlines how the colour design was integrated into a design project thoroughly with student approaches at each stage in the parametric design studio. An online survey was administered to students to understand their colour experiences. The primary motivation was to maintain a procedure that makes colour design decisions evolve through the design stages. In Stage 1, students used a colour chart to develop their initial colour design ideas, allocating colours to the chart to represent the architectural functions of the project using context-free inspiration images. When asked about the basis of their visual inspirations for the project’s spatial functions, students explained that their colour choices were either based on their personal experiences and preferences or inspired by nature. They also considered the colour psychology, ambience, and function of the spaces. In Stage 2, students started working on the plan layouts and sections and generated 3D visualisations and models of their

designs. They applied their colour decisions to the spatial elements and to improve their initial charts. When asked to describe the approaches that guided their projects' 3D spatial colour designs, students mentioned that they had considered parameters such as wayfinding, environmental factors (e.g., natural and artificial lighting), the materials, atmosphere creation, colour psychology, spatial/user identity, demographic features, and spatial functions. Students also reported that considering the walls, ceiling, floor, and furniture in an interior environment was the most leading motivator for their colour design decisions.

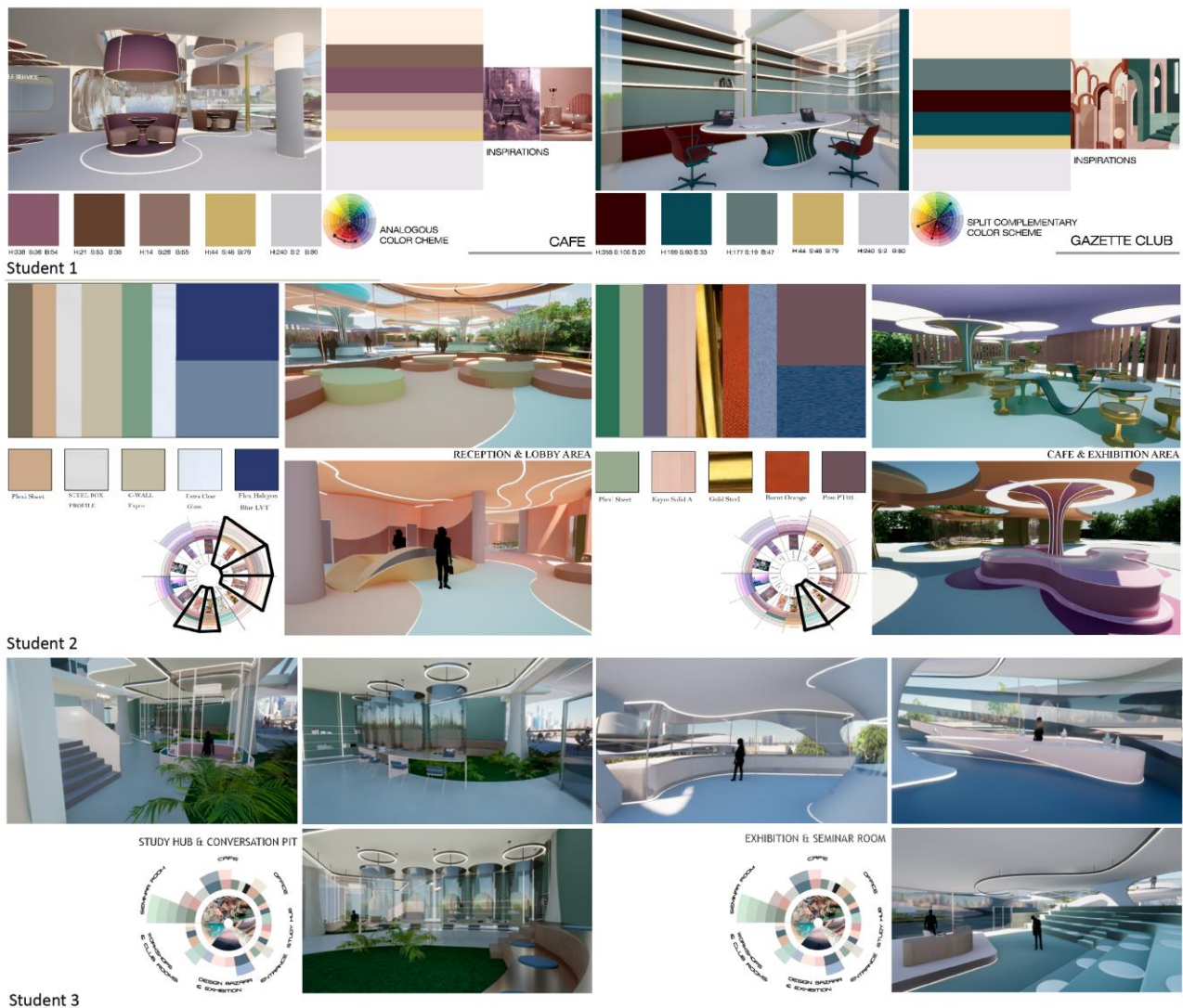

Figure 3: Colour applications from Stage 3.

In Stage 3, students adjusted their colour charts according to the detailed design of interior spaces. When asked about the differences between the initial colour design decisions and the final project outcomes, 50% of students asserted that their processes were consistent, whereas 50% stated that their outcomes were inconsistent. Students mentioned that the inconsistency was due to the rendering programs' limited colour palettes and material options. In addition, they argued that they were unable to apply their colour design decisions to materials and hence had to revise their initial colour charts. When asked which phase of the project colour design decisions should be studied, 34% of students stated that they preferred focusing on only one stage, either in conceptual development

or the interior design phase. 25% of students mentioned that they preferred focusing on two stages sequentially: conceptual development and the interior design phase, or the phases of interior design and the detailed design. 41% of students indicated that they were satisfied with their colour design decisions throughout all stages. This result suggests that producing colour charts from the initial stages of the design process, making colour design decisions for interior environments in 3D visualisations at all stages are critical for improving the student projects and helps them to envision and effectively reflect their atmosphere creations. Although students encountered some difficulties in converting their colour scheme into materials, as Billger (2004) states, through practice, students will gain more knowledge about how the interaction of coloured surfaces, coloured materials, and light is affected by their spatial contexts, and this will cultivate their subjective responses through experience (Akbay, 2006; Ural et al., 2017). In conclusion, the integration of colour design in both conceptual and practical means into all project stages, as one of the main determinants of interior space characteristics, is essential for the encouragement of students to develop an abstract methodology for colour decision making consistent with their conceptual approaches.

## REFERENCES

- Akbay, S. 2006. An Analysis of Basic design students' intuitive and analytic attitudes in colour decisions. In: *AIC 2006 Interim Meeting of the International Colour Association, Colour in Fashion and Colour in Culture*, Misty Hills, South Africa, 22-25.
- Billger, M. 2004. The experience of painted room: the significance of light and colour combinations. In: *AIC 2004 Interim Meeting of the International Colour Association, Color and Paints*, J.L. Caivano (ed.), Porto Alegre, Brazil, 219-222.
- Jabi, W. 2013. *Parametric Design in Architecture*. Hachette, UK: Laurance King Publishing.
- Patera, M. 2009. *The Potential of 3D Visualisation Technology in Art and Design Education*. [Ph.D. Dissertation]. The Glasgow School of Art, UK.
- Pile, J. 1997. *Color in Interior Design*. New York, NY: McGraw-Hill.
- Schumacher, P. 2008. *Parametricism as Style: Parametricist Manifesto* [11th Architecture Biennale, Venice].
- Schumacher, P. 2009. Parametricism: A new global style for architecture and urban design. *AD Architectural Design* 79(4): 14-23.
- Ural, S.E, S. Akbay, and B. Altay. 2017. Progression of color decision making in introductory design education. *Color Research & Application* 42: 849-860.
- Woodbury, R. 2010. *Elements of Parametric Design* (1st ed.). Routledge.

# Beyond the rainbow: a new sorting set for teaching colour

Paul Green-Armytage <sup>1,\*</sup> and Maggie Maggio <sup>2</sup>

<sup>1</sup> Curtin University; p.green-armytage@curtin.edu.au

<sup>2</sup> Smashing Color; maggiemaggio@gmail.com

\* Corresponding author: p.green-armytage@curtin.edu.au

## Abstract

In this paper we describe a new set of colours that can be used by children in primary school to explore colour relationships in both two and three dimensions. The set introduces many colours that are “beyond the rainbow” by intentionally expanding the familiar circle of vivid colours to include colours that are light, dark and muted, as well as vivid. These colours are featured on tiles that are easy to pick up and move around for sorting in two dimensions. The same colours are repeated on specially shaped cards that can be assembled to form simple three-dimensional models.

**Keywords:** *Colour education, Colour sorting, Colour order systems, Colour models*

## INTRODUCTION

The spectrum and the colour circle are prominent in science and art classrooms, but in each case the focus is on vivid colours. Each presents a two-dimensional view of colour relationships. We argue that learning about colour is best begun with an introduction to colours in many variations – not just the vivid colours, but also the light, dark and muted colours that we see around us. To help children learn about more colours we have designed a calibrated set of colour tiles that can be used for sorting exercises. These tiles, and the same colours on sets of colour cards, can also be used for playing games that are enjoyable while reinforcing colour concepts as they are being introduced. For further reinforcement, children can construct a simple three-dimensional model. After particular colour relationships are pointed out, children can explore the variety of colours in their personal environments and make their own discoveries.

### The rainbow, the spectrum and the colour circle

“All the colours of the rainbow” is a common expression for a large number of colours. Rainbow colours, as a spectrum, can be seen more clearly with the aid of a prism as shown in figure 1A.

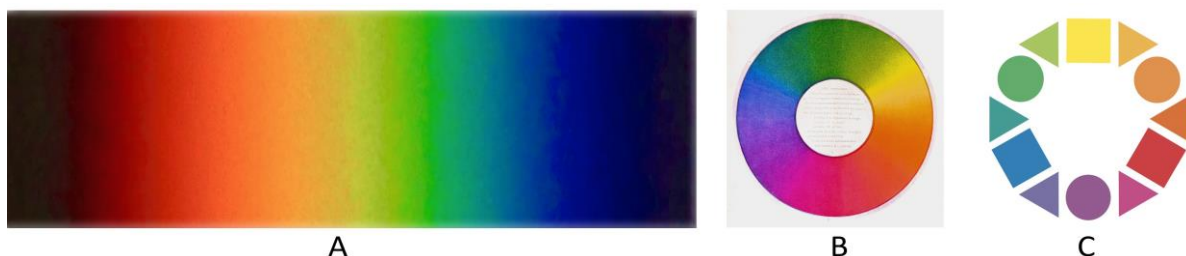

Figure 1: A: Light from a projector refracted by a prism to form a spectrum. B: Circular diagram produced by M.E. Chevreul with spectral colours, augmented by purple, in a blended sequence (Schindler 2009: 67). C: Colour circle constructed from yellow, red and blue ‘primaries’ (squares). ‘Secondaries’ are circles and ‘intermediary’ colours are triangles.

Children are often taught in science that there are seven colours in the spectrum and they learn to name them in order: Red, Orange, Yellow, Green, Blue, Indigo and Violet (ROYGBIV). But if you look at a spectrum you can see that there are no hard borders separating the colours. Red does not change abruptly to orange; the spectrum is a continuum. You can see orange between red and yellow, but can also see lime between yellow and green and turquoise between green and blue. (Violet was faint but



Beyond the rainbow: a new sorting set for teaching colour visible on the screen; it has not registered in the photograph). There are more than seven colours in the spectrum, but there are still many colours that are missing. There are no purples, browns, or pinks.

Purples can be added to the spectral sequence and the colours can be arranged in a circle as shown in figure 1B. M.E. Chevreul, who produced this circle, produced another circle divided into 72 separate colours (Schindler 2009: 66-69). Newton divided the spectrum into just seven colours. Many children become familiar with a colour circle that has 12 colours with yellow, red and blue as ‘primaries’, as shown in figure 1C. There is a place for purple in this colour circle, but still no places for brown or pink.

In both the spectrum and the colour circle the emphasis is on vivid colours, yet in the world around us there are many more colours that are not vivid, colours that are light, pale, deep, dark, soft or muted. To find these colours, which include the browns and pinks, we can turn to a paint fan deck or a colour atlas which often has more than 1,000 colours. But these tools are beyond the reach of most children. More useful would be something in between – a basic sorting set for learning about colour that has room for colours that are not vivid as well as those that are.

### A NEW SORTING SET OF COLOURS

Existing sorting sets are generally too expensive for everyday use in primary schools, with the notable exception of that produced in Germany by Andreas Schwarz (2014). The Schwarz set comes with printed sheets from which a simple three-dimensional model can be built to show how colours can be related. Our objective was similar: an inexpensive, generic set with colours that can be carried easily in memory and which can be organised in a three-dimensional framework.

In a previous study of the legibility of shapes and colours it was found that there are four factors that contribute to quick and easy recognition in a given context: simplicity, familiarity, contrast and nameability (Green-Armytage 2010: 21-22). So our colours are organised in a simple three-dimensional framework, they are familiar, clearly differentiated, and easy to name. These considerations put a limit on the number of colours to be included, but at the same time the set of colours must be able to represent a broad range of the different colours that we can see. We looked for a middle ground between too many colours and too few.

In our basic set of 45 tiles the colours are not specified precisely but are defined within a narrow range as shown in figure 2. Also listed are reasonably close matches to the vivid colours from the set of 24 *Crayola* crayons used in many primary school classrooms in the US and around the world.

Grey Scale	Character				Hue Family	NCS Range	Munsell Range	Crayola Name
	Muted	Dark	Light	Vivid				
					Yellow	G90Y - Y	5Y - 7.5Y	Yellow
					Orange	Y40R - Y50R	2.5YR - 5YR	Orange
					Red	Y90R - R10B	2.5R - 7.5R	Red
					Magenta	R30B - R40B	1.25RP - 3.75RP	Red Violet
					Violet	R60B - R65B	10PB - 2.5P	Blue Violet
					Blue	R85B - R95B	10B - 3.75PB	Blue
					Turquoise	B30G - B40G	7.5BG - 10BG	Blue Green
					Green	G - G10Y	2.5G - 5G	Green
					Lime	G40Y - G50Y	5GY - 7.5GY	Yellow Green

Figure 2: The 45 colours of the basic set with the hue ranges in the Natural Colour System (NCS) and Munsell system. Also listed are reasonably close matches to the vivid colours from the set of 24 *Crayola* crayons.

This set of colours is to be thought of as just that – a set of colours. It is not to be regarded as a guide to mixing or harmony. At this first stage, no colours should be identified as ‘primary’ and no

Beyond the rainbow: a new sorting set for teaching colour colour pairs should be identified as ‘complementary’. These are matters that can be dealt with when children reach higher grades. To make the system accessible to all from an early age we decided that descriptions of the colours should be in terms of everyday language.

### Choice of terms for describing the different colours

The term we have adopted for introducing the concept of ‘hue’ is ‘family’ and we refer to ‘hue families’. The term we adopted for the variety of colours within a hue family is ‘character’. Character and hue family words can be combined in a simple system for naming individual colours: ‘vivid red’, ‘light blue’ etc. We can also use a shorthand system: vR for vivid red, lB for light blue.

We have chosen to include nine hue families. We started with Hering’s Yellow, Red, Blue, and Green, his ‘urfarben’, that are recognised as the unique hues (Hering1964/1920). We then added the in-between colours Orange, Purple, Turquoise and Lime. With the four unique hues and four in-between colours we have a hue sequence of eight. However, it was clear that the visual steps from Red to Purple to Blue were much greater than those from Blue to Turquoise to Green. We decided to replace the single Purple with two colours: Magenta as a reddish purple and Violet as a bluish purple.

The next step was to decide how many colour variations (characters) to include for each hue. We referenced the colour triangle by Faber Birren (1969: 47). This shows just 4 variations: pure colours, tints, shades and tones which are shown in relation to white, black and grey on the left in figure 3.



Birren’s Triangle Yellows in the Environment Yellow Hue Family Yellow Hue Plane

Figure 3: Faber Birren’s colour triangle and three representations of the yellow hue family.

We replaced Birren’s terms with more familiar terms: ‘vivid colours’, ‘light colours’, ‘dark colours’ and ‘muted colours’. Birren’s triangle has a single grey between white and black. We included seven greys for a nine-step grey scale with white and black at the ends. To the right of the Birren triangle in figure 3 are three representations of the yellow hue family, first in images from photographs, then as a diagram of a hue family and, on the right, the four colour characters arranged as a ‘hue plane’.

### Additional colour names

The common vocabulary of colour names in English is very small: the eleven so-called ‘basic colour terms’ White, Black, Red, Green, Yellow, Blue, Brown, Purple, Pink, Orange and Grey. For the *World Color Survey* (Kay and Cook 2015: 3), basic colour terms were defined as “the smallest set of simple words with which the speaker can name any color.” These 11 colour names are almost always the only names featured in the many books that are produced to teach children how to name colours.

Words can help us to see. As Ammon Shea (2008: 208) points out, “if I know there is a word for something ... I will stop and pay more attention to it.” But words can also control and limit what we see. So if we have the one word ‘green’ for all the variety of greens that can be seen then that variety can be lost to us. Instead of noticing the differences between light greens, dark greens, vivid greens, muted greens, bluish greens and yellowish greens we stop looking and simply register ‘green’.

Before learning the meaning of the word ‘green’, young children will have had the experience of seeing a wide variety of greens – in the park, on their dinner plates, and in the shops. Part of our purpose is to restore that variety and help children to see and appreciate the richness of colours in the world around them. When the basic colour terms for English were mapped on an array of colours from the Munsell colour order system in the study by Brent Berlin and Paul Kay (1991: 119) it was evident that there are many more colours identified as ‘green’ and ‘blue’ than as ‘yellow’, ‘orange’ or ‘red’. We believe that by simply introducing additional colour names like ‘lime’, ‘magenta’ and ‘turquoise’ children will have words that will help them to ‘stop and pay more attention’.

### **Arranging colours ‘in order’ and sorting colours into families and by character**

The colour tiles are used for sorting tasks and for playing games that introduce the concept of colour relationships. The first sorting exercise is to arrange the colours ‘in order’. With no other guidelines it is up to the children to decide on the basis for ordering and we have found that most children soon discover ways in which colours are related. They learn to see for themselves. When all the tiles have been sorted, and arranged in the order determined by the children, the relationships are pointed out. An example of this kind of free sorting is shown in figure 4A.

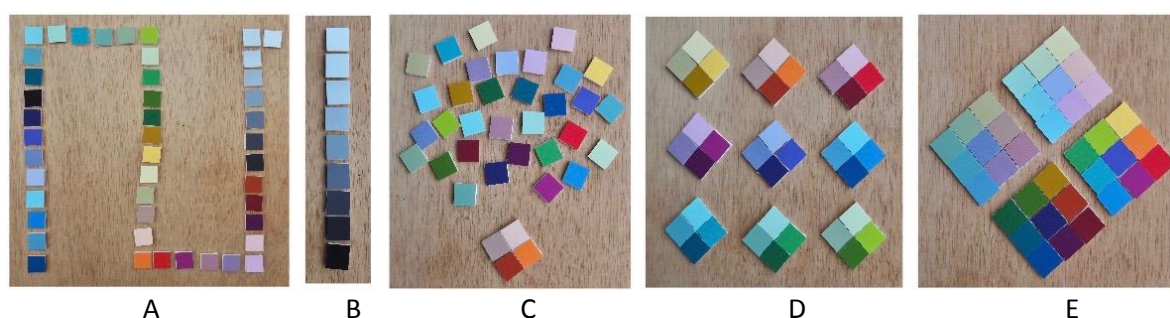

Figure 4: A: Arranging colours ‘in order’. B: Arranging the grey scale colours in order. C and D: Sorting the other colours into hue families. E: Sorting by character.

After identifying the colours of the grey scale, and introducing the concepts of ‘family’ and ‘character’, the next tasks reinforce the concepts. The colour sequence is broken up and the grey scale colours put to one side where they are arranged in order as shown in figure 4B. The remaining tiles are spread out in random order. Four tiles from the same hue family are taken and grouped together as shown at the bottom of figure 4C. Children are told ‘This is a family. Now arrange the remaining tiles in their family groups.’ This task has been tested with young children and they could see the family resemblance between the colours and could sort the remaining colours accordingly. Colours grouped in hue families are shown in figure 4D. It is then easy to single out the light, muted, vivid and dark colours from each family and rearrange them in groups of the same character as shown in figure 4E.

### **THE SORTING SET AS AN INTRODUCTION TO THREE-DIMENSIONAL COLOUR**

The next step is to show how the colours in the set are related in three dimensions. Colour order systems are three-dimensional models and typically have more than 1,000 colours with very many hue planes and as many as 40 colours in a hue plane. Our set of colours constitutes a very basic colour order system with a limited but representative set of colours.

At the Forsius Symposium on Colour Order Systems W.D. Wright (1984: 229-233) identified two broad groups of systems that are structured with different variables. An example of one group is the Natural Colour System (NCS) with its scales of hue, whiteness, blackness and chromaticness (vividness). Figure 5 shows how the colours of our basic set relate to a colour order system like the NCS. The

Beyond the rainbow: a new sorting set for teaching colour variables of whiteness and blackness are indicated in 5A. Chromaticness is zero at the grey scale and increases towards the right of the triangle. The arrangement can be seen in 5B which shows a page from the NCS atlas with the four tiles representing four characters from the yellow hue family laid on top. For our three-dimensional model the four colours of each hue family are arranged as shown in 5C and printed on card. They are connected to slots in circular discs. There are several discs with different numbers of slots for connecting different numbers of hue families. The model shown in 5D has hue planes for the four unique hues. All nine hue planes are connected in the model shown in 5E.

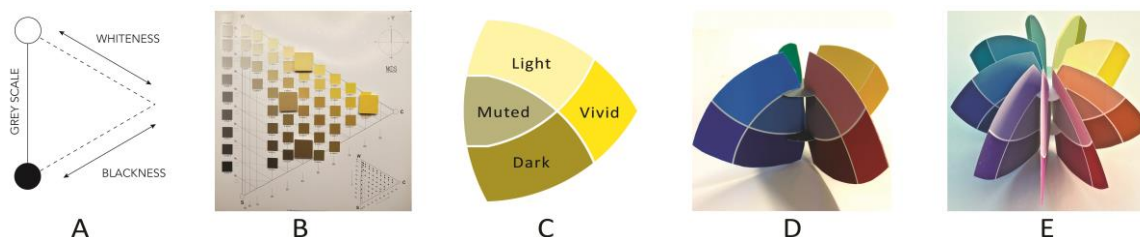

Figure 5: Colour relationships in a three-dimensional model. A: Diagram indicating how the variables of whiteness and blackness relate to the grey scale. B: Page from the NCS atlas with tiles from the yellow hue family laid on top. C: The four characters from the yellow hue family arranged as a hue plane for the model. D: Hue planes for the four unique hues connected in a model. E: Hue planes for all nine hue families connected in a model.

An example of the second group of colour order systems identified by Wright is the Munsell system with its variables of hue, value and chroma. The variables of value (lightness level – described below) and chroma (vividness) are indicated in figure 6A. A page from the Munsell student atlas is shown in figure 6B with the tiles from the yellow hue family laid on top. Munsell ‘chroma’ is broadly similar to NCS chromaticness. Where the NCS has all the most vivid colours arranged at the same level as mid grey, in the Munsell system the colours are placed at their own lightness levels.

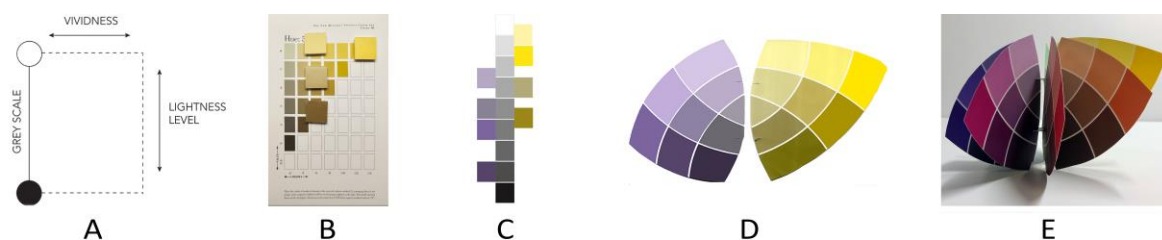

Figure 6. A: Diagram indicating how the variables of lightness level (value) and vividness (chroma) relate to the grey scale. B: Page from the Munsell student atlas with tiles from the yellow hue family laid on top. C: Colours from the violet and yellow hue families related to the grey scale. D: Violet and yellow hue planes, with additional colour characters, showing how the hue planes can be stretched in relationship to lightness level and vividness. E. Model constructed with hue planes adjusted according to lightness levels and degrees of vividness.

### ‘Light colours’ and ‘lightness levels’

‘Light colours’ are colours that are perceived to be between a vivid colour and white. A colour’s ‘lightness level’ can be established by comparing the colour with the grey scale and finding the grey where the border between the colour and the grey is least distinct. Colours of the same character from different hue families will not necessarily be at the same lightness level. This is shown in figure 6C where colours from the violet and yellow hue families are placed next to steps on the grey scale. The lightness level of light violet is at a much lower lightness level than light yellow. In some hue families the most vivid colour appears more vivid than the most vivid colour from another hue family. This is the case with the violet and yellow of this set where the vivid yellow is more vivid than the vivid violet.



This is shown in figure 6D where vivid yellow is placed farther from the grey scale than vivid violet. The model in figure 6E has hue planes adjusted to bring the colours close to the positions that indicate their lightness levels and vividness. This model has additional characters in the hue families.

Each of the two structures identified by Wright has its advantages. Designers, especially, benefit from being familiar with both.

### **Additional hue families and colour characters in an elastic colour system**

The basic set of colours can be a starting point for expansion or contraction. Teachers can choose to reduce the number of colours they use for activities with very young children. The range can also be extended beyond the present nine hue families. To accommodate extra hue families the colour circle is 'elastic'. Intervals between colours can be stretched or compressed. The advantages of an elastic colour solid have been described by Paul Green-Armytage (2018). Additional colour characters, such as 'very light' and 'very dark', can also be introduced in the third dimension. This will add colours that are more muted and closer to grey as shown in figures 6D and 6E. Maggie Maggio has used this elastic principle to design the models with differently organised hue planes such as those shown in figures 5 and 6. This elastic principle means that one type of model can morph into another.

### **CONCLUSION**

The aim of this expanded sorting set is to give children more confidence with colour by helping them to see the many variations of the colours around them, to open their eyes to the wider range of colours beyond the rainbow and colour circle, and to introduce ways in which colours are related in three dimensions. This set of colours, on tiles and cards, has been used successfully with small groups of young children, but it is a work in progress. We need many more trials with many more students. As we continue to refine the set we welcome comments and suggestions.

### **REFERENCES**

- Birren, F. 1969. *Principles of Color*. New York: Van Nostrand Reinhold Company.
- Berlin, B., and P. Kay. 1991. *Basic Color Terms*. Berkeley and Los Angeles: University of California Press.
- Green-Armytage, P. 2010. A Colour Alphabet and the Limits of Colour Coding. *Colour: Design & Creativity* (5) (2010): 10, 1-23. <http://www.colour-journal.org/2010/5/10/>
- Green-Armytage, P. 2018. Relating Munsell to Other Systems in an Elastic Colour Solid. *Color Res Appl.* 43: 815-826.
- Hering, E. 1964/1920. *Outlines of a Theory of the Light Sense*, Cambridge, Massachusetts: Harvard University Press.
- Kay, P., and R. S. Cook. 2015. World Color Survey, *Encyclopedia of Color Science and Technology*, accessed July 11, 2021. [http://imbs.uci.edu/~kjameson/ECST/Kay\\_Cook\\_WorldColorSurvey.pdf](http://imbs.uci.edu/~kjameson/ECST/Kay_Cook_WorldColorSurvey.pdf)
- Schindler, V. M. 2009. Michel Eugène Chevreul. In: Spillmann, W. (ed) *Farb-Systeme 1611-2007: Farb-Dokumente in der Sammlung Werner Spillmann*. Basel: Schwabe Verlag. Illustration of Chevreul's colour circle reproduced with permission.
- Schwarz, A. 2014. Kleines Farbenpraktikum. Available with *Wege zur Kunst – Begriffe und Methoden für den Umgang mit Farbe*. Braunschweig: Schroedel.
- Shea, A. 2008. *Reading the OED*. New York: Perigree.
- Wright, W. D. 1984. The Basic Concepts and Attributes of Colour Order Systems. *Color Res Appl.* 9: 229-233.

# Color Names Education Effect on the Color Range Recognition

Lea Jeong<sup>1</sup> and YungKyung Park<sup>1,\*</sup>

<sup>1</sup> Ewha Womans University; lea@ewhain.net, yungkyung.park@ewha.ac.kr

\* Corresponding author: yungkyung.park@ewha.ac.kr

## Abstract

The use of incorrect color names in educational fields where accurate color information is required can lead to the incorrect recognition of colors. This study examines the changes in recognition of color range after color name education to identify the effects of the education on understanding color. First, systematic color names and require specialized knowledge were selected, and color samples of the range corresponding to the color names were presented. Then, the pre-and post-color name education results were analyzed after the color name selection was made for the color sample. It was revealed that yellowish-red was distributed a little more widely in the Y direction, and reddish-yellow was distributed a little more widely in the R direction. These results indicate that the recognition of color range has changed in a way that conforms to the contents of color name education. Therefore, it was confirmed that color name education serves as the basis of color information.

**Keywords:** *color name education, color range, color recognition*

## INTRODUCTION

Color names play a key role of language communication that accurately conveys color information. Color names deliver the objective meaning to others by precisely expressing the emotions and information that people perceive about colors. In the spring of 2021, Apple released the iPhone 12 Purple. iPhone Purple added bright vibes and fun options to the previous model. Consumers showed great interest in the color name 'Purple'. If Apple had announced the release of 'R234 G345 B456' iPhone, it would not have been able to deliver their intended vibes and images to consumers. As such, color names are used as an important means of communication with their excellent strengths of conveying images about colors. Around the same time as the release of the iPhone Purple, Samsung also released the Galaxy S21 Violet. The dictionary meaning of purple is an intermediate color between red and blue or reddish-blue. The dictionary meaning of violet is bluish-purple. Violet has stronger blue color than purple. Although the iPhone and Galaxy both correspond to violet with strong blueness, they were given different color names, 'purple' and 'violet', respectively. This is an example of inaccurate color information being delivered to consumers who may not clearly recognize the distinction between 'purple' and 'violet'.

In a modern society where, rich visual information is rapidly expanding, individuals' recognition of color names may differ by trends and various experiences. Although the use of inaccurate color names does not significantly hinder communication in daily life, it can cause confusion in many industrial sites and educational fields that require accurate color information communication. A study by Lee and Shin (2012) showed that the color information conveyed by color names and the colors that people generally perceive through color names are different. The Korean Agency for Technology and Standards revised the color names frequently used in daily life into the Korean standard color names. Color names that were different from actual colors and that could cause confusion in everyday life were changed to match the actual colors. For example, color names that were difficult to infer intuitively, such as chrome yellow color and canary color, became easy names such as banana color and lemon color. These changes were to encourage people to grasp color information, facilitate smooth color name communication, and use correct color names more easily and accurately. Lee (2011) stated that any substantial gap between people's recognition of color and the color information

conveyed by color names requires correction. Education on color names can be an objective basis for individual subjectivity and experiences and can form a clear recognition of color. If color names have already been institutionally established so that revision needs a lot of research, time, and budget, education on color names can help reduce confusion between color names and color recognition. Yang (2005) emphasized the importance of color planning using color names and learning that presupposes a correct understanding of color names. Hong and Park (2016) revealed that in terms of the basic colors, the younger generation in their 10s who were educated with the name 'green (chorok)' and the older generation in their 20s and 40s who were educated with the name 'green (noksek)' had different use of color names and color recognition. Therefore, it is expected that the recognition range of the color are different when teaching color names whose color recognition is not clear. The current study selected color names in a range where color recognition is not clear and examined differences in perception according to color name education. Also, the study identified the effects of education on the general recognition of color names and the reduction of color information confusion by color names. The purpose of this study was to reaffirm the importance of color name education.

## **EXPERIMENT**

This experiment was designed to investigate how the color range of yellowish-red and reddish-yellow is recognized. The information delivery of these two colors is difficult because of the unclear color boundary, although the names are specified in the Korean Language Dictionary.

The first experiment was organized to investigate the recognition range according to color understanding in the absence of education on color name concept. The Experiment was limited to R, YR, and Y series colors based on KS Korean standard colors. Participants looked at color samples without education on the concepts of yellowish-red and reddish-yellow and chose yellowish-red and reddish-yellow, or 'none of above'.

The second experiment was organized to investigate the range of color recognition according to color understanding after education on the color name concept. After the first experiment, the same participants completed education on color name concepts and then participated in the second experiment. In the color name education, the participants read and understood the definitions of color names written at the top of the answer sheet. The definitions of color names followed the Korean Language Dictionary. The post-education experiment had the same procedures as the first experiment.

In order to minimize the error range of the color sample output by the print setting for an in-person experiment, the Google online experiment format was used, using LG Gram 15ZD980-GX30K 15-inch screen, monitor brightness 100%, and sRGB mode.

## **ANALYSIS AND RESULTS**

**Analysis:** in order to examine the difference in the recognition of color range for color samples in the first and second experiments, the characteristics in the color space represented by the  $a^*b^*$  graph and the  $C^*L^*$  graph were compared. Answer sheets with at least 33.3% of response completeness were used for comparison. This criteria of 33.3% indicated that the participants responded to at least one of the three items in the color name selection experiment, which served as the minimum standard that allowed inferring the recognition of color samples.

This 33.3% criteria for examining the change in recognition before and after color name education might have low reliability to be applied to color categorization for color names. Therefore, for the results of the second experiment with a high degree of understanding of color names, color samples with 50% of response completeness or more were determined to be reliable color range recognition.

**Results 1:** In the first experiment, 10 out of 122 samples (8.19%) were answered yellowish-red more than 33.3%, and 11 out of 122 samples (9.01%) answered reddish-yellow more than 33.3%.

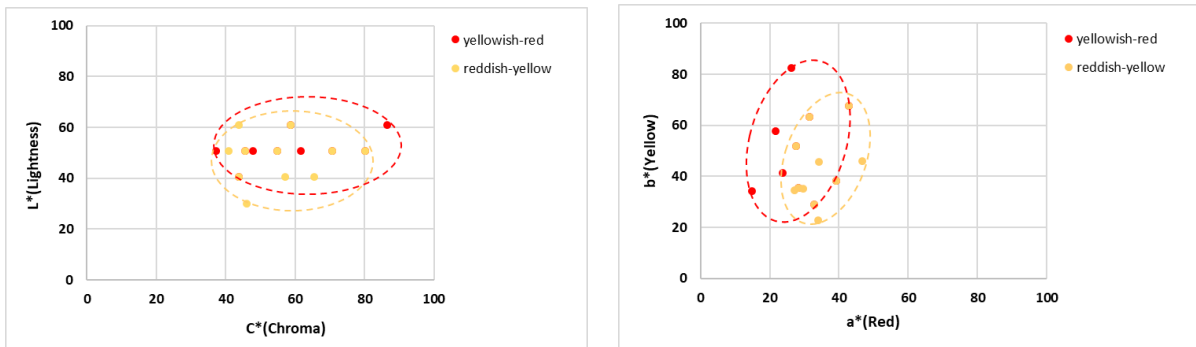

Figure 1: 1st experiment results showed that the C\*L\* and a\*b\* graph answered more than 33.3%.

Through C\*L\* graph, yellowish-red and reddish-yellow colors were not clearly distinguished due to mixed recognition in chroma c or brightness. The value of the yellowish-red L\* axis was 40-61, and its value of the C\* axis was 37-80. The value of the reddish-yellow L\* axis was 30-60, and its value of the C\* axis was 40-80, which was concentrated and distributed in the range of low-mid brightness and medium-high chroma.

Through a\*b\* graph, the color distribution of yellowish-red and reddish-yellow is as follows. The value of the a\* axis of yellowish-red was 14-42, and its value of the b\* axis was 28-82. The color range was distributed from 10R07.5YR. The value of the a\* axis of reddish-yellow was 27-47, and its value of the b\* axis was 22-67. The color range was distributed from 7.5R-5YR.

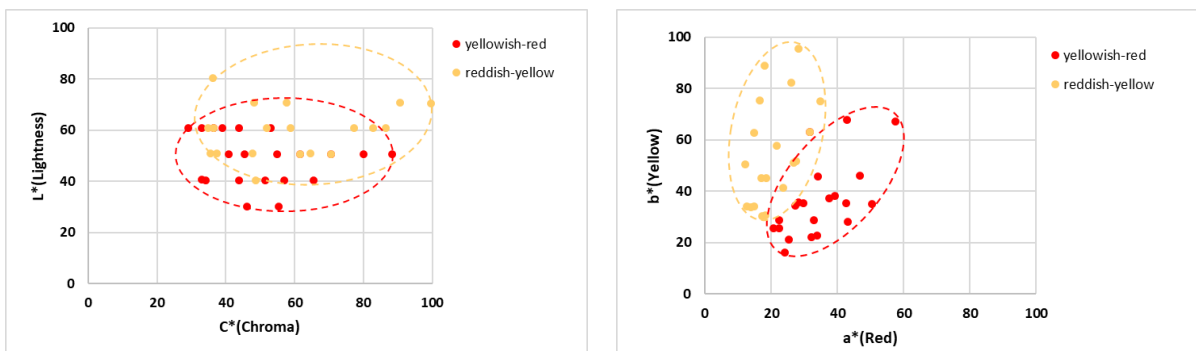

Figure 2: 2nd experiment results showed that the C\*L\* and a\*b\* graph answered more than 33.3%.

**Results 2:** In the second experiment, 21 out of 122 samples (17.21%) were answered yellowish-red more than 33.3%, and 19 out of 122 samples (15.57%) were answered reddish-yellow more than 33.3%.

Through C\*L\* graph, the value of the L\* axis of yellowish-red was 30-60, and its value of the C\* axis was 29-80. The value of the L\* axis of red and yellow was 40-80, and the value of its C\* axis was 35-99. In the second experiment, reddish-yellow had a slightly higher L\*-axis value than yellowish-red, and its value of the C\*-axis also had a slightly higher range.

Through a\*b\* graph, the value of the a\* axis of yellowish-red was 22-57, and its value of the b\* axis was 16-67. The color range was 7.5R-5YR. The value of the a\* axis of reddish-yellow was 12-35, and its value of the b\* axis was 30-90. The color range was 5YR-10YR. As a result of the second experiment,

the values of the  $a^*$ -axis and the  $b^*$ -axis were clearly distributed in yellowish-red compared to reddish-yellow. Considering the mixture of yellowish-red and reddish-yellow color ranges in the first experiment, this was different from the characteristic that yellowish-red had a lower  $a^*$ -axis value and a higher  $b^*$ -axis value than reddish-yellow.

**Results 3:** The color range of yellowish-red and reddish-yellow examined above showed changes in recognition before and after color name education based on 33.3% of the minimum recognition criteria. Since the minimum recognition criteria of 33.3% included the confusion range of color samples recognized by the participants, it was determined that it was necessary to reset the criteria of color categorization recognized by the participants as yellowish-red and reddish-yellow. Therefore, the color sample data, which secured the reliability of the participants' response completeness of 50% or more, became the basis for color recognition for the corresponding color name.

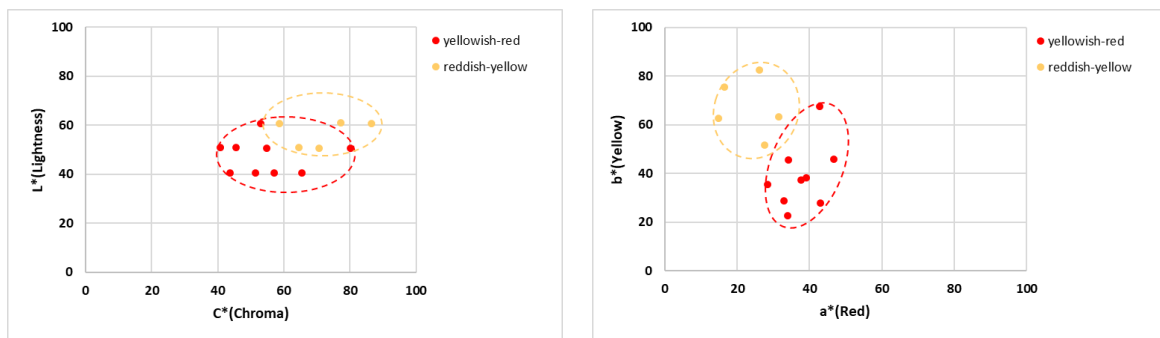

Figure 3: 2nd experiment results showed that the  $C^*L^*$  and  $a^*b^*$  graph answered more than 50%.

Through  $C^*L^*$  graph of data that had more than 50% of response completeness in the second experiment, the value of the  $L^*$  axis of yellowish-red in the  $C^*L^*$  graph was 40-60, and its value of the  $C^*$  axis was 40-65. The value of the  $L^*$  axis of reddish-yellow was 50-60, and its value of the  $C^*$  axis was 58-86. The  $L^*$  and  $C^*$  axis values of reddish-yellow were distributed in a higher range than that of yellowish-red.

Through  $a^*b^*$  graph, the value of the  $a^*$ -axis of yellowish-red was 28-46, and its value of the  $b^*$ -axis was 22-46. The color range was 7.5R-2.5YR. The values of the  $a^*$  axis of reddish-yellow was 14-31, and its value of the  $b^*$  axis was 51-82. The color range was 5YR-10YR.

Through color space of the  $a^*b^*$  graph, it was confirmed that yellowish-red had a higher  $a^*$ -axis value and a lower  $b^*$ -axis value than reddish-yellow. Therefore, yellowish-red had lower brightness and chroma than reddish-yellow and was recognized as a color close to the R series.

## DISCUSSION

This study examined whether education about yellowish-red and reddish-yellow, which had difficulty in conveying information because of their unclear color boundary, led to differences in color range recognition, and to identify the effects and importance of color name concept education. Comparing the results of the first experiment when the participants had a low understanding of colors and the second experiment after color name education, the distribution of yellowish-red and reddish-yellow showed a significant difference. In the first experiment, the color range of yellowish-red was 10R- 7.5YR and that of reddish-yellow was 7.5R-5YR. Their boundary was ambiguous, and reddish-yellow was recognized a little closer to the R series than yellowish-red. According to the results of the second

experiment, yellowish-red had a higher  $a^*$ -axis value and lower  $b^*$ -axis value than reddish-yellow, and the color range was relatively distinctive, with yellowish-red 7.5R-5YR and reddish-yellow 5YR-10YR. In other words, the range of recognition shifted toward yellowish-red close to the R series, and reddish-yellow color intermediate between the R series and Y series. After color name education, yellowish-red and reddish-yellow chroma were also distinguished; The  $C^*$  value of reddish-yellow representing chroma increased, and thus it was recognized as a more vivid color.

In the second experiment, the range of color recognition for each color name was clearly distinguished, and the results aligned with the concept of color name compared to the first experiment. This supported Choi (2014)'s study that the categorical perceptual characteristics of colors are closely related to color names. Lee (2014) stated that a concept is a basic element that forms thoughts about an object or thing, and An (2016) stated that vocabulary learning helps to structure and expand the concept and use it efficiently. The current study revealed that education contributed to the participants forming the concept of color and systematizing the recognition of color range. This was in line with the role of conceptualization and the function of education as described by Lee (2014) and An (2016). This study confirmed the effects of color name education and suggested a way to narrow the gap between the colors that people generally recognize through color names and the color information conveyed by color names.

## **CONCLUSION**

In the case of yellowish-red and reddish-yellow in the middle region between red and yellow, there was a difference in color recognition according to color characteristics and chroma characteristics after color name education. That is, color name education impacted color perception according to the concept of color names. In particular, the color range corresponding to the color name concept became clear and the mixed color range decreased after the color name education. This showed that color name education made it possible to clearly distinguish colors. This study emphasizes the need for color name education to accurately use color names and convey color information.

## **REFERENCES**

- An, C. W. 2016. A Study on Vocabulary Education based on Conceptual System. The Department of Korean Language Education, Korea University.
- Choi, W. J. 2014. A Study on Focal Colors and Color Names as a Factor Forming Memory Colors. Unpublished Doctoral Dissertation. Ewha Womans University, Seoul.
- Hong, H. R. and Y. K. Park. 2016. Color Distribution Studies over the age of 'Chorock' and 'Nockescek' color names. In: *Proceedings of the 2016 KSCS Fall Conference*, 41-44.
- Lee, H. H. 2011. The Aspects of Korean Color Expressions and Their Classifications. *The Korean Language Society*, Vol. 291, 193-228.
- Lee, H. H., and H. C. Shin. 2012. The Color Recognition and Color Expression of Co-relationship (2) – A Critical Viewpoint of the National Standard Color Name 'KS A 0011'. *The Sociolinguistic Journal of Korea* 20(1): 235-265.
- Lee, K. M. 2014. The Effect of Grandparent's Traditional Storytelling Program based on Concept Learning Situation Model on Children's Prosocial Behaviors. Department of Early Childhood Education Graduate School of Gangneung-Wonju National University.
- Yang, J. H. 2005. A Study on the Color-Name Teaching Method for the Emotional Language of Color Expression and Communication – Focusing on the Synesthesia of Color Image Expression. Concepts in Craft design of Education. Graduate School of Education. Kookmin University.



# Colorful safety guide

Jihye Choi <sup>1,\*</sup> and Paolo Calafiore <sup>2</sup>

<sup>1</sup> NOROO MILAN DESIGN STUDIO; jihye@noroomilan.com, paolo@noroomilan.com

\* Corresponding author: jihye@noroomilan.com

## Abstract

NOROO Milan Design Studio wants to focus attention on how color can be an efficient tool for childhood assuming different levels and scales of intervention. NMDS has created four color projects to reorganize the flows and guide the entrance spaces of the institutes in Milan, to ensure the safety of children, families, and all users. The approach of NMDS projects is concentrated on finding a key element in each place of intervention and imagining the application of color through forms that determine an effective visual impact to satisfy needs, such as in this case of interpersonal distancing for the problem caused by the covid-19 pandemic. Site specific Color Design that takes on the role of safety guide contribute to by carrying out an educational game.

**Keywords:** *Color Design Against Covid, Color design for School, Sicurezza Colorata, Color Design*

## INTRODUCTION: COLORFUL SAFETY GUIDE PROJECTS

NMDS has created four color projects started from September 2020 to today and fifth is upcoming. Colorful Safety guide was an idea birth during first Lock-down period, and it is the result of our efforts to overcome the covid-19 epidemic through color and design.

### Four Color projects

Colors are fundamental elements for our visual perception and environmental experience. They communicate symbolic messages, Signal, Camouflage and deter, provide help with orientation (Meerwein et al. 2007: 16-17). Color conveys messages and is an important element in safety signs, as it provides extra information to users (Siu et al. 2017: 56). We designed safety guide for each institution to take advantage of those fundamental aspects of color.

#### *The first project is for Guerzoni, Milan*

Guerzoni is a nursery school attended by children between 6 months and 3 years old, an age in which the perception of color is still mainly centered on primary care. Red, Blue, Yellow work as an ideal traffic light by creating rest areas and advancement of the waiting line. Red, Blu and Yellow applied for major visibility on cream white color background pavement of raw concrete material. Red color used for warning stop are with empty circle shape invite them to stay within. Blu and yellow work as guidelines reminding traffic light color.

The ramp leading to parents and children at the entrance is 165 cm wide, to create the safety distance we have designed an oblique line system that creates a zigzag path by alternating and spacing the red triangles to position itself in a row and stop safely.

#### *The second project is for Villani, Milan*

Villani is The Kindergarten that attended by children from 3 to 6 years old, an age at which they can hardly learn each nuance and associate it with a specific name of the color. The choice of white, yellow, blue, lively orange (the level of visibility Yellow (stop area)> White (stop area)> Orange(Boundary) >Blu(pathway guide)) was dictated by the immediacy with which children recognize these colors and visibility with grained dark grey color pavement, while the geometric shapes recall the hexagonal



polygons that distinguish the structure of the school. The directions of entry and exit are distinguished by colors and shapes. At the entrance, the wait is marked by two interpenetrating hexagons, white is intended for an adult and yellow (for a smaller size) for a child, a further orange hexagonal trace around the white and yellow core defines and guarantees the safety area. The exit is marked by a blue line with some yellow exogen distinguished from entrance area both the color and shape, that allows users to stay in safe distance to exchange greetings.



Figure 1: Above Left is the first project Guerzoni, Nursery School.

Figure 2: Above Right is the second project Villani, Kindergarten.

*The third project is for Marie Curie School, Milan*

We designed sign graphic with 3 primary colors and white to make main entrance path following required distance for emergency. Yellow > Orange > White (small size) > Light Blu, Background: grey color asphalts . The main concept of the project for Elementary school of Marie Curie comes from Marie Curie, her valuable scientific research work, and her passion for science. The project aims to remember and dedicate to Marie Curie's teaching, inspired by the shape of the molecular 'connection' between various chemical elements, the intersection of meeting points of a network determines an adequate distance where we can stop safely. We want to communicate and give this sign to all users of the M. Curie school: science is a natural system strictly regulated by respect for all the elements, and we can feel good and exist in harmony while respecting the rules of nature.





Figure 3: Above Left is the third project Elementary school Marie Curie, view from main entrance to door to school.

Figure 4: Above Right is the third project Elementary school Marie Curie, after school when the lesson is finished.

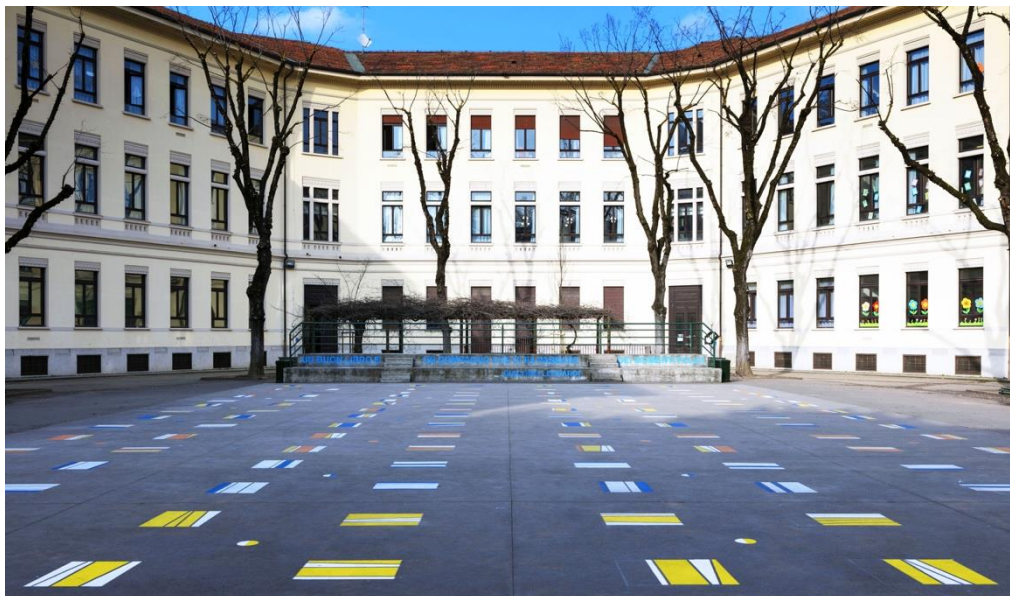

Figure 5: Above Left is the third project Elementary school Marie Curie, view from main entrance to door to school.

*The concept of the fourth project for the Giacomo Leopardi School is the FLAG*

We designed waiting area in safe taking advantage of huge square located in the middle of courtyard in School. Our goal was to define of area to prevent gatherings on and off the school, which the users can be stay within in safe. The FLAG, an iconic element with its highly symbolic personality obtained

through the composition of the colors, immediately identifies its presence. 116 FLAGS of Color and different geometric compositions drawn only with 4 colors. We created 4 groups of each 29 with 4 main colors, composing different form and color to make a division in existing classes. The colored platform can be used while waiting for the exit, indicating the correct positioning to be safe, identified through the composition of 4 color groups. At the same time, it can become an audience where to participate in events indicating the orderly and safe positioning (even after the pandemic). With the Colored Safety project, the entire perception of the courtyard becomes more bright compare with monotone grey, giving the entire school context a new image.

Following Heinrich Frieling, 5-8 age children refuse Black, White and Dark brown color and in general monotone (Mahnke and Giacone 1998: 182).



Figure 6: Above Left is the third project Elementary school Marie Curie, view from main entrance to door to school.

## **CONCLUSION**

The fundamental element to make a success for this kind of color design project it is necessary to consider: first, to analyze materials of background color and condition of area for application. second, to select suitable paint, in this case we collaborated with closely with a paint industry both for technical support and other consideration such as outside temperature to calculate the time for dry. The last, to organize efficiently with institution for the realization.

Colorful safety guide projects aimed to dedicate Color design to overcome emergency especially for children, at the same time to try make it as a play after the situation finished.

## **REFERENCES**

Mahnke, F., and L. Giacone. 1998. *Il colore nella progettazione: l'uso del colore come elemento di benessere nella progettazione dell'ambiente architettonico*. Torino : UTET.

- Meerwein, G., B. Rodeck, and F. H. Mahnke. 2007. *Color-communication in architectural space*. Walter de Gruyter.
- Datta, S. M. *The Impact of Colour*. Curtin University of Technology.
- Kim, S.-H., and Y.-R. Choi. 2015. *A study of safety color & safety sign*. Paper presented at Proceedings of the Korean Society of Disaster Information Conference, .
- Or, C. KL, and A. HS Chan. 2010. *The effects of background color of safety symbols on perception of the symbols*. Paper presented at 3rd International Conference on Applied Human Factors and Ergonomics, AHFE 2010.
- Siu, K. W. M., M. S. Lam, and Y. L. Wong. 2017. Children's choice: Color associations in children's safety sign design. *Applied Ergonomics* 59: 56-64.



# Educational resources based on augmented reality applied to Color Theory contents

Junior Vendrami <sup>1</sup>, Marley de Lira <sup>2</sup> and Berenice Gonçalves <sup>3,\*</sup>

<sup>1</sup> University of Santa Catarina, Brazil 1; jvendrami@me.com

<sup>2</sup> University of Santa Catarina, Brazil 2; marleylir4@gmail.com

<sup>3</sup> University of Santa Catarina, Brazil 3; berenice@cce.ufsc.br

\* Corresponding author: berenice@cce.ufsc.br

## Abstract

This article reports research developed in the Color Theory class, from the Design course at Federal University of Santa Catarina, Brazil. This course used a Virtual Learning Environment for 10 years, but in 2021 sought to expand the interactive and participatory possibilities by creating a resource based on Augmented Reality, for the selection of chromatic scales. This resource, programmed in the class's Instagram profile, was adopted for the systematization of the Chromatic Principles and Harmonies. Design academics were asked to identify and classify design pieces from the resource. The results showed that the “color select” filter was significantly accessed by the group and proved to be useful as a tool to support the identification of chromatic scales in examples from the Design area. The strategy proved to be productive, especially when used in conjunction with teaching activities and processes previously forwarded by the Moodle Virtual Environment.

**Keywords:** *Chromatic Principles, Teaching, Color Theory, Augmented Reality, Instagram.*

## INTRODUCTION

Working with the teaching of color and the parameters linked to its use in the field of design implies a need to reflect on pedagogical practices. Each historical moment, more than technical progress, presents cultural changes.

Historically, chromatic learning has been linked to processes developed in workshops and craft corporations. Studies, based on observation and repetition of principles, and concepts were disseminated by great masters. The different phases, transformations, and the different technical systems used in each period left deep traces in our conceptions and our chromatic usage codes, Gonçalves (2004).

The 20th century brought systematic institutional experiences that radically influenced the study of color in the areas of Design, Architecture, and Art. One of these learning models has its origins in the “Bauhausian” experience. The Bauhaus exerted such influence on the ways of learning color that, even today, vestiges of its theoretical-practical assumptions can be seen in classroom practices Gonçalves (2004).

Smith (2001), was a pioneer in emphasizing that the “studio of color” should mix traditional teaching strategies with new teaching-learning approaches. The author referred to the importance of the correlation between educational goals and technologies. These open up opportunities for different forms of information delivery, exercises, analysis, and reflection.

In recent decades, the use of information and communication technologies (ICT) has been seen all over the world as a support for distance learning or as a support for on-site teaching, adopting a hybrid teaching perspective. ICTs can encourage the contrast of opinions and points of view of different actors involved in the educational process. ICT can motivate interaction, contextualization, and problem-solving among subjects involved in the same process.

Therefore, whether in the form of virtual environments or even through strategies that adopt social media networks, technologies have potentialized changes in the ways of teaching and learning, bringing valuable contributions, especially in the current period of remote learning.

From this context, this article reports research developed in the Color Theory class, from the Design course at Universidade Federal de Santa Catarina, Brasil (Federal University of Santa Catarina (UFSC), Brazil). This class already had support from the Virtual Learning Environment for 10 years, but in 2021 it sought to expand the group's interactive and participatory possibilities by creating an Interface resource based on Augmented Reality, on the Instagram social network, for teaching and systematization of the concepts of Chromatic Principles. Design academics had to identify and classify design pieces from the resource.

### ***COLOR IN DESIGN***

Addressing color in Design is to resume significant heritages regarding the main theoretical and practical use concepts of color. As already mentioned, the 20th century was marked by different teaching-learning approaches to the chromatic aspect, mainly in the artistic sphere, with influences that emerged in the Bauhaus, Barros (2011). These teachings consolidated a theoretical-practical basis that is perpetuated in developments that address research on color in many areas related to information, behavior, and culture.

Within the scope of color application, some compositional relationships originating from practices, written documents, graphics, and pictorial images have been perpetuated. The different coloristic organizations of contrasts and harmonies allow construction and highlighting of spatial relationships, concepts and ideas.

In the field of Graphic Design, chromatic information of a piece can enhance the identification of certain structures and influence human behavior. Therefore, color, in addition to an aesthetic function, can act informatively, functionally, or symbolically based on more or less explicit codes. In this aspect, certain design requirements are assigned to stimulate the subject's interaction with what was idealized, which is directly related to chromatic information.

Csillag (2011) mapped out the main studies on color perception, highlighting the value of chromatic contrasts. These tend to provide the same perceptive effect to human beings with normal vision and are fundamental for areas of knowledge, such as Design, Architecture, Advertising, Art, among others, that study application of color.

Itten (1973) presents studies about main contrasts. The contrast of color itself, such as that in which the adjacent pure hue with black is used, thus producing vibrant hues. In this contrast, the pure hue compared to the white background fades it. According to Itten (1973), the chiaroscuro contrast is important to visualize a spatial effect. The author also described the principle of temperature, in which references to hot and cold colors were found in several other authors as well. Albers (1974) and Itten (1973) deepened the relativity of temperature contrasts, depending on the chromatic adjacency.

The contrast of complements has also been extensively addressed in the color theory literature: Pedrosa (1995), Sausmarez (1974), and Wong (1997). Contrast is widely adopted in visual communication since it provides a "design that captures the eye" Wong (1997:77) due to the maximum appreciation of the vibration of each hue Itten (1973) and "maximum vitality" Sausmarez (1974:93).

### ***AUGMENTED REALITY***

Augmented reality is a form of virtual reality application. Such technologies have become popular as the quality of computer-generated graphics progresses to a point where images generated are often mistaken for the real world, Schmalstieg and Hollerer (2016).

In virtual reality, generated images are separated from the user's world, which does not happen in augmented reality, which places its objects directly in the same space as the user, creating an illusion



that such objects exist in that space at that exact moment, Azuma et al. (2001). With the constant evolution around us of technological objects' computational powers, the graphics projected by augmented reality become less and less distinguishable from the real world. Reaching the point where digital information seems to be part of the real world can be considered the goal of augmented reality, and this goal is achieved through visual coherence between what is being simulated and the real environment, Schmalstieg and Hollerer (2016). Currently, even the tangibility of objects generated by technology - the possibility of interacting with them - is already beginning to be part of some applications.

As for data entry, augmented reality can be classified by the form of tracking, Wang et al. (2016): augmented reality based on vision, when only photographic and cinematographic cameras are used to capture data for simulation; sensor-based augmented reality when non-visual equipment is used to capture data; and, as seen emerging today, mixed augmented reality, which uses image capture and sensor reading, such as an accelerometer and magnetic field reader, for example. The detection of surfaces in the world, through the analysis of unique points present in planes, allows the allocation of virtual objects respecting real-world surfaces, ARKit (2017).

The Instagram social network has enabled the use of filters based on Augmented Reality technology. An important feature is in the Stories area, where users can use filters - resources applied to photographic or audiovisual media that make it possible to change them and create interactions with users who view them. Thus, many filters use augmented reality to generate platform interaction with the videos captured by the application, Schmalstieg and Hollerer (2016).

## **METHODOLOGICAL PROCEDURES**

To forward the research, the following steps were developed:

- Elaboration of the educational resource based on Augmented Reality;
- Application of resources by design academics at UFSC, in color theory class;
- Result analysis and Discussions.

## **RESULTS**

To build the resource, the first step was to look for examples of other Instagram filters that allow the user to interact with features linked to color. In this sense, the filters that stood out were divided into 3 categories: 1. Filters that change the color of the captured scene; 2. Filters that apply virtual elements in color variations that interact with the captured scene; 3. Filters that measure parameters related to the color of the captured scene and demonstrate them to the user.

Resource development took place in the SparkAr Studio app. Inside the application, using the visual object editor to position the elements in the scene and the command editor, which uses JavaScript/TypeScript language, to create the interactions between such elements and the user, it was possible to develop a tool that measures which are the 5 main colors of the captured scene and demonstrates them to the user in colored boxes positioned on the side of the filter.

After development, the application was submitted for approval by the social network through the SparkAr Hub portal, where, in addition to publishing the tools, it is possible to monitor statistics of those already published by the profile, such as the amount of use, screenshots, sharing of publications, among others. Finally, with the platform's approval, the filter became visible and accessible to all Instagram users in the filters tab of the CorUFSC profile or the application's general filter search. To test the filter, some trials were performed:



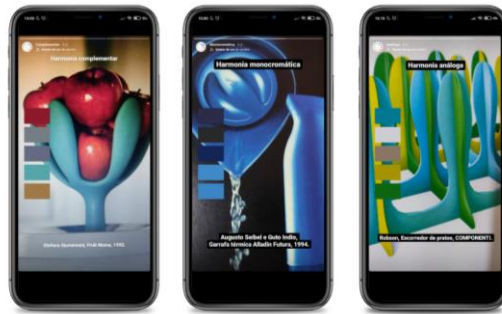

Figure 1: Examples of tests carried out using the color selector filter on images of Design pieces, on the CorUFSC profile on the social network and Instagram app.

### Application of the AR-based resource in the context of the Color Theory class/Design UFSC

The filter was presented and made available on 07/05/2021, in a remote synchronous class taught from the Google Meet platform along with the Moodle platform of the Theory of Color class (Moodle.ufsc.br). In the context of the content module worked in class, namely “Chromatic Principles and Harmonies”, design academics were asked to select examples of Design pieces, use the color selector, and identify the dominant chromatic principles. Later, they should post on Instagram identifying the scale and citing the CORUFSC profile. Regarding the use of the filter, it was possible to observe that within a week there was a good level of engagement. As shown in Figure 3, there were 147 accesses.

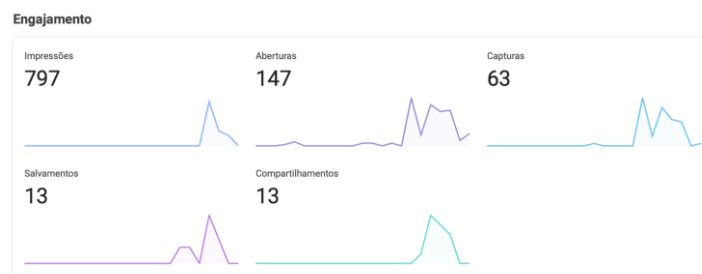

Figure 2: Engagement statistics of the CorUFSC profile on the social network and Instagram app.

As for the images published by academics, it is highlighted that the chromatic principles most frequently identified in the examples of Design Pieces were Achromatic, Triadic, and Complementary, as shown in figure 3 and figure 4. Regarding the choice of Design examples, some students presented recurrent images in the field of visual arts, partially diverting from the activity’s objective.

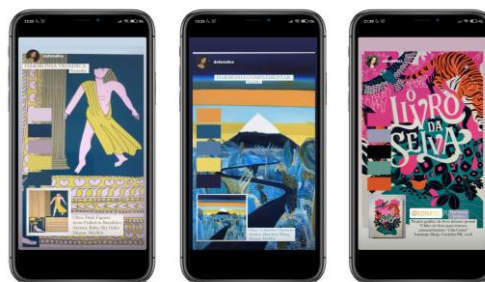

Figure 3: Examples made using the color selector filter corresponding to the triadic and complementary principle.



Figure 4: Examples corresponding to the achromatic and triadic principles.

Regarding the adopted strategy, the proposal to build a collaborative catalog with examples for the creation of a repertoire for the class on chromatic principles was very well-received by the group. However, in a group of 23 students, it was identified that 2 did not use Instagram. Most academics demonstrated the need to confirm the examples to be posted. They preferred to validate their choices with the class monitor or even, from examples already presented in other activities done in the class' Moodle, as shown in the figures below. In this way, a reinforcement and interrelationship between the many actions of the class on different platforms are identified, which favors the systematization and mastery of the contents.



Figura 5: Activity interfaces performed by students in the Moodle virtual environment, used in the Color Theory class.

## CONCLUSIONS

The filter proved to be an efficient tool to support the identification of chromatic principles by the first-year academics of the Design course. The strategy adopted showed greater potential when linked to other activities and platforms used in the class. In this study, there was an evident integration with exercises performed using the Moodle questionnaire tool, in which students were already looking for examples of color in the field of Design. The results corroborate recent studies that highlight the potential of integration of different media to support the teaching process. At this moment of remote learning, the use of the "Color select" filter in the Instagram profile as a tool for viewing examples in the field of design has generated an alternative for the class' dynamization and interaction.

## **ACKNOWLEDGEMENTS**

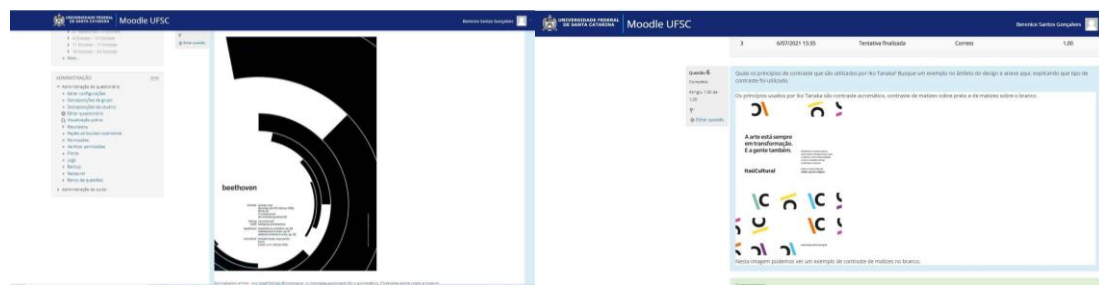
To the academics of the 2021/1 Color Theory class of the Design course at Universidade Federal de Santa Catarina (Federal University of Santa Catarina) for their participation and to the Coordenação de Aperfeiçoamento de Pessoal de Nível Superior – Brasil (CAPES) (Coordination of Superior Level Staff Improvement) for funding the research.

## **REFERENCES**

- ARKIT (About augmented reality and arkit). 2019. *Apple developer documentation*. Online: <https://developer.apple.com/documentation/arkit/aboutaugmentedrealityandarkit>.
- Albers, J. 1974. *L'INTERactions de couleurs*. Paris: Hachete.
- Azuma, R., Bailiot, Y., Behringer, R., Feiner, S., Julier, S., Macintyre, B. 2001. Recent Advances in Augmented Reality. *IEEE Computer Graphics and Applications*. online: <http://www.cs.unc.edu/~azuma/cga2001.pdf>.
- Barros, L. 2011. *A cor no processo criativo: Um estudo sobre a Bauhaus e a teoria de Goethe*. São Paulo: Editora Senac São Paulo.
- Csillag, P. 2011. Um mapeamento de estudos de cores frente ao Modelo SENS|ORG|INT de percepção visual de modo a identificar princípios cromáticos que tendem a ser generalizáveis aos seres humanos. *InfoDesign* 8(2): 39-47.
- Gonçalves, B. 2004. "Cor aplicada ao design gráfico: um modelo de núcleo virtual para aprendizagem baseado na resolução de problemas." PhD diss., Universidade Federal de Santa Catarina.
- Itten, J. 1973. *The art of color*. New York: John Wiley & Sons.
- Schmalstieg, D. and H. T. 2016. *Augmented Reality: Principles and Practice*. Boston: Addison-Wesley Professional.
- Sausmarez, M. 1974. *Basic design: the dynamics of visual form*. New York: Van Nostrand Reinhold.
- Smith, D. 2002. The colour studio in crisis? Embracing change. 9th Congress of the International Colour Association. Proceedings 1017-1020.
- Wang, X., ONG, S. K., NEE, A. Y. C. 2016. A comprehensive survey of augmented reality assembly research. *Advances in Manufacturing* 4(1): 1-22.
- Wong, W. 1997. *Principles of color design*. New York: John Wiley & Sons.

# Teaching and learning color. An insight into STEM/STEAM approach

Berta Martini <sup>1,\*</sup>, Monica Tombolato <sup>1</sup> and Rossella D'Ugo <sup>2</sup>

<sup>1</sup> Università di Urbino Carlo Bo; berta.martini@uniurb.it, monica.tombolato@uniurb.it, rossella.dugo@uniurb.it

\* Corresponding author: berta.martini@uniurb.it

## Abstract

The paper aims to help define the STEM/STEAM approach to Color Education. Nowadays more and more schools embrace this approach as it seems to respond to a need for renewal of teaching while adapting it to the present time. However, this approach is not univocally defined, so that under this label fall experiences of color education of various kinds and different educational effectiveness. Therefore, this work intends to clarify the meaning of this approach. The article is divided into three parts that show the methodological path undertaken. In the first part, some invariant properties of situations classified as STEM/STEAM were identified; in the second part, the invariants were described in terms of didactic variables inferred from the literature and some STEM/STEAM teaching activities; in the third part, some procedural principles to guide teachers' work were formulated and discussed in the context of teaching and learning about color.

**Keywords:** *STEM/STEAM education, color teaching and learning, Didactic variables, Procedural principles, Didactic transposition of knowledge*

## **INTRODUCTION: TOWARD A CLARIFICATION OF THE STEM/STEAM APPROACH TO TEACHING**

Since its being inherently interdisciplinary, color reveals to be a stimulating but challenging teaching-learning object/content within the field of science education. In a previous paper (Martini et al. 2000) we attempted to make explicit its polysemic nature that we identified as the source of several naïve conceptions about color vision detected by empirical research. Whilst fighting against pervasive and stubborn misconceptions as those related to the processes of additive and subtractive synthesis (e.g., Feher and Meyer 1992), there is also the difficulty for students to coherently reconcile their experience with scientific explanations based on idealized models (Giere 2004). This is the reason why our working hypothesis is that a knowledge integration approach like STEM/STEAM (Science, Technology, Engineering, Art, Mathematics) – at least according to a certain interpretation of the acronym – can be a well-suited educational perspective for dealing with issues related to color teaching and learning. If it is the case, it depends on how STEM/STEAM activities are designed and performed.

Let's start by briefly clarifying what we mean by the STEM paradigm in order to understand if and under which conditions it can provide us with some proper recommendations to transform expert knowledge about color vision into knowledge to be taught.

In the field of science education, the acronym STEM was proposed in 2001 to refer to a group of disciplines (science, technology, engineering, mathematics) identified as fundamental to meet the challenges of the future (McComas and Burgin 2020). Historically, the STEM movement developed in parallel with the curriculum reform movement whose characteristic feature was a renewed interest in the content and purposes of education even by experts and academics. This phenomenon affected especially the sciences and resulted in the formulation of curricula that considered scientific and cultural advances and the problems that threatened the national security in the climate of the Cold War (Bruner 1960). Lately, the acronym STEAM has been introduced, where the addition of the letter "A" that stands for Arts, addresses the need to integrate creative thinking and applied arts into real-world situations, allowing for an integration of all curricular disciplines in line with the goals of school education (e.g., Martini 2019).

Although the instructional models and ideas put forth under the STEM label are having a profound impact on the ongoing educational practices in schools all over the world, some educational researchers (McComas and Burgin 2020) have started pointing out limits and contradictions of this potentially revolutionary approach. According to them, an uncritical and politically driven acceptance of STEM is indeed occurring to the detriment of a thorough effort to empirically investigate the merits and drawbacks of this approach which appear to be neither unambiguous nor procedurally defined. While new textbooks and websites are popping up to advise teachers on how to implement STEM practices, STEM curricula lack an awareness of what STEM is and what STEM programs should include. Specially, two main and not particularly clear definitions of STEM are at issue (McComas and Burgin 2020). One definition of STEM recognizes some degree of epistemic similarity among any of the four subjects, that makes them potentially of interest to the same group of educators, but without any expectation that these subjects must be taught together. In contrast, the second definition strongly recommends knowledge integration rather than a mere juxtaposition of different subject matter contents to achieve proper STEM/STEAM goals. This interdisciplinary approach is also encouraged in K-12 education, although there is no universal consensus on how many of the four subjects should be blended and what level of integration should be pursued.

Currently, in Italy, the Recovery and Resilience Plan envisages school reform interventions that enhance STEM in response to the need both to increase students' scientific literacy and to identify approaches for teaching scientific disciplines that are more integrated and supported by digital technologies. Hence, teachers at all school levels – as reported by Orizzonte Scuola, a well-known News and Information portal that is a useful online reference for school employees – are asked to place a great emphasis on the search for connections between disciplines and between theoretical concepts and real-life contexts.

Although we acknowledge the potential fruitfulness of STEM/STEAM education, we advocate nonetheless that integrating knowledge in real world contexts does not ensure success in learning. On the contrary, the very focus on experience in real contexts, where complex phenomena occur, requires a high control, both epistemic and didactic, over the learning situations. Within this framework we aim at improving the conceptualization of the “STEM/STEAM approach” by identifying some instructional procedural principles (Stenhouse 1977) – i.e., pragmatic patterns of behavior that assist teachers in the didactic transposition (Martini 2011) of expert knowledge about color in knowledge to be taught – that can be useful to empirically define what we mean using the term “integration”.

### ***THE INVARIANT PROPERTIES OF EXPERIENCES CLASSIFIED AS STEM/STEAM INSTRUCTIONAL ACTIVITIES***

The first step of the research aiming at identifying such procedural principles consisted of a reconnaissance of the literature in order to identify the features characterizing STEAM/STEAM education starting from the theoretical attempts to conceptualize this approach and from the teaching situations labelled by the authors as examples of STEM/STEAM activities. The result of the analysis allowed us to identify four main characteristics shared by the various experiences.

A first characteristic concerns the “integration between disciplines” in order to overcome their separation and fragmentation. However, constructing interdisciplinary teaching situations implies distinguishing different degrees of integration that concern both the types and the in-depth levels of disciplinary knowledge involved. A second feature concerns the “integration of theory and practice”. Often, in school, the former is treated separately from the latter without considering the relationship existing in the process of knowledge construction between content and disciplinary practices. From an

educational point of view, in order to ensure that this invariant is complied with, it is necessary to bring out the contents as the result of epistemic practices within specific contexts. A third characteristic concerns the “integration of disciplinary knowledge into real-life contexts”. However, referring to real-life contexts is not in itself sufficient to ensure student learning because it also depends on the knowledge already held by the student that guides him or her in understanding and acting within the context. From an instructional perspective, this means controlling the repeated processes of decontextualization and recontextualization of knowledge. Finally, a fourth characteristic concerns the “integration of technologies into teaching”. However, making available and using technologies does not imply better learning, if one is not aware of how technological devices act on the teaching content and the learner's mind.

As can be seen, all four of these characteristics identify four different directions of integration of knowledge to be taught and learned. We assume these characteristics as the “invariants” of the different situations that fall under the STEM/STEAM label. From the educational point of view, the problem at issue is how to ensure that these “invariants” are fulfilled as they are formulated, they represent, indeed, a reference point that is still too vague and abstract to guide the teaching action and, consequently, to characterize precisely and operatively the STEM/STEAM approach. To this end, it is convenient to represent the problem of the creation of teaching situations consistent with the invariants in terms of didactic variables. Since teaching action affects the relationships that are built within the Teacher-Student-Knowledge system, both epistemic variables and learning variables play a fundamental role in this representation. If we accept to represent the problem in this way, then the compliance with the invariants depends on the variables considered and their relationships. In schematic terms, we can interpret each of these invariants as a function of the relationship between certain epistemic and learning variables.

If we denote by  $I_{id}$  the “integration between disciplines” invariant, by  $v_{ex}$  a certain epistemic variable  $x$ , and by  $v_{ay}$  a certain learning variable  $y$ , then we can write

$$I_{id} = f [R (v_{ex}, v_{ay})]$$

Similarly, for the other invariants:

$$I_{itp} = f [R (v_{ex}, v_{ay})] \quad \text{Integration of theory and practice}$$

$$I_{idr} = f [R (v_{ex}, v_{ay})] \quad \text{Integration of disciplinary knowledge into real-life contexts}$$

$$I_{itd} = f [R (v_{ex}, v_{ay})] \quad \text{Integration of technologies into teaching}$$

### **THE IDENTIFICATION OF THE DIDACTIC VARIABLES**

At this point, let's describe the individual didactic variables allowing to consider both the aspects related to the object of learning and the aspects related to the subject of learning. After identifying these variables, the procedural instructional principles can be formulated from teaching situations that satisfy the invariants, while being consistent with the STEM/STEAM approach. The identification of the didactic variables was carried out based upon the educational literature and by analyzing some concrete instructional activities labelled as STEM/STEAM and published in scientific journals or made publicly available on dedicated web portals. Here we refer, by way of example, to three experiences addressed to students of different school levels ([www.stem.org.uk/resources/community/collection/286171/colour](http://www.stem.org.uk/resources/community/collection/286171/colour); Koyunkaya et al. 2019; Dark 2019) as they allowed us to evaluate the STEM/STEAM approach to teaching content related to light and color that differs in the degree of depth in which they are covered (simpler or more complex). The different types of activities and learning environments (structured and supported by more or less advanced technologies) designed according to this approach were also examined.

The analysis led to the identification of the didactic variables shown in Table 1. We distinguished between epistemic variables, related to the object of teaching/learning and individual learning variables, related to the subject who learns. The former identifies the factors that constrain the teacher's choices about the transposition of knowledge; the latter refer to the factors on which individual student's learning depends. The latter are therefore transversal to all invariants.

STEM/STEAM Approach	Didactic variables	
INVARIANTS	Epistemic variables	Learning variables
<b>Integration between disciplines</b> (interdisciplinarity)	<ul style="list-style-type: none"> <li>- <i>Disciplines involved</i> (which and how many)</li> <li>- <i>Level of depth and complexity of the teaching content involved</i> (basic/advanced)</li> <li>- <i>Interplay between disciplines</i> (curricular continuity/discontinuity)</li> <li>- <i>Forms of disciplinary reasoning</i> (analogy, induction, deduction, abduction, by trial and error, by falsification, by models, probabilistic, statistical, etc.)</li> </ul>	<ul style="list-style-type: none"> <li>- Level of students' prior knowledge</li> <li>- Ability level</li> <li>- Skill level</li> <li>- Language mastery</li> <li>- Learning pace</li> <li>- Preferred learning styles (different sensitivity to didactic mediators)</li> <li>- Interest and motivation</li> <li>- Misconceptions</li> <li>- Ability to use technology</li> </ul>
<b>Integration of theory and practice</b> (knowing and doing)	<ul style="list-style-type: none"> <li>- <i>Types of knowledge to be integrated</i></li> <li>- <i>Type of practical knowledge</i> (expert practice and practice as teaching expedient)</li> <li>- <i>Degree of formalization of knowledge</i></li> </ul>	
<b>Integration of disciplinary knowledge into real-life contexts.</b>	<ul style="list-style-type: none"> <li>- <i>Historical evolution of the discipline</i> (problems and contexts of genesis and development of knowledge)</li> <li>- <i>Degree of complexity of the problem-situations</i></li> </ul>	
<b>Integration of technologies into teaching</b>	<ul style="list-style-type: none"> <li>- <i>Type of technologies</i> (non-digital, analogical and digital) <i>used as a means to learn certain content</i></li> <li>- <i>Technologies used to represent knowledge</i></li> <li>- <i>Technologies used to construct knowledge</i></li> </ul>	

### **THE PROCEDURAL PRINCIPLES FOR IMPLEMENTING THE STEM/STEAM APPROACH TO COLOR TEACHING**

We are now able to formulate the procedural instructional principles based on the identified variables that can provide operational guidance to fulfill the “invariants” that characterize the STEM/STEAM approach according to our hypothesis. After formulating the general procedural principles, we will discuss them in relation to color education experiences in order to clarify the meaning of such invariants and to provide operational guidance for designing color teaching activities. We point out that the invariants and consequently the procedural principles have been isolated from a logical point of view, but as closely interrelated, in teaching practice almost every activity exemplifies multiple of them.

#### **I<sub>d</sub> (Integration between disciplines)**

1.1 *Given equal individual learning factors, an instructional activity is consistent with the STEM/STEAM approach if it involves multiple disciplines (S, T, E, A, M).*

1.2. *Given equal individual learning factors, an instructional activity is consistent with the STEM/STEAM approach if the contribution of the disciplines involved is targeted to the specific teaching content.*

1.3. *A teaching activity is consistent with the STEM/STEAM approach if the selected topics are covered at the same level of depth within each discipline and if such level of depth is appropriate to students' prior knowledge.*

1.4. *An instructional activity is consistent with the STEM/STEAM approach if it has different degrees of complexity that allow it to promote various forms of disciplinary reasoning in learners.*

A typical integration concerns Science and Art. This binomial, although potentially fruitful, requires precise control over the contents and their relationships. E.g., to place side by side the explanation of the mechanisms of color vision with the explanation of the mixing of pigments without distinguishing the different points of view from which color is approached, is ineffective for both teaching and learning: the contents of teaching about color are not organized in a logically coherent way; learning is subject to generating cognitive conflicts that are likely to turn into misconceptions (we self-contribute). Therefore, the procedural principles (1.1. and 1.2) require us to check if and how Science and Art contribute to the understanding of the different “descriptions” of color (color lights/chromatic pigments). A further example involves integration between Science and Mathematics. In this case, it is evident how integration requires control of the levels of depth of the knowledge involved (1.3 and 1.4). E.g., additive synthesis is usually depicted through graphical schemes, like Euler-Venn diagrams, which students must be able to understand from a logical point of view. Similarly, in a teaching situation that proposes a diffraction experiment, knowledge of trigonometry allows us to calculate the wavelengths of individual light rays and thus understand the quantitative relationship between perceived color and wavelength of light.

#### **I<sub>tp</sub> (Integration of theory and practice)**

2.1 A teaching activity is consistent with the STEM/STEAM approach if it consistently involves disciplinary content and student-performed practices.

2.2 A teaching activity is consistent with the STEM/STEAM approach if it integrates the theoretical knowledge and practical experience of students in a suitable way to capture their interest and motivation.

2.3 *An instructional activity is consistent with the STEM/STEAM approach if it integrates the theoretical knowledge and practical experience of learners in a suitable way to their preferred mode of learning.*

2.4. *A teaching activity is consistent with the STEM/STEAM approach if the degree of formalization of knowledge is appropriate to students' prior knowledge and if it considers their different sensitivity to the use of didactic mediators (active, iconic, symbolic mediators).*

Regarding the integration of theory and practice, procedural principles suggest that we check for consistency between the theoretical teaching content and the activities that the teacher engages students in to exemplify or portray that content (2.1, 2.2, 2.3, and 2.4). E.g., it is common for teachers to use Newton's disk and colored spotlights to make students understand additive synthesis. These experiences capture students' attention and intercept their different sensitivity to didactic mediators. However, these experiences may not be consistent if you do not make explicit the difference between emitted and reflected light and the different effect you get as a result.

#### **I<sub>dr</sub> (Integration of disciplinary knowledge into real-life contexts)**

3.1. *A teaching activity is consistent with the STEM/STEAM approach if it involves problematic real-world situations that allow students to ascribe meaning to disciplinary contents.*

3.2. *A teaching activity is consistent with the STEM/STEAM approach if it involves monitoring the degree of “similarity” between the phenomenon reproduced within the teaching situation and the phenomenon to be represented.*



Regarding the integration of disciplinary knowledge in real-world contexts, a virtuous example (Dark 2019) is achieved by integrating the historical evolution of the scientific understanding of light as a physical phenomenon and the evolution of the way painters have portrayed light over the centuries (3.1 e 3.2). The historical dimension evokes the real problems that scientists and artists had to solve. As Shlain (2007) outlined, the evolving scientific conceptual understanding of light changed painting techniques, as well as Art contributed to develop the cultural thinking to foster progress in Physics. In higher education, for example, a meaningful integration experience might involve setting up a lab in which students try to investigate the conditions to best illuminate a painting having certain characteristics and located in a certain environment.

#### **I<sub>td</sub> (Integration of technologies into teaching)**

- 4.1. *A teaching activity is consistent with the STEM/STEAM approach if it is supported by technology.*
- 4.2. *A teaching activity is consistent with the STEM/STEAM approach if technologies are used by teachers to present knowledge content.*
- 4.3. *A teaching activity is consistent with the STEM/STEAM approach if technologies are used by students in knowledge-building practices.*

Regarding the use of technologies in teaching color, some devices allow us to support the teaching experience in a way that ensures consistency with the logic of the theoretical content. For example, the representation of additive and subtractive synthesis processes, which usually generate multiple misconceptions due to the inadequacy of the devices employed, can be supported using monochromatic spotlights of adjustable intensity and high reflective screens. An example of subtractive synthesis, alternative to the pigment mixture usually proposed at school, is the illumination of an object by three monochromatic light sources (red, green, blue – RGB) simultaneously. The presence of the obstacle allows the formation of shadows that overlapping make available a dynamic representation of the static image usually used to represent the subtractive mixture. Specially, the areas where the shadows intersect are black, while the areas surrounding the black shadow are colored shadows composed of primary and secondary colors (Koyunkaya et al. 2019: 113). This reveals to us that there is a significant relationship between the color of the light and the pigment color.

#### **REFERENCES**

- Bruner, J. 1960. *The Process of Education*. Cambridge: Harvard University Press.
- Dark, M. L. 2019. Light and Color in a Physics and the Arts Course. *Circe magazine: steam edition*: 149-155.
- Feher, E., and K. R. Meyer. 1992. Children's conceptions of color. *Journal of research in Science Teaching* 29(5): 505-520.
- Giere, R. N. 2004. How models are used to represent reality. *Philosophy of science* 71(5): 742-752.
- Koyunkaya, M. Y., T. Enginoglu, B. Karabey, and K. Yurumezoglu. 2019. A Colorful STEAM Activity. *Circe magazine: steam edition*: 108-120.
- Martini, B. 2011. *Pedagogia dei saperi*. Milano: Franco Angeli.
- Martini, B. 2019. Verso un modello di curricolo integrato. *Pedagogia più Didattica* 5(2): 1-8.
- Martini, B., M. Tombolato, and R. D'Ugo. 2019. Primary colors as a source of possible misconceptions: an insight into teaching and learning about color. *Color Culture and Science* 11(02): 25-33.
- McComas, W. F., and S. R. Burgin. 2020. A Critique of "STEM" Education. *Science & Education* 29(4): 805-829.
- Shlain, L. 2007. *Art and Physics: Parallel visions in space, time, and light*. NY: Harper Perennial.
- Stenhouse, L. 1977. *Dalla scuola del programma alla scuola del curricolo*. Roma: Armando Editore.

# Color and Polymers at ITECH

Caroline Bouchez <sup>1</sup>, Blandine Chorein <sup>2</sup> and Dominique Corger <sup>3,\*</sup>

<sup>1</sup> Cosmetic laboratory, ITECH Lyon, Ecully (69), France, caroline.bouchez@itech.fr

<sup>2</sup> Research Manager, ITECH Lyon, Ecully (69), France, blandine.chorein@itech.fr

<sup>3</sup> Colorimetry laboratory, ITECH Lyon, Ecully (69), France, dominique.corger@itech.fr

\* Corresponding author: dominique.corger@itech.fr

## Abstract

ITECH Lyon was founded with the aim of combining 4 professional fields into a single course of study focusing on "polymer materials and coatings": chemistry, plastics engineering, leather and textiles.

These specialties have in common polymers chemistry and color. ITECH has a laboratory dedicated to colorimetry, for academic and professional training.

In the Colorimetry Lab, training is organized in different sessions, based on the following topics: practice of color and use of dyes/pigments for visual color-matching, measurement of colors with spectro-colorimeters and use of colorimetric quality-control software, interpretation of color differences, formulation-correction of colors by using computer-aided color-matching and dye/pigment databases, as well as initiation to effect colors and effect pigments with metalized colors and pearly colors.

Colorimetry is part of many constantly-evolving industries, which is why training is essential for novices and experts alike. Many devices that can be used during the training are adapted to participants and so is the content. Novices are taught the color vocabulary, the color definition, to achieve color-matching, etc. Experts will better understand and anticipate color variation, they will learn how to control and adjust tints by using a spectrophotometer, how to create a database on a specific spectrophotometer, how to optimize the use of devices, etc. Many ways to help professionals and students to expand their knowledge.

**Keywords:** Training, Colorimetry, Color-matching, Color correction, Spectrophotometer

## INTRODUCTION

If education is ITECH's first vocation, its links with industry are amongst its strong points. ITECH Lyon and its subsidiary ITECH Entreprises offer scientific and technical contractual services in the form of industrial studies, trials, consulting, material leasing and professional training.

Colorimetry is one of our specialties and expertise used in many fields: inks, paints, cosmetics, leathers, textiles, plastics. Colorimetry is a complex science that requires training to perform assessment and correction.

## HOW IS THE COLOR TRAINING ORGANIZED?

In the **Colorimetry Lab**, academic and professional training is organized in 4 different sessions.

**Session 1** is focused on **practice of color**, and use of dyes/pigments for **visual color-matching**. This session explains basics on lights and CIE illuminants, definition of color and interactions of light with colored samples, vision of colors and CIE observers. Use of dyes/pigments and mixing laws (addition, subtraction, juxtaposition) are detailed.

Visual tools are shown, either color circle for pigments, or color triangle for dyes. Finally, the phenomenon of metamerism is defined.

Regarding Lab work, it's composed of visual study of the behavior of dyes and pigments, visual description of target color, selection of dyes and pigments for better reproducibility, color mixing and visual color-matching (see Figure 1).



Figure 1: Example of color mixing (left) and visual assessment of color (right) [1].

The topic of **Session 2** is **Colorimetry and quality-control software**. It starts with standardized Color Cards and Atlas (RAL, Pantone, NCS, Munsell). Then colorimetric systems (CIELab, CIE XYZ, RGB) and interpretation of color differences are presented. Calculation of  $DE^*$ ,  $DE$  CMC, CIE 1994, CIE 2000 is explained. The principle of color measurement is demonstrated. Measurement devices such as Colorimeters, Spectro-colorimeters (see Figure2) and Muti-angles are detailed. It ends with definition and control of Color Strength.

Regarding Lab work, it's composed of use of colorimetric quality-control software (Datacolor, Minolta), measurement of color and data such as whiteness, yellowness, metamerism, opacity, as well as use of measurement for color-matching and correction of color, and also acceptance and acceptability of color.



Figure 2: CIELab color space (left) [2] and example of spectrophotometer(right) [3].

**Session 3** deals with **Formulation-correction of colors by using computer-aided color-matching** and dye/pigment databases. First, color rules used for opaque/transparent/translucent colors are presented, and also the relations of gloss-matt effect and opacity-transparency with color. Then, the principle of color-matching software is outlined: calculation of color and Kubelka-Munk theory. The creation of a dye/pigment database is explained: K & S data, colored mixing for calibration, and testing colors.

Regarding Lab work, it's composed of the creation of a pigment database for opaque colors, and use of Datamatch software to formulate and correct colors (see Figure3).



Figure 3: Mixing of pigment pastes in a white paint (left) and mixing of pigments in polyethylene material (right).

**Session 4** is an initiation to effect colors and effect pigments, with metalized colors and pearly colors. The flip-flop effect and the visual description of effect colors are defined. Measurement devices, such as multi-angle spectroradiometers, are detailed. For effect pigments, both aluminium and pearlescent pigments are explained, along with chemical nature, properties and the principle of colored effects. Important parameters are described: shape, size, thickness, position/organization of effect pigment particles, influence of colored pigments, influence of process conditions (mixing, dispersion, application...). Finally, the role of a microscope is studied.

Regarding lab work, it's composed of color-matching with effect colors (metalized colors and pearly colors), visual observation, measurement with multi-angle, and use of microscope (see Figure4).



Figure 4: Example of interference colors (left) [4] and measurement of effect color with multi-angle (right) [5].

### **HOW TO SELECT THE APPROPRIATE DEVICE?**

The color is essential to providing many properties: shininess, matteness, tint, etc. A color can be perceived through the human eye or by using some devices as spectroradiometer.

Below is a list of equipment and software used in the Color Lab, with descriptions (see Figure5).

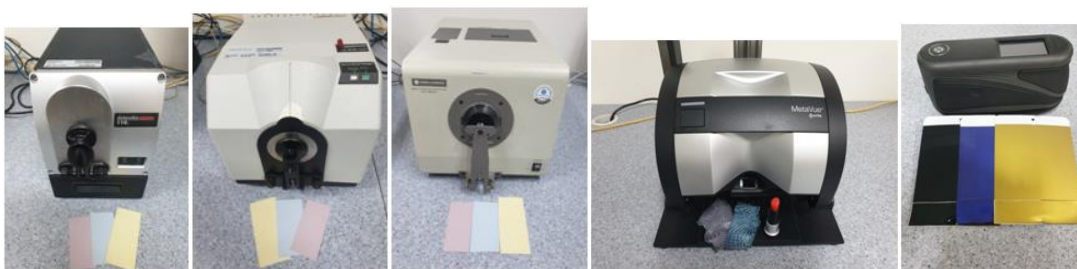

Figure 5: Different spectroradiometers (from left to right): Dataflash 110, Spectraflash SF300, Konica Minolta CM 3600d, Metavue VS 3200, MA-T6 multi-angle.

### **Datacolor**

- Spectroradiometer Dataflash 110: integrating sphere, reflection mode, used for opaque colors of solid samples
- Spectroradiometer Spectraflash SF300: integrating sphere, reflection mode, used for opaque colors of solid samples
- Software for Formulation-Correction: Datamatch Pigment

**Konica Minolta**

- Spectrocolorimeter CM 3600d: integrating sphere, diffuse/8° geometry, reflection and transmission mode, used for opaque or semi-transparent colors of solid samples, and transparent colors of liquid or solid samples
- Software for Quality-Control: SpectraMagic NX
- Software for Formulation-Correction: Colibri

**Xrite**

- Spectrocolorimeter Metavue VS 3200: multi-spectral imaging, 0/45 geometry, contactless, reflection mode, used for opaque or semi-transparent colors of solid and liquid samples, pastes, powders, and also samples with a small size, irregular shape, uneven surface
- Multi-angle spectrocolorimeter MA-T6: measurement at 45°, 6 lamps at -15°/15°/25°/45°/75°/110°, camera, used for effect colors of solid samples, like paints, plastics, textiles, cosmetics, and in application area like the automotive industry, building materials, packaging
- Software for Quality-Control: Color iQc, Nucleos EFX Qc
- Software for Formulation-Correction: Color iMatch

***WHAT MISSIONS DOES A COLOR SPECIALIST HAVE ?***

The knowledge of colorimetry is very wide and can be useful in many applications. Here are some examples of missions a color specialist can carry out:

- Creation of database in opaque formula for inks
- Setting up a spectrocolorimeter in a laboratory
- Developing new colors and optimizing them
- Quality control of colored products
- Setting a validation method for lipstick bulk colors by using a spectrocolorimeter
- Development of new attractive exterior colors for coatings, and waterborne formula optimization
- Development of a paint formula with multicolor effect for cookware
- Color instrumental measurements, interpretation of colorimetric data
- Color measurement in transmission for plant oils
- Measurement of color and transmittance for transparent polymer panels, influence of dye concentration and chemical nature on ageing of polymer
- Measurement of color and reflectance for powder samples
- Measurement of color for polyurethane plastic parts, thermal stability of yellow pigment pastes
- Measurement of color on painted panels, comparison with RAL 1004 standard color
- Application of nail polishes on contrast card, colorimetric measurement, creation of colors and color-matching
- Audit visit of paint manufacturing plant, observation of manufacturing processes of paste colored products, in order to improve color-matching of paint products with tinting machine

### **WHICH FIELDS ARE CONCERNED?**

Many fields have a connection with colors. We can give examples in the sectors of raw materials, manufacturing, tailoring, dyeing, and application. At ITECH, it corresponds to the 4 majors : leather, formulation chemistry, textiles, plastics.

For the leather field, we work with tanneries, leather goods, shoes and dye suppliers...

For the formulation chemistry field, we work with cosmetic and paint laboratories, raw material suppliers, end users,...

For the textile field, we work with dyers, textile coating companies, raw material suppliers ...

For the plastic field, we work with masterbatch manufacturers, injection molding companies ...

Collaborations can be set up in educational training, professional training, technical studies, etc. Topics can be color development, validation of dye/pigment ranges, colorimetric databases, etc.

### **REFERENCES**

1. "Visual assessment of color", RAL colors, accessed June 15, 2021, <https://www.couleursral.fr/>
2. "CIELab color space" , CIE, accessed June 15, 2021, <https://cie.co.at/>
3. "Example of spectrophotometer", XRite, accessed June 15, 2021, <https://www.xrite.com/fr-fr>
4. "Example of interference colors" , Merck, accessed June 15, <https://www.merckgroup.com/>
5. "Measurement of effect color with multi-angle", Byk Altana, accessed June 15, 2021, <https://www.byk-instruments.com/fr/>



# How to convert an experience-based university course about colour, light and space for the web?

Saara Pyykkö<sup>1,\*</sup>

<sup>1</sup> Aalto University; saara.pyykko@aalto.fi

\* Corresponding author: saara.pyykko@aalto.fi

## Abstract

COVID-19 forced university studies to the web. This paper describes the case study of an experience-based MA-level course at Aalto University about colour-light-space. The purpose is to evaluate and research the used pedagogical methods in the web-based educational environment. The research methods are: practice-based case study, documentation of the course and students work, a questionnaire for the students, and personal notes. Three pedagogical principles summarize the results: 1) new practices and rules of the web-based educational environment, 2) pedagogical methods for connecting people during the course and 3) methods for building the experience of colour, light and space for the web. All lectures, assignments and virtual excursions were adapted to the web.

**Keywords:** Architecture, Education, Web-based education, Colour, Light, Space

## INTRODUCTION

The COVID-19 pandemic changed university teaching in March 2020. At the end of 2020, it was the moment to evaluate the structure of the course and to consider the main pedagogical challenge: How to convert the experience-based and learning-by-doing-based course about the colour, light and space for the web? How to build experience, perception, discussions and interaction with students, and to teach architectural colour design? This case-study deals with an MA level university course at Aalto University, Finland. The course 'Colour-Light-Space' during 2017-18 (4 ECTS) is documented (Arnkil and Pyykkö 2018). The writer has been responsible for the (enlarged 6 ECTS) course since 2019, including 64 hours contact teaching and 98 hours student's independent work. The aim is a deep experience-based understanding of the possibilities and the role of the colour and the lighting in the built environment. The 20 participants study architecture (9), interior architecture (3), landscape architecture (3), textile design (1) or visual culture (4). The research methods are practice-based case study, documentation of the course and students work and a questionnaire for the students.

## LECTURES AND ASSIGNMENTS 1A-F, 2ABC, 3, 4AB

The course includes lectures, excursions and four types of assignments. The lectures deal with lighting, colour systems and colour models, colour design in the urban design context, in interior architecture and in landscape architecture and art. Unfortunately, all excursions such as those to iGuzzini and Tikkurila Oyj, as well as historical architecture such as the National Library of Finland and The Ateneum Art Museum, had to be organized only as webinars.

The four types of assignments are: 1A-F are short tasks about *colour mixing with the watercolours, analyzing colours, practicing the NCS Colour system, using the PERCIFAL method, and the Colour walk* (see page 4). 2ABC includes *three reading seminars*. The students prepared one presentation during the course and acted as an opponent in other two reading seminars. 2A dealt with *perception* (Arnkil et al. 2012; Fridel Anter and Svedmyr, 2004) and *architectural atmosphere* (Böhme 2017a; Pallasmaa 2016; Tanizaki 1997; Zumthor 2006), and gave conceptual tools for the assignments 3. 2B gave practical tools for *colour design strategies and colour designing* (Delcampo-Carda et al. 2019; McLachlan 2012, McLachlan et al. 2015; Porter and Mikedilles 2009; Serra Lluch 2019; Smedal 2001)



How to convert the experience-based university course about colour, light and space for the web?

for the last assignments 4A and 4B. 2C opened the *meaning of colour in the work of architects, artist and designers*, De Heer, (2009), and presented the phenomenon *synesthesia*, (Arnkil 2003, 2010; Böhme 2016b). The assigned literature was books, scientific articles, and other writings. 2B and 2C included names without related literature: James Turrell and Olafur Eliasson, Roberto Burle Marx, Luis Barragan, Bruno Taut, Matthias Sauerbruch & Luisa Hutton and le Corbusier, where the students used books and web-based visual material as sources. After the reading seminars, the students shared their PowerPoint-presentations, and this way they got condensed knowledge from several disciplines.

Task 3 was the *analysis of the architectural atmosphere* of a street or a block. The main idea was to gain understanding about the atmosphere of the site, identifying the main aspects and how those aspects change. The name of the course is *Colour-Light-Space*, so they were the main aspects to study. However, other factors such as ageing of façade, its wetness, the illumination and the weather, involved in their perception and experience. The students needed to visit their blocks at least three times in different the illuminations and weathers. The buildings were of different architectural styles, building materials and colour scales.



Figure 1: Assignments 3, “Atmosphere of place”. The students learned to use the NCS colour system as a tool of architectural colour design. One of the main highlight moments was to understand how the colours differ in cloudy daylight, sunny daylight, and cloudy evening (left: Kirsi-Maria Raunio, MA-student of Visual Cultures and Assi Lindholm, MA-student of architecture). A positive effect of realising the course across the web was that one of the students started the course from Copenhagen and three other students took the course from cities in Finland. (right: Janina Hedström, MA student of architecture).

The last task, 4AB, concluded the earlier tasks, and the students applied their broadened understanding to a real on-going architectural colour design project including an *analysis* (4A) and a *sketch of the colour design* (4B). The case was a new block with three buildings. The architect of this case, a professor Pentti Kareoja from AKR-house arkkitehdit Oy, played two roles on the course. He was an architect of the project, needing a new colour design, and he was also a visiting critic in the reviews of the analysis of the site (4A) and the final sketch of the colour design (4B).



Figure 2: 4A, “Two analyses of the site”, (left: Riku Kuukka, MA-student of landscape architecture and Tapio Tuomi, MA-student of architecture. Right: Julia Lehto, MA-student of textile design and Assi Lindholm, MA-

student of architecture). The students applied the new understanding from the task 3 to the real architectural project. The students used 20 hours for the analysis of the environment of the three new buildings.



Figure 3: 4B, “The sketch for the colour plan” from the same students. (left: Riku Kuukka, MA-student of landscape architecture and Tapio Tuomi, MA-student of architecture. Right: working process from Julia Lehto, MA-student of textile design). The students used 20 hours for the last task, and they designed with several design methods. According to the feedback, many students said that they rediscovered doing with hands, and they will use not only the computer, but drawing, watercolours and painting as a design method in the future.

### **THREE PEDAGOGICAL PRINCIPLES FOR MAKING A COURSE WEB-BASED**

My participation in 7 Experiences, Aalto Experience Summit in September 2020 revolutionised my approach to web-based communication. The organizer provided the participants step-by-step instructions on how to make the atmosphere of the meetings more focused, e.g., by organizing the physical working environment and avoiding multi-tasking. The new participation guidelines were based on state-of-the-art scientific knowledge on so-called Zoom fatigue and how to prevent it (e.g., Bailenson, 2021). My knowledge grew during the course with the interaction of the students and their feedback. The analysis of the pedagogical interventions used during the course and in the different type of assignments can be summarized as the following three pedagogical principles:

1) *The new practice and rules of web-based educational environment.* In the first meeting, I presented the rules of the course and I explained the scientific reasons behind it. The students used the sketchbook for their personal notes, and they took screenshots from the presentations if needed. To avoid multitasking, no ‘chat’ was used. The course materials were available in *MyCourses*. To avoid “virtual meeting fatigue”, (Nurminen and Pakarinen 2019), we had after 45 minutes at least a small break, and after 90 minutes a longer break. During the breaks, I encouraged the students to look out from the window, to take a small nap and to avoid the social media. Several software were used during the course: *Zoom* was the main educational environment. The optimal time of breakout sessions varied between 15 to 30 minutes. *Flinga* was used in the virtual Colour Walk and collecting the results and data from the breakout room sessions. The students used *PowerPoint* in their presentations and some of them *SketchUp*, *Miro*, *Photoshop* and *ArchiCAD*. One of the most innovative ideas was to use *Google map* for virtual traveling. One of the students used it to present Bruno Taut and his colour design projects in Berlin by traveling virtually to see the current colours of Taut-designed neighborhoods.

2) *Connecting people* refers to the methods by which the connection, interaction and grouping between the students were pedagogically built. In the first meeting, the students presented themselves via pictures and they told their personal motivation and aims for this course. The social aspects of student-to-student interaction and well-being were important. During lockdown, the four-hour Zoom session could be the only social contact of the day. The students learned from each other, because all small groups were organized with students from different backgrounds. (see page 1). The teacher was not allowed to demand students to keep their camera on, but some voluntary faces helped

the teacher to have a feeling of interaction. The best size of breakout rooms was a group with 4-5 participants. In a group of 6-7, one student had the role of moderator and another was a secretary. The role of moderator was to activate silent students and to curb talkative persons. The secretary collected the answers for the question or the results of the discussion. During the course, every person served in both roles.

3) *Building the experience* refers to a single student's experience and the shared experience of the group, and how the experience is built in assignments and lectures. The visitors were asked to build their presentations from the perspective of experience. For example, the lectures described the space and the place not only through visual aspects but also through other senses, such as the smell of the sea, the sound of the rushes in the wind, or wetness of the walls. Tasks 1B, *my water colour palette*, and 1C, *Four possible mixtures of ten basic colour*, opened the sensitivity to the colour. Task 3, *architectural atmosphere*, was an important start to the main analysis and the design assignment. The understanding of experience and interaction of colour, light and space in human perspective grew through personal perceptions and experiences on the site, and from sharing those perceptions in the mid-critic sessions and discussions with the main group or in breakout rooms. Tanizaki's "In praise of Shadows" and Pallasmaa's "The eyes of the skin" were given as reading to increase awareness of all the senses. The Colour Walk method (Pyykkö 2016) was developed to understand the colours of neighbourhoods and the influence of the detailed plan and design guidelines on them. However, I have used that as a learning method too. Now the Colour walk was realized in two parts. During the lockdown, only the students who were able to walk or drive to the area, did it. They walked the route, took photos, and made notes. After that, on the next Zoom-meeting, we walked virtually in Flinga software the same route and discussed about their perceptions and experiences. The virtual colour walk opened the experience of the pedestrian and enlarged the understanding for the meaning of views, distances, spaces, volumes of architecture and material of the facades.

### **STUDENT'S FEEDBACK AND TEACHER'S EXPERIENCE**

After the course, 8 out of the 18 students answered the questionnaire, and a few students gave feedback by e-mail. All eight students gave the course the highest score (5/5) in their evaluation. 7 out of the 8 students gave 5/5 and 1 student gave 4/5 for the organization of the course. "The best organized course during the Corona!". I asked what five books /articles /professionals of the reading seminar supported the best their studies. 63% answered Fridell Anter and Svedmyr, 38% the presentations about Bruno Taut and Burle Marx, and 25% answered Zumthor, Tanizaki, and the presentations about Olafur Eliasson and Le Corbusier. Some students felt it was hard to name the most important literature. Next lectures supported most their studies: 75% colour systems and colour tools, 63% designer's talk about landscape architecture and art, 50% colour in the detailed plan and urban design context, 38% the opportunities of lighting and designer's talk about interior architecture.

I asked about the three pedagogical principles: 1) *new practices and rules for a web-based educational environment*, 2) *pedagogical methods for connecting people during the course* and 3) *methods for building the experience of colour, light and space on the web*. 1) The students named the lectures, the breaks, the structure of the course, the long-term working during the entire spring term, the breakout sessions and working in small groups "as well as the different type of approach such as literature, the colour walk, assignments supported my learning, despite the fact that we didn't see each other". 2) According to the students, the connection was built with the working in breakout rooms, in the discussions of the literature seminars, working in the small groups in assignments 3 and 4AB. They appreciated the long-term co-working in task 4AB and learning from each other by working with

How to convert the experience-based university course about colour, light and space for the web?

students from other disciplines. The atmosphere of the course was encouraging, and they thanked the teachers' amazing attitude: *"The best course in the corona time, humane and encouraging"*. 3) As to the question about building the experience, the students answered: *"The experience about colour, light and space broadened little by little"*. The lectures of the professionals, the literature seminars and discussions, the diversity of the students, the own and the shared experiences, and task 3, Atmosphere, supported their understanding and learning. *"Percival made me look at the physical environment more analytically."*

From the perspective of a teacher with 25 years of teaching experience, the course meant more than learning lots of new software. It forced on to study new practices on a web-based educational environment, to evaluate all earlier assignments, to add more task with watercolours, to consciously include the topic of experience in all meetings and discussions. All prework, planning the schedule and meetings, preparing the material for the web, organizing small group discussions in breakout rooms, familiarizing oneself with student's work, and writing e-mails, tripled the teacher's workload. Scientific knowledge of such matters how to avoid Zoom fatigue, and mental and physical wellbeing of the students grew 'more and more' important during the course. The teachers were encouraged by the university to organize breakout room sessions, and thus to add the co-operations between students. The students of Aalto University are hard-working and ambitious, so they needed continuous reminding how many hours they need to use for each task. *"The course is a learning process"* or *"It will be sufficient to use 20 hours for this task"*. The course does not have numerical evaluation, only pass or fail. Despite that, I could have given the best grade to almost every student for their excellent participation in the web-based course in this demanding situation.

## **CONCLUSION**

Converting the experience-based university course about colour, light and space for the web is based on scientific knowledge about the new educational environment. Based on the findings of this case study, three pedagogical principles were identified: 1) *new practices and rules of web-based educational environments* aiming at avoiding multitasking, Zoom fatigue and at promoting well-being, 2) *pedagogical methods for connecting people* during the course such as discussions in breakout rooms, long-term group work and cooperation in assignments and 3) *methods for creating the experience of colour, light and space across the web*; for example, lecturers described the site and places through many senses, not only with images. The course started with a personal touch to colour and colour mixing with watercolours. The students used drawing, painting and other design methods in the main design assignments, not only relying on the computer. Thus, it was surprising that in this web-based course, students rediscovered working with their hands. The feedback of the students summarizes this point: *"I learnt a lot about colour, light and space. However, equally important was the teacher's continuous reminding: don't multitask, remember the breaks and that the estimated hours per task are sufficient"*.

## **ACKNOWLEDGEMENTS**

I am grateful for The Finnish Cultural Foundation which has supported this research. I would like to thank all students for their participation, curiosity and interaction during the course. All visiting lectures impacted this course in important ways, especially Pentti Kareoja, who presented the main task and acted as a visiting critic. I thank Harald Arnkil for discussions about the 'Colour-Light-Space' course and the comments on this conference paper.

## REFERENCES

- Arnkil, H., 2003. Mitä silmä kuulee ja korva näkee – Maalaustaiteen ja musiikin yhteyksistä. <http://www.svy.fi/mita-silma-kuulee/>. (loaded 20.6.2021)
- Arnkil, H., K. Fridell Anter, and U. Klarén. 2012. *Colour and Light – Concepts and confusions*. Espoo: Aalto ARTS Books.
- Arnkil, H. 2010/2021. *Värit havaintojen maailmassa*. Espoo: Aalto ARTS Books [In English: Colours in the Visual World]. 131-134.
- Arnkil, H. and S. Pyykkö. 2018. Color–Light–Space: an interdisciplinary course for graduate and postgraduate students. *Color Research and Application* 43: 857-864.
- Bailenson, J. N. 2021. Nonverbal Overload: A Theoretical Argument for the Causes of Zoom Fatigue. *Technology, Mind, and Behavior* 2: 1
- Böhme, G., (ed. Engels-Schwarzpaul, A.-Chr.). 2017. *Atmospheric Architectures: The Aesthetics of Felt Spaces*. Bloomsbury Academic. London New York. chapters: Atmosphere, a Basic Concept of New Aesthetic s. 13-36, Atmospheres in Architecture, s. 69-80, Light and Space s. 143-156.
- Böhme, G., (ed. Thibaud, J-P.) 2017. *The Aesthetics of Atmospheres*. Routledge. London New York. chapter: On Synesthesia. 66-75.
- Delcampo-Carda, A., A. Torres-Barchino, and J. Serra-Lluch. 2019. Chromatic interior environments for the elderly: A literature review. *Color Research and application* 44:3, 381–395.
- De Heer, J., 2009. *The architectonic colour: Polychromy in the Purist Architecture of le Corbusier*. Rotterdam.
- Fridell Anter, K., and Å. Svedmyr. 2004. *Mikä talolle väriksi*. Kustannus Oy Hakkuri.
- McLachlan, F. 2012. *Architectural Colour in the Professional Palette*. Taylor & Francis Group. London and New York. 1–101, 103–195.
- McLachlan, F., A.M. Nesar, L. Sibilliano, M. Wenger-Di Gabriele, and S. Wettstein. 2015. *Colour Strategies in Architecture*. Haus Der Farbe. Schwabe AG, Basel.
- Nurmi, N. and S. Pakarinen. 2019. Virtual meeting fatigue and its cognitive performance costs. *Academy of Management Annual Meeting Proceedings*, 2019(1):10956.
- Pallasmaa, J. 2016. *Ihon silmät - arkkitehtuuri ja aistit*. ntmo. [In English: Eyes of the Skin: Architecture and the Senses].
- PERCIFAL. <https://www.konstfack.se/syn-tes>. (loaded 20.6.2021).
- Porter, T.(ed.) and Mikellides, B. (ed.) 2009. *Colour for Architecture Today*. Routledge. Taylor & Francis Group. London and New York. p. 23–49, 79–115.
- Pyykkö, S. 2016. Colours of a Neighborhood: Methodological Questions and Challenges. In: *AIC2016 Interim Meeting Color in Urban Life: Images, objects and spaces*, 56-59.
- Serra Lluch, J. 2019. *Color for Architects*. Princeton Architectural Press. New York. p. 72-164.
- Smedal, G. 2001. *Longyerbyen I farger – og hva nå, Longyearbyen in colour – status and challenges*. Eider. Bergen.
- Tanizaki, J. 1997. *Varjojen ylistys*. Taide. [In English: In Praise of Shadows].
- Zumthor, P. 2006. *Thinking Architecture*. Birkhäuser. Basel.

# Mario Lodi: “Children's colours are festive, flamboyant, vivid colours”

Franca Zuccoli <sup>1,\*</sup>

<sup>1</sup> Department of Human Sciences for Education, University of Milano-Bicocca 1; franca.zuccoli@unimib.it

\* Corresponding author: franca.zuccoli@unimib.it

## Abstract

Mario Lodi was a teacher and key figure in the history of Italian education. His school journals and joint compositions with pupils are still studied by trainee teachers today: they illustrate Lodi's classroom practices, the value he attributed to children's voices, and his commitment to mindful but flexible educational design, documentation, and self-evaluation. The centenary of Lodi's birth on 17 February 2022 invites us to rediscover lesser-known aspects of his work, such as his interest in children's multiple languages, including expressive languages and colour. In 1989, Lodi founded *Casa delle Arti e del Gioco*; in 1992, at the Galleria Gottardo in Lugano, he staged *L'Arte del Bambino*, which later became an itinerant exhibition showcasing children's artistic productions, from their earliest scribbles through their first abstract works. In this paper, I explore Lodi's colour education and its relevance to contemporary didactics, based on his autobiographical writings and practical work with children.

**Keywords:** *Mario Lodi, Didactics, School, Colour, Education*

## INTRODUCTION

This aim of this paper is to point up the valuable contribution of a key figure in the field of education and didactics on the centenary of his birth: namely, Mario Lodi (1922-2014), a teacher and educationalist who successfully brought about the introduction of new teaching practices by proposing an alternative educational approach that was innovative and even revolutionary for its time. Importantly, Lodi viewed children's graphic, pictorial, and artistic productions as a key aspect of their educational trajectories which he saw as fostering their overall development. Within his novel perspective on children's multifaceted potential, he consistently stressed the importance of the artistic-expressive component, stating in an interview that the aim of schooling should not merely be to teach literacy and mathematical skills, but rather to fully develop each child's unique creative resources.

“School is not just about reading, writing, and arithmetic as once believed, but rather it is above all having an overall purpose. The key purpose in my view is forming the democratic child, which we must seek to accomplish slowly, not by means of empty words, but in our everyday practice, and in our respect for things and people.” (Salviati 2015: 25)

Before examining the specific path followed by Lodi in the field of art and colour education, it should be pointed out that in the same historical period numerous other women and men embraced the teaching profession with enthusiasm and passion, challenging the boundaries imposed by a traditional and transmissive model of school, and proposing an alternative approach to teaching. Due to space constraints, the following examples include only a few of these influential figures, whose work reflects a personal, cultural, and social drive to transform and renew the school system, as the best way of ensuring the positive advancement of Italian society: Bruno Ciari, Don Lorenzo Milani (Lodi corresponded with both on educational topics), Loris Malaguzzi, Alberto Manzi, ..., each with his own personal way of understanding change, and his own unique approach and praxis, together composing a diversity of style and a lack of uniformity of perspective that is highly enriching for all prospective teachers.

### **THE PATHWAY FOLLOWED BY MARIO LODI**

In order to understand Mario Lodi's ideas about and awareness of the artistic domain, it is helpful to briefly review his life story, and especially - drawing on his own words - key episodes that influenced his method of working with children. First of all, from a young age, he was recognized as having artistic talent, both in terms of his spontaneous productions and his ability to copy the works of others. His mother observed that as a small child seated in his high chair, he had displayed an unmistakably strong interest in scribbling and imitating his father's painting motions (the latter decorated fireguards both as a hobby and to supplement his modest income as a small farmer), as Lodi himself recalled: "My mother used to say that, from my high chair, I would watch what he [Lodi's father] was doing and try to imitate him, drawing marks and doodles on everything with lead and colour pencils: on the table, on sheets of paper, and even on my father's postcards when I was able to reach them by stretching out my arm. She used to say that I was happy [...]" (Lodi 1992: 3)

At school, on the other hand, the only artistic education offered to children involved copying: for example, when Lodi attempted to enrich his drawings with realistic details, he was immediately told to return to the "right" procedure of faithfully copying: "I would diligently copy those simple and schematic drawings and the teacher told me that I was really good at them. [...]. Once I was meant to copy a fish: the model was highly schematic and I, knowing that fish have scales, because I used to watch my mother scrape them off before cooking them, drew in the scales, which the model did not have. When the teacher saw them, she acted annoyed, and came down from her desk and scolded me: - Yes, that makes the fish look more real, but you must not add anything to the drawing to be copied!- she said. And she made me erase the scales. Drawing was copying." (Lodi 1992: 3)

Even when he was older, at the beginning of his education at a teacher training institute [Istituto Magistrale], while acknowledging his artistic abilities, his art teacher's main concern was to remind him that, as a teacher, he should only copy illustrations from textbooks, for teaching-explanatory purposes, getting the children to copy them in their turn, in a never-ending process of reproduction without any creative or imaginative component. Simple and simplified pictures were proposed to young teachers as a useful tool for teaching children who were not yet able to read and write. "He too (the drawing professor) therefore, like my primary school teacher, taught us that at school, drawings were to be copied from other drawings." (Lodi 1992: 4)

When he began his own career in the classroom, while clashing with transmissive methods that were alien to his own understanding of education, which led him to drop out of teaching for a few years, he too found himself teaching art via reproduction. But one day: "Attilio, a boy in fourth class in S. Giovanni in Croce, brought in paper cones containing coloured powders left behind by builders: he had found them in the yard of his farmstead, where the rooms of an apartment had just been painted. He opened out the twists of paper and all the children were struck by the strong and lively colours: Blue, yellow, green, black... - I saw what the builders did - Attilio said - they mixed them with lime and made pale colours. But can they be used like this? - Of course - I answered - they just need to be mixed with a little water and glue. - Shall I prepare them? - he asked, keen to spring into action. At that moment, something extraordinary was happening: For the first time in my classroom, a child wanted to prepare colours by himself and use them to paint something that was not copied from the blackboard." (Lodi 1992: 4)

### **A DIFFERENT WAY OF CONCEPTUALIZING ART EDUCATION**

The episodes just recounted offer a clear illustration of Lodi's line of inquiry as a teacher and of his desire to depart from the models that he had personally experienced in order to experiment with a new way of understanding art and colour education, allowing himself to be guided by the children themselves. Thus, teaching art was no longer restricted to isolated exercises in copying the drawings of other adults, but rather entailed an authentic teaching-learning path that elevated the dignity of the acting of painting/drawing: each individual child's drawing was viewed as an authentic production in a true language. Thus, drawing and painting became one of multiple possible languages, which the children were entitled to use, and which bore enormous communication potential. No more isolated and preordained exercises in drawing, without any opportunity for improvisation, but rather a personal journey, which became richer day after day. The drawings were not on set themes imposed by the teacher, but rather were freely produced by the children, individually or as a group. Subsequently, they were carefully observed and commented upon by the entire class. Drawing became a pretext for in-depth learning and discussion, in relation to the episode represented in the artwork, and the method chosen to represent it. Later, one drawing might be chosen as the most meaningful, as illustrative of situations that could become a theme for a group writing exercise, and with the classroom printing machine, several copies of this text could be made or it could be included in the school newspaper. Mario Lodi recounted his memories of this change: "And so began a fertile period of artistic production. The children depicted places and things from their village environment: the priest preaching, shopkeepers, election speeches in the square, old folk praying in the church, their parents at work, the old folks' home, the market, festivals, the woods, the courtyards, fishermen, hunters, boys bathing in the canals, their memories of seaside holidays... drawing and painting had become independent languages that each child used in a personal way to frame these subjects, preparing and combining their favourite colours. Everybody liked to paint and we organized shifts of three or four children who worked at the same time at the big table in our workshop during their free moments. And the "exhibition" of the paintings that had been produced was popular too: this was usually held at the end of each week by hanging the pictures on the classroom walls to be observed and discussed. [...] at those sessions, which I left to range freely while recording the commentary, the children sometimes made interesting observations about the use of colours for expressive purposes, and sometimes about technical details [...]" (Lodi 1992: 4-5)

### ***LODI'S ENCOUNTER WITH THE COOPERATIVE EDUCATION MOVEMENT***

Along this trajectory of continuous professional growth, we should note a particularly key juncture for Lodi, at which he regained his passion for teaching, after some years of struggling with the limitations of more traditional and transmissive approaches. This was the encounter, which occurred almost accidentally in 1955, with the fledgling cooperative education movement (Movimento di Cooperazione Educativa, MCE), founded in 1950 and initially named - in 1951 - Cooperative of the School Printing Press [Cooperativa della Tipografia Scolastica, CTS]. This was a group of innovative teachers, scattered all over Italy, and led by Giuseppe Tamagnini, who had come together to exchange ideas inspired by the example of Célestin Freinet and his wife Élise in France. Their first experimental projects involved classroom printing and correspondence between different schools. The Freinets' approach entailed the use of new teaching and methodological tools such as: discussion, conversation, free writing, printing, school newspapers, interschool correspondence, group writing (cfr, Lodi e i suoi ragazzi, 1972; 1979), the working library, the class as a cooperative, the collective construction of knowledge, the school treasury, scientific and social observation, engagement with the local area/community,



Mario Lodi: "Children's colours are festive, flamboyant, vivid colours"

expressive languages (art, music, theatre, poetry, ...) and manual activities (Bertoletti et al. 2016). The ongoing experimentation conducted by these young teachers underpinned a process of constant self-training and the continuous exchange of experience, thoughts, and dilemmas. Mario Lodi consulted this group of colleagues when he saw that his classroom discussions about the children's drawings sometimes got very heated and critical, and were putting some children off drawing altogether. "I searched for my mistake. I spoke about it with my friends in the cooperative education movement, getting them to listen to the recordings; and the President, Giuseppe Tamagnini himself, in a long letter in which he stressed the importance of pictorial language for children's development, warned me that to freely discuss, in front of the entire class, the work of individual children, means running the risk that excessively detailed and often unjust criticism from their companions will inhibit the most timid, who are unable to cope with this." (Lodi 1992: 5) Instead of giving up on discussing the children's artworks, the first solution that Lodi had thought of, Tamagnini proposed a different, more constructive style of discussion, a positive critical analysis, focused on the discoveries, and the specific features of the different works. This anecdote illustrates the work method of the teachers in this movement, who, by virtue of the principle of cooperation, were not afraid to engage in open discussion, helping one another to develop innovative teaching-learning paths.

### **THE FOCUS ON COLOUR IN LODI'S WRITINGS**

Following this overview of Mario Lodi's process of professional growth, the first point to be noted in this new section of the paper, is his consistent commitment to documenting his educational actions: recording the children's utterances, writing up a daily account of the teaching-learning activities conducted and the events that took place in the classroom, and thus producing a significant corpus of material, with both literary merit and instructive value for future teachers (Lodi 1963; 1970; 1973; 1974; 1983). The journal entries of this enlightened teacher can be analysed thematically. The theme of interest to us here is Lodi's emphasis on colour and how it developed in the course of his many years teaching different grades of elementary school. Three sub-foci may be identified: the environment, the evolution of children's graphic art production, and teaching-learning processes in art education.

On the second point, the following citation offers interesting insights: "Colours. Children's colours, up to the age of 7-8 years, are not realistic: we find green faces, blue arms, red skies, etc. painted with nonchalance, in a totally natural manner. Children's colours are festive, flamboyant, vivid colours, without grey hues and intermediate shades. Their choice of colour is determined by the pleasant emotions and beauty that they experience on observing or imagining or recreating the things of the world that they are in the process of discovering." (Lodi, 1992, p.30)

It should be specified that Lodi, being extremely interested in the evolution of children's drawing, right from his early years as a teacher, recognizing that all children proceeded through similar stages in their drawing ability, albeit with unique individual variations, set out to collect children's drawing productions, beginning with their earliest scribbles. To this end, he had asked his pupils' parents to bring in earlier drawings, but few had kept what he viewed as similar to archaeological finds from previous eras (Lodi 1992: 7). Therefore, in order to gain access to a larger body of materials, Lodi asked infant school teachers if he could see the drawings produced by their pupils. This allowed him to study the graphic language of younger children, which had not been addressed at the primary teacher training institute he attended. He also studied the work of numerous scholars including: Rudolf Arnheim, Franz Cižek, Victor Lowenfeld, Rhoda Kellogg, Rudolf Koch, Jean Piaget, Herbert Read, Corrado Ricci, William Stern, and Wilhelm Viola, among others. This research, together with the children's drawings and paintings he collected between 1948 and 1988, gave rise to the *Pinacoteca*

Mario Lodi: "Children's colours are festive, flamboyant, vivid colours"

*dell'arte infantile [Picture Gallery of Children's Art]*, in the Casa delle Arti e del Gioco, in Drizzona (Cremona), as well as a dedicated exhibition entitled *L'Arte del Bambino [Children's Art]* inaugurated at the Galleria Gottardo in Lugano in 1992, which consisted of 52 works displayed in chronological order, and which still today offers insight into the evolution and richness of children's pathway to the discovery of graphic-pictorial language.

## **CONCLUSIONS**

Our observation of the work of Mario Lodi suggests that an extremely important aspect of his innovative educational approach was a focus on children's production of drawings and paintings. This represented a radical departure from the method that children had long been accustomed to, which merely consisted of copying set models without any scope for participation. Within Lodi's approach, the material aspects of producing artwork was also key. Colour, for example, was no longer used readymade, but rather was prepared by the children themselves. This emphasis on children's graphic and pictorial production became such a distinctive part of Mario Lodi's path of inquiry that he began to collect children's drawings, from their earliest scribbles, and to analyse them. Colour also became a defining characteristic of his approach, with functions that he believed to vary according to the child's age.

## **REFERENCES**

- Bertoletti, B., C. Lodi, E. Platè, and F. Tonucci. 2016 (Eds.) *La scuola di Mario Lodi "Abbiamo lasciato un segno a chi vuole continuare..."*. Drizzona: Casa delle Arti e del Gioco- Mario Lodi.
- Lodi, M. 1963. *C'è speranza se questo accade al Vho*. Milano. Avanti!
- Lodi, M. 1970. *Il paese sbagliato*. Torino: Einaudi.
- Lodi, M. 1973. *Cominciare dal bambino. Scritti didattici, pedagogici e teorici*. Torino: Einaudi.
- Lodi, M. 1974. *Insieme. Giornale di una quinta elementare*. Torino: Einaudi.
- Lodi, M. 1982. *Guida al mestiere di maestro*. Roma: Editori Riuniti.
- Lodi, M. 1983. *La scuola e i diritti del bambino*. Torino: Einaudi.
- Lodi, M. 1992. *L'arte del bambino*. Drizzona: Casa delle Arti e del Gioco- Mario Lodi.
- Lodi, M. 2014. *Come giocavo*. Drizzona: Casa delle Arti e del Gioco.
- Lodi, M. e i suoi ragazzi. 1972. *Cipì*. Torino: Einaudi.
- Lodi, M. e i suoi ragazzi. 1979. *Bandiera*. Bari: Laterza.
- Salviati, C. I. 2015. *Mario Lodi maestro*. Firenze: Giunti.



# Colour proposals consistency in the CMF for car design education

Flora Gaetani <sup>1,\*</sup>, Fausto Brevi <sup>2</sup> and Donatella Balloni <sup>3</sup>

<sup>1</sup> Politecnico di Milano; flora.gaetani@polimi.it

<sup>2</sup> Politecnico di Milano; fausto.brevi@polimi.it

<sup>3</sup> Politecnico di Milano; donatella.balloni@polimi.it

\* Corresponding author: flora.gaetani@polimi.it

## Abstract

The aim of this work is to investigate the learning processes of the CMF project, through the analysis of the methods of colour representation in thesis of students of courses in Transportation Design. In car design, the eventual richness in students' representational abilities is crucial for them to best express their ideas. In the CMF design field, in which the choice and combination of chromatic variables play a fundamental role, the representation richness is even more important because of the need to express ethereal concepts such as emotions. A first result described in this work identifies a recurring difficulty by students in the graphic restitution of the chromatic concepts, stated in the moodboard of their own projects, with style and quality consistent with the other parts of the project. At last, the areas on which the teachers will have to take action to reduce these difficulties are highlighted.

**Keywords:** *CMF design, representation, color proposal, car design, design education*

## INTRODUCTION

In car design there is an important, but often underestimated, step able to change the perceiving of a car literally. It's named Colour & Trim and is tasked with devising surfaces, textures, and colours, both interior and exterior, that form a physically subtle but significant proportion of the vehicle's identity. Practically, it means to research, design, and develop all interior and exterior colours and materials for all the visible surfaces finishing. So, the trim lines for the future automobile are chosen from hundreds of fabric, leather, paint and plastic samples and colours. And, sometimes, they are created entirely new from scratch. This job is mainly carried out by CMF designers.

The Colour & Trim car designers work in close collaboration with exterior and even more with interior designers, as well as with marketing and product team, but also with ergonomists and with technical engineers who work on the concept and industrialisation of the new vehicles. The main goal is to collect technical input and non-technical feelings from all of them and give a strong brand and product identity to the new project using colours, materials, and finishing because people's relationship with them emotionally connects them.

Because of all these interactions, CMF designers can act as Colour & Trim car designers should be very good in visual representation and in its techniques and should know how to materialise and communicate ideas. S/He should have a strong cultural, artistic, and technical background, as well as a passion and a good understanding of the trends and lifestyle evolutions.

This work aims to investigate both the learning and the rendering processes of the CMF project by analysing the methods of colour representation in the thesis of students of specialisation courses in Transportation design. For this purpose, the activities developed in the last years within the specialisation master course in Transportation & Automobile Design of Politecnico di Milano have been considered.

Over the years, the educational path of this course has evolved significantly to improve the effectiveness of a curriculum aimed at professionalising students. The expected output profile is a junior professional able to have a broad vision of the many activities that contribute to the design process of a complex object such as the car and have representative skills consistent with this profile.

To achieve these objectives, the Car Design Studio within the master's program has been structured to simulate what happens inside an Automotive Design Centre: there are four teachers, three of them

involved in teaching/reviewing a specific aspect of the car design process (exterior, interior, colour & trim); all of them are coordinated by the fourth teacher who corresponds to the design director.

Colour & Trim design is, therefore, one of the subjects covered within the Car Design Studio and is one of the design aspects that students develop within their final thesis project.

## **METHODOLOGY**

The CMF design includes multiple processes based on very different practical activities, such as market research, colour experiments, tactile checks, and even relationships with suppliers. Mainly for these reasons, the teaching of CMF design is a well-known problem in the product design degree curricula, often managed on a theoretical basis because of the fragmentation of the several different topics to be covered (Zhang, 2020).

To prevent this problem, in the specialising master course in Transportation & Automobile Design, a double path for teaching CMF design has been setup: the first one happens outside from the Car Design Studio, as an introductory course mainly based on a theoretical approach; the second one happens inside the Car Design Studio, and it's only based on design reviews activities, in accordance with the Shön, Oxman and Cunliffe approach to cognitive processes. They redefine the educational tasks on designer training, suggesting a shift from an orientation linked to a product achievement to a cognitive-constructive system. For this reason, design reviews are the founding moment of all the teaching activities of the Car Design Studio; during revisions, the act of "reflection in action" allows to spend time exploring why students acted in a certain way and how to improve their quality both in design and in representation. Indeed, the only way to describe the cognitive processes of design is to identify a set of representational techniques that can model visual and conceptual knowledge as well as its dialectical interaction with the "reflection in action" process. The cognitive characteristics of design thinking and its acquisition can be found in the content of the metacognitive and recursive approach to design education that involves "learning to learn". Moreover, moving from a cognitive to a practical approach, it can be observed that the specificity of the educational project is strongly linked to the relationship between visual and conceptual contents (Shön 1983; Oxman 1999, 2004; Cunliffe 1999). In the CMF design field, in which the choice and combination of chromatic variables play a fundamental role, the representation quality is essential because of the need to express ethereal concepts such as the emotions linked to the user's experience.

### **From Theory to Practice**

Currently, in the didactical path that is independent by the Car Design Studio, students learn the basics of colour theory and its history, the most important typologies of materials used in the making of a car, and some suggestions on eco-friendly materials, as much as on next-generation and experimental materials. At the same time, students are involved in a more practical activity focusing on the making of reports on the most important design exhibitions to highlight the new trends in the sector; that means either the most famous Motor Shows, like Geneva, Tokyo, Paris, but also exhibitions not directly focused on vehicles, like CES (Consumer Electronics Show in Los Angeles), Salone del Mobile. Milano, or Lineapelle (in Milano, New York, and London). This assignment is completed with a survey in materials libraries and, of course, in the web platforms specialised in colour and lifestyle trends. The last part of the preparatory activities is a simulation of a CMF project for a piece of a car (for example, the door panel). The project is described using a moodboard with references to at least three different materials and to a colour palette. The colour definition is always requested in one of the coded colour palettes (mainly RAL, NCS, Pantone) to keep more consistent information. In the end, students are ready to implement the same process in their thesis projects, developed in the Car Design Studio, with reviews by the same teacher.



Figure 1: Moodboard “Cozy Digital” by Marco Quamori Tanzi. On the left the moodboard to describe materials, finishes and sensations; on the right the CMF proposal for the interior of a vehicle.

During the CMF project developed in the Car Design Studio, the emotional parts of the general project are initially expressed through the definition of moodboard based on the project brief, but also on the brand, on the needs of the target user and his/her experience. The colour variables are simplified as a triad of colours (the main colour: 60%; the secondary one: 30%; and the accent: 10%) to allow students to manage a complexity that, by its nature, must also consider the geometry of the project as well as materials, finishes, textures, and patterns. The final materials selection happens gradually with the final definition of the interior shapes, going deeper into the project details via graphical proposals. For each project, two alternative CMF projects are developed, the main one and a secondary one: the main one will be used in the presentation images and models.

## RESULTS

In a ten-year-long list of exhibitions made to highlight the final thesis projects developed by the Transportation & Automobile Design course students, the exhibited materials are changed, evolving towards a more complete and professional way to describe a car design work.

Currently, the most comprehensive exhibition was made in the summer of 2019. The subsequent ones have been greatly influenced by the covid-19 pandemic scenario and by the related constraints. For these reasons, the 2019 one will be described as the actual state of the art reference to analyse the strength and weakness points in showing the CMF part of the projects. In the 2019 exhibition, each project has been shown using a layout characterised by:

- a 2 x 1.4 m. board containing a graphical description of the global project
- an aesthetic model of the exterior shape in 1:4 scale created with a CNC machine and painted (Brevi and Gaetani 2020)
- a 1:10 scale FDM 3D printed model of the interior, unpainted
- a 1:18 scale FDM 3D printed model expressing a secondary feature of the project, unpainted
- two panels with the two alternative CMF proposals

About the exterior part of the vehicles, the proposed colours were represented by a few ad hoc produced samples (3 or 4 depending on the project) intending to highlight the behaviour of light on concave, convex surfaces and on small and large radii of curvature. The prominent colours combination

proposal has been used to paint the 1:4 scale model. The materials chosen for the interiors are represented by some samples in the CMF panel and in the renderings of the mainboard. The model of the vehicle's interior, built in 1:10 scale, does not show any material characterisation, describing only the layout and the main shapes.



Figure 2: CMF project panel for Audi Crisalis by F. Batavia, J.P. Bruni, E. Trabattoni, P.E. Tranchellini. In the upper part the main colour (blue), the secondary one (grey) and the accent (yellow).

Of course, the final stages of the last two years editions (which ended in July 2020 and 2021, respectively) were inevitably influenced by the covid-19 pandemic. The projects of the 2020 edition were highlighted exclusively online (a webinar, on the master's website, on a YouTube channel): this meant that the digital image became the absolute protagonist compared to the physical component of the models and samples. The development of virtual models and, from them, the creation of 3D digital render images capable of expressing the material component at its best was therefore fundamental (see Figure 2).

In the 2019-20 edition, the students completed the course online after the outbreak of the pandemic scenario, while in the 2020-21 edition, students had to attend the most significant part of the course from home but during the final stages. This matter allowed a hybrid approach to the traditional final exhibition, being back to a physical one in a lighter mode than usual but in which the projects were exhibited again. The presentation models were created in Additive Manufacturing (FDM and SLA) on a 1:10 scale, starting from the digital NURBS models done by the students, and painted. Of course, the exhibition was smaller in size than in the past, but large enough to keep the presentation models, a table with a graphical description of the project, and a secondary 1:20 scale model, unpainted, to tell the alternative function that was in every project (the projects brief requested it).



Figure 3: BMW Hyla by S. Armento, F. Errera, J. Gussoni, A. Lanzalotta, P. Vitale. An image created with a digital rendering from a 3D digital model to describe three CMF proposals.

Because of the still alive difficulties in getting in touch with textile suppliers for experiencing a real tactile experience, the CMF project was still illustrated using prints and video. So, once again, the function of the digital model and, even more, the quality of its rendering was fundamental, especially for the rendering of the materials proposed for the projects.

## **DISCUSSION**

In the last two years, the need to show the CMF part of the projects only using images created by students themselves highlighted the difficulties in keeping consistent the process from selecting colours, materials and finishes to their final representation in printed images and/or in a video. That was partially hidden in the previous years by the physical presence of samples and painted models that were able to go over misleading results in images.

In the 2021 exhibition, the complete lack of samples describing colours, materials and finishes for the interior of the vehicles highlighted the differences in being effective in representing the CMF for the exteriors in relation to the interiors. Indeed, the presentation model (it doesn't matter if in the 1:4 or 1:10 scale) can capture the eyes and give the perception that the colours and finishes of the exteriors are those, and only those, visible on the model itself. That's not entirely true because the result is always a compromise between the student's original CMF project and the colour chips available in the supplier colour collection. And this is one of the reasons why there is a lack of consistency in the colour representation: students work on rendering using as reference their original choices and not the colours chosen as the closest possible choices from the supplier palette. It's mainly a matter of timing because students must start realising rendering images already before the models are painted. Still, it's not possible to imagine delaying further the start of images production.

## **CONCLUSION**

Of course, it's possible to work for better consistency of colour management between physical objects and their digital representation (Gaiani et al. 2011). Still, it could probably be better to teach students that different representation systems could tell other things, highlighting different information about the CMF project.



Figure 4: GoPro Chios by E. Campinotti, R. Gallo, R. Nagaraj, S. Toninato). On the left the physical model in 1:10 scale, on the right a rendered image: both representations are from a 3D digital model done by students.

Besides that, we believe there are two main areas to improve the general quality of the process currently used in the course. The first significant improvement in communicating the CMF project could be to close the gap in perception of CMF for interior and exteriors. To reach this goal could be helpful to have both a panel with CMF samples for interior and exterior, as it was in the 2019 exhibition, and a meaningful part of the interior model as a presentation model with its relative CMF choices applied. This is much more challenging than the presentation model for the exterior because it's not a



matter of paints and finishes only. It is also involved materials to cover the hard model. Still, it could probably be a significant jump in the perceived quality of the CMF representation.

A second improvement probably could be reached with a closer relationship with external suppliers, but this is mainly a management topic rather than a technical issue.

### **ACKNOWLEDGEMENTS**

The paper is the result of common research and findings undertaken by the authors. Nevertheless, Introduction, Methodology (partially) and Conclusions were edited by Fausto Brevi; Results and Discussion were edited by Flora Gaetani; From Theory to Practice was edited by Donatella Balloni.

### **REFERENCES**

- Brevi, F., and F. Gaetani. 2020. The Process of Surveying Maquettes in Car Design. *Diségno* 7: 141-150.
- Cunliffe, L. 1999. Learning how to learn, Art education and the background. *Journal of Art and Design Education* 18: 115-121.
- Gaiani, M., A. Deserti, F. Brevi, and S. Ferioli. 2011. Tools and Methods to Assist the Product Customisation in the Field of Furniture Design. *Design Principles and Practices* 5: 221-238.
- Oxman, R. 1999. Educating the designerly thinker. *Design Studies* 20: 105–122.
- Oxman, R. 2004. Think-maps: teaching design thinking in design education. *Design Studies* 25: 63–91
- Shön, D.A. 1983. *The reflective practitioner*. New York: Basic Book.

# We don't know Jack about Hue: The Colour Knowledge Survey

Craig Kirkwood <sup>1,\*</sup>

<sup>1</sup> Cardiff Metropolitan University; craig.kirkwood@gmail.com

\* Corresponding author: craig.kirkwood@gmail.com

## Abstract

What does the average person know about colour? The Colour Knowledge Survey concludes that few people can confidently identify basic principles as to the nature and behaviour of colour. The survey collected spans a period of some 12 months, across a broad range of participants, from professional designers through to those who profess little or no understanding of the subject. The conclusion is that colour literacy is generally poor even among those whose profession or education requires a high level of competence.

**Keywords:** *colour education, colour order systems, colour knowledge*

## INTRODUCTION

The Colour Knowledge Survey is an attempt to measure the level of understanding about the nature, behaviour and science of colour among both design professionals and the general community. It forms a critical phase of *Lingua Colour*, my doctoral research project at Cardiff Metropolitan University (Cardiff Met). *Lingua Colour* aims to develop a new, open, colour order system for the graphic arts and the wider colour education sector, particularly at the tertiary (college and university) and industrial level.

This paper presents the methodology and findings of the survey as well as a short description of the proposed *Lingua Colour* project as it currently stands.

### Understanding Colour

Before beginning to create a survey about knowledge or understanding, we should first determine what there is to know and why it matters. Colour is a research field that spans so many disciplines it is hard to know where to begin. Perhaps with physics – how we understand the mechanics of light and electromagnetic radiation? Or with optics – the physiological or mechanical response to light stimulus and the subsequent neurological processing thereof? Or maybe psychology? Colour is, after all, widely considered a psychophysical response to a given stimulus, by virtue of our trichromatic retinal receptors and the subsequent opponency of our response.

All of these – perhaps some more than others – are of interest to researchers of colour but what about those who work with colour as designers, artists, decorators or students? Or indeed anyone choosing colours for an everyday task such as painting a room, starting an enterprise, or designing a school project? Those needs are typically less academic and certainly more practical: what colours 'go well together'? What colours suggest confidence or reliability? And more pertinently, how can we communicate desired colours to others when manufacturing, printing or reproducing colours. And how can I ensure consistent reproduction of colours across different media?

### Colour Management

There is no obvious answer to the first two questions, although one could argue there should be, but for the others – communicating colour and consistent reproduction across media – we have some tools at our disposal, well-known in the graphic design profession. In the English-speaking world at least, most professional designers would be familiar with the ubiquitous Pantone Matching System as a

means of choosing and communicating colour. Experience I have gained in teaching graphic design to industry over the past two decades suggests the Pantone system plays an important, albeit diminishing, role in colour choice and communication but just how well this system is known is one of the questions in the Colour Knowledge Survey.

The other question – how to ensure consistent reproduction of colours – falls under the category of 'colour management' which has been an elusive but critical goal of the digital supply chain as developed by Adobe, Apple, Quark and Corel, among others, and indeed by computer hardware, printing, and display technology vendors such as HP, LG, Epson, Sony and Canon. As both printing and display technology have evolved so rapidly over the past thirty years this problem has diminished to near insignificance for many users. Consider that it was barely twenty years ago that flat screen display technology, with its superior colour reproduction and reduced power consumption, entered the market, but today you'd be hard pressed to find a cathode ray tube (CRT) screen in any office in the developed world. And only a decade before that, virtually all screens were monochrome with no colour at all!<sup>1</sup>

Still, an understanding of how colours map between the additive RGB space of computer monitors and device screens to that of the subtractive, CMYK space of printers remains of importance to designers of all levels. As is well known in colour research, colour 'behaves' very differently when it is the result of light transmitted from an electrical source than it does when being observed on the surface of an illuminated object – something I was keen to explore in the Survey.

### **Colour knowledge vs musical knowledge**

In considering the importance of colour 'knowledge', it is worth reflecting on the obvious parallel of music – a metaphor for colour that so many influential thinkers from Isaac Newton to Wassily Kandinsky have considered in various ways (Kuehni and Schwarz 2008). Newton was sufficiently invested in the idea that spectral colours should echo the intervals of the musical scale that he added at least one (possibly two) colours to earlier, medieval depictions of the rainbow to match the seven intervals (8 notes) of the octave (Hutchison 1997). Indeed the famous colour wheel from his 1704 book, *Opticks*, presents the colours around the circumference interspersed with the notes of the musical Dorian mode (Newton 1704).

In the present day, music has an elaborate and mature system of notation, education and professional practice that is all but absent in the use of colour. And yet, we typically consider our vision to be more a more sophisticated sensory system to that of the auditory – certainly when measured by the biological commitment evolution has invested in its physiology<sup>2</sup>

It is easy to dismiss as naïve a direct comparison between the musical scale and, say, our range of spectral perception (despite the common etymology of terms such as 'chroma', 'tone' and 'harmony') but such a comparison reveals – or perhaps belies – something of our cultural attitude to the senses, as much as it does about our biology. Why is it that we have such a mature system of musical theory and corresponding practice, and yet almost no equivalent in the use of colour? Which begs the enticing question: is it time to invent one?

---

<sup>1</sup> Various flatscreen technologies were explored as far back as the 1960s but it wasn't until the 1990s that liquid crystal displays (LCDs) began appearing in laptop computers. And not until 2003 did LCD screens first begin to outsell cathode ray tube (CRT) monitors on desktop computers. The Apple II and the Atari 800 computers were the first to offer coloured output in the late 1970s (to colour TV screens), followed by the IBM PC in 1981 ('Computer Monitor' 2021).

<sup>2</sup> Estimates are typically around 130 million rods and 7 million cones in the human eye, as opposed to some 30000 fibres in the cochlear nerve of the ear (Hawkins 2020). A poor measure of sensory significance perhaps but certainly an indication of evolutionary investment. We could also compare the auditory range of humans (some 20hz to 20Khz) and the unique number of tones we can discern within that spectrum (around 1400 unique pitches) to that of our visual system (as many as 16 million 'colours' in total although far fewer discernible hues).

## The Lingua Colour Project

In the English-speaking world, and in many countries beyond, colour dialogue in the graphic arts and design professions continues to be dominated by the Pantone Matching System<sup>3</sup>. While this privately-owned, proprietary system was effective in the years prior to digital 'desktop' publishing it is no longer ideal for several key reasons.

Firstly, it was designed at a time when pre-mixed 'spot' colours were a popular form of printing, whereas today, most printing is done on either four-colour (CMYK), offset lithography systems or on short-run, 'digital' printers based on inkjet, laser or dye-sublimation technology.

Secondly, Pantone is a privately owned system, now in the hands of X-Rite, Inc. which is, in-turn, a wholly-owned subsidiary of the US conglomerate, Danaher Corporation<sup>4</sup> who also own the Munsell System<sup>5</sup>. That ownership is at odds with comparable systems such as musical notation which is, of course, very much in the public domain.

Perhaps even more significantly, we're now in a world where the vast majority of information is not printed at all but is delivered to devices held in our hands, on our laps, or on our dashboards.

Lingua Colour is a proposed colour system which is better suited to today's world of screens, devices and mixed printing systems whose workings are largely opaque to most users. A system which is open, educational, affordable and flexible for use across any number of creative domains.

In this paper, I do not discuss this project in detail as the focus here is the Colour Knowledge Survey which is, in and of itself, I hope, a valuable contribution to the wider consideration of colour education and understanding in general.

## METHODOLOGY

### Target Groups

When the survey was first conceived, relatively early in my doctoral research,<sup>6</sup> it was with professional graphic designers in mind. The Lingua Colour project, which led to the development of the survey is, at least in part, a response to the limitations of the Pantone System which is the best-known colour system for graphic designers in the English-Speaking world and many beyond<sup>7</sup>. Note that the apparent limitations of the Pantone System and the proposed Lingua Colour Project will be discussed in further detail in a subsequent paper.

As my research evolved it became clear that the graphic design profession was fragmenting into several specialist areas: user interface (UI) design, user experience (UX) design, instructional design, and content design are perhaps the best examples, although certainly not the only ones<sup>8</sup>. All of these

---

<sup>3</sup> From nearly three decades teaching design software on three continents I can confidently say, that Pantone is the only show in town. Of course there are other systems in other parts of the world but in the English-speaking world Pantone is king.

<sup>4</sup> According to X-Rite's website, they merged with their largest competitor, GretagMacbeth, and a year later acquired Pantone: 'Acquisitions combine X-Rite's strength in portables, Gretag's expertise in benchtop and imaging, Macbeth's 100+ years in lighting, the Munsell legacy of color science, and Pantone's leadership in color inspiration and design' (X-Rite Color Management, Measurement, Solutions, and Software, n.d.)

<sup>5</sup> Strictly speaking, not the Munsell System but the commercial products of the Munsell Company as established by Albert Munsell just a year before his death in 1918. The company was sold by his son, Alexander Munsell in 1942 with the proceeds used to set up the Munsell Color Foundation. In 1983, this became the Munsell Color Science Laboratory at Rochester Institute of Technology, while the commercial assets (and presumably any licensing considerations) became the property of GretagMacbeth and later X-Rite.

<sup>6</sup> I officially began my PhD in January 2019 although the seeds of this can be traced to my long history of teaching design, photography and media production in an industrial context.

<sup>7</sup> I say this with the caveat that I'm really referring to graphic designers, marketers, product managers and 'creatives' whose work is based on computers and digital production as opposed to those who work with conventional 'pre-digital' media or indeed to 'fine artists' and those schooled in the traditions thereof. It is this larger sector that I have most experience with and for whom the Lingua Colour Project is aimed. This group, as the survey will attest, has little knowledge of the Munsell System or indeed the work of the CIE.

<sup>8</sup> A quick search through the listings of any of the popular 'job market' websites here in the UK (TotalJobs, Indeed or Reed for example) using the keyword 'design' will attest to this fragmentation.

growth areas are focussed on digital delivery as the screen continues to dominate our professional and personal lives. Print design, on the other hand, has declined in relative significance, remaining important only to those with a professional interest in supplying print services or within manufacturing facilities. Of course, books, magazines and newspapers are still printed every day but they no longer dominate the media landscape in the way they used to and furthermore their manufacture is so highly automated as to reduce human input to a bare minimum<sup>9</sup>.

Furthermore, my work in industry over the past 25 years or more has revealed a noticeable trend: graphic design is increasingly part of the workload of anyone who works in the broader fields of communications, marketing or sales, those who are self-employed, or indeed anyone attempting to reach markets, audiences, clients or colleagues through some form visual media. That's a large group indeed.

With this in mind, I decided to broaden the parameters of the research such that anyone could participate, and thus was able to increase the breadth and scope of the data set while providing additional questions for those with a professional interest in any related field.

### **Survey Design**

The survey was designed to determine how much the average person understands about the nature and behaviour of colour. More specifically, I wanted to determine what factors, if any, influence that understanding. Is there a significant difference between those who work professionally in a design-related job and those who don't?<sup>10</sup> Or between those who have received some level of formal education in design or the visual arts and those who haven't? And to what degree both professionals and non-professionals are familiar with either the Pantone or the Munsell colour systems.

The broader question as to whether such knowledge is necessary to function effectively as a designer, either professionally or otherwise, is not really addressed here as it is surely debatable in the same way one could ask of musicians: is it necessary to read music to make music? I find this question interesting and perhaps would argue that while you do not need to read music to 'make music' you most certainly do if you wish to work as a session musician (in the case of popular music) or join an orchestra (in the case of classical music), or indeed participate in any professional context where collaboration is involved. It is, after all, the common language which unites musicians.

And what is the common language that unites designers and users of colour? That's where *Lingua Colour* comes in...

### **RESULTS**

In all, approximately 300 delegates participated in the survey. There was a broad cross section of users, roughly half of which identified in some way as 'creative'.

The survey data were imported into a custom-built Filemaker Pro database which allowed for some normalization of the values as well as a 'live' graphical presentation which updated dynamically as new results were imported.

---

<sup>9</sup> The decline in print media is surely self-evident but by way of example, the Pew Research Centre reports that printed newspaper circulation is down to around 25 million in the US (as of 2020), compared with over 60 million in the heyday of the 1980s and 90s (NW et al., n.d.).

<sup>10</sup> By 'professional' I don't necessarily mean in the technical sense of one's 'main profession or vocation', but rather those who either identify as a designer or similar, or who undertake work, hobbies or projects which could be classified as visual design or graphic design in a reasonably broad sense.

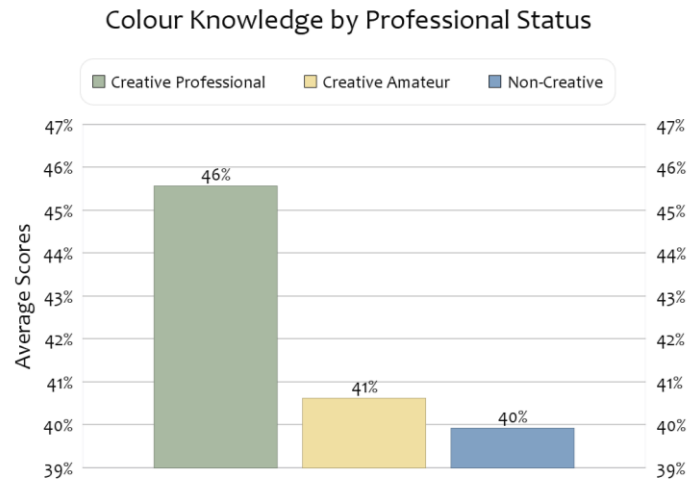

Figure 1: Colour Knowledge by Professional Status.

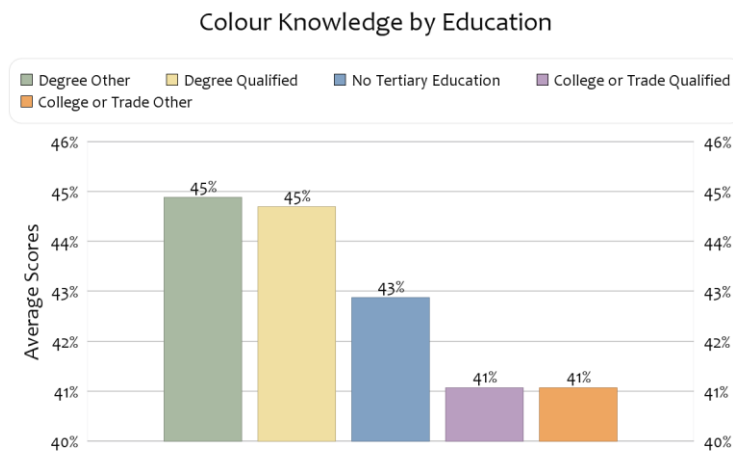

Figure 2: Colour Knowledge by Education.

**CONCLUSIONS**

The first thing that strikes is the very small difference between the results on the basis of any of the properties indicated. While at a glance the graphs show large differences for each data column, the variance is actually very small indeed. Just six percentage points separate the smallest and largest values in the case of professional status, and only four percent in the case of education.

We can certainly conclude that one's occupation has at least some bearing on understanding of colour fundamentals but to a barely statistically-significant degree. And the same can be said for education. Indeed those who profess to having no education beyond high-school score very similarly to those who have undertaken tertiary study specifically related to creative practice of some kind, with a differential of just two percent.

It is hard to believe such a narrow margin exists for any other professional sector. Again, music and musicianship come to mind as a logical comparison. It is difficult to imagine that those who have studied music would have little more knowledge of music theory than those who haven't. Likewise a casual musician playing the guitar or ukulele would surely be no match for a classical musician performing with an orchestra or even a popular musician playing in a band.

With equal surprise we observe the average scores across the board were below the level of a standard pass grade of 50 percent!

### *Limitations*

Readers may well conclude that the survey design is not in any way accredited or aligned with educational or professional frameworks and thus is, to a certain degree, somewhat arbitrary in scope and detail.

It is hard to argue with this but perhaps that is part of the point of the exercise: there is no obvious accreditation nor professional framework for the study and use of colour. At least not yet.

There are other limitations to note here. One is that the survey is biased towards those working within the digital realm rather than those using paint or fabric or other materials. As we note above, that is certainly true and reflects the initial aim of the research which is to demonstrate the need for a new, open colour system for use in the graphic arts and the wider education sector.

Secondly, the sample size of 300 participants is too small to represent the general population but the results shown above were evident – and largely unchanged – from a sample of just 30 participants.

### **FINAL CONCLUSIONS**

If we are to place any faith in the design and methodology of the survey we can say with some confidence that very few people understand the nature and behavior of colour irrespective of their profession or education.

It is more difficult to argue that this is problematic and limits one's ability to perform a job or undertake creative activities, but at the very least it reveals there is much work to be done in terms of colour education at quite a fundamental level.

### **Links**

The Colour Knowledge Survey can be taken here: <https://tinyurl.com/colourknowledge>

The worked solutions to the survey can be viewed here: <https://linguacolour.com/survey-solutions/>

### **REFERENCES**

Computer monitor. 2021. In *Wikipedia*.

[https://en.wikipedia.org/w/index.php?title=Computer\\_monitor&oldid=1036665585](https://en.wikipedia.org/w/index.php?title=Computer_monitor&oldid=1036665585)

Hawkins, J. 2020, October 29. *Human Ear Anatomy*. Encyclopedia Britannica.

<https://www.britannica.com/science/ear>

Hutchison, N. 1997. *Colour Music—Introduction*. Colour Music.

<http://www.colourmusic.info/intro.htm>

Newton, S. I. 1704. *Opticks: Or, a treatise of the reflexions, refractions, inflexions and colours of light. Also two treatises of the species and magnitude of curvilinear figures* (4th ed. Cor.). Printed for W. Innys.

NW, 1615 L. St, Washington, S. 800, & inquiries, D. 20036 U.-419-4300 | main202-419-4349 | fax202-419-4372 | media. (n.d.). Trends and Facts on Newspapers | State of the News Media. *Pew Research Center's Journalism Project*. Retrieved 8 August 2021, from <https://www.journalism.org/fact-sheet/newspapers/>

*X-Rite Color Management, Measurement, Solutions, and Software*. (n.d.). X-Rite. Retrieved 3 August 2021, from <https://www.xrite.com>

1 COLOR AND MEASUREMENT INSTRUMENTATION	2 COLOR AND DIGITAL	3 COLOR AND LIGHTING	4 COLOR AND PHYSIOLOGY
5 COLOR AND PSYCHOLOGY	6 COLOR AND PRODUCTION	7 COLOR AND RESTORATION	8 COLOR AND BUILT ENVIRONMENT
9 COLOR AND DESIGN	10 COLOR AND CULTURE	11 COLOR AND EDUCATION	12 COLOR AND COMMUNICATION MARKETING

## 12 COLOR AND COMMUNICATION / MARKETING

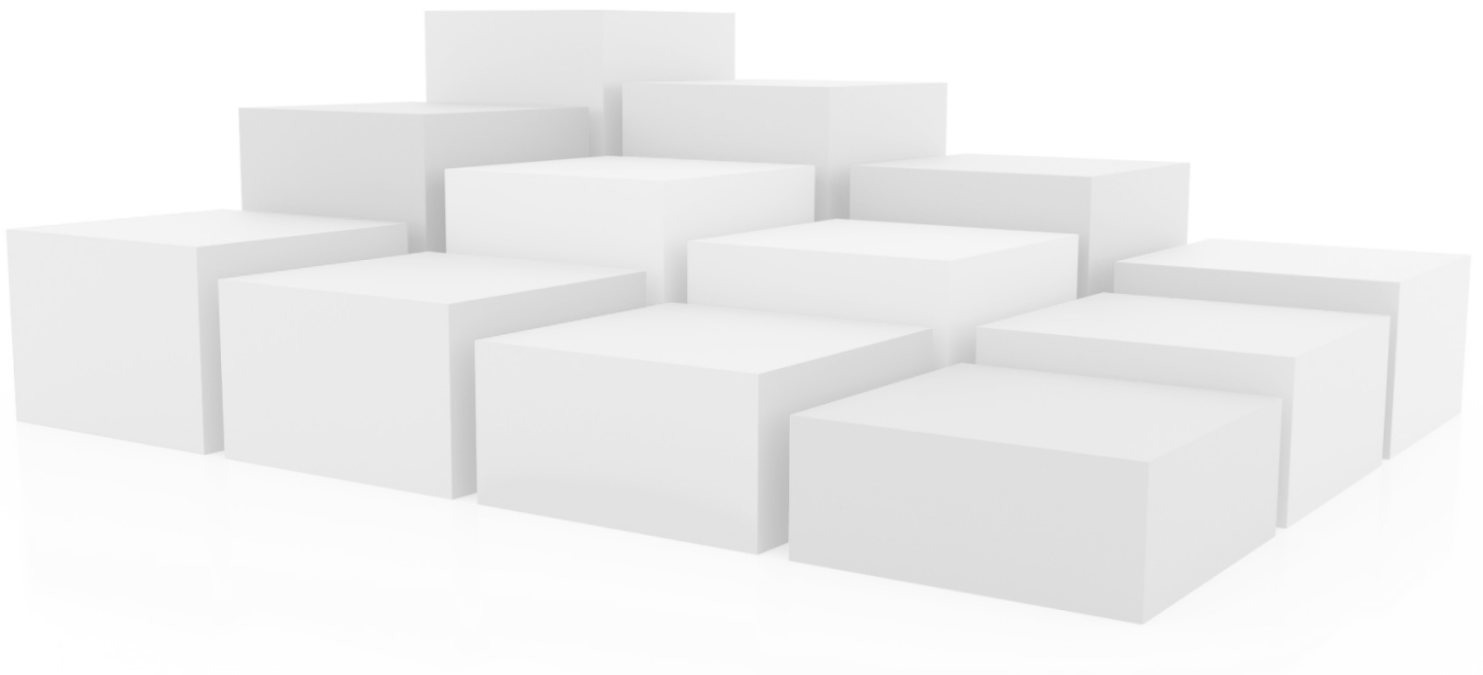





# Data visualization: The power and persuasive capacity of color

Zena O'Connor<sup>1,\*</sup>

<sup>1</sup> Design Research Associates & Colour Collective Sydney; zena@zenaoconnor.com.au

\* Corresponding author: zena@zenaoconnor.com.au

## Abstract

Data visualizations are common across academic, business, educational, and political sectors. They are generally purpose-driven and designed, and while the overall goal is to convey information, this intention is underpinned by the aims and agenda of the author.

Design elements and especially color and contrast play integral roles in data visualization and are used to highlight information. In this context, the mechanics of visual perception in tandem with cognitive processing and critical analysis can influence how an audience perceives, understands, and responds to the information contained within data visualizations.

This paper examines the power and persuasive capacity of color in data visualization and explores the ways it may impact how information can be skewed, depending on an author's aims and agenda. Color and contrast have the capacity to highlight information or misrepresent and mislead, and flow-on effects relate to the ways in which the audience evaluates, responds to, and acts upon information presented in data visualizations.

**Keywords:** *Data visualization, visual communication, color application, graphic design, color design*

## INTRODUCTION

*Lies, damn lies and statistics*, a phrase popularized by Mark Twain, can be applied to data visualization due to the way information can be presented to clarify or misrepresent, inform or mislead, enhance or obscure meaning. This paper explores the way in which color in data visualization can play a critical role not only in communicating information effectively but to also misinform and mislead.

Communication of information is generally underpinned by the author's aims and agenda. Hence, purpose-designed visual communications often reflect Lasswell's communication model; that is, a focus on: *Who, Says What, In Which Channel, To Whom, With What Effect?* (Lasswell 1948). This model echoes Aristotle's notion of the elements of circumstance (*Septem Circumstantiae*) from *Nicomachean Ethics*, as per Aquinas' summary: 'We must take note of *who* did it, by what aids or instruments they did it (*with*), *what* they did, *where* they did it, *why* they did it, *how* and *when* they did it (Sloan 2010). Data visualizations follow suit and 'With what effect' often an author's primary end goal.

A branch of visual communications, data visualizations are generally two-dimensional and static but may also be three-dimensional and animated, and the design can help an author present data relative to their aims and agenda. That is, their specific communication objectives are highlighted (or perhaps obscured) via the allocation of design elements in their data visualizations.

Parikh advises that authors often use three ways to mislead within the context of data visualization:

- a) Cumulative graphs that obscure actual trends in data.
- b) Adjusting the y-axis to visually misrepresent data.
- c) Ignoring conventions in data visualization (Parikh 2014).

One such example is the chart used by Tim Cook at an Apple iPhone presentation in 2013. Cook's primary end goal was to imply that iPhones sales were on a constant and successful upward trajectory. However, the cumulative graph chart included dates for the horizontal x-axis but did not include details for the y-axis or any other relevant data, as illustrated in Figure 1.

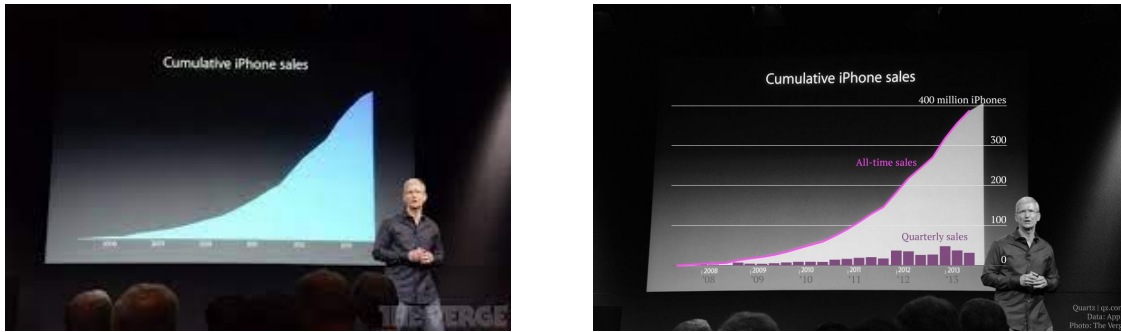

Figure 1: iPhone sales chart, 2013.

Aside from the mathematical formatting of data visualizations, the allocation of color and contrast is a powerful design element that can be used to skew data presentation to either clarify and inform, or mislead and misrepresent depending on an author's aims, intentions and agenda.

This discussion explores the strategic use of color to either highlight or obscure data. Given the prevalence of data visualization across multiple sectors, this discussion will focus on the power and persuasive nature of color in respect to three sectors: sociology, climate change, and politics.

### **EVOLUTION OF COLOR IN DATA VISUALIZATION**

Visual representation of information in one form or another is not new. Land installations documenting the lunar cycle, tidal movements and the like, date back centuries. Some of these include land installations such as the pit alignments at Warren Field, Crathes, Scotland (c8000 BCE), which correlate with the phases of the moon and considered the oldest lunar calendar and Stonehenge.

Many centuries later, data visualizations on paper emerged. Early examples include those created by William Playfair, referred to as the inventor of the line, pie and bar chart as well as the pie chart. Playfair's illustrations in *Commercial and Political Atlas*, published in 1786, featured patterns of similarity and difference in import and export relevant to England and, given Playfair's various roles as a merchant, investor, counterfeiter, secret agent, and banker, it is likely he developed and published his charts to suit his own aims and agenda. Playfair's bar chart illustrating Scotland's imports and exports from and to seventeen countries (1781) and trade-balance chart (1786) predominantly feature variations in tonal value plus hand-colored sections to highlight changes in data.

French civil engineer Charles Joseph Minard is also recognized as an early pioneer in representing data through two-dimensional visual representation. Examples include Minard's diagram (1858) which illustrates the movement of cattle from various regions of France to Paris and a chart (1869) illustrating the flow of French troops and the distance covered during France's invasion of Russia.

Early data visualization illustrations were mostly presented in a limited range of colors, predominantly black and white. Variations in tonal value and occasionally color were used to highlight patterns of similarity and difference in data. As printing processes advanced and, with the emergence of color printing and digital color representation, color became an integral element in data visualization.

### **COLOR IN DATA VISUALIZATION**

Under traditional color theory, color is understood to have three attributes: hue, tonal value and saturation (O'Connor 2021). In data visualizations, their effectiveness is underpinned by how well the attributes of color are allocated to ensure that attention is drawn to key areas of information embedded within these illustrations. Specifically, due to the mechanics of visual perception and the

operation of saccades, focal attention is drawn to strong color contrast and movement. This is supported by the findings from eye-tracking studies, which indicate that visual search is attracted by human faces and figures, areas of strong contrast, and detailed visual data (Yarbus 1967).

As a result, variations in color and contrast are often harnessed in 2D static visual communications to attract attention, create focus, encourage engagement and in some cases, communicate symbolic meaning (O'Connor 2015). In the design of data visualizations, the capacity to read and understand these quickly and effectively relies on the speedy communication of patterns of similarity and/or difference in the presented data. Color and contrast are integral components of this process.

However, the author's aims and agenda tend to underpin the allocation of color and contrast to ensure that specific areas of data highlighted or perhaps obscured.

This paper explores the allocation of color and contrast in data visualization. Through examination of recent case studies in sociology, climate change and politics, the power and persuasive capacity of color to influence and perhaps alter meaning is revealed.

## **Sociology**

Sociology is a discipline where color is often used in data visualizations to change perceptions relevant to an author's aims and agenda. This has been occurring for over a century, with both positive and negative impact in terms of changing perceptions, cultural awareness, economic impact and policy.

One of the earliest and most effective applications of color in data visualizations were those by W E B Du Bois for the 'American Negro' exhibit at the 1900 Paris Exposition. Du Bois was committed to combating racism and challenging the notion that African Americans were misconstrued as inferior to Anglo-Americans. Du Bois' data visualization charts are exceptional in their ability to use simple design elements and color to convey information that highlight the experiences and achievements of Black Americans. Du Bois was keen to challenge the racist caricatures that diminished and denigrated African Americans by illustrating empirical evidence relating to the many achievements of African Americans.

Du Bois was successful in using data visualizations to achieve his aims, and color played an integral role in the powerful imagery of his charts.

'Redlining' is another example of the way in which color in data visualization was used in a powerful way to change perceptions about specific minority groups in the USA. Emerging initially in land economics, redlining had incredibly negative and long-term impacts. The practice of redlining was developed by Homer Hoyt, the Chief Land Economist of the Federal Housing Administration (FHA) between 1934 and 1940. Hoyt, who worked as a real estate broker in Chicago while completing his PhD, focused on developing data visualizations that indicated the level of loan security for over 200 cities around America. These "residential security maps" were underpinned by Hoyt's assumptions about minority population cohorts and their capacity to pay off their mortgages.

Data visualizations such as those in the following Figure, include a legend where green indicated Grade A (or First Grade), that is, the best neighborhoods; and red was used to indicate 'hazardous' neighborhoods. Hoyt's data visualizations were used to deny minority groups' access to loans to purchase houses in white neighborhoods, thereby perpetuating racial segregation. In addition, redlining also prompted variations in investment across different parts of city, effectively starving redlined areas of investment across a range of key services, thereby negatively impacting a range of outcomes including educational outcomes (Rothstein 2017).

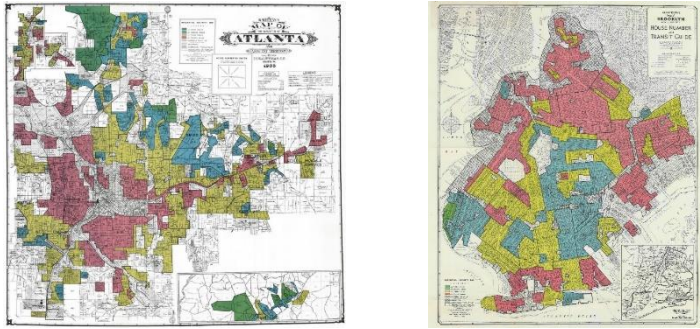

Figure 2: Redlining data visualizations developed by Homer Hoyt for FHA.

### Climate Change

Climate change, an issue of global concern, is often discussed and illustrated using data visualization. An early data visualization considered "the most compelling global warming visualization ever made" was created by climate scientist Professor Ed Hawkins in 2016 (Samenow 2016). Two years later in 2018, Hawkins created Climate Change 'warming stripes' which feature the common constructs of *warm colors* and *cool colors* to illustrate the impact of climate change. The following figure features Ed Hawkins' data visualization (2016) and annual global temperatures from 1850-2017 (2018).

This highly effective use of the common color construct of *warm colors* and *cool colors* not only conveys the key message about climate change but does so in a way that is quickly and easily understood irrespective of age, cultural background, or educational and scientific training.

The familiarity of *warm colors* and *cool colors* plus the aesthetics of Hawkins' warming stripes is also important because it has helped this specific data visualization become ubiquitous and highly effective in promoting the issue of climate change across multiple, disparate applications. The following figure features Hauptbahnhof, Cottbus station, Germany (2020).



Figure 3: Hawkins' Warming Stripes featuring *cool colors* and *warm colors*.

Since the emergence of Hawkins' Climate Change warming stripes and the plethora of contexts that now feature these, Hawkins has brought invaluable global attention to this key issue. The color strategy of *warm colors* and *cool colors* has been harnessed to effectively convey the integral message about climate change. Given the ubiquitous nature of Hawkins' warming stripes, the simple but effective use of this color strategy has had a powerful impact on raising awareness of climate change worldwide.

### Politics

*Traditional U.S. electoral maps not only illustrate polarization, they can exacerbate it. No state is strictly red or blue, they are all shades of purple (Albers 2020).* Three key issues complicate the discussion

regarding the outcome of US elections: the Electoral College system, the uneven spread of population across counties, and the way election results are reported in data visualizations.

An early example provides insight. In the 1936 US election, Franklin D. Roosevelt won 60.8% of the popular vote, Alf Landon won 36.5% and William Lemke won just under 2%. However, due to the Electoral College system, Roosevelt won 523 electoral votes, 98.49% of the electoral vote total of 531. The Electoral College map of the 1936 election a landslide win to Roosevelt. However, the results by county show a different perspective and it's the allocation of color that reinforces the variations between these two data visualizations.

History records that no state in the USA ever votes 100% Democratic or 100% Republican and this is reflected in the data visualizations of multiple US elections created by Purplestatesofamerica.org. These illustrate the proportion of Democrat or Republican vote for each state using nuances of purple to represent the proportional Republican or Democrat vote in each state, as per Figure 4.

However, data visualizations that are far more common depict US states as either wholly Republican (red) or Democrat (blue). Unfortunately, these strong color contrast depictions serve to reinforce an inaccurate narrative that suggests America is deeply divided and polarized despite the fact that US states are never 100% Republican or 100% Democrat. In addition, while people often have voting preferences, these change over time with each US election (see Rutchik et al. 2009).

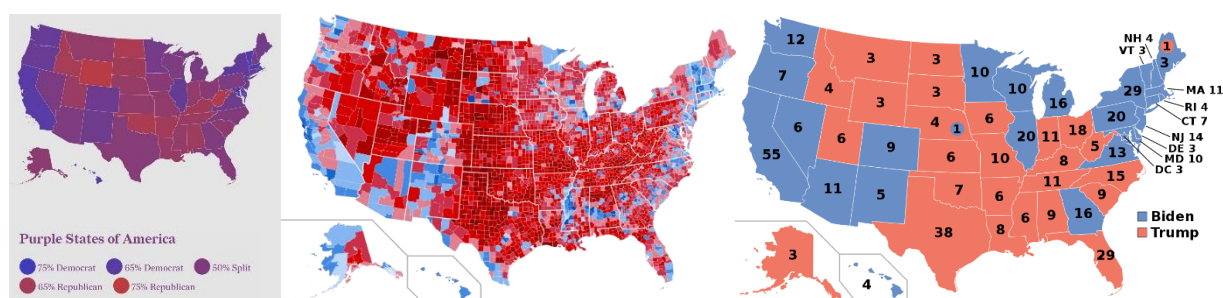

Figure 4: 2020 US election voting results by county and Electoral College.

It is this use of color allocation in election data visualizations that has the capacity to obscure or mislead, and to misinform the target audience, depending on the author's aims and intentions. The former US President Donald J Trump and members of the Republican Party have used these data visualizations to underpin an agenda of "election fraud".

## CONCLUSION

Data visualizations are purpose-designed graphic illustrations of information created and presented to support an author's aims and agenda. Given the graphic nature of these, design elements like color are used to draw attention to key areas of information in such a way as to draw attention quickly and to ensure the communication process is effective. This paper explored the mechanics of visual perception and the roles that color and contrast play in attracting attention within the limited context of data visualizations within the disciplines of sociology, climate change and politics.

Without negating or minimizing the roles of cognitive processing and critical analysis, color is often used strategically by some authors to skew the presentation of data in an attempt to persuade and perhaps manipulate audience evaluation and response. Depending on the author's aims, intentions and agenda, the outcomes from the strategic use of color have the power to contribute in some way

to the greater good, or sow the seeds of chaos and divisiveness as per the recent “Big Lie” and claims of election fraud arising from the 2020 US election.

## REFERENCES

- Albers, G. 2020. *Purple states of America*. Accessed on 20 February from <https://purplestatesofamerica.org/>
- Badger, E. 2017. *How redlining’s racist effects lasted for decades*. New York Times, August 24, 2017. Accessed on 3 May 2018 from <https://www.nytimes.com/2017/08/24/upshot/how-redlinings-racist-effects-lasting-for-decades.html>
- Berinato, S. 2016. *Visualizations that really work*. Harvard Business Review (June 2016, 92-100). Accessed 18 February 2021 from <https://hbr.org/2016/06/visualizations-that-really-work>
- Du Bois, W.E. Burghardt. 1900. The American Negro at Paris. *The American Monthly Review of Reviews*, vol. XXII, no. 5 (November): 575-577.
- Hawkins, E. 2018. *Climate Lab Book – Warming Stripes* (May 2018). Accessed 20 September 2018 from <https://www.climate-lab-book.ac.uk/2018/warming-stripes/>
- Holt, T. C. 2008. W. E. B. Du Bois. *African American National Biography*. (Eds. Henry Louis Gates Jr. and Evelyn Brooks Higginbotham). New York: Oxford University Press. Accessed on 28 March 2021 from African American Studies Center <https://oxfordaasc.com/>
- Lasswell, H. 1948. In: Bryson, L. (ed.). *The Structure and Function of Communication in Society. The Communication of Ideas*. New York: Institute for Religious and Social Studies.
- Mason, B. 2020. *Election Maps Are Everywhere. Don’t Let Them Fool You*. New York Times, October 30, 2020. Accessed on 20 January 2021 from <https://www.nytimes.com/interactive/2020/10/30/opinion/election-results-maps.html>
- O’Connor, Z. 2021. Traditional colour theory: A review. *Color Research and Application* 46: 838-847.
- O’Connor, Z. 2015. Colour, contrast and Gestalt theories of perception: The impact in contemporary visual communications design. *Color Research and Application* 40: 85-92.
- Parikh, R. 2014. How to lie with data visualization. *Heap*, April 14. Accessed on 18 February 2021 from <https://heap.io/blog/data-stories/how-to-lie-with-data-visualization>
- Rotherstein, J. 2020. *Black Lives 1900: W.E.B. Du Bois at the Paris Exposition*. London: Redstone Press.
- Rothstein, R. 2017. *The color of law: A forgotten history of how our government segregated America*. New York: Liveright Publishing.
- Rutchick, A. M., J. M. Smyth, and S. Konrath. 2009. Seeing Red (and Blue): Effects of Electoral College Depictions on Political Group Perception. *Analysis of Social Issues and Public Policy*, 9, 1. Accessed 19 February 2021 from <https://doi.org/10.1111/j.1530-2415.2009.01183.x>
- Samenow, J. 2016. Unraveling spiral: The most compelling global warming visualization ever made. *The Washington Post*, 10 May 2016. Accessed 20 July 2016 from <https://www.washingtonpost.com/news/capital-weather-gang/wp/2016/05/10/the-most-compelling-visual-of-global-warming-ever-made/>
- Sloan, M. C. 2010. Aristotle’s Nicomachean Ethics as the Original Locus for the *Septem Circumstantiae*. *Classical Philology*, 105: 236-251.
- Yarbus, A. L. 1967. *Eye Movements and Vision*. New York: Plenum Press.
- Yanofsky, D. 2013. The chart Tim Cook doesn’t want you to see. Quartz, September 11, 2013. Accessed 2021 from <https://qz.com/122921/the-chart-tim-cook-doesnt-want-you-to-see/>

# Designing Voice-Aware Text in Voice Media with Background Color and Typography

Qinyue Chen <sup>1</sup>, Yuchun Yan <sup>1</sup>, and Hyeon-Jeong Suk <sup>1, \*</sup>

<sup>1</sup>Color Lab., Department of Industrial Design, KAIST, Republic of Korea; chenqinyue@kaist.ac.kr, yanyuchun@kaist.ac.kr, color@kaist.ac.kr

\* Corresponding author: color@kaist.ac.kr

## Abstract

Speech-to-Text plays a significant role in voice media. While preserving semantic information, STT also results in a large loss of nonverbal information in the voice. The goal of voice-aware text design is to bridge the gap between expressive voice and its converted text. An online survey was carried out to compare the effect of different text design elements —font, background color, and typography — on emotion expressivity, content delivery, and appropriateness of converted text. Background color and typography enhanced all three scales; however, the font did not, and even had negative effects on content delivery and appropriateness. We also found that the combination of background color and typography was regarded as the most appropriate text design in both voice messaging and social media.

**Keywords:** *Voice visualization, Text design, Color, Typography, Typeface*

## INTRODUCTION

Voice media, such as voice messaging and voice posts on SNS, have become increasingly popular. Many recent studies have focused on Speech-to-Text (STT), which is only concerned with the correctness of converted text. However, voice conveys more than contents when compared to plain text. STT inevitably results in a significant loss of nonverbal information in the voice that may have supported the user's emotional expression and content delivery.

To address this question, researchers began to use text design to represent voice characteristics and emotions. For example, studies have demonstrated the effectiveness of voice-driven typography in representing voice characteristics such as loudness, speed, and prosody (Pataca et al. 2020). Moreover, several researchers attempted to compensate for the emotion loss in mobile messaging by using affective fonts (Choi et al. 2016), color (Chen et al. 2021) or emoji (Hu et al. 2019). However, it remains unknown which text design is most appropriate for visualizing voice media.

In this study, we were inspired to visualize voice media by changing the font, background color, and typography. An online survey was conducted to compare the effect of these three text design elements on emotion expressivity, content delivery, and appropriateness of converted text. We also investigated the most appropriate text design of converted text in voice messaging and social media.

## METHOD

### Voice stimuli

We selected voice stimuli from the CREMA-D (Cao et al. 2014) corpus that corresponded to utterances of the same content given with various emotions. The same actress read aloud all of the voice stimuli in six emotions: happy, surprised, sad, fearful, angry, and disgusting. The voice stimuli consisted of three short sentences and lasted around 8 seconds. By purpose, these sentences are emotionally neutral in their literal meaning, avoiding meaning hints from the textual content.

### Voice-aware text design



The goal of this study was to investigate the effect of voice-aware text design in voice media. More specifically, three text design elements— font, background color, and typography, were investigated. We decided to map the text design to the voice in the following way:

First, as shown in Figure 1, different fonts and background colors were selected to represent seven voice emotions. When the font or color change, the participants are supposed to be aware of the emotion change immediately and understand the target emotion intuitively.

*Font.* Choi et al. (2016) provides a 100-Font dataset where each font was labeled with six emotion categories (happy, sad, surprised, fearful, angry, and disgusting). We selected fonts with high emotional consensus in this dataset. For legibility reasons, we replaced several fancy or gothic fonts with other typefaces that have similar font characteristics. The font Arial is selected as a neutral font.

*Background color.* Multiple studies have confirmed that red is connected with anger (Johnson et al. 2013; Hanada 2018). Furthermore, people link light blue with happiness and pleasure (Suk and Irtel 2010), while dark blue is associated with sadness (Hanada, 2018). Orange is frequently connected with surprise, green with disgust, and purple with fear (Johnson et al. 2013).







Emotion	Font	Background Color
Neutral	Maybe tomorrow it will be cold. I would like a new alarm clock. I wonder what this is about.	Grey 
Happy	<b>Maybe tomorrow it will be cold. I would like a new alarm clock. I wonder what this is about.</b>	Light blue 
Surprised	<b>Maybe tomorrow it will be cold I would like a new alarm clock I wonder what this is about</b>	Orange 
Sad	<i>Maybe tomorrow it will be cold. I would like a new alarm clock. I wonder what this is about.</i>	Dark blue 
Fearful	<del>Maybe tomorrow it will be cold. I would like a new alarm clock. I wonder what this is about.</del>	Purple 
Angry	<i>Maybe tomorrow it will be cold. I would like a new alarm clock. I wonder what this is about.</i>	Red 
Disgusting	<i>Maybe tomorrow it will be cold. I would like a new alarm clock. I wonder what this is about.</i>	Dark green 

Figure 1: The representative fonts and background colors for each emotion.

*Typography.* We mainly capitalized or slanted the word according to the acoustic features of voice stimuli, like word-level average loudness and speed. When we want to get a listener's attention, we always employ a louder voice in our speaking. Here, we use capitalized for the loudest words in a sentence to capture the reader's attention since it makes scanning the text and recognizing relevant keywords easier. Additionally, letter slant has been associated with changes in speed (Pataca et al. 2020). Thus, we map the voice speed to letter slant and utilize slanted for fast words in a sentence.

Combining the font, background color and typography, we created seven text designs for each non-neutral emotion. Additionally, the text designs were integrated into two representative platforms: voice messaging and social media. To simulate the practical application, we applied the solid background color on the chat bubble for voice messaging. While for social media, we utilized the

corresponding color as the gradient background. A total of 84 (7 text designs × 6 non-neutral emotions × 2 platforms) stimuli were created. Examples of stimuli for "Happy" are shown in Figure 2.

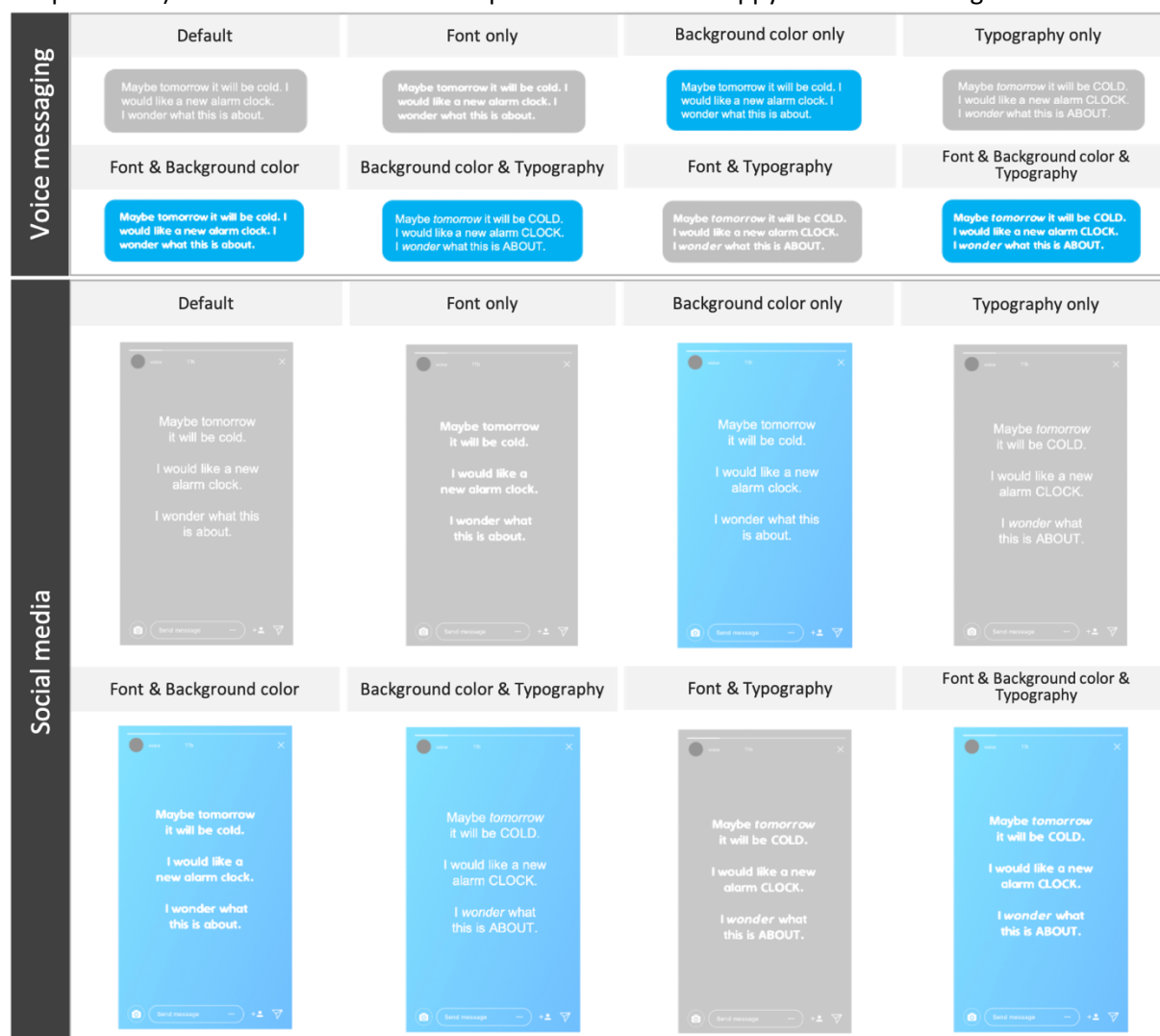

Figure 2: Examples of stimuli for "Happy" in voice messaging and social media.

### Experimental setup

A total of 31 participants voluntarily participated in the study (13 males and 18 females, ages ranging from 18 to 43,  $M = 26.23$ ,  $SD = 5.62$ ) and all were paid volunteers. The study was carried out in a web-based survey and the participants were given 84 stimuli in random order. As shown in Figure 3, for each voice stimuli, the participants were required to listen to the audio first, and compare the text designs with the default one based on three criteria: emotion expressivity, content delivery, and appropriateness, with a bipolar scale where -2 referred to "Strongly disagree" and +2 referred to "Strongly agree".

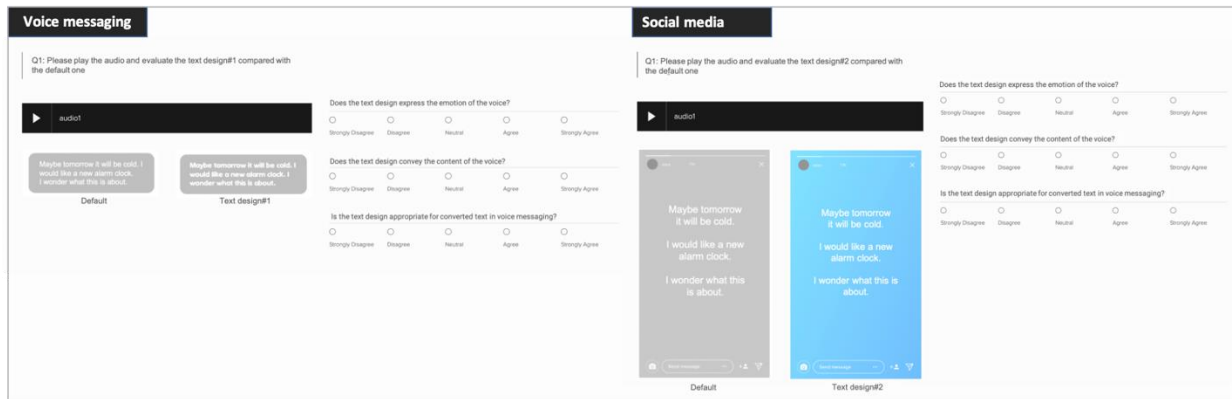

Figure 3: A screenshot of the web-based survey for this study: voice messaging and social media

## RESULTS

### Effect of font, background color and typography

We performed a three-way ANOVA to identify whether font background color and typography have an influence on emotion expressivity, content delivery, and appropriateness respectively.

*Emotion expressivity.* The results indicated that background color and typography statistically improved the emotion expressivity (background color:  $F(1,2597) = 48.20, p < 0.05$ ; typography:  $F(1,2597) = 67.92, p < 0.05$ ). Despite our participants' agreement that the font can express voice emotions to some extent ( $M = 0.17 > 0$ ), there was no statistical difference observed in font ( $F(1,2597) = 0.26, p > 0.05$ ). That is, our participants perceived a very limited affective impact of the font on the converted text in this experiment. We did not find any further statistically significant interaction effects.

*Content delivery.* There were statistically significant main effects of all the text designs (font:  $F(1,2597) = 168.94, P < 0.05$ ; background color:  $F(1,2597) = 49.13, p < 0.05$ ; typography:  $F(1,2597) = 29.62, p < 0.05$ ). More specifically, the users evaluated that background color ( $M = 0.34, SD = 1.04$ ) and typography ( $M = 0.31, SD = 1.09$ ) improved the content delivery of converted text, however the font even lowered the content delivery compared to the default ( $M = -0.10, SD = 1.09$ ). Similarly, no significant interaction effects were found.

*Appropriateness.* As expected, font, background color and typography all had significant main effects on appropriateness (font:  $F(1,2597) = 131.88, p < 0.05$ ; background color:  $F(1,2597) = 93.56, p < 0.05$ ; typography:  $F(1,2597) = 23.94, p < 0.05$ ). No statistically significant interaction effect was found. We see that background color received higher ratings ( $M = 0.21, SD = 1.02$ ) than typography in appropriateness ( $M = 0.11, SD = 1.03$ ). On the contrary, participants generally argued that using fonts was inappropriate ( $M = -0.20, SD = 0.04$ ).

### The most appropriate text design on voice messaging and social media

A one-way ANOVA was conducted to figure out which text design improved most in terms of emotion expressivity, content delivery, and appropriateness for two platforms. Figure 4 shows the mean rating scores that the different text design combinations received in two different platforms.

For voice messaging, "Background color & Typography" statistically received positive results in all three scales (emotion expressivity:  $M = 0.50, SD = 1.01$ ; content delivery:  $M = 0.85, SD = 0.85$ ; appropriateness:  $M = 0.66, SD = 0.87$ ). This implies that the combination of background color and typography not only improved the emotion expressivity and content delivery of converted text, but

was also suitable for voice messaging. Surprisingly, although receiving the highest rating score in emotion expressivity ( $M = 0.56$ ,  $SD = 1.20$ ), “Font & Background color & Typography” was seen as negatively affecting content delivery and not suited in voice messaging. We also noticed the font had a negative effect on all three scales, and all text designs that used font (i.e., “Font & Background color”:  $M = -0.45$ ,  $SD = 1.02$ ) were regarded inappropriate for use in voice messaging.

For social media, “Background color & Typography” received highest rating scores across all three scales (emotion expressivity:  $M = 0.62$ ,  $SD = 1.04$ ; content delivery:  $M = 0.75$ ,  $SD = 0.92$ ; appropriateness:  $M = 0.61$ ,  $SD = 0.91$ ). In terms of content delivery and appropriateness, the results show that “Background color” was also preferred, just below “Background color & Typography”. Also, it was interesting to note that, different with voice messaging, participants agreed that “Font & Background color & Typography” significantly improved the three scales in social media. Nonetheless, despite statistical significance, the impacts of “Font & Background color & Typography” on content delivery and appropriateness are modest when compared to “Background color & Typography” and “Background color”.

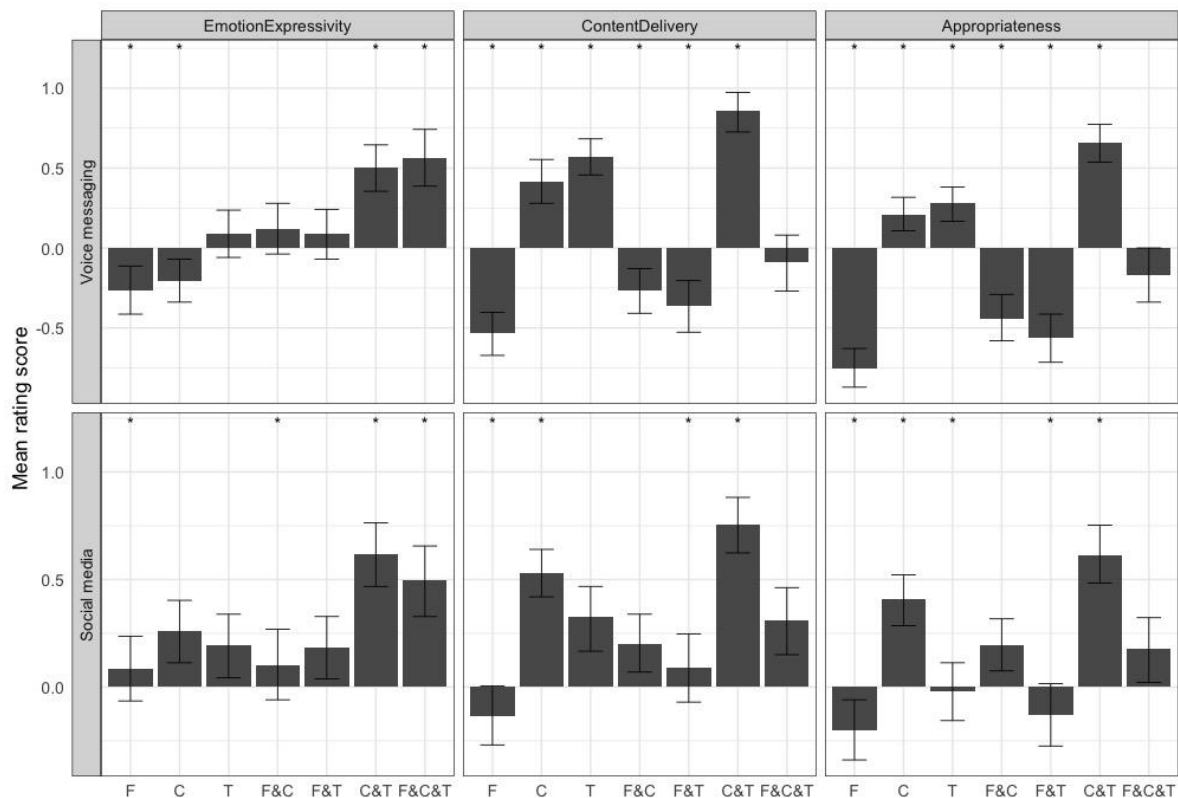

Figure 4: Average scales of emotion expressivity, content delivery and appropriateness in voice messaging and social media (F = “Font”, C = “Background color”, T = “Typography”). An asterisk indicates significance at  $p < .05$  compared against all other text designs.

## CONCLUSION

The effect of different text design elements was explored in this study. We found that, when compared to background color and typography, the effect of the font on emotion expressivity and content delivery of the converted text was insignificant and negative. The font is also seen as unsuitable for text design in two platforms, particularly voice messaging. The combination of background color and typography is shown to be a good text design to represent voice media in both voice messaging and

social media. Although this study did not investigate all the variations of font, background color, and typography designs, it did demonstrate the potential of voice-aware text in narrowing the gap between voice and converted text, which can be used in affective voice interfaces and automatic captioning. For the future work, the influence of specific color and typography properties, such as color brightness and letter roundness need to be investigated.

## **ACKNOWLEDGEMENTS**

This work was supported by the National Research Foundation of Korea (NRF-2018R1A1A3A 04078934) and the BK21 plus program through the National Research Foundation (NRF) funded by the Ministry of Education of Korea (NO.4120200913638).

## **REFERENCES**

- De Lacerda Pataca, C., and P. Dornhofer Paro Costa. 2020. Speech modulated typography: towards an affective representation model. In: *Proceedings of the 25th International Conference on Intelligent User Interfaces*, 139–143.
- Cao, H., D. G. Cooper, M. K. Keutmann, R. C. Gur, A. Nenkova, and R. Verma. 2014. Crema-d: Crowd-sourced emotional multimodal actors dataset. *IEEE Transactions on Affective Computing* 5 (4): 377–90.
- Chen, Q., Y. Yan, and H. Jeong Suk. 2021. Bubble coloring to visualize the speech emotion. In: *Extended Abstracts of the 2021 CHI Conference on Human Factors in Computing Systems*, 1-6. 2021.
- Choi, S., T. Yamasaki, and K. Aizawa. 2016. Typeface emotion analysis for communication on mobile messengers. In: *Proceedings of the 1st International Workshop on Multimedia Alternate Realities*, 37-40.
- Hanada, M. 2018. Correspondence analysis of color–emotion associations. *Color Research & Application* 43, no. 2, 224-237.
- Hu, J., Q. Xu, L. P. Fu, and Y. Xu. 2019. Emojilization: An automated method for speech to emoji-labeled text. In: *Extended Abstracts of the 2019 CHI Conference on Human Factors in Computing Systems*, 1-6.
- Johnson, D. O., R. H. Cuijpers, and D. van der Pol. 2013. Imitating human emotions with artificial facial expressions. *International Journal of Social Robotics* 5, no. 4: 503–13.
- Suk, H.-J. and H. Irtel. 2010. Emotional response to color across media. *Color Research & Application* 35, no. 1: 64-77.

# Sentiment Analysis Based on Frequency of Colour Names on Social Media

Boshuo Guo <sup>1,\*</sup>, Stephen Westland <sup>1,\*</sup> and Peihua Lai <sup>1</sup>

<sup>1</sup> The University of Leeds; b.guo1@leeds.ac.uk, s.westland@leeds.ac.uk, ss17pl@leeds.ac.uk

\* Corresponding author: b.guo1@leeds.ac.uk, s.westland@leeds.ac.uk

## Abstract

This study aims at finding out the sentiment associated with eight colour terms in the context of an overall negative marketplace sentiment during 2020/2021 and how the sentiment varies over time. We focus on the valence aspect of sentiment. We collected two datasets, separated by six months, each containing 18000 mentions of each of the eight colour terms in English from Twitter users around the world. We calculated the weighted average sentiment score of each instance when a colour is mentioned. We find that purple, pink and green have a positive average sentiment score in both observation points. Brown, red and orange are negative in both observation points. We also find that the relative sentiment value associated with the colour terms did not significantly vary over the six months. This finding indicates that there is a strong coherence in the sentiment. Our work contributes to colour perception in marketing communication.

**Keywords:** *colour, marketing, psychology*

## INTRODUCTION

Colour plays an important role in marketing communication. Research shows that colour makes advertisements more attractive (Bohle and Garcia 1986), promotes favourable attitudes (Fernandez and Rosen 2000) and influences customers' information processing (Lee et al. 2014). Understanding the sentiment associated with colours enables marketers to generate positive online word of mouth, improve persuasion (Han, Duhachek and Agrawal 2014) and effectively promote products.

In this study, we aim at finding out the sentiment associated with eight colour terms in the context of an overall negative marketplace sentiment in 2020 and 2021 and how the sentiment varies over time. We focus on the eight chromatic colours that are blue, brown, green, orange, pink, purple, red and yellow; we chose these colour terms because they are the chromatic terms in the 11 basic colour names (the other 11 basic colour names, that we did not include, are white, black and grey). We focus on the valence aspect of sentiment. We collected the first datasets in July 2020 and the second dataset in January 2021. Each dataset contains 18000 mentions of each of the eight colour terms in English from Twitter users around the world. We measure sentiment using the weighted average sentiment score of each instance when a colour is mentioned based on known sentiment scores of other words in the tweet.

We have two main findings. First, our sentiment measurement shows that purple, pink and green are the colours with a positive average sentiment score in both observation points. Purple is the colour with the highest average score, indicating that the users exhibit the most positive sentiment when mentioning purple. Brown, red and orange are negative in both the 2020 and 2021 datasets. Our second finding is that the sentiment value associated with these colour terms did not significantly vary over the six months. When mentioning a colour, twitter users used more than half of the words that are identical between the two observation points. In terms of the words that carry sentiment meanings, the match rate is even higher (>75%.) This finding indicates that there is a strong coherence in the sentiment associated with the mentions of colour within six months.

In the next sections we describe our data, develop our measurement of sentiment and discuss our findings, as well as study limitations and directions for future research.

## DATA AND METHOD

We collected two datasets from Twitter, using Twitter API and Rtweet (Kearney 2019) package. Each dataset contains 144000 Twitter posts (18000 posts per colour name x 8 colour names). In order to avoid repeated content in retweets and consequent bias in calculation, we included only original Twitter posts in our datasets and no retweets are included. We group the posts according to mentions of colour. We collected the first dataset in July 2020 and the second dataset in January 2021, in order to assess the coherence and temporal consistency in the sentiment associated with these colour names.

In our datasets, every post is described with 90 variables, including time when the post was created, post text, user's name, hashtags, number of likes and more. However, we simply focus our analysis on post text in this study. We collected the posts from Twitter users around the world and only include in our datasets the posts in English.

We cleaned the datasets and made the post text into "tidy text" in the following steps. First, we removed URLs, mentioned user's names and hashtags from the text. This is to avoid the bias in calculating the sentiment value, since, although some URLs and users' names contain words that carry sentiment meanings, quoting these elements does not uncover the sentiment of the post author. Stop words are common words that do not carry meaning, for example, "is" and "the". We follow the routine of natural language processing and removed these words from text too. We split the remaining text into single words and calculated the frequency of every word in the 18000 posts of each colour.

We derive sentiment value of each word using AFINN (Nielsen, 2011) lexicon. AFINN lexicon rates the valence of English word using a score from -5 to +5. A positive score indicates positive emotion, while a negative score indicates negative sentiment. A score with a bigger absolute value indicates a stronger emotion.

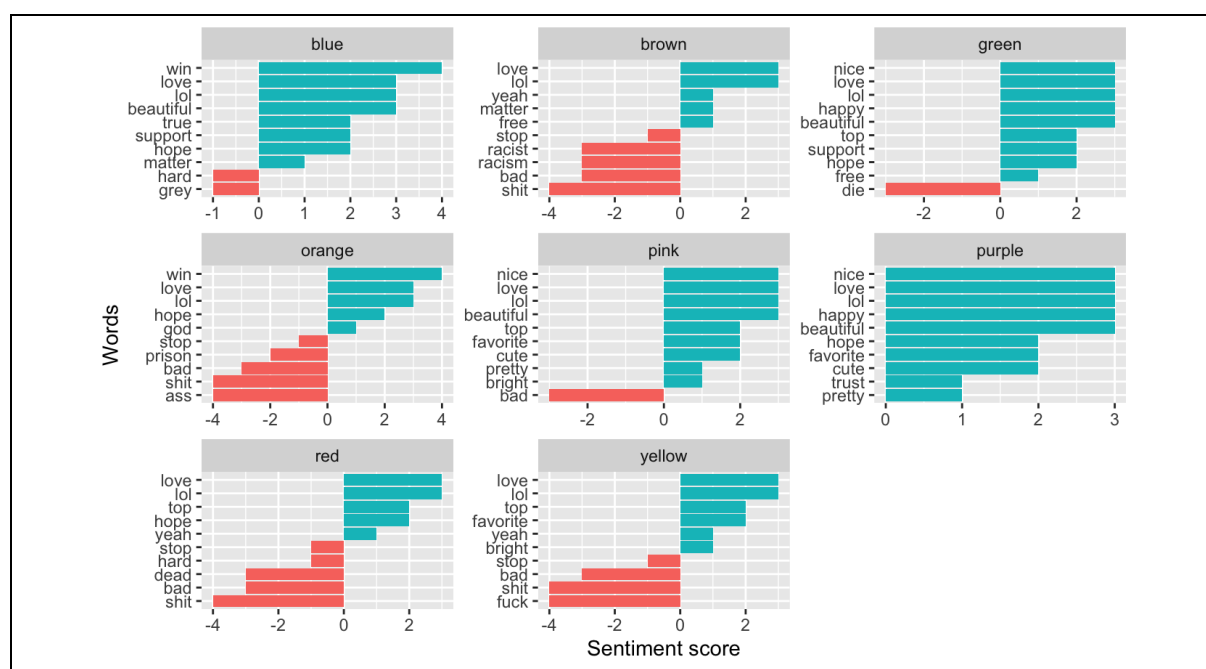

Figure 1: The ten most frequently used words (and their sentiment scores) for each of the colour words in the 2020 July dataset.

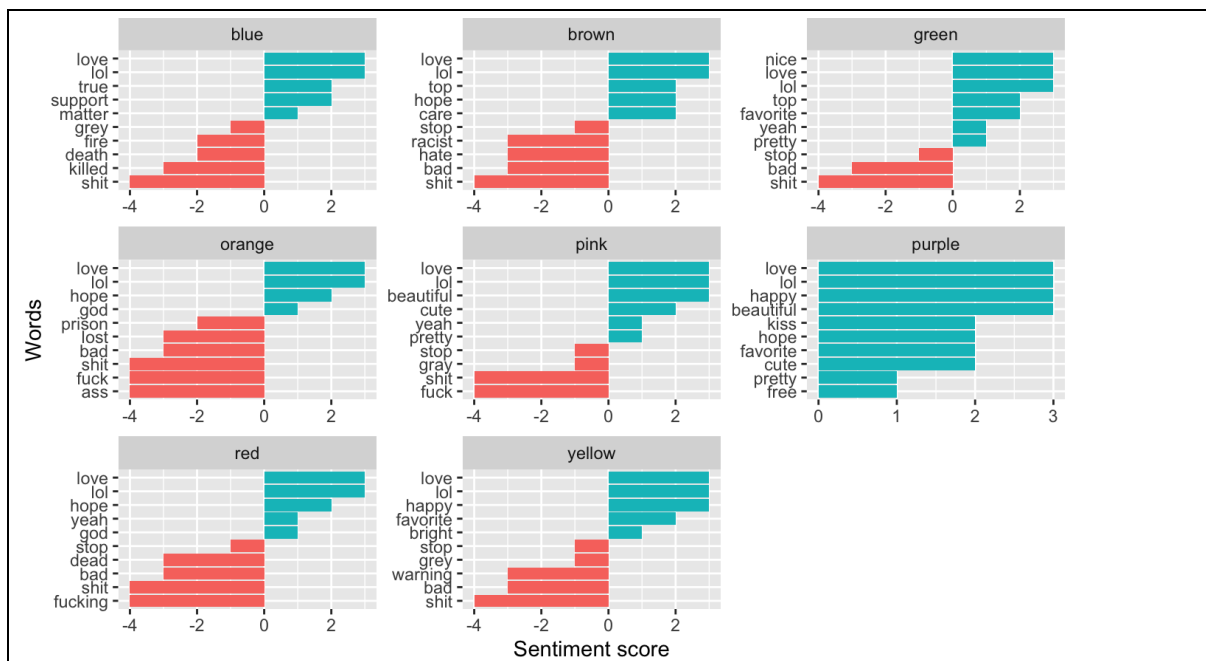

Figure 2: The ten most frequently used words (and their sentiment scores) for each of the colour words in the 2021 January dataset.

Figure 1 and Figure 2 show the ten most frequently used words and their sentiment scores in the group of posts of every colour in each of the datasets. Figure 1 and Figure 2 display words that contribute the most sentiment score in the posts of every colour. In both figures, we use green bars to indicate positive sentiment scores, whilst red bars are used for negative sentiment score.

We develop the measurement of colour associated sentiment as a weighted average sentiment score, as documented in Formula 1.

$$colour\ associated\ sentiment = \frac{\sum (Score * frequency)}{\sum frequency} \quad (1)$$

We use the word frequency as the weight, since a word contributes more to the overall sentiment value if it is used more often in the posts. We multiply every word’s sentiment score by the number of times this word was used in all the posts mentioning a certain colour. We sum up this value of all the words in the posts mentioning a certain colour and divided it by the total word frequency.

**RESULTS**

We present the colour associated sentiment values in Figure 3.

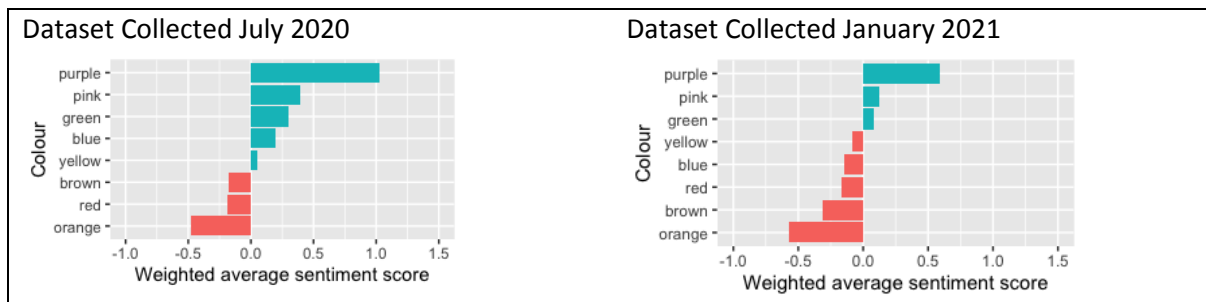

Figure 3: Mean sentiment scores for each of the colour names in 2020 and 2021.



We find that Purple is the most positively mentioned colour in both January 2021 and July 2020. Purple, pink and green are the colours that are positive in weighted average sentiment scores in both datasets. Blue and yellow are positive in the July dataset while negative in the January dataset. Red, brown and orange are negative in both datasets.

We find that, in both datasets, purple is the only colour where the top ten frequently used words are all positive, as illustrated in Figure 1 and Figure 2. Pink and green have more positive words than negative in both datasets, with significantly more positive words in July dataset. Besides, blue and yellow have more positive words in July dataset, while in January dataset both colours have half of the words positive.

Figure 1 and Figure 2 show that the most frequently used words in the mentions of every specific colour are likely to be highly coherent between July 2020 and January 2021. In order to understand how coherent the words used in the posts are between the two datasets, we derive the word stem of every word used in the posts. Within the group of posts mentioning one colour, we count the number of matches between the word stems in January dataset and the July dataset. We find that more than half of the word stems in January 2021 dataset find a match in July 2020 dataset. This is true for all colours in our datasets. It indicates that, when mentioning a colour, the twitter users used more than half of the words that are identical between the two observation points. In terms of the words that carry sentiment meanings, the match rate is even higher than 75%. This finding indicates that there is a strong coherence in the sentiment associated with the mentions of colour between these different observation time points.

## ***DISCUSSION***

Our study contributes to the colour research area by uncovering the coherence of sentiment associated with eight chromatic colour names in Twitter over a six month scope. To the best of our knowledge, this study is one of the pioneering effort to explore the sentiment coherence of colour terms in social media using natural language processing methods. The coherence that we observed suggests that it is possible to develop tools to automatically monitor and predict the sentiment associated with colour terms in social media.

Our study contributes to marketing communication by suggesting that marketers, before using a colour term to feature grammatical marketing communications on social media, can analysis the sentiment associated with this colour term on this social media platform in order to make more cautious managerial decisions on the marketing communication.

There are several limitations in our study. First, this study is only based on the data collected from Twitter. According to the past studies in consumer sentiment analysis, brand sentiment depends on the social media platforms. We assume that colour sentiment metric can also depend on the platform. Further research can be developed on a more comprehensive analysis of data collected from multiple social media platforms.

Second, we focus only on the grammatical mention of colour names in text. Since processing text is considered as a higher construal level, compared with processing pictures, in consumers' information process, we assume the colour sentiment metric can be different in pictures. Further studies can explore the colour sentiment associated with the colour featured photos on social media.

Third, our study is not limited to the colour sentiment in any specific country or specific industry. Past studies suggest that the meaning of colours depends on country, culture, industry and more. Future studies could develop a more comprehensive analysis on colour sentiment in different markets and different industries.

## **REFERENCES**

- Bohle, R. H., and M. R. Garcia. 1986. *Reader Reactions to Color in Newspapers*.
- Fernandez, K. V., and D. L. Rosen. 2000. The effectiveness of information and color in yellow pages advertising. *Journal of Advertising* 29(2): 61-73.
- Garcia, M. R., and R. Bohle. 1986. Poynter research findings. *Color in American newspapers*: 32-42.
- Han, D., A. Duhachek, and N. Agrawal. 2014. Emotions shape decisions through construal level: The case of guilt and shame. *Journal of Consumer Research* 41(4): 1047-1064.
- Kearney, M. W. 2019. rtweet: Collecting and analyzing Twitter data. *Journal of open source software* 4(42): 1829.
- Lee, H., X. Deng, H. R. Unnava, and K. Fujita. 2014. Monochrome forests and colorful trees: The effect of black-and-white versus color imagery on construal level. *Journal of Consumer Research*, 41(4), 1015-1032.



# Color Specificity: the perception of difference through exhausting repetition

Daniela F. Pinheiro<sup>1</sup>, Teresa Almeida<sup>2</sup> and Domingos Loureiro<sup>3,\*</sup>

<sup>1</sup> University of Oporto, Faculty of Fine Arts. Research Institute in Art, Design and Society. Research Unit VICARTE, Glass and Ceramics for the Arts, FCT/UNL; pinheiro.daniela@hotmail.com

<sup>2</sup> University of Oporto, Faculty of Fine Arts. Collaborative Researcher in the Research Institute in Art, Design and Society; talmeida@fba.up.pt

<sup>3</sup> University of Oporto, Faculty of Fine Arts; dloureiro@fba.up.pt

\* Corresponding author: pinheiro.daniela@hotmail.com

## Abstract

This article seeks to address the perception of color and its relativity from the approach to creative and artistic processes based on a repetitive and systematic structure through the implementation of a group of formal rules. Paul Cézanne and Claude Monet through their artistic processes show us how their involvement with colors can be a reflex of a long period experience of repetition and observation of a specific formal context. That, we associate to Patricia Stokes and her notions of *ill-structured problems* and *well-structured problems*. Color and its volatility leads us to say that its relativity is associated to *ill-structured problems*, which will allow its author to perceive, based on repetition and creation of several analogous units, the ambivalent instability that identify a chromatic universe. Therefore, we come close to the artists Anoka Faruqee and Ângelo de Sousa to approach repetitive processes, that can lead its author to a creative singular path, where each unit that appears in the space of doing potentiates a confrontation between repetition, difference and singularity.

**Keywords:** *Color Perception, Repetition, Context, Constraints and Difference*

## INTRODUCTION

As the most relative medium in art, color can boost unpredictable states of perception. Take into consideration that the perception of a group of shapes is a reflex of the chromatic pallet, perceived and captured in a certain moment by someone, we start this article approaching how the experimental creative intentions of Paul Cézanne (1839-1906) and Claude Monet (1840-1926) seem to lead them to an involvement with repetition as a means to embraces different perspectives of a same motif. Color and its relativity provided the artists a confrontation with multiple perspectives of the same regular shapes. Consequently, we associate the aim of these two artists of capturing the essence of an environment by repetition, to the notions of task and goal constraints of Patricia Stokes, related to creative and unexpected results. By that, after an approach to the chromatic structured problems of Josef Albers (1888-1976), given to his students, about the multiple faces of colors, we come closer to the contemporary artists Anoka Faruqee (b.1972) and Ângelo de Sousa (1938-2011) to analyze how a group of self-constraints can contain and promote simultaneously their artistic processes related with colors and its contaminations in the space of perception. At last, a personal relationship with the implementation of color constraints to promote an authorial chromatic search in an artistic creation, led us to conclude that, when related with the creative ambitions of an artist, a set of self-constraints implanted regularly can externalize small and singular differences that improves an understanding of the artist about the ambiguities that his/her repetitive task can embrace.

### 1. Repetition in Painting as a constraint methodology to perceive formal differences

In the history of painting, or even in the history of art, the connection between looking, perceiving and representation feature the main concerns of art creation. Aspects related with shapes, volumes, perspective, but also with color – its relativity, perception or representation – were taken, more or less, into account by the artists during a creative process of a visual masterpiece. The color as medium

and resource started to occupy, around the nineteenth century, some of the biggest concerns of artists, such as Paul Cézanne (1839-1906), Paul Gauguin (1848-1903), Claude Monet (1840-1926), Vincent van Gogh (1853-1890), Georges Seurat (1859-1891) or Henri Matisse (1869-1954). A bigger awareness about color contrast and its relativity began to model the way that the artists represented the observed reality. The Mont Sainte-Victoire paintings from Cézanne or the Rouen Cathedral painted twenty-seven times by Claude Monet (Stokes, 2006: 47) exemplify this awareness. Cézanne and Monet had sought to capture the essence of a visual scene through an exhausting repetition, characterized by a persistent rearrangement of the shapes and colors. Cézanne did it through his several approaches to the Mont Sainte-Victoire, creating several compositions from the mountain and its environment, and also through his several still lifes, where he explored different formal hierarchies and chromatic balances by means of “multiple arrangements of the same objects” (Stoke 2006: 48). Monet explored color light relationships through an attempt to register a time specific impression of things, like in his painting series from Rouen Cathedral, but also, in his paintings from the same row of poplars that he also carried out in various times of day (Stokes, 2006). Consequently, it seems that repetition, as a creative methodology, was sustained by the possibility of each unit highlighting singular differences, turning them into a true moment of uniqueness. That is because repetition allowed each one of the artists to explore their own intentions inside a restricted subject of work, without precluding an individual confrontation with different understandings and formal relationships. In “Creativity from Constraints”, Patricia Stokes specify the approaching intentions of Monet (his goal constraint) through the identification of his task constraints, such as limitation on motif (Stokes 2006). In her perspective, the goal of Monet was to perceive “how does light break up (a) on things, (b) between things, (c) alone” (Stokes 2006: 41). His *goal constraint* or artistic intention connected to a task constraint leading him to an involvement with repetition as a process of perceiving the circumstantial differences. Therefore, this can be one of the possibilities that leads some artists to an involvement with systematic processes, sustained in a restricted group of rules.

## 2. Constraints and Color Relativity

After the closure of Bauhaus in 1933, Josef Albers (1888-1976) migrated to the United States, where he taught until 1950 at the Black Mountain College and, until 1958, at the Yale University. Albers was a paradigmatic teacher that, in the words of his former students Sheila Hicks and Richard Lytle, expressed his main goal as a professor with the expression “opening eyes” (Search Versus Re-Search, 2015, 25:28). By this simple phrase, Albers wanted to alert his students to the relationship, that we appoint early, between looking, perceiving and representing. To explore the intersections between these movements, Albers established some challenges and exercises with procedure constraints as a means to introduce his students to the chromatic ambiguity of hues and tones in different contexts. Considering color as “the most relative medium in art” (1976: 1), Albers presents some *ill-structured* problems (Stokes, 2006), allowing his students to create, test and analyze dozens of similar results promoting a search for balances between hues and shapes. One of the exercises was called “Four World Project” (Lytle in Search Versus Re-Search, 2015). The exercise consists in the selection of four hues that, when combined in four different studies, must enable a confrontation with completely different worlds. Despite Richard Lytle referring to the colors blue, green, red and black as the best ones to embrace this problem, the exercise doesn’t imply a single right answer. On the other hand, its form allows each student to confront a lot of different combinations of four hues in lots of diverse shapes. Consequently, each student has a singular confrontation and experience with forms, perspectives and color manipulation that redirect his/her expectations and understandings towards a

given creative path. However, in the words of Patricia Stokes, an exercise to be related with the possibility of creative results must present an *ill-structured* opposed to a *well-structured* problem (2006). The difference of both is in the specification of its task constraints. In a *well-structured* problem all the steps are known previously, likewise its right answer. Instead, in an *ill-structured* problem something is left to chance, being determined, posteriorly, by the circumstantial conditions of the moment. Nevertheless, in our perspective, when an exercise has in consideration that the perception of colors is dependent on a host of variables, the task constraints are always related with *ill-structured* problems, not being dependent of their specification or openness. The color itself can lead to unpredictable results (Pinheiro, 2019).

## 2.1 Repetition and Color-constraints in Contemporary Artistic Creation

Between 2004 and 2007, the artist Anoka Faruqee (b.1972) created five diptychs, through a definition and execution of a group of task self-constraints, whose principle and final result were connected with the sense of copy. The first step of the task was to paint a small canvas with one of the three colors: cyan, magenta or yellow. After that, she should brush the entire surface with one of the two other colors, leaving a trail of paint. To finish this painting, she should make another layer, like the second one, with the color left behind. The second step of her task consisted in copying exactly, in a bigger canvas, what she could see in the smallest one (Faruqee 2008). The goal was not to copy the way of doing, but to copy the visible image, including the multiple lines of hues observed. In the first diptych (Figure 1 [CMY]), Anoka Faruqee registered fifteen different hues, while in the last one (Figure 1 [MCY]) she reported ninety-three colors. In the words of the artist, she saw more colors just because she increased her expectation to see them (2008). However, her expectation led her to add some regular variations between diptychs, as the size difference between canvas ended up changing not only her color perception, but also her gesture register. By that, her diptychs started inscribing little variations, resulted from the making circumstances and her predisposition to look at each small painting as a distinguished universe that inscribed different movements and color trails. Consequently, her task constraints revealed a certain openness, enhanced by the procedural differences, that led her to amplifying her own perceptual experiences.

Another artist that also amplified his own color perception restricting his pictorial action to the use of only three colors, creating a monochromatic painting series, is Ângelo de Sousa (1938-2011)<sup>1</sup> (Dias, 2016). Starting each painting with a subtle drawing and with a very thin and transparent paint layer, Ângelo de Sousa was defining the shapes and each chromatic environment through a successive and occasional process of primary colors overlaying: blue, red and yellow. Sousa created a huge number of paintings with large areas of a manipulated hue that inscribed multiple shades and subtle chromatic crossings (Figure 2). Along this repetitive and restricted process, his task included self-constraints as the linear drawing previously determined, the restricted used of the three primary colors and, possibly, his goal of each canvas giving the illusion of a monochromatic surface. However, his chromatic expectations, and consequently the course of each painting, were determined by each overlap that took place in the course of his task. Despite each layer, being carried out, taking into account a possible effect, each overlap determined consequently the expectations of Ângelo de Sousa, redirecting or

---

<sup>1</sup> Natural from Maputo, Ângelo de Sousa moved to the city of Oporto in 1955, where he started and developed his extraordinary artistic career. Very experimental and multifaceted, Ângelo de Sousa is a Portuguese artist that became known by his attempt of trying to get “a maximum effect with a minimum of resources; a maximum of efficiency with a minimum of effort; a maximum of presence with a minimum of screams” (own translation from Nazaré et al. 2005: 18). By that, Ângelo de Sousa created lots of works of art inside a repetitive methodology where he explored multiple formal variations inside diverse constraints of materials. | \*citation in pt: “um máximo de efeito com um mínimo de esforço, um máximo de eficácia com um mínimo de esforço, um máximo de presença com um mínimo de gritos” (Nazaré et al. 2005: 18)

Color Specificity: the perception of difference through exhausting repetition attesting his chromatic options on a given route (Sousa, 2007). Therefore, his pictorial path was a result of a dialogical movement between what he could hope to get and what really happened during the process.

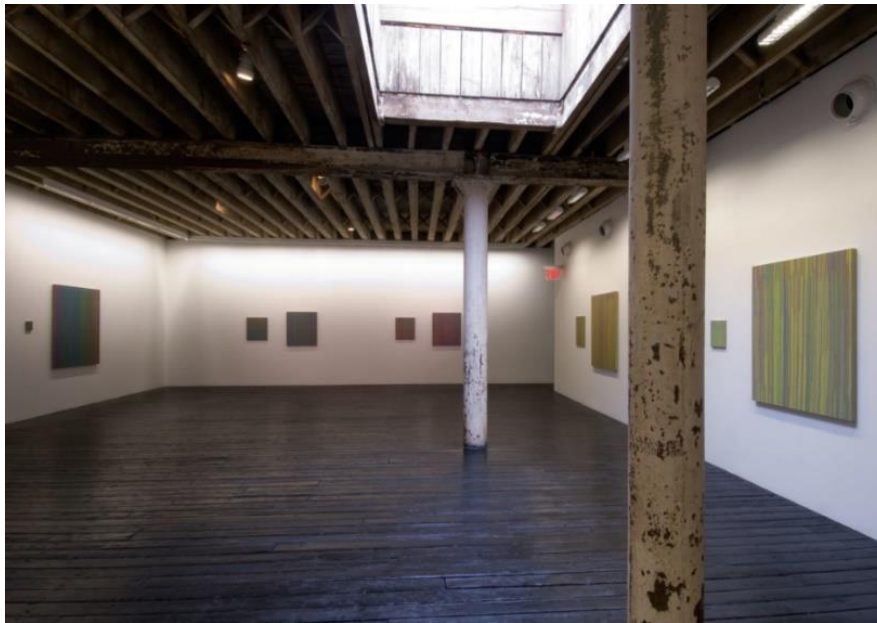

Figure 1: Diptychs “Colors Observed and Magnified” – from left to right – (MCY), (CMY), (MYC), (YCM) and (YMC) in the Exhibition CMY RGB XYZ from Anoka Faruqee at the Hosfelt Gallery, New York, 2008. Source: <http://anokafaruqee.com/installation-images/>

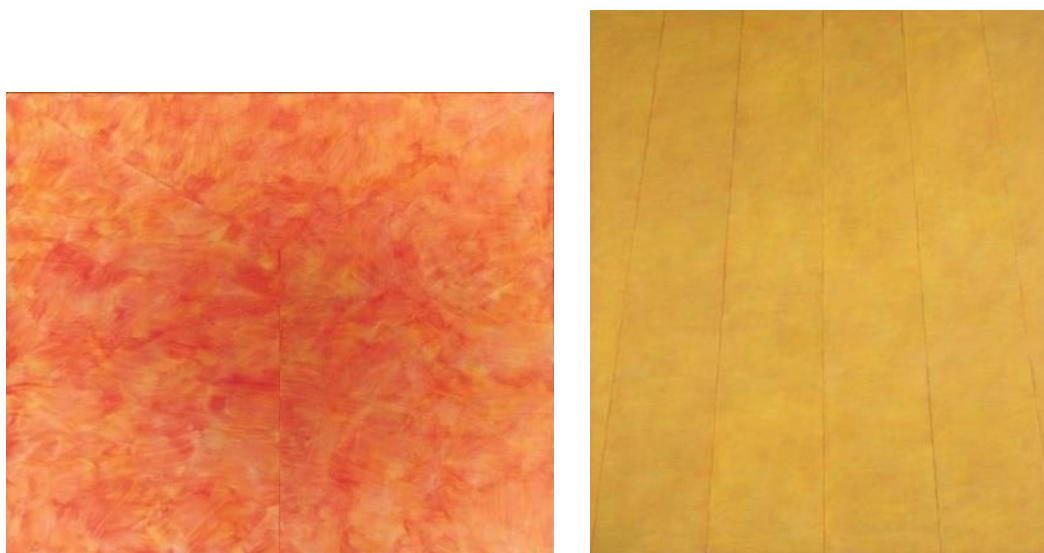

Figure 2: Ângelo de Sousa, (both paintings) Untitled, acrylic on canvas, 169.5 x 199.5 cm (left), 199.5x170 cm (right), 1973-74. Source: Foundation of Serralves Collection, Oporto.

These consequently rapprochements of the artists to the universe of color across the implementation of a group of self-constraints, lead us to reinforce the position of Josef Albers, about color and its relativity, saying that color and context are intimately connected. In other words, the perception and the use of a color are hosted in unstable conditions determined by the circumstantial characteristics of a context. By that, the repetition and the execution of a task settled in a group of self-constraints guaranty the artist a particular and specific environment, allowing him/her attesting

Color Specificity: the perception of difference through exhausting repetition

the variations that his/her task embrace. In that sense, the repetition can lead the artist to get results that escape the reductive condition of his/her initial restrictions.

## 2.2 Color-Constraints: from School Exercises to an Authorial Artistic Practice

In my personal experience, only after five years of artistic practice, I started to recognize that my increased involvement with color and art creation was a reflection of all my experiences and pictorial works created inside a specific group of self-constraints. Since the beginning, my paintings embraced, as principle of construction, a specific group of constraints directed to: i) the shapes' representation, with three specific rules; ii) the choice of three colors, for each painting; iii) and colors application through an overlaying process. That self-awareness, lead me to embrace my artistic practice as an opportunity to test and create other task constraints as a principle to explore the proximities between formal perception, color, repetition, *ill-structured* problems based on school exercises and art creation. My installation "In the beginning the difference of the end" (Figure3) was the first result in the art field of these personal intentions. In this work, my memory as a primary school student was rescued and the simple exercise of reproduce a chromatic circle through geometry and a use of the gouache's three primary colors was repeated and executed successively until the one hundred units. The only formal variation inscribed in my self-constraints was the three secondary colors obtain through the mixing of the primaries. This minimal change allowed to create and perceive a strong and static form, that independent of its opacity and rigidity, embraces a whole lot of perceptive illusions, turning the repetitive solid in a static image in motion. An exponential color mixing accuracy and sensitivity led to a subsequent register of the endless middle hues that hypothetical separate two primary colors: as greenish blues, blueish greens, yellowish greens or greenish yellows. By that, repetition as a methodological process led me to a formal approach that escaped to the reductive condition of my initial restrictions, promoting the discovery of unexpected color results and singular affinities between hues that improved my self-awareness about the potentialities of three colors manipulated.

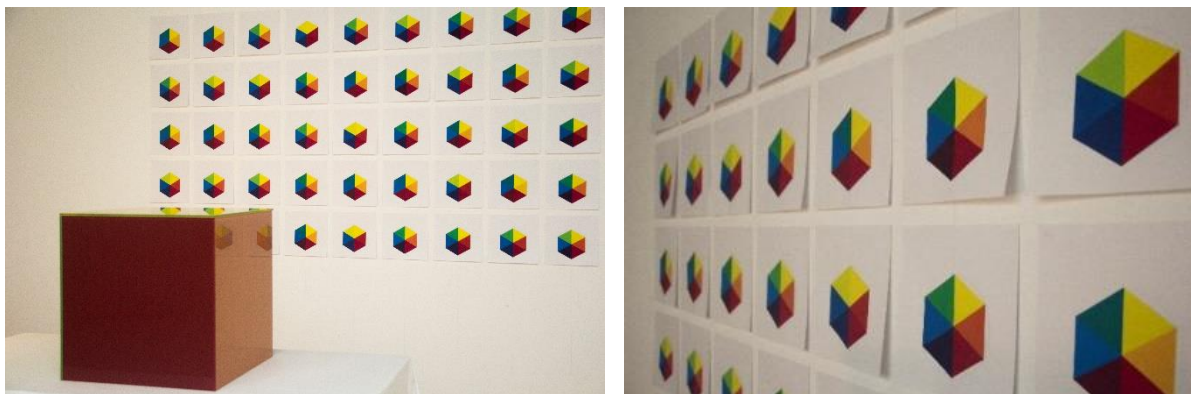

Figure 3: Daniela Pinheiro, "In the beginning the difference of the end", graphite and gouache on paper and enamel on float glass, 50 drawings of 100, 20 x 20 cm (each) and one glass object, 40 x 40 x 40 cm. 2020.

## CONCLUSION

The first approach to the artistic involvement of Paul Cézanne and Claude Monet, enabled an approach to repetition as a strategy that can be related with a group of self-constraints, defined by the artists as a means to specify their artistic challenges. Having in consideration that the perception of a color is dependent on a host of circumstantial conditions, an artist can choose to enlase his/her own artistic creation at a group of self-constraints, allowing him/her a confrontation with the multiple perceptual variations that his/her task can reach. The contemporary artists Anoka Faruqee and Ângelo de Sousa



revealed how a permanence and constant implementation of their tasks can highlight unpredictable results and surprising affinities between color, perception and its manipulation. A repetitive implementation of a group of formal strategies can reveal singular differences, that with time, extrapolate its first restricted condition, leading the artist to an open dialogue with his/her own intentions.

On the other hand, the connection that we protrude between the structure of task constraint and the structure of educational chromatic exercises (ex.: Josef Albers) leads us to question how closer can task constraints created by the artists be from teaching art school exercises? Maybe the cross line of both sides is thinner than we can imagine. In any case, these rapprochements to the universe of color across constraints and *ill-structured problems*, allow us to reinforce Albers's perspective, about color and its relativity, asserting that a certain ambiguous perception of a color application can be reached through a repetitive patient process. That is, because the little singularities that distinguish each analogous unit in the space of doing are a consequence of a time-extended execution and from the predisposition of the artist to embrace them as parts of a distinct whole. At last, a repetition process can lead to the perception of singular differences, that in dialogue with the creative intentions of the artist, will lead his/her artistic search in a given singular course.

### **ACKNOWLEDGEMENTS**

This article results of the financial support of the Portuguese public agency “Fundação para a Ciência e a Tecnologia” (FCT) and from the European Social Fund through attribution of a doctoral scholarship (SFRH/BD/144944/2019).

### **REFERENCES**

- Albers, J. 1976. *Interaction of Color*. London: Yale University.
- Education Workshop #4: Four Color Worlds, video file, 10:22, The Josef and Anni Albers Foudation, posted April 04, 2020. Online: <https://albersfoundation.org/about-us/video/2020/#tab9>
- Faruqee, Anoka. 2008. Artist s Notes: CMY RGB XYZ.” *Anoka Faruqee*. Online: <http://anokafaruqee.com/artists-notes-cmy-rgb-xyz/>.
- Nazaré, L., Â. de Sousa, B. Frey Pinto de Almeida, and A. Alves. 2005. *Ângelo de Sousa: com um mínimo de gritos*. Caminhos da Arte Portuguesa. Lisboa: Editorial Caminho.
- Pinheiro, D. F. 2019. A Condição Imprevisível da Pintura. In: *ICOCEP - International Congress on Contemporary European Painting - 2ND EDITION - PROCEEDINGS BOOK*, by Francisco Laranjo et. all, 80-84. Porto: Institute for Research in Art, Design and Society - i2ADS; University of Oporto, School of Fine Arts.
- Faruqee, A. 2016. *Search Versus Re-Search: Recollections of Josef Albers at Yale*, video file, 33:20, YouTube, posted by Anoka Faruqee, July 01, 2016. Online: [https://www.youtube.com/watch?v=cC7671N76\\_Q&t=1381s](https://www.youtube.com/watch?v=cC7671N76_Q&t=1381s)
- Sousa, Â. de. 2007. Ângelo de Sousa, Interview by Ana Sousa Dias, video file, 58:10, RTP Arquivos, January 30, 2007. Online: <https://arquivos.rtp.pt/conteudos/angelo-de-sousa/>
- Stokes, P. D. 2006. *Creativity from Constrains: The Psychology of Breakthrough*. New York: Springer Publishing Company.

# Influence of wine color on wine selection and consumption

Anica Hunjet<sup>1,\*</sup>, Sandra Križan<sup>1</sup> and Dijana Vukovic<sup>1</sup>

<sup>1</sup> University North; anica.hunjet@unin.hr; sandra.krizan@unin.hr; dijana.vukovic@unin.hr

\* Corresponding author: anica.hunjet@unin.hr

## Abstract

The paper titled The influence of wine color on wine selection and consumption is first addressed by a theory that seeks to familiarize the reader with the wine itself as a product. They will look at wine throughout history, learn about the way wine is made, the types of wine and how it is paired with food. The process of making a decision to buy wine will also be thoroughly considered. This is followed by an introduction to the color of the wine itself, which is the most recognizable feature of wine. Looking at the color of the wine, many factors can be discovered about the wine, such as the grape variety, its youth or age, origin, mode of vinification. The subject of this thesis is to determine consumer's perceptions of wine, their preferences, and their buying and consumption behavior.

**Keywords:** *wine, wine color, decision making process, consumer's behavior*

## INTRODUCTION

Wine is actually fermented grape juice. The recipe for wine has been around since ancient times – its usage for therapeutic purposes can be dated back to 2200 B.C., which makes it the world's most famous man-made medicine. There are many various kinds of wine, and some of the most well-known ones are French, Bulgarian, and Croatian. Wines can be categorized by color: there are white, rosé (rosé, opolo) and red wines. This extremely popular subject opens various opportunities for cooperation between wineries and restaurants or wineries and local food producers (f. e. prosciutto, cheese, and mushrooms can all be perfectly paired with wines). Furthermore, this is a great opportunity for tourism and hospitality staff to promote authentic, local foods and create a unique tourism- and gastro-enological experience. Consumer education and a gradual creation of the so-called 'wine culture' is highly encouraged. The purpose of this approach is to take a step back from consumption of wine as an alcoholic beverage, as well as to create some distance from accusations of alcoholism promotion. Both education and creation of 'wine culture' serve to expand the horizons of those who enjoy an occasional quality drink and potential consumers. Like any other culture, true wine culture is attained over time and encompasses certain knowledges on grapevines, wine production, wine types (by quality, color, CO<sub>2</sub> and sugar content, etc.), and the ways of serving wine. The most delicate wine culture element is pairing wine with various foods and the aforementioned knowledges are crucial to do so successfully (Ivandija, and Marić 2010: 98).

### Wine colors

Apart from the clarity, fluidity and vividity, the most significant impression is an observation made by the eye. Even though wines aren't sooth-black or snow-white, it is common to categorize them into white, rosé (or opolo), and black (or red) wines, with a special shade spectrum for each category (Benašić 2001:54). These are mostly described as reddish-yellow, white, bright-yellow or hay-yellow, greenish-yellow, golden-yellow, amber, dark yellow, a dull yellow which is also often referred to as brownish or, if the shade is darker, as dark-brown. Black and pink wines are commonly called red wines and are categorized into pinkish-red, pink, ruby-red, etc. It is important to note that wines get their colors from a group of ingredients that are commonly referred to as dyes (Ivanković and Kolega 2016: 11-112).

*White wine consumers are shaped by white wines*

In these modern times, white wine vinification encompasses new technological and professional terms, modern equipment and zero room for mistakes. White wines are to be processed differently from red ones – when it comes to white wines, the period of maceration is either non-existent or very short, the possibilities of keeping these wines in wooden barrels are very limited, their value doesn't increase with age (some wines reach their peak after only a couple of months), they are light-bodied, can also be consumed without meals and are to be served at lower temperatures. Their vinification demands a certain balance - unlike red wines, even the smallest unwanted change or variation can create consequences that are hard to undo later in the process. The characteristics of white wines, i.e. their youth, freshness and light body can be compared to a young dancer who reaches their peak in the full bloom of youth. Consumers who prefer white wines mostly like a homey ambiance, take vacations in their domicile country and are happy with their career and position in life. White wine lovers usually make between 180.000 and 230.000 kuna per year, and only 43% of them are college graduates. Most of them aren't interested in career advancements – over two fifths of the respondents stated that they aren't very ambitious (Meler 2003: 23).

**Rosé consumers are shaped by rosé wines**

Pink (rosé) and opolo wines are made from black grapes. The dye is contained within the skin of the grape (with the exception of 'teinturiers,' whereby even the grape flesh contains the dye). Pink wine can either be made by mixing white grape must with red grape must or by mixing white and red wines (which is generally prohibited). People who prefer rosé are mostly shy and quiet. According to a research conducted by Daily Mail, these people are usually kings and queens of social media such as Facebook, are loud and charming in social situations and usually drink up to two glasses every week (Meler 2003: 24).

**Red wine consumers are shaped by red wines**

One might believe that red wines were named after their color, but in actuality, all wines are red to a certain degree. As opposed to the majority of wine-growing countries, where red wines are called 'red,' in Croatia they are usually called 'black' (Meler 2002: 23). Nowadays the color is usually induced right after the fermentation, with the use of certain bacteria. Some winemakers prefer the traditional methods of winemaking and therefore let it happen spontaneously in the spring, with the rise of temperatures (Meler 2002: 23). Afterward, the wine ages in either wooden barrels or steel containers (wine maturation). Fresh fruity wines (the kinds that are meant to be consumed young) are filtered and bottled. Wine should be transfused during its aging process in order to get rid of the residue. The number of transfusions depends on the time wine spends inside the barrel. Some wines are made by mixing certain sorts or by mixing the same sort that was previously nurtured in different positions. Wine clarification and filtering occurs before bottling (even though some winemakers claim filtering causes the wine to lose some of its character). Many world-famous wines have matured in new oak barrels. Red wine lovers are very ambitious, strong, and intelligent and tend to drink up to four glasses per week.

**RESEARCH METHODOLOGY**

The previous chapters have provided an insight into the theoretical portion of winemaking and wine consumption, whereas this chapter serves to conduct a complete analysis and interpretation of the

obtained research results (Benšić and Šuvag 2013). This research has been conducted using a survey questionnaire created in Google Forms. The respondents have been questioned both online and in person in order to obtain the most relevant answers possible. 304 respondents participated in the survey. The survey questionnaire was comprised of 26 questions about wine knowledge and personal views and opinions on wine. The majority of questions were closed-ended, whereby the respondents were able to pick one or several answers. Some questions had the added option of 'something else,' which allowed the respondents to give their own answers. Social media, primarily Facebook, was utilized to invite potential respondents to fill out the questionnaire. This helped us collect an appropriate sample with various demographic characteristics. The survey was conducted between December and January of 2020 using Facebook Groups. The questionnaire was in Croatian and the estimated survey time was 2 to 3 minutes. The problem this research uncovered is a general unsatisfactory knowledge on enology. The objective of this research was to determine the consumers' perception of wine, their preferences and consumer behaviors when purchasing and consuming wine.

The research hypotheses are as follows:

- H1. Consumers can recognize the wine sort by its color.
- H2. Croatian consumers mostly consume red wines.

### ***DISCUSSION OF THE RESEARCH RESULTS***

The first three questions referred to the demographic structure of the respondents, i.e. their sex, age and the region they come from.

The obtained results show that 304 respondents participated in this research. 171 of the respondents were female (56,25%) and 133 were male (43,75%).

The majority of the respondents were between the ages of 31 and 40 (105 persons or 34,5% of respondents); 76 respondents (25%) stated they were between the ages of 21 and 30; 56 respondents were between the ages of 41 and 50 (34,5%); 38 persons claimed to be between the ages of 51 and 60 (12,5%), 19 respondents were over the age of 61 (6,3%) and 10 respondents were under the age of 20 (3,3%).

The majority of respondents – 99 persons or 32,6% - lived in the northwestern part of Croatia, followed by 92 persons (30,2%) who lived in the north of the Adriatic Coast and Lika; 48 respondents (15,8%) of the respondents lived in central Croatia; 41 respondents (13,5%) lived in the central and southern portion of the Adriatic Coast, whereas 24 persons (7,9%) lived in the east of Croatia. The majority of the respondents – 288 persons or 94,70% - had a positive opinion on consumption of wine, 15 respondents (4,90%) had a neutral opinion, whereas only 1 person (0,30%) had a negative opinion. The majority of the respondents – 127 persons or 41,80% - said they liked wine, 117 respondents (38,50%) stated they loved wine, 58 persons perceived wine as okay (19,10%), whereas 2 respondents (0,70%) said they didn't like it. When asked about their enological culture, 110 respondents (36,20%) said their enological culture was satisfactory, 79 persons stated it was very good (26%), 67 respondents (22%) stated their enological culture was bad, 32 respondents (10,5%) said it was excellent, whereas only 16 persons (5,30%) claimed their enological culture was non-existent. The next question referred to the part of the enological culture the respondents were most familiar with. It was possible to select multiple answers. 229 respondents stated they were familiar with wine sorts, 119 reported they were familiar with grape sorts, 116 were familiar with wine colors, 85 with production processes, whereas 70 persons stated they were mostly familiar with planting, cutting, and picking grapes. The remaining respondents said they weren't familiar with anything in particular. When asked 'How often do you consume wine,' almost half of the respondents – 142 persons or 46,70% -

said they consumed wine at least once a week, 74 respondents (24,30%) consumed it every day, 44 persons (14,50%) consumed it at least once a month, whereas 43 respondents (14,10%) said they consumed wine only on special occasions. Only 1 person (0,30%) claimed they never consumed wine. The next question asked about consuming wine with meals. 103 respondents stated they consumed wine with meals often, 88 consumed wine with meals occasionally, 66 persons said rarely, whereas 28 respondents stated they always consumed wine with meals. Only 19 persons said they never consumed wine with meals. The next question was: ‘How often do you consume wine when going out?’ 107 respondents reported they consumed wine during outings often, 95 persons said sometimes, 46 persons said rarely, and 43 respondents said always. Only 13 respondents said they never consumed wine during outings. When asked ‘How often do you consume wine during a celebration (birthdays, weddings etc.)?’ 130 respondents said they consumed it often, 89 persons said very often, 58 respondents said sometimes, whereas 24 persons said rarely. Only 3 respondents stated they never consumed wine during celebrations. The last question was on wine consumption unrelated to an occasion: 113 respondents stated they consumed wine sometimes, 74 persons said rarely, 71 respondents said often, 25 persons said never and 21 respondents said they always consumed wine.

Sample reliability was analyzed using the Cronbach’s Alpha Coefficient. Nine Likert – scale questions were analyzed.

Reliability Statistics		
Cronbach s Alpha	Cronbach s Alpha Based on Standardized Items	N of Items
0,736	0,744	9

Table 1: Cronbach’s Alpha Coefficient

Cronbach’s Alpha Coefficient demonstrated a satisfactory reliability level ( $\alpha=0,74$ ). Accordingly, we can conclude this test was reliable.

	frequency	Percent	Valid Percent	Cumulative Percent
valid good	110	36,2	36,2	36,2
bad	67	22	22	58,2
none	16	5,3	5,3	63,5
great	32	10,5	10,5	74
Very good	79	26	26	100
Total	304	100	100	

Table 2: What is your enological culture like? (H1)

The first question was asked in order to prove the hypothesis H1. H1 was herewith confirmed. The second question also confirms H1.

	frequency	Percent	Valid Percent	Cumulative Percent
Valid maybe	120	39,5	39,5	39,5
I do not know	50	16,4	16,4	55,9

Influence of wine color on wine selection and consumption				
no way	83	27,3	27,3	83,2
safe	7	2,3	2,3	85,5
probably	44	14,5	14,5	100
Total	304	100	100	

Table 3: Are you able to recognize the wine sort by its color? (H1)

The third question also confirms H1.

The first goal of the research was to examine the connection between wine and certain colors. The associations that certain wine colors evoke in consumers can be very powerful tools when it comes to choosing wine. When choosing a wine, consumers associate the color of the wine with the wine garden, the food and the brand. The use of wine color as a peripheral meaning in persuasive communication can potentially be very successful, when it comes to women as consumers in whom wine color has an extremely large impact. Despite the fact that the sample is intentional and appropriate in a study conducted on the influence of wine color on wine selection when considering the influence of color and gender of respondents, it is clear that the selection of such a sample significantly reduces external validity. Despite the aforementioned shortcoming, the implications of the research are important. Although it seems intuitively clear, it is important to prove empirically how different wine colors evoke different associations when choosing, and to investigate the best color choice for each individual circumstance, ie to determine which color (s) best fits the occasion when drinking wine, in the food consumed. The influence of color-based wine selection varies depending on the target population and situation, depending on the year of harvest, the type of grapes, the method of processing and the like.

Based on the statistical analysis of the obtained data, we herewith accept H1, which states that the consumers can recognize the wine sort solely by its color.

		frequency	Percent	Valid Percent	Cumulative Percent
Valid	white wine	161	53	53	53
	red wine	126	41,4	41,4	94,4
	rose wine	17	5,6	5,6	100
	Total	304	100	100	

Table 4: Which color of wine do you prefer? (H2)

This was the first question asked in order to prove the hypothesis H2. H2 was herewith discarded.

In order to prove the hypothesis H2, the respondents were asked to state their favorite wine sort in an open-ended question. The obtained results indicated that the respondents preferred white wine (Malvasia, Yellow Muscat, Welschriesling, Chardonnay). The second question also serves to discard H2.

## CONCLUSION

A total of 304 respondents participated in this research. The research was conducted using a questionnaire comprised of 26 questions about wine knowledge and personal views and opinions on wine. Most questions were closed-ended, allowing the respondents to pick one or multiple answers. Some questions offered an additional option of 'something else,' allowing the respondents to add their

own answers. More females than males participated in this research. The majority of the respondents were between the ages of 31 and 40, followed by the respondents between the ages of 21 and 30. Only a small number of respondents were under the age of 20. The majority of the respondents lived in the northwest of Croatia, whereas the least number of respondents lived in the east. The majority of the respondents said they had an average life standard, whereas only a small number reported a life standard that was below average. The majority of the respondents had a positive attitude with regards to wine consumption. Sample reliability was tested using Cronbach's Alpha Coefficient for 9 Likert-scale questions. The obtained Cronbach's Alpha Coefficient indicated a satisfactory reliability level ( $\alpha=0,74$ ), and we can therefore conclude the test was reliable.

H1. Consumers can recognize the wine sort by its color.

The first question was asked in order to confirm H1. The consumers were asked about their enological culture and general knowledge on grape and wine sorts, processing procedures etc. The majority of respondents (36%) said their enological culture was satisfactory, another 36% said their enological culture was very good and 11% stated it was excellent. The next question asked the respondents what they were most familiar with. The respondents were able to choose from the following answers: grape sorts; wine sorts, planting, cutting, and picking processes; production processes; none of the above; and something else. 116 respondents claimed to be familiar with wine colors. When asked whether they were able to recognize the wine sort by its color, 40% of the respondents said yes. Based on the statistical analysis, H1 is hereby confirmed.

H2. Croatian consumers mostly consume red wines.

The first question was asked in order to confirm H2. The respondents were asked about the color of wine they preferred. 53% of the respondents said they mostly consumed white wine, 41% said they preferred red wine, whereas only 6% stated they consumed rosé. Based on the obtained answers, hypothesis H2 is herewith discarded. The respondents were asked to name their favorite wine sort in an open-ended question. The obtained results indicate that the respondents preferred white wine ((Malvasia, Yellow Muscat, Welschriesling, Chardonnay). Based on the obtained statistical data, H2 is herewith discarded.

## REFERENCES

- Benašić, Z. 2001. *Što ljubitelji vina žele i vole znati*. Đakovo: vlastita naklada.
- Benšić, M., and N. Šuvak. 2013. *Primijenjena statistika*, Osijek: Sveučilište u Osijeku - Odjel za matematiku.
- Ivandija, T., and B. Marić. 2010. *Podjela vina*. Glasnik zaštite bilja.
- Ivanković, M., and A. Kolega. 2016. *Marketing vina*. Mostar: Sveučilište: Hrvatska akademija za znanost i umjetnost (HAZU) u Bosni i Hercegovini.
- Meler, M. 2003. *Neformalni marketing*. Osijek: Sveučilište J. J. Strossmayera u Osijeku, Ekonomski fakultet u Osijeku.
- Meler, M. 2002. *Marketing*. Osijek: Sveučilište Josipa Jurja Strossmayera, Ekonomski fakultet u Osijeku.

# The role and significance of color when choosing cars

Lidija Mandić <sup>1,\*</sup> and Maja Strgar Kurečić <sup>1</sup>

<sup>1</sup> University of Zagreb Faculty of Graphic Arts, Zagreb, Croatia; lidija.mandic@grf.unizg.hr, mstrgar@grf.hr

\* Corresponding author: lidija.mandi@grf.unizg.hr

## Abstract

The research was conducted in two steps; an online survey to determine how people choose color for car and whether they are willing to allocate more financial resources to get the desired color. The second part of the research was carried out at certain traffic locations of the city of Zagreb where it was examined which colors of cars were most presented. The results obtained in the online survey as well as collected data were compared with the research carried out by BASF, analyzing the color distribution on the European car market. The results coincide with the study conducted by BASF, black, white and gray are the dominant colors.

**Keywords:** *color, car, color experience*

## INTRODUCTION

At the beginning of serial production of cars, color didn't play a role in the decision to buy a car. In the early 20<sup>th</sup> century, the first cars were produced mostly in darker color variants, the dominant color was black. In the middle of the 20<sup>th</sup> century, bright and vivid colors prevailed, while today customers are mostly choosing achromatic colors. Recently, metallic colors or colors with additional effects predominate. As the automotive industry has developed through history, the customer show needs for new and more pleasing colors. Today, car companies offer seemingly endless color choices, so even the most discerning customers can find the color for themselves. From traditional standpoints like black and gray to unusual colors like purple, orange and yellow, car manufacturers are doing everything in their power to attract potential customers with their products. The existence of a wide range of color palettes raises the question of whether the consumer will choose a color of car based on a simple choice of color or whether the choice of color will reflect his psychology (Becker 2016). It has been proven that people have certain mental and physical reactions when experience colors Fehrman and Fehrman (2004). Difference in cultures also affect the experience of color. In western culture, white signifies purity and innocence, while in China and India is associated with death.

The research conducted with an online survey and collecting samples of cars on the streets with the aim of whether the preferences of customers regarding car colors are reflected in their car purchase. The obtained results were compared with the European research conducted by BASF.

## COLORS THROUGH CAR HISTORY

With the mass production of cars, color did not play a significant role in buying cars. In the early 20<sup>th</sup> century, the first cars were produced mostly in dark colors, mostly dominated by black. Henry Ford's famous sentence was: "You can buy a Ford model T in any color as long as it's black." However, the first few years of production (1908-1913.) were produced in gray, red and green [www.shutterstock.com](http://www.shutterstock.com) (2019). Blue and green colors were so dark that they looked more like black than blue and green. The black paint proved to be more durable, it was cheaper, more resistant to scratches and, thanks to nitrocellulose varnishes, it dried quickly, which enabled faster production of the car. At the time, Ford's goal was to produce a cheap and safe car that the average American worker would be able to afford.



After World War II, car industry developed quick and car buyers were looking for futuristic vehicles that were equipped with the latest technology. The cars had one or two colors and large chrome extensions. In 1995, over 1000 Ford car owners participated in the survey, the results confirmed that the most important characteristics were color and appearance of car. Some participants felt that light colors allowed greater visibility on the road, while others felt younger and more modern in colorful cars. There were customers who didn't like bright colors as well as chrome extensions. In 1954, Chrysler made two cars, Le Comte for men and Le Comtesse for women [www.allpar.com](http://www.allpar.com) (2020). Although based on the same Chrysler Newport vehicle, Le Comte had more masculine colors like bronze and black, and La Comtesse had more feminine colors such as pink and white.

In the 1970s, there was a shortage of fuel and a sense of ecology developed, cars become compact, earth colors prevailed (brown, olive green and beige). In the 1980s, there was an increase in sales of minivans and the most popular colors were black and red [www.classis-car-history.com](http://www.classis-car-history.com) (2019). The 1990s were a period of growth for SUVs.

BASF conducted a survey of what are the most popular car colors. BASF divided cars into 5 categories: small city and city cars, compact cars and sedans, luxury cars, sports cars and luxury cars. The goal of BASF's report is not just to uncover currently popular colors but to predict which colors will in vogue in the next few years.

## **RESEARCH**

The research was conducted in 2 steps with the aim of obtaining the results of the influence of colors on the car experience. The research was conducted at several intersections by counting cars and recording color in relation to the car class. Data collection was carried out in Zagreb on the main roads during traffic jams in order to collect as many cars as possible. Cars are divided to: small city cars, city cars, compact cars, sedan cars, caravans, minivans, coupe, SUV, luxury cars and sport cars. 1630 car class and color were collected.

The second part of the research was conducted through an online survey. 637 participants participated in online survey. The first few questions were general, about gender, age, color and type of car, etc. The remaining questions relate to the car type and color offered. Each question contained one class of car and the colors (same for each type of cars). Participants rated the most appropriate color on a 5-point scale (grade 1 doesn't match at all, grade 5 is excellent).

## **RESULTS**

By monitoring the traffic, the representation of small city cars was 125, city cars 377, compact cars 266, sedan cars 198, caravans 318, minivan 74, coupe 35, SUV 160, luxury cars 70, sports cars 7.

The results of obtained data are presented in Figures 1-5. together in comparison with BASF results. In the case of small cars, the largest presence of colors are white (26 %), red (16 %) and black (13 %). In the case of city cars, most colors refer to white (25 %), silver (24 %) and red (18 %). By monitoring the traffic of compact cars, the most cars were white (29 %), black (22 %) and silver (19 %). In case of sedan cars, silver color (31 %) is on first place, followed by black (21 %). In the case of caravans, silver is most present (35 %), followed by white (21 %) and black (18 %). It is similarly for rest of car types, expect for sports cars where black and red colors prevail.

The role and significance of color when choosing cars

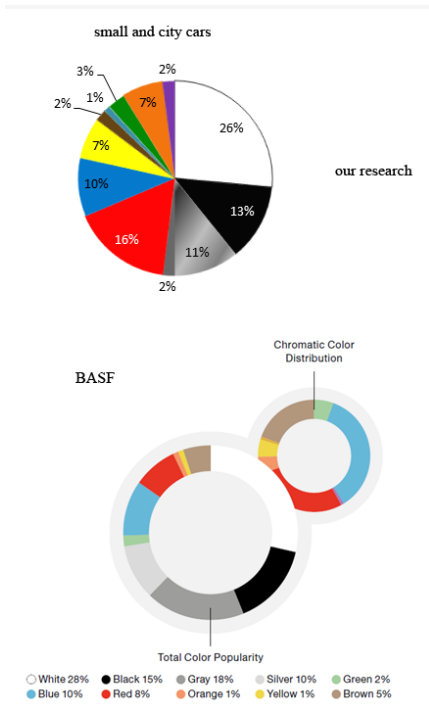

Figure 1: results comparison for small and City cars.

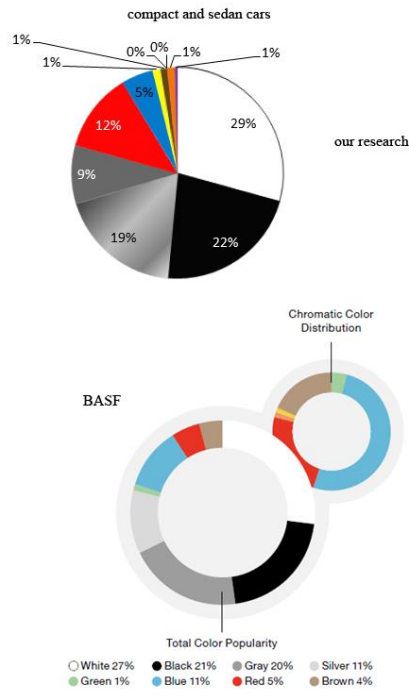

Figure 2: results comparison for compact and sedan cars.

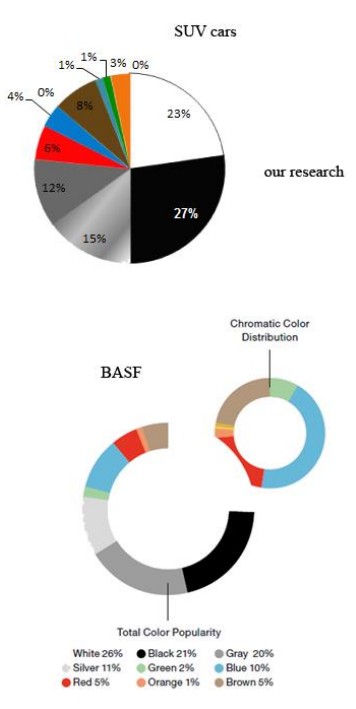

Figure 3: results comparison for SUV cars.

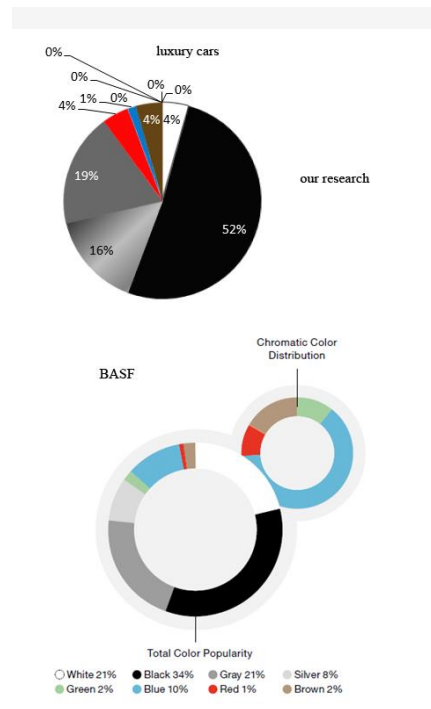

Figure 4: results comparison for luxury cars.

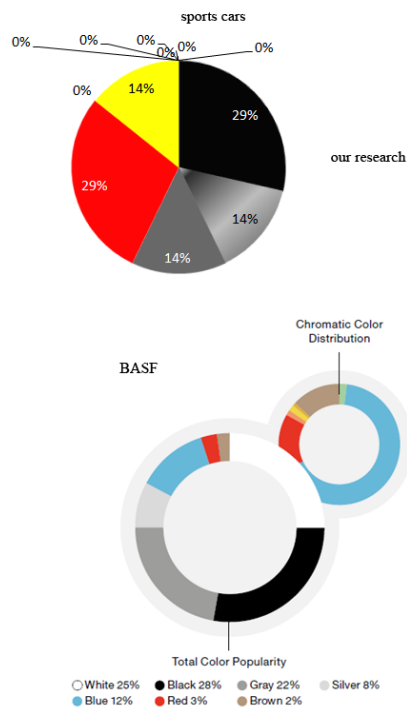

Figure 5: results comparison for sport cars.

The results compared to the studies conducted by BASF mostly coincide. Overall, white, black, gray and silver are still the most common colors. In small city and city cars, larger deviations are only present in gray and red. Differences in blue, red and gray have been noticed in compact and sedan cars. With luxury cars, there is a difference with white color.

637 participants participated in online survey, of which 76,5 % were women and 23,5 were men. Most of them were between ages 18-25 (70,2 %), followed by 26-30 (20,6 %) and 31-40 (4,4 %). Among all cars types they had to choose the one that met their needs. Most participants (30,3 %) answered that compact cars would suit them best, while 27 % chose city cars. For most participants (478), car represents a “need” for them, while for 441 of them it represents mobility. To the question “When choosing a car color, you are guided... “(multiple choice), most respondents (426) answered they choose a car with preferred color, while 249 of them choose based on existing experience (maintenance). The next question was about color they would choose for the car. In the first place with 41 % was metallic color, followed by ordinary color without additional effects (27,3 %) while in third place was matte color (21 %). More participants have black car, followed by gray and blue. When asked “Would you set aside an average of 500-1000 euros more for the desired color of the car, 65,1 % of participants answered that they are not ready to set aside that amount. Most respondents (30,9 %) participants answered that they would not buy old car with a color they don’t like. The following questions are similar for all types of cars and the offered colors were the same (shown in Figure 6).



Figure 6: example from an online survey: car class and colors offered.

The results for preferred colors for small cars are black and white, same for city cars, compact SUVcars. In the case of sedan cars, they preferred black and darkgray, the same for caravans. They preferred black, white, darkgray and silver for minivans. For coupe they preferred black and red color, while for luxury and sports cars black and silver.

## CONCLUSION

Two research were conducted in order to determine whether customers are guided by their color preferences when buying a car or not. The first research involving counting cars at intersections in Zagreb during times of traffic jam. City, compact and caravan cars have been shown to predominate on the road. The most common car colors were white, black and gray. In an online survey, respondents answered that when buying a car, they are guided by the preferred color, although they choose black, white and silver for different types of cars. This is probably due to the ease of car maintenance. They like cars with metallic colors the most, but they wouldn't spend extra money to get the color they want. Although brightly colored cars or a combination of 2 colors can be seen today, they are still in the minority

## REFERENCES

- Becker, D. 2016. *Color Trends and Selection for Product Design: Every Color Sells A Story*. William Andrew.
- Fehrman, K. R., and C. Fehrman. 2004. *Color: The Secret Influence* (2nd Edition). Pearson College Div. <https://www.shutterstock.com/blog/car-design-thought-history>, Accessed December 12, 2019.
- <https://www.allpar.com/model/lafemme.html> Accessed January 14, 2020.
- <https://www.classis-car-history.com/classic-ini-history.html> Accessed December 16, 2019.



# Why do people choose their car colours?

Peihua Lai <sup>1,\*</sup>, Boshuo Guo <sup>1</sup> and Stephen Westland <sup>1</sup>

<sup>1</sup> University of Leeds; ss17pl@leeds.ac.uk, b.guo1@leeds.ac.uk, s.westland@leeds.ac.uk

\* Corresponding author: ss17pl@leeds.ac.uk

## Abstract

Successful colour forecasting enables companies to provide suitable products to the right customers. Generation Y are significant customers in vehicle markets. Understanding relevant factors on young customers are essential for companies and can help them fine-tune their products' colour for specific demographic groups. However, consumer preference for colour could depend on various factors, including trends, age, gender, income and more. In the automotive industry, automotive exterior colour is a critical decision. The choice may be more considered because the consumer will likely be living with that colour for many years daily. Despite this, few studies have investigated the factors that drive customer selection of automotive colours. Thirty-three participants from generation Y were invited to take an online survey designed to get their ideas on various factors that can influence their car colour decision. Personal preference and ease of maintenance are two main aspects of their automotive colour selection. This study looks into the effects of relevant factors on the colour of cars. It can encourage more research in the field of colour forecasting in the automotive industry.

**Keywords:** *automotive colour, colour forecasting, generation Y, car purchase intention*

## INTRODUCTION

Colour can affect purchasing behaviours; effective colour forecasting enables companies to provide products with suitable colours for customers at the right time (Diane and Cassidy 2005). Colour information in the fashion industry changes quite rapidly and there are many different independent colour forecasting agencies (e.g., Pantone and WGSN) in addition to forecasters working within manufacturing and retail organisations. By contrast, colour forecasting in the automotive industry is more limited. Only a few paint companies deliver automotive colour forecasting reports each year, including BASF, Axalta and PGG. Nevertheless, practical colour information is economically important to enable automotive companies to produce successful products.

Customers may take longer to decide about the exterior colour of automotive than with other products. This is because some purchases have very limited use (e.g., fast fashion) and/or are less expensive so that consumers can afford to take more risk. On the other hand, consumers live daily with their choice of automotive exterior colour for many years. Exterior colour could also affect future resale values.

Despite this, few studies have investigated the factors that drive customer selection of automotive colours specifically. Personality is one of the most frequently cited elements influencing car colour choice (Andrews et al. 2006; Dwivedi 2015). Emotion-colour correlation plays a role as well (Powers and Power 2006; Zhang et al. 2020). King (2003) summarised correlations between personality and automotive colour selections. In the UK, for example, red is more likely to be chosen by creative drivers, yellow car drivers are more likely to be energetic, whilst pink vehicle drivers are more likely to be victims of road rage than drivers of other colours. Automotive colour selection may also be influenced by geography and social movements (Oliver and Lee 2010; Jun and Bo 2012; Kowang et al. 2018). Factors like price and brand (Kowang et al. 2018), how customers perceive themselves (Oliver and Lee 2010), colour appropriateness for particular vehicle types (Hanss et al. 2012) and patriotism (Mustafa et al. 2020) have all been suggested to influence automotive colour selection.

The majority of studies on the influence of factors on automotive colour selections concentrate on the general population. Few studies have looked into the intentions of young customers when it comes

to purchasing a vehicle (Mustafa et al. 2020). In today's automotive industry, Generation Y is the most prominent customer demographic (Dewalska-Opitek 2017). Compared to other demographic groups, generation Y customers are more willing to accept new technology and trends. Because of technological advancements, they now have access to internet information, and the opinions of other consumers may affect their colour choices (Weiler 2004). New graduates and young customers from generation Y act differently on their values, attitudes and vehicle purchased behaviours (Dewalska-Opitek 2017).

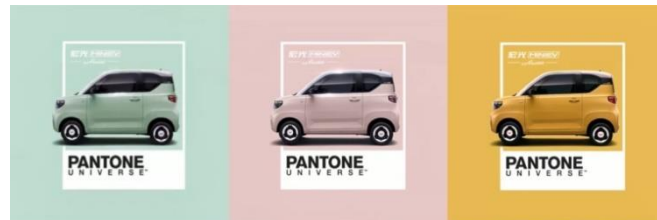

Figure 1: Images of Wuling Mini EV Macaroon collection.

In recent years, the automotive market has grown rapidly in China. Cars are now much more affordable, even for young consumers, than even one or two decades ago. Along with the advancement of automobile engines and performance, aesthetics strongly influences consumer purchase intent (Kumar and Sarkar 2016). Exterior colour will undoubtedly influence a consumer's choice of purchase (Jun and Bo 2012). As a result, automotive companies have shown a growing interest in colour trends in marketing. For instance, China's leading automotive company Wuling launched a new series called Mini EV Macaroon in 2021 (see Figure 1), with colour forecasting agency Pantone. Avocado green, lemon yellow and white peach pink were chosen for their new microcars— with similar colours to those in the Pantone 'Colour of the year' report (Gijsenij et al. 2021).

This study investigates automotive colour preferences of Chinese generation Y customers to enable companies to better understand China's Generation Y's purchasing patterns.

## **METHODS**

A total of 33 Chinese participants born between 1980 to 1995 completed an online survey. The survey was designed to identify factors that might influence young consumers' decisions on automotive colour selections and aimed to measure attitudes towards colour trends for automotive exterior colours.

The research focuses on the aesthetics of a vehicle, which includes the shape and automotive colours. Participants were asked about their preferences for their first (the first car they purchased or intend to purchase) and second (meaning the car they would like to buy in the future) cars as well as some general preference questions such as attitude towards automotive colour trends. The rationale for asking about first and second cars was that the second car is more aspirational and the first car is more practical since the second car could be a car that the consumer cannot currently afford but would aspire to own.

## **FINDINGS**

Young consumers have different vehicle type preferences between their first car and second car (see Figure 2). Although SUV was the most frequent choice for the first vehicle selections, the choice of the second car was less clear but with some shift towards 4WD and Coupe vehicles.

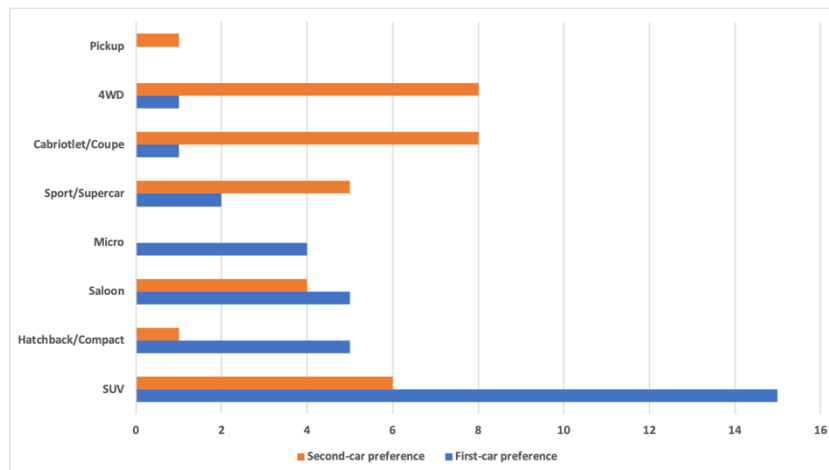

Figure 2: Respondent preferences on car type for their first car and second car.

When asked about colour preferences, there was a strong preference for black (when asked about the first car) but a relative increase towards colours such as red for the second car (Figure 3). As various colours suit different types of vehicles (Hanss et al. 2012), understanding whether customers are buying their first or second car may help better understand the colour preferences of consumers.

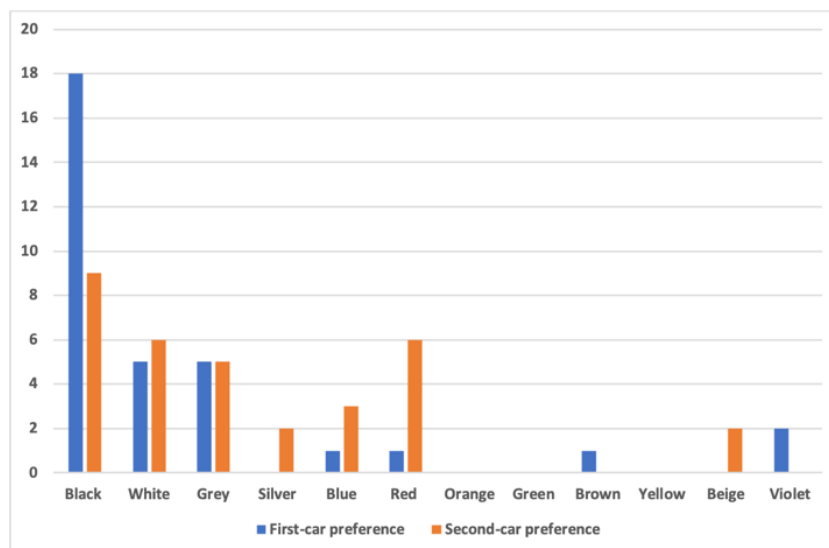

Figure 3: Respondent preferences on automotive exterior colour for their first car and second car.

When asked what features are important to them for their 'dream' car comfort and safety were strongly cited (Figure 4). Similar to other generations, safety is a priority although consumers may not be aware that dark-coloured cars are more likely to be involved in accidents than light-coloured cars (Ho et al. 2017). Quality and trendy are also concerns for generation Y consumers.





Figure 4: Word cloud of responses about important features in consumers' ideal car.

Figure 5 shows the colours that consumers associate with luxury and trendy cars. Over 70% of the consumers associated black with luxurious cars whereas for trendy cars there was more variability in the responses. Some of this variability might be related to individual consumer's ideas about what is a trendy car.

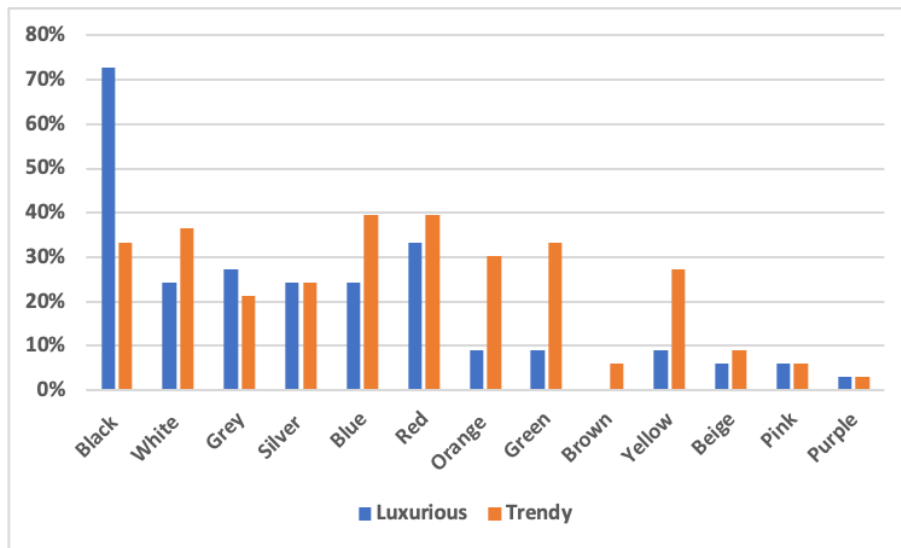

Figure 5: Colours that consumers associate with luxurious and trendy cars.

Over half of young consumers (58%) in the research mentioned the personal preference would affect their colour decision. Previous research supports the importance of personal preference in choosing colour for products (Lee, Westland, and Cheung 2018). Another distinctive aspect of automotive colour selections (58% of responses) is the ease of maintenance. One of the benefits of easy-to-care automotive colours could reduce cleaning efforts (darker coloured cars do not show dirt as easily light coloured ones). 18% of young consumers expressed concern about safety and other comments in their colour selections. Surprisingly, only a few consumers mentioned price factors in automotive colour selections.

## CONCLUSION

In terms of engines and performance, the automotive industry has advanced significantly in recent decades. As a result, car aesthetics have become an essential component in the purchase process. General factors such as age, region, income and resale prices appear to be insufficient predictors of consumer interests in car selections. However, the existing system with machine learning algorithms could help predict car purchased intention with general factors like price, customer reviews, resale price (Das Mou et al. 2021). Furthermore, with inspiration from the research, a better forecasting system could be designed to better fulfil young customers' needs.

Personal preference and ease of maintained are two dominant elements that influence Chinese Gen Y customers when choosing automotive colours. Balancing these two factors and methods to collect personal preference information for each customer still needs further exploration. However, the obvious shortcoming of this study is that the amount of data is small, which leads to a certain limitation. In addition, a more diverse group of participants could add in future research.

## REFERENCES

- Andrews, D., P. Nieuwenhuis, and P. D. Ewing. 2006. Black and beyond - Colour and the mass-produced motor car. *Optics and Laser Technology* 38(4-6): 377-391.
- Dewalska-Opitek, A., 2017. Generation Y consumer preferences and mobility choices—an empirical approach. *Archives of Transport System Telematics* 10.
- Diane, T. and T. Cassidy. 2009. *Colour forecasting*. John Wiley & Sons.
- Dwivedi, N. and R. Mehrotra. 2015. Influence Of Personality Dimensions and Aesthetic Orientation on Consumer'S Colour Preference During Car Purchase. *Voice of Research* 65.
- Gijzenij, A., M. Vazirian, E. Kirchner, P. Spiers, P. Lai, S. Westland, and P. Koeckhoven. 2021. Analyzing a decade of Colors of the Year. *Color Research & Application*, 46(1): 258-270.
- Hanss, D., G. Böhm, and H. R. Pfister. 2012. Active red sports car and relaxed purple–blue van: affective qualities predict color appropriateness for car types. *Journal of Consumer Behaviour*, 11(5): 368-380.
- Ho, T. H., J. K. Chong, and X. Xia. 2017. Yellow taxis have fewer accidents than blue taxis because yellow is more visible than blue. *Proceedings of the National Academy of Sciences*, 114(12): 3074-3078.
- Jun, M., and Z. Bo. 2012. Study on Forecasting Model for Popular Vehicle Exterior Colors in Future Chinese Vehicle Market. *Agricultural Equipment & Vehicle Engineering* 2.
- King C. (2003 January19) Reported in Now that's a daft colour, James Foxall, the Sunday Times, 2003.
- Kowang, T.O., S. A. Samsudin, L. K. Yew, O. C. Hee, G. C. Fei, and C. S. Long. 2018. Factors affecting car purchase intention among undergraduates in Malaysia. *International Journal of Academic Research in Business and Social Sciences* 8(8): 80-88.
- Kumar, B. and P. Sarkar. 2016. Prediction of future car forms based on historical trends. *Perspectives in Science* 8: 764-766.
- Lee, G., S. Westland, and V. Cheung. 2018, December. Effective Colour Communication. *In Proceedings of the International Colour Association*, 517-522. AIC.
- Mou, A. D., P. K. Saha, S. A. Nisher, and A. Saha. 2021, February. A Comprehensive Study of Machine Learning algorithms for Predicting Car Purchase Based on Customers' Demands. In: *2021 International Conference on Information and Communication Technology for Sustainable Development (ICICT4SD)*, 180-184. IEEE.

- Mustafa W. M. W., M. A. M. Kassim, M. S. Abdullah, and A. K. Yahya. 2020. For the Love of National Cars: Understanding Generation Y's Intention to Purchase Malaysia Local Wheelers. *Journal of Social Science and Humanities* 3(5): 08-12.
- Oliver, J. D., and S. H. Lee. 2010. Hybrid car purchase intentions: a cross-cultural analysis. *Journal of consumer marketing*.
- Powers, K. 2008. *A Psychophysical Approach to Assessment of Relationship Between Vehicle Color and Purchase Price*. ACR North American Advances.
- Weiler, A. 2004. Information seeking behavior in Generation Y students: motivation, critical thinking, and learning theory. *Journal of academic librarianship* 31(1): 46-53.
- Zhang, X., M. Yang, J. Su, W. Yang, and K. Qiu. 2020. Research on product color design decision driven by brand image. *Color Research & Application* 45(6): 1202-1216.

**SPECIAL SESSION**

**INNOVATION AND RESEARCH IN COLOR FOR  
BEAUTY CARE AND HAIRSTYLE**

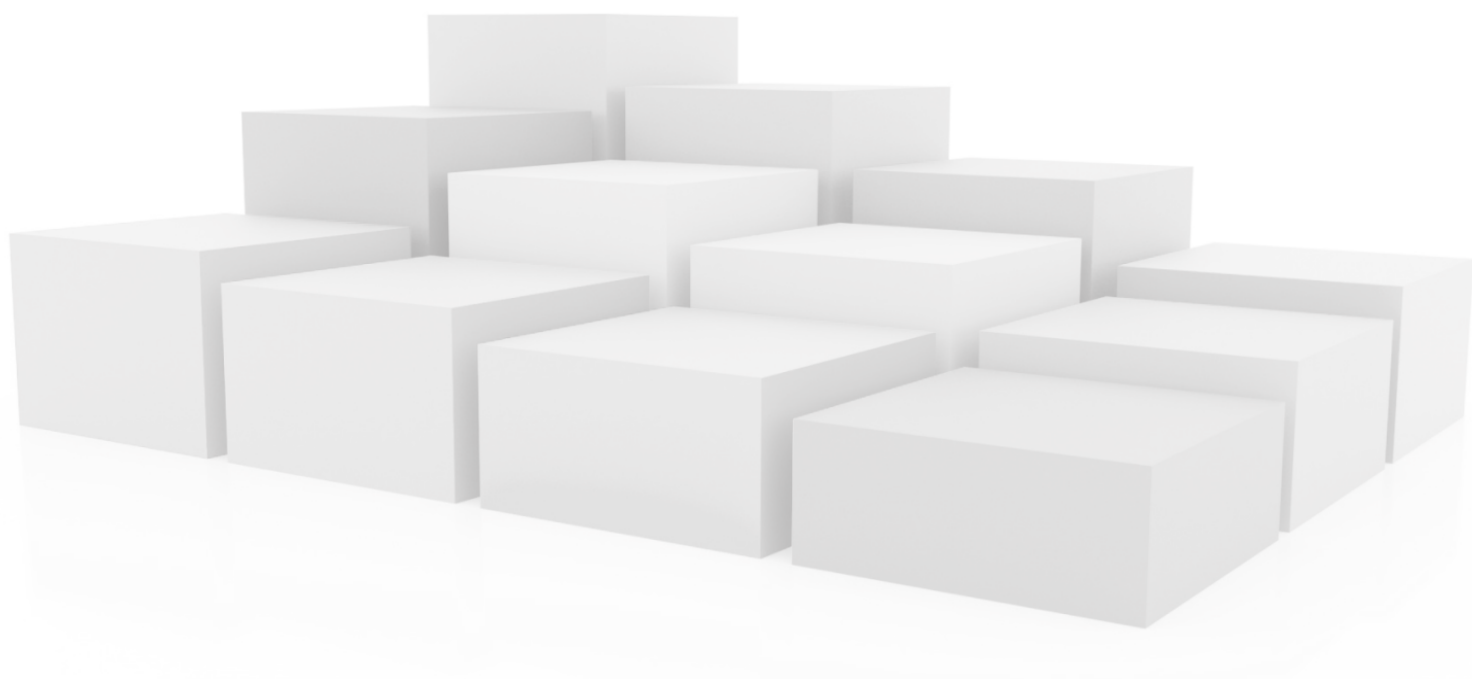

AIC 14<sup>th</sup> Congress Milano 2021 - August 30<sup>th</sup>– September 3<sup>rd</sup> 2021



# History of colours and beauty

Christine Fernandez-Maloigne <sup>1,\*</sup>

<sup>1</sup> Université de Poitiers, XLIM Laboratory, UMR; christine.fernandez@univ-poitiers.fr

\* Corresponding author: christine.fernandez@univ-poitiers.fr

## Abstract

History, sociology, psychology, styling, decoration, many fields are interested in the symbolism of colors and as proof, the incredible number of books devoted to it! Why such an interest in what seems rather superficial? Because after reflection, the language of colors, what they are capable of inspiring us, of making us feel, the behavior they can induce is far from negligible and perhaps even much more important than what we usually think. Thus, since the dawn of time, men and women have sought to enhance their beauty through the use of makeup and it is likely that prehistoric men already practiced body painting. So, want to put yourself on your best for an interview, a date? There is no doubt that choosing your colors well can be wise! So we will retrace the history of makeup over the centuries and take a look at the language of colors for beauty!

**Keywords:** *colors and beauty, history of colors, language of colors, makeup history*

## INTRODUCTION

Numerous books have examined the beauty of colours and their language. Is our brain predetermined to like certain colour contrasts, while others do not stimulate it at all? Artists, scientists, neuroscientists and enlightened art lovers regularly ask themselves this question and some develop theories on the subject. It's not by chance that stores, advertisements, decorators, artists carefully choose their colors, these instruments that are said to have psychological and physiological power over human beings... India, China, Egypt, Italy, Greece, had in antiquity their symbolism of colors, symbols often intimately linked to religion and expressed through the stained glass windows of cathedrals, paintings of Egyptian temples, representations of divinities among many peoples and tribes such as the Mayas, the Aztecs or the Incas. The Japanese, for their part, recognize delicate meanings in each color "beyond what man can describe." Obviously, according to the times, civilizations, places, the language of colors changes, is sometimes different or even contradictory, but grasping the main trends attached to different colors can give us an overview, a business card, in a way, of each color that make up our daily lives. In particular, since the dawn of time, men and women have sought to enhance their beauty through the use of makeup and it is likely that prehistoric men already practiced body painting. So, want to put yourself on your best for an interview, a date...? There is no doubt that choosing your colors well can be wise! I suggest you to retrace the history of makeup over the centuries and to take a look at the language of colors for beauty!

## A LITTLE BIT OF HISTORY

### Antiquity

The use of make-up is a practice that goes back thousands of years: if the earliest written traces can be found in the Bible, archeology has found accessories and cosmetics dating back to 10000 BCE. Cosmetics are an integral part of Egyptian hygiene and health. Men and women in Egypt use scented oils and ointments to clean and soften their skin and mask body odor. Oils and creams are used for protection against the hot Egyptian sun and dry winds. Myrrh, thyme, marjoram, chamomile, lavender, lily, peppermint, rosemary, cedar, rose, aloe, olive oil, sesame oil, and almond oil provide the basic ingredients of most perfumes Egyptians use in religious rituals.

3000 years before our era, the Egyptians put their eyes in value with kohl, which was made from soot or lead, red lip and cheek makeup from mineral red like poppy and henna to color the nails... And

they were already applying carbonate of lead also called white lead on the face to whiten the skin. White, a symbol of purity, has also long been a criterion of beauty for women's skin. The kohl also had the function of protecting the eyes from the rays of the sun and conjunctivitis.

At the same period, the Chinese stain their fingernails with gum arabic, gelatin, beeswax, and egg. The colors are used as a representation of social class: Chou dynasty royals wear gold and silver, with subsequent royals wearing black or red. Lower classes are forbidden to wear bright colors on their nails. Regarding Greece, the women paint their faces with white lead and apply crushed mulberries as rouge. The application of fake eyebrows, often made of oxen hair, is also fashionable.

In 1500 BCE, Chinese and Japanese citizens commonly use rice powder to make their faces white. Eyebrows are shaved off, teeth are painted gold or black, and henna dyes are applied to stain hair and faces.

In 1000 BCE, Grecians also whiten their complexion with chalk or lead face powder and fashion crude lipstick out of ochre clays laced with red iron. In fact, at the beginning of our era, it was the caravans bringing spices and silk to Europe that made make-up products known in Greece and throughout the Roman Empire. In ancient Greece, especially in Athens and Sparta, this practice was originally forbidden to respectable women and reserved for courtesans. But under the Roman Empire, the patricians, part of the nobility, of the privileged class, devoted a lot of time to their toilet, their hairstyle and their make-up.

Ovid, Latin poet and ancient star of the makeover, has written a treatise on this subject in which he gives the coquettes of his time many beauty tips and recipes. Ovid distills his advice through his books and through word of mouth, an ancient communication system operating on the principle of what we now call social networks! But if Ovid thought that "you would be ashamed of too white skin", and recommended a tanned skin reflecting athletic activities performed outdoors, among the Greeks as among the Romans, a mask made from barley powder, honey and egg was intended to lighten the complexion. The white was the color of the nobles, those who do not work. Moreover, the eyebrows were blackened with charcoal.

In the 1st century, it was also fashionable to lighten your skin with white lead and chalk, to underline the eyes with a line of kohl and to enhance your complexion and lips with red. In addition, in ancient times, the theory of zoomorphism appeared, according to which each man corresponds to an animal. Redheads were automatically associated with the fox, reputed to be deceitful, and with pigs (whose hair is red), reputed to be dirty and lecherous. In Egyptian mythology, the god Set, the murderer of his brother Osiris, was described as "impious, violent and red-haired". The colour blonde, in its various shades, preferred to any other, appears, since Antiquity, as emblematic of aesthetic perfection; "compared to the light of the sun, opposed to the darkness of a moonless night, it symbolises, it seems, an ideal of purity and innocence on the religious, moral and aesthetic level".

Later, between 300 and 400, Henna was used in India both as a hair dye and in mehndi, an art form in which complex designs are painted on the hands and feet using a paste made from the henna plant, especially before a Hindu wedding. Henna is also used in some North African cultures.

### **The Middle Ages**

From 476 to 1492, the Crusaders brought makeup to Northern Europe from the 12<sup>th</sup> century. From the 13<sup>th</sup> century, the nobles used foundation, hair dye and perfume. Perfumes are first imported to Europe from the Middle East as a result of the Crusades, around 1200. Women use flour, white coral and white lead to whiten their complexion. In Elizabethan England, dyed red hair comes into fashion. Society women wear egg whites over their faces to create the appearance of a paler complexion. Some

people believe, however, that cosmetics blocked proper circulation and therefore pose a health threat. In France, make-up is condemned by the church because it is a symbol of lust. The perfect woman should be slim and slender, have white skin, and be blonde. Prostitutes had to have "carrot" hair to be recognized: in 1254 Saint Louis promulgated an edict to force prostitutes to dye their hair red to distinguish them from "respectable women". This color was obtained with saffron or madder (*Rubia tinctorum*).

Generally speaking, red hair was a sign of connection or trade with the devil, as well as witchcraft. Indeed, it was believed that people with red hair vowed their souls and bodies to the devil, and that, burnt by the flames of Hell, their hair became the colour of embers. Moreover, in the Middle Ages, green was the colour of Satan, the devil, the enemies of Christianity, strange beings: fairies, witches, goblins, wood and water genies. Thus, redheads with green eyes often ended up at the stake....

### **The Renaissance**

From 1492 to 1610, the ideal of female beauty was to have a diaphanous complexion, red lips, cheeks, fingernails, and golden hair. To obtain a Venetian blond, women coated their hair with a mixture of saffron and lemon and exposed their hair to the sun. In addition, men and women of the bourgeoisie powdered their faces with white lead and red ocher and tinted their lips with tincture of cochineal.

During the 16<sup>th</sup> century, Queen Elizabeth I of England made bright shades of rouge popular. Before then, medieval Europeans believed that makeup – particularly red lips – warned of death. In parallel, Italy and France emerge as the main centers of cosmetics manufacturing in Europe, and only the aristocracy has access. Arsenic is sometimes used in face powder instead of lead. The modern notion of complex scent-making evolves in France.

Early fragrances are amalgams of naturally occurring ingredients. Later, chemical processes for combining and testing scents surpass their arduous and labor-intensive predecessors.

### **The Old Regime**

From the 17<sup>th</sup> century, the use of make-up extended to all social classes. While in the 18<sup>th</sup> century, red was abused and even painted to sleep, the 19<sup>th</sup> century was marked by a certain return to nature. The era of modern times begins with Charles VII, nudity becomes aesthetic, especially thanks to art. The criteria of beauty have changed somewhat, the woman must have curves, but not too much anyway, to be beautiful, but still fair skin and blond hair if possible. The eyes and eyelashes are made up with black antimony, highly toxic (cousin of arsenic in the form of crystals), vermilion is worn on the lips, nails and cheeks, for the nobles of course. It should be noted that in order to have blond hair like the Italians of the time, women coat their hair with saffron and lemon and then stay in the sun for hours. During the time of Louis XIV, all kinds of devices were used to look good and appear clean. the fashion was porcelain complexion, white lead, with fake moles, flies. These flies on the face, initially used to camouflage pimples and scars due to smallpox, after the discovery of the vaccine for this disease in 1796, remain an essential aesthetic element.

But at the end of the 19<sup>th</sup> century, Queen Victoria publicly declares makeup improper. It is viewed as vulgar and acceptable only for use by actors. If Queen Victoria frowned upon the wearing of makeup, the young women of the day were not deterred, and early feminists started painting their lips crimson as a symbol of emancipation.



## Modern Times

In Edwardian Society, pressure increases on middle-aged women to appear youthful while acting as hostesses. As a result, cosmetics use increases, but is not yet completely popularized. At the start of the 20th century, industrialization allowed the reign of modern cosmetics to begin. This is the era of the cultural revolution with cinema and vamps: actresses-muses inspire women and serve as their models. Modern make-up has its origins in theater and cinema, and was initially used to see oneself from afar: it was heavy make-up to mark the features, in bright colors.

Afterwards, makeup developed with the general public to become more accessible and wearable. From 1930, the fashion was to have a tanned complexion. But it is always said that men prefer blondes!

During the second world war, lipstick was the only cosmetic not rationed, as British prime minister Winston Churchill believed it boosted morale. The decades after the war saw lipstick continue to dominate the cosmetics market, with movie sirens from Egypt to Hollywood favoring a bold pout. Samia Gamal danced her way across the silver screen with a bold flush of blush, and it is said that 98% of women in the US were wearing lipstick by that time, probably encouraged by Hollywood sirens like Marilyn Monroe and Elizabeth Taylor. Note that, since this time, the United States has been at the forefront of cosmetics innovation, entrepreneurship, and regulation.

## **A SCIENTIFIC LESSON IN MAKE-UP**

With my red hair and green witchy eyes, let me give you some tips for your next business or private appointment! Because this is not witchcraft! On the contrary! When it comes to makeup, it's easy to forget the importance of the science behind it when you're distracted by the latest shiny pigments or trendy applications. Don't get me wrong, there's obviously room for that too! However, nothing is more important than a scientific understanding of colour. So, let me explain to you very seriously that to choose a make-up harmony, you have to consider: the colour of the iris; hair colour; skin tone ; the colour of the clothes.

### **Iris colour**

Two notions are essential to highlight the eyes:

- Make maximum use of contrasts (light/dark)
- Avoid using the same shade and value of make-up on the eyelid as on the iris (dull the eyes).

Apart from this advice, the choice of colours is left to your appreciation and artistic sensitivity.

### **Hair & skin tone colour**

Wherever possible, the harmony of hair colour and skin tone is respected.

- hair colour = Black, Brown, Dark Chestnut, Light Chestnut  
shades = Violet, Blue, Ash (blue green)  
harmony = cool
- hair colour = Dark Blonde, Light Blonde, Red, Grey White  
shades = Golden (yellow), Copper (orange), Mahogany (red)  
harmony = warm
- complexion = Black, half-breed  
shades = olive green, grey  
harmony = cold

- complexion = Copper yellow (Asian), Matte (Mediterranean), Clear (Central Europe), Diaphanous (Northern Europe)
  - shades = Rose, Red, Gold, Copper
  - harmony = warm

### **Influence of light on make-up.**

As we have seen, light creates colours. This is why the quantity (intensity) and quality (warm or cold) of the light transform the rendering of colours and therefore the make-up. This theory is the basis of the distinction between the different types of make-up (day, evening, cocktail).

Memo: A colour is relative, never stable and definitive, since it only exists through light, which varies.

#### *A. Natural light produced by the sun*

It is often white, but it varies during the day and the seasons: bluer in the morning and more yellow in the afternoon. In full daylight, colours are saturated and reflect fully and intensely (daylight make-up). But daylight remains the ideal source of light for putting on make-up,

#### *B. Artificial light*

To apply make-up and to bring out the best in your complexion, it is necessary to have diffused and homogeneous lighting. It is also preferable to use white light, the ideal being to use daylight type bulbs. LED light is also a good idea. It is important not to use coloured bulbs in the bathroom if you want to get good lighting for make-up! As far as lights are concerned, beware of using ceiling lights, as the light comes from above and you end up with shadows on your face.

### **Clothing colour**

Clothing and accessories greatly influence the choice of colours and make-up style. Generally, we take inspiration from one or more colours present in the outfit, thus creating an overall harmony.

White and black, neutral colours, allow all harmonies. However:

- A white or light outfit intensifies the make-up. It is therefore wise to choose soft, pastel shades (bridal make-up).
- On the other hand, the intensity of the make-up is weakened by a black or dark outfit. Therefore, the use of brighter and more luminous shades is required.

Finally, let us note the concepts generally associated with colours, which can inspire the choice of your outfits.

- Black: power, evil, death and mystery.
- Grey: security, authority, maturity and stability.
- Purple: royalty, luxury, wisdom and passion.
- Yellow: joy, energy and warmth.
- Red: danger, boldness, urgency and energy.
- Blue: peace, calm, confidence and affection.
- Green: life, growth, freshness and healing.
- White: hope, purity and light.

## **CONCLUSION**

Wearing colour means existing, sending a strong social signal to others! 'Look at my face', said Louboutin. And the appetite for pigments is constantly growing, especially today for the eyes, which alone protrude from our health masks. We are all addicted to colour, that warms and rejoices in our time of crisis: just look at the make-up collections! Colour seduces, protects, reassures. The cosmetics industry is adapting to this: today's eye shadows have nothing in common with their ancestors.

Over the past three years, the success of nail polish, driven by nail art, has caused the sector's figures to soar. The cosmetic displays are all brighter, like peacocks to seduce the customer. There is no doubt that our appetite for colour is growing, and not just on our fingertips. The proof: the Dutch photographer Marcel Christ explodes pastel pigments on his pictures, symbolising a strong trend in contemporary art. In Paris, the Color Run, a race in which participants spray themselves with coloured powder, was a hit in one day. These events are also developing in our universities.

Beyond these one-off events, make-up has become a daily game. The popularisation of colour - frank, bright, in short, visible - has reached a new level. And colour has become a key factor in innovation. Like the big fashion houses, brands are bringing out a range per season, and multiplying cruise collections and limited editions. The beauty sector - tiny in terms of volume - is one of the most innovative in the global pigment market. The arrival of pearlescent colours on car bodies, for example, is a simple transfer of technology from cosmetics. If we are not witnessing a technological revolution, there are many innovations. Light is at the center of research. Suppliers are now able to produce purer, less opaque pigments. Flat, thin pigments are created that sit like a puzzle on the skin. They are perfect for the new generation of foundations. These advances accompany and facilitate creative proposals, which are ever more seductive. Colour can be dared as a new accessory, a real choice.

And so we can conclude by saying that we are more fashionable than ever by participating in AIC!

## **REFERENCES**

- Eckstut, J., A. Eckstut. 2013. *Secret Language of Color: Science, Nature, History, Culture, Beauty of Red, Orange, Yellow, Green, Blue, & Violet*, Black Dog & Leventhal; Illustrated edition.
- Gerbod, P. 1995, *Histoire de la coiffure et des coiffeurs*, sept. 1995, 383 pp., 495 F.
- Ovide. 43 BC. *Les Fards ou Soins du visage*, traduction française de M. Heguin de Guerle - M. F. Lemaistre. 1927. *Ovide. L'Art d'aimer*, Paris, Classiques Garnier
- Taggart, E. 2018. *The History of the Color Blue: From Ancient Egypt to the Latest Scientific Discoveries*.

# A comparative study of lipstick shades preferences by geographical areas

Hélène de Clermont-Gallerande <sup>1,\*</sup>, Emmanuelle Mauger<sup>1</sup>, Nicolas Rolland <sup>1</sup>

<sup>1</sup>CHANEL Parfums Beauté, Innovation, Recherche et Développement, 8 rue du Cheval Blanc CS40045, 93694

PANTIN Cédex, France;

helene.declermontgallerande@chanel.com, emmanuelle.mauger@chanel.com

nicolas.rolland@chanel.com

\* Corresponding author: helene.declermontgallerande@chanel.com

## Abstract

International cosmetics companies manufacture make-up products that are then sold in all countries where the brand is distributed. Lipstick ranges today each include about 30 shades and each brand offers several ranges with different effects of the make-up result. A couple of years ago, Chanel lipsticks provide 142 shades divided into several ranges: 34 classic lipsticks, 48 shiny lipsticks, 39 intense lipsticks and 21 matt lipsticks. It seemed to us worth looking too, at the 20 best-selling lipsticks by specific geographical area. So, the areas studied are not of comparable size because they are those where detailed sales figures are available. These areas are France, Italy, the UK, the USA, Asia and South America. The best sales per area are analyzed to establish shade preferences in each of these areas. A comparison then made it possible to establish the geographical areas whose lipstick color choices are closest.

**Keywords:** *Shades, Preference, Lipsticks, Color, Geographical area*

## INTRODUCTION

Before the health crisis induced by COVID-19, lipstick was the best-selling makeup product.

Although wearing a mask has drastically reduced lipstick sales, it remains the quintessential feminine attribute. CHANEL is one of the world's leading sellers of lipsticks. Like all international cosmetics companies, its products are sold in every country where the brand is distributed. However, where cosmetics are concerned, the success of a product is linked to the whole marketing mix (advertising, media communication, packaging, brand impact, texture and performance complaints) but, above all, to the color on offer. Therefore, CHANEL offers its customers a wide range of shades with the aim of appealing to women from all cultures, in all age ranges and of every style.

Like all CHANEL's makeup ranges, the lipstick lines are divided into two parts: firstly, a core range including iconic shades that are found all over the world, and secondly the freedom to use colors that respond to the needs and specific characteristics of the markets. We thought it would be interesting to study which were the 20 best-selling shades in each part of the world where CHANEL's products are distributed.

A couple of years ago, CHANEL offered 142 lipstick shades distributed over several ranges: 34 classic moisturizing lipsticks (Rouge Coco), 48 shiny, transparent lipsticks (Rouge Coco Shine and Rouge Coco Stylo), 39 intense lipsticks (Rouge Allure) and 21 matt lipsticks (Rouge Allure Velvet). The regions of the world studied are France, Italy, United Kingdom, USA and Asia. The geographical areas studied are not of identical size because Maison CHANEL compiles its figures by continent.

In this article, the best-selling lipsticks were analyzed to establish the favorite shades per region. The most similar geographical areas will thus be distinguished from the most dissimilar ones.

## MATERIALS AND METHODS

The color of the products was measured using an Xrite VS450 contactless spectrophotometer in the CIEL\*a\*b\* color space.

A mapping of the 142 shades was produced using a Principal Components Analysis (PCA) performed on the L\*, a\* and b\* parameters according to Jobson (1992). Afterward, to regroup products with similar shades, a clustering method was applied on the previous PCA components as described by Everitt et al. (2011). A response surface model using standard least squares was used to analyze the ranking in a specific market. The main effects of the model are the lipstick rank and the second order the geographical area.

The ranking of the 20 best-selling shades per country or continent at the end of the studied year was supplied by the company's marketing division, Chanel PB (2016). These results are based on sell-in figures, except for Asia where only sell-out figures were available. The product classified as N° 1, the most frequently sold, will then have 20 points. The points assigned will then decrease to 1. A shade which is not present in the 20 best-selling shades in a given region will therefore have a mark of 0. The color classification previously built was used to determine the shades unanimously liked all over the world and those which are more favored or even specific in a geographical area.

## RESULTS AND DISCUSSION

The lipstick color analysis is resumed on the figure 1. The first axis represents the a\* and b\* parameters. The lipsticks on the bottom left are darker. The one on the right are redder and yellower.

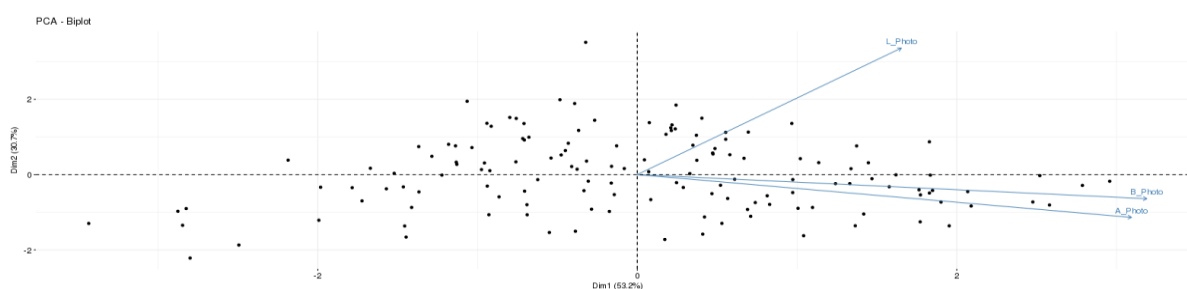

Figure 1: Simultaneous representation of the first factorial map of the PCA on lipsticks color parameters.

The classification led to obtain 8 clusters. To visualise the classification, the previous graph was rebuilt figure 2, using color of the lipstick and the shape corresponding to the classification.

A comparative study of lipstick shades preferences by geographical areas

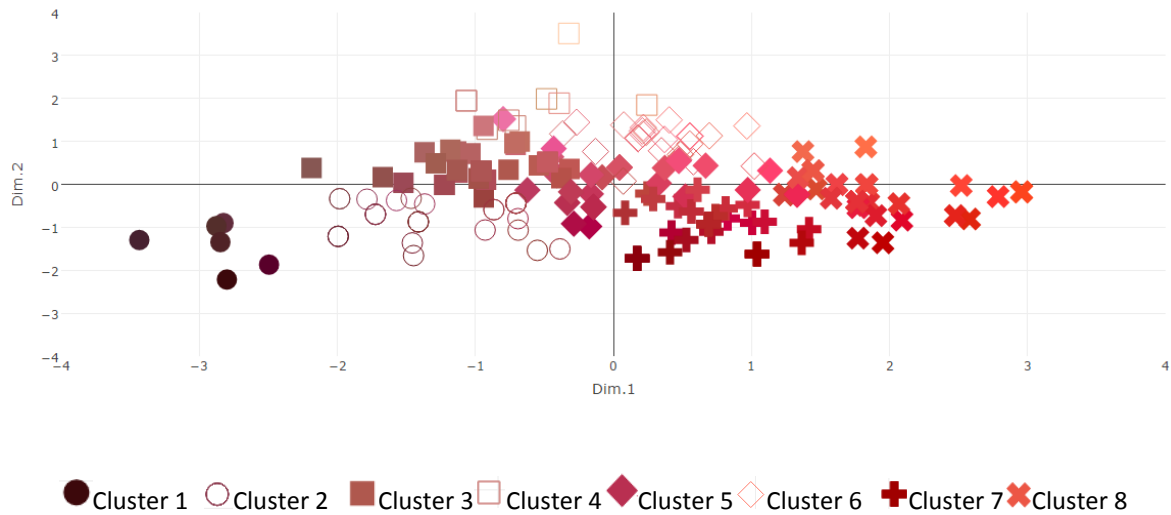

Figure 2: Graphic representation in the colorimetric space of the 142 shades offered by Chanel. The shape corresponds to the lipstick colors classification.

Two shades are classified among the Top 20 of the six regions studied: Rouge Allure Pirate and Rouge Coco Gabrielle. However, the rankings of sales of Rouge Allure Pirate are systematically better than those of Rouge Coco Gabrielle, making Rouge Allure Pirate Chanel’s best international seller. Rouge Allure Pirate was launched by Chanel in 2005 and Rouge Coco Gabrielle in 2015. The two shades are saturated dark reds with a hint of yellow. Considering both the presence of the six regions in the ranking and their positioning within that ranking, the most frequently sold shades are Rouge Allure Pirate, Rouge Coco Stylo Message and Rouge Coco Gabrielle as shown on figure 3.

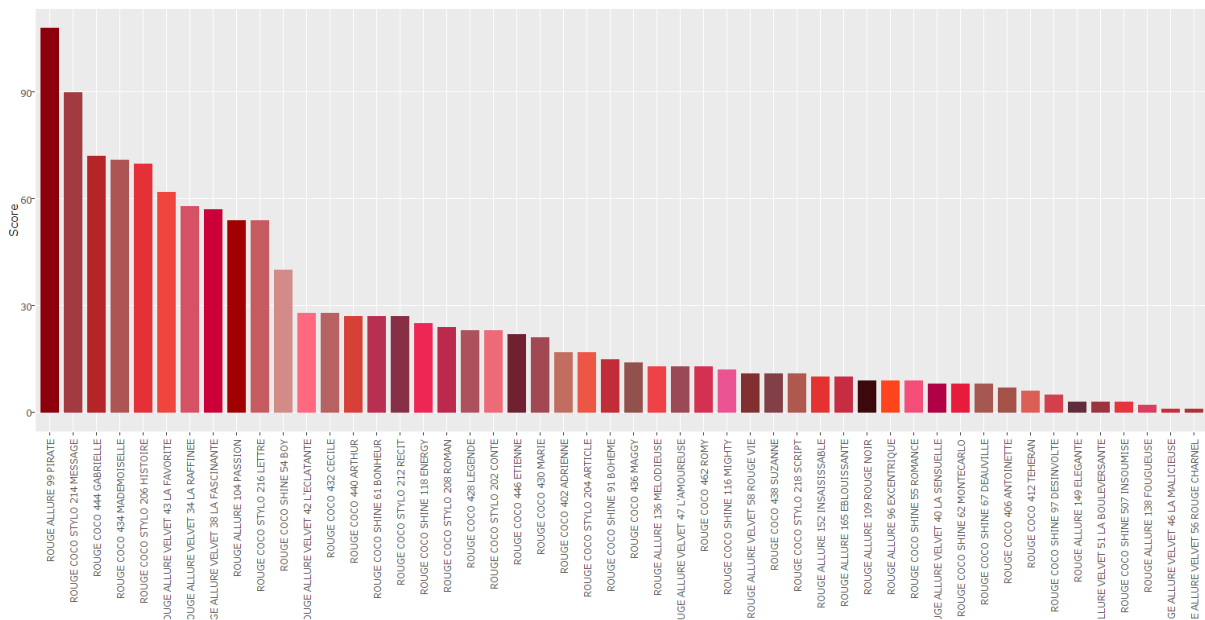

Figure 3: The score of the 50 shades most frequently represented of the Top 20 in the six geographical regions, comparing their presence and ranking within that classification.

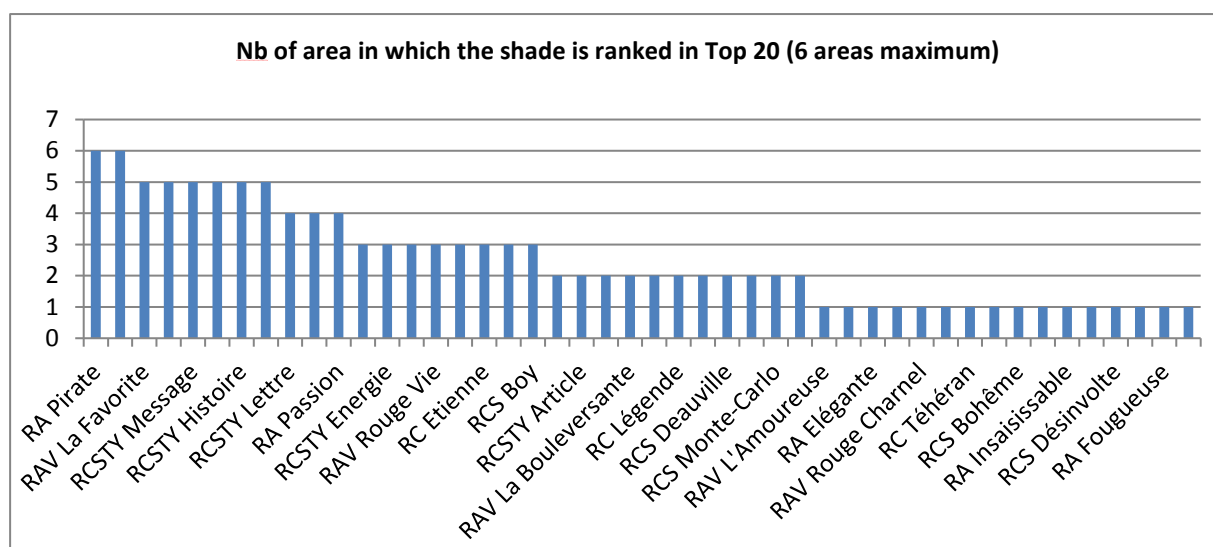

Figure 4: Presence number in the rankings of the Top 20 in the six geographical regions.

Figure 4 shows that six shades are present in five of the six regions studied: Rouge Allure Velvet La Favorite, Rouge Allure Velvet La Fascinante, Allure Velvet La Raffinée, Rouge Coco Stylo Message, Rouge Coco Stylo Histoire and Rouge Coco Mademoiselle. It is interesting to note that among those excellent sales, three are matt lipsticks.

Three shades are among the 20 best sellers in four regions: Rouge Allure Passion, Rouge Coco Arthur and Rouge Coco Stylo Lettre.

Eight shades are represented in this ranking in three geographical regions: Rouge Allure Velvet l'Éclatante, Rouge Allure Velvet, Rouge Vie, Rouge Coco Etienne, Rouge Coco Marie, Rouge Coco Shine Boy, Rouge Coco Stylo Energie, Rouge Coco Style Récit and Rouge Coco Stylo Conte.

Eleven shades are present only twice in the Top 20 ranking: Rouge Allure Velvet La Bouleversante, Rouge Coco Cécile, Rouge Coco Légende, Rouge Coco Suzanne, Rouge Coco Antoinette, Rouge Coco Shine Bonheur, Rouge Coco Shine Romance, Rouge Coco Shine Deauville, Rouge Coco Shine Monte-Carlo, Rouge Coco Stylo Roman and Rouge Coco Stylo Article.

Lastly, 16 shades are specific to one region:

For France, three shades: Rouge Allure Velvet L'Amoureuse, Rouge Allure Rouge Noire and Rouge Allure Élégante.

For Italy, two shades: Rouge Allure Velvet Rouge Charnel and Rouge Allure Bouleversante.

For the United Kingdom, two shades: Rouge Coco Téhéran and Rouge Coco Adrienne.

For the United States, one shade: Rouge Coco Maggy.

For South America, three shades: Rouge Coco Romy, Rouge Coco Shine Mighty and Rouge Coco Stylo Script.

Lastly, for Asia, eight shades: Rouge Coco Shine Bohème, Rouge Coco Shine Désinvolte, Rouge Coco Shine Insoumise, Rouge Allure Mélodieuse, Rouge Allure Insaisissable, Rouge Allure Excentrique, Rouge Allure Fougueuse and Rouge Allure Velvet Malicieuse.

Thus, Asia is the most differentiated part of the world compared with the other geographical areas. It is distinguished by its different choices of shades compared with other countries of the world.

Asians tend to prefer pinkish shades, while other parts of the world tend to prefer redder shades. However, although the preferences of France, Italy and the United Kingdom are relatively similar compared with other countries, differences can nevertheless be discerned between South America

and the United States. South Americans are inclined to prefer brown shades like Rouge Allure while North Americans tend to prefer reds.

Similarities and countries whose choice of shades is very close can be observed: for example, Italy and France share a preference for 13 of the 20 best-selling shades.

Areas	Italia	UK	South America	Asia	USA
France	13	11	11	8	10
Italia		12	12	9	8
UK			10	8	11
South America				6	10
Asia					4

Table 1: Number of shades shared by two regions of the 20 shades present in the ranking.

The first proximity criterion in the choices seems to be linked to geographical proximity. Europeans share a preference for certain shades. As an illustration, Italy and France share 13 of the 20 best-selling shades. The United Kingdom shares 12 shades with Italy and 11 with France.

Similarly, countries whose culture is Latin make similar choices in their shades and South Americans and Italians share 12 out of 20 shades, while France and South America share 11.

Lastly, there seem to be certain affinities between English-speaking countries, although they are somewhat less marked. Ten shades are shared by the United Kingdom and the United States but also by South America, the United Kingdom and the United States, a 50% similarity in all those cases.

The part of the world which is really very different from the others is Asia with a maximum of nine shades in common with another region, Italy, sharing only four shades out of 20 with the United States. Those two continents are the most distant in their shade preferences.

The countries which best represent world preferences are those of Europe, with France and Italy in the lead, closely followed by the United Kingdom.

To study the color preferences in each region, the link between the ranking and the lipstick color classification was studied. The figure 5 is a cluster representation in the Top 20 ranking according to geographical region. France is the only region which presents shades in cluster 1 in its 20 best-selling shades. Italy shows a preference for cluster 7. Although the United Kingdom is centrally positioned, like all European countries, its inclination is for American preferences. For the United Kingdom and the United States, cluster 3 is most frequently represented in the survey of their best sellers. Although South America shows a preference for cluster 5, a taste for saturated pinks suggests a degree of Latin proximity to France and Italy. Lastly, Asia is the most differentiated part of the world with a nearly 50% preference for light saturated shades (cluster 8). The specific shades which appear in a country's ranking but not in the five other regions are shades characteristic of the country's color preference.



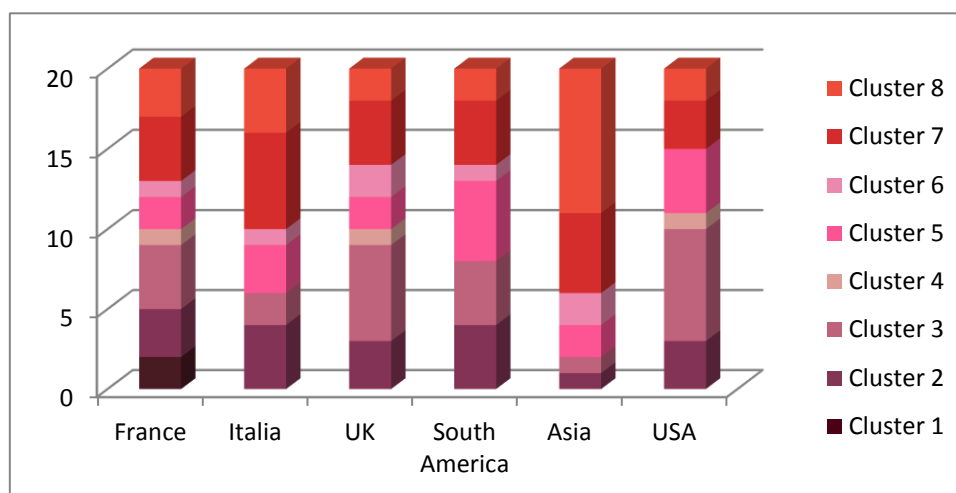

Figure 5: Cluster representation in the Top 20 ranking according to geographical region.

## CONCLUSION

The best-selling 50 shades of lipstick in six regions of the world showed that the shade called Rouge Allure Pirate was unanimously preferred internationally. Italy and France were the two countries most representative in terms of lipstick shades. The countries of Europe, France, Italy and the United Kingdom, were close in their choices while Asia was the geographical region where the best-sellers were the most different from the rest of the world. Lastly, a proximity in the choices of the Latin countries and a tendency towards proximity for the English-speaking countries was apparent. The best-selling lipstick colors differ from one area to another. Americans prefer pink shades as do the British, while Asians opt for very fresh, light and saturated shades. In South America, bluish and saturated shades account for good sales figures. Each region shows its cultural difference through these color preferences.

## REFERENCES

- CHANEL PB. 2016. *Sell In Bases Vente Monde Asie & WW Projection Sept 2016* // Region Feedback South America YTD Sept 2016 Internal Source.
- Everitt, B. S., S. Landau, M. Leese, and D. Stahl. 2011. *Cluster analysis*. New-York: Wiley.
- Jobson, J. D. 1992. *Applied Multivariate Data Analysis, Vol. 2, Categorical and Multivariate Methods*. New York; London: Springer Verlag.

# Parallelism as advertising strategy in Maybelline's lipstick color names

Isabel Espinosa-Zaragoza <sup>1,\*</sup>

<sup>1</sup> University of Alicante; isabel.espinosa@ua.es

\* Corresponding author: isabel.espinosa@ua.es

## Abstract

This study analyses the word formation processes and formal features of lipstick color names by the cosmetic brand Maybelline. For this purpose, a seventy-six-color name sample was manually collected from their webpage. The analysis reveals the predominance of two main parallelistic mechanisms used in color nomenclature: structure and concept repetition. The former is intended to impress the audience and capture customer attention (e.g., hyphenated expressions like *ruby-for-me*; or determiner plus secondary color terms, such as *more berry*); the latter aims to seduce the consumer by exploiting theme consistency based on color longevity or romance and compulsion (e.g., *taupe seduction*), sometimes combined with alliteration (e.g., *constant cocoa*) and assonance (e.g., *extreme aubergine*). The results and conclusions point to the paramount importance of color terminology and verbal identity (Allen and Simmons 2003), as it contributes to a coherent and homogeneous color range organization that is highly identificatory, memorable and attention-grabbing.

**Keywords:** *color terminology, English for Advertising, cosmetics, naming, nominal architecture*

## INTRODUCTION: GENERAL FORMAT AND LENGHT

The cosmetic industry is well-known for resorting to evocative color terminology to differentiate almost identic products in an overflooded market where both products and brands are constantly created. This high productivity forces for impactful and eye-catching color denominations to boost consumerism, with countless products and colors making their way season after season. For this reason, attention must be paid to these fleeting trends that constitute part of a company's brand image (Allen and Simmons 2003) and to the intentional linguistic strategies aimed at gaining market distinctiveness in order to know what has already been done and what can be expected from future naming trends.

## REVIEW OF LITERATURE

Basic color terms<sup>1</sup> (Berlin and Kay 1969), henceforth BCTs, are a rarity in cosmetic color terminology (Wyler 2007, 116-117) as they frequently are accompanied by diverse linguistic information (e.g., light, dark, deep) that yield compositional non-basic color terminology (Anishchanka et al. 2014). Secondary color terms (Casson 1994), "non-compositional non-basic names" (Anishchanka et al. 2014) or "logical" terms (Biggam 2012), where "entity stands for entity's colors", are also highly prevalent but insufficient to stand out in a myriad of product extravaganza. Thus, linguistic information is added to create evocative terms (Biggam 2012: 50) and diverse "nominal architecture" (Martín 2009, 283) is used not only to create a coherent in-brand color range organization but also to boost its appeal and to stand out from other competitors. The different relations among company lines, products, subproducts and services, which contribute to brand image creation, exploit different strategies to construct brand identity. In our case, a syntactic pattern, on the one hand, and a semantic pattern whose concept is perceptible by the consumer, on the other. Alliteration and assonance, linguistic devices which very much resemble many facets of poetic language (Vasiloaia 2009), are also typically featured in

---

<sup>1</sup> That is, black, white, red, green, yellow, blue, brown, purple, pink, orange and grey in English.

advertising language. The mnemonic effects these rhetorical devices exude help with brand memorability, both in terms retention power and recall (Skorupa and Dubovičienė 2015). How brands create these elements of verbal identity is important to shed light on this area of English for Specific Purposes.

### **OBJECTIVES AND METHODOLOGY**

The study focuses on the word formation processes which create lipstick shade names by the cosmetic brand Maybelline, as well as on specific formal features, the imagery and theme chosen to exploit and the different phonetic-phonological aspects characteristic of the language of advertising. A seventy-six-color name sample belonging to four collections by Maybelline was manually collected from their webpage (www.maybelline.com) during March 2021<sup>2</sup>. No further color description is offered by the company on the aforementioned webpage, only a visual representation of the color and its name.

<b>Maybelline's collections</b>	<b>Nomenclatures</b>	<b>n</b>
Color Sensational® Made for All Lipstick	Syntactic	7
Color Sensational Ultimatte, Slim Lipstick Makeup	Syntactic	10
Super Stay 24® 2-Step Liquid Lipstick Makeup	Semantic	44
Color Sensational® Shine Compulsion Lipstick Makeup	Semantic	15
Total		76

Table 1: Sample.

### **ANALYSIS**

The analysis reveals the predominance of two main parallelistic mechanisms used in color nomenclature creation: structure repetition based on the consistent use of different word formation processes, on the one hand, and concept repetition or consistency, also known as semantic nomenclature (Martín 2009), on the other. The exploitation of some phonetic-phonological aspects, namely assonance and consonance, is also used to enhance the appeal of these “constructed nameables” (Wylter 2007: 117).

#### **Word formation aspects: structure repetition**

Two different word formation processes are consistently resorted to with the intention to surprise and divert customer expectations of finding a selection of conventional monolexic color terminology — either BCTs (Berlin and Kay 1969) or secondary color terms (Casson 1994)—, by creating eye-catching syntactic structures which further contribute to the homogenization of the collection.

Firstly, in the *Color Sensational Made for All Lipstick* collection, hyphenated expressions are used to reinforce the collection's claim (i.e., *Made for All*) and the general appropriateness of the product (e.g., *red-for-me*, *pink-for-me*; *mauve-for-me*, *fuchsia-for-me*; *plum-for-me*, *spice-for-me*; *ruby-for-me*). This structural pattern of “color term-for-me”, a compound phrase with a color term as head and a prepositional phrase complement (Bauer and Renouf 2001: 103), not only works as a mantra in each

<sup>2</sup> New shade additions are not taking into account beyond March 2021.

application to stress the fact that both this brand and this particular color belong to the consumer but also links and identifies those colors as part of the "Made for All" line.

Secondly, the *Color Sensational Ultimatte, Slim Lipstick Makeup*<sup>3</sup> collection resorts to a determiner (e.g., *more*) and a secondary color term to imply that there is more of something, in this case, a secondary color term (i.e., "entity stands for entity's color") after flowers and plants (e.g., *more mauve*), food and beverages (e.g., *more berry, more truffle*), minerals and pigments (e.g., *more ruby, more rust, more scarlet, more magenta*), animals (e.g., *more taupe, more buff*) and the naked body, as in the color of skin turning red (e.g., *more blush*).

### **Semantic aspects: theme consistency**

A semantic nomenclature (Martin 2009) entails semantic consistence, that is, following an identifiable conceptual pattern across all the names of a collection. The *Super Stay 24® 2-Step Liquid Lipstick Makeup* collection is an example of semantic nomenclature, where the concept of product longevity is not only mentioned in the collection name (i.e., *Super Stay 24*, that is, it claims to last up to 24 hours) but also exploited in the color name to emphasize the fact that this product is very long-lasting and intended to stay in your lips for hours. The structural pattern usually consists of a first element which denotes longevity, either adjectives (e.g., *everlasting, eternal, endless, infinite*) or adverbs (e.g., *all day, 24/7, all night, forever*) plus a color term to yield nameables like *everlasting wine, eternal cherry, endless espresso, infinite petal, all day cherry, 24/7 fuschia, all night apricot* and *forever chestnut*, among others. In addition, there are some cases of sentences (e.g., *pink goes on, keep up the flame*) that also denote color durability and one instance of color term + noun (e.g., *merlot armour*, where the color covering the lips acts as a firm and enduring shield). Over all, the notion of the color being durable is maintained throughout all the elements of the collection by using synonymous adjectives and adverbs which highlight the high staying power of these shades.

Similarly, the *Color Sensational® Shine Compulsion Lipstick Makeup* collection intends to seduce the consumer with terms related to romance, sex and compulsion and, hence, the color names allude and continue this recurrent theme in the cosmetic color terminology industry (Merskin 2007; Radzi and Musa 2017) in two different ways. On the one hand, mainly carried out by means of compounds whose head is a color term and the left element is an adjective related to sex and romance, such as *undressed pink, spicy sangria, spicy mauve, steamy orchid, risky berry, baddest beige, arousing orange* and *secret blush*. On the other hand, with the color term as left element in the compound and a noun related to passion, desire and a risky and forbidden love as head: *pink fetish, taupe seduction, scarlet flame, chocolate lust, magenta affair, berry blackmail* and *plum oasis*. The intention behind the romance semantic category is two-fold: (1) the consumer is captivated by the color range and, thus, seduced by it and/or (2) the person that wears the color is the one able to seduce others due to the application of that particular color to their lips.

### **Phonetic-phonological aspects: alliteration and assonance**

Apart from that, the *Super Stay 24® 2-Step Liquid Lipstick Makeup* collection, based on thematic repetition of the notion of product endurance, is also combined with consonantal alliteration in some cases to boost its attractiveness, where the initial consonant sounds in both elements coincide: repetition of the voiceless plosive stops such as /p/ in *so pearly pink* and *perpetual plum*, /t/ in *timeless toffee* and /k/ in *committed coral, constant cocoa* and *continuous coral*; the voiced plosive stop /b/ in

---

<sup>3</sup> 'Ultimate' and 'matte' are blended together to condense information about the qualities of the product.

*boundless-berry*; the different approximants, like the voiced alveolar approximant /l/ in *loaded latte* and *lasting lilac*, the voiced post-alveolar approximant /r/ in *reliable raspberry* and *relentless ruby* and the voiced bilabial velar /w/ in *wear on wildberry*. Not to mention the voiced bilabial nasal /m/ in *more & more mocha* and the voiceless alveolar fricative /s/ in *stay scarlet*. This sound repetition is not exclusively relegated to consonant sounds, as there are also instances vowel sound reiteration (i.e., assonance), like in *extreme aubergine* (/ɪk'stri:m 'æʊbərzi:n/), *steady red-y* (/ˈstedi 'rɛdi/, with a reanalysis that coincides with the homophone “ready”), *non-stop orange* (,nɒn'stɒp 'ɒrɪndʒ/) and *very cranberry* (/ˈveri 'krænbəri/). These phonetic-phonological aspects are proved to be helpful in an advertising context owing to their fancy-sounding qualities and ability to increase memorability (Skorupa and Dubovičienė 2015).

## CONCLUSIONS

This study intends to highlight the crucial importance of color names in the cosmetic industry as part of English for Advertising. Cosmetic color names do much more than simply describe or designate hues, these “constructed nameables” instill these lipstick collections with a distinctive touch that serves both to organize the colors in a coherent and homogeneous way and to capture customer attention. Consequently, apart from designating a particular hue, they imbue the color and the product with a repetitive mantra, the concept of romance and desire to sell you an exclusive experience or the reliability of the hue's staying power. Structure repetition provides order and homogeneity to the color range and reinforces the fact that each member belongs to that collection, whereas the repetition of the concept (i.e., longevity and romance) —already stated in the collection name in most cases— packs information that can ultimately motivate a purchase. In this case, the concepts selected were product characteristics (i.e., long-lasting power in a liquid lipstick) and a romantic experience where there is a patent ambivalence with the consumer both seducing and being seduced. Additionally, alliterative color names add to this experience as they are pleasing to the ear. The results and conclusions point to the paramount importance of verbal identity in cosmetics as part of English for Advertising. The conception of appealing and evocative color terminology can be considered as influential for the company's brand image as other advertising elements, such as PR packaging ideation, color range selection and social media (re)presentation and interaction. This analysis further complements and expands on previous cosmetic advertising studies and on the language of cosmetics (Merskin 2007; Ringrow 2016; Radzi and Musa 2017) and covers some of the cutting-edge linguistic trends that currently dominate cosmetic color denomination and the implications of this terminology curation.

## ACKNOWLEDGEMENTS

The author of this paper is the beneficiary of a grant from the Vicerrectorado de Investigación y Transferencia de Conocimiento/Vice President for Research and Knowledge Transfer of the University of Alicante for pre-doctoral training (from 01/01/2019 to 31/03/2022). This research has been carried out with the financing obtained in the context of this grant.

## REFERENCES

Allen, T., and J. Simmons. 2003. Visual and verbal identity. In: *Brands and Branding*, R. Clifton and J. Simmons, eds. London: The Economist Newspaper: 113–126.

- Anishchanka, A., D. Speelman and D. Geeraerts. 2014. Referential meaning in basic and non-basic color terms. In: *Colour studies: A broad spectrum*, W. Anderson, C. P. Biggam, C. Hough, and C. Kay, eds. Amsterdam/Philadelphia: John Benjamins, 323–338.
- Bauer, L. and A. Renouf. 2001. A Corpus-based Study of Compounding in English. *Journal of English Linguistics* 29, No.2: 101-123.
- Berlin, B., and P. Kay. 1969. *Basic Color Terms: Their Universality and Evolution*. Berkeley: University of California Press.
- Biggam, C. P. 2012. *The semantics of colour: A historical approach*. Cambridge: Cambridge University Press.
- Casson, R. W. 1994. Russett, Rose, and Raspberry: The Development of English Secondary Color Terms. *Journal of Linguistic Anthropology* 4, No. 1: 5–22
- Martín, E. 2009. *Nominología: cómo crear y proteger marcas poderosas a través del naming*. Madrid: Fundación Confemetal.
- Merskin, D. 2007. Truly Toffee and Raisin Hell: A Textual Analysis of Lipstick Names. *Sex Roles* 56, No.9: 591–600. <https://doi.org/10.1007/s11199-007-9201-9>.
- Radzi, N. S. M., and M. Musa. 2017. Beauty Ideals, Myths and Sexisms: A Feminist Stylistic Analysis of Female Representations in Cosmetic Names. *Journal of Language Studies* 17, No.1: 21–38. <https://doi.org/10.17576/gema-2017-1701-02>.
- Ringrow, H. 2016. *The Language of Cosmetics Advertising*. Palgrave Pivot. <https://doi.org/10.1057/978-1-137-55798-8>.
- Skorupa, P., and T. Dubovičienė. 2015. Linguistic characteristics of commercial and social advertising slogans. *Coactivity: Philology, Educology/Santalka: Filologija, Edukologija* 23, No.2: 108–118.
- Vasiloaia, M. 2009. Linguistic Features of the Language of Advertising, *Economy Transdisciplinarity Cognition*. No. 1, 1–5.
- Wyler, S. 2007. Color terms between elegance and beauty. The verbalization of color with textiles and cosmetics. In: *Speaking of Colors and Odors*, M. Plümacher and P. Holz, eds. Amsterdam/Philadelphia: John Benjamins, 113–128.

## APPENDIX

Color Sensational® Made for All Lipstick	Color Sensational Ultimatte, Slim Lipstick Makeup	
ruby-for-me	more berry	more mauve
pink-for-me	more ruby	more buff
mauve-for-me	more scarlet	more taupe
fuchsia-for-me	more magenta	more rust
spice-for-me	more blush	more truffle
red-for-me		
plum-for-me		

<b>Super Stay 24<sup>®</sup> 2-Step Liquid Lipstick Makeup</b>	<b>Color Sensational<sup>®</sup> Shine Compulsion Lipstick Makeup</b>	
merlot armour	frozen rose	baddest beige
so pearly pink	steady red-y	undressed pink
timeless toffee	non-stop orange	secret blush
never ending pearl	stay scarlet	spicy sangria
absolute taupe	timeless rose	spicy mauve
constant cocoa	reliable raspberry	risky berry
constant toast	24/7 fuschia	steamy orchid
loaded latte	all day cherry	arousing orange
all night apricot	eternal cherry	pink fetish
committed coral	everlasting wine	taupe seduction
more & more mocha	optic ruby	chocolate lust
frosted mauve	on and on orchid	scarlet flame
firmly mauve	unlimited raisin	magenta affair
infinite petal	all day plum	berry blackmail
always heather	boundless-berry	plum oasis
forever chestnut	relentless ruby	
blush on	endless espresso	
continuous coral	extreme aubergine	
lasting lilac	pink goes on	
perpetual plum	keep up the flame	
very cranberry	wear on wildberry	
crisp magenta	keep it red	

# Fifty Shades of Beige: An Analysis on Color System for Liquid Foundation

Yuchun Yan <sup>1</sup> and Hyeon-Jeong Suk <sup>1,\*</sup>

<sup>1</sup> Color Lab., Department of Industrial Design, KAIST, Republic of Korea; yanyuchun@kaist.ac.kr, color@kaist.ac.kr

\* Corresponding author: color@kaist.ac.kr

## Abstract

With the increasing awareness of skin diversity, cosmetic companies have created foundations with more than 40 shade options. Color researchers endeavored to evaluate the color quality of foundation from product R&D. At the same time, cosmetics companies have conducted their own trials to systematically communicate these tiny shade differences to consumers. In this study, we investigated the relationship between the practical color labels and the colorimetric values of 175 foundations from three global product lines measured in CIEL\*a\*b\* color space. Based on the analysis, the color of liquid foundation, were shades in a wide lightness range, in low chroma, and concentrated hue. Lightness difference was clearly controlled through L\*; undertone classification was influenced by L\* and was specified with the combination of a\* and b\* or h (hue angle), which slightly differed from brand to brand.

**Keywords:** *Liquid foundation, Color system, Lightness, Undertone*

## INTRODUCTION

Foundation, a base color cosmetic product, is developed to even skin tone, cover the pores, blemishes, or further reproduce facial skin color as the customers want. Such function, requires the color of product shades to be in harmony with the bare skin. Due to the increasing awareness of the diversity of skin color and the accelerated process of internationalization, the provided shade options have been increased globally. Typically, when launching a foundation range, around 20 shades were considered. In this age of vlogger celebrity, singer Rihanna's beauty company, Fenty Beauty, launched in 2017 with 40 shades of foundation with the intention that women everywhere would have a choice of their foundation shade color. Although some famous global brands, such as Lancome, M.A.C., already had over 40 shades, after the launch of Fenty Beauty, more brands started to increase their shade range from below 20 to more than 40 shades, which made 'Fenty 40', a magic number (Wilson 2020).

When the total foundation shade range has been continuously increasing, how to select the color, arrange the color and communicate these shade colors with customers remain equivocal. Many researchers have endeavored to first discover the color feature of foundation products from color science. Whiting et al. (2004) investigated the perceptible color-difference for foundation products using sensory difference tests. Ikeda et al. (2014) evaluated the luminosity of skin coated with powder foundation and analyzed in color space. Recently, Yan et al. (2021) tried to report the discoloration, the time-resolved color changes of liquid foundation. By convention, cosmetics companies and manufactures have developed their own approach and practiced to communicate this world of beige with customers for long. For many other products, numeric or symbolic color labels are not necessary, but they are usually used for foundation to intuitively introduce the whole color range and specify the color identity of each shade. Attentions have also been paid to color names, which help convey a specific color image for each shade. In this regard, this study addresses the color communication for liquid foundation concerning the color system developed behind through various cosmetics companies practically. We investigated the relationship between the practical color labels with colorimetric values of measured foundation shades from three global lineups.



## METHOD

### Apparatus and Measurements

To analyze the color distribution and color tendency of liquid foundation, measurement of the texture color was conducted using a non-contact spectrophotometer, X-rite MetaVue™ VS3200. Liquid foundations were applied on opacity charts and the texture color were measured. Four drops of liquid foundation were placed on the opacity chart and were slid from the top to the bottom through a four-sided applicator. The application thickness was set as 100 $\mu$ m. This thickness enabled the applied foundation layer to be opaque and the color data of the foundation can be directly recorded without further calculation. When the foundation layer was applied on the opacity chart, the opacity chart was placed under the measurement window and the measurement started immediately. The circular spot for the measurement was set as 12mm in diameter. The hardware and example of the foundation-coated opacity chart are shown in Figure 1.

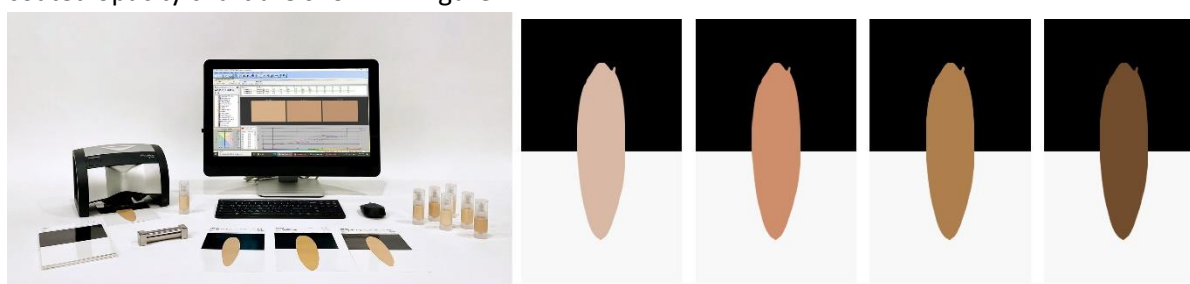

Figure 1: A scene of measurement using the MetaVue™ VS3200 together with the samples of applied foundation on opacity charts.

### Materials

Three product lines of liquid foundation were selected shown in Figure 2. All three product lines covered a wide range of foundation colors for different ethnic groups and were launched for international market. All products were purchased from the official stores. A total of 175 shades of liquid foundations were measured.



Figure 2: Three selected global product lines with a total of 175 shades of liquid foundation: from left to right Brand A, B and C.

### Data Collection

For each shade, the measurement resulted in color values, such as  $L^*$ ,  $a^*$ ,  $b^*$  in CIE1976 $L^*a^*b^*$  (CIE-Lab hereinafter), reflectance, and reflection gloss.  $L^*$  indicates the lightness (0 to 100), while  $a^*$  and  $b^*$  explains greenness-redness and blueness-yellowness (-127 to 127), respectively. The  $a^*$  and  $b^*$  crossed at a right angle by creating an  $a^*-b^*$  plane. In the analysis, the  $L^*$ ,  $a^*$ , and  $b^*$  values were also converted into CIE-LCh to refer the Chroma and hue angle straightforwardly. C stands for the Chroma, which refers to the vividness of the color, and was estimated through a Euclidean distance of  $a^*$  and

$b^*$  from achromatic orientation. Lastly,  $h$  refers to a hue angle of a color in the  $a^*$ - $b^*$  plane. Reflectance was recorded with a spectral range of 400nm to 700nm in 10nm intervals.

## RESULTS

### Color Distribution for Global Shades

For the 175 measured shades, how  $L^*$ ,  $a^*$ ,  $b^*$ ,  $C^*$  were distributed were plotted in Figure REF. The left figure presented the shade color in  $L^*$ - $C^*$  panel and the right figure for  $a^*$ - $b^*$  panel. For the entire data collected from the three brands,  $L^*$  ranged from 20.19 to 85.74 (Mean = 59.93, SD = 14.54). More shades were distributed in lightness above 60. Considering the total range of  $L^*$ , ranging from 0 to 100, liquid foundation included shades in diverse lightness. In terms of chroma, it ranged from low to medium level considering the total chroma scope (Mean = 30.68, SD = 4.96). A horizontally flipped “C” shape appeared in this panel. When  $L^*$  was relatively low or high,  $C^*$  ranged around 20. As  $L^*$  increases,  $C^*$  increased to a climax around 40 when  $L^*$  ranged from 40 to 60. Therefore, in terms of foundation color, it is more vivid in medium lightness and is relatively paler for dark and light colors. Different from  $L^*$ ,  $a^*$  and  $b^*$  were distributed in a concentrated range but uniformly.  $a^*$  ranged from 6.33 to 20.76 (Mean = 13.94, SD = 3.14) and  $b^*$  ranged from 12.05 to 36.53 (Mean = 27.20, SD = 4.69).

How  $L^*$ ,  $a^*$ , and  $b^*$  were distributed were plotted in Figure 5 in terms of the whole data and individual brand. One-way ANOVA was conducted for  $L^*$ ,  $a^*$ , and  $b^*$ , respectively, to investigate whether the color distribution differs for different global product lines. There were no statistically significant different for  $L^*$  [ $F(2,172) = 1.14$ ,  $p = 0.32$ ] and  $a^*$  [ $F(2,172) = 0.96$ ,  $p = 0.38$ ] but only for  $b^*$  [ $F(2,172) = 3.63$ ,  $p = 0.03$ ]. This indicates that the similar color distribution is considered for  $L^*$  and  $a^*$  for global foundation color. In terms of  $b^*$ , Brand B has the lowest and Brand C has the highest. The foundation colors selected for Brand C are relatively more yellowish.

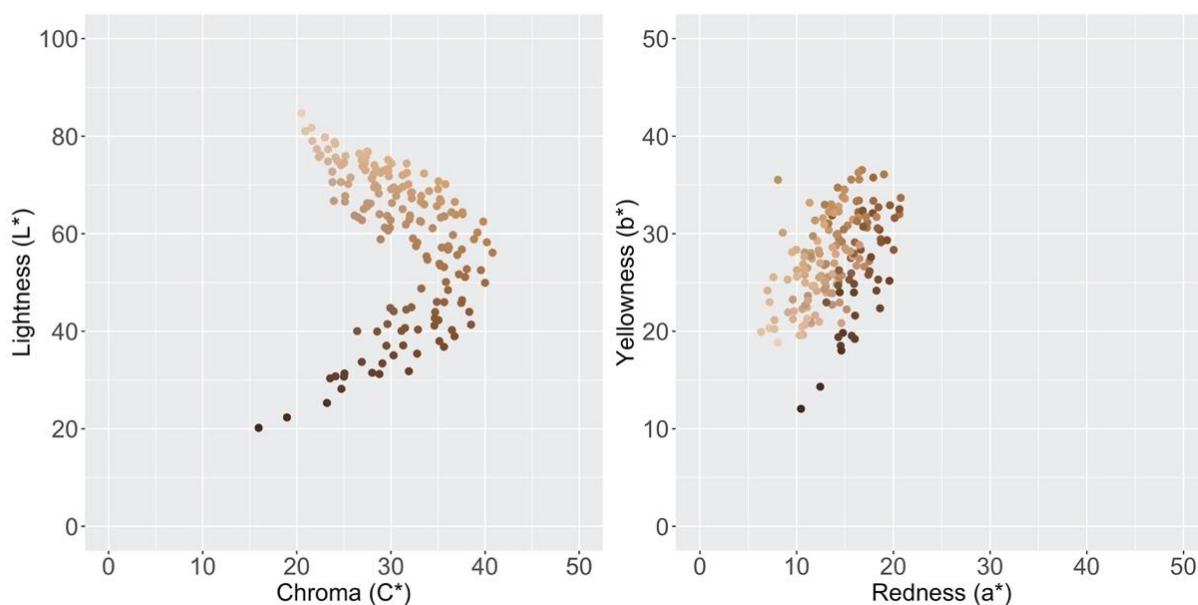

Figure 3: 175 foundation shades plotted in  $L^*$ - $C^*$  and  $a^*$ - $b^*$  panels.

Relationship between Colorimetry and Color Labels

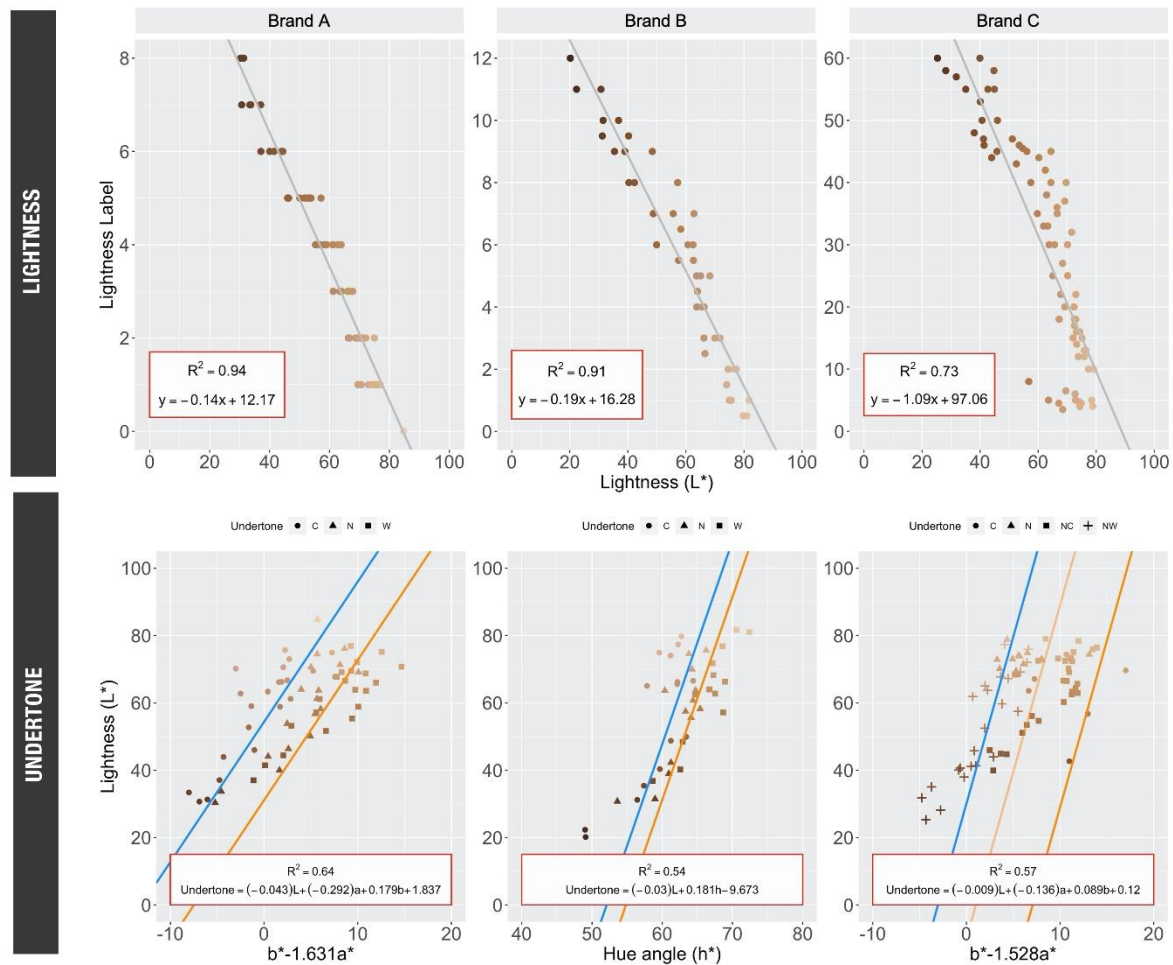

Figure 4: Lightness and undertone classification for each brand.

Lightness

These three brands used different number range to label the shades. Brand A used 9 integers, ranging from 0 to 8, to indicate the lightness. 0 to 2 belonged to 'Light'; 3 to 5 belonged to 'Medium'; and 6 to 8 belonged to 'Deep'. Brand B used numbers up to one decimal point, ranging from 1 to 12. Brand C used numbers up to two decimal point, ranging from 3.5 to 60. To figure out the relationship between color values and foundation color feature of lightness, a correlation analysis was first conducted for the numeric lightness label and color values. A very strong negative correlation was spotted between L\* and numeric lightness label. To further investigate the relationship between numeric lightness label and L\*, the product shades were plotted to Lightness label-L\* panel. From the plot in Figure 4, a clear linear relationship between Lightness label and L\* was observed for all three brands. Therefore, a linear regression was calculated to predict lightness code based on L\*. A significant regression equation was found [F(1,59) = 940.10, p < 0.05], with an R<sup>2</sup> of 0.94 for brand A; [F(1,40) = 421.1, p < 0.05], with an R<sup>2</sup> of 0.91 for brand B, and [F(1,70) = 187.80, p < 0.05], with an R<sup>2</sup> of 0.73 for brand C. The linear relationship was especially strong on brand A and B. Therefore, L\* was a significant predictor of numeric lightness label.

Undertone

Different from lightness, undertone was not in numeric scale and was classified into several levels. In terms of brand A and B, it was mainly classified into three levels, named as 'C' for 'Cool', 'N' for 'Neutral' and 'W' for 'Warm'. Different from these two brands, it was classified into four levels for Brand C, named as 'C' for 'Cool', 'NC' for 'Neutral Cool', 'N' for 'Neutral' and 'NW' for 'Neutral Warm'. One thing worth mentioning was that the color label for Brand C was opposite to the normal understanding.

To figure out the relationship between color values and undertone, a multinomial logistic regression was conducted to understand what color values were critical to identify the undertone tendency. Table 1 indicated the trials on different independent variables (IV) with top 3 model accuracy for each brand. For brand A, the model with IV of L\*, C\* and h achieved the highest accuracy but the IV C\* was not statistically significant. Considering with the similar level of accuracy, model with IV of L\*, a\*, b\* was most. Similarly, model with IV of L\*, h was most appropriate to predict the undertone categories for brand B and the model with IV of L\*, a\* and b\* for brand C.

Rank	Brand A				Brand B				Brand C			
	IV1	IV2	IV3	Accuracy	IV1	IV2	IV3	Accuracy	IV1	IV2	IV3	Accuracy
1	L*	C*	h	78.70%	L*	h		71.40%	L*	a*	b*	73.50%
	*		*		*	*			*	*	*	
2	L*	a*	b*	75.40%	L*	C*	h	71.40%	L*	h		72.20%
	*	*	*		*		*		*	*		
3	h	C*		70.50%	L*	a*	b*	69.00%	L*	C*	h	72.20%
	*	*			*	*	*		*		*	

\* p < 0.05

Table 1: Top 3 models in high accuracy to predict the undertone categories for each brand.

To be specific, this multinomial logistic regression model results for undertone categories were shown in Table 2. This table indicated the variables that could explain the undertone color tendency compared with neutral undertone. If the odds ratio < 1, the outcome is more likely to be in the referent group; if the odds ratio > 1, the outcome is more likely to be in the comparison group. Compared with neutral undertones, similar color tendency for cool and warm undertones were shown in both three brands. Shades in cool undertones were higher in lightness (L\*) and redness (a\*) for Brand A, lower in hue angle (h) for Brand B, and higher in redness (a\*) for Brand C; while shades in warm undertones were higher in yellowness (b\*) for brand A and C, and higher in hue angle (h) for Brand B. These indicated that the combination of a\* and b\* or h were meaningful color values to predict undertone and the undertone cognition changed based on lightness.

Predictor	Cool vs Neutral			Warm vs Neutral		
Brand A	Odd ratio	95% CI		Odd ratio	95% CI	
L*	1.28**	1.09, 1.50		0.87	0.74, 1.03	
a*	5.07**	1.81, 14.18		0.40*	0.16, 0.97	
b*	0.45***	0.28, 0.73		1.96**	1.22, 3.15	
Nagelkerke R <sup>2</sup> = 0.73						
Brand B						
L*	1.08	1.00, 1.17		0.85	0.71, 1.02	
h*	0.63*	0.42, 0.92		2.90*	1.21, 7.22	
Nagelkerke R <sup>2</sup> = 0.65						
Predictor	Neutral Cool (NW) vs Neutral		Neutral Warm (NC) vs Neutral		Warm (C) vs Neutral	
Brand C	Odd ratio	95% CI	Odd ratio	95% CI	Odd ratio	95% CI

L*	0.92	0.71, 1.21	0.77	0.59, 1.01	0.75*	0.56, 1.00
a*	2.56	0.94, 6.95	0.34**	0.16, 0.72	0.26***	0.11, 0.60
b*	0.70	0.38, 1.29	2.20**	1.31, 3.70	2.86***	1.58, 5.19
Nagelkerke R <sup>2</sup> = 0.77						
* p < 0.05, ** p < 0.01, *** p < 0.001						

Table 2: Odds Ratios and 95% Confidence Intervals from multinomial logistic regression for the relation between undertone categories and predictors for three brands.

## CONCLUSION

In this study, the color system of liquid foundation was investigated, through the color labels practically developed by cosmetics companies and measured foundation shade colors from global lineups. We investigated how the shade colors were arranged concerning lightness and undertones. 175 shades from three global product lines were measured using a non-contact spectrophotometer for the surface color. Based on the measurement, lightness color feature was strongly correlated with L\*, undertone categories were influenced by lightness and could be explained through h (hue angle) or the combination of a\* and b\* in CIEL\*a\*b\* color space. We concluded that the color communication of liquid foundation developed practically in color cosmetics was through a color system with two color features (lightness and undertone) following quantitative rules to arrange these shades of beige. Different from the color systems used in academia and industries, customers, those ordinary people are the audience of this color system. We believe cosmetics companies and manufactures can be benefited from this study for product research and launching. More studies are expected to be conducted to further specify the foundation color from customers' perception.

## ACKNOWLEDGEMENTS

This work was supported by the National Research Foundation of Korea (NRF-2018R1A1A3A04078934) and the BK21 plus program through the National Research Foundation (NRF) funded by the Ministry of Education of Korea (NO.4120200913638).

## REFERENCES

- Ikeda, N., K. Miyashita, R. Hikima, and S. Tominaga. 2014. Reflection measurement and visual evaluation of the luminosity of skin coated with powder foundation. *Color Research & Application*, 39(1), 45-55.
- Whiting, R., S. Murray, Z. Caintic, and K. Ellison. 2004. The use of sensory difference tests to investigate perceptible colour-difference in a cosmetic product. *Color Research & Application: Endorsed by Inter-Society Color Council, The Colour Group (Great Britain), Canadian Society for Color, Color Science Association of Japan, Dutch Society for the Study of Color, The Swedish Colour Centre Foundation, Colour Society of Australia, Centre Français de la Couleur*, 29(4), 299-304.
- Wilson, A. 2020. The Popularity of Fenty Beauty and How It Reflects the Online Beauty Community. *Makeup in the World of Beauty Vlogging: Community, Commerce, and Culture*, 37.
- Yan, Y., J. Lee, J. Hong, and H.J. Suk. 2021. Measuring and describing the discoloration of liquid foundation. *Color Research & Application*, 46(2), 362-375.

# The impact of skin colours on visual impression

Xiaoxuan Liu <sup>1</sup>, Rui Peng <sup>1</sup>, and Ming Ronnier Luo <sup>1,2,\*</sup>

<sup>1</sup> State Key Laboratory of Modern Optical Instrumentation, Zhejiang University, Hangzhou, CHINA; alice\_liu@zju.edu.cn, cherrypr2018@163.com

<sup>2</sup> School of Design, Leeds University, Leeds, UK; m.r.luo@zju.edu.cn

\* Corresponding author: m.r.luo@zju.edu.cn

## Abstract

This study investigates the impact of skin colour affecting visual impressions in terms of attractive, healthy, youthful, feminine, cooperative. The images were rendered on colour calibrated mobile displays for 4 female models, representing the typical types of skin colours. Each image was assessed by 30 Chinese observers using the 5 impressions. The results were used to reveal the relationship between different impressions for each skin type.

**Keywords:** Facial impressions, skin colours, 50% tolerance ellipses

## INTRODUCTION

It is well known that many studies carried out the research work to investigate the impact of skin colour on facial impression. The results are important for different industries such as to develop products in the cosmetic industry, to establish preferable skin colour to achieve satisfactory colour image quality, to create characters for the animation industry, etc.

In the previous investigations (Fink 2001; Fink 2008; Stephen 2011; Yuan 2011), the computer-generated facial images were commonly used. Limited study used real human faces to do the investigation. Wang and Luo (2017) conducted a research to render facial images using those of real human face to investigate the influence of skin colour on facial impressions. Experiment 1 accumulated 22 word-pairs which were typically used to describe facial impressions. Each original facial image was rendered 26 images according to whiteness scale and hue angle. Ten observers were asked to judge which word in each word-pair for the image displayed. The results showed that 5 attributes, sociable, likeable, masculine, youth and health, were sufficient to describe the relationship between facial impression and skin colour. Experiment 2 further investigate the influence of different genders and ethnicities between the observers and stimuli images. Thirty observers were invited and judged the 5 attributes. The relationships between the above 5 facial impressions and colour (whiteness and hue angle) were established. Peng and Luo (2020) studied the preferred colours for 4 types of skin colour on mobile phones. They used the Zeng and Luo's method (2009, 2013) to render images in a\*b\* diagram on a display and to perform visual assessment in terms of preference. Four colour centres together with their 50% tolerance ellipsoids were established. The same method is used in the present study.

The goal of this study was to establish colour centre and 50% tolerance ellipsoid (Peng 2020) for each of the 5 impressions (Wang 2017).

## EXPERIMENT

### Images

Four female models of different skin types were chosen, including Oriental, Caucasian, South Asian, and African. The models were asked to wear black clothing and no accessories. All images were captured using a NIKON Z6, in a studio, under the same lighting condition (6500K, 550lux), against a

uniform neutral grey background. Figure 1 shows the images of four female models, where the eyes of the models were masked by a black patch to help hide their identity from the observers.



Figure 1. The four images used in experiment.

### Display colour characterization

The experiment was conducted using five Huawei P20 mobile phones. Since five mobile phones were used to conduct the experiment simultaneously, it was important that all displays showed good colour consistency. To characterize the display, the 3D colour Look-Up Table (LUT) method, using an array of  $9 \times 9 \times 9$  colours, was implemented (Kang H. R., 1995). The results showed that the colour difference between the individual and the mean values ranged from 1.24 to 1.79 in CIEDE2000 ( $\Delta E_{00}$ ) units (Luo M. R., 2001) using the 24 Macbeth Color Checker chart colours. Overall, the colour accuracy of the five displays was acceptable.

### Predetermined colour centres of Test Images

The shape of the skin colour cluster for digital images in CIELAB colour space can be approximately represented by a 3D ellipsoid (Wang M., 2017). To achieve a reliable 3D ellipsoid skin colour model, including the lightness dimension, a set of 49 colours, uniformly distributed in CIELAB colour space, was used to morph the skin colours of the test images.

Figure 2 shows the 16 colours within the skin colour ellipsoid projections in the CIE  $a^*b^*$  diagram. The black ellipse defines the skin colour boundary of Zeng and Luo (2009) and the red dot is the center of the ellipsoid. The rendered colour samples and the ellipses were selected to give a good coverage of skin colours across all skin types.

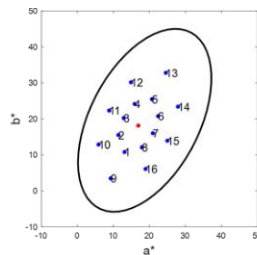

Figure 2: The 16 skin colour centers in CIELAB  $a^*b^*$  plane. The ellipse defines the skin colour boundary of Zeng and Luo and the red point is the center of the ellipsoid.

Each point was also visually refined to cover as large a skin gamut as possible. Images of the same skin type share a set of  $L^*a^*b^*$  values (regardless of gender and age). All images share the same points in the CIE  $a^*b^*$  diagram, but in the  $L^*b^*$  diagram and the  $L^*a^*$  diagram, the range of  $L^*$  values are different for different skin types.

Using Photoshop image processing software to create a suitable mask. The colour of the extracted skin area was morphed toward each of the 49 pre-determined skin colour centers to produce 49 versions of each image in which only the skin colour was different. 16 images in each of the  $a^*b^*$ ,  $L^*a^*$ ,  $L^*b^*$  planes. In total, 196 adjusted images were generated corresponding to 49 skin colours ( $16 \times 3 + 1$



repeat) of 4 original images. As an example, Figure 3 shows the average  $a^*b^*$  co-ordinates of 16 adjusted and the Caucasian images in  $a^*b^*$  plane. Similar plots were for  $L^*a^*$ , and  $L^*b^*$  respectively. Overall, all samples did give a good coverage around the centre.



Figure 3: The 49 test images rendered from the original Caucasian female image.

### Experimental procedure

The experiment was carried out in a darkened room. The mobile phone was placed in landscape direction and was fixed on a table using an adjustable support. The table surface was covered by a grey cloth having CIELAB  $L^*a^*b^*$  values of [76.4, 0.3, 1.3], under CIE D65 illuminant and  $10^\circ$  observer. Observers sat approximately 35 cm in front of the display screen. A total of 30 Chinese observers with normal colour vision participated in the experiment.

At the beginning of each session, observers were asked to adapt to the dark environment for two minutes, while the mobile phone screen was black. After 2 minutes, the observer inputted their personal information on the phone and then commenced the experiment. There were 5 image groups, including 4 original and 1 repeated group (the Oriental images were assessed twice to evaluate the intra-observer variations). Each group contains 49 images of different skin tones of the same model.

Five facial impression attributes were selected in the present experiment, e.g., attractive-unattractive, healthy-unhealthy, young-old, feminine-masculine, cooperative-uncooperative. Taking 'attractive-unattractive' as an example, the images for each model was evaluated separately. The observer judged each of the 49 images as "attractive" or "unattractive" in random order. There was a black screen lasting for 30 seconds between two test groups for re-adaptation. This procedure was repeated for each of the 5 image groups with the order of the 5 groups randomized for each observer. Altogether, 36,750 estimations were made, i.e., 5 groups (4 origin images+1 repeat) x 30 observers x 49 renderings x 5 impressions. The whole experiment lasted about 60 minutes for each observer. The whole experiment lasted about 60 minutes for each observer.

## RESULTS

### 50% acceptability ellipsoid model

The raw data was reported in terms of positive percentage. For example, if for each image judged as 'attractive' by 10 observers, this image will have a positive percentage of 33.3%. Hence, the result for each image is described in terms of positive percentage (P%). The results were analysed in terms of



50% acceptability ellipsoid for each image based on 49 rendered images. The independent variable is the skin colour center defined from the  $L^*$ ,  $a^*$ ,  $b^*$  values of the 49 images, and the dependent variable is the scaled visual results in terms of  $P$ . Eq. (1) was used to fit a model to characterize the percentage attractiveness of the skin colour:

$$P = \frac{1}{1 + e^{\Delta E' - \alpha}} \tag{1}$$

and

$$\Delta E' = \sqrt{k_1 \cdot (L^* - L_0^*)^2 + k_2 \cdot (a^* - a_0^*)^2 + k_3 \cdot (b^* - b_0^*)^2 + k_4 \cdot (a^* - a_0^*)(b^* - b_0^*)} \tag{2}$$

where  $L^*$ ,  $a^*$ ,  $b^*$  is the predetermined colour center. The preferred colour center,  $(L_0^*, a_0^*, b_0^*)$ , and  $k_1 - k_4$  and  $\alpha$  are the parameters required to fit the experimental data by minimizing the difference between the visual data and the parameters calculated using Eqs. (1) and (2). When  $\Delta E' = \alpha$ , a preferred skin colour ellipsoid with a positive  $P$  of 50% can be calculated and this ellipsoid contains all the colours that have 50% acceptability. The other four impressions were analysed with the same method.

The mean correlation coefficient,  $r$ , between the percentage calculated from the experimental data and the percentage predicted by the model for this image group was 0.94, indicating that the model can predict the facial impression attributes well.

Figure 4 shows the model of skin colour CIELAB  $a^*b^*$  values and corresponding attractiveness percentage  $P$ , where the data points are the experimental data and the mesh points represent the model of Eq. (1) corresponding to different attractiveness percentages. The higher the percentage, the smaller the area of the ellipse and the closer to the center of the ellipse, representing the 'the most attractive' colour. The same calculation was adopted to the other 4 impressions. Figure 5 shows the 50% acceptability ellipses of the 4 skin groups for five impression attributes in CIE  $a^*b^*$  plane.

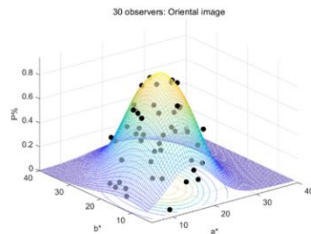

Figure 4: The fitted bivariate Gaussian distribution  $P(a^*, b^*)$  for estimating the degree of skin colour attractiveness when 30 observers viewed oriental images.

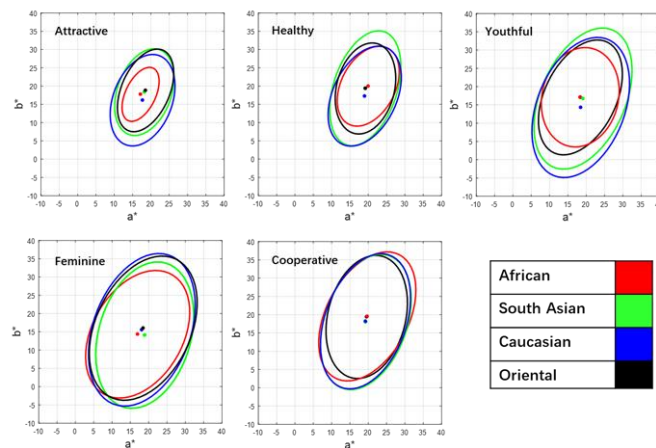

Figure 5: The 50% tolerance ellipses of four ethnic skin images for five impression attributes in CIELAB  $a^*b^*$  plane.

The results showed that all ellipses are quite consistent in shape and orientation except the size. All observers scaled attractive and healthy the most consistent, followed by cooperative and the youthful and feminine the least, i.e., a larger size of ellipse, the more observer variation.

The following analysis is to investigate the effect of impressions. The results between two impressions were first plotted and their correlation coefficients (r) were reported. They are listed in Table 2. It can be seen good agreement between attractive and healthy (r=0.95), between youthful and feminine (r=0.98), between cooperative and healthy (0.92).

	Attractive	Healthy	Youthful	Feminine	Cooperative
Attractive	1.00	0.95	0.87	0.80	0.90
Healthy		1.00	0.80	0.71	0.92
Youthful			1.00	0.98	0.91
Feminine				1.00	0.88
Cooperative					1.00

Table 2: Correlations between the different attributes.

The above finding can be verified in Figure 6. It confirmed the earlier finding as attractive, followed by healthy, youthful, cooperative, and feminine from the most to the least observer consistent according to the size of ellipses (the smaller the ellipse, the more consistent). Comparing the 5 impressions for each skin type, some trends can be found:

Feminine impression to have least chroma, weakest, followed by attractiveness, youthful, and healthy and cooperative the strongest. This is most obvious for African skin type. In addition, feminine and youthful impressions are more reddish. Attractive and cooperative are slightly yellower than the others. Finally, all impressions are slightly redder than the other skin types for Caucasian.

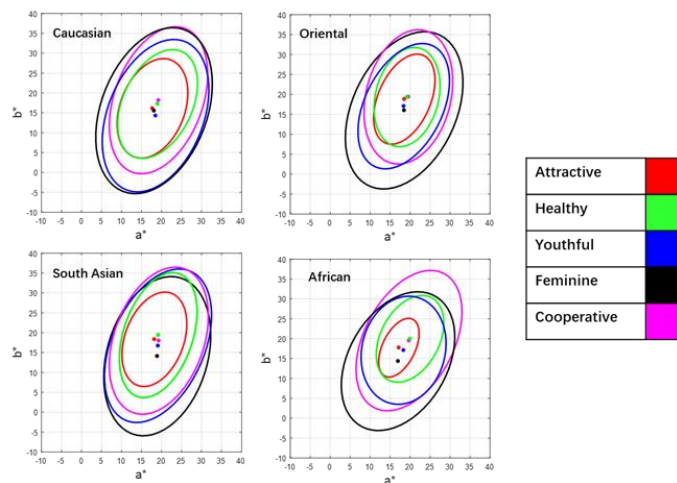

Figure 6: The 50% tolerance ellipses of five impression attributes for four ethnic skin images in CIELAB a\*b\* plane.

Finally, it was also found that in L\*C\*<sub>ab</sub> plane, the 5 impressions were located following a line from the white point [100,0]. This is known as saturation scale, or whiteness scale in the reverse direction (Cho 2017a; 2017b). The impressions follow a consistent trend, i.e. from the whitest, feminine, youthful, cooperative and cooperative, and the healthy (the most saturated) for all skin types. This agrees well with those found by Wang and Luo.

## CONCLUSIONS

This present study investigates the impact of skin colour affecting visual impressions in terms of attractive, healthy, youthful, feminine, cooperative. The images were rendered on colour calibrated mobile displays for 4 female models, representing the typical types of skin colours. The results were used to fit 50% tolerance ellipsoids. Its colour centre represents each of the 5 impressions. Its size indicates the 50% acceptance to define an impression region. Various relationships between different impressions for each skin type were revealed.

## REFERENCES

- Cho Y. J., L. C. Ou, G. Cui, and M. R. Luo. 2017a. New colour appearance scales for describing saturation, vividness, blackness, and whiteness. *Colour Research & Application* 42: 552–563.
- Cho Y. J., L. C. Ou, and M. R. Luo. 2017b. A cross-culture comparison of saturation, vividness, blackness and whiteness scales. *Colour Research & Application* 42: 203-215.
- Fink, B., K. Grammer, and R. Thornhill. 2001. Human (*Homo sapiens*) facial attractiveness in relation to skin texture and colour. *Journal of Comparative Psychology* 115: 92-99
- Fink, B., P.J. Matts, H. Klingenberg, S. Kuntze, B. Weege, and K. Grammer. 2008. Visual attention to variation in female facial skin colour distribution. *Journal of Cosmetic Dermatology* 7: 155-161
- Kang, H. R. 1995. Comparisons of three-dimensional interpolation techniques by simulations. In: *Proceedings of SPIE*: 104-114
- Luo M. R., G. Cui, and B. Rigg. 2001. The development of the CIE 2000 colour difference formula. *Colour Research & Application* 26: 340-350.
- Peng, R., M. R. Luo, M. Cao, Y. Zhu, X. Liu, and G. Liu. 2020. Preferred skin reproduction centres for different skin groups. In: *28th Colour and Imaging Conference*: 109-113.
- Stephen, I. D., V. Coetzee, and D.I. Perrett. 2011. Carotenoid and melanin pigment coloration affect perceived human health. *Evolution and Human Behavior* 32: 216-227
- Wang, M., and M. R. Luo. 2017. The impact of skin colour on facial impressions. In: *AIC 2017 Color Application*, Jeju, Korea: 09-05.
- Yuan, Y., L.-C. Ou, and M. R. Luo. 2011. Effects of Skin Tone and Facial, Characteristics on Perceived Attractiveness: A Cross-Cultural Study. In: *19th Colour and Imaging Conference: Society for Imaging Science and Technology*: 253-259
- Zeng, H. and R. Luo. 2009. Modelling skin colours for preferred colour reproduction. In: *17th Colour and Imaging Conference: Society for Imaging Science and Technology*, 175-180.
- Zeng, H. and M. R. Luo. 2013. Colour and tolerance of preferred skin colours on digital photographic images. *Colour Research & Application* 38: 30-45

# Quantifying facial colour appearance of Caucasian and Chinese faces

Yan Lu <sup>1</sup> and Kaida Xiao <sup>1,\*</sup>

<sup>1</sup> University of Leeds; sdyl@leeds.ac.uk, k.xiao1@leeds.ac.uk

\* Corresponding author: k.xiao1@leeds.ac.uk

## Abstract

This research is aimed to better understand human perception of skin colour and quantify the overall colour appearance of human faces. In this study, a colour matching experiment was conducted and the overall facial colour appearance of 80 facial images, including 40 Caucasian faces and 40 Chinese faces, were obtained. The main finding of this study is that the overall facial colour appearance is different from the average colour in facial area at a very significant level ( $p < 0.001$ ). Overall, the facial colour appearance perceived by people are less reddish, less yellowish, and much lighter. Moreover, the overall facial colour can be quantified accurately by linear regressions of average pixel colour calculated in the facial area ( $R^2 > 0.912$ ). The results will be used in further study to test colour appearance models for facial skin, and to support studies predicting facial attractiveness based on the accurate facial colour appearance.

**Keywords:** *facial colour appearance, Caucasian, Chinese*

## INTRODUCTION

Colour is the most common but crucial visual sensation to human. The facial colour appearance describes what the colour stimuli of facial skin look like in human colour vision. It has been a subject of great interest in many areas of science and technology including dermatology, cosmetology, computer graphics, and computer vision. There is an increasing number of applications that need to quantify skin colour appearance and reproduce it accurately. For example, accurate skin colour reproduction is considered as an indicator of good quality for many products in imaging industry such as the display and the camera (Imai et al. 1996); colour matching to the surrounding skin is extremely important in patients wearing maxillofacial prostheses (Sohaib et al. 2018; Xiao et al. 2013).

Although facial skin colour of a certain point can be measured easily instruments like tele-spectroradiometers and spectrophotometers based on CIE colourimetry, such measurements cannot include the overall skin colour information and all the facial characteristics including chromatic features, colour variations, contrast, etc. On the other hand, subjective evaluation is also widely used to quantify skin colour appearance in cosmetics and dermatology. However, the relationship between colour perception and colorimetric values of a human face is not clear so far, and what is the overall colour appearance of a human face remains unknown to us.

The impact of facial colour appearance on attractiveness assessment has been studied and those studies have commonly used average skin colour specified in CIELAB colour space to represent the overall facial colour appearance (Foo et al. 2017; Lefevre and Perrett 2015; Tan and Stephen 2019) The overall facial skin lightness, redness and yellowness have been simply represented by the mean  $L^*$ ,  $a^*$  and  $b^*$  values of the facial skin area respectively. Though in CIELAB system,  $a^*$  and  $b^*$  represents the value along red-green and yellow-blue dimensions, it is unknown whether these colorimetric values are equivalent to the subjective colour perceptions of facial skin.

Furthermore, existing studies have shown that, in terms of visual perception, the facial colour appearance is largely different from the colour appearance of any other objects. Yoshikawa et al. found that perceived facial whiteness is largely influenced by chroma and hue, which was not found in the perception of uniform colour patch (Yoshikawa et al. 2012). Shimakura et al. found inverse effect of

saturation on brightness on the perception of colour appearance of face and uniform colour patch (Shimakura and Sakata 2019). Hasantash et al. tested different light conditions and found in some lighting conditions, the impact of memory on color perception is greatest for face color compared to other colours (Hasantash et al. 2019). Obviously, the universal colour appearance model does not fit skin colour considering its particularity and complex physical properties.

To find the colour appearance model adequate for accurate prediction of appearance of human complexions, it is critical to first define the overall facial colour appearance. Thus, this study is designed to better understand human perception of skin colour and to quantify the overall colour appearance of human faces.

## EXPERIMENT

### Stimulus description

Eighty real facial images, including 40 Caucasian images and 40 Chinese images, all with a neutral facial expression, selected from the Liverpool-Leeds Skin-colour Database (LLSD) were used in this study. In the meanwhile, eighty corresponding colour patches were generated using MATLAB. Each uniform colour patch has the same shape as the corresponding facial image, and the initial colour was approximately the overall mean colour of each pixel in the facial area of the image. A BenQ professional colour display, with the white point set to D65, was used to display the facial images as well as the colour patches. The model of gain-offset-gamma (GOG) was implemented for the colour characterization of the display colorimetric transformation, with  $0.59 \Delta E^*_{ab}$  unit of accuracy averaged from 20 skin colour samples as testing colours.

### Study design and observers

A Colour matching experiment was carried out in a dark room using a self-compiled MATLAB program on display. Figure 1 shows an example of the experimental interface. There is a facial image on the left of the screen and a same-shape colour patch on the right. The observers were asked to adjust the patch colour without any time limit until they produced a match between the overall colour appearance of the facial image and the colour of the colour patch based on their colour perceptions. After completing one match, the next set of facial image and colour patch would appear automatically.

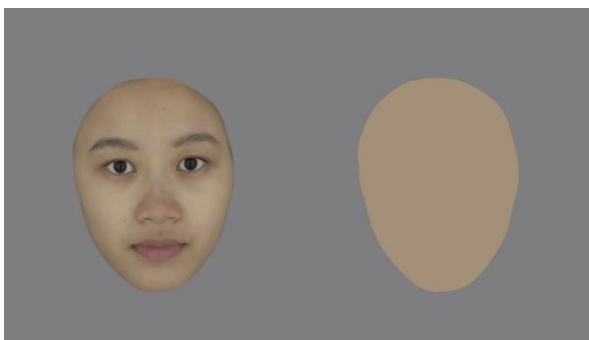

Figure 1: An example of the experimental interface.



Figure 2: Keyboard control for patch colour adjustment.

All the colour control of the patch was achieved through the keyboard. As Figure 2 shows, six adjacent keys outlined on the keyboard were used to adjust the patch colour along the  $L^*$ ,  $a^*$  and  $b^*$  dimensions in CIELAB colour space, roughly altering facial lightness, redness, and yellowness,

respectively. Space is used to save the match results of present face and show the next face. The function key is used to restore the default patch colour.

Twenty-two observers (10 males and 12 females) with normal colour vision have taken part in the experiment (mean age  $\pm$  SD =28.00  $\pm$  5.27). After 5-min dark adaption, the observers were given the experimental instructions and started a training session before the formal experiment to learn how to adjust the colour of the patch colour through keyboard control before the experiment. The 80 facial images were shown in a random order and 10 randomly selected facial images were repeated to test the consistency of each observer. Totally, each observer matched the overall colour appearance of 90 facial images.

### Statistical analysis

The matched patch colour, in terms of display RGB values, of each image and each observer was recorded during the experiments. The mean matched colour overall observers for each image were then calculated and transformed into CIELAB colour coordinates based on the display characterization model. The observer variability including the inter- and intra- observer variability was evaluated first in terms of mean colour differences from the mean (MCDM). The average colour and matched colour were compared, and their colour difference was calculated. The repeated measures ANOVA was carried out to further illustrate the difference between the average colour and the matched colour regarding to different colour specifications. Linear regressions were performed to quantify the overall facial colour appearance.

## RESULTS AND DISCUSSION

### Observer variability

The inter-observer variability was evaluated per facial image by calculating the colour difference  $\Delta E^*_{ab}$  between the matched colour of an individual observer and the mean matched colour over all observers and then taking the mean. The mean inter-observer MCDM values calculated for all 80 faces is 2.19  $\Delta E^*_{ab}$  unit (Caucasian faces: 2.11, Chinese faces: 2.26). The Intra-observer variability was assessed by calculating the MCDM, regarding to each observer's mean colour difference for the 10 repeated facial images and then averaging over each observer. The mean intra-observer MCDM values is 2.23. The results indicated both the high consistency and repeatability of observers.

### Average colour vs. Matched colour

The mean colour difference between the average colour and the matched colour of 80 facial images is  $3.28 \pm 0.53 \Delta E^*_{ab}$  unit (Caucasian faces:  $3.20 \pm 0.50 \Delta E^*_{ab}$ ; Chinese faces:  $3.35 \pm 0.58 \Delta E^*_{ab}$ ). Figure 3 shows the colour shift from the average pixel colour (hollow points) to the matched facial colour appearance (solid points) of 40 Caucasian faces (blue lines) and 40 Chinese images (orange lines) in  $a^*b^*$  plane and  $L^*C^*$  plane in CIELAB colour space. It is obvious that the actual facial colour appearance perceived by observers is different from the average facial colour. The colour shift of both Caucasian faces and Chinese faces showed the similar trend that the actual matched facial colour appearance had lower  $a^*$  values, slightly lower  $b^*$  values and much higher  $L^*$  values compared to the average facial pixel colour.

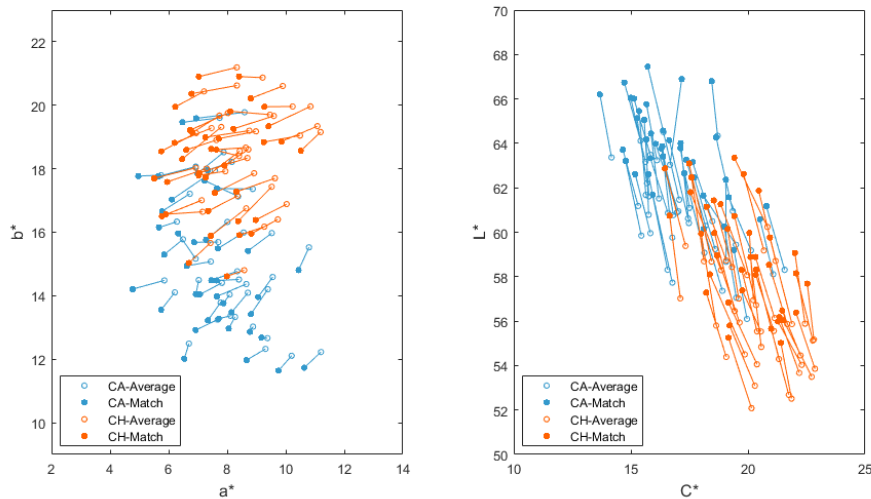

Figure 3: Colour shift from the average colour (hollow points) to the matched colour (solid points) of Caucasian faces (blue lines) and Chinese faces (orange lines).

To further illustrate and quantify the difference between the average colour and the matched colour regarding to different colour specifications, the repeated measures ANOVA with the colour appearance (before and after match) as repeated measure and the face ethnicity as between-subject factor was carried out for  $a^*$ ,  $b^*$ , and  $L^*$ , respectively (Figure 4).

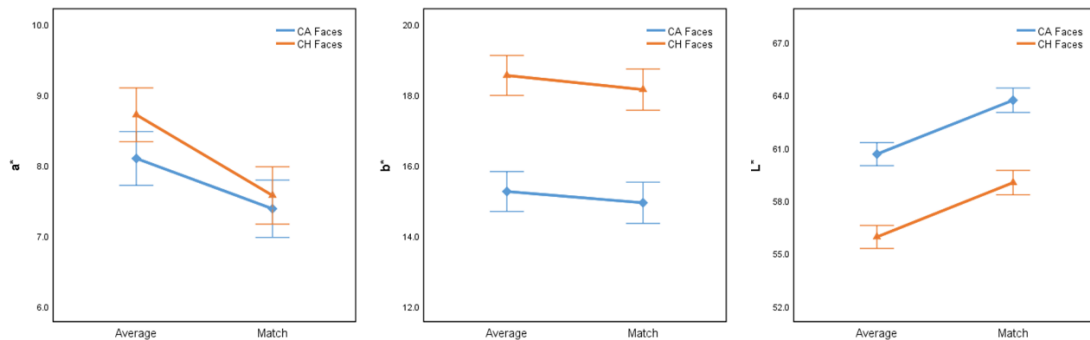

Figure 4: The difference between the average and the matched colour:  $a^*$  (left),  $b^*$  (centre),  $L^*$  (right),  $\blacklozenge$  Caucasian faces (CA),  $\blacktriangle$  Chinese faces (CH). The error bars indicate 95% confidence intervals.

After colour matching, the  $a^*$  decreased significantly after match ( $F=697.782, p<0.001$ ). There is also an interaction between colour perception and face ethnicity ( $F=37.387, p<0.001$ ), where the  $a^*$  of Chinese faces was reduced more than Caucasian faces. There was no significant main effect of face ethnicity indicating the skin colour of the two ethnicities were quite consistent with the facial redness. The  $b^*$  also decreased significantly after matching ( $F=114.550, p>0.001$ ) and origin  $b^*$  of Chinese faces are significantly higher than Caucasian faces ( $F=63.672, p<0.001$ ). There is no interaction effect between colour perception of  $b^*$  and face ethnicity. As for the lightness ( $L^*$ ), matched colour appearance was significantly lighter than the average lightness of face ( $F=2403.595, p<0.001$ ). Caucasian faces are originally lighter than Chinese faces ( $F=97.437, p<0.001$ ). No interaction was found between lightness perception and face ethnicity.

Overall, the facial colour appearance perceived by people are less reddish, less yellowish, and much lighter compared to the average facial colour used commonly in previous research.

**Model the overall facial colour appearance**

Based on the positive associations between the average colour specifications and the matched colour specifications, it was possible to carry out a regression analysis to predict the overall facial colour appearance from the average pixel colour. Figure 5 shows the linear regressions with regression lines. These models are all statistically significant at less than 0.001 level. The average pixel colour  $\bar{a}^*$ ,  $\bar{b}^*$ ,  $\bar{L}^*$  respectively explained 91.2 per cent, 98.5 per cent, and 97 per cent of the variance in the prediction of the perceived facial colour appearance  $a^*$ ,  $b^*$ , and  $L^*$ .

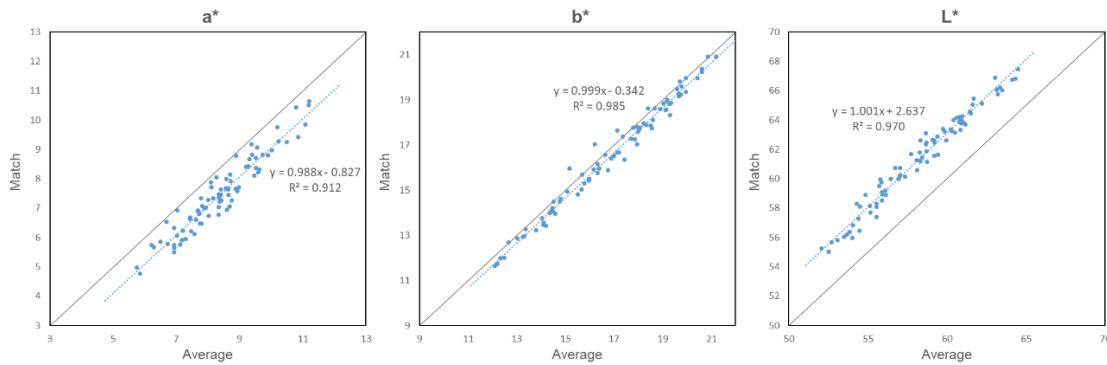

Figure 5: The linear regressions of the average pixel colour on matched colour appearance with regression lines: a\* (left), b\* (centre), L\* (right).

Though the current model promises a relatively good accuracy for facial colour appearance quantification (more than 90 per cent of the variance are explained), some attempts have been made to exclude the outlines and optimise the regression models of predicting overall facial colour appearance. Considering the presence of other skin features such as wrinkle, acne, moles, pores, hairs, and the shadows and highlights generated by these things, we hypothesise that our vision system would recognize these features and filter this colour information since they are not normal skin colour. In this respect, the trimmed mean colour was calculated in MATLAB to remove a designated percentage of the largest and smallest values before calculating the mean, and then the colour difference between the matched colour and the trimmed mean colour was examined. As Figure 6 shows, the  $\Delta E_{ab}^*$  does decrease a bit as more outliers are excluded. The extreme value of trimmed mean is the median, which left 2.97 unit of  $\Delta E_{ab}^*$  still. The results indicates that, in the perception of facial colour appearance, our vision system tends to filter out some unusual colour information on skin appearance, but only to a lesser extent.

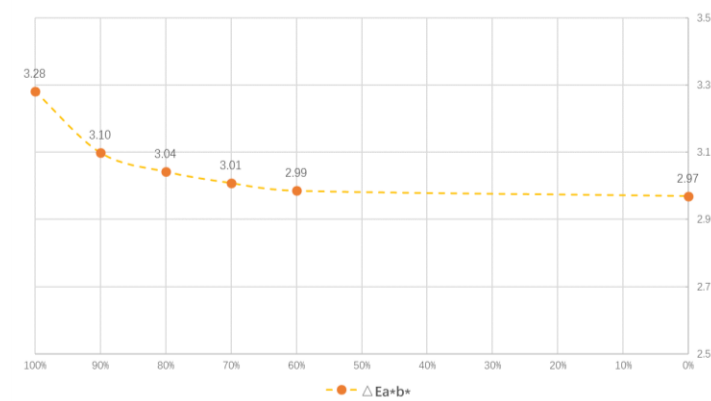

Figure 6: The  $\Delta E_{ab}^*$  between the matched colour and the trimmed mean colour (excluding outliers).



## CONCLUSION

This study focused on the overall facial colour appearance with two research questions: (1) What is the perceived overall colour appearance of a human face? (2) How to quantitatively model this facial colour appearance? A colour matching experiment was conducted in this study and the main finding is that the overall facial colour appearance is different from the average colour in facial area which is commonly considered as facial colour appearance in previous studies, and the overall facial colour can be quantified by linear regressions of average pixel colour calculated in the facial area. Overall, the facial colour appearance perceived by people are less reddish, less yellowish, and much lighter compared to the average facial colour used commonly in previous research. The results will be used in further study to test colour appearance models for facial skin, and to support studies predicting facial attractiveness based on the accurate facial colour appearance.

## REFERENCES

- Foo, Y. Z., L. W. Simmons, and G. Rhodes. 2017. Predictors of facial attractiveness and health in humans. *Sci. Rep.* 7: 1-12. DOI:10.1038/srep39731
- Hasantash, M., R. Lafer-Sousa, A. Afraz, and B. R. Conway. 2019. Paradoxical impact of memory on color appearance of faces. *Nat. Commun.* 10: 1-10. DOI:10.1038/s41467-019-10073-8
- Imai, F. H., N. Tsumura, H. Haneishi, and Y. Miyake. 1996. Principal component analysis of skin color and its application to colorimetric color reproduction on CRT display and hardcopy. *J. Imaging Sci. Technol.* 40: 422-430.
- Lefevre, C. E., and D. I. Perrett. 2015. Fruit over sunbed: Carotenoid skin colouration is found more attractive than melanin colouration. *Q. J. Exp. Psychol.* 68: 284-293. DOI:10.1080/17470218.2014.944194
- Shimakura, H., and K. Sakata. 2019. Desaturation-Induced Brightness in Face Color Perception. *Iperception.* 10: 1-2. DOI:10.1177/2041669519854782
- Sohaib, A., K. Amano, K. Xiao, J. M. Yates, C. Whitford, and S. Wuerger. 2018. Colour quality of facial prostheses in additive manufacturing. *Int. J. Adv. Manuf. Technol.* 96: 881-894. DOI:10.1007/s00170-017-1480-x
- Tan, K.W., and I. D. Stephen. 2019. Skin color preferences in a Malaysian Chinese population. *Front. Psychol.* 10. DOI:10.3389/fpsyg.2019.01352
- Xiao, K., F. Zardawi, R. van Noort, J. M. Yates. 2013. Color reproduction for advanced manufacture of soft tissue prostheses. *J. Dent.* 41: e15–e23. DOI:10.1016/j.jdent.2013.04.008
- Yoshikawa, H., K. Kikuchi, H. Yaguchi, Y. Mizokami, and S. Takata. 2012. Effect of chromatic components on facial skin whiteness. *Color Res. Appl.* 37: 281-291. DOI:10.1002/col.20685

# Development of a measurement system for the optical properties of facial skin using a three-dimensional camera and projector

Kumiko Kikuchi <sup>1,\*</sup>, Shoji Tominaga <sup>2</sup> and Jon Y Hardeberg <sup>3</sup>

<sup>1</sup> Shiseido Co., Ltd MIRAI Technology Institute, Yokohama, Japan; kumiko.kikuchi1@shiseido.com

<sup>2</sup> Department of Computer Science, Norwegian University of Science and Technology, Gjøvik, Norway;  
Department of Business and Informatics, Nagano University, Ueda, Japan; shoji.tominaga@ntnu.no

<sup>3</sup> Department of Computer Science, Norwegian University of Science and Technology, Gjøvik, Norway;  
jon.hardeberg@ntnu.no

\* Corresponding author: kumiko.kikuchi1@shiseido.com

## Abstract

We have developed a system that measures the optical properties of facial skin together with the three-dimensional shape of the face. In measuring the three-dimensional shape of the face, our system uses a light-field camera to simultaneously provide a focused image and a depth image. The light source has a projector that produces a high-frequency binary illumination pattern to separate the subsurface scattering and surface reflection from the facial skin. Using a dichromatic reflection model, the surface reflection image of the skin can be separated further into a specular reflection component and a diffuse reflection component. The method presented here provides new possibilities in the field of cosmetology and skin pharmacology.

**Keywords:** *Subsurface scattering, skin, light field camera, specular reflection, diffuse reflection*

## INTRODUCTION

The quantitative assessment of human skin for its visual qualities, including skin radiance, skin gloss and skin translucence, is a subject attracting great interest in the fields of color science, dermatology, cosmetology and computer graphics.

When light from the exterior is incident on the skin, part of the light is reflected from the skin's surface and the remainder penetrates the skin.(Anderson and Parrish 1981) On the skin's surface, specular reflection is affected by a thin emulsified film resulting from the presence of sebum, in addition to being affected by the contours of the face and the geometric heterogeneity of the surface roughness due to pores, fine wrinkles and other irregularities.(Bargo and Kollias 2010) Light that has entered the interior of the skin is reflected diffusely by the microstructure of the stratum corneum.(Jiang and DeLaCruz 2011) The stratum corneum is generally clear and colorless and there is usually little light absorption within this layer, which allows the light to continue and reach the deeper skin layers, including the epidermis, dermis and beyond. There, the light is absorbed by skin pigments, including melanin in the epidermis and hemoglobin in the dermis, and as a result, some of the light then exits the skin through subsurface scattering.

Several methods have been proposed to separate and measure the optical properties of skin, including the specular reflection, diffuse reflection and subsurface scattering of the skin. The main method used for the separation and measurement of the specular reflection component involves the use of two polarizing plates (Bargo and Kollias 2010; Matsubara et al. 2012). In addition, several methods have been proposed to separate and measure the subsurface scattering from the skin. The method of grid pattern projection observes the distribution of the subsurface scattering from the skin in a two-dimensional image by scanning a grid pattern projected on the skin (Nayer et al. 2006).

However, there are few examples of the development of systems that can acquire all optical properties that affect the skin texture on the face in addition to acquiring the geometry of the skin.(Debevec et al. 2000; Weyrich et al. 2006; Ghosh et al. 2008) The purpose of the present study is

Development of a measurement system for the optical properties of facial skin using a 3D camera and projector to develop a system that can measure the geometrical shape and optical properties of facial skin simultaneously and thus obtain basic data that can be used for reference in many areas of applied research, including the confirmation of the effectiveness of cosmetics.

## ***DEVELOPMENT OF A SYSTEM THAT MEASURES THE OPTICAL PROPERTIES OF FACIAL SKIN***

### **System configuration**

We have developed a system that measures the optical properties of facial skin. The system comprises a light field camera and a lighting device and is installed in a darkroom. A light field camera (R-29; Raytrix GmbH, Kiel, Germany) is used because it is capable of acquiring three-dimensional (3D) information. The image sensor of the light field camera used in this study is a progressive scan-type charge-coupled device (CCD) with resolution of  $6576 \times 4384$  pixels. A focused image and a depth image that includes distance information can be obtained from a single shot acquired using only the one camera. The focused image obtained from the light field camera is a red-green-blue (RGB) 16-bit Tag Image File Format (TIFF) image with an image size of  $3288 \times 2192$  pixels. The focused image can be combined with the distance information to reconstruct the 3D surface. (Perwass and Wietzke 2012) A single-chip digital light processing projector (PJ WXC1110; Ricoh Co., Ltd., Japan) is used as the lighting device. The light source of the projector is an RGB light-emitting diode. The projector resolution is  $1280 \times 800$  pixels (Wide Extended Graphics Array or WXGA standard). This projector provides irradiance sufficient to acquire both 3D and color information from a participant's face and generates various lighting patterns to separate subsurface scattering from surface reflection from the facial skin.

### **Separation of the subsurface scattering component**

We adopt theory proposed by Kuwahara (2010) and a calculation method based on high-frequency illumination proposed by Nayar et al. (2006) to separate the total light reflected from one point on the skin into the surface reflection and subsurface scattering components. The projector placed in front of the participant's face generates white light illumination, where all the pixels of the projector emit white light, and binary square wave illumination, which comprises vertical stripes produced a repeating pattern of four white pixels and four black pixels. When the skin is illuminated with the binary square wave illumination in the darkroom, the light exiting from the illuminated point contains a surface reflection component and a subsurface scattering component; however, only the subsurface scattering component exits from an unilluminated point. In our system, 4 pixels of the projector is equivalent to a length of 1.0 mm on the skin. A point on the skin surface changes between an illuminated state and unilluminated state with the horizontal shifting of the projection of the high-frequency illumination. At each point on the skin, a maximum value ( $i_{\max}$ ) and a minimum value ( $i_{\min}$ ) are obtained from the brightness values for the same pixel in a set of patterned light projection images. Here,  $i_{\max}$  is the brightness value when the point is illuminated and  $i_{\min}$  is the brightness value when the point is not illuminated. By acquiring an image set through shifting the high-frequency illumination, the maximum and minimum brightness values are obtained at the same coordinates for each RGB channel. An image comprising the minimum brightness values corresponds to a subsurface scattered image.

### Separation of the specular and diffuse reflection components using the dichromatic reflection model

The specular and diffuse reflection components are separated in the following procedure based on a methodology (Higo et al. 2006) that considers that the object can be modeled with a dichroic reflection model.

Step 1: Calculate the hue, saturation and intensity in the hue-saturation-value (HSV) color space from the RGB values of all pixels in the surface reflection component image.

Step 2: Classify the pixels according to their hue values and plot the value of each pixel for which the hue value is constant on the saturation–intensity plane. On the saturation–intensity plane, the pixels that contain the specular reflection component have high intensity values and the pixels that contain the diffuse reflection component only have low intensity values in the iso-saturation region.

Step 3: Calculate the slope  $A$  of the straight line on which the pixels with the diffuse reflection component only are plotted for each classified hue value.

Step 4: By recalculating the intensity values using slope  $A$  and the saturation values, it is then possible to obtain the diffuse reflection component with the specular reflection component removed at each pixel.

Specifically, in Step 2, the pixels that contain the diffuse reflection component only can be extracted by selecting the minimum intensity value for each saturation value, as shown in Figure 1 (a). In Step 3, the intensity of the diffuse reflection component is determined from the saturation values for all pixels by obtaining the slope  $A$  of a straight line using the least squares method. By subtracting the constructed diffuse reflection component image from the surface reflection component image, it is then possible to calculate an image of the specular reflection component alone.

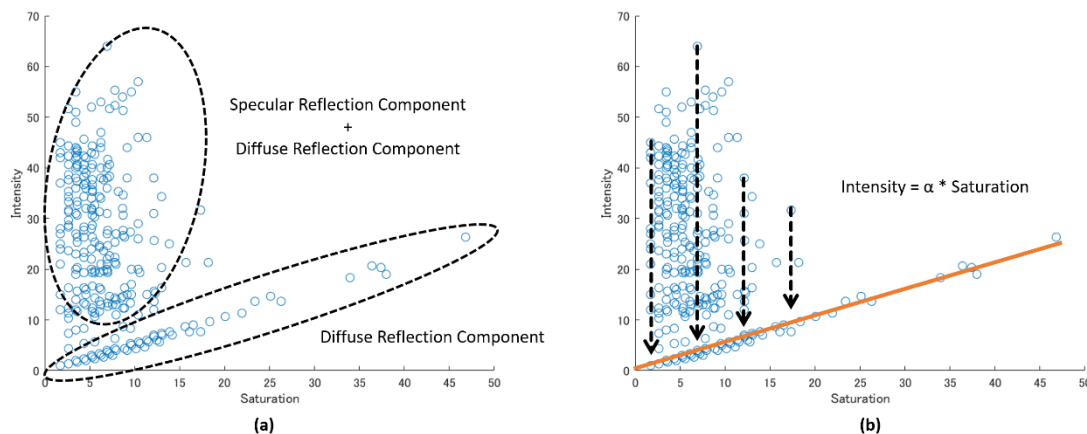

Figure 1: Separation of the diffuse reflection component from the specular reflection component using the dichromatic reflection model. (a) Plane with saturation and intensity values plotted for pixels with the same hue. The pixels that contain the specular reflection component have high intensity values and the pixels that contain only the diffuse reflection component have low intensity values in the iso-saturation region. (b) The intensity of the diffuse reflection component can be determined from the saturation values and the slope  $A$  of the straight line.

## RESULTS

### Features of each light component image

Figure 2 shows an example of the optical characteristics of the skin of one woman in her twenties. To protect the personal information of the subjects, the optical characteristics of each target subject's skin were morphed onto an average face created from the facial images of four subjects. The figure shows (a) a focused image acquired under white light illumination from the projector; (b) the subsurface scattering component image calculated via projection of the high-frequency patterned light; (c) the surface reflection component image calculated via projection of the high-frequency patterned light; (d) the diffuse reflection component image calculated using the dichromatic reflection model; (e) the specular reflection component image calculated by subtracting the diffuse reflection component image from the surface reflection component image; (f) an image that includes the diffuse reflection component and the subsurface scattering component. A comparison of the subsurface scattering component image in (b) with the surface reflection component image in (c) shows that the subsurface scattering component image is generally reddish whereas the surface reflectance component image is generally bluish. This result reflects the phenomenon that longer-wavelength light propagates more easily inside the skin than shorter-wavelength light. A comparison of the diffuse reflection component image in (d) and the specular reflection component image in (e) shows that the former is a smooth image that lacks high-frequency information whereas the latter contains fine textures. This is because the specular reflection component is the light component that is reflected from the skin's surface and is thus affected by the unevenness of the skin's surface due to pores and fine wrinkles. In addition, the images confirm that there is strong specular reflection from the forehead and the tip of the nose.

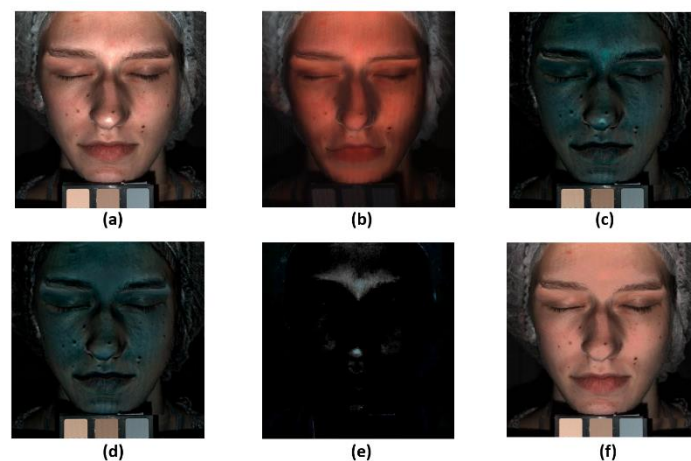

Figure 2: Separation of the optical properties of the skin of subject A, who is in her twenties. (a) Focused image acquired with white light illumination from the projector. (b) Subsurface scattering component image calculated through projection of the high-frequency patterned light. The output value from each RGB channel of the subsurface scattering component image was multiplied by 1.5 and then displayed for easy visual confirmation. (c) Surface reflection component image calculated through projection of the high-frequency patterned light. (d) Diffuse reflection component image calculated using the dichromatic reflection model. (e) Specular reflection component image calculated by subtracting the diffuse reflection component in (d) from

Development of a measurement system for the optical properties of facial skin using a 3D camera and projector the surface reflection component in (c). (f) Image including the diffuse reflection component in (d) and the subsurface scattering component in (b).

## **DISCUSSION**

In this work, we developed a measurement system that divides the light reflected from facial skin into the subsurface scattering component, diffuse reflection component and specular reflection component and acquires the three-dimensional shape of the subject's face.

The use of a light field camera allows the system to acquire the facial shape information in a single shot. This system can measure the skin condition of each subject in a short time from a remarkably small number of images when compared with other methods and it is thus suitable for use in confirming the effectiveness of a variety of cosmetics and external skin preparations.

Our system separates the diffuse and specular reflections using a traditional dichromatic reflection model, whereas some recent studies have proposed a method that uses the differences between images obtained with different microlenses of a light field camera to separate the specular reflection.(Tao et al. 2015) In addition, our system separates the subsurface scattering and surface reflectance components using high-frequency illumination, whereas other methods that separate the subsurface scattering into shallow scattering and deep scattering components have been reported.(Ghosh et al. 2008) It would thus be interesting to compare the skin optical property parameters obtained with these different optical separation methodologies with the parameters obtained using our system. Another important research topic will be to determine how each of the optical property parameters obtained using the proposed system affects the perception of texture aspects such as the glossiness, transparency and dullness of the skin. We intend to clarify the relationships between the physical indices of the optical properties and the perception of skin texture and thus contribute to the development of skin texture research.

## **CONCLUSION**

We developed a measurement system that divides the light that is reflected from facial skin into the subsurface scattering component, diffuse reflection component and specular reflection component while also acquiring the three-dimensional shape of the subject's face. This system is expected to be applied not only to skin texture research but also to the confirmation of the effectiveness of various cosmetics and external skin preparations.

## **REFERENCES**

- Anderson, R. R. and J.A. Parrish. 1981. The optics of human skin. *Journal of investigative dermatology* 77: 13-19.
- Bargo, P. R. and N. Kollias. 2010. Measurement of skin texture through polarization imaging. *British Journal of Dermatology* 162: 724-731.
- Debevec, P., T. Hawkins, C. Tchou, H.P. Duiker, W. Sarokin, and M. Sagar. 2000. Acquiring the reflectance field of a human face. In *Proceedings of the 27th annual conference on Computer graphics and interactive techniques*. 145-156.
- Ghosh, A., T. Hawkins, P. Peers, S. Frederiksen, and P. Debevec. 2008. Practical modeling and acquisition of layered facial reflectance. In: *Proceedings of ACM SIGGRAPH Asia 2008*. 1-10.

- Development of a measurement system for the optical properties of facial skin using a 3D camera and projector
- Higo, T., D. Miyazaki, and K. Ikeuchi. 2006. Realtime removal of specular reflection component based on dichromatic reflection model. *IEICE PRMU* 106.230: 77-84.
- Jiang, Z. X. and L. DeLaCruz. 2011. Appearance benefits of skin moisturization. *Skin Research and Technology*. 17: 51-55.
- Kuwahara, T. 2010. *Measurement of Skin Translucency KOGAKU [ISSN: 0389-6625]*. 39:524-528.(in Japanese)
- Matsubara, A., Z. Liang, Y. Sato, and K. Uchikawa. 2012. Analysis of human perception of facial skin radiance by means of image histogram parameters of surface and subsurface reflections from the skin. *Skin Research and Technology*. 18: 265-271.
- Nayar, S. K., G. Krishnan, M.D. Grossberg, and R. Raskar. 2006. Fast separation of direct and global components of a scene using high frequency illumination. In: *Proceedings of ACM SIGGRAPH 2006*. 935-944.
- Perwass, C. and L. Wietzke. 2012. Single lens 3D-camera with extended depth-of-field. In: *Proceedings of Human Vision and Electronic Imaging XVII. International Society for Optics and Photonics* Vol. 8291, p. 829108.
- Tao, M. V., J.C. Su, T.C. Wang, J. Malik, and R. Ramamoorthi. 2015. Depth estimation and specular removal for glossy surfaces using point and line consistency with light-field cameras. *IEEE transactions on pattern analysis and machine intelligence*. 38: 1155-1169.
- Weyrich, T., W. Matusik, H. Pfister, B. Bickel, C. Donner, C. Tu, J. McAndless, J. Lee, A. Ngan, H.W. Jensen, and M. Gross. 2006. Analysis of human faces using a measurement-based skin reflectance model. *ACM Trans. Graph. (SIGGRAPH 2006)* 25: 1013-1024.

# The Reference point for determining human facial skin tone

Katsuaki Sakata <sup>1,\*</sup> and Hitomi Shimakura <sup>2</sup>

<sup>1</sup> Joshibi University of Art and Design; sakata00031@venus.joshihi.jp

<sup>2</sup> Shiseido Global Innovation Center; hitomi.shimakura@shiseido.com

\* Corresponding author: sakata00031@venus.joshihi.jp

## Abstract

Perceptual judgment of facial skin tone is considered more sensitive than general perceptual judgment of color, and a slight change in facial tone can indicate whether one is ill or intoxicated. A reference point for discerning facial skin tone was demonstrated in the results obtained from the response probability for each elementary color indicated among 27 participants. Their responses were compared with five hypotheses regarding the viewer's skin color, skin color memory, the average skin color of the group to which the viewer belongs, and the skin color of the related educational material. Analyses results indicate the reference point is closest to the average facial skin tone of the belonging group; this fact suggests that people unconsciously memorize the facial skin tone of a person they see regularly and use the centroid as their reference for skin tone judgment.

**Keywords:** *facial skin tone, color perception, criterion of judgment, acceptability*

## INTRODUCTION

The detailed information obtained from other people's faces is believed to have critical implications for human as social animals. Previous studies have found that the perception of facial skin tone characteristically differs from perceptions of other colors (Lagouvardos et al. 2018; Shimakura and Sakata 2019; Tan and Stephen 2013; Yoshikawa et al. 2012). However, it has been reported that discrimination performance is not necessarily superior in the direction of human skin color. (Chauhan et al. 2019).

Human observers with normal trichromatic color vision can detect subtle changes in human skin color with a high degree of accuracy (Lagouvardos et al. 2018). Despite the vast diversity of human facial skin tone (Xiao et al. 2017), the fact that humans judge perceptibility and acceptability based on the natural appearance of facial skin tone (Leow et al. 2006) suggests that some psychological perception standards exist. In general, color perception sensitivity is modulated by adapting to the chromaticity distribution in the surrounding environment (Webster and Mollon 1997) and is influenced by the color memory experienced in a person's daily environment (Olkkonen et al. 2008). Notably, this influence reportedly differs between natural objects and uniform color patches (Hansen et al. 2008). Furthermore, researchers have reported that skin-color-based interracial judgments of health and attractiveness are easily compared with interracial judgments (Stephen et al. 2012) and that health judgments based on facial perception depend on the extent to which one's facial shape deviates from the average (Jones 2018). Hence, it seems that facial skin tone judgments must depend on the color perception of the surrounding human faces' skin color.

Color perception is always relative and is based on a comparison of light compared to an achromatic color or another standard. It is likely that a criterion for judging normal skin tone exists, as one can tell if someone is intoxicated or ill by perceiving changes in their facial skin tone, despite the fact that different races have a wide range of skin colors (Xiao et al. 2017). However, the exact tone which is universally considered the "standard" skin tone and color and how these attributes are determined have not been previously studied.

Therefore, we examined the following five hypotheses to determine which of them could be used to assess facial skin tone:



- Hypothesis 1: The centroid facial skin tone encountered in daily life: Facial skin tone is judged based on the facial skin tone of those observed in a person's daily life.
- Hypothesis 2: The centroid facial skin tone of one's generation: Facial skin tone is judged based on the skin tone of the other members of a person's generation that they encounter in daily life.
- Hypothesis 3: The measured value of one's facial skin tone: Facial skin tone is judged based on one's own skin tone.
- Hypothesis 4: The memory color of one's facial skin tone: Facial skin tone is judged based on the color of their skin tone as they remember it.
- Hypothesis 5: The skin color taught in one's childhood, i.e., the "skin color" according to JIS (Japanese Industrial Standards): Facial skin tone is judged based on the color of one's childhood drawing materials.

## EXPERIMENT

### Methods

#### *Stimuli and procedure*

The stimuli presented in this study comprised one uniform stimulus (a) and four varied face stimuli (b–e). The uniform stimulus was the same size as the face stimuli and was a "Rectangular uniform patch". The face stimuli comprised an "East Asian face," consisting of an average face image of Japanese female faces aged 39 years (d), and a "Caucasian face," which was an average face image of Caucasian female faces aged 39 years (e), as well as "Scrambled (47 × 36)" (b) and "Scrambled (4 × 3)" images (c), which were scrambled images of panel (d) as variations of the face stimuli (Figure 1). The stimulus color was a color variation of 36 chromaticities that divided the range of approximately  $1\sigma$  of the facial skin tone distribution of Japanese females aged 20–59 years into six steps,  $a^*$  and  $b^*$ , respectively, and the average chromaticity was  $L^* = 66$ ,  $a^* = 9$ , and  $b^* = 18$  (Figure 2). Each participant completed 3240 trials in total (36 chromaticities × 18 repetitions × 5 images), and the entire experiment took approximately 2.5 h.

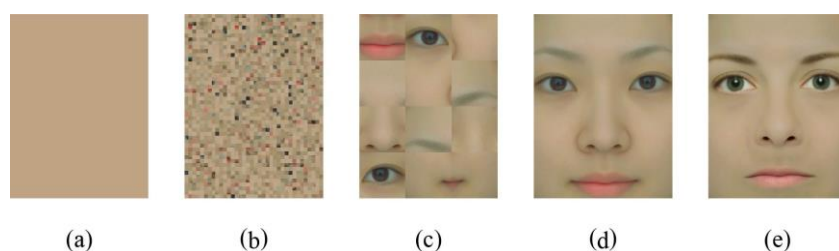

Figure 1: The stimulus images presented in the Experiment. (a): "Rectangular uniform patch," a uniform patch of the same size as the face images; (b): a scrambled face image divided into 47 × 36; (c): a scrambled face image divided into 4 × 3; (d): the "East Asian face" image; (e): the "Caucasian face" image.

A stimulus was displayed at the center of the monitor screen for 500 ms after a fixation cross was displayed for 500 ms, followed by a random dot pattern with an average luminance identical to the grey background for 500 ms. Participants completed a five-alternative forced-choice test in which they were asked to judge the color they perceived more strongly among red, yellow, green, blue, and white when compared to their perceived normal facial skin tone.

### Data analysis

The selection rates of red, yellow, and white uniformly increased and decreased as the chromaticity changed, and the chromaticity at which the selectivity reached 50% was regarded as the border of facial skin tone acceptability.

The criterion for judging facial skin tone was assumed to be the centroid-acceptable skin tone, which was defined as the point equidistant from each color border (Figure 3). This coordinate of the criterion for each participant's judgment was calculated, and the distance between the coordinate criterion and each hypothesis point was determined for each type of stimulus image: the distance between the center of the criteria and the centroid facial skin tone of Japanese females aged 20–59 years for hypothesis 1; the distance between the center of criteria and the centroid facial skin tone of Japanese females aged 20–39 years ( $a^* = 9$ ,  $b^* = 17$ ) for hypothesis 2; the distance between the center of criteria and the measured chromaticity of the observer's own facial skin tone for hypothesis 3; and the distance between the center of criteria and the chromaticity of the observer's memory of skin color chosen after trials, and the distance between the center of criteria and "the skin color in JIS " ( $a^* = 17$ ,  $b^* = 22$ ; Japanese Industrial Standards, 2007) for hypothesis 4.

The effects of the hypothesis and stimulus image type were analyzed statistically using a 2-way analysis of variance (ANOVA) after confirmation of the equality of variances using Levene's test, and each of the main effects of each factor was confirmed through multiple comparisons of the t-test with Bonferroni correction.

Figure 2: The chromaticities of stimuli

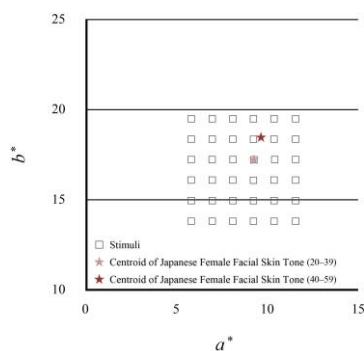

The 36 chromaticities of the experimental stimuli (empty squares), the centroid facial skin tone of Japanese females aged 20–39 years (light red star), and the centroid facial skin tone of Japanese females aged 40–59 years (dark red star).

### Participants

The experiment included a total of 27 Japanese females between the ages of 20 and 39 years who had never participated in a color vision experiment. The experiment participants provided written informed

Figure 3: The criterion for judging facial skin tone

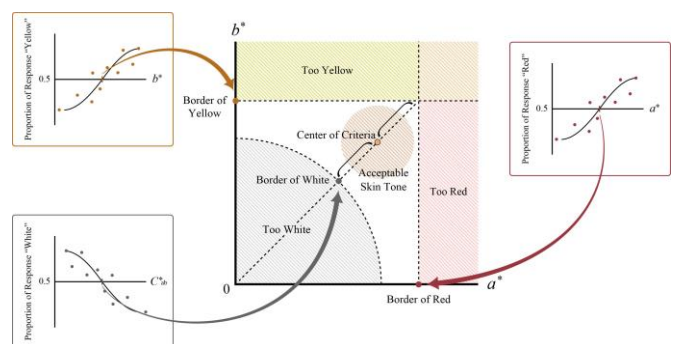

The acceptable facial skin tone border was defined as chromaticity with 50% of the selection probability of red, yellow, and white colors. They were judged as "too strong" by the participants when viewing the facial-image stimulus; the centroid of this area was regarded as the criterion in judgment.

consent for their participation and data (including optical measurement data) to be published in a scientific journal, with the understanding that their name and/or personal information will not be made public.

## RESULTS

Figure 4(a) depicts the average of the distances of the image from the center of the judgment criteria to each of the hypotheses' reference points for each stimulus image. The centroid facial skin tone value of Japanese females and Caucasian females ( $L^* = 60$ ,  $a^* = 12$ ,  $b^* = 15$ ) were calculated and compared from a previous study (Xiao et al., 2017). Pairwise comparisons of the combined data from all the stimulus image conditions revealed that the distance to the centroid facial skin tone of Japanese females aged 20–39 years differed significantly from all other hypothesis data ( $p < 0.0001$ ), with the exception of the facial tone of Japanese females aged 40–59 years ( $p = 0.076$ ).

The centers of the criteria for each stimulus image were plotted against the centroid facial skin tone of Japanese females aged 20–39 years, that of Japanese females aged 40–59 years, the centroid of Caucasian facial skin tone (Xiao et al. 2017), and the JIS skin tone, which includes the colors of some drawing materials used in primary educations, such as crayons and paint, are regulated in Figure 4(b). The analysis revealed that two stimulus images, “Rectangular uniform patch” and “Scrambled (47 × 36),” which were barely visible in the face image, were judged to have less redness than the other images. When the stimulus image was not perceived as a face, the judgment was that the redness appeared to be reduced.

Figure 4:

(a) The distance from the criteria's centers to the chromaticity of each hypothesis

(b) The locations of the center of the criteria for each stimulus

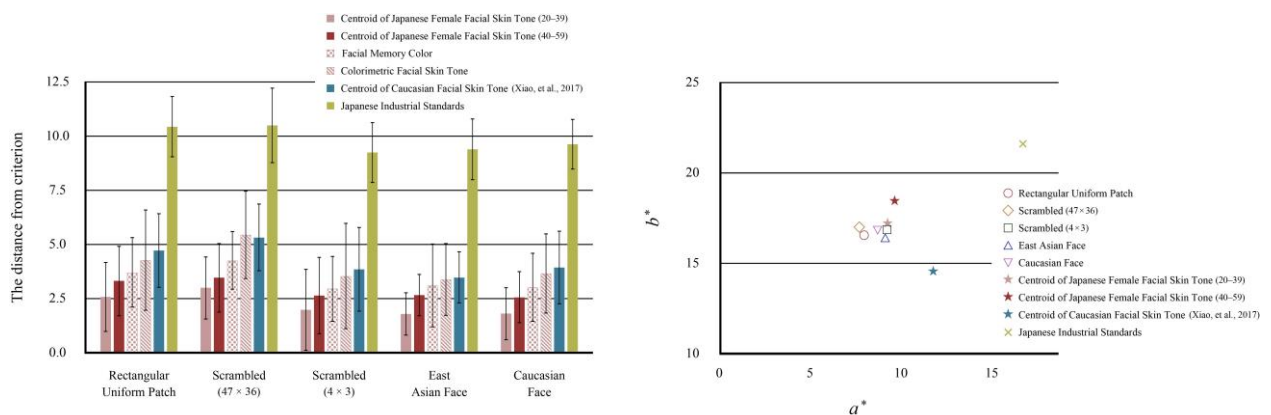

(a) We compared the distance between the center of the criteria and the centroid of each hypothesis to examine which one is closest to the center of the criteria. (b) An empty symbol represents the center of criteria for each stimulus, and star symbols represent the locations of the centroid facial skin tone of Japanese females aged 20–39, the centroid facial skin tone of Japanese females aged 40–59, and the centroid of Caucasian facial skin tone (Xiao et al., 2017). The cross represents the “skin color” according to the JIS.

## DISCUSSION

The center of judgment criteria was closer to the centroid facial skin tone of Japanese females aged 20–39 years than to other hypotheses' chromaticity. This result implies that the participants judged the color of the stimulus image relative to their own skin color. However, there was no significant difference in the distance to facial skin tone between those aged 20–39 years and those aged 40–59 years, implying that the participants judged the facial skin tone of the images based on the skin tone of all Japanese female faces but not to their own generation, which suggests that the participants judged the facial skin tone of the images based on the skin tone of all Japanese female faces, but not to that of their own generation. Moreover, the distance from the center of the judgment criteria to the facial skin tone of Japanese females aged 20–39 years was significantly smaller than the distance to the measured color of the participant's face and the distance to the memory color of the participant's own face, lending credence to this theory.

The distance between the center of judgment criteria for East Asian facial images and the centroid facial skin tone of Japanese females aged 20–39 years was minimal ( $\Delta a^*b^* = 1.8$ ). This distance is close to the threshold, indicating an accurate chromatic judgment of the facial skin tone regardless of asperity or shade. These findings are consistent with previous studies reporting that facial color perception is more accurate than other general color perceptions (Tan and Stephen 2013). The distances between the center of judgment criteria and the centroid facial skin tone in the "Rectangular uniform patch" and "Scrambled (47 × 36)" images were significantly larger than those in the "Scrambled (4 × 3)," "East Asian face," and "Caucasian face" images, suggesting that the recognition of human facial tone impacts facial skin tone judgment. This result also supports a previous study's conclusion that skin color gamut is not responsible for the small threshold in skin color perception (Chauhan et al. 2019).

Although the difference in participants' judgment for each stimulus figure was small and difficult to detect, participants frequently reported that green and blue shades appeared in the face stimuli; however, these colors did not exist colorimetrically in the face images. Interestingly this phenomenon was rarely reported by participants in response to the color patch stimulus. In the case of facial skin tone perception, it has been proven that these responses for green and blue colors (which do not exist colorimetrically) are paradoxical, derived from decreases in redness and yellowness, respectively, and appears to demonstrate the peculiarity of facial skin tone perception. This phenomenon was rarely observed in response to the "Uniform patch," but it did occur in response to the scrambled (47 × 36) stimulus image. A previous study (Shimakura and Sakata 2019) revealed no difference in the Helmholtz-Kohlrausch effect between fine-scrambled and rough-scrambled face figure images, but we found a significant difference in this experiment, possibly because the former study evaluated the effect of saturation, while this study evaluated color. Furthermore, the judgment of facial skin tone using a Caucasian face image as the stimulus did not differ from the trials using a Japanese face image. This result also suggests that in the judgment of facial skin tone, which is a judgement made based on "normal" Japanese skin color, recognition of a face is more important than skull structure or race of the person in the image, even though the face is known to be Caucasian.

The experiment results revealed that Japanese participants used the criterion point proximal to the centroid skin color of their local group as the centroid of skin color judgment, suggesting that we unconsciously memorize the facial skin tone of people we observe in our daily lives and judge facial skin tone using an "average" of those tones. The sensitivity of our color perception is adjusted by our adaptation to the color distribution of the surrounding environment (Webster and Mollon, 1997); thus, our color perception is influenced by the skin color of people in our daily environment (Hansen et al.

2008; Olkkonen et al. 2008). The perception of facial skin tone appears to be based on the adaptation to the skin color of those around us. Regardless of whether the face image was East Asian or Caucasian, the facial skin tone was judged based on the centroid skin color of each participant's group, which may suggest that the environmental effect on our color perception is superior to race or a priori knowledge in the judgment of facial skin tone.

## REFERENCES

- Chauhan, T., K. Xiao, and S. Wuerger. 2019. Chromatic and luminance sensitivity for skin and skinlike textures. *Journal of Vision* 19: 13. DOI: <https://doi.org/10.1167/19.1.13>
- Hansen, T., M. Giesel, and K. R. Gegenfurtner. 2008. Chromatic discrimination of natural objects. *Journal of Vision* 8: 2.1–19. DOI: <https://doi.org/10.1167/8.1.2>
- The Japanese Industrial Standards 2007. JIS S 6028: 2007 “Water colour paints,” Tokyo, Japan.
- Jones, A. L. 2018. The influence of shape and colour cue classes on facial health perception. *Evolution and Human Behavior* 39: 19-29. DOI: <https://doi.org/10.1016/j.evolhumbehav.2017.09.005>
- Lagouvardos, P., N. Spyropoulou, and G. Polyzois. 2018. Perceptibility and acceptability thresholds of simulated facial skin color differences. *Journal of Prosthodontic Research* 62: 503-508. DOI: <https://doi.org/10.1016/j.jpor.2018.07.005>
- Leow, M. E., R. K. Ow, M. H. Lee, C. Y. Huak, and R. W. Pho. 2006. Assessment of colour differences in silicone hand and digit prostheses: perceptible and acceptable thresholds for fair and dark skin shades. *Prosthetics and Orthotics International* 30: 5-16. DOI: <https://doi.org/10.1080/03093640500465096>
- Olkkonen, M., T. Hansen, and K. R. Gegenfurtner. 2008. Color appearance of familiar objects: effects of object shape, texture, and illumination changes. *Journal of Vision* 8: 13.1-16. DOI: <https://doi.org/10.1167/8.5.13>
- Shimakura, H., and K. Sakata. 2019. Desaturation-induced brightness in face color perception. *i-Perception* 10(3): 2041669519854782. DOI: <https://doi.org/10.1177/2041669519854782>
- Stephen, I. D., I. M. L. Scott, V. Coetzee, N. Pound, D. I. Perrett, and I. S. Penton-Voak. 2012. Cross-cultural effects of color, but not morphological masculinity, on perceived attractiveness of men's faces. *Evolution and Human Behavior* 33: 260-267. DOI: <https://doi.org/10.1016/j.evolhumbehav.2011.10.003>
- Tan, K. W., and I. D. Stephen. 2013. Colour detection thresholds in faces and colour patches. *Perception* 42(7): 733-741. DOI: <https://doi.org/10.1068/p7499>
- Webster, M. A., and J. D. Mollon. 1997. Adaptation and the color statistics of natural images. *Vision Research* 37(23): 3283-3298. DOI: [https://doi.org/10.1016/S0042-6989\(97\)00125-9](https://doi.org/10.1016/S0042-6989(97)00125-9)
- Xiao, K., J. M. Yates, F. Zardawi, S. Sueprasarn, N. Liao, L. Gill, C. Li, and S. Wuerger. 2017. Characterising the variations in ethnic skin colours: a new calibrated data base for human skin. *Skin research and technology* 23(1): 21-29. DOI: <https://doi.org/10.1111/srt.12295>
- Yoshikawa, H., K. Kikuchi, H. Yaguchi, Y. Mizokami, and S. Takata. 2012. Effect of chromatic components on facial skin whiteness. *Color Research and Application* 37(4): 281-291. DOI: <https://doi.org/10.1002/col.20685>

---

Note: The purpose of this study is to provide further scientific investigation in the field of facial skin tone. The authors of this paper hope to approach this subject with care and sensitivity, and in no way perceive any skin tone as being superior or more desirable.

# Munsell and Ostwald Color Spaces: A Comparison in the Field of Hair Coloring

Simone Liberini <sup>1,\*</sup> and Alessandro Rizzi <sup>1</sup>

<sup>1</sup> University of Milan, Milan (Italy); simone.liberini@gmail.com, alessandro.rizzi@unimi.it

\* Corresponding author: simone.liberini@gmail.com

## Abstract

Color science has had a very long history, dotted over the millennia with many contributions from the most diverse fields of human knowledge. At the beginning of the 20<sup>th</sup> century, Albert Henry Munsell, an artist formally trained in academia, and Friedrich Wilhelm Ostwald, Nobel prize for chemistry in 1909 and amateur painter, each envisioned and developed a color system with a related color atlas. Both authors recognized the importance of the visual relationship between colors, which they conceived as sensations stemming from, but not merely confined to, pigments and light. We hereby describe the salient features of these color spaces, their strengths and weaknesses, the authors' analogy of intents and divergence in execution. We then comment on how to employ them on a practical basis within an industrial setting, the cosmetic of human hair.

**Keywords:** *hair coloring, color atlas, Munsell, Ostwald.*

## COLOR-ORDER SYSTEMS

Decades of color science have seen the rise and fall of a variety of color attributes under the most different of theoretical and practical circumstances. Colorimetry has been providing us with plenty of color coordinates, yet not always do these describe color the same way we would in our everyday life. To name but the most famous, tristimulus values are as far removed from the layman's color terms as one could possibly imagine, whereas 'light' and 'dark', 'strong' and 'weak' are color attributes that all of us were implicitly taught about from the very early stages of our lives. Of course, this is not to say that colorimetry is a fanciful yet fruitless endeavor of the human mind. Rather, it is the acknowledgement that different mindsets may require different tools whenever the description of the boundless world of color is involved, so much so that a quick skim over its centuries-long history would seem to suggest the existence of an apparently unbridgeable divide between the figurative arts and the hard sciences. However fruitful, bridges have actually been built in the recent past, and it is with the intent of exploring two of them that this paper is written.

Both systems under scrutiny are examples of a so-called color-order system, which may be defined as a 'systematic and rational method of arranging all possible colors or subsets by means of material samples' (Graham 1985 through Choudhury 2015), or alternatively 'a set of principles for the ordering and denotations of colors, usually according to defined scales' (ISO/TC187 through Choudhury 2015). Both definitions highlight the need for a set of rationally devised ordering principles, ultimately meant to serve practical purposes. In this way science, or more properly a 'scientific' approach of sorts, meets the figurative and applied art's needs. The act of trying to order color is of course at least as old as the concept of color itself, but not so is science's contribution to the cause. In fact, it is only after Newton's *Opticks* that science truly began finding its way through the world of color, shaping it towards new possibilities whilst facing open acts of hostility and fierce opposition. Since we find the historical context to be instrumental to the topic, we begin with a short journey into the lives of A.H. Munsell and F. W. Ostwald.

**MUNSELL AND OSTWALD: TWO BIOGRAPHIES IN A SKETCH**

Born in Riga in 1853, Friedrich Wilhelm Ostwald (Figure 1 left) was a Baltic German Nobel laureate, perhaps best known to chemists for his many contributions to the field. He spent the second half of his life dealing with politics, philosophy, and art, himself being a passionate yet untrained artist. In 1914, the German Association of Craftsmen tasked him with the creation of a rational color atlas to be adopted by the flourishing German coloring industry, especially for the systematic creation and management of synthetic colorants (Shawelka 2018). Into this undertaking he poured his heart and soul, producing both an exhaustive atlas and a large body of related literature of which he felt incredibly proud.

On the contrary, neither scientists nor artists appreciated Ostwald's body of work. The former were mostly skeptical of a few issues that he seemed to have disregarded in favor of the beauty of his model, which he fervently considered a proof of formal correctness. The latter, for the most part, treated him with open contempt. During a lecture held in Stuttgart in 1919 to his associates, Ostwald exhibited the color-order system with the visual aid of his own pieces of art, only to be ridiculed for the chromatic unpleasantness of those old-fashioned «*paintings of little flowers*» of his. He was forced out of the Association, and so was his work from the art world. After a few years, a small number of artists reevaluated his Color Manual, but even then, it has been out of print since 1972 (Granville 1994).

Albert Henry Munsell (Figure 1 right) was born in Boston, Massachusetts, in 1858. There he trained at the Massachusetts Normal Art School, where he graduated in 1881 and was soon after hired as an instructor. Eager for more education, he travelled to Europe from 1885 to 1888, spending time at the École des Beaux Arts in Paris. His French stay was arguably a determining factor in the development of his later work (Cochrane, 2016). The academic tradition was beginning to crumble under the weight of the Impressionist *avantgarde*, but come the closing of the century, Impressionism itself was already being superseded by Neo-Impressionism. Also, science had long since set its firm grip on color.

Much of Munsell's endeavors are finely detailed in his personal journal, which he regularly filled in from the late 1880s up to his demise in 1918. Through it, we learn he was well aware of the raging scientific debate among physicists, physiologists, and psychologists about the nature of color. This was somewhat mirrored by the world of art. Impressionists maintained that a thorough comprehension and use of colors was innate, so it could not be taught at all. Neo-Impressionists, eager to delve into the latest scientific discoveries, identified color with spectral wavelengths entirely. On his part, Munsell chose not to busy himself with definitions. Instead, he set up a system to describe color whose modern survival is perhaps testimony to the wisdom of such choice.

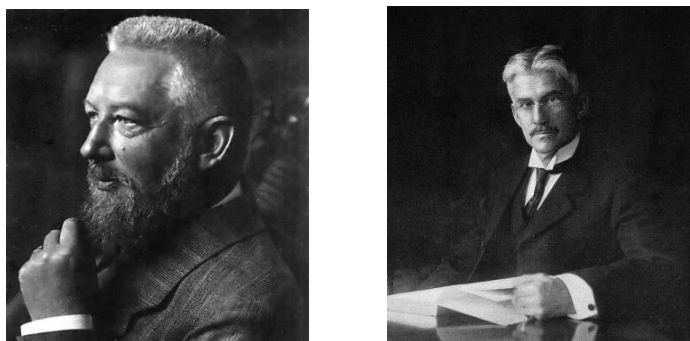

Figure 1: Friedrich Wilhelm Ostwald (left) and Albert Henry Munsell (right).

Before venturing into a description of Ostwald's and Munsell's works, a fundamental distinction must be made. A color-order system is, as already hinted at, a set of rules and principles by which every possible color can be described and ordered. A color manual, atlas, or book is a physical collection of color samples realized and arranged according to said rules and principles. For entirely practical reasons, these collections show but a limited subset of all perceivable colors, which are in the millions for a human observer with no color deficiencies.

### **OSTWALD'S COLOR HARMONY MANUAL**

Think of a three-dimensional object in our surrounding space, defined by its length, width, and height. Likewise, each and every color system must be based on three independent color attributes. Having set about to describe surface colors, Ostwald chose, quite unsurprisingly for a chemist turned painter, black content (B), white content (W), and full color (C) as his system-defining dimensions (Bond and Nickerson 1942). These contents must mix according to a very simple rule:  $C + W + B = 1$ . In other words, given a pigment, C, W, and B represent the proportions of pure color, white, and black that mix up as percentages of its overall amount. Pure colors ( $C = 1, W = B = 0$ ) are organized into a color equator much like a color wheel. Lying at the center of the circle, and perpendicular to it, is an axis representing neutral colors, i.e. the series of grays, going from pure black at the bottom ( $C = W = 0, B = 1$ ) to pure white at the top ( $C = B = 0, W = 1$ ). For each pure color, a triangle can be drawn that connects it to both white and black, which are in turn connected. The resulting overall shape is a double cone, each of whose sections is comprised of the common gray axis, a defining pure color, and of all intermediate colors given by mixtures of C, W, and B (Figure 2 left) at all times bound by the rule  $C + W + B = 1$ .

When trying to put this system into physical form, Ostwald eventually chose to split the color equator bearing Herring's red-green and yellow-blue opponencies in mind. He put yellow a half circle distance from ultramarine, and so he did with red and sea-green. By creating secondary and tertiary colors, he reached a total of twenty-four hues. The central axis was divided in ten steps instead, the bottommost pure black, the topmost pure white. To Ostwald's dismay, moving from the former to the latter in regular variations of pigment did not yield the expected result, i.e. a uniformly varying gray scale. Remembering the Weber-Fechner's law of perception, he adopted a logarithmic scale instead, which he applied to the outermost rows as well. The upper rows connecting white to pure colors, the so-called light clear series, are an exclusive mixture of white and pure color. The lower rows connecting black to pure colors, called dark clear series, of black and pure color. All the samples contained within these three outer boundaries are mixtures of pure color, white and black (Figure 2 right). Because of this, the model possesses three viewpoints: rows parallel to a light clear series contain the same level of black and are therefore called isotones; rows parallel to a dark clear series contain the same level of white and are therefore called isotints. Rows parallel to the gray axis are called shadow series.

The last step when defining a color-order system is providing it with a proper notation, a naming convention for users to identify and communicate colors rapidly and unequivocally within that system. In the 24-step version, each hue is denoted with a number from one to three and one or two capital letters. For instance, yellows are labeled 1Y, 2Y, 3Y, sea-greens 1SG, 2SG, 3SG, and so on and so forth. Each of the physically available eight steps in the gray axis is identified with a lowercase letter: 'a' for white, then 'c', 'e', 'g', 'i', 'l', 'n', and finally 'p' for black. These same letters are also used for white and black contents in the mixture: for instance, 3LGge is leaf-green number three, having a 'g' amount of white, to be read on the light clear series and prolonged on the isotint towards the gray axis, and intersected with an 'e' amount of black, to be read on the dark clear series and likewise prolonged on the isotone.





equal Value be placed on Maxwell's disk, e.g. red and blue-green, Value 5, in identical measure. Should they spin to a reddish gray, despite being mixed in equal proportion, then that particular red would intrinsically be more chromatic than the blue-green counterpart and should accordingly be placed further from the neutral axis. By repeating this experiment tirelessly for a set of Hues at different Values, not only did Munsell fully build his color-order system, but a first draft of a color atlas as well. Later, this was expanded and refined into the modern-day Munsell Book of Color, which boasts forty different hues with Values and Chromas whose only limit is set by the stability of currently available pigments on the market (Figure 3 right).

Every colored chip in the Book follows a standard naming convention in the form Hue Value/Chroma (H V/C). Hues are the combination of a numeral within the set 2.5, 5, 7.5, and 10, followed by capital letters symbolizing each of the ten main hues: R (red), YR (yellow-red), Y (yellow), GY (green-yellow), G (green), BG (blue-green), B (blue), PB (purple-blue), P (purple), and finally PR (purple-red). Values range in theory from 0 to 10, but in practice on the Book from 1 to 9.5. Finally, Chromas range from 2 to typically 12 or 14, depending on the Hue, but higher numbers will be attainable as soon as new stable pigments become available. For instance, 5R 4/12 represents a decidedly chromatic, medium-dark characteristic red, while 10PB 8/4 a somewhat weak, light purplish blue. Neutral colors, having neither Hue nor Chroma, are labeled as NV, V being a Value number. For instance, N1.5 is a very dark gray, N5 the middle gray, and N9 a very light gray.

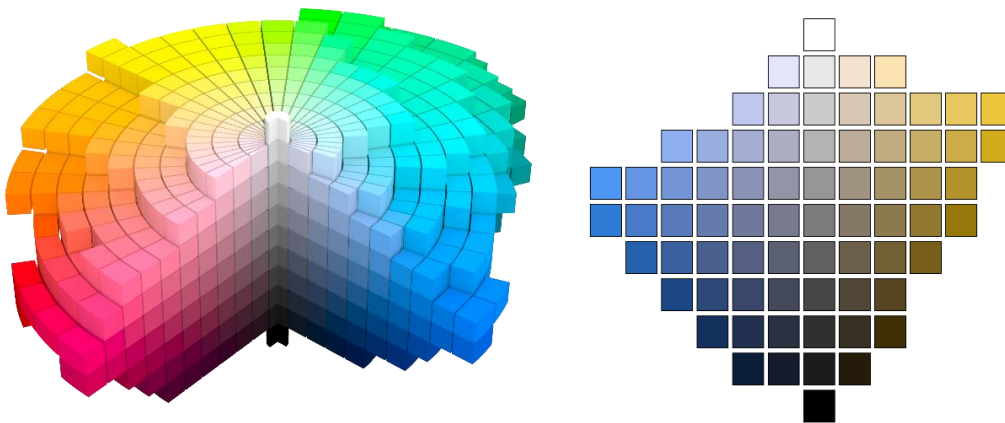

Figure 3: Three-dimensional representation of the 1943 Munsell renotations (left) (sRGB approximation with front portion cut away). Image credits: author SharkD, CC BY-SA 3.0 <<https://creativecommons.org/licenses/by-sa/3.0/>>, via Wikimedia Commons; (right) Digital representation of the hue couple 5PB – 5Y, which are opposite on the hue circle and as such also complementary. Notice the common neutral axis in the middle. Values can be read vertically from 0 (pure black, physically unavailable) to 10 (pure white, likewise). 5PB expands leftwards towards higher chromas, whereas 5Y rightwards. Maximum chroma is reached at different Values, giving the solid an overall irregular shape.

### **HAIR COLORING: OSTWALD OR MUNSELL?**

Both Ostwald and Munsell used pigments, and both their systems are aimed at ordering surface colors. Though results might seem similar, a fundamental difference lies at the core. Once made aware of the Weber-Fechner Law, Ostwald applied it extensively, satisfied with the purely quantitative nature of his method and adamant on its absolute correctness. Munsell, on the other hand, put the law to test against actual human perception. Ostwald's proportions of pigments are set in stone *a priori*, while

Munsell never mentions them explicitly. For Munsell, pigment mixtures are only useful as a means to an end, which lies within the colorist looking at a colored chip, not in the chip itself.

This has striking practical consequences. The Book consists of chips that are everywhere perceptually equidistant. Furthermore, all chips having the same Value appear equally light or dark, and all chips having the same Chroma equally strong or weak. This is not true for Ostwald's chips, as the same amounts of white and black mixed to different pure colors do not create the same variation in appearance, and also tend to slightly alter hue. Ostwald has all pure colors stand on the very same level, the color equator. Munsell notices that colors reach their purest at different Values: highly chromatic yellows also have high Values, whereas highly chromatic Blue have low Values, because blue is intrinsically darker than yellow. A case could be made for the use of Ostwald in hair coloring, since his system relies explicitly on the mixture of pigments, apparently much like hair colorants. However, in the case of artistic pigments the result on paper (or whatever medium is being used) is for the most part coherent with the appearance of the mixture. This is not true for hair colorants, which are often comprised of oxidizing agents. Artists want their pigments to be stable and **not** to chemically react when mixed, while hair color is meant from the start to interfere with hair melanin and other chemical components. In other words, hair color is not present in the tube. For example, the colorant for black is originally a whitish cream, that only darkens hair once a few minutes of application have passed.

Finally, Munsell attributes lend themselves very well to the description of hair color, which is mainly defined by two aspects: tonal height and nuance. The former describes, usually in a 10-step scale, hair lightness: 'black', 'brown', 'blonde', 'platinum', etc. Munsell Value is very easily associable with this trait. The latter describes undertones, such as 'copper', 'ash', or 'golden'. Munsell Hue is very suitable to characterize this attribute.

## CONCLUSIONS

Color-order systems represent a compromise between the world of art and science. They are usually well suited to practical applications, because a physical version can be realized for direct comparison with surface samples. Despite a ubiquitous use of a simplified version of Ostwald's system within the hair coloring industry, we make a case for the use of Munsell's system instead. The latter's 'agnostic' approach to color, and his choice of color attributes, make his Book a very versatile device, and one quintessentially compliant with human perception of colors, whichever object they belong to.

## REFERENCES

- Bond, M. E., and D. Nickerson. 1942. Color-Order Systems, Munsell and Ostwald. *Journal of the Optical society of America* 32.
- Choudhury, A. K. R. 2015. *Principles of Colour and Appearance Measurement, vol. 2 Visual measurement of colour, colour comparison and management*. Woodhead Publishing, Elsevier.
- Cochrane, S. 2014. The Munsell Color System: A scientific compromise from the world of art. *Studies in History and Philosophy of Science*, 47: 26-41.
- Granville, W. C. 1994. The Color Harmony Manual, a Color Atlas Based on the Ostwald Color System. *Color Research and Application* 19(2): 77-98.
- Munsell, A. H. 1912. A Pigment Color System and Notation. *The American Journal of Psychology* 23(2): 236-244.
- Schawelka, K. 2018. Wilhelm Ostwald 'Harmony of Colors (1918) and Its Mixed Reception – a Reassessment. *Óbuda University e-Bulletin* 8(2): 13-24. Online: <https://bit.ly/2UDILuo>.

# Hair Color Wheels and Charts

Alessandro Rizzi <sup>1,\*</sup>, Roberta Suardi <sup>2</sup> and Simone Liberini <sup>1</sup>

<sup>1</sup> Università degli Studi di Milano; alessandro.rizzi@unimi.it, simone.liberini@gmail.com

<sup>2</sup> Universal Beauty Products; roberta.suardi@beautypioneers.com

\* Corresponding author: alessandro.rizzi@unimi.it

## Abstract

Cosmetic coloring of human hair is based on the so-called series of naturals, a set of ten reference swatches from deep black to light blonde. These are normally visualized radially on a color wheel, where nuance variations are placed within the circle. In this way, opponent colors are underlined. These color wheels are supposed to be a sort of standard way to 'explore' the available color of each color chart. However, they differ considerably from brand to brand. No standard is globally set by the industry. A selection of wheels is reported and described to discuss their differences.

**Keywords:** *hair coloring, cosmetic, color appearance, color wheel*

## INTRODUCTION

Ordering color is more than an old topic, it is a sort of natural instinct. Everyone of us has the experience of playing with a set of colored pencils trying to put them back in their box in the proper order. In the case of colored pencils sets, surely, we have the memory of some kind of frustration, since putting them in order from white to black is the equivalent of a geometrical projection from 3D to 1D: there are many different ways according to the chosen projection constraints. A different story is ordering hues on a circle. In this case hues are a 1D space, thus no projection is necessary to accomplish the task.

## COLOR CIRCLES AND WHEELS

In the history of art and science many important scholars and artists have built their own color wheel. Here we report some of them without the scope of presenting a complete survey of the topic. We describe a few interesting color wheels since they have influenced the actual way to represent and communicate color. Across the history, almost all color wheels share a common structure. They represent hues without considering variations in lightness and saturation. When a variation of these kinds takes place, it is only for visualization purposes, or simply because the author did not consider it properly and thoroughly. The order of hues generally follows the order of rainbow colors, with magentas connecting the red and violet ends. What changes across different wheels is the space given to the hues, and to the transitions among them.

## ISAAC NEWTON (1643-1727)

Newton built his color wheel (Figure 1) to summarize many of his findings and ideas, right after his famous prism experiment by which he showed that a thin ray of white light is split into multiple colors. The wheel is divided in seven wedges, with the more representative color at the center of each sector. The succession is the same as the one found in the rainbow, with magenta connecting the red and blue ends. Each line dividing the wedges is associated to a musical note, from A (La) to G (Sol). Since the transitions from B (Si) to C (Do) and from E (Mi) to F (Fa) are composed of only a semi-tone, this could explain why *aureus* and *indigo* are smaller wedges.

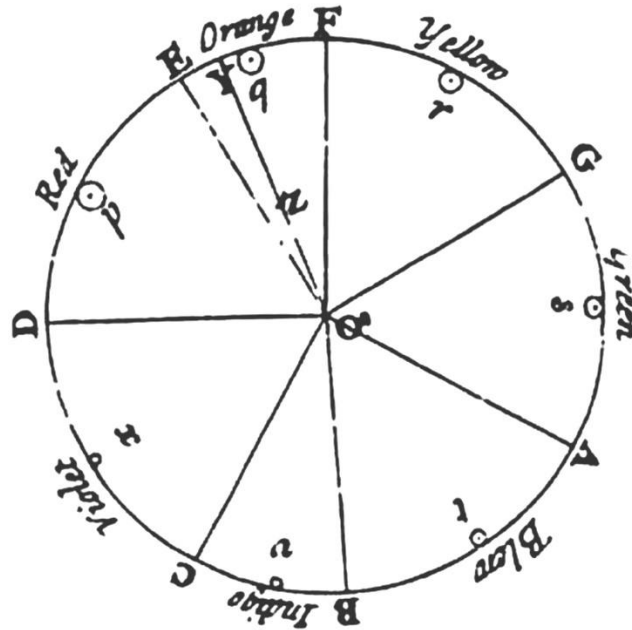

Figure 1: Newton's color circle (Newton 1730).

Notice how at the center of each sector, below the color name, there are circles of different sizes. These are pictorial representations, the size of which is proportional to what Newton called the "number of rays", without further specifications, possibly referring to the energy or the brightness associated with the color. From the position of the wedges and the size of the circles, Newton computed the law of the center of mass of his wheel. In the example, this is signed with the letter Z, corresponding to a kind of orange, north of the wheel center. This point is an average of the positions of the seven main hues, weighted by the respective circle sizes. According to him, this is a representation of the additive mixing of lights of different wavelength, each with its own energy. Point O at the center is supposed to represent white, the mixtures of all colors in equal proportions.

### **JOHANN WOLFGANG VON GOETHE (1749-1832)**

Goethe and Newton did not get along very well, without even having met in person. Maybe for this reason, Goethe as well decided to develop his own color wheel. Like Newton, he also did several experiments on color, resulting in quite different conclusions. In fact, even today, these two important scholars represent the two opposite approaches to color. Newton represents the physical aspect of color, while Goethe represent the perceptual one. As we know color comes from physical emission of light but is synthesized by our brain. Both dimensions are necessary.

Goethe color wheel is visible in Figure 2. Goethe considered magenta the "highest" color, thus he put it at the north of the wheel. Besides the orientation of hues, differences are clearly visible compared to Newton's wheel in terms of sizes and of transitions among the basic colors. Moreover, Goethe's wheel is symmetric, with six basic colors equally spaced resulting in clear opponency: yellow-purple, orange-blue and red-green. The symbolic qualities associated to the four quadrants are, anticlockwise from the upper right one: Reason, Fantasy, Sensuality, Understanding. The association to colors are orange-noble, magenta-beautiful, purple-unnecessary, blue-common, green-useful, yellow-good.

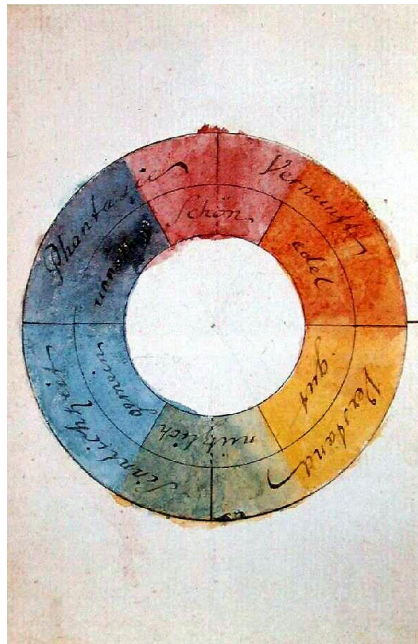

Figure 2: Goethe's color wheel, with associated symbolic qualities annotated (Goethe 1840).

**MICHEL EUGÈNE CHEVREUL (1786-1889)**

Chevreul's color wheel derives from the need to support the carpet makers in choosing the right color to match the requirements of carpet making or repairing. Carpets are made by the juxtaposition of threads, that results in spatial effects and interactions among colors. For this reason, Chevreul studied the effect of simultaneous contrast and considered it in his wheel (Figure 3). He observed that our vision system "tends to add to an observed stripe a bit of the complementary color of the adjacent stripe, increasing the difference between the two" (translated from Italian). Chevreul's wheel has no transitions between colors, it is composed by 72 uniform color wedges (Figure 3), originating 36 couples of opponent colors.



Figure 3: Chevreul's color wheel. Diametrically opposed colors are couples of opponents (Chevreul 1861).



## **COLOR OPPONENCY**

Color wheels contains the inner idea of color opponency. In the wheel setup, drawing a diametrical line allows to find two colors that are geometrically opponent in the wheel, and are supposed to be also opponent colors. Observing different color wheels, it is easy to notice that color opponency changes from wheel to wheel. It is not due just to a matter of precision in the wheel drawing, it is also due to the fact that color opponency can have several different meanings. Let us have two colors A and B. A can be opponent to B if staring at A for a long period results in the afterimage of B. A and B can be opponent if adding pigments or light of A and B results in an achromatic color. A and B can be opponent in the visual pathway. And more ideas and definitions of opponency are possible.

## **HAIR WHEELS AND CIRCLES**

Color wheels are very successful in the field of hair coloring. They are often used in hair color catalogues for two main purposes: to present all the available colors and to help hairdresser in their use. These are two well distinct goals.

To present the available colors the problem to solve is to have a 2D color wheel design able to present the 3D color dimensions: hue, saturation, and intensity. Usually this is done merging hue and saturation in nuance series like 'copper' and 'intense copper'. This is an effective solution, but to be decoded it needs a training on color basics since it is not clearly explained and moreover it is done and labeled differently from brand to brand.

The second goal, i.e. to help the hairdresser in the use of presented colors, is much more difficult. The main use is to make explicit the properties of opponency, used to counterbalance the resulting nuances. Here the idea of opponency is clearly the one related to pigment or colorant mixing, but the way it is reported in the wheel has to deal with gamut limits both in the printed wheel (or circle) and in the colored swatches in the catalogue. Figure 4 shows a series of color wheels from different catalogues.

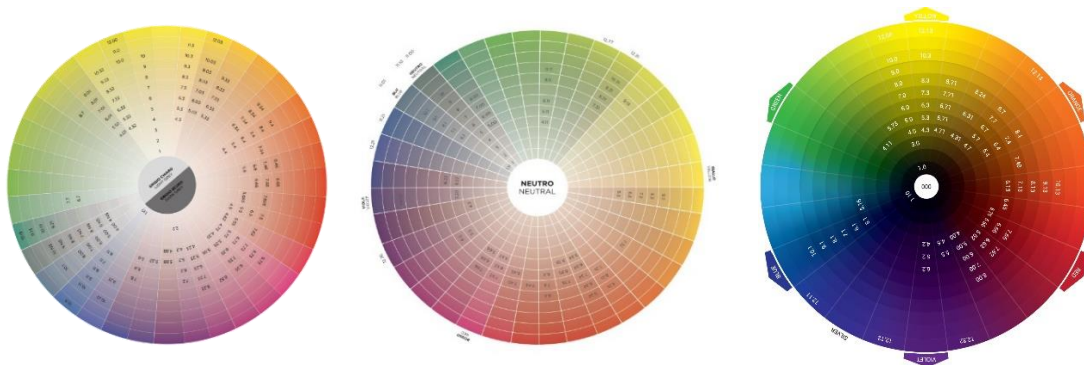

Figure 4: Different color wheels from different catalogues.

## **THE SERIES OF NATURALS**

The pillar of hair coloring is the so called "series of naturals". This should describe the color scale of a sort of average hair colors, as the name would suggest commonly found naturally, with no particular color shifts or nuances. It is scaled in 10 different tones, from 1 (Black) to 10 (light blonde). As a pillar it should be a solid base on which to build the hair color space, but unfortunately it changes easily from brand to brand. Also, within the same brand, color properties of each swatch can be subject to many unwanted shifts, as visible in Figure 5, which reports chromatic assessments made on a series of naturals.

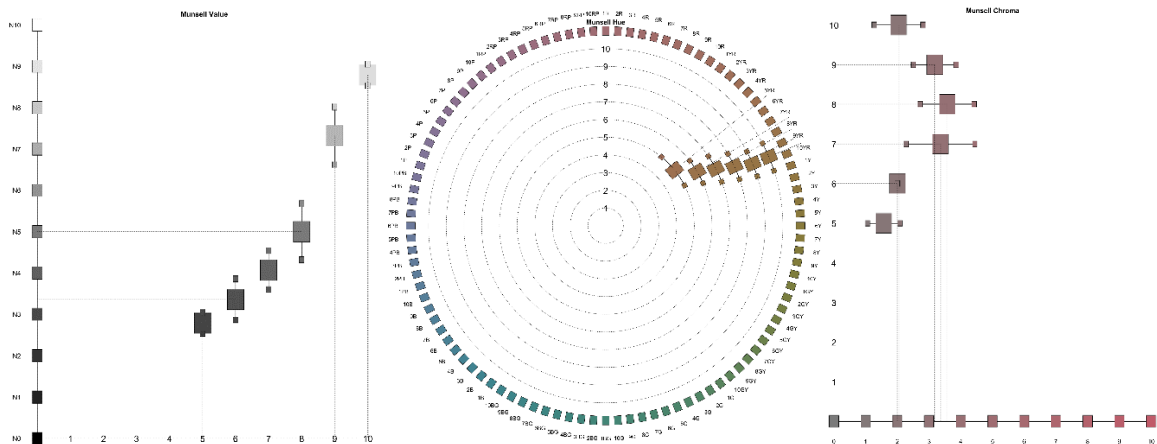

Figure 5: Chromatic assessment of a series of naturals: tones, hues, and saturations.

All assessments in Figure 5 are reported in the perceptually uniform Munsell space. It can be noticed that tonal values are not linear, and some steps are unbalanced (Figure 5a); that saturation increases in the middle tones (Figure 5c), as expected; and that there is a progressive hue shift towards yellow while lightening the tone, or, conversely, a shift towards red when darkening it (Figure 5b).

**CONCLUSIONS**

In this paper we have presented the legacy from some historical color wheels to the color wheels used nowadays in the industry of hair coloring. Some of the analyzed characteristics suggest possible improvements in order to have a shared and precise instrument of color communication and teaching in the field of hair coloring use and production.

**REFERENCES**

Chevreul, E. M. 1861. *Exposé d'un moyen de définir et de nommer les couleurs*, planche 3.  
 Goethe, J. W. 1840. *Zur Farbenlehre* (Theory of Colors).  
 Newton, I. 1730. *Opticks: Or, A Treatise of the Reflections, Refractions, Inflections and Colours of Light*.  
 William Innys at the West-End of St. Paul's.





# Chromatic Appearance of Nylon Swatches in Hair Color Charts

Alice Toninelli <sup>1,\*</sup>, Simone Liberini <sup>2</sup>, Roberta Suardi <sup>1</sup> and Giannantonio Negretti <sup>3</sup>

<sup>1</sup> Universal Beauty Products; alice.toninelli@nggrp.com, roberta.suardi@beautypioneers.com

<sup>2</sup> University of Milan; simone.liberini@gmail.com

<sup>3</sup> NG Group Universal; ga@nggrp.com

\* Corresponding author: alice.toninelli@nggrp.com

## Abstract

Hair color charts are to hair coloring what color atlases are to color painting: a standardized palette of tones and nuances for colorists to choose from. In fact, slight variations exist among them, supposedly for marketing goals. However, a few other inconsistencies are readily apparent by visual inspection in the series of naturals, i.e., the one extending from deep black to light blonde. By means of a visual comparison through the Munsell Book of Color, we assess the chromatic appearance of a selection of hair color charts comprised of several colored nylon swatches, mainly focusing on the series of naturals. Results show the level of consistency of nuances throughout the scale, and among different brand scales. They also provide a clear indication on the actual tonal scaling of the samples, with particular regard to its perceptual linearity.

**Keywords:** *hair coloring, cosmetic, color appearance, Munsell Book of Color*

## INTRODUCTION

Hair coloring is nowadays a well-established and elaborate craft, so subtle and nuanced, in fact, that calling it an art form is perhaps not an exaggeration. Much like artists resort to color wheels to create color palettes, hair colorists base their own work on hair color charts in order to bring hair, their canvas, to life. Swatches in color charts, especially those of the series of naturals, are usually given a name, broadly classifying a likewise amount of commonly-occurring human hair colors: 'Black' (1.0), 'Deep Dark Chestnut Brown' (2.0), 'Dark Chestnut Brown' (3.0), 'Chestnut Brown' (4.0), 'Light Chestnut Brown' (5.0), 'Dark Blond' (6), 'Blond' (7.0), 'Light Blond' (8.0), 'Very Light Blond' (9.0) and 'Platinum Very Light Blond' (10.0). Numerous other swatches exist in color charts named in the general form LL.TT(T), where LL is a level number from 1 to 10, and TT(T) is a tone number which identifies special shades of that level. All .0 are naturals, all .33 are intense golden, all .334 are intense copper golden, etc. Joining level and tone, we might for instance define a 6.334 as an intense copper golden dark blond.

Again similar to artists, hair colorists are historically used resort to subjective perception to identify and evaluate hair color. Instrumental measurements are sometimes employed in industrial settings, but their accuracy remains dubious due the intrinsic light scattering properties of hair (Liberini 2020). Personal preference, however, lends itself quite poorly to standardization. In order to try and bridge this gap, we propose a visual matching experiment for assessing the chromatic appearance of nylon swatches based on the Munsell Book of Color, the physical realization of the eponymous color-order system for the ordering and denotation of colors. Munsell Book is widely adopted in a variety of applications such as the analysis of soil and foliage colors, or even skin tones. In the last years, glossy and pastel-tones versions have been issued, widening the scope of use to car bodies and furniture, among others. Munsell system is very useful because it describes color with three attributes related to our perception: Hue, Value and Chroma, which are, respectively, 'color' in the everyday sense of the word; the attribute defining the level of 'lightness' or 'darkness'; and lastly, the one identifying a certain color as 'strong' or 'weak'. Moreover, Munsell chips are perceptually equidistant: moving from a chip by the same distance along each of the three independent directions identified by the attributes gives rise to the same perception of color difference.

## MATERIALS AND METHODS

### Nylon swatches

Three series of naturals were analyzed, each picked from a different hair color chart. The first one (S1 from here on) is comprised of nine swatches ranging from 1.0 to 10.0 with swatch 2.0 missing, as is often the case due to a somewhat low marketability of the associated color. Swatches are straight, about 3.5cm long and 1.5cm wide at the loose end (from which they slightly taper towards the glued end) and weighting on average 0.350g each (Figure 1A top). Series two (S2, Figure 1A middle) is instead complete, and so is series three (S3, Figure 1A bottom). Swatches from S2 and S3 come in a curled arrangement, vaguely reminiscent of a horse-shoe. The overall shape is predominantly planar, but the twisting around the midpoint creates a perceivably protruding arc that catches and reflects light in multiple directions, highlighting undertones that remain mostly hidden from view in S1. Both S2 and S3 swatches are 4.0cm long, whereas they are respectively 4.0cm and 4.5cm wide at their widest point, 0.800g and 0.750g heavy on average.



Figure 1: (A) 1.0, 6.0 and 10.0 colored swatches from S1 (top), S2 (middle) and S3 (bottom). (B) The custom lightbox: LEDs can be seen shining from the ceiling trough the frosted panel. (C) The color wheel with a selection of Munsell chips. The wheel turns around the central hook, where swatches are also affixed for visual comparison. Chips are numbered randomly in order to avoid test subjects to infer an ordered pattern in their answers.

### Perceptual experiment setup

Before the experiment itself, test-takers sat the Farnsworth-Munsell 100 Hue test, meant to evaluate the predisposition of an individual to discriminate between nearly identical hues. The test is composed of four black plastic rows, on which subjects need to arrange a total of eighty-five colored chips that span the entire range of Munsell Hues at fixed Munsell Value and Munsell Chroma 5. Subjects need to rebuild, one chip at a time, the color series that connects the two immovable chips at both ends of each row. Once the test is over, the suggested ordering is checked against numbers printed on the lower inner surface of every chip. The result is an integer figure that accounts for all positioning mistakes, so that the further apart ideally consecutive tiles are placed, the greater the amount added to the score.

The color of an object as our eyes sense it is the result of the interaction among its pigmentation and the impinging light. Given a pigmented object, such as a hair swatch, it is then fundamental that all perceptual tests be administered under a controlled lighting setup. Artificial lighting is generally

undesirable, because spectra of common light sources are very likely to underrepresent certain wavelengths intervals. A custom-made lightbox (Figure 1B) was therefore realized with two LEDs casting a mostly flat, uniform spectrum at about  $T = 5000\text{K}$  (D50 illuminant), mimicking the ideal behavior of sunlight. In order to better diffuse this light within the box, LEDs were screened with a frosted glass panel, and all inner walls were painted in uniform white.

Ideally, light should reach colored samples at a  $45^\circ$  angle with respect to the normal axis, along which all observations must then be made. Accounting for the positioning of LEDs inside the lightbox, all samples were mounted on a square-based hemi-prism and fixed in position on an immovable hook. Round this hook, a spinning paper disc<sup>1</sup> was also placed with a total of 50 Munsell chips arranged along two concentric circumferences, the innermost at a distance of 8.3cm from the colored sample, the outermost at 11.4cm (Figure 1C). Ideally, perceptual matchings should be forgotten right after having been made, in order not to influence the remaining choices. In other words, despite the intrinsic progression of the series of naturals, swatches should be visually matched with colored chips independent from one another. Rigidly structured colored patterns of the chips, such as they come in the Book, are therefore not ideal. Rather than providing the subjects with entire Hue pages, chips were then chosen so that a sufficient variety of Hues, Values and Chromas could be supplied for testing. Afterwards, they were placed on the disk in blocks of non-contiguous Values, randomizing the positions of Hues and Chromas. Furthermore, in order to avoid memorization effects, swatches were shown in steps of 3, e.g. 1-4-7-10-3-6-9-2-5-8. Subjects were instructed not to touch nor to remove neither swatches nor chips (to avoid soiling) and were only allowed to turn the wheel in order to better sense the color they deemed predominant among emerging hair undertones.

## RESULTS

### Test sample

Eleven test subjects were recruited, of whom four males and seven females, aged 23 to 42 (mean age 27y). None of them was ever officially diagnosed with any kind of color anomaly or color blindness, and their Farnsworth-Munsell 100 Hue Test total error scores (mean TES = 24) placed them either in the Superior Discrimination category (5 out of 11) or in the Average Discrimination category (6 out of 11). 4 out of 11 test subjects made a mistake in the first row, and 1 out of 11 made two. This is most relevant to the experiment at hand because it contains hues from red to yellow. Having said that, all these errors consist of simple swaps between adjacent chips, i.e. the minimum possible error, amounting to less than half a Hue step apart when considering Book chips. Because of this, there is no apparent reason to question subjects' answers to the matching test, let alone discard them.

### Perceptual test

Averaging results of the perceptual test requires computations based on Munsell chips' standard nomenclature, whose specification is alphanumeric, e.g.: 7.5YR 5/8. Values and Chromas are innately numbers (respectively 5 and 8 as per the example), whereas Hues are a mixture of an Arabic numeral (7.5) followed by a short character tag (YR). While the latter is meant to designate Hue itself, the former provides a numerical degree of membership to such label, with 5 being the center-most, eponymous step. A second nomenclature exists, the so-called 'inner loop', that orders Hues on a purely numerical

---

<sup>1</sup> Common printing sheets are treated with chemical bleachers to make them appear whiter. Collaterally, the treatment greatly boosts reflectance within the blue spectral bandwidth, altering visual perception of superimposed colors. For our perceptual experiment, we chose untreated paper sheets.

basis starting from 1 at 1R and ending at 100 at 10RP, which better satisfies computational needs. Data are processed according to this naming convention. Hue, Value and Chroma experimental results are plotted for S1, S2 and S3. Figure 2 shows mean values minus and plus standard deviations, while Figure 3 shows median values comprised within the first and third quartiles (interquartile range, IQR).

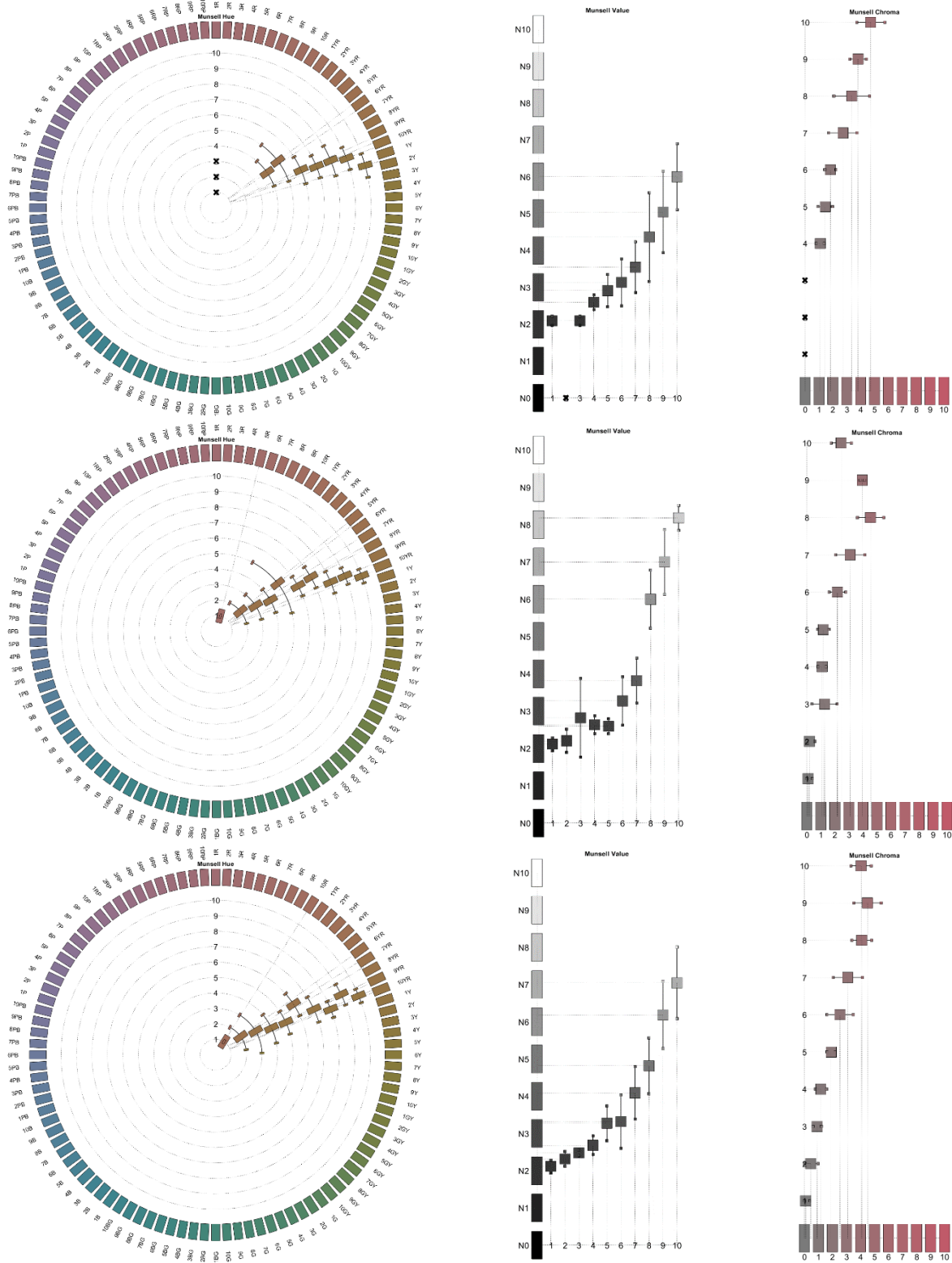

Figure 2: Munsell coordinates (Hue: left; Value: center; Chroma: right) of S1 (top), S2 (middle), S3 (bottom), expressed as means and standard deviations. x symbols are samples perceived as achromatic (S1#2 is absent).

Chromatic Appearance of Nylon Swatches in Hair Color Charts

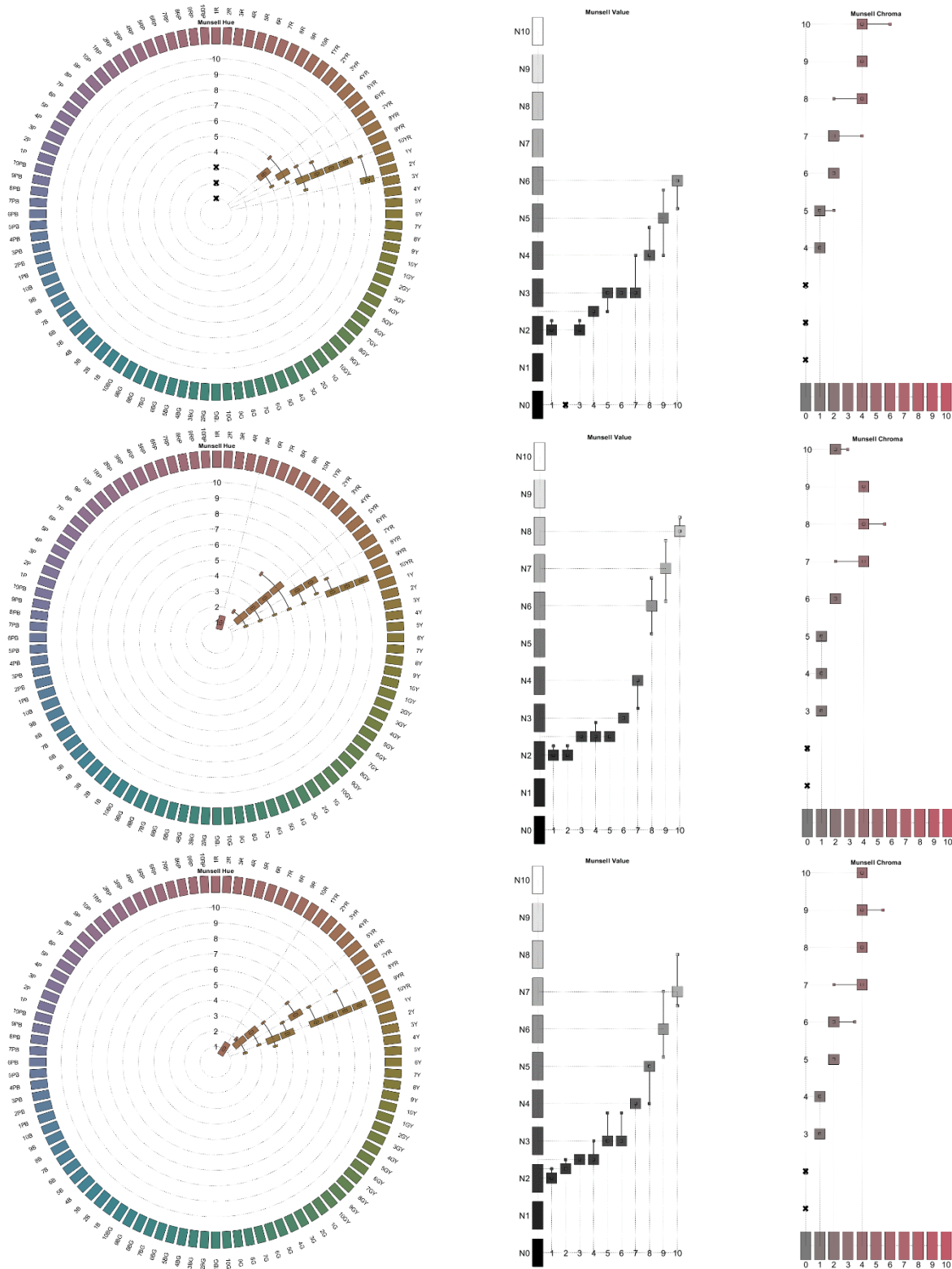

Figure 3: Munsell coordinates (Hue: left; Value: center; Chroma: right) of S1 (top), S2 (middle), S3 (bottom), expressed as medians and interquartile ranges. x symbols are samples perceived as achromatic (S1#2 is absent).

**DISCUSSION**

A method detailing the evaluation of human hair appearance has been proposed. In a custom-made lightbox, nylon hair swatches were observed by eleven subjects previously tested for their ability to

finely discern colors. Results were reported in terms of Munsell Hue, Value and Chroma. Briefly before discussing data, we would like to note that standard deviation is represented symmetrically around the mean, assuming that samples are normally distributed<sup>2</sup>. This may not be the case here, as interquartile ranges are more often than not skewed in one direction. In other words, means and medians are quite different because of a few outliers, i.e. answers that differ greatly from the rest. We choose median values for ease of reading, and because the generally unbalanced interquartile ranges suggest a clearer tendency of the data.

Broadly speaking, Hues increase from orange proper (5YR) to a yellower shade (10YR) when moving towards blond swatches. 1.0, ideally a pure black, was incorrectly perceived as having a deeper red nuance (10R) for S3, and an even deeper one for S2 (5R). In fact, every test subject but one perceived these swatches as purely neutral. On the contrary, S1#3 is so dark that it was perceived as achromatic, which it actually isn't. An anomaly appears in S3 for swatches 4.0, 5.0 and 6.0, either because the latter appears redder, or because the former appears yellower than intended. The IQRs of 4.0 and 5.0 move anticlockwise on the Hue circles, actually suggesting an overall reddish shade, but so does 6.0. It is therefore likely that 6.0 is incorrectly scaled with respect to other levels in the series.

Values steadily increase from 1.0 towards 10.0. This was expected, but here Munsell chips' inherent structure shows a very interesting detail. Supposing the series of naturals is built to represent steadily increasing hair levels, as perceived by the human eye, then Values should scale in equal steps from one swatch to the following, for each and every swatch. This is never the case, as there consistently appears to be a marked divide from the lower part of the series (1.0 to 5.0) to the upper one (6.0 to 10.0). In other words, the brown subseries moves in short steps, the blonde one in wider leaps.

If Munsell Hue is easily relatable to color shades, and Value to level heights, Chroma is more difficult to contextualize. It starts at 0 for achromatic colors, then slightly increases for blond swatches. S2 and S3 seem to suggest Chroma going back again towards the neutral axis, which sounds plausible because swatches 11.0 and 12.0, here untested and rarely present in the series of naturals in color charts, are even lighter and closer to white, by definition an achromatic color. Chroma might therefore represent the richness of undertones, which is more visible in upper-intermediate swatches and curled geometries, where three-dimensionality possibly helps bring it out.

Finally, it is apparent that the three series of naturals analyzed show different behaviors, despite serving as a theoretically universal reference for all color charts. For instance, 10.0 reaches a median Munsell Value of 6 in S1, 8 in S2 (going slightly higher), and 7 in S3 (going a bit more decidedly higher). None of the series is perceptually linear (visually, none of the three is a straight line connecting 1.0 to 10.0 on the Value plots). This shows the overall potential of Munsell color-order system and Book for the evaluation of color attributes of human hair.

## **ACKNOWLEDGEMENTS**

We wish to thank Giorgio Znacchi for his contributions in devising and building the lightbox. We are grateful to both Dr. Camilla Zanetti and Dr. Eudald Grané Solsona for their useful feedback on the practical execution of the matching experiment, which they also helped us carry out.

## **REFERENCES**

Liberini S., A. Avolio, S. T. Yankowski, and A. Rizzi. 2020. Consistency issues in hair spectral reflectance and colour measurements. *Coloration Technology* 00: 1-11.

---

<sup>2</sup> That is, with answers mostly grouped around the mean, with a low prevalence of data too far from the mean itself.

# Influence of color discrimination proficiency on wellness professionals' training and craft

Daniele Fusari <sup>1,\*</sup>

<sup>1</sup> Centro Poliestetico di Milano 1; danielefusari@gmail.com

\* Corresponding author: danielefusari@gmail.com

## Abstract

Color plays a crucial role in the field of wellness. Identifying color vision deficiency (CVD) – the most typical vision and undiagnosed color vision defect – is fundamental to supporting and addressing vocational students in their professional development. This work aimed to determine the prevalence of CVD among students of the *Centro Poliestetico of Milan*. A cross-sectional and descriptive study about students' color vision deficiency was carried out using the Farnsworth-Munsell 100-Hue test. One hundred and fifty-five students were included (138 females and 17 males). The mean score of the Farnsworth Munsell 100 Hue Test Score was higher in males ( $64.4 \pm 46.3$ ) than in females ( $45.7 \pm 30.5$ ). In addition, a positive association between males and low discrimination levels ( $p = 0.042$ ) emerged. Advice and support on color vision proficiency are necessary for wellness professionals to increase their awareness, reduce anxiety during the working activity, and improve customer satisfaction.

**Keywords:** *color vision deficiency, color proficiency, wellness professionals, Farnsworth-Munsell 100-Hue test*

## INTRODUCTION

Color vision usually is trichromatic: three different cone visual pigments have peak sensitivity at blue, green, and red wavelengths (Marmor and Lanthony 2001). Color vision deficiency (CVD) is the "*inability to distinguish certain shades of color or, in more severe cases, see colors at all*" (American Optometric Association, 2006, 1).

It is a condition characterized by disturbances of color perception that occurs if the amount of visual pigment per cone is reduced or if one or more of the three-cone systems are absent. Dichromats have two, instead of the standard three cone photopigments, while anomalous trichromats have three cone photopigments, of which usually only one is abnormal. The etiology of CVD is either congenital (Fanlo et al. 2019) or acquired (Simunovic 2016). Congenital red-green deficiency (protan and deutan) is due to abnormalities of red and green visual pigment lying on the X-chromosome (Deeb 2004), while the rare blue deficiency (tritan) is autosomal dominant (Henry et al. 1964). Red/green color vision deficiency is the most common; individuals have difficulty distinguishing between the two colors. Blue/yellow color vision deficiency is less common but more severe; individuals frequently have red/green color vision deficiency (Randolph 2013).

Congenital CVD affects about 8% of European Caucasians, 5% of Asians, 4% of Africans, and less than 2% of indigenous Americans, Australians, and Polynesians (Birch 2012). CVD remains an unnoticed problem in many cases, although the faculty of appreciation of color is essential for almost all smooth daily activities and in many professions (Hood et al. 2006). In some fields, e.g., health care, many studies have demonstrated the need for CVD screening to raise awareness among health professionals to reduce errors due to a misleading interpretation of image outcomes (Dohvoma et al. 2018).

Among wellness professionals, color vision plays a crucial role. Professionals with CVD can find difficulties in their practice because of a lack of color discrimination, increasing the risk of poor customer satisfaction.



Awareness of CVD among beauty professionals is, to date, an unexplored field. Proper management of color and its gradations may improve the trust relationship with customers and represent one of the most critical factors in determining the success of wellness professionals.

To the best of our knowledge, no such study has been carried out in the Wellness field. Therefore, this work aimed to determine the prevalence of color vision deficiency among students of the *Centro Poliestetico of Milan*, raising awareness in the wellness field about the importance of CVD screening.

## **MATERIAL AND METHODS**

A cross-sectional and descriptive study was carried out between May and June 2021. The questionnaire was addressed to Italian students of the *Centro Poliestetico of Milan* and distributed through the author's mailing lists. Participation in the questionnaire was voluntary, anonymous, and without any form of remuneration. This study did not fall under human research's Italian law, and the Ethical Committee did not ask for specific approval.

In the invitation, we explained our research purposes and that the author was responsible for data collection and management. In addition, we specified that the project and its findings were to be published in scientific articles.

The Farnsworth-Munsell 100-Hue test (Farnsworth 100 Hue Test; Richmond Products Inc, Albuquerque, NM) was used to determine chromatic discrimination. It consists of 85 colored caps split across four trays. The caps vary only in hue, with lightness and saturation kept constant. Each tray has 21 removable intermediate caps whose hues range smoothly between the two fixed caps at either end (Cranwell 2015).

The intermediate caps were removed from each tray and placed randomly while the participant looked away. Then, subjects were asked to arrange previously and randomly mixed-up caps on a horizontal plane according to color tones. The trays were completed in different orders between participants. The goal of this test was to place the color palettes in the correct order based on the color hue. Scores for the test are based on two factors: (1) frequency of the color caps misplaced; (2) the severity or distance of the misplacement. The experimenter recorded the order in which the participant placed the caps. The task was completed under simulated daylight illumination. The daylight illumination was kept homogeneous for all participants.

Error scores for each tray position were calculated using the differences between its chosen cap and the two neighboring caps, generating a baseline score of 2 for each cap when in perfect order. Error scores for caps at the end of each tray were calculated using the neighboring cap in the same tray and the first cap of the next tray so that all caps are considered on a continuum around the color circle. The TES is computed by first subtracting the baseline score from each tray position error score and then summing all 85 individual error scores.

A TES of 0-16 is considered a good score (superior range of competence for color discrimination); TES score between 16 and 100 is normal; TES score higher than 100 is regarded as weak discrimination. Lower error scores indicate higher color discrimination ability (<https://munsell.com/faqs/what-does-score-farnsworth-munsell-100-hue-test-mean/>).

Quantitative data were summarized as mean  $\pm$  standard deviation, while qualitative data were reported as relative frequencies and percentages. Statistically significant differences were examined through Fisher's exact test for qualitative data, while Wilcoxon paired signed-rank test and Kruskal-Wallis with Dunn's procedure were executed for quantitative data. Shapiro-Wilk test was performed

to check the normality of the quantitative data. STATA17 (StataCorp., College Station, TX, USA) was used for statistical analysis. Statistical significance was set at 5% ( $p < 0.05$ ).

## RESULTS

The study included one hundred and fifty-five students of the *Centro Poliestetico of Milan* (response rate 51.7%). About 89.03% (138/155) were females, and 10.97% (17/155) were males. The mean age was 16.15 (2.89) years, higher in males ( $17.2 \pm 3.0$ ) than in females ( $16.0 \pm 2.9$ ) ( $p = 0.050$ ). The sample was homogeneously distributed between 14-15 and 16-17 years. Only small percentages of students were older than 17 years (18.71%, 29/155). Respondents' characteristics were reported in Table 1.

<b>N° respondents</b>	155
<b>Gender, n (%)</b>	
<b>Female</b>	138 (89.03)
<b>Male</b>	17 (10.97)
<b>Age, mean (sd)</b>	16.15 (2.89)
<b>Age range, n (%)</b>	
<b>14 -15 years</b>	69 (44.52)
<b>16 – 17 years</b>	57 (36.77)
<b>&gt; 17 years</b>	29 (18.71)

Table 1: Respondents' characteristics.

The mean score of the Farnsworth Munsell 100 Hue Test Score was  $47.7 \pm 33.0$ , higher in males ( $64.4 \pm 46.3$ ) than in females ( $45.7 \pm 30.5$ ) without statistically significant difference ( $p > 0.05$ ) (Figure 1).

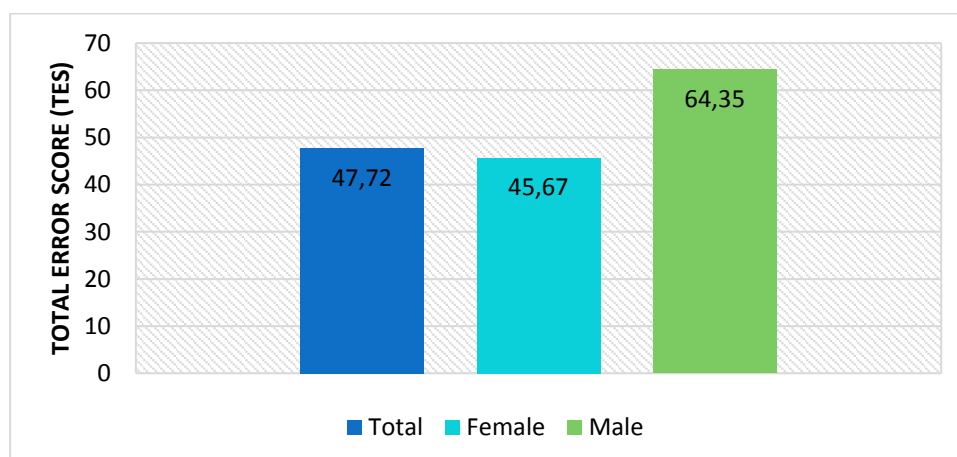

Figure 1: Mean of Total Error Score (TSS) for the whole sample, females, and males.

No statistically significant differences emerged comparing the Farnsworth Munsell 100 Hue Test among the three different age range (14-15 years, 16-17 years, > 17 years), although a borderline significance was noted between the lowest and the highest age range ( $TES_{14-15 \text{ years}}: 49.74 \pm 30.62$ ;  $TES_{>17 \text{ years}}: 40.72 \pm 31.32$ ;  $p = 0.0588$ ) (Figure 2).

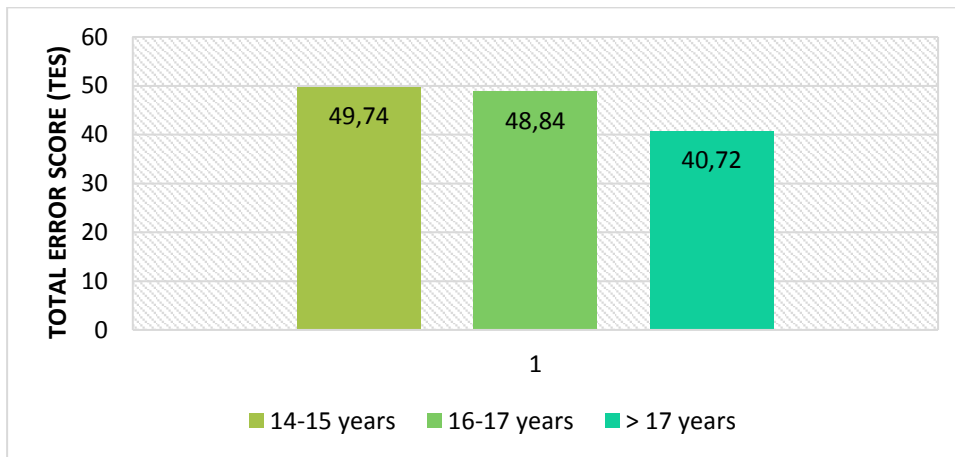

Figure 2: Mean of Total Error Score (TSS) for age range.

About 75% (116/155) of the students reported a normal discrimination level ( $16 < TES < 65$ ), followed by a 20.7% (32/155) who reported an excellent discrimination level ( $TES < 16$ ). Only 4.52% (7/155) reported a TES value higher than 100. The association between gender and TES score range reported a statistically significant difference between males and females ( $p = 0.042$ ), from which emerged that a higher percentage of females reported a high discrimination level (21.74%, 30/138). In comparison, only 11.76% (2/17) of males had the same high degree of discrimination. About 18% of males (3/17) reported a low discrimination level (score higher than 100), percentages significantly higher than that reported by females, among whom only 2.90% (4/138) reported the same discrimination level. These differences were characterized by statistical significance ( $p = 0.042$ ). Completed results were reported in Figure 3.

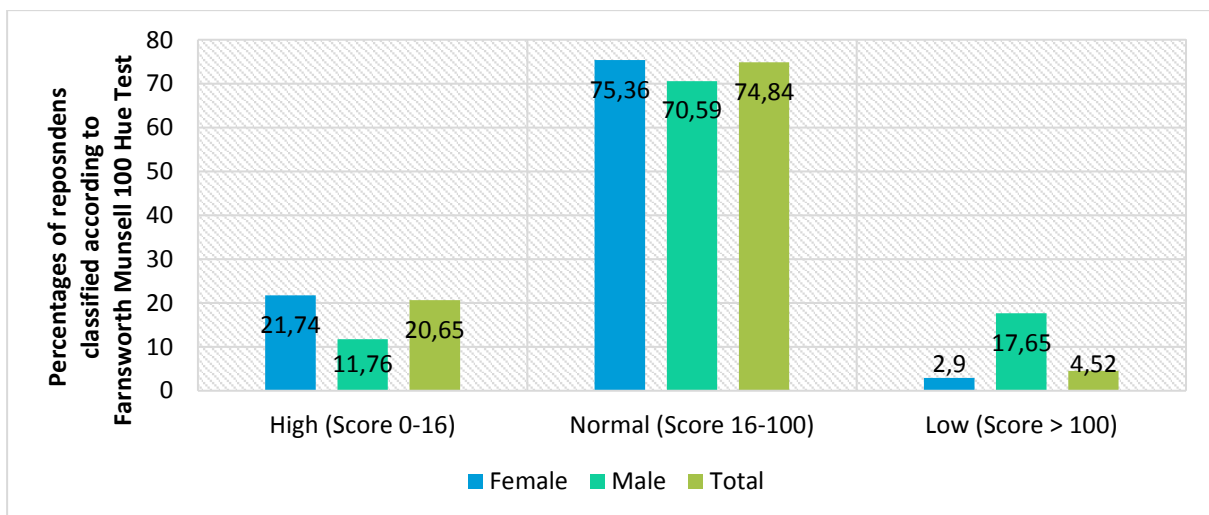

Figure 3: Percentages of respondents in each color discrimination level – Comparison between gender.

Comparing discrimination levels among the three age ranges, although non statistically significant differences emerged, the highest and the lowest discrimination level emerged in students older than 17 years: 27.59% (8/29) of them reported the highest discrimination level, while 6.9% (2/29) reported the lowest discrimination level. Conversely, about 80% (55/69) of the youngest students showed a normal discrimination level (Figure 4).

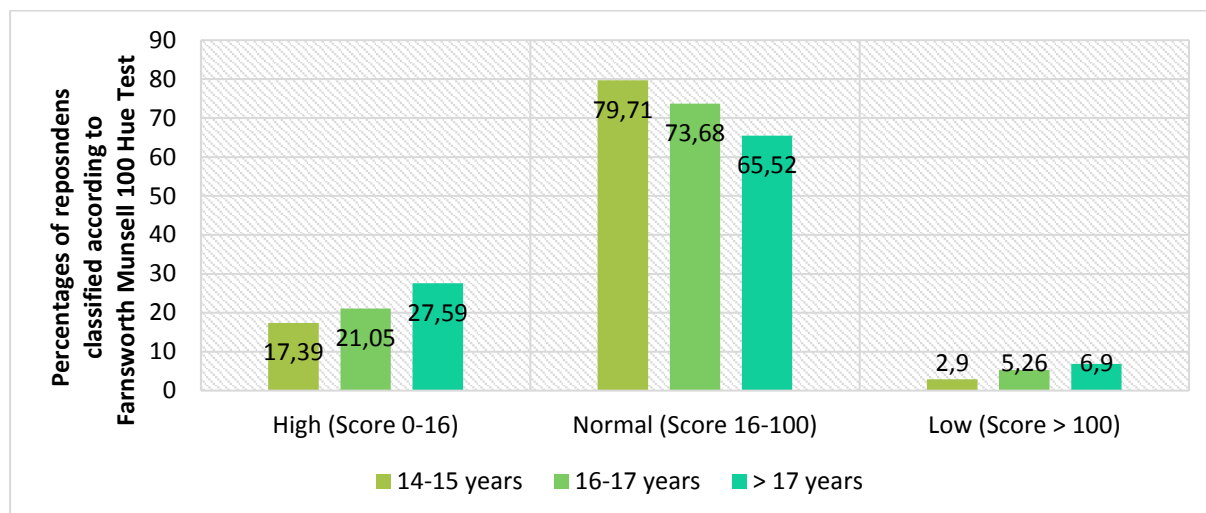

Figure 4: Percentages of respondents in each color discrimination level – Comparison among age range.

## DISCUSSION

Color vision deficiency is the commonest disorder of vision and undiagnosed color vision defect. Many studies have demonstrated that the prevalence of CVD varies depending on race and ethnicity [7]. For example, in the medical field, Patel et al. (2016) demonstrated a prevalence of 1.8% among medical students, which raise to 5.58% in Nepal among male medical and dental students (Pramanik et al. 2012).

In the field of wellness, color plays a crucial role in customers' satisfaction. However, to date, no scientific studies have been conducted to determine CVD prevalence among students in the wellness field. Therefore, this work aimed to assess the prevalence of color vision deficiency (CVD) among students of a wellness academy.

According to Patel et al. (2016), red-green perceptive disorders are more frequently reported in males than females because of the X-linked recessive gene, which is passed from the mother to her son. Our findings showed a higher prevalence of CVD among male students than female students (17.65% of males vs. 4.52% of females). However, the prevalence of CVD in our sample was higher than that reported worldwide (8% in males and 0.5% in females). The younger age of the respondents could explain these findings. As emerged in previous studies, CVD in children (6-11 years) and young people (12-17 years) have a prevalence of 4.28% and 4.1%, respectively (Xie et al. 2014; Slaby and Roberts 1973).

In our sample, there was no decrease in the low discrimination level with increasing age. Students older than 17 reported a higher prevalence of CVD (6.9%), although it was offset by a higher level of discrimination (27.59%) than that seen among younger groups.

From our findings, no student with CVD was aware of his/her deficiency. This result was in line with that reported by Tagarelli et al. (1999), who demonstrated that 96% of students attending middle school and 65% of students at university were not aware of their deficiency.

This study may be considered a first pilot study to raise awareness of future wellness professionals about color vision deficiency, as already suggested in many fields (Ranfolph 2013). Although the study design was simple and easy to implement, some limitations emerged during the statistical analysis. The first limitation is the small sample size, which prevented the author from inferring the data to the

whole population. Second, the CVD was assessed using only one test: more than one color deficiency test, as Ishihara's test, could have improved the whole study's internal validity. Third, given the subjectivity of the test, a vision quality test could have helped the author better understand each respondent's initial vision condition.

In conclusion, our study has shown that advice and support are necessary for wellness professionals to increase their awareness about CVD. Therefore, although a color vision screening is not considered among the regular educational activity, we recommend it as good practice in wellness academies so to help students, and thus future hairdressers and beauticians, in recognizing their color vision limitations to reduce their anxiety during the working activity and improve customers' satisfaction.

## REFERENCES

- American Optometric Association. 2006. Color Vision Deficiency. Available on <https://www.aoa.org/healthy-eyes/eye-and-vision-conditions/color-vision-deficiency?sso=y>
- Birch, J. 2012. Worldwide prevalence of red-green color deficiency. *Journal of the Optical Society of America* 29: 313.
- Cranwell, M.B., B. Pearce, C. Loveridge, and A. C. Hurlbert. 2015. Performance on the Farnsworth-Munsell 100-Hue Test Is Significantly Related to Nonverbal IQ. *Investigative Ophthalmology & Visual Science* 56: 3171.
- Deeb, S. S. 2004. Molecular genetics of colour vision deficiencies. *Clinical and Experimental Optometry*.
- Dohvoma, V., M. S. R. Eban, G. Kagmeni, et al. 2018. Color vision deficiency among biomedical students: a cross-sectional study. *Clinical Ophthalmology* 12: 1121-1124.
- Fanlo, Z. A., V. J. Gutiérrez, R. V. Pueyo. 2019. Revisión de los principales test clínicos para evaluar la visión del color. *Archivos de la Sociedad Española de Oftalmología* 94: 25-32.
- Henry, B. G. H., B. L. Cole, and J. Nathan. 1964. The inheritance of congenital tritanopia with the report of an extensive pedigree. *Annals of Human Genetics* 27: 219-231.
- Hood, S. M., J. D. Mollon, L. Purves, and G. Jordan. 2006. Color discrimination in carriers of color deficiency. *Vision Research* 46: 2894-2900.
- Marmor, M. F., and P. Lanthony. 2001. The Dilemma of Color Deficiency and Art. *Survey of Ophthalmology* 45: 407-415.
- Patel, J., H. Trivedi, A. Patel, et al. 2016. Assessment of colour vision deficiency in medical students. *International Journal of Community Medicine and Public Health* 230-235.
- Pramanik, T., B. Khatiwada, and R. Pandit. 2012. Color vision deficiency among a group of students of health sciences. *Nepal Medical College journal* 14.
- Randolph, S. A. 2013. Color Vision Deficiency. *Workplace Health & Safety* 61.
- Simunovic, M. P. 2016. Acquired color vision deficiency. *Survey of Ophthalmology*.
- Slaby, D., and J. Roberts. 1973. Color vision deficiencies in youths. *Vital and Health Statistics*. Ser.11.
- Tagarelli, A., A. Piro, and G. Tagarelli. 1999. Genetic, Epidemiologic and Social Features of Colour Blindness. *Public Health Genomics* 2: 30-35.
- Xie, J. Z., K. Tarczy-Hornoch, J. Lin, et al. 2014. Color Vision Deficiency in Preschool Children. *Ophthalmology* 121: 1469-1474.

# Hair Coloring and Customer Satisfaction

Giannantonio Negretti <sup>1,\*</sup>

<sup>1</sup> NG Group Universal; ga@nggrp.com

\* Corresponding author: ga@nggrp.com

## Abstract

Hair color is a fundamental identity-defining feature, especially in the female universe. The relationship with the world of hair coloring is equally paramount to customers and professional hairdressers. Among all treatments, hair coloring promotes the highest customer loyalty, and at the same time, it excels in its ability to attract new customers. However, despite the substantial monetary profit and business volume of the coloring service, there is an extremely high percentage of customer dissatisfaction. We tried to investigate where the short circuits between expectation and result occur. Some causes emerged mainly attributable to a generalized lack of appropriate training provided to students during their advancement in the Vocational Training Centers, especially regarding color theory. On top of this is the non-academic approach based on habits, the custom amongst cosmetic companies to determine tone heights in a totally subjective way, and the use of non-standard color charts.

**Keywords:** *hair coloring, vocational training, customer satisfaction.*

## THE COMPLEX WORLD OF HAIR COLORING

Hair has always been an instrument of attraction. Although the self-image it conveys can change over the course of life, it always reflects identity and personality. Hair tells people something intimate. Sometimes it is just a matter of fashion, but other times it communicates moods, quirks, or desires. Hair is one of the most important and direct ways a person can express themselves, other than words. It is also an essential part of what makes us attractive to others, something that can be transformed with different cuts, styles, and colors.

For women in particular, hair color is a key element of a person's identity. Each shade says something different about their personality and tastes, their desire for change, a mood, a playful disposition, or their desire to appear younger. It reflects the sense of style, and in some cases, it even reveals information about their occupations. Today, girls see their hair as an accessory they can show off. As a result, the value of professional coloring services has changed. These services have become a means of making each client's hair as unique as their fingerprints. Today, having luminous, healthy, dyed hair is very important because it is synonymous with meticulous self-care.

### The customer's perspective

The consumer's relationship with the world of hair color is of essential importance. 7 out of 10 Italian women between the ages of 15 and 75 dye their hair: 67% of the female population dyes their hair 6-8 times a year, while on average, 50% of Italian women visit the hair salon for professional services every 45-60 days (data from internal report). For hair salons, color is a *core business*. It is one of the most profitable and high-revenue services they offer, making it an important tool for increasing income, building customer loyalty, and attracting new clients.

Despite the high potential and great demand for hair coloring services, however, clients experience a high rate of dissatisfaction and disappointment with regard to their expectations. It is easier to lose a client because of a poor dye job than because of a haircut. The disappointment that ensues when the results do not meet the client's expectations can lead to a state of emotional turmoil that even impacts their interpersonal relationships. That is why stylists hold a great deal of social responsibility.

Beauty services are supposed to promise happiness, and yet they can often cause great disappointment. This contradiction gives rise to bad experiences, which in turn trigger a vicious cycle known as *cosmetic nomadism*: an obsessive, increasingly frustrating search for exhaustive answers to beauty concerns, leading the client to constantly switch products, services, and professionals.

It is estimated that hair salon clients experience an 87% rate of dissatisfaction (data from internal report). This means that the ability to retain a client and build loyalty is scarce. The average *Customer Retention* rate is reportedly 13%. These figures are worth pondering. They show the worrying disparity between the beauty industry's promises and the results, which nearly always fall short of expectations. We envision the need of new approaches and concrete solutions to this problem, the necessity for a cultural movement that aims to re-center individuals, along with their needs, values, and social expectations, within the pursuit of Beauty (Negretti, 2020).

### **ONE PATH TO BEAUTY**

If Beauty becomes a source of pain, openly contradicting its very essence and the promises of its professionals, it becomes inhumane. This creates a ripple effect of negative consequences. We worked with a group of researchers, scientists, university professors, and industry experts to find precise solutions to our clients' Beauty demands. These desires have always been right under our noses, and yet they have often been ignored: maintaining youth, boosting self-esteem, reducing anxiety, increasing interpersonal wellness, caring for the soul. We analyzed the grounds for this dissatisfaction, to find out where the breakdown between expectations and results occurred, and what caused misunderstandings between client and stylist.

Due to the expertise acquired over 60 years of production and distribution of cosmetics, among which professional hair dyes for third party brands, we have had first-hand experience with the dichotomy at the heart of the Beauty industry. On the one hand, it is the backbone of our Country, the industry that has experienced the highest level of growth for over a century, as well as an icon of Made in Italy valued throughout the world. On the other hand, public opinion views it as a second-tier industry, as a place for dropouts to find work. This skewed view of reality has inexorable effects on the futures of young stylists. Since they feel their talents are depreciated, they struggle to seize the real opportunities for personal and professional growth which the sector offers them .

The "drop-out stigma" which is applied to young people who choose to become Beauty and Wellness service providers, or who are encouraged to pursue this track, was corroborated by a scientific study which we commissioned a group of Aesthetic Psychology researchers (Giorgi 2017). According to this research, those who "choose" to become Beauty service providers often find themselves stigmatized, which further saps their low self-esteem, the perception of their own value, and their developing professional identity. Their ability to imagine the future is stunted (Erikson, 1994). This is paradoxical, considering that Beauty is a fundamental aspect of human life, and that these aspiring professionals will one day care for other people's Beauty. The general sense of discouragement that follows can be seen in the recurring frustrations, invalidation, and disqualification which atrophies their *social engagement*: this does not favor individual growth. In fact, it prevents young people from overcoming their induced sense of inferiority (Leonardson 1986; Crocetti and Palmonari 2011).

#### **The need for a broader vision**

This negative, alienating, and destructive effect on young people's self-esteem made us realize the need for a social engagement project. *PROUD TO BE* was created to help develop young trainees' self-

esteem and pride in their profession. The goal is to overturn the current paradigms that prevent Wellness professionals from achieving personal growth, while establishing integrated communications between the spheres of academia, institutions, and vocational training on all levels. Professors, directors, students, professionals, companies, and institutions must work together to build a New Professional Avant-Garde.

Young people need help to identify their own resources and limitations when it comes to their skills and abilities (their knowledge and their know-how), as well as to build their own self-image as individuals who can define who they are, who they can become, and who they want to be (Dinkmayer 2000; Mascetti 2009). In Italy alone, there are over 400 Centers for Professional Development within the nation's DDIF (right and duty to education and training) framework. These are accredited, scholastic institutions in the Wellness industry which comprise around forty thousand students. These talented, sensitive young people are not understood by their families or by institutions; they are used to feeling unwanted, and often identify with a feeling of failure.

When we look at the economic growth of vocational schools dedicated to the Beauty industry (hairstyling, aestheticians, spas, nail salons, etc.), we can clearly see that the "weak link" in this chain is found in the world of hair care, which is the most underdeveloped. The paradox lies in the fact that the hairstylists must manage complex technologies in the salon, like colorimetry, but lack the appropriate scientific tools and knowledge. What is more, teaching is based on perpetuating customs, while failing to emphasize the importance of appropriate lighting at the workplace or address rates of color-blindness, cosmetic companies' tendency to be totally subjective in their choice of tonal values, the use of non-standard color charts, and the use of inappropriate color spaces when teaching color theory.

After analyzing certain areas of research in the industry, we realized that many topics had yet to be thoroughly scientifically investigated. From there, we worked with Italian universities to launch a series of multidisciplinary activities leading to findings and results which were then presented at industry conferences. At the same time, we are participating in other studies that will be published later on, some of which will be presented during this Conference.

### **A new educational approach**

The difficulty in assessing hair color has made dyeing hair an art form, as well as the best way of ranking a hair stylist. The amount of scattering in the hair is so high that the usual tools for measuring color become unreliable (Liberini et al. 2020). Visual inspection by expert professionals arguably remains the most reliable approach, as long as it is preceded by a test, for instance the Farnsworth-Munsell 100-hue test, in order to assess their color discrimination proficiency (and perhaps suggest an undergoing, yet undetected color-blindness, for which further official diagnostic tests are then required). As a direct consequence, visual inspection must be performed under the most natural possible lighting conditions, another key point that still goes ignored for the most part.

In order to assess the level of instruction dedicated to colorimetry at vocational training schools, we performed a national survey of all the textbooks used therein. We found that the content was inconsistent, often limited to a page or two of very simplified color theory without any insights, for a total of 4-6 hours per year of theory. This is how hair coloration has been taught in Italy for nearly 70 years. Similarly, in the professional hair industry, scientific approaches to color and light are almost non-existent. Apart from a bit of information about mixing pigments and a few words about additive and subtractive color theory, there is nothing to be found about color appearance and measuring color.



This leaves plenty of room for re-thinking the way students are trained and establishing an objective method for measuring color with the greatest possible control over all the variables that may influence its appearance. The goal of our project is to push vocational training schools to evolve to a higher level, comparable to academic high schools in some ways, with the aim of putting an end to the model of schooling which penalizes tens of thousands of young people. At the same time, the new approach will equip them with knowledge-based, cultural, technical, and technological tools which they can use to confront an increasingly complex market and use highly technological cosmetics.

With the help of our scientific committee, we have created a new category of instruction which will allow young people to seize innovative opportunities for personal and professional growth and recover their self-esteem. It will be called POLIESTETICO, and it will be launched in Milan at the start of the 2021/22 school year. The authoritative, dignified name is highly evocative and inherently promotes the educational initiative. This will be the first, comprehensive school where each space is an integrated, integral part of an education in which Beauty is a daily experience for students and teachers. Rooms will be carefully decorated, each space intended as a place of art, culture, and wellness. Colors, music, fragrances: all will facilitate the creative process of students. The educational plan will include new areas of study, such as hair salon lighting, aesthetic psychology, colorimetry, and color spaces, with the support of tools and tests which target the acquisition of this knowledge, and which are designed in collaboration with the professors involved in establishing this innovative project.

## **CONCLUSIONS**

The world of hair color requires a deeper investigation of the many opportunities available in this industry. Today, science is able to achieve results that meet modern demands, resolving problems and prejudices that have always impacted the Beauty industry, in particular in the hair sector. Let us take advantage of these possibilities and train young people in a comprehensive and thorough way so that they may be able to apply their new scientific knowledge in the future, while giving the last word to the powerful abilities of the human eye.

## **REFERENCES**

- Crocetti, E., and A. Palmonari. 2011. Le fasi adolescenziali e giovanili nello sviluppo individuale. *Psicologia dell'Adolescenza*, 53-66.
- Dinkmeyer, D. C., and R. Dreikurs. 2000. *Encouraging Children to Learn*. New York: Taylor & Francis.
- Erikson E. H. 1994. *Insight and Responsibility*. New York: WW Norton and Company.
- Leonardson, G. R. 1986. The Relationship between self-concept and selected academic and personal factors. *Adolescence* 21 (82): 467.
- Liberini, S., A. Avolio, S. T. Yankowski, and A. Rizzi. 2020. Consistency issues in hair spectral reflectance and colour measurements. *Coloration Technology* 00: 1-11.
- Mascetti, A. 2009. Incoraggiamento e stile di vita. *Rivista di Psicologia Individuale* 66: 97-104.
- Negretti, G. 2020. *La Cosmetica Umanistica*. Milano: Editoriale Delfino.

# More Than a Tube of Color - The Emotion

Lupe Voss <sup>1,\*</sup> and Sherman Wong <sup>2</sup>

<sup>1</sup> Color Space™; lupe@colorspacehair.com

<sup>2</sup> Collective Beauty Brands; sherman.wong@collectivebb.com

\* Corresponding author: sherman.wong@collectivebb.com

## ABSTRACT

The relationship a colorist builds with their chosen products is deeply emotional and is heavily dependent on trust and confidence in their performance. With this confidence a colorist's focus can remain on their ability to ensure consumers' happiness through proper product choice, which directly affects the livelihood of a colorist. When a person sits in the colorist's chair, there can be trepidation, anxiousness, eagerness, or excitement. As with all relationships, understanding these emotions builds trust between consumer and colorist. How people feel about their hair color is intimate and unique to each individual. Color creates a connection to how people see themselves, and thus a reflection of how one is perceived. We will look at the perception and psychology behind different colors of hair, such as blonde, red, brunette, and grey. These intended consumer benefits – confidence, happiness, comfort - are often derived from this sacred service.

**Keywords:** *Relationship, Psychology, Hair Color, Emotional connection, Trust*

## INTRODUCTION

A tube of hair color has a broad impact on lives. Like most products used in the beauty industry, hair color is utilized as a relationship and confidence builder. The emotional connection to hair color is intrinsic to these relationships. A connection to the colorist, from the colorist to the consumer, and from the consumer to their chosen hair color, drives the color product choice, and our chosen hair color result.

## THEORY

Hair Color service is a relationship of the colorist and the consumer, achieved through a tube of hair color. Product choice creates trust and confidence in this relationship. The sacred hair color service triggers emotions and influences the perception of an individual.

## SURVEY

Two questionnaires were developed to investigate the behaviors and opinions of hair color consumers and professional hair colorists. Questions are formatted in multiple choice and short answer form. A total of 500 hair color consumers, including 281 professional hair colorists were surveyed. Data collection was conducted between May 17, 2021 to June 17, 2021.

## RESULTS AND DISCUSSION

### Product Choice

When selecting a hair color line, the most important factors to a colorist are the performance, the customizability, and the environmental impact. Survey respondents are prompted to select top deciding factors when selecting a hair color line. Figure 1 is an illustration of the result.

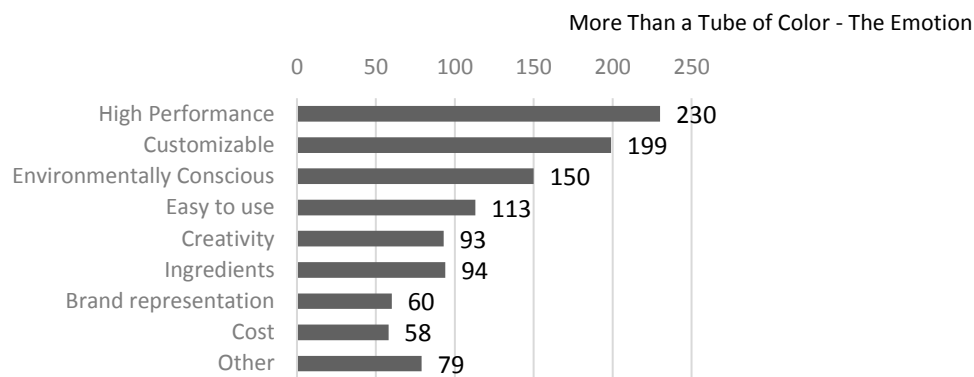

Figure 1: Important Deciding Factors to Selecting a Hair Color Line.

### High Performance

When a colorist is choosing a hair color product to represent their work, quality is vital. Trusting that the hair color will perform as expected builds confidence in the colorist to achieve what the consumer expects. Amongst the surveyed professional hair colorists, 19% of the respondents experience 100% success rate; 58% of the respondents experience 90% success rate; 19% of the respondents experience 75% success rate; and 4% of the respondents only experience 50% success rate. No surveyed colorists use a hair color line that delivers below 50% success rate. Hence, performance of hair color provides the confidence for colorists to deliver consumer's needs (Table 1, left).

Along with trust, hair color performance builds loyalty in both the colorist and consumer. The colorist is loyal to the hair color brand and the consumer is loyal to the colorist. Analysis shows that 51% of the respondents, who are professional hair colorists, use a single hair color line. This is an indication of colorists trusting the performance of their selected choice of hair color product (Table 1, right).

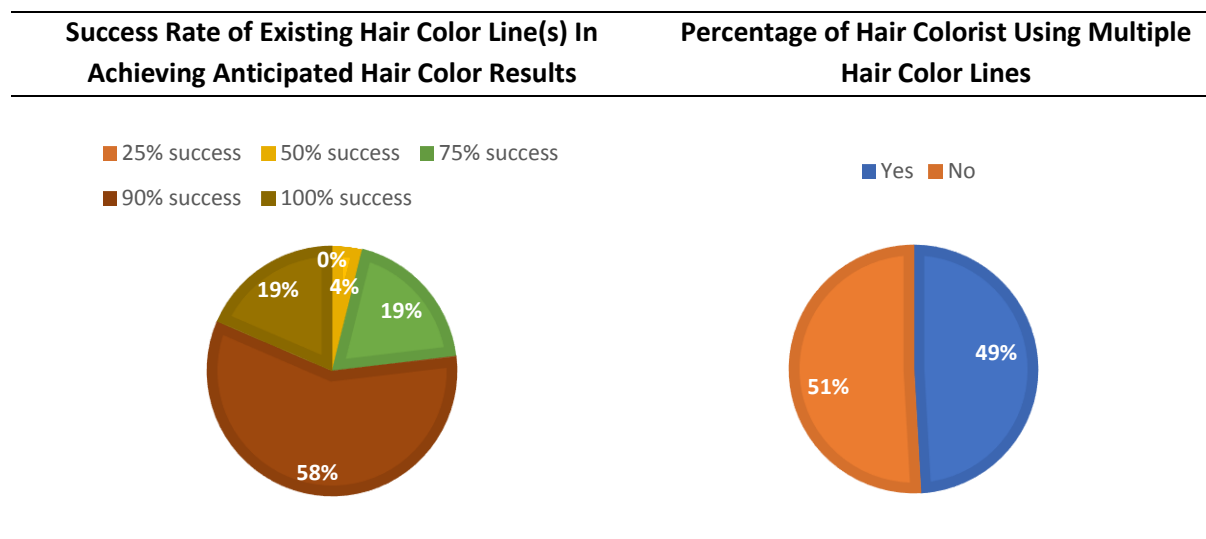

Table 1: Analysis of Hair Color Lines.

Confidence in a product connects directly to a colorist on an emotional level. Quality components within the tube of hair color, supported by a foundation of strong education, create predictable and consistent results. When predictable results occur, the colorist trusts the product performance, and confidence is established.

### *Customizable Hair Color*

The ability to be creative with hair color is very appealing to a colorist. Marketing a customizable hair color to consumers is a natural fit with the current trend of “individuality”. Fisher et al. (2016) suggests that the colorist needs to assess a series of variables when formulating hair color. In order to create the desired outcome, variables such as Hair Texture, Hair Type, and Density affect a color formula and need to be considered. Using the same formula on different clients will not produce the same results. Product performance and formulation ease are a must when working with customizable hair color. A colorist works with tight schedules and cannot spend extra time adjusting an unexpected hair color result. In the beauty industry, time has a direct correlation to money.

### *Environmental Impact*

Because of the current state of the global environment, more companies in the beauty industry are focusing on sustainability. Sparknews Report in collaboration with Cosmoprof Worldwide Bologna (2019) stated “Pioneering beauty brands focusing on positive impact innovation and creativity are paving the way for eco-conscious products and green companies to take over the market and showing their less sustainable siblings that green is not only the new glamorous — it’s also a mean to preserve the well-being of our planet and the people who live in it”. Colorists connect to hair color companies that advocate the following beliefs: clean ingredients, plant-based ingredients, vegan, PETA friendly, innovations to make color easier to use.

Search engines are widely accessible. It is not uncommon for colorists and consumers to research where ingredients are sourced. One also expects the cleanest ingredients that give a quality performance while remaining sensitive to environmental impact. A clean product that is sensitive to the environment should be the goal for all hair color manufacturers.

### **Confidence and Trust**

#### *The Confidence a consumer has in their colorist*

The relationship between the colorist and the consumer is a strong emotional connection. Majority of the consumers, represented by 97% of the respondents in the questionnaire, trusts that the colorist is knowledgeable and competent to give recommendations and create suitable outcomes. There can be a lot of emotions connected to this trust. Until this trust is established, there can be fear and anxiety before a hair color service. Such emotions can return when adjustments are required. Having a consistent, reliable product will help colorists to be successful; hence maintaining the established trust. Trust in the colorist is established through different stages of the relationship (Table 2, right).

#### *Stage 1 - Before the first hair color appointment*

The consumer gets introduced to a colorist through avenue such as referral and research. 18% of the survey respondents trust their colorists through word-of-mouth reputation.

#### *Stage 2 – After the first hair color appointment*

In the first appointment, the consumer and colorist are both getting to know each other. A solid consultation kicks off the relationship between the colorist and consumer. The consumer is anxious, fearful, insecure, and vulnerable sitting in the colorist’s chair. This fear is alleviated with each question a confident colorist asks during the consultation, and as the consumer feels heard. 57% of the survey respondents trust their colorists after the first appointment.

*Stage 3 – After the second and third hair color appointments*

During the second appointment, any adjustments needed stemming from the previous service is addressed. This appointment can be pivotal in the colorist/consumer relationship. The consumer assesses how well the colorist performs the second service and understands the consumer’s needs. A consumer returning for their third appointment indicates that trust has been established. It is also apparent at this appointment that the colorist understands the consumer, and the consumer knows what to expect from the colorist. The consumer has built trust in the colorist to do what is right and that the colorist can adjust or correct anything the consumer does not like. 20% of the survey respondents trust their colorists after the second and third appointments.

*Stage 4 – Trust established*

95% of the surveyed respondents would have established trust to their colorists upon reaching Stage 3 of the relationship (Table 2, left). Once trust is established, consumers will start to feel confident to the recommendations from the colorists. From the questionnaire surveying professional colorists, 22% of colorists agreed that 100% of their clients will allow them to select hair color for the clients with absolute trust. 38% of the colorist agreed that 75% of their clients will allow them to choose hair color for the clients with absolute trust. This is a significant indication that the established trust empowers the colorist to make appropriate recommendations to the consumer.

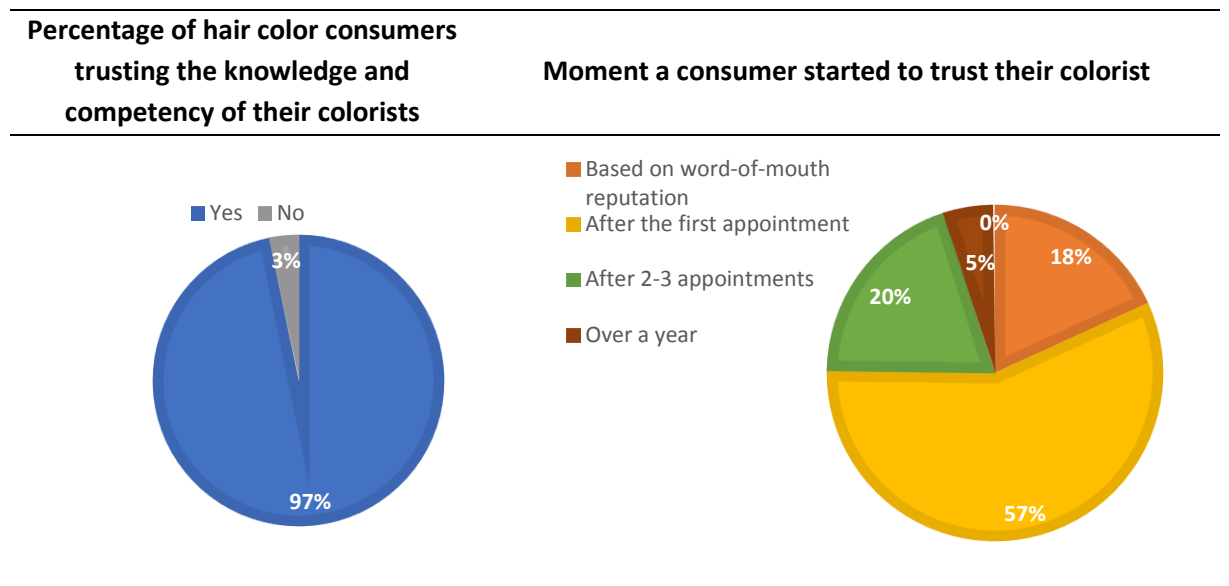

Table 2: Analysis of consumer’s Trust towards their colorists.

**Perception and Emotion**

Beauty consumers search for ways to look their best and feel beautiful. This personal quest can create specific individual emotional responses which can in turn drive this search for tools that will help one feel more beautiful. Hair color is a tool that can be utilized in fulfilling the emotional responses. Examples of emotional responses include confidence, acceptance, self-expression, individuality, and self-representation.

There is an intense psychological connection to hair color as well. There are two ideas to consider; how we perceive ourselves and how others perceive us.

Table 3 illustrates some preconceived ideas of an individual's personality or characteristics connected to hair color. Words can be definitive in our perception. As we go through this world of opinions, we have heard how people see blondes, brunettes, reds, and grey hair. Kyle and Mahler (1996) found that biases regarding personal appearance may affect judgement about a female's applicant's ability in a job application process. These perceptions or preconceived ideas of who we are, affect how we perceive ourselves, our relationships, and employment. We often hear others' ideas of how they perceive Blondes, Brunettes, Reds, and Grey hair. This can define our perception and how others perceive us.

	<b>Positive</b>	<b>Negative</b>
<b>Blondes</b>	Blondes, have more fun Blondes always get their way Popular Glamorous	Low IQ / Weak Blondes are only interested in their looks Mean
<b>Reds</b>	Red heads are passionate Wild / Libidinous / Impulsive Quick-tempered	Hot-blooded / Hot-tempered / Angry Get thing done Funny / Personality
<b>Brunettes</b>	Brainy brunette / smart Sophisticated Clever/witty Down-to-earth / wholesome / sensible Girl-next-door	Serious Plain-looking / dull Mousy Villains
<b>Grey</b>	Knowing Wise Confident Grey	Unrelatable Grandmother / Grandfather Old Unfavorable

Table 3: Perceptions of Blonde, Red, Brunette, Grey.

*Perception and Emotion behind grey hair*

A personal weighing of emotions is involved when the consumer decides when to cover grey hair and when to stop. In our survey, 40% of the total respondents do not have grey hair; 60% have grey hair. 78% of this grey hair population uses hair color to cover their grey hair; and the remainder 22% embrace their grey hair.

Emotionally, the decision to cover or grow out is individualized. The top two reasons our surveyed respondents choose to cover their grey hair is because covering greys makes them feel better and more youthful. There is a balance of feeling insecure with appearing old or appearing desperate to look young. In contrary, the top two reasons our surveyed respondents choose to grow out their grey hair is because it is less maintenance and like how they look. The decision to embrace the grey will arrive when a person is emotionally prepared.

*Perception of Ourselves and Emotion*

Hair color plays a role in our identity. How we regard ourselves is paramount to our hair color choices. Choosing the hair color that best suits our perception of who we are, blonde, red, brunette, or grey, is about self-identification. How we think others perceive us is affected by our biases learned from our experiences. The emotional connection by how others regard us stirs in us fear, insecurity, and uncertainty. Most consumers strive for social acceptance and approval. There is often a feeling of joy

when someone compliments our hair, as the compliment is a validation of the consumer's hair color choice.

## **CONCLUSIONS**

The hair color service that evokes emotions such as confidence, happiness, and comfort, is an important moment that changes how we feel about ourselves. These emotions are derived from the sacred hair color service and start with a tube of hair color. The relationship of a hair color product to the colorist, the colorist to the consumer, and the consumer to their hair, is profound. The relationship involves building trust and understanding, which results in an emotional impact to the consumer. The celebration of individuality is unique to how a consumer feels about their hair color choice. Consumers show the world how they want to be perceived - their statement and their self-expression.

Become aware of all the different hair colors surrounding you and see how you perceive them. Know that there is a trusted tube of hair color that performs perfectly and is emotionally contributing to personal acceptance and happiness.

## **ACKNOWLEDGEMENTS**

The assistance provided by Martin Barriga, Pat Beaupre, Ph.D, Erik Arveseth, and Janice D'Souza was greatly appreciated. A special thanks to Giannantonio Negretti and Orazio Ray Civello for their encouragement and support. Finally, I could not have completed this without Manual Voss, who provides stimulating discussions as well as happy distractions to rest my mind outside of work.

## **REFERENCES**

- Fisher, J., S. Held-Perez, and V.A. Stavrakis. 2016. Pivot Point Fundamentals Color. Chicago, IL, USA: Pivot Point International, Inc.
- n.d. hrf - 12 Red Head Personality Traits. Accessed June 13, 2021. <https://healthresearchfunding.org/12-redhead-personality-traits/>.
- Kyle, D.J., and H.I. Mahler. 1996. "The Effects Of Hair Color And Cosmetic Use On Perceptions Of A Female's Ability." *Psychology of Women Quarterly* 447-455.
- ListAKA. 2015. Top 10 Blonde Stereotypes. Accessed June 30, 2021. <https://listaka.com/top-10-blonde-stereotypes/>.
- Sparknews Report in collaboration with Cosmoprof Worldwide Bologna. 2019. Cosmoprof. [https://www.cosmoprof.com/media/cosmoprof/cosmotalks/Aziende%2520impactxbeauty/CPBO\\_IMPACT\\_FOR\\_BEAUTY.pdf](https://www.cosmoprof.com/media/cosmoprof/cosmotalks/Aziende%2520impactxbeauty/CPBO_IMPACT_FOR_BEAUTY.pdf).
- Stollznow, K. 2021. Psychology Today - An Examination of Stereotypes about hair color. April 24. Accessed June 10, 2021. <https://www.psychologytoday.com/us/blog/speaking-in-tongues/202104/examination-stereotypes-about-hair-color>.
- Stoskopf, K. n.d. Minq - What Does Your Hair Color Say About Your Personality? Accessed June 13, 2021. <https://www.minq.com/lifestyle/50411/what-does-your-hair-color-say-about-your-personality/>.

**SPECIAL SESSION**  
**ALL THE COLORS OF CINEMA**

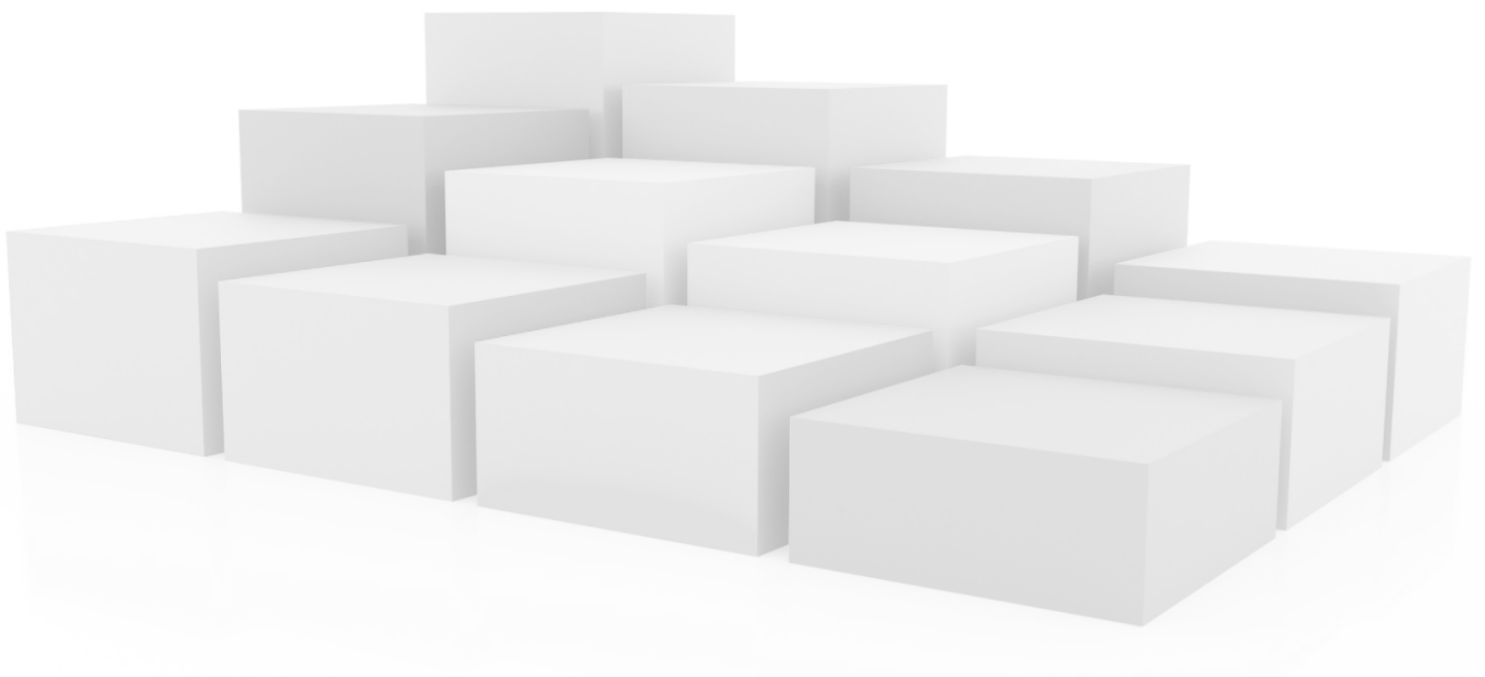

AIC 14<sup>th</sup> Congress Milano 2021 - August 30<sup>th</sup>– September 3<sup>rd</sup> 2021





# Handling Color in Photography and Film: From Photo Retouching to Color Grading

Ivan Magrin-Chagnolleanu <sup>1, 2,\*</sup>

<sup>1</sup> Aix-Marseille Univ, PRISM Laboratory, Marseille, France ; ivan.magrin-chagnolleanu@cnrs.fr

<sup>2</sup> Chapman University, Orange, California

\* Corresponding author: ivan.magrin-chagnolleanu@cnrs.fr

## Abstract

This paper deals with photo retouching and color grading. It proposes a simplified workflow for both of them. It also points the commonalities and the differences, and further explore the relationship between the two, including a phenomenological point of view as well as an aesthetic point of view.

**Keywords:** *Photography Retouching Workflow, Color Grading Workflow, Color Aesthetics, Phenomenology of the creative process*

## INTRODUCTION

In this paper, I explore how color is used in photography and film. I focus my contribution on the treatment of color after the images have been recorded. I am speaking from the point of view of a scholar dedicated to photography and film philosophy and aesthetics, but also from the point of view of a long-term practitioner as both a photo retoucher and a color grader.

The outline of the paper is as follows: the first part deals with photo retouching. A simplified workflow is proposed. A second part then deals with color grading, and a simplified workflow for color grading is also proposed. A third part compares the two approaches, points the commonalities as well as the differences, and also shows how the two approaches can feed each other. And finally a conclusion wraps-up the paper.

## PHOTOGRAPHY RETOUCHING AND COLOR

Most professional photographers nowadays use softwares from the adobe suite. One particular program, Lightroom, has been developed with the photographer workflow in mind, and offers various ways to save a lot of time in the process. Even though the topic I discuss here is not related to the use of a particular software, part of how I do things might be. There are also numerous plug-ins that exist today, whose job is to allow a professional photographer to save time. I am very fond of Color Efex Pro (and Silver Efex Pro for Black&White photography)<sup>1</sup>.

### Why do we retouch a photograph

Today, retouching a photo is something a photographer can do on their own. All they need is to open the raw digital file inside a software, and then push buttons and see the corresponding result. This process is non-destructive. It has become entirely part of the creative process. Because there are so many possibilities now, you end up playing with the possibilities and expanding your horizons.

So why do we retouch a photograph? We do it to improve the look of the photograph, in terms of contrast, colors, framing, final look, etc. But we also do it to try new things, to play with the possibilities of the tools we use. Photo retouching is therefore an investigative process.

### What is the color component of photo retouching

In this whole process, not everything is directly related to color, though most of it has an impact on how color is perceived. For instance, changing the exposure of a picture impacts the perception of

---

<sup>1</sup> I owe the discovery of that plug-in to Rick Sammon (2016).

color saturation: making a picture darker tends to make us perceive it as more saturated. The first steps of a retouching workflow often deals with brightness and contrast. And then we start playing with color. We can do several things at this point. We can check the setting of the white balance, and if we are using raw files, we can choose a different white balance even after the picture has been taken. We can also tell the software where our real whites are and let the software change the settings accordingly. This whole process, called “removing a color cast”, consists in compensating for some technical limitations of the camera we used, or the circumstances of the picture.

There is then the possibility of wanting our picture to look a bit different colorwise. For instance, if you took the picture of a sunset, and you noticed that your camera tended to bring the whole scene a bit more towards yellow than pink or orange, you can then add a tint of pink or orange to make the picture look closer to what you remember or what you intended.

### **A possible workflow for photography retouching**

Let me now propose a simplified workflow for photo retouching. First of all, as mentioned earlier, I mostly use Lightroom to do my work on pictures. With Lightroom, you can import images, sort them, define all sorts of metadata, retouch them, and then export them. I will deal here only with the part of the workflow that deals with retouching pictures.

I also want to point out a very important principle in art making. There are no immutable laws. Even when you have a workflow in place, occasionally you will choose to deviate from it. Besides, this workflow is also meant to be rethought, and hopefully improved with time.

#### Photo Retouching Simplified Workflow:

- **test the auto setting:** sometimes, the resulting retouching is close enough and I continue from there, and sometimes the original picture is closer to what I want and I then start with the original picture.
- **adjust the exposure:** it is possible at this stage to modify the white balance inside the software, but I rarely do it. It is because I have usually set the white balance up before taking the picture, and therefore rarely need to change it later. I often tend to lower the exposure a bit. I have found that, most of the time, the auto button tends to set an exposure that is a bit too bright for my taste.
- **adjust the contrast:** I tend to prefer more contrasted pictures, because that makes them more pictorial, more graphical. For those first steps, auto, exposure, and contrast, I usually use my eyes only. Then, I rely mostly on the histogram, and a bit on my eyes.
- **adjust the highlights and the shadows:** the idea behind those two steps is to occupy the whole range of brightness from black to white, in order to have the best possible distribution of pixels.
- **adjust the texture, the clarity, the dehazing, and the sharpening:** these four sliders have to do with the granularity of the picture, and how it looks in terms of details. I barely change them, but often just a bit, to increase the crispiness of the picture.
- **adjust the vibrancy and the saturation:** we finally get to the color aspect of retouching pictures. I usually utilize two sliders to do it, the vibrancy slider and the saturation slider. In most cases, I increase both a bit and that gives me a richness in terms of color that I like. Occasionally, I will desaturate slightly, but only for very particular photos.
- **use the color efex pro plug-in:** I will then open the picture in color efex pro, and will play with some of the possibilities of this plug-in to enhance the picture.

### **Aesthetics considerations for photography retouching**

I often wonder why I make the choices I make, or why photographers in general make the choices they make, in particular regarding color. One way to answer that question is by saying that a photographer remembers the scene he took a picture of, and consciously or subconsciously tries to match the picture and the memory of that scene. A perfect example of that is when taking a picture of a sunset. The captured picture will always deviate from what was really in front of our eyes. And the temptation would be to correct the picture later, to make it as close as possible to what we remember. But that would be forgetting that a picture is only a representation of reality. The truth is much more complex. When I retouch a picture colorwise, I try find the color treatment that would serve that particular picture best, that would enhance the power of evocation of that picture.

Concretely, there is a part of habit in the process. We tend to do things the way we are used to doing them. But how did we come up with this way of doing? This process is usually incremental. We first learn to do it through practice, on the one hand, and from learning, on the other hand. We can learn from someone, from a book, from an online course or tutorial. Then, once we have a basic workflow, we keep experimenting, and we keep learning from courses, books, tutorials. That process will constantly open perspectives, suggest other ways to do it, sometimes better ways, sometimes not. But as we gain knowledge about the process, be it in practice or by learning, we expand our horizons and the possibilities. At the same time, we develop a way to adapt to a particular photo our own way of doing things, our own style. Maybe we try to match aesthetics we love, from photographers we admire. Maybe we are also trying to match other media, like painting or film. In the end, there is something subtle guiding us in this quest for beauty, for the most aesthetically satisfying picture. It has to do with what motivated us to take the picture in the first place, what we want to express through that picture, something that has to do with some universal truth, but seen through the prism of our own experience and our own peculiarities.

## ***COLOR GRADING AND COLOR***

Let us move on to color grading. I got involved in it quite naturally. Because I had done a lot of photo retouching. Because I was making films. And because it made sense to me to do my own color grading on my film projects. And then I started doing it for other people.

### **Why do we grade films**

There is a slightly different reason why we grade films, compared to photo retouching. In color grading, there is an important motivation which is to save shots.

The rest of the job pretty much resembles that of a photo retoucher, with one big difference: we are now working on moving images, that is, we are not just retouching one still image, or a series of a few images, but 24 or 25 or 30 images per seconds, from the beginning of a clip to the end of a clip, clip after clip, from the beginning of the film to the end of the film. This work is comparatively huge in terms of involvement and time, and there are also considerations about the unity of a shot, of a sequence, of a film.

### **What is the color component of color grading**

As with photo retouching, the whole process of color grading does not have to do with color, although it can be argued that everything a color grader does impact color perception. But there are mostly two operations that directly have to do with color. The first one consists in removing a color cast, that is, identifying what is supposed to be white and trying to bring those particular pixels back to white. It can also be done by using some particular scopes, called parade, which displays the repartition of

luminosity for each of the three sensors (red, green blue), and often allows to detect discrepancies between them. The second one concerns finding the look of a clip, a sequence, or an entire film. This often includes considerations on whether the mood of that particular clip, sequence, or film should be colder or warmer.

### **A possible workflow for color grading**

Let me now propose a simplified workflow for color grading. The software I am using is Davinci Resolve, which has imposed itself as the professional tool for color grading. It was first developed only as a color grading tool. Now, Davinci Resolve is an entire post-production suite. The workflow I propose here is not specific to Davinci Resolve though.

Also, as I stated previously for photo retouching, a workflow is a guideline. But there is no law preventing to occasionally deviate from that workflow. And a workflow is also here to be continuously improved.

#### Color Grading Simplified Workflow:

- **brightness/contrast/highlights/shadows:** for color grading, I prefer using curves, which is a tool I rarely use for photo retouching. The reason why I like curves in color grading is that it allows me to do several operations all at once, while using at the same time my eyes and the scopes. With some experience, it takes only a few seconds to correct the brightness/contrast/highlights/shadows of a clip all at once. To use the curves tool, I usually set up a point close to white and then move it until I get the expected result. And then I set a point close to black and do the same thing.
- **removing a color cast:** I use again the curves tool to do it, but this time, I use it color by color (red, green, blue). I will mostly use the scopes as a guideline, but I also keep an eye on the image itself.
- **secondary correction:** the first two steps are called primary correction, meaning they are applied to the whole image. A secondary correction is a correction that is only applied to a part of the image, for instance a face. It requires the use of a mask, and then tracking of the mask across the whole clip. This is used only when necessary as it is very time consuming to set it up and adjust it. It is often used to lighten or darken an area of an image, to make it more or less present.
- **adjusting between clips and sequences:** this step consists in adjusting consecutive clips and/or sequences in order to smooth the experience of the viewer. Sometimes, the opposite effect is sought after: increase the transition effect between one clip and another, or between one sequence and another.
- **working on the look of a clip/sequence/film:** the last step consists in working on the look of a clip, sequence, or film. This usually requires applying some additional effects on the images, often through the use of LUTs (Lookup Tables) which are preset tables allowing to apply entire looks and/or filters to clips. Color is often an important component of the look of a film. This is mostly due to the correlation between color and mood.

The last two steps can be inverted. It is often possible to start working on looks before doing all the clips or sequences matching.

### **Aesthetics considerations for color grading**

Again, the question that comes to mind is: why do we, as color graders, make the choices we make? The answer here is not much different from the one I gave for photo retouching. Habit is part of it, improving a process too, and matching a particular aesthetic we like.

But there is a big difference here. Photography is usually a one-person medium. Film is a collaborative medium and the color grader is not the only person making decisions on the color grading

process. The director is also involved, quite often too the director of photography, and sometimes other people too (some producers, or studio executives). It makes the process more complex, and requires the color grader to be able to argue their choices, and also to be flexible enough to integrate the vision of other people, even when that vision contradicts their own.

### ***A DIALOG BETWEEN PHOTOGRAPHY RETOUCHING AND COLOR GRADING***

Let us now investigate on the relationship between photo retouching and color grading. This is rarely done because it is not so common to find people who do both. I happen to do both, and I have consistently and often written accounts of my work as both. This led me to think that a good color grader has to be a good photo retoucher (the opposite is not necessarily needed). It is due to the fact that the building blocks of working on the look of a film is to work on the look of images. Writing consistently on my work as both a photo retoucher and a color grader also led me to see a dialog between the two, pointing the similarities as well as the differences, and developing an understanding about the tight relationship between the two, and how they could mutually influence each other. This, of course, also has important implications from a pedagogical point of view.

#### **Similarities between photography retouching and color grading**

As you probably noticed, there are similarities in the workflows I presented for photo retouching and color grading. In both cases, we deal with the same first three steps: correcting brightness and contrast, correcting color, and applying a look.

Another similarity has to do with the kinds of tools we find in the softwares that we use to do those jobs. Even though color grading has a few additional tools, the tools we use for the first three steps are very similar. There are sliders, curves, and scopes (mostly a histogram for photo retouching).

Finally, aesthetic considerations about what makes an image beautiful and/or meaningful and/or impactful are also very similar.

#### **Differences between photography retouching and color grading**

Let us now investigate about the major differences between the two. The first major difference has to do with the nature of the medium. Because a film is a rapid succession of still images, there are important additional considerations to take into account when color grading.

First, at the very basic level, we color grade a clip and not a still image. It means we have to select the referent image carefully, if we want the correction to translate in a satisfying way to the other frames of the clip. It also requires to test the correction we made across the whole clip, by watching it entirely to see if there is anything else to adjust. This is particularly difficult when the nature of the material is changing drastically across the clip, as is the case for a long sequence shot.

We also mentioned earlier what is called secondary correction. Of course, it is not uncommon to correct only part of a photograph when we retouch it. But with film, we are also concerned with tracking, that is, with the fact that this secondary correction has to be applied along a clip and not just to a still image, and to the right area of the image, frame after frame.

There is also the question of clips matching, which obviously does not exist in photo retouching, except when we work with serial photography. When matching clips, it's not just the aesthetics of a still image that we are after, but also the aesthetics of an entire sequence. And that requires different analytical skills and aesthetic knowledge. This is equally true when matching the sequences of a film to give its visual unity to a film.

#### **The relationship between photography retouching and color grading**

I would like to expand the previous discussion about similarities and differences between photo retouching and color grading by exploring a bit further the relationship between the two.

Because the nature of the medium is not the same (still images versus moving images) and because the nature of the work is different (solitary work versus collaborative work), it is not uncommon to make some discoveries in one medium and then translating that discovery (when possible) to the other one. Some of my work as a photo retoucher has deeply influenced some of my work as a color grader, and vice versa.

Because the workflow is not entirely the same, and because the tools are not entirely the same, discoveries concerning aesthetics and also the use of tools and the workflow can happen indifferently in one medium or the other. This is also why a photographer can be influenced by a filmmaker and a filmmaker can be influenced by a photographer.

But this relationship goes much deeper. And this is something that is harder to explain since it is mostly phenomenological, that is, based on a lived experience. It is a bit as if those two things were only one thing for me and, as I work on a photo, I mobilize knowledge from both the photo and the film worlds, and from both my experiences as a photo retoucher and a color grader, and it is the same when I work on a film as a color grader. This is also the reason why I keep learning about photography to feed my film work, and why I keep learning about film to feed my photo work.

#### **Pedagogical implications of the relationship between photography retouching and color grading**

I will not expand too much about the pedagogical implications of that relationship between photo retouching and color grading. I will just say that I always have students of color grading work on photo retouching first, and I encourage them to keep doing so all over their career. I also suggest to students of photography who are particularly interested and fluent in photo retouching to look into color grading as a career, or at least as a strong interest of theirs.

#### **CONCLUSION**

In this paper, I have dealt with photo retouching and color grading. I have offered a simplified workflow for both. I have also discussed the commonalities and the differences between the two, exploring the tight relationship they had with each other. The next steps of this research would be to expand even further on the relationship between the two, and to develop the implications for practice and pedagogy.

#### **REFERENCES**

- Alekan, H. 2001. *Des lumières et des ombres*. Paris: Éditions du Collectionneur.
- Bleicher, S. 2012. *Contemporary Color: Theory & Use*. Boston: Delmar Cengage.
- Brown, B. 2016. *Cinematography Theory and Practice, Third Edition*. New York: Focal Press.
- Frost, J. B. 2009. *Cinematography for Directors: A Guide for Creative Collaboration*. Studio City: Michael Wiese Productions.
- Haine, C. 2019. *Color Grading 101*. New York: Routledge.
- Hullfish, S. 2012. *The Art and Technique of Digital Color Correction, 2nd Edition*. New York: Routledge.
- Hyman, J. 2006. *The Objective Eye: Color, Form, and Reality in the Theory of Art*. Chicago: University of Chicago Press.
- Magrin-Chagnolleau, I. 2013. The Use of Color in Theatre and Film. In: *Proceedings of AIC 2013*, 1481-1484.
- Mollica, P. 2012. *Color Theory*. Mission Viejo: Walter Foster.
- Sammon, R. 2016. *Evolution of an Image*. New York: Routledge.
- Storaro, V. 2011. *Writing With Light, Colors, and the Elements*. Florence: Mondadori Electa.

# Color correction and color grading: how a film colorist works

Pedro F. P. Souza <sup>1,\*</sup>

<sup>1</sup> Universidade Estadual de Campinas - UNICAMP; pedropinho88@gmail.com

\* Corresponding author: pedropinho88@gmail.com

## Abstract

Amongst many professionals involved in making a film, this paper intends to analyze the colorist's work as an artistic work. This professional performs his work during post-production. They are supposed to digitally manipulate the pixels of the images. It is possible to say that these professionals, within the cinema production chain, are the latest responsible for the chromatic aspects of an audiovisual work before it is released. The work process can be divided into two parts: color correction and color grading. This text aims to show the importance of these two processes to guarantee a satisfactory performance for the colors in a film. In this sense, the uses of color will be analyzed in the film *Joker* (2019).

**Keywords:** *color correction, color grading, cinema, look*

## INTRODUCTION

It is easy to see, nowadays, the importance of post-production processes in films, modifying the color of an image seeking greater aesthetic and believable security seems to be a prerequisite for any current audiovisual production, and in this sense the role of the colorist is fundamental. The purpose of this work is not to bring news in the area or new ways of carrying out the processes, but rather to interpret and analyze them from the perspective of creation and the debate between technique and art that permeates the colorist's work.

How to associate a color to a certain feeling? Apparently, humanity has been doing this since its inception, and it continues this process today as an eternal mission in an attempt to understand the world. Cinema is an example and a means through which this mission continues to exist. The main premise here is that only the creative and artistic process will be able to understand color in the perceptual and sensory development of individuals and works, especially films.

An important debate concerns how the colorist is seen in the cinematographic universe. Due to the increasing importance of digital techniques to the detriment of analogue ones, the colorist is often seen as the technician responsible for adjusting the image to established standards using predetermined software with automatic functions, while other professionals, such as director of photography and art director, are in charge of bringing "artistic aspects" to the image. Often the colorist is seen as the one who masters the software and only applies what is asked of him.

Currently, as reported by Edgar Moura (2016), many believe that the colorist's work is limited to balancing and equalizing the shots, optimizing the images so as not to let mistakes, or exaggerations made during recording, be noticed, something like "fix the image", a "quality control" function. This is really one of its functions, but not the main one, nor the only one. The colorist's main job is to propose the look, a visual identity for the work! And, in order to do this, it will require more effort than just manipulating software or knowing the basics of color theory.

### Automatic Color Correction

Authors and even professionals in the cinema field differ on how to name and divide the different stages of the digital colorization process. The stage of cinematographic post-production that intervenes and modifies the filmed image by manipulating the pixels is called color correction or color grading. Alexis Van Hurkman, an American colorist, differentiates between these two terms: "I would



argue that color correction refers to a process that is more technical in nature, of making adjustments to correct clear qualitative problems in an image, bringing it to a fairly neutral state, whereas grading refers to a more intensive process of developing an appropriate overall style for the image, relative to the narrative and artistic needs of a program (Hurkman 2011: ix).”

Hurkman already show us, therefore, of the importance that the colorist has in the process of construction of the cinematographic image. The terms, however, still need attention as they can be confusing. By separating the two terms into two different concepts, the author also establishes different steps for the process. A first, with a technical character, and a second, with an artistic bias. Digital colorization, as a process, provides the cinematographic work with two important developments: chromatic constancy, which will determine the verisimilitude necessary for most cinematographic works, thus guaranteeing a simulation of reality by assembling the planes under the same chromatic identity. The second development involves the creation of a look proposal, this step is called color grading (Hurkman 2014) and meets the narrative and artistic needs of the work.



Figure 1: The importance of color correction to create verisimilitude in a film.

Currently, what can be seen is the standardization and automation of color correction processes, especially color matching, the equalization of images in search of creating chromatic constancy. The colorist is no longer the real person responsible for color correction itself, as this process is increasingly automatic, and becomes an organizer of the workflow to enhance the intended look. To ensure this flow, the colorist needs to know the color spaces, the cameras used, and the project output in order to automate the process. In this sense, current software, such as DaVinci Resolve, create systems to collaborate with this, automating the processes as much as possible..

However, if the processes are increasingly automated, what should the colorist do? Firstly, not every automated process is perfect, so the checking of each shot and sequence of the film needs to be analyzed by the colorist, and punctual modifications need to be made in order to guarantee chromatic constancy. Second, the creative processes now become essential to guarantee this professional in the market as an artist and not a technician. Therefore, the importance of knowing but always questioning ready and automated looks, as accepting automated looks will be the colorist's attestation of technicality against his artistic work. If the automation of the color correction process is acceptable, considering that this process is much more mechanical than creative, automating the process of creating the look will only bring harm to professionals as they will be able to treat their work less under one artistic bias in detriment of the technique used.

We defend the idea that the colorist is an artist within the cinematographic chain of functions, as well as the cameraman, art director, editor, etc. his art is fundamental and the manipulation of color and its symbolism in a film makes him an artist, denying this function will only diminish the value given to this professional.

### **Colorist: technician or artist?**

The technique of applying colors in the computer environment demands from the colorist the subjectivity of choosing each color for the image, no longer within the numerical model, but as a sensation. The color inscribed in this subjectivity is what feeds the colorist's art. Thus, the color, real or digital, functioning as a sensation in the work, brings a subjectivity that is provided by the technique. In short, color appears as a fundamental element of the image, a minimum element in the pixel, numerical model and machinery, and also as a maximum element in the image, as a pure sensation.

The debate about color in cinema, which took place at the beginning of cinema, is similar to the debate about the introduction of digital techniques, and it is interesting to note the conservatism regarding the use of colors in this art, as it does not allow the free use of colors in films other than musicals and fantasies. Fortunately, some authors would question this premise and introduce color into films by associating it with narrative and carrying the works of symbolic references brought by color.

The use of color as an element of verisimilitude and the color correction technique have similarities. As well as the color grading technique that makes possible to provide visual pleasure through the work and expands its narrative capacity. There are, therefore, two aspects that come together in the digital colorization process, one technical and the other artistic. Edmond Couchot (2003) understands that it is the techniques that give access to art, that is, the control of a given technique will develop, or even produce, new forms of art. "The image is an activity that puts techniques into play and a subject (operator, artisan or artist, according to each culture) operating with these techniques, but possessing a know-how that always takes the voluntary trait, or not, of a certain singularity. As an operator, this subject controls and manipulates techniques through which he lives an intimate experience that transforms his perception of the world: the technesthetic experience. (Couchot 2003: 15)."

Philippe Dubois (2004: 57) also theorizes about it, and declares: "[...] the essential invention is always aesthetic, never technical". This technique, therefore, is not separate from the "intimate experience" that the colorist has with the tool, and by manipulating and understanding it in depth, it will develop new and different possibilities for its use, distancing itself from the purely technical character (if at all this exists) and approaching an artistic bias in the use of the tool.

Thus, the more automatic and predetermined characteristics appear to control the image, the more aesthetic possibilities will appear for those who control the tool to be able to modify and question this automatism and approximation of the image fixed in reality. The colorist, by mastering the software, at the same time, masters ways to modify the image and give it his personal characteristics and traits as an artist in the process.

That's why ready-made and pre-set looks undermine the colorist's experience as an artist. Not producing the look in a thoughtful and structured way through color concepts and its symbology and theory is a problem and transforms the colorist into just a reproducer of ready-made concepts, in which color does not acquire certain aesthetic characteristics, nor useful symbolism in the narrative, just serving the purpose of verisimilitude of the work, without narrative or visual depth. In this sense, the example most used by the film industry is Teal and Orange. This look works because it pleases the eye by opposing two complementary colors – blue cyan and orange warm tones, the orange tone

normally present on the skin of the vast majority of characters, while cyan can be found in the sky, at night, and in most current scenarios, generating this currently famous contrast. The big problem is not using this look on a large scale, but using it without real depth as an artistic and narrative element. Choosing Teal and Orange over other infinite possibilities shows an industry more concerned with accelerated and standardized production processes than with real artistic and visual quality.

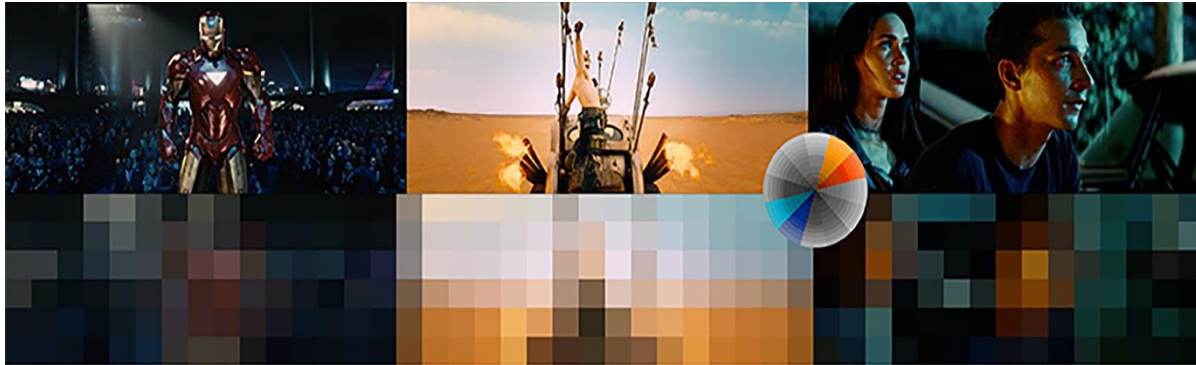

Figure 2: Some movies that uses Teal and Orange in Hollywood - Iron Man (Jon Fraveau, 2008); Mad Max - Fury Road (George Miller, 2015); Transformers (Michael Bay, 2007 -2018).

When the Teal and Orange visuals are used for artistic and narrative purposes, the possibilities expand in terms of understanding the stories and visual developments in the works, as we will see when analyzing the film Joker.

### The Teal and Orange in Joker

The proposal is to analyze the film Joker (2019) through the colors that the film has. By analyzing the images of the film in line with its narrative, we seek to understand the main subject of the film and how color can help us and amplify our understanding of it. Joker was directed by Todd Phillips and has Joaquin Phoenix as Arthur Fleck /Joker, Zazie Beetz as Sophie Dumond and Robert De Niro as Murray Franklin.

The film is about the story of Arthur Fleck, a man who suffers from neurological and psychological problems, he works as a clown and lives with his mother in a small apartment. He has contact with few people and knows Sophie, a neighbor, in whom he has a love interest. Fleck witnesses a harassment of a woman on the subway by three wealthy Wayne business owners and after being assaulted by them, Fleck shoots and kills the stalkers, triggering a series of protests against Gotham City's rich people. The film shows the processes that lead Fleck to psychiatric and psychotic disorders and his famous characterization as the Joker.

The association proposed in this article is to find in the clash between the film's Teal and Orange look with the character's own clashes towards his moral and social collapse. In this sense, we can see how the cyan blue appears in the film in moments of greatest vulnerability of the character and in which he is aware of his actions. Moments in which the character is humanized and also the saddest in the work, in which we perceive human fragility in a distorted society. The character struggles against this objective reality and almost always perishes in front of them.

This constant defeat against reality takes us to the second moment of the film's colors and the orange tones. These tones are usually associated with joy and warm moments, the place where the character paints himself as a clown, the laughing child in the bus, Fleck's mother, and the moments when he is on stage are illuminated with orange tones. However, throughout the film, we understand

the corruption of orange and its change of association towards the psychopathic side of the character. And it is interesting to note the counterpoint between being totally involved in cyan or orange in the stairwell scenes, in both the collapse is imminent, either towards the depression, sadness and impotence of the cyan, or towards the madness and psychopathy of the orange.

The path through which the character goes is unusual, his moral and social defeat does not occur in the final moments of the film, but throughout the work. We observe his constant loss of sense of reality and judgment and little by little, madness and psychopathy appear, the film brings this new association of orange, little by little, in detail. The scene where Fleck murders his own mom and then smiles in the sun, every scene where he dresses up completely as Joker and the above-described staircase scene are good examples.

However, there is a important scene in this corruption of the character in the film that generates a moral doubt in the viewer. We discovered at a certain point in the work that the moments with Sophie's character were nothing more than Fleck's hallucinations, and that in reality he never got to be with her in the scenes we saw. If Fleck was hallucinating in his encounters with Shopie, and his madness, as well as the female character, is represented by the shades of orange, did the main character ever meet the girl? And if so, did he kill her later? – Sophie's death is not shown to us, and that's the big question. Proposing this reflection to the viewer is an important point of the film.



Figure 3: Joker's scenes that increasingly changes from teal to orange during the storytelling.

We believe that the character, when subjected to all the problems and ills of society, is fully capable of the barbaric acts he performs at the end and the film brings plausible social arguments for his actions in the diegetic narrative. However, to believe this we must also believe that the character murdered Sophie in cold blood for no reason or logic, and the work's colors showed us this. Those who do not believe that the character murdered her understand the entire unfolding of the second half of the work as just the character's mental madness, hallucination, therefore. What the film wants to show us is that the association of orange is with the madness caused by social rot and is not associated with hallucinations per se. Sophie, as said, is usually represented in orange tones, the red in her dress, more than the usual symbolism of passion and love interest, is the beginning of the character's plunge into his madness, in his total insanity in the face of all ailments and society's chaos. Fleck quest for an unreal

love interest in a black woman is his attempt to get out of that society – get out of the cyan blue society -, his confrontation with the reality that it was all a hallucination sinking him into the worst and deepest sexism and racism issues of this society, represented exactly through the murder of the black woman and after that he sinks in the madness and psychopathic society – the orange one. The rotten and distorted structure of society is represented by the maddening of the main character and when we believe in his journey towards madness, we also attest to this rottenness.

## **CONCLUSION**

Even using an usual and largely commercial look, Joker conceives a deeply artistic, functional and narrative approach to the look and thus conveys important issues and debates to the work through the use of color. More than simply using the visual for a pure aesthetic effect or for approximation of objective reality, the film's colorist works seeking to unite all thematic proposal of the work through colors, making this film a great example of the use of this already well-worn look.

Therefore, we can conclude that the increasingly automatic characteristics of color correction processes should free the colorist for greater artistic possibilities in their work, instead we are seeing an increase in automated processes including these issues, with automatic looks being widely spread and used . Debating the use of color in cinematographic works and how to use them to create more appealing films in their visual and symbolic narratives is the real hard work that film colorists have to face.

## **REFERENCES**

- Couchot, E. 2003. Da representação à simulação. In: A. Parente, *Imagem-Máquina: a era das tecnologias do virtual*, 37-48. São Paulo: Editora 34.
- Dubois, P. 2004. *Cinema, vídeo, Godard*. São Paulo: Cosac Naify
- Hurkman, A. V. 2011. *Color Correction Handbook: Professional Techniques for Videos and Cinema*. Berkeley, California, EUA: Peachpit Press.
- Hurkman, A. V. 2014. *Color Correction Look Book: creative grading techniques for film and video*. Berkeley, Califórnia: Peachpit Press.
- Moura, E. 2016. *da Cor*. Santa Catarina: iPhoto Editora.
- Joker (2019). Film. Director: Todd Phillips. Production: Todd Phillips, Bradley Cooper, Emma Tillinger Koskoff. Cast: Joaquin Phoenix, Robert De Niro, Zazie Beetz, Bill Camp, Frances Conroy, Brett Cullen.

# Color in characters' identity in the animation cinema

Manuela Piscitelli <sup>1,\*</sup>

<sup>1</sup> Università degli Studi della Campania Luigi Vanvitelli; manuela.piscitelli@unicampania.it

\* Corresponding author: manuela.piscitelli@unicampania.it

## Abstract

This paper analyses the use of colour in Disney's animation films from three different and closely connected points of view: the first is the link between colour and the identity and psychological features of the characters; the second relates to the chromatic contrasts between the protagonist and his antagonist in the story; the third concerns the figure-background relationships, through the study of the colours of the environment in which the characters move. The first theme is developed by grouping characters with similar psychological characteristics taken from different films. The second and third themes are treated with reference to certain films considered emblematic.

**Keywords:** *Animation films, character's psychology, color symbolism, chromatic identity, chromatic contrasts*

## INTRODUCTION

"We look at a person and immediately a certain impression of his character forms itself in us." (Asch 1946: 258). This quotation from a well-known psychology essay on how we form a first impression of a person's character by looking at their external image, lends itself well to introducing the theme of the perception of the identity of characters in animated films. Through the lines of the drawing (gentle curves or, on the contrary, broken lines), the shapes that describe them (compositions of geometric shapes such as triangles, squares or circles) and the colour that describes them, characters communicate their identity even before the spectator witnesses the development of the story in which they are protagonists.

Since the late nineteenth century, advertising images and product packaging has been designed to guide visual pathways and attribute meanings. In his 1955 study on colour in human activities, Maurice Dérivé argues that colour influences the perception of objects, attracting or repelling, in each case acting as a psychological feature whose first impact is important. (Dérivé 1955).

The advent of colour in cinema has involved material, visual, narrative and affective fields, adding new meanings and modes of expression. Most characters in animated films are linked to a precise colour, and this choice is not accidental, but closely linked to the psychological characteristics they bear. In some cases, the chromatic identity goes even further, linking the choice to a consolidated literary or pictorial imagery associated with a colour, based on the consideration that children are not the only audience, and the same film may have different levels of meaning that will be received and appreciated by different groups of viewers. In 1935, Natalie Kalmus, executive head of the Technicolor art department, recommended that "In order to apply the laws of art properly in relation to color, we must first develop a color sense, in other words, we must become color conscious. We must study color harmony, the appropriateness of color to certain situations, the appeal of color to the emotions." (Kalmus 1935: 140).

## COLOUR IN DISNEY'S ANIMATION FILMS

Since the advent of colour in cinema, Disney has invested heavily in its use. In 1923, Disney established an ink and paint department where the colours were made and applied to the production of the films. (Thompson 2014a). The paint lab mixed the paints from formulas by chemists, using pigments of



animal, vegetable and mineral origin, to obtain several values of each colour, from dark to light. These values were used to mark the passage of a character from shadow to light (Schultheis 1938).

This was not the only use of the chromatic potentiality. "Disney's narrative use of Technicolor not only exceeded its traditional naturalistic functions as cues for depth, movement and three dimensionality, but also prompted an affective and sensual delight in color's abstraction, purity and movement." (Thompson 2014b).

### **Colour and character identity**

The first level of significance of colour in animated films concerns the definition of the psychological features of the characters. These qualities derive from pre-existing chromatic imagery, which the cinema has contributed to consolidate through re-presentation, and sometimes has modified. The symbolism of colour has in fact changed very slowly throughout the history of the nineteenth century, following a long-term logic (Pastoureau 1989). The basis of colour symbolism was for a long time Goethe's colour theory, which gave rise to an important trend of reflection on the psychophysiological effects of vision, arguing that colour had a moral action (Goethe 1810). On the warm arc of the colour circle, in correspondence with red and orange, we find the "choleric" temperament associated to the personalities of "tyrants, heroes and adventurers"; in correspondence with yellow and green, we find the "sanguine" temperament and its "hedonistic, lovers and poets" personalities. On the passive side of the circle, there are the "melancholic" temperament: purple is associated with "pedants, philosophers and rulers" personalities, and blue with "historians, speakers and teachers". Moreover, colour is associated with other characteristics, as the "intelligence" of green and yellow; the "sensuality" of blue; the "fantasy" of violet (Ivanovic 2018).

In addition to this chromatic symbology, there are many other significances from literature and painting, which over time have entrenched meanings linked to the colour of a character's clothing. One of the most emblematic examples is Madame Bovary's blue dress in Gustave Flaubert's novel (1856). Blue is recurrent in the descriptions of Emma's character, inspiring later portraiture in painting. The values conveyed by the colour are spirituality, nonconformity and class (Falcinelli 2017).

Disney's imagery absorbs many of these traditional references, as can be seen from the chromatic analysis of the film's protagonists. Many female characters are dressed in blue: Cinderella at the dance (*Cinderella*, 1950), Alice (*Alice in Wonderland*, 1951), Belle at the beginning of the film (*Beauty and the Beast*, 1991), Aurora when she falls asleep (*Sleeping Beauty*, 1959), Elsa (*Frozen*, 2013). The reference is to the sensuality of Goethe's blue, but also to the traditional values of Madame Bovary. Among the male characters, we find in blue the genie of the lamp (*Alladin*, 1992) and the Hercules' cloak (*Hercules*, 1997), where the colour indicates loyalty and mental strength. Green is also reserved for positive characters, expressing cunning and intelligence, but also youth, growth, freedom and love of nature. This is the case of Robin Hood and Little John (*Robin Hood*, 1973), Peter (*Peter Pan*, 1953), Ariel (*The Little Mermaid*, 1989) (Figure 1).

Red tones are mostly used for choleric characters according to Goethe's definition, almost always negative in opposition to the protagonists. Antagonists in red include the Queen of Hearts (*Alice in Wonderland*, 1951), Captain Hook (*Peter Pan*, 1953), Lady Tremaine (*Cinderella*, 1950), Gaston (*Beauty and the Beast*, 1991), all characters featuring strength, energy, anger, determination, in opposition to green or blue characters. A final chromatic category concerns the evillest characters, associated with shades of black and dark purple, such as the Evil Queen (*Snow White and the Seven Dwarfs*, 1937), Maleficent (*Sleeping Beauty*, 1959), Ursula (*The Little Mermaid*, 1989). Black expresses elegance and formality but also alludes to the devil and death, while purple is connected to nobility (many of these

characters are queens), but also to the desire for power, lust and ambition. Another famous Disney villain, Cruella de Vil (*One Hundred and One Dalmatians*, 1961), combines the elegance and evil of black with the anger and determination of red, as well as Jafar (*Alladin*, 1992) (Figure 2).



Figure 1: J.A.D. Ingres, portrait of the princess De Broglie, 1851-53. Disney positive characters in blue and green.



Figure 2: Goethe's colour circle, 1810. Disney villains in red, black, and purple.

### Chromatic contrasts protagonist / antagonist

The relationships between colours have been studied since the nineteenth century with the publication of the law of simultaneous contrast by the French chemist Chevreul, in which he demonstrated that two colours placed in contact influenced each other, reaching their maximum intensity in the presence of two complementary colours (Chevreul 1839). His text was widely used in the 19th century and was the reference for theories on colour contrasts, the best known being Itten's (Itten 1965). As in the case of the symbolism of colour discussed above, theories of contrasts constitute a cultural reference widely used first in painting, then in advertising graphics and finally in cinema with the advent of colour.

Looking at the Disney characters, we can see how the psychological opposition between protagonist and antagonist is in many cases accentuated by the chromatic contrast. This is particularly evident in the contrast between the complementary colours of red and green, which have opposite positions on the chromatic circle but emanate an equal degree of luminosity, so that in the juxtaposition they have a balance in which neither is prevalent. This type of contrast is found in various films, for example between Robin Hood and Little John in green and Prince John and the Sheriff in red,



between Peter Pan (and the crocodile) in green and Captain Hook in red. The contrast reinforces on a perceptive level the personality and narrative opposition, accentuating the sense of struggle between positive and negative characters. The perceptive balance between the two complementary colours corresponds to the narrative balance between the protagonist and the antagonist, whose clash appears equal (Figure 3).



Figure 3: Contrast between complementary colours red and green.

Less balanced from a perceptive point of view is the contrast between warm and cold colours that occurs in the juxtaposition of red and blue. In this case, red, a warm colour, advances into space and visually prevails over the cold hue of blue. This type of chromatic opposition emphasises the imbalance between pairs of characters in which the antagonist is, for a good part of the story, in a dominant position compared to the protagonist, who does not seem able to oppose his anger and arrogance. Examples in this sense are couples such as: The Queen of Hearts in red and Alice in blue; Gaston in red and Belle in blue; Lady Tremaine in red and Cinderella in blue (Figure 4).

Finally, the colour group of villains characterised by black and dark purple tones follows the contrast between light and dark, juxtaposing different values of brightness. This type of contrast is widely used in painting to give depth and drama to scenes by juxtaposing darkness and brightness. From a narrative point of view, the reference is to the opposition between evil and good, identified by shadow and light.

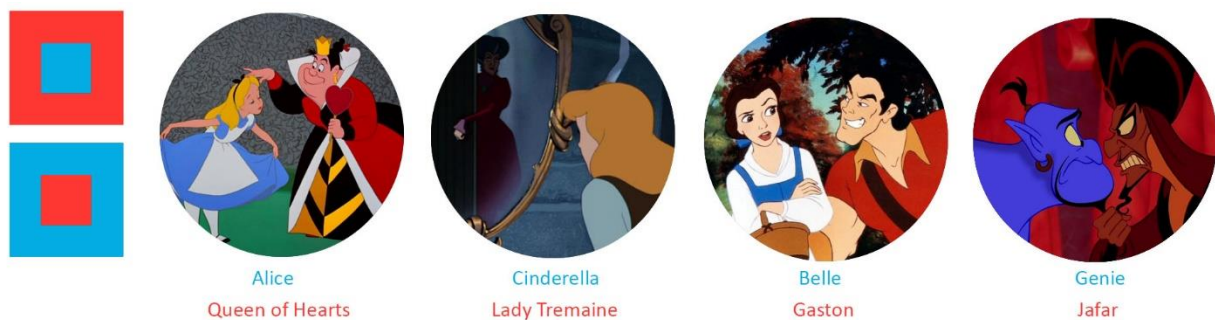

Figure 4: Contrast between warm and cold colours red and blue.

### Relationships figure / background

“When we receive the script for a new film, we carefully analyse each sequence and scene to ascertain what dominant mood or emotion is to be expressed. When this is decided, we plan to use the appropriate color or set of colors which will suggest that mood, thus actually fitting the color to the scene and augmenting its dramatic value” (Kalmus 1935: 145).

The palette of colours, in harmony or in contrast with the protagonists, contributes to the filmic narrative, accentuating the emotions expressed by the characters. The change of scenes corresponds

to chromatic changes that emphasise the narrative perceptually. When the hues of characters and scenes use similar colours, i.e., in adjacent positions on the chromatic circle, colour harmony induces a feeling of serenity in the viewer. Conversely, the use of complementary colours or strong chromatic contrasts between characters and background induces a feeling of tension and unease. The choice of colour palette is therefore designed to connect to symbols and induce specific emotions in the viewer. (Gegenfurtner and Sharpe 2000).

Returning to the example of Robin Hood, the background of the forest is in chromatic harmony with the protagonists, while in the scene of the castle fire, the dark colours of the sky and the reds of the fire, in contrast with Robin's green, accentuate the drama of the story and the feeling of danger (Figure 5).



Figure 5: Chromatic harmony and chromatic contrast between Robin Hood and the background.



Figure 6: Colour palette of the film *The Lion King* (1994).

From the point of view of the relationship between figure and background, the analysis of the colour palette of the film *The Lion King* (1994) is particularly interesting. The mood is naturalistic, both

in the representation of the animals and in the backgrounds, which realistically reproduce the colours of Africa where the narrative is set. For this reason, the main colours are limited to browns. However, colour is also used in the psychological definition of the characters, as in the case of the black mane of the evil Scar, and above all in the alternation of the tones of the backgrounds in the different moments of the narrative. The main palette of the film, based on brown tones, is flanked from time to time by other colours to suggest different atmospheres: the blue of the sky in the family scenes that express serenity; greens, expression of lightness and personal growth, in Simba's new life in the jungle; reds, green-yellow, purple and darker tones, evoking tension, in the dramatic scenes and fights, mostly involving the villain Scar (Figure 6).

## REFERENCES

- Asch, S. E. 1946. Forming impressions of personality. *The Journal of Abnormal and Social Psychology* 41(3): 258-290.
- Chevreul, M. E. 1839. *De la loi du contraste simultané des couleurs, et de l'assortiment des objets colorés, considéré d'après cette loi*. Paris: Pitois-Levrault et Cie.
- Déribéré, M. 1955. *La couleur dans les activités humaines*. Paris: Dunod.
- Falcinelli, R. 2017. *Cromorama*. Torino: Einaudi.
- Gegenfurtner, K., and L. Sharpe. 2000. *Color vision: From genes to perception*. Cambridge: Cambridge University Press.
- Goethe, J. W. 1810. *Zur Farbenlehre*. Tubinga. (It. Ed. *La teoria dei colori*. Milano: Il Saggiatore, 2014).
- Itten, J. 1965. *Arte del colore: esperienza soggettiva e conoscenza oggettiva come vie per l'arte*. Milano: Il saggiatore.
- Ivanovic, C. I. 2018. Symbolic Color Associations in Goethe's Farbenlehre and its application in the pictorial work of its early receptors. *Cultura e Scienza del Colore - Color Culture and Science Journal* 09: 65-73.
- Kalmus, N. 1935. Color Consciousness. *Journal of the Society of Motion Picture Engineers* August 1935: 139-147.
- Pastoureau, M. 1989. *Couleurs, images, symboles. Etudes d'histoire et d'anthropologie*. Paris: Le Léopard d'Or.
- Schultheis, H. 1938. *Notebooks 1938-1940*. Walt Disney Family Museum, Presidio, San Francisco, 1-82.
- Thompson, K. 2014a. Colourful material histories: The Disney paint formulae, the paint laboratory and the ink and paint department. *Animation practice, process & production* 4: 45-66.
- Thompson, K. 2014b. Quick Like a Bunny! The Ink and Paint Machine, Female Labor and Color Production. *Journal for Animation History and Theory* 9, February 2014.

# A Film in a Frame: Movie Barcodes for Film Restoration

Alice Plutino <sup>1,\*</sup>, Beatrice Sarti <sup>1</sup>, Gabriele Simone <sup>1</sup> and Alessandro Rizzi <sup>1</sup>

<sup>1</sup> MIPS Lab, Computer Science Department, Università degli Studi di Milano; alice.plutino@unimi.it; beatrice.sarti@unimi.it; gabriele.simone@di.unimi.it; alessandro.rizzi@unimi.it;

\* Corresponding author: alice.plutino@unimi.it

## Abstract

Today, color reproduction techniques are among the most studied and fascinating topic in cinema studies and film restoration. In this study, we propose the use of a tool called movie barcode in order to represent the chromatic variation of a whole film in a single image. The movie barcode is a graph where all the colors used in each film frame are extracted and represented in succession, allowing to synthesize in a single image the chromatic variations throughout the film.

The study and analysis of the movie barcodes allowed us to extract movies chromatic mood board and make comparisons among different videos. The potential of this method has been initially tested on animated films with simple color compositions and next on digitized analog films. This application let us to evaluate the effectiveness of movie barcodes to represent and study films of cultural and historical interest before and after the process of restoration.

**Keywords:** *Color in Film, Film Restoration, Color and Cinema*

## INTRODUCTION

Since its origins, color in cinema has been used to give emphasis and relevance to movie content, and today, there are many threads of research aiming at analyzing the use of color in cinema history (Mazzanti 2012), (Mazzanti 2018), and as means of expression (Wang, et al. 2010), (Wilms and Oberfeld 2018) (Cohen-Kalaf, et al. 2021).

In this context, movie barcodes are a widely used way to summarize and extract the main color used in a film. The movie barcode is a graph where all the colors used in each movie frame are extracted and represented in succession. Thus, this method allows to quickly obtain information on the colors and tones of an entire sequence of frames. Movie barcodes applied on movies can be easily found in the literature, e.g., Moviebarcode (Tumblr 2021) and The Colors of Motion (Clark 2018). Even though in the majority of the cases those applications are used for artistic purpose, there are many applications using the movie barcodes to extract colors and create color maps (Gray 2013), or to study the use of colors in films (Cohen-Kalaf, et al. 2021), (Chen, Faden e Ryan 2021). These applications have been found extremely useful in the process of animation films production, because movie barcodes are an easy system for communicating visual storytelling ideas before any actual animation is done, and in the process of color analysis and film studies, because movie barcodes offer a synthetic visualization of the colors in a video (Otto, et al. 2018).

In this work we propose the use of movie barcodes to study and analyze not only modern and contemporary movies, but also to compare video streams before and after the process of restoration. In fact, this approach could help the restorer in assessing how much the process of color correction affected the whole mood-board of the original film, but also to identify an eventual color cast. In fact in film restoration, due to the lack of original trustworthy references, the color correction is left in the hands of the restorer under the supervision of the restoration project curator (Enticknap 2013) (Plutino 2020). In this context, even though some tools have been developed to assess the overall quality of the final restoration, the restoration color assessment is almost always done subjectively (Barricelli, et al. 2020). As a consequence, the movie barcode could be a supplementary tool to support the work of



the restorer and to underline the color enhancements and modifications introduced during the process of restoration.

In this work, different approaches, and statistical methods to generate movie barcodes will be presented, and the applications on film restoration will be discussed.

**MOVIE BARCODES**

In order to obtain different movie barcodes for different purposes, many software or web applications create the barcode extracting the average color of each movie frame. Nevertheless, this approach could be limiting, because the average color of a frame is not always the most representative. In this Section, different statistical methods to extract the dominant colours from film frames have been analysed and compared in order to define the best method of movie barcode construction.

Considering the color distribution in an image as a statistical distribution of numbers, we computed for every RGB channel the mean, the median and the mode. In this way, we obtained three different results, synthetizing the color distribution in images (see Figures 1-2).

This representation could be useful to analyze and study different images, videos and old films because it allows at representing:



Figure 1: Example of computation of the mean, median and mode color in the image "Starfish".

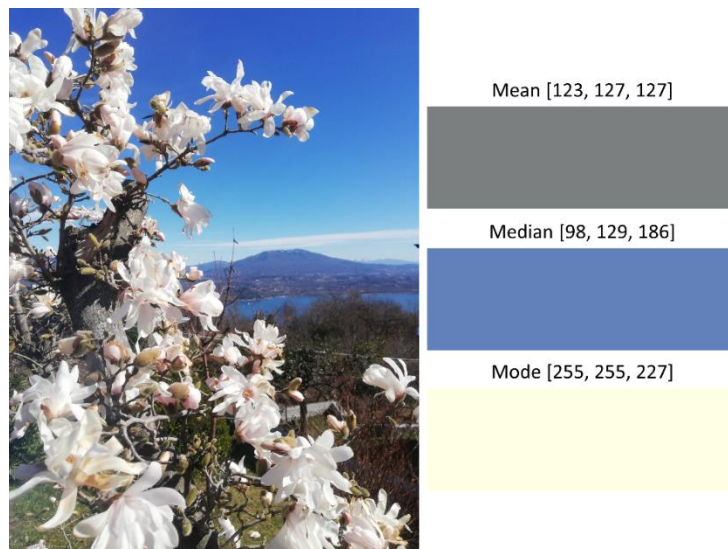

Figure 2: Example of computation of the mean, median and mode color in the image "Calogna".

The mean: the central value in the color distribution (i.e., the sum of all the values for every RGB channel divided by the number of pixels in the image).

The median: the middle value in the distribution (i.e., once ordered the pixel values in every RGB channel, the median value is the value in the middle of the distribution).

The mode: the most frequent value in the distribution (i.e., the value in every RGB channel which appears more often).

In order to apply this computation to video stream, once extracted the mean, median and mode for every frame in a video, we created a barcode where every column represents the mean, median or mode RGB value for every frame in the movie. An alternative approach to represent color distribution and analyze the chromatic content in films, has been presented in (Otto, et al. 2018), where the film frames have been posterized through a re-quantization process reducing the numbers of colors in every frame before performing the mean computation. Nevertheless, in this work we decided to exclude the posterization step, in order to include all the color content of the images in the computation and perform a more reliable analysis of the colors used in historical films.

## **FILM RESTORATION**

The movies analyzed in this study are from the MIPS Lab (Computer Science Department, Università degli Studi di Milano) dataset. Many of these films have been restored using innovative color enhancement algorithms, named Spatial Color Algorithms (SCAs) (Rizzi e Bonanomi 2017). This family of algorithms, derived from Retinex, allow at enhancing frames colors according to the pixel spatial distribution, thus enhancing the colors and simulating their original appearance (Rizzi, Bonanomi and Gadia 2016). This approach has been successfully applied in film restoration and in the literature is possible to find many publications about its application (Plutino, Lanaro, et al. 2019), (Plutino and Rizzi 2020), (Plutino and Rizzi 2020b). In **Error! Reference source not found.** are resumed the ID, the main features and the employed restoration algorithm of the videos analyzed using the movie barcodes:

<i>Video ID</i>	<i>Main Features</i>	<i>Restoration algorithm</i>
Calza	363 frames Year: 1961	Automatic Color Equalization (ACE) (Gatta, Rizzi and Marini 2002)
Fiat	888 frames Year: 1931	ACE Manual Color Correction with Da Vinci Resolve (Black Magic Design 2020)
Nuit	130'520 frames Year: 1982	Manual Color Correction with Da Vinci Resolve

Table 1: List of videos analyzed using movie barcodes.

The videos named “Calza” and “Fiat” are just short sequences of longer videos (“La lunga calza verde” and “Fiat 508”). The video named “Nuit” is the full movie “Toute Une Nuit”, by Chantal Ackermann, restored in collaboration with the Belgian Cinematek.

## **MOVIE BARCODES FOR FILM RESTORATION**

In Figure 3-5 are reported the results of the application of the movie barcodes on the movies presented in the previous Section. Here it is possible to see the difference among the mean, the median and the mode color and tones of the same film in original and after the restoration. In Figure

3, thanks to this representation it is possible to notice a strong red color cast around the frames from 80 to 90, where in this case is part of the video storytelling. In this video the strong pinkish dominant of the original film has been reduced after the color equalization and the strong pinkish shift evidenced in the mode barcode has been removed during the restoration.

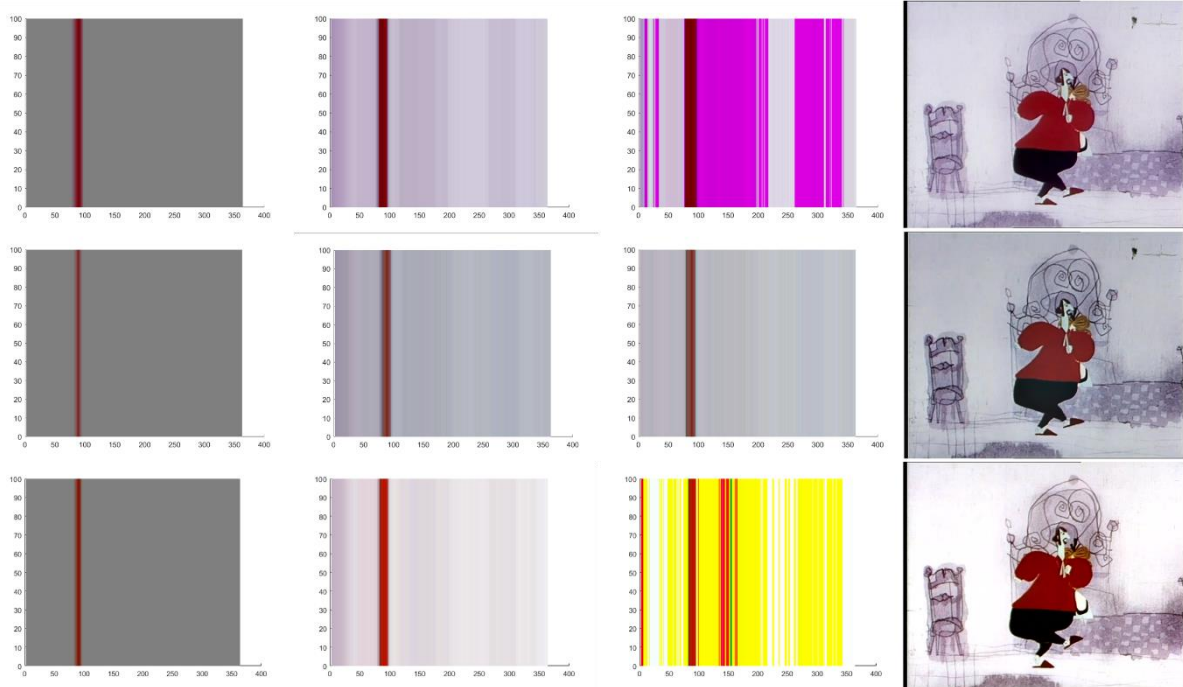

Figure 3: Barcodes of "Calza". From left to right it is reported the mean barcode, the median barcode, the mode barcode and a sample frame of the original and restored film.

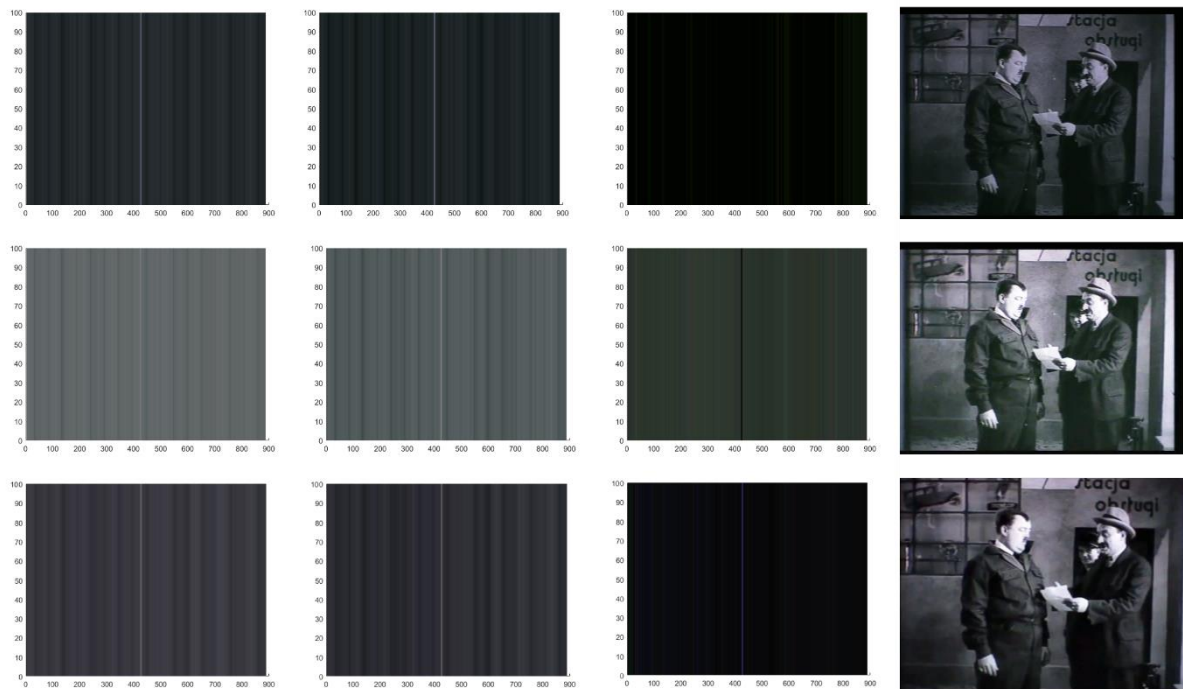

Figure 4: Barcodes of "Fiat". From left to right it is reported the mean barcode, the median barcode, the mode barcode and a sample frame. From top to bottom are reported the results of barcode application on the original film, on the film color correction through ACE algorithm and on the film restored manually.

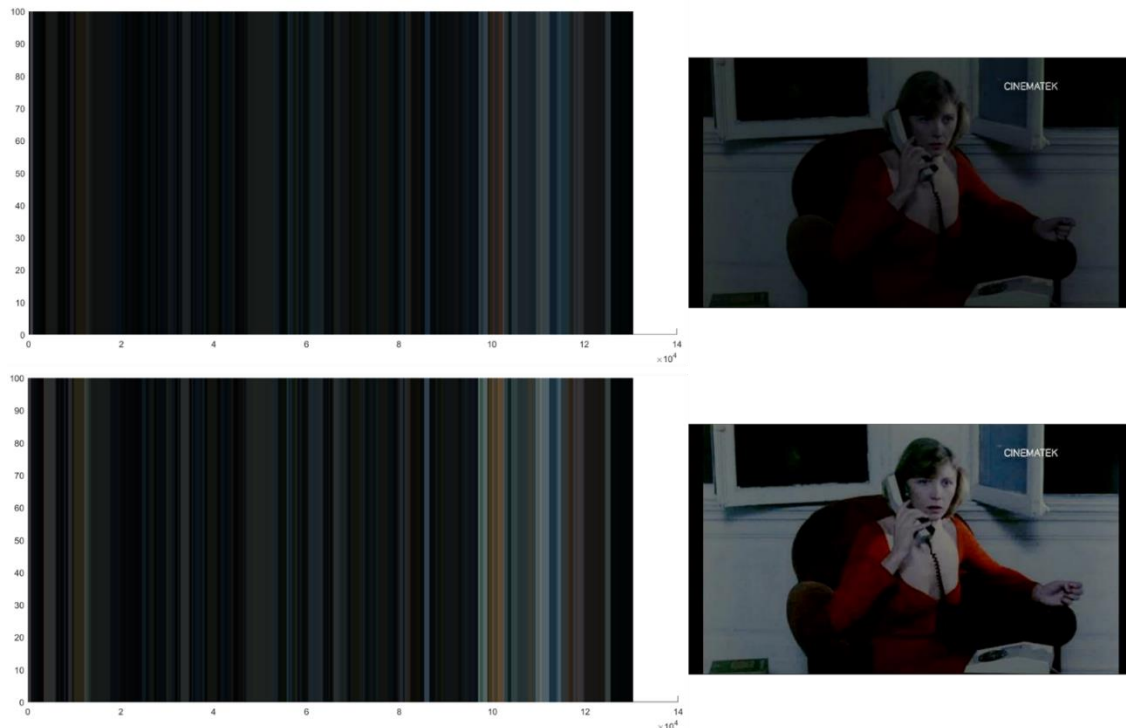

Figure 5: Barcodes of "Nuit". From left to right it is reported the mean barcode and a sample frame of the original and restored film.

In Figure 4, is presented an application of the movie barcodes on a black and white film. In this case the continuous shift among different shades of grey in the original mean and median barcode highlights a string flickering in the film, which has been reduced (not completely removed) after both the color corrections. Furthermore, the straight white line at the center of this sequence identifies a damaged frame in the video, which is totally oversaturated. In the restoration practice this possibility of detection could help the restorer in identifying strongly damaged frames to be substituted. In addition, the mode barcode is very useful to compare different restoration methods (see ACE and manual restoration), and to identify the brightness increase in the frames.

In conclusion, in Figure 5 is possible to see the application of the mean movie barcodes on a full movie. In this experiment, it is possible to see the color variance along with the whole film. Around frame 95'000 the increase in color brightness underlines the scene setting from night to daytime. The color correction produced an overall increase in color brightness, and the different scenes are more visible in the barcode.

## **CONCLUSION**

In this work we have presented the use and application of the movie barcodes on a set of two film sequences and on a full film which have been restored using different color correction algorithm.

This preliminary study has been useful to demonstrate the potential of the movie barcodes computed with different statistical methods in order to visualize not only the mean color of every frame in a video, but also the median color and the most frequent color. From the analysis of the results, we have proven that the movie barcode could be a supplementary tool to support the work of the restorer. In fact, this method allows to underline the color enhancements and modifications introduced during the restoration process.



**REFERENCES**

- Barricelli, B. R., E. Casiraghi, M. Lecca, A. Plutino, and A. Rizzi. 2020. A cockpit of multiple measures for assessing film restoration quality. *Pattern Recognition Letters*, Pattern Recognition and Artificial Intelligence Techniques for Cultural Heritage special issue.
- Black Magic Design. Da Vinci Resolve. 2020. <https://www.blackmagicdesign.com/it/products/davinciresolve/>.
- Chen, Y., E. Faden, and N. C. Ryan. 2021. KALMUS: tools for color analysis of films. *Journal of Open Source Software* 6( 61).
- Clark, C. *The Colors of Motion*. 2018. <https://www.thecolorsofmotion.com/about>.
- Cohen-Kalaf, M., J. Lanir, P. Bak, and O. Mokryn. 2021. Movie emotion map: an interactive tool for exploring movies according to their emotional signature. *Multimedia Tools and Applications* (Springer), 2021: 1-22.
- Enticknap, L. 2013. *Film Restoration - The Culture and Science of Audiovisual Heritage*. Palgrave McMillan.
- Gatta, C., A. Rizzi, e D. Marini. 2002. ACE: An automatic color equalization algorithm. *Conference on colour in graphics, imaging, and vision 2002*: 316-320.
- Gray, T. *A Visit to Disney's Magic Kingdom*. 2013. <https://blog.wolfram.com/2013/08/13/a-visit-to-disneys-magic-kingdom/>.
- Mazzanti, N. 2018. A FILM IS A FILM IS A FILM... IS IT NOT? or: a few thoughts on the materiality of film. In *Oberflächen und Interfaces* 221- 236. Wilhelm Fink.
- . 2012. *Chromatic Cinema: a history of screen colour*. Taylor & Francis.
- Otto, I., A. Plutino, M. Lanaro, and A. Rizzi. 2018. All the Colours of a Film: a study on the Chromatic Variation of Movies. *AIC Colours and Human Comfort*, Lisboa (Portugal), 29-29 September 2018, ISSN: 2617-2410.
- Plutino, A. 2020. *Tecniche di Restauro Cinematografico – Metodi e Pratiche tra Analogico e Digitale*. Roma: Dino Audino.
- Plutino, A., and A. Rizzi. 2020. Alternative Methods for Digital Contrast Restoration. In *Imagine Math* 7: 73- 87. Springer.
- Plutino, A., and A. Rizzi. 2020. Research directions in color movie restoration. *Coloration technology* (Wiley).
- Plutino, A., M. P. Lanaro, S. Liberini, and A. Rizzi. 2019. Work memories in Super 8: Searching a frame quality metric for movie restoration. *Journal of Cultural Heritage*.
- Rizzi, A., Berolo, A. J., C. Bonanomi, and D. Gadia. 2016. Unsupervised digital movie restoration with spatial models of color. *Multimedia Tools and Applications* (Springer) 7(75).
- Rizzi, A., and C. Bonanomi. 2017. Milano Retinex family. *Journal of Electronic Imaging* (International Society for Optics and Photonics) 26(3).
- Tumblr. moviebarcode. 2021. <https://moviebarcode.tumblr.com/>.
- Wang, J., B. Li, W. Hu, and O. Wu. 2010. Horror movie scene recognition based on emotional perception. 2010 *IEEE International Conference on Image Processing (IEEE)*, 2010: 1489-1492.
- Wilms, L., and D. Oberfeld. 2018. Color and emotion: effects of hue, saturation, and brightness. *Psychological research* (Springer) 82(5): 896-914.

# The Lilac Scarf – Color as a visual narrative as depicted in the film *Far From Heaven* (2002)

Mark Wentworth<sup>1</sup>, Orly Morgenstern<sup>2</sup>, Tania Fuentes<sup>2</sup>, Carolina Gutierrez<sup>2</sup> and Evelyn L. Rivera<sup>2</sup>

<sup>1</sup> Colour for Life, UK; mark@colourforlife.com

<sup>2</sup> Tecnológico de Monterrey ITESM - CSF, México; a01028101@itesm.mx; [tania.fuentes@tec.mx](mailto:tania.fuentes@tec.mx); a01022323@itesm.mx; a01422567@itesm.mx

\* Corresponding author: tania.fuentes@tec.mx

## Abstract

This paper aims to analyze the development and construction of a parallel storytelling line by the use of color in the movie *Far From Heaven*, directed by Todd Haynes. We will focus on the lilac scarf worn by the main character, Cathy Whitaker (Julianne Moore), throughout the film.

*Far From Heaven* is a popular film from 2002 that embraces race issues, homosexuality, marriage, and society's stereotypes in Connecticut during the 1950's; it was nominated to a series of awards, including Best Cinematography at the 75th Academy Awards and won several others, such as Best Film at that year's New York Film Critics Circle Awards.

**Keywords:** color, lilac, *Far From Heaven*, film, visual-narrative

## INTRODUCTION

Cathy Whitaker, an American housewife during the 50's seems to have an idyllic life, until she discovers her husband is having an affair with another man. At her request, he goes to conversion therapy to no avail, eventually leaving her. At the same time, she starts a friendship with her gardener, a black man with whom she finds comfort. Feelings start blossoming between the two, but the time's prejudices are too strong. They are forced to separate before their love even begins.

*Far From Heaven*, directed by Todd Haynes, is a movie in which color is the parallel narrator of its storyline; the color palette focuses on silent but saturated colors that embrace each scene in a colorful and coherent environment. Color temperature, saturation, tone and contrast are carefully planned and executed throughout the 108 minutes of the film. Everything, excluding Cathy's lilac scarf, matches in color. The scarf's interaction with the characters reinforces the message of conflict and carries the viewer into an interpretable storyline.

To understand the importance of lilac in the visual narrative of the movie, we must first approach the historical and social context at the time in Connecticut. Even though the racial barrier was outlawed from the Constitution of Connecticut since 1876, throughout the decades of the 1900's, racial discrimination prevailed as a social issue in the United States. The state of Connecticut was no exception, and social uprising against racial inequality did not start until the 1960's with the civil rights movement. Analyzing the film, we observe these social tensions, prejudice and discrimination as its main theme.

## THE SCARF

Lilac is often associated with elements of fantasy and dreaming of other possibilities beyond the current ones. In some cases, it is referred to as a "light purple", its links to purple might lead us to consider it as a daring color and one that is not afraid to go against the norm. Yet, paradoxically, it is a friendly and warm empathic color that communicates a consideration for the needs of others before their own. With such diametrical opposites, lilac has the potential to create a strong inner emotional tension which can lead to a sudden loss of emotional control, or what might be referred as a total

breakdown of logic and common sense. The pull of the seemingly irrational and going against the odds, somehow in the lilac realms of daydreams, for a period of time anyhow, seem not so impossible.



Image 1: Frame from *Far From Heaven*, 2002 [Todd Haynes].

By the 18th minute of *Far From Heaven*, the storyline has been set and the characters introduced. As Cathy (Julianne Moore), the main character, stands outside with her friends listening to one of them, Eleanor, as she reads from a society circular we are introduced for the first time to the lilac scarf. It seems impossible not to see it because, aside from Cathy wearing it around her neck, the color is different from all the others in the frame and doesn't blend with the autumnal colors used elsewhere. As Eleanor Fine (Patricia Clarkson) reads aloud the words "kind to negroes" (while talking about Cathy), Cathy touches the scarf which in part covers her heart, which makes us wonder if this the first subtle hint about what is about to happen to her.

An important parenthesis would be whether the use of the lilac scarf is an acknowledgement and subtle shout out to the "lavender marriages" of the time, which were seen as marriages of convenience and an outer conformity for gay men and lesbian women. Such marriages were often arranged by agents and the studios for the Hollywood film stars of the time.

By minute 19:00, the scarf is blown away by a sudden gust of wind and is blown up and over the house, to which Cathy says "Oh, I love that scarf".

If the scarf being blown away is hinting towards Cathy herself not being averse to being "swept up into the realms of fantasy and dreamy possibilities", it is in its action and initial placement around Cathy's neck and chest/heart area that it might be coming into its own as the lead visual narrator; besides its contrast with the surrounding color scheme built on warmer colors.

Having said goodbye to her friends after a meeting with girlfriends, Cathy walks back towards the house, touches her heart and remembers the scarf almost as a symbol of an awareness of the times. That little sign conducts us to ask if these particular moments she is living in are some which perfection and appearances have more importance than matters of the heart.

The following camera movement shows us her subsequent wandering from the front, round to the back of the house. With walls separating outer from inner space, we are given a glimpse into the

The Lilac Scarf – Color as a visual narrative as depicted in the film *Far From Heaven* (2002) journey from outer acceptable world round to the unspoken back of the house: perhaps a mini heroine’s journey, or the start of which we’re about to watch.



Image 2: Frame from *Far From Heaven*, 2002 [Todd Haynes].

At minute 20:39 Cathy finds her missing lilac scarf resting in the hand of Raymond Deagan (Dennis Haysbert), an African American gardener working in her garden. He says to a slightly surprised Cathy: “I had a feeling it might be yours... the color... it just seemed right”. His words and the close shot of him holding the scarf hint to us the beginning of Cathy’s fantasy life.

### **LILAC EVERYWHERE**



Image 3: Frame from *Far From Heaven*, 2002 [Todd Haynes].

Later in the story, Cathy meets her husband, Frank Whitaker (Dennis Quaid) outside the psychiatrist’s office building, he’s seeing the doctor in regards to his latent homosexuality.

Waiting Cathy wears a lilac-lavender-blue outfit, hinting at her now unravelling “lavender marriage”. The building behind her lies in shadow and as something catches her eye, sunlight lights up the once dark building and her face as we now follow her gaze to see a young couple kissing on a park bench. The lilac hat and lavender blue jacket begin to reinforce her escape into a fantasy life; also mirroring her with the girl on the bench through their clothing: as one lives a reality the other one wishes to have.

Almost by the hour of the movie, whilst not the lilac scarf, a deeper shade of the color has now transferred to a much more solid piece of clothing, a cardigan worn by Cathy in a meeting with her friend Eleanor. In this scene the appearance of Cathy and Frank’s marriage collapses as Eleanor sees a trace of physical violence in Cathy’s forehead. The illusion of the perfect couple starts to fall apart for the external physical bruise above her eye. Back to Cathy’s cardigan, the lilac continues to complement its meaning in the film as a color that represents the keeping of appearances.

Afterwards, once more we see Cathy walking from her house and encountering a now more than familiar Raymond Deacon. He is dressed in varying shades of autumnal colors, suggesting someone in harmony with their surroundings and themselves. Raymond invites Cathy to join him to “take her mind off things”. The cardigan now beholden to the color narrative is much more solid and with Raymond’s invitation to join him the color is now grounding the fantasy.

### **THE ILLUSION**

At first, she refuses his offer and then with a turn of events she walks out to his truck not only wearing the deeper lilac cardigan but also for the first time since Raymond handed it back, she carries her lilac scarf over her arm. To this moment we might suggest that both shades and tones are saying “here I am, rescue me into this fantasy other life”. Their agenda follows through the afternoon allowing Cathy to escape her mundane routine and scenery in exchange of a daring experience with Raymond, who takes her to dinner and dance after exploring unseen places.

The lilac color continues to appear during different stages of Cathy and Raymond’s interaction, which uncover more of the color’s meaning, such as following roads less travelled and imaginary exchanging social roles. The lilacs now in full swing of fantasy and illusion, find the characters in controversial social situations towards each other.

As the following scenes fade into one another we see a Cathy fully dressed in a blue lilac dress, the fantasy now completely embodied as she places the flowering witch hazel in pride of place for all to see more fully in the light. The separate pieces of lilac from scarf to cardigan to coat and to one full piece dress would lead us to surmise that this is the coming together of Cathy’s ever more deepening escape into a fantasy world, slowly she is becoming more detached from the reality of truth. And little by little segregates herself from the rest that surrounds her, this is visible through the contrast of her clothing compared to every other character, main or supporting. For example, in the cancelled dance recital scene in which Cathy’s daughter was about to perform, every other mom was wearing harmonising outfits with the predominating color scheme of the frame, everybody but Cathy, still in her blue-lilac clothing.

It comes a moment when Cathy tells Eleanor about everything that has been happening regarding her and Raymond; as she does so, she walks across to the window, the curtains have lines of lilac running down them caused by the light shining through them, she recounts some of their story mentioning how Raymond “just made me feel [...] alive somewhere”. As she speaks of him, her look tells us she is once more under the spell of lilacs fantasy and a desire to be different.



Slowly, the color story is revealed to us, colors develop personality and embody roles within the represented society. Cathy's colors of choice affect her compromise to society as she gradually changes and questions her true identity and wishes. The daring to be different, or even the hope to be different as shown by her coat and dress always comes at a cost regarding society.

## **CONCLUSION**

In the final moments of the film we see Cathy on her way to the train station after a second guessing on pursuing a different ending of her story with Raymond, who decided to move away from town after being seen with a white woman all over the city. Cathy, naively, drives to have a final look and hopefully say some final words to Raymond that might make them change their minds regarding their relationship.



Image 4: Frame from *Far From Heaven*, 2002 [Todd Haynes].

Just before, as we see her in the same color dress as the first scene of the movie, Cathy finds the lilac scarf in her pocket and wraps it around her head. She is tangled in a contrast of orange and red with lilac purple. The scarf comes back to frame, pointing to us that the hero's journey has come to an end. It started with its arrival, now finishes with its reencounter; lilac prevails as Cathy's color and mirror of fantasies.

The lilac scarf, for the first time, is now tied firmly and tightly around her head and neck. Thus, symbolising that fantasy and illusions are best left to daydreams and private imaginings rather than being played or lived out in real life. Meanwhile, Cathy's groundedness is personified by the shades of red in her outfit, hair and makeup. Her body is wearing red, and her head is wrapped in lilac, a contradiction by itself but a reassurance that her way of life goes two ways that do not intersect. The mundane, small life of expectation and conforming is now calling louder than the other life offered by the lilac scarf.

In *Far From Heaven*, the lilac scarf and the use of lilac in varying tones and shades help us understand and relate to the unspoken emotions that run deep within and throughout our brief encounter as an audience with Cathleen Whitaker. Beyond proving itself aware of the audience's needs, color as a visual narrative, and even its own character, completes the atmosphere and key symbols for this movie.

### **ACKNOWLEDGEMENTS**

This paper features materials protected by the Fair Use guidelines of Section 107 of the Copyright Act. All rights reserved to the copyright owners.

### **REFERENCES**

- DePeyster, S. 2019. The great migration in Hartford. *Scholars Collaborative*.  
<https://scholarscollaborative.org/Hartford/social-issues/the-great-migration-in-hartford/>.  
Accessed on: August 24<sup>th</sup>, 2021.
- Haynes, T. (director). 2002. *Far from Heaven*. Focus Features.

# PIXAR's Colorscripts: Chromatic Analyses of Four Films Using Sens|Org|Int Model

Paula Csillag <sup>1,\*</sup> and Amanda Sabião <sup>2</sup>

<sup>1</sup> ESPM College and Associação ProCor do Brasil; pcsillag@espm.br

<sup>2</sup> ESPM College; amandasabao@hotmail.com

\* Corresponding author: pcsillag@espm.br

## Abstract

The objective of this study is to make chromatic analyses of the colorscripts of four Pixar films using Sens|Org|Int model. These analyses are intended to understand the use of color and their communicative intentions, as well as discuss communicative relationships between emotion and plot through the use of colors, identifying which aspects of chromatic perception are objective (physiological) and which aspects of chromatic perception are subjective or interpretive. The empirical research was conducted creating first an instrument of analyses for the colorscripts, based on the theoretical review. Results of the analyses indicate not only that Pixar uses color very coherently and effectively in terms of physiological visual perception, but also show which color uses and contrasts are mostly used and with which communication intentions. Also, the analyses convey a broad scope of color associations in films that could be useful for future chromatic projects.

**Keywords:** *colorscripts, emotional associations to color, animation, cinema, color communication*

## INTRODUCTION

The concept of colorscript (Figure 1) is a filming tool used in the production of some movies, mainly in animations. It allows us to see the full emotional mood that color brings to a film in a single glance, by arranging scenes side by side in a single plate. This process aims to plan and refine the visual and emotional rhythm of a film, so that it supports its story (Amidi 2011).

According to Amidi (2011), the term colorscript was only recently adopted due to the great amplification, mainly by PIXAR, of its role in the film creation processes. There is some ambiguity about what constitutes a colorscript or at what stage in pre-production it should be done, there are several versions of the process, just as there are several artists to create them.

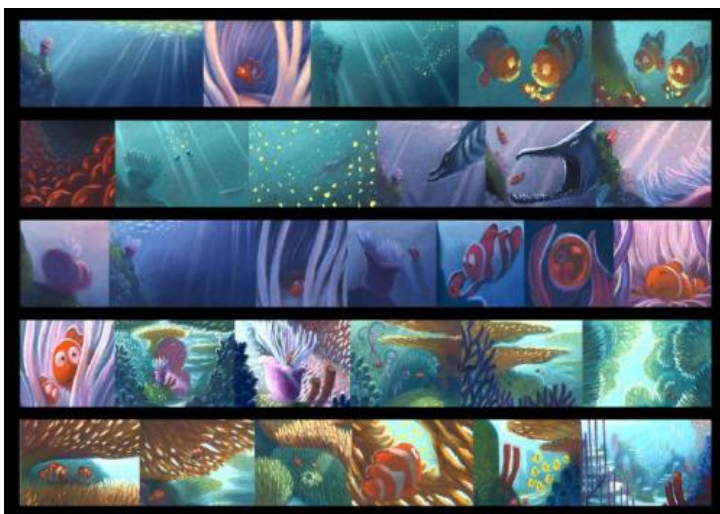

Figure 1: Colorscript of the film "Finding Nemo". Source: The art of Finding Nemo (2003).



In this research, the objective was to analyze the associations of colors and emotions present in animation colorscripts, mapping objective (physiological) and subjective (interpretative) factors used for these associations.

## ***COLOR IN CINEMA***

To review the origin of color in cinema, the following authors were used: Barbosa (2007); Misek (2010); Costa (2005); Neale (1985); Reis (2016); Bordwell et al. (1985); Sagen (2015); Braga and Costa (2000) and Hércules (2012), referring to the painting methods used, companies that stood out and the importance of color in narratives. The methods used include the non-photographic ones — hand painting, stencils, dyes, turnings and the Handschiegl process — and the photographic ones — Kinemacolor, Kinekrom, GaumontChronochrome, Cinecolorgraph, Kodachrome, Prizmacolor, Lumicolor, Dufaycolor, Gasparcolor and Technicolor.

### **Colorsript**

This topic addresses the origin of the color-to-emotion mapping method used today by PIXAR's animated films. Its origins date back more than seventy years, and its first versions began as soon as color made its presence felt in the cinematographic world. According to Amidi (2011), in the mid-1930s, an initial colorsript process was created and employed in Hollywood live-action films by Natalie Kalmus, supervisor of Technicolor's color control department. Soon, the concept of colorsript came to Disney animated films in the 40s.

The idea of presenting the colors of an entire animated film, in a single piece of art, as they are done today, didn't fully materialize until the films made by United Productions of America, founded in the 1940s. Inspired in Disney's processes and with a team of artists who had already worked there, the UPA created "continuous color sketches" for their films in the mid-40s (Amidi 2011). The modern resurgence of colorsript was brought on by Disney, more specifically, by artist Richard Vander Wende who painted scenes from the entire Aladdin movie (Amidi 2011). According to Amidi (2011), the term colorsript was only recently adopted due to the great amplification, mainly by PIXAR, of its role in the film creation processes.

## ***SENS|ORG|INT MODEL***

Sens|Org|Int Model (Csillag 2013, 2015) differentiates three processes that occur in human perception: sensory impressions, organizing processes, and interpretive processes of visual perception. The model was devised in an attempt to differentiate which principles of design tend to be common to all human beings with normal eyesight from the concepts that don't. Those that are not common therefore are learned or otherwise acquired. Therefore, this model unites the synthetic approach (Hering 1964 (1878), Gibson 1979), and the analytical approaches (Berkeley 1709; Helmholtz 1925; Bruce et al. 2003), neuroscientific explanations (Chalupa and Werner 2004; Knoblauch and Shevell 2004; Pinna and Spillman 2001; Shimojo et al. 2001; Spillman and Levine 1971; Zeki 2000) on how the brain works, and relates them to design principles. With this framework, we are then able to tell, from the classical design "laws," which ones can truly be considered a principle that tend to be valid for all human beings from those that don't.

Sens variable (sensory impressions) is related to the sensory information received through the pupil in our visual sensory organ. This aspect of perception is a phenomenon that occurs in the eye only, still in the form of light, before it becomes neural signs in the retina.

Org variable (organizing processes) is related to organizing aspects of perception that occur starting in the retina, including what is considered the primary visual cortex, mostly in area V1 of the striate cortex. Org is related to the bottom-up approaches of visual perception in psychology. The phenomena of perception that occur as Org are what tend to be considered as principles of design.

Int variable (interpretive processes) refers to the elaboration of Org in the extrastriate visual cortex, including approximately areas V2, V3, V4 and V5 of the brain, and moving on to other areas of the brain. This variable refers to the top-down approaches to visual perception in psychology. It is in this moment of perception, that neural cascades occur, which undergo the interference of motivation, emotion, personality, culture, knowledge, etc. This aspect of perception causes variation and interpretation in design and in the proposed model, is called interpretive processes.

### **METHODOLOGY AND EMPIRICAL RESEARCH**

The empirical research consisted primarily on the analyses of colorscripts, based on SENS|ORG|INT model. Thus, four PIXAR films were selected: *Finding Nemo*, *UP*, *Cars* and *Wall-e*. These were specifically selected as they represent some of the studio's early films and feature a wide variety of color usage. Following SENS|ORG|INT model, each colorscript was analyzed, in terms of objective percepts (ORG) and subjective percepts (INT). Due to space limitations, in this paper, only one example is illustrated below.

Figure 2 shows a colorscript of the film *Finding Nemo*. In this scene, the colorscript indicates the moment when the character Marlin finds the only survivor egg after a shark attack to his nest full of eggs.



Figure 2: Colorscript of the film "Finding Nemo". Source: The art of Finding Nemo (2003).

Figure 3 features the same scene in the actual movie. Both the indications of colors in the colorscript and the actual colors used in the film feature a very important characteristic, observed using SENS|ORG|INT model. In terms of ORG variable (objective percepts), it is noted that the contrast of the egg color and its surroundings is a contrast that indicate a more saturated and thus brighter orange for the egg. And Marlin, when holding the egg on his fin (Figure 4), is featured with a desaturated orange (mixed with grey), indicating an orange with less brightness. Analyzing these scenes in terms of INT variable, it is noted that the usage of a desaturated orange for the father is associated with his stressful feeling at this moment, and the saturated orange used in the egg is associated with brightness, life and hope.



Figure 3: Scene of the film "Finding Nemo". Source: Finding Nemo (2011).

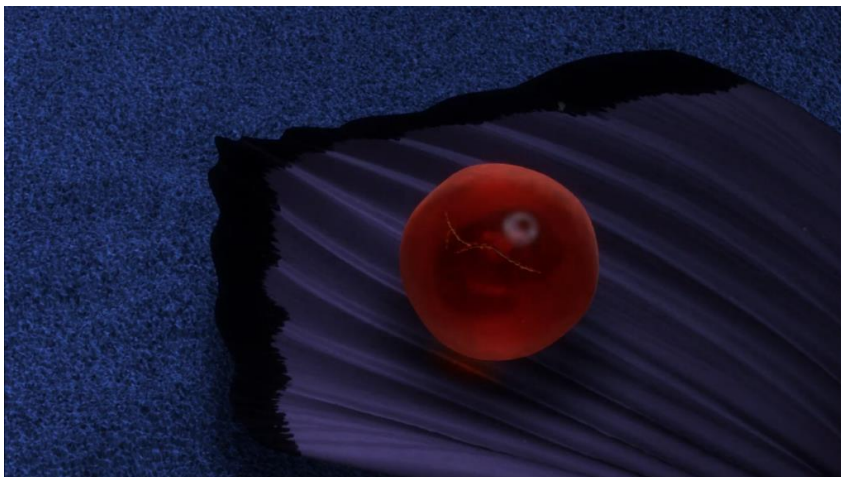

Figure 4: Scene of the film "Finding Nemo". Source: Finding Nemo (2011).

### **RESULTS AND FINAL CONSIDERATIONS**

Through the analysis made in the colorscripts of some PIXAR films, it was possible to draw conclusions about their uses of color. First, in a general context, there is a very precise use of both objective and subjective factors in PIXAR cinematographic works. The studio knows and uses its knowledge in order to always add meaning to its productions from the initial stage (colorscript) to the film.

In the analyses, in relation to objective factors (ORG variable), it was possible to observe a greater use of communication of spatiality through hot and cold or light and dark contrast. Then comes the communication of smoothness through contrasting pastels and saturation. Both stimulation and calm communication through hot and cold contrast and high vibration communication through complementarity contrast were equally used. Next, there is the communication of vibration through contrast of pure hues, and finally there is the communication of chromatic mutation through simultaneous contrast.

The greater occurrence of objective spatiality communication factors is due to the fact that the studio prioritizes, for the most part, highlights of the character or object in relation to its background or vice versa to attract the attention of the audience. In *Finding Nemo*, it is possible to observe a constant use of communication to highlight the fish in relation to the bottom. In the other films,

however, there is a rotation, some scenes prioritize the characters while others, the setting. This power of choice between what should attract the most attention shows that PIXAR knows what it's doing and explores what best contributes to the understanding of its scene.

There is also a higher occurrence of smoothness communication through saturation contrast than through pastel tones. This choice shows a preference of the studio to bring softness, but also to create focuses of attention, which occurs in the saturation contrast, since in places where pure hue was used, these focuses are created. In the analysis of the film *Wall-e*, there was a choice to predominantly use the saturation contrast, while in the other productions the two cases happened - saturation contrast and pastel tones -, again showing that the studio has the knowledge to recognize which case is ideal for each type of communication.

In the communication of stimulation and calm, it is possible to observe that in the films *Nemo* and *Wall-e* the intention of calm is very present due to the existence of cooler tones in the analyzed scenes. In the films *Cars* and *UP – Altas Aventuras* there was a greater balance, in some cases there is a communication of calm through the contrast between cool colors and in others communication of stimulation through the contrast between warm colors. This choice is mainly in line with the intention that the studio wants to convey at a certain point in the film.

The communication of chromatic mutation occurred once, in *Cars*, and is a little more complex as it requires the artist who creates the colorscripts to have knowledge of the change in the color of an image due to the color used in the neighboring image. This factor was very well explored in the film, with sunlight interfering with the color of the truck's shadow.

High vibration communication through complementarity contrast occurs in all analyzed films, as well as vibration communication through pure hue contrast. Vibration plays an important role in animations as it attracts the eye and generates vibration and dynamism, suitable for a child audience. As for the subjective factors, it is observed that, based on the authors analyzed, PIXAR knew how to use colors well in the context of communication, allowing interpretations that enrich its plots. Subjective communication was widely used to confirm, mainly, the feelings of the characters in the scenes, which occurs in all the investigated films, in addition to also giving evidence of personality, which was again used in all productions. The subjective factors of colors were also used to accompany decision-making, as analyzed in the scenes of *UP – High Adventures* and *Cars*, in moments when the colorscript color is aligned with a certain decision that determines the direction of the film.

Finally, subjective communication (INT) is applied to reaffirm the role of a place or a character, as it happens in *Nemo*, *Carros* and *Wall-e*, in moments such as when there is a feeling of danger with jellyfish (*Nemo* movie), the trophy that must be overshadowed (*Movie Cars*) and the planet Earth that must represent neglect (film *Wall-e*). These and more examples show how subjective communication has been very well studied and constructed to allow a wide variety of emotions to enrich the film's plots.

The analyses carried out on the objective (ORG) and subjective (INT) factors only show how PIXAR masters the language of colors and methodically uses them to enhance its characters and stories with emotions, creating layers of interpretations and perceptions for its films.

In addition to mastering the objective factors, they also explore the subjective part of color well by contextualizing it in colorscript and film scenes in a way that enhances the communication of the story. It is hoped with this research that these studies and analyses can contribute to those interested in the area of film and animation production or even to other trainings such as design, serving as a guide for a conscious and expressive use of color.

**REFERENCES**

- Amidi, A. 2011. *The Art of PIXAR: The Complete Colorscripts and Select Art from 25 Years of Animation*. San Francisco: Chronicle Books.
- Barbosa, P. 2007. *A Primeira Cor No Cinema: Tecnologia E Estética Do Filme Colorido Até 1935*. Belo Horizonte: Escola de Belas Artes da UFMG.
- Berkeley, G. 1709. *Berkeley selections*. New York: Scribner's.
- Bordwell, D., Staiger, J., and K. Thompson. 1985. *The Classical Hollywood Cinema: Film Style & Mode of Production to 1960*. London: Routledge.
- Braga, M. H. and V. Costa. 2011. *Color in films: a critical overview*. Palhoça: Crítica Cultural.
- Bruce, V., Green, P., and M. Georgeson. 2003. *Visual perception*. Hove: Psychology Press.
- Costa, F. 2005. *O primeiro cinema: Espetáculo, narração, domesticação*. Rio de Janeiro: Azougue Editorial.
- Chalupa, L., and J. Werner (Eds.). 2004. *The visual neurosciences*. Cambridge: MIT Press.
- Csillag, P. 2021. *Comunicação com cores: uma abordagem científica pela percepção visual*. São Paulo: SENAI-SP Editora, 2015. E-book ASIN: B08SW4JFBC
- Csillag, P. 2013. Um mapeamento de estudos de cores frente ao Modelo SENS|ORG|INT de percepção visual de modo a identificar princípios cromáticos que tendem a ser generalizáveis aos seres humanos. *INFODESIGN (SBDI. ONLINE)*, 8: 39-47. <https://doi.org/10.51358/id.v8i2.127>
- Gibson, J. 1979. *The ecological approach to visual perception*. Boston: Houghton-Mifflin.
- Helmoltz, H. 1925. *Treatise on physiological optics: The perceptions of vision*. Optical society of America: Ithaca.
- Hércules, L. 2012. *A cor na análise fílmica: um olhar sobre o moderno cinema francês*. São Paulo: Revista Comunicación, 10(1).
- Hering, E. 1964 (1878). *An Outline of a Theory of the Light Sense*. Cambridge: Harvard University Press.
- Knoblauch, K., and S. Shevell. 2004. Color appearance. In: Chalupa, L. and J. Werner (Eds.). *The visual neurosciences*. Cambridge: MIT Press.
- Misek, R. 2010. *Chromatic Cinema: A history of screen color*. New Jersey: John Wiley & Sons Ltd.
- Neale, S. 1985. *Cinema and Technology: Image, Sound, Colour*. London: Macmillan.
- Pinna, B., and L. Spillman. 2001. Surface Color From Boundaries: a new watercolor illusion. *Vision Research* 41: 2669-2676.
- Reis, D. 2016. *A Influência Das Cores Nas Narrativas Cinematográficas: Análise Cromática Dos Filmes Kill Bill Vol. I E O Grande Hotel Budapeste*. Rio de Janeiro: Faculdades Integradas Hélio Alonso.
- Sagen, M. 2015. *Testing and Evaluating Dye Color: A Study Using Spectrophotometry on Technicolor and Eastman Color Motion Picture Film*. New York: Rochester Institute of Technology.
- Shimojo, S., Kamitani, Y., and S. Nishida. 2001. *Afterimage of perceptually filled-in surface*. *Science*. Aug 31; 293 (5535): 1677-1680.
- Spillmann, L. and J. Levine. 1971. Contrast enhancement in a Hermann grid with variable figure-ground ratio. *Experimental Brain Research* 13: 547-559.
- Zeki, S. 2000. The architecture of the colour centre in the human visual brain: New results and a review. *European Journal of Neuroscience* 12(1): 172-193.

# Fine Arts on Film: The Hand-Painted Work of Stan Brakhage

Sabrina Negri <sup>1,\*</sup>

<sup>1</sup> University of Colorado, Boulder; sabrina.negri@colorado.edu

\* Corresponding author: sabrina.negri@colorado.edu

## Abstract

This paper will approach the topic of colour in cinema by examining the case of the hand-painted films made by experimental filmmaker Stan Brakhage. Specifically, I will present the example of some hand-coloured pre-print elements belonging to the National Cinema Museum in Turin and preserved at the Haghefilm lab in Amsterdam in 2011. I will argue that these films challenge traditional understandings of cinema by belonging simultaneously to the realm of film and to that of the fine arts and will show the consequences of this liminal position both at a practical and a theoretical level. In particular, I will explore the challenges related to the preservation of some of these films, and will relate them to broader issues of originality, medium specificity, and philological recreation of experimental cinema practices.

**Keywords:** *film preservation, experimental cinema, Stan Brakhage, hand-painted film, originality*

## WHAT IS CINEMA? OLD QUESTIONS, NEW ANSWERS

Starting in the early 2000s, the introduction of digital technology in the realm of cinema has rekindled scholarly interest in the ontology of the medium. Questions like “What is cinema?”, which seemed to have lost their appeal for the academic world, have attracted renewed attention on the part of film theorists as soon as digital technologies started supplanting analogue ones.

As I have argued elsewhere, including the practice of film restoration and preservation in discussions over the ontology of cinema can contribute to a fuller understanding of some of the issues raised by the recent technological transition (Negri 2016). For instance, film preservation engages issues of originality, medium specificity, and mechanical reproducibility by virtue of its being the only type of restoration in which the end-product is a copy. If it might seem arbitrary to operate a distinction between an original and a copy when dealing with an art that is based on technical reproduction, it is also true that, from a film restoration perspective, any copy of a film is an original in and of itself, insofar as any copy displays technological and historical peculiarities that render it unique. Digital technology hardly changes this; if anything, film preservation highlights some continuity from the analogue era by showing that certain technological elements cannot be reproduced regardless of whether the restoration is performed digitally or analogically (Fossati 2018).

A particularly relevant example of this mechanism is provided by experimental cinema. By breaking the rules of mainstream narrative filmmaking in its modes of production, distribution, and exhibition, experimental cinema emphasizes the complexity of cinema’s nature and the need for a broader and more flexible understanding of the medium. Because of the lack of standardization of experimental cinema practices, the preservation of experimental films can be incredibly challenging while also highlighting complexities and contradictions that are integral to cinema itself.

In this essay, I will examine the case of Stan Brakhage’s hand-painted films by focusing on some film elements related to his *Spring Cycle* (1995), owned by the Museo Nazionale del Cinema in Turin, Italy, and preserved at the Haghefilm film lab in Amsterdam in 2011. I will argue that Brakhage’s filmmaking practice blurs the line between cinema and the fine arts, and that this hybrid nature can be best appreciated by looking at the preservation of his films. Acknowledging Brakhage’s hand-

painted work's liminal position affects our understanding of cinema by broadening the range of forms that the medium can assume at different stages of its existence, including the archival one.

### **STAN BRAKHAGE'S EXPERIMENTAL FILMMAKING**

When Stan Brakhage began experimenting with fully hand-painted films in the 1980s, he was already considered one of the founding fathers of American experimental cinema. According to experimental cinema scholar P. Adams Sitney, it is generally impossible to attribute the stations of evolution of avant-garde cinema to the invention of a single filmmaker, with one notable exception: the forging of the lyrical film by Stan Brakhage (Sitney 2002: 155). As Sitney writes,

*The lyrical film postulates the film-maker behind the camera as the first-person protagonist of the film. The images of the film are what he sees, filmed in such a way that we never forget his presence and we know how he is reacting to his vision. [...] In the lyrical film, as Brakhage fashioned it, the space of the trance film, that long-receding diagonal which the film-makers inherited from the Lumières, transforms itself into the flattened space of Abstract Expressionist painting. [T]he film-maker working in the lyrical mode affirms the actual flatness and whiteness of the screen, rejecting for the most part its traditional use as a window into illusion. (Sitney 2002: 160)*

In other words, the lyrical film as conceived by Brakhage is an expression of the subjectivity of the filmmaker, who strives to reproduce on the screen his own visual perception. This idea is ripe of consequences: while initially still working in the legacy of Maya Deren, who also tried to translate subjective experience into film, Brakhage has nonetheless been pushing for a more radical reinvention of film form since his early works. Hence the refusal of Renaissance perspective, embodied by the diagonal composition which had been a staple of traditional filmmaking since the Lumière brothers, in favour of a flat space that is more influenced by Abstract Expressionist painting, particularly that of Jackson Pollock, than by narrative cinema. The screen is therefore no longer a window into an illusory world, but rather a canvas for the filmmaker's vision.

Brakhage's idea is further clarified in his own writing. In the often-cited opening of his book *Metaphors on Vision* from 1963, Brakhage explains the drive behind his filmmaking work:

*Imagine an eye unruled by man-made laws of perspective, an eye unprejudiced by compositional logic, an eye which does not respond to the name of everything but which must know each object encountered in life through an adventure in perception. How many colors are there in a field of grass to the crawling baby unaware of 'Green'? (Brakhage 1963: 24)*

Here, Brakhage calls for the recuperation of the perceptual innocence of a child who has not yet entered the realm of language and is therefore able to distinguish all the colours that adults group under the linguistic label of "green". The search for this pre-linguistic innocence includes a rejection of the laws of perspective, which Brakhage sees as artificial and arbitrary. His commitment to lyrical cinema, in different ways throughout his life, is Brakhage's way to go back to that irretrievable unprejudiced vision.

In the earlier part of his career, Brakhage experimented mostly with montage, superimpositions, the splicing together of positive and negative film and the manipulation of the film stock both at the development stage and in post-production. In *Reflections on Black* (1955), for instance, the influence of Maya Deren's "trance film" is still clear, but the search for a new form that could explore more directly the dynamics of vision and consciousness starts emerging. *Reflections on Black* portrays the

inner vision (or hallucination?) of a blind man. While most of the shots are quasi-naturalistic, the use of repetitions, jump-cuts, and flashes of light betray the subjective nature of the man's perception. In *Reflections on Black*, Brakhage also starts working directly on the film stock to achieve effects that the camera alone could not produce. The man's blindness is symbolized by star-shaped figures scratched directly on film so as to erase his eyes, or substitute them with a different type of metaphorical vision.



Figure 1: *Reflections on Black* (Brakhage 1955). The man's blindness is symbolized by star-shaped scratches on the film's emulsion.

The direct intervention of the artist on film materials is key to Brakhage's poetics, as a way to both work around the limitations of the camera and leave a distinctly authorial mark on his work. From this perspective, the climax of Brakhage's research could not be other than cameraless films. After all, the lens of a camera is in itself an eye ruled by compositional logic, and colour film stocks are manufactured to appeal to a taste that is already poisoned by socially-created expectations – in Brakhage's words, "that picture post card effect (salon painting) exemplified by those oh so blue skies and peachy skins". (Brakhage 1963: 25) The earliest and probably best-known example of this new inspiration is the cameraless film *Mothlight* (1963), a collage of organic material (leaves, seeds, flowers, insect wings) glued in-between two perforated 16mm Mylar tape strips – so that *Mothlight* is not only a cameraless film, but technically also a filmless film. Even though Brakhage replicated the experiment on 35mm with *The Garden of Earthly Delights* in 1981, this production process was too labour-intensive to become a staple of his filmmaking.

His hand-painted films, though radically different from these collage works, can be seen as embodying the same desire to portray a vision freed from the constraints of the camera, of colour film emulsions, of culture in general. Brakhage had already begun painting on film earlier in his career, but it was not until the late 1980s that he began making entirely hand-painted films on a regular basis. This shift in style is certainly due to practical reasons (making hand-painted films is cheaper as it leaves out the negative processing stage, it can be done without camera equipment, etc.), but the deep reason probably lies within Brakhage's later interest in what he calls "hypnagogic vision" – that is, what the eye sees when the eyelids are closed.

Hypnagogic vision is the climax of Brakhage's research on the subjectivity of perception. What is more subjective than one's vision when their eyes are closed? It is important to remark that this kind of vision is different from imagination or fantasy; rather, it is a fully perceptual experience, freed from any referent in the world outside of the seeing subject. It is pure colour, the closest an adult can get to the "unprejudiced eye" of the child who has not yet learned that the grass is green. No cameras or



colour film stocks can possibly reproduce those images; only the hand of the artist himself can. In an interview, Brakhage himself links hypnagogic vision with painting, specifically Abstract Expressionist art. He said:

*Somewhere after beginning to give attention to what I see when my eyes are closed, I recognised pattern likeness to Jackson Pollock's interwoven whirls of paint, and then I realised that I had seen it before [...]. It began very quickly to touch some childhood memories. (Smith 2018: 42)*

From this excerpt, the connection between hypnagogic vision, abstract painting, and childhood perceptual innocence is clear. Only the direct intervention of the artist on the film strip can replicate what the artist sees in the most unmediated manner. Painting alone, however, is not enough as it lacks one key feature of perceptual experience: movement. For this reason, the film strip is more than a canvas, but is rather an object that fulfils its purpose only when projected.

### **SPRING CYCLE (1995) AND THE ISSUE OF ORIGINALITY**

From a production perspective, the film strips hand-painted by Brakhage can be considered pre-print materials – that is, film elements that are not supposed to be projected but are needed to produce the projection print. Unlike what usually happens with traditional narrative cinema, though, the processing of these films is rather complex and can be considered as part of the making of the film itself. An example of this complexity is provided by the instructions that Brakhage wrote to Sam Bush, lab technician and frequent collaborator of Brakhage, with regards to the printing process to be used for the 1998 hand-painted film *The Birds of Paradise*:

*I want it ... printed thus: superimpose loops #1 and 2, then superimpose loops #2 and 3, then superimpose loops #1 and 3 ... (take each loop around long enough so that the MOBIUS effect of #1 and #2 has occurred at least once – i.e. each flipped once in the printing: you can also go into the frames of #1 and/or #2 [diagram here] as you, say, run the MOEBIUS loops through a 2nd or 3rd time. Then I'd like a brief (1 minute and a half minute) interlude where loops #1 and #2 superimposition and loops #2 and #3 supers are bi-packed, all; then, finally breaking open into a non-orange negative section of the above bi-pack on non-orange negative and finally loops #1 and #3 superimposition on non-orange negative... P.S. DON'T frame-IN on the single perf #1 and #3 combination and/or on #3 at all in the print – i.e. let it be a kind of exact refrain in all this.*

From this description, included in a private correspondence between Marilyn Brakhage and Luca Giuliani (former head of the archive of the National Film Museum in Turin), it is clear that the hand-painted materials represent just one of the stages of the production of the finished film, and that Brakhage exerted complete control over every single step of the workflow. Given the enormous difference between the hand-printed strips and the finished product, which element constitutes the “original” film by Brakhage? The answer is not easy.

Mark Toscano has worked on several preservation projects of experimental films at the Academy Film Archive, including films by Brakhage. In his essay “Archiving Brakhage”, Toscano goes over the artist’s working habits in order to map possible preservation strategies for such complex productions. For instance, he describes Brakhage’s habit of editing directly on the positive print, leaving the camera negative alone – for those films where a camera negative exists, given Brakhage’s preference for reversal film. In this case, Toscano writes, the edited positive is the artist’s original. (Toscano 2006: 15) In this example, originality is placed in the author’s idea of the finished work. The camera negative,

which would normally be considered the best source element for a restoration, is only a necessary step to fulfil the author's creation, but it is not an original in itself. This is an example of how experimental cinema can diverge from traditional narrative filmmaking both in its practices and in its restoration processes, due to the frequent presence of an individual author and to the creative freedom governing every step of a film's making. As we will see shortly, the case of hand-painted films complicates this already complex scenario.

From this account, it is clear that originality in cinema is a manifold concept that shifts depending on the perspective adopted, and in turn influences the broader issue of the nature of cinema as a medium. This complexity emerges more clearly in film restoration, where it is necessary to define what is meant by "original" before undertaking a restoration project. For instance, a film might have been released in different versions, each of them "original" in its own right. The case of experimental films is even more complex since, as we have seen, there are many stages to the production of a film, each of them unorthodox compared to those of traditional narrative filmmaking and therefore revelatory of the artist's creativity and artistic vision.

In the case of hand-painted films the problem is even more complicated, as shown by the film elements related to *Spring Cycle*, a hand-painted film that Brakhage made in 1995 and sold to the National Film Museum in Turin in 1997. When the Museum decided to undertake a preservation project on *Spring Cycle* in 2011, it was necessary to understand exactly what the original printing process was and, concurrently, what was the nature of the elements in the Museum's possession. The materials conserved at the Museum consisted of four film cans with one short hand-painted fragment in each can. The title on one of the cans was *Spring Cycle*, while the other three had "Mobius" written on them.



Figure 2: *Spring Cycle* (Stan Brakhage, 1995). Pre-print materials. Courtesy of the National Cinema Museum, Turin, Italy.

An email correspondence with Marilyn Brakhage clarified that "Mobius" was not a title, but rather a reference to the artist's technique. Brakhage used to tape film strips in the shape of a mobius loop, which is a loop with a half-twist in it, to superimpose them one with the other at the printing stage. This is confirmed by the writing on the label on one of the film cans, reading "'SPRING CYCLE' loops A+B/ mobius B, C+ D". As Mrs. Brakhage recalls, "After receiving a print back from the lab, made from his painted film, from directions such as these, Stan would then make final edits and that, then, would serve as the original work from which an internegative would be made for further printing." The printing and editing stage are therefore integral part of the production process and are controlled by the artist as much as the hand-painting on blank film. Brakhage himself was very clear on this. In his description of *Spring Cycle*, he wrote: "Note: I am the sole author of this film: Sam Bush of Western Cine Service, Denver, is a paid employee; and I've added the credit, at end, simply to fairly praise his

workmanship". This shows how Brakhage considered the lab work to be part of the making of the film, a film of which he was the only author.

If, as Mrs. Brakhage writes, originality in this case should be attributed to the internegative made after printing the hand-painted strips according to Brakhage's instructions, what is to be made of the hand-painted strips themselves? Are they only pre-print elements like any other? The answer to these questions depends on the perspective we decide to adopt. If the focus is on the finished work, the film that is going to be projected as the author meant, then the hand-painted fragments are only one stage on the path towards the screen. However, this answer is clearly unsatisfactory; how can a work hand-painted by the artist himself not be considered an original? A different answer is possible, although it requires a shift in perspective from a conception of film as a series of images projected on a screen to one of film as an archival object. This new perspective would bring cinema closer to the fine arts, where a work is considered unique and irreproducible by virtue of its being the direct product of an authorial effort. In fact, Brakhage's hand-painted films cannot be mechanically reproduced in any way, as their nature is indissolubly tied to their physical characteristics, including the materiality of their colours.

This shift shows how any restoration of these materials, be it analogue or digital, is bound to produce a ghost of the original, with which it would share no more than its disembodied appearance. Rather than lamenting the loss of the object in reproduction, though, this scenario highlights the multifaceted nature of cinema, which cannot be reduced to one aspect or the other, but is rather the product of the interaction of different drives, materials, experiences, archival artifacts. If Brakhage's hand-painted work can be considered as fine arts on film, it is because some aspects of cinema can be likened to painting, including the uniqueness of some of the objects that can be found in archives. This perspective could open up new exhibition strategies, closer to those of the fine arts, which would highlight the value of the objects while teaching a new history of cinema where a film would no longer be only a story, but also a work of art not dissimilar from a painting.

## **ACKNOWLEDGEMENTS**

My deepest thanks go to Luca Giuliani, former head of the film archive at the National Cinema Museum in Turin, Italy, who has shared with me precious information and documents related to the preservation of *Spring Cycle* with immense generosity. Stefania Carta, Stella Dagna, and Anna Sperone, film archivists and preservationists at the same institution, worked on the preservation of *Spring Cycle* at the Haghefilm laboratory under the supervision of Daniela Currò, as part of the Haghefilm Foundation Internship Program in 2011. To all of them go my gratitude and admiration.

## **REFERENCES**

- Brakhage, S. 1963. *Metaphors on Vision*. Film Culture Inc.
- Fossati, G. 2018. *From Grain to Pixel: The Archival Life of Film in Transition*. Amsterdam: Amsterdam University Press.
- Negri, S. 2016. Simulating the Past. Digital Preservation of Moving Images and the 'End of Cinema'. *Cinéma&Cie* XVI, 26/27: 45-54.
- Sitney, P. A. 2002. *Visionary Film: The American Avant-Garde, 1943-2000*. New York: Oxford University Press.
- Smith, V. 2018. *The Hand-Painted Films of Stan Brakhage: An Interdisciplinary and Phenomenological Exploration of Painted Moving Images*. Ph.D. Thesis, University of Portsmouth.
- Toscano, M. 2006. Archiving Brakhage. *Journal of Film Preservation* 72: 13-25.

# A material investigation of color film technology through the Koshofer Collection

Giorgio Trumpy<sup>1,\*</sup>, Sreya Chatterjee<sup>2</sup>, Ulrich Ruedel<sup>2</sup> and Barbara Flueckiger<sup>1</sup>

<sup>1</sup> University of Zurich; giorgio@trumpy.eu; baflueckiger@gmail.com

<sup>2</sup> HTW Berlin; ulrich.ruedel@htw-berlin.de

\* Corresponding author: giorgio@trumpy.eu

## Abstract

The Koshofer collection is an invaluable resource about the history of color film technology from the late nineteenth century until the 1980s, including film frames from early applied hand coloring, tinting and stencil coloring, to mimetic color processes such as Kinemacolor, Gasparcolor, and many other rare and popular color film stocks. Multispectral imaging in the visible range has been carried out to characterize the optical properties of the color processes, and an extensive microscopic examination allowed to reveal minute material features. These investigations highlight distinctive elements for the identification of some of the most significant historical color processes on film, and at the same time, offer crucial information for classical restoration techniques and for rigorous digitization strategies.

**Keywords:** *Optical microscopy, multispectral imaging, color film technology.*

## INTRODUCTION

In analog film preservation and—more recently—in film digitization, producing copies of movies on modern color film stock or translating them into digital color spaces has proven challenging due to spectral mismatches between historical and current techniques. A deep understanding of the optical and material properties of film colors is necessary to establish effective methodologies for film preservation and restoration.

Although, in principle, any analytical chemistry technique (e.g., chromatography or XRF) can yield information on color chemistry (Ruedel 2017), two methods were chosen here for their ability to reveal in a non-destructive way the intimate link between color chemistry and visual appearance.

UV-Vis spectroscopy can chart the interaction of colorants with light, not only predicting the color appearance of a given film under particular illuminations, but also yielding an increased understanding of the aesthetics of historical color processes. Armed with this convictions, multispectral images were captured in the visible range with the methodology described in previous publications (Trumpy and Flueckiger 2018, Trumpy et al. 2021). The spectral resolution ( $\sim 14$  nm sampling interval) allowed to fairly trace the absorption curves of the samples, and the spatial resolution (up to 5X magnification on a 16-megapixel full-frame sensor) allowed to capture spectra down to a  $2.2 \mu\text{m}^2$  area. Microscopy enables researchers and restorers to ‘zoom into’ the photographic image even further to reveal its intimate structure and material properties tied to the spatial composition of the film stocks (Flueckiger 2012a, Flueckiger et al. 2020). The samples were observed and documented with transmission microscopy, using a Leica DM 2700 M microscope. Between the most plausible features of the analyzed historical color processes, the microscopic investigation also revealed curious oddities that stimulate further research.

The present contribution uses film frames from the Koshofer collection to look back at the evolution of film color technology. Gert Koshofer has been a prolific expert on film technology, who acquired a varied range of frames from rare and experimental historical color film stocks to more commercially viable and mass-produced ones. The collection consists of 161 samples categorized into 36 different color processes. The corresponding galleries have been included on the *Timeline of Historical Film Colors* (Flueckiger 2012b) containing the film frames, their micrographs and spectral measurements.

## SELECTED SAMPLES FROM THE COLLECTION

### Applied colors

Since its inception, the medium of moving images—and the cinema culture it grew into—was aiming at rendering images in color. Methods to selectively color silver-based monochrome images after development were implemented soon, based on staining the gelatin with suitable soluble dyes, either by hand or stencil, or literally ‘bathing’ the film. Redox chemistry allowed for replacing the silver grains with colored salts. These methods, alone or combined, established a wealth of early applied film colors (Read 2009).

### Chromolithography

Chromolithography represents a very special case of applied colors on film, as the images are not created with a silver-halide photographic emulsion. This printing process was first adapted for the *laterna magica* and later used to produce early animation films. These films were usually very short and projected in loops (*litho-loops*). The Koshof collection includes frames from three litho-loops that date back to around the first decade of the 20th century. Figure 1 reports the edge-to-edge color image of a sample with six primary colors: black, yellow, magenta, cyan, light cyan and beige. Other colors were obtained applying two primary colors, such as the green obtained adding yellow to light cyan. The plot in Figure 1 reports the spectral density values of the sample’s yellow and light cyan and green (solid lines). By adopting a simple subtractive model, it is possible to confirm that the light cyan was applied to the whole table until the bottom black line, and the superimposition of a diluted yellow produced the green. In fact, the sum of the yellow spectral density with a dilution factor (0.65) and the light cyan spectral density gives a good match with the green spectrum (black dashed line).

A photomicrograph of another litho-loop sample is reported at the bottom of Figure 1. The film exhibits an extended landscape of craquelure that resembles the quintessential ageing of historical paintings. The typical ‘spongy’, irregular distribution of the color on the film emulsion is especially evident in the red section.

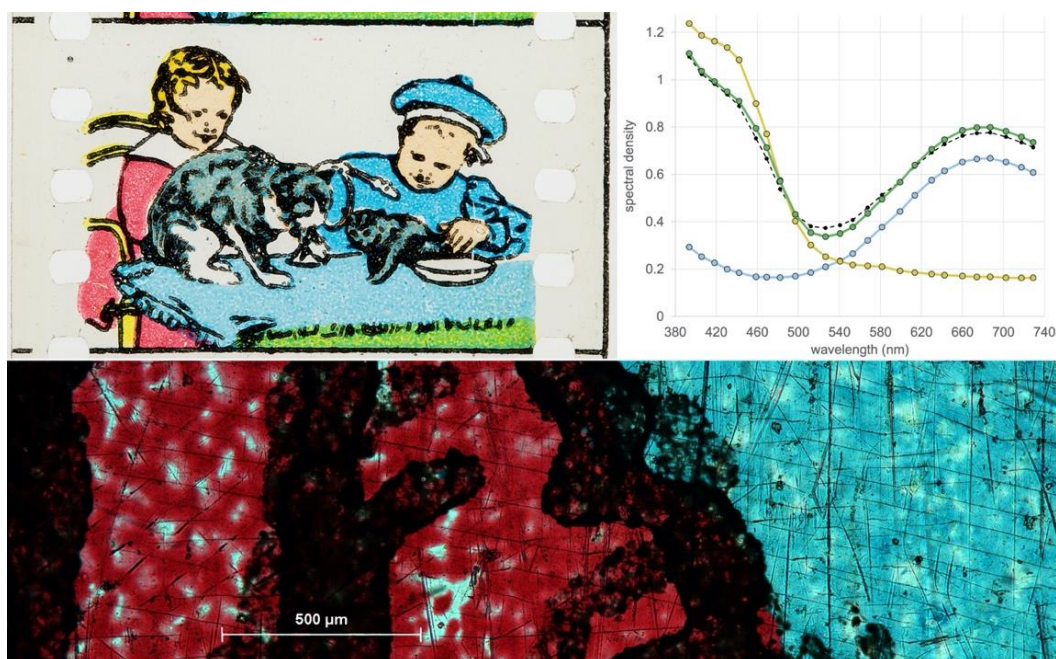

Figure 1: Chromolithographic samples - selected spectra and micrographs.

## Mimetic colors

During the time in which applied colors were widely used, innovation continued and strove towards the so-called ‘natural’ or *mimetic* colors, by splitting spectral information into two to three - rarely four - components and recombining them into a colored rendition on the cinema screen with a large range of technical solutions. The combination was achieved either by admixtures of colored lights (additive color), or by filtering the illumination through layers of dye- or pigment-containing gelatin (subtractive color).

### Additive processes

The principle behind additive processes that employ regular or irregular patterns of colored stripes or dots (*screen processes*) can only be understood via microscopic investigation.

Cinécolor film is the application of the 3-color mosaic screen process Autochrome to motion pictures. The Cinécolor frame reported in Figure 2 dates to around 1929. The color component that is meant to modulate the short visible wavelengths is actually a violet—instead of a blue. In fact, the transmittance values reported in Figure 2 indicate that the blue dye considerably transmits light around 650 nm. This distinctive feature limits the range of colors that the film can generate.

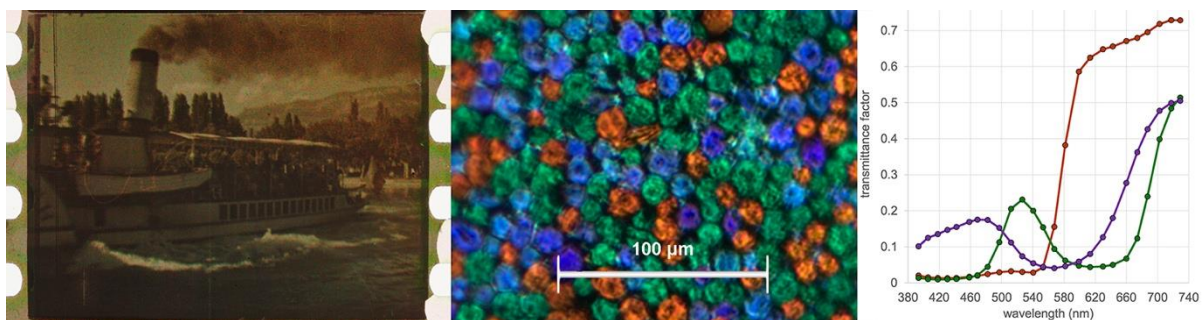

Figure 2: Cinécolor sample – Micrograph and dyes' spectra.

The photomicrograph of the Cinécolor sample (Figure 2-center) depicts a constellation of multicolored particles appearing to be oscillating in a rhythmic choreography, despite being prosaically just transparent colored potato starch grains. The microscopic investigation highlights one of the problems that prevented the successful exploitation of this process. The starch grains tended to form clusters of the same color (Heymer 1933), leading to an uneven pattern that, when projected as motion picture, became significantly obtrusive to seamless perception.

In contrast, Dufaycolor is an additive three-color screen process with a regular pattern of thin colored lines arranged diagonally, which was in use between 1933 to 1958. Like Cinécolor, it was mostly used as a reversal process, but some years after its first introduction, a negative/positive Dufay process was also introduced (Dufay-Chromex 1938).

The micrographs and the chromaticity ranges of reversal and negative/positive Dufay are reported in Figure 3. The green component exhibits the most significant difference. The chromaticity of the aqua-green primary of Dufay reversal is close to the chromaticity of its blue primary, resulting in a strong compression of the color range in comparison to its negative/positive version.

Dufaycolor's regular structure is visible in the micrographs. The diagonal lines are positioned at an angle of 23°, with one line—depending on the year and location of production—overlapping the other two. The areas of the patches are balanced for neutral color rendition.



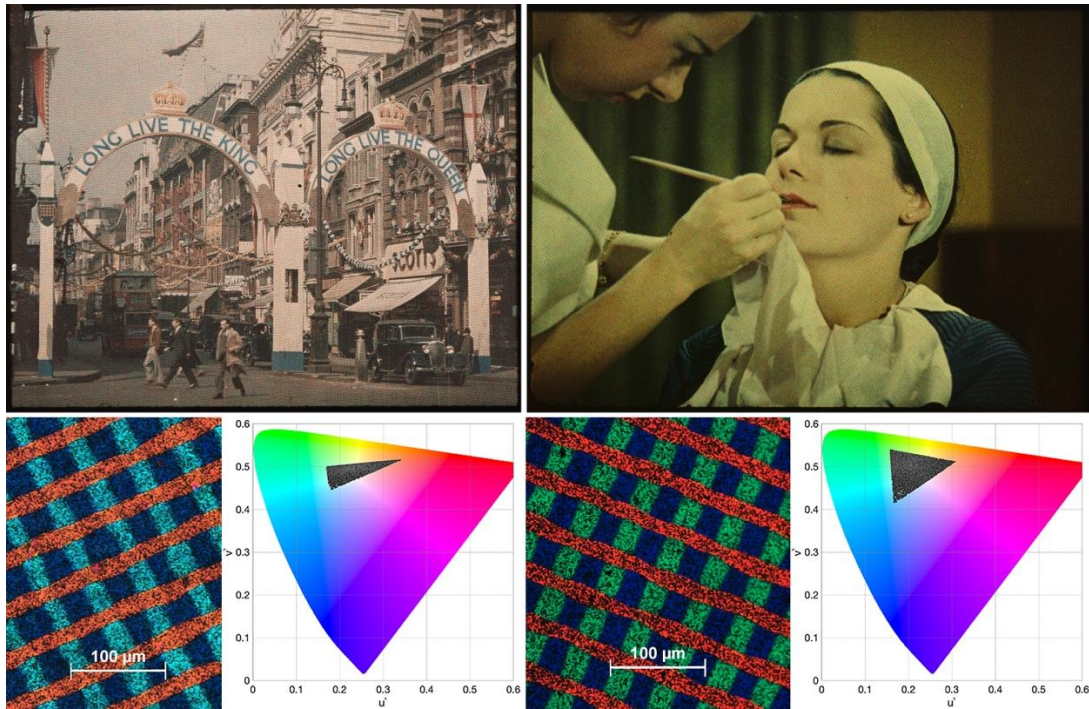

Figure 3: Dufaycolor reversal (left) and negative/positive (right) – Corresponding micrographs and chromaticity ranges (bottom).

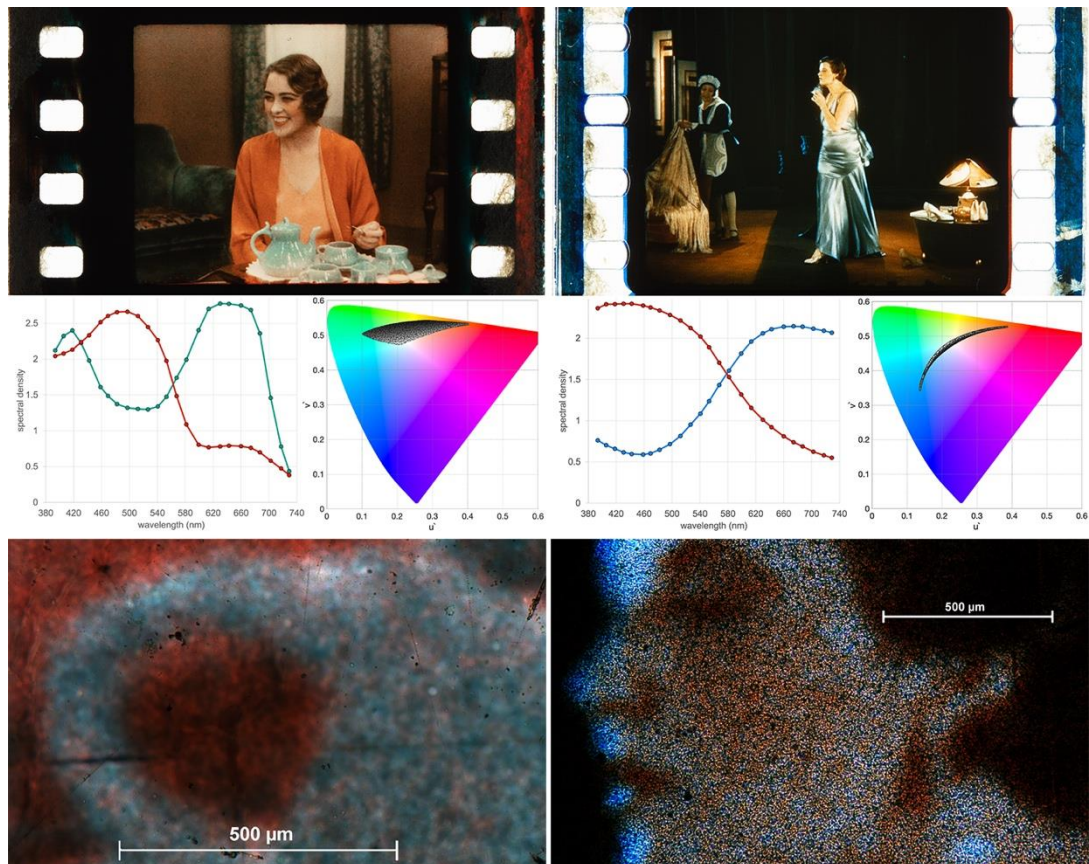

Figure 4: Two-color Kodachrome (left) and Multicolor (right) – Pure dyes' spectra, chromaticity ranges and micrographs.

### *2-color subtractive processes*

Two-color processes only reproduce a limited color range, leading to very characteristic aesthetics. The visible spectral range is split in two sub-ranges, and in each sub-range the transmitted light is modulated by one of the two colorants. The Kodachrome Two-color, invented in 1915 (Ryan 1977), employs a red-orange colorant that mostly absorbs below 560 nm and a green colorant that mostly absorbs above 560 nm (see Figure 4-left). The sub-range modulated by the green colorant also includes a small additional region below 440 nm. The image of this two-color film frame renders a formidable sense of color tridimensionality, which is corroborated by the quite extended chromaticity range reported in the left side of Figure 4. The photomicrograph of the Kodachrome sample illustrates a fleeting/elusive textural quality. The large size of the image particles is indicative of the low emulsion speed of the process, and the patchy structure appears quite blurred in magnification.

Multicolor is a double-coated subtractive two-color process that was in use between 1928 and 1934 (Otis 1931). The cyan and red dyes create well separated sub-regions of the visible spectrum. The absorbance curves cross each other smoothly around 580 nm (see Figure 4-right). The micrograph of Multicolor (Figure 4-bottom/right) resembles a piece of textile embroidered with golden thread work, containing strong highlights and extremely deep darks. The toned image particles confer a characteristic granular texture that reminds colored frosted glass, with the two color records often slightly displaced thereby creating color fringes.

### *3-color subtractive processes*

Subtractive three-color processes became the dominant standard in photography and film throughout the second half of the 20th century, with Technicolor being the market leader for two decades until the mid-1950s. In Technicolor prints, yellow, magenta and cyan dyes were printed in succession through a dye-transfer process onto a blank film. The dyes modulate the short, medium and long wavelengths respectively (see Figure 5). The micrograph of the Technicolor No. V color chart from 1956 (Figure 5-bottom/right) has a characteristic patchy, halftone-like pattern resulting from the printing process. The photomicrograph resembles a crystallized material, like a layer of a suddenly frozen liquid. These frames depict a test print composed of the three images from the individual printing matrices. The misalignment is responsible for the color fringes visible in the micrograph of the combined image.

## **CONCLUSION**

Investigating the material properties of color film yields highly significant results, enabling archivists and restorers to identify historical film stocks by comparing unidentified film prints in their holdings with the documentation discussed here and published online. Furthermore, such investigations need to be integrated into film digitization/restoration practices more rigorously. Image texture and characteristics are important factors of a film material's specific aesthetics and color appearance, necessitating minute attention to each element's genealogy and materiality.

## **ACKNOWLEDGEMENTS**

The multispectral images were captured in the framework of the ERC Advanced Grant *FilmColors - European Union's Horizon 2020 research and innovation program*, grant agreement No 670446, while the micrographs were taken during a collaborative project between HTW Berlin and the University of Zurich with the support of the FNK Commission for Research and Young Scientists. The authors would like to thank David Pfluger for his valuable suggestions and constructive feedback.



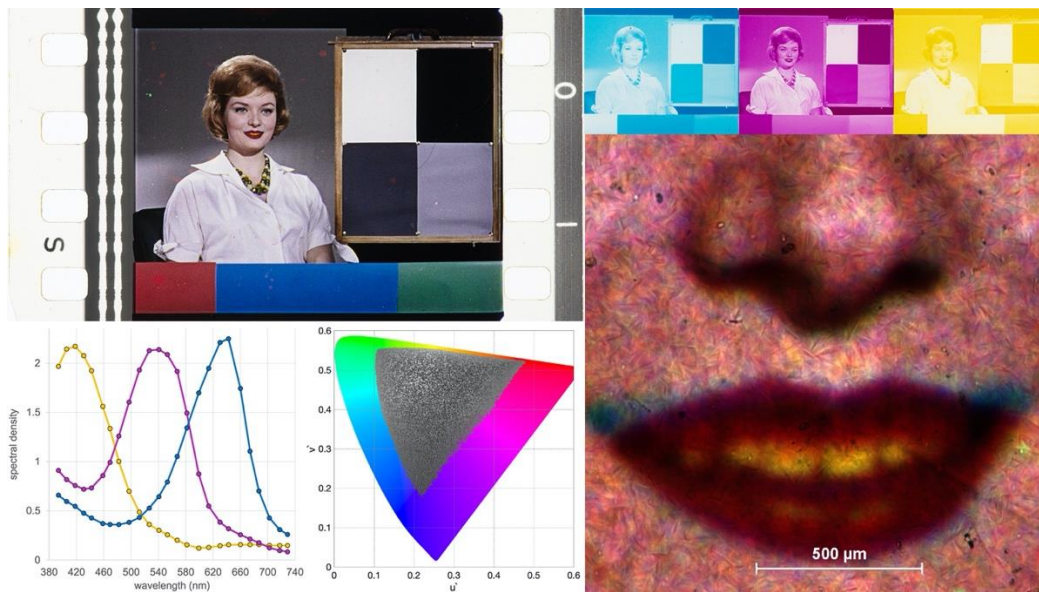

Figure 5: Technicolor print – Pure dyes' spectra, chromaticity range, individual matrices and micrograph of the composite print.

## REFERENCES

- Dufay-Chromex. 1938. *The Dufaycolor Manual. Of Interest to Advanced Amateurs, Professional Photographers and Printers*. New York: Dufaycolor, Inc.
- Flueckiger, B. 2012a. "Material Properties of Historical Film in the Digital Age." *NECSUS. European Journal of Media Studies* 1 (2): 135–53.
- Flueckiger, B. 2012b. *Timeline of Historical Film Colors*, ff. <https://filmcolors.org/>.
- Flueckiger, B., N. Daugaard, and O. K. Stutz. 2020. Shattered Provenance in the Digitization of Early Color Films. In *Provenance and Early Cinema*, edited by J. Bernardi, P. Cherchi Usai, T. Williams, and J. Yumibe, 80–90. Bloomington, Indiana: Indiana University Press.
- Heymer, G. 1933. Auflösungsvermögen und Farbwiedergabe in der Farbrasterphotographie. In *Veröffentlichungen des Wissenschaftlichen Zentral-Laboratoriums der photographischen Abteilung Agfa*, edited by IG Farbenindustrie, 3:188–207. Leipzig: S. Hirzel.
- Otis, R. M. 1931. "The Multicolor Process." *Journal of the Society of the Motion Picture Engineers* 17 (1): 5–10.
- Read, P. 2009. "Unnatural Colours'. An Introduction to Colouring Techniques in Silent Era Movies." *Film History* 21 (1): 9–46.
- Ruedel, U. 2017. "An Archeometry of Colours. Pathé Metal and Mordant Toning in the Davide Turconi Collection Studied by X-Ray Fluorescence." In *Recherches et innovations dans l'industrie du cinéma. Les cahiers des ingénieurs Pathé (1906-1927)*, edited by Stéphanie Salmon and Jacques Malthête, 251–66. Paris: Fondation Seydoux Pathé.
- Ryan, R. T. A. 1977. *History of Motion Picture Color Technology*. London: Focal Press.
- Trumpy, G., and B. Flueckiger. 2019. "Chromatic Callier Effect and Its Repercussions on the Digitization of Early Film Colors." *Journal of Imaging Science and Technology* 63 (1): 10506-1–11.
- Trumpy, G., J. Y. Hardeberg, S. George, and B. Flueckiger. 2021. "A Multispectral Design for a New Generation of Film Scanners." In *Proc. SPIE 11784, Optics for Arts, Architecture, and Archaeology VIII (8 July 2021)*.

# Digital Colour in Cinema: An Incomplete Transition

Luca Giuliani <sup>1,\*</sup>

<sup>1</sup> Independent scholar; luca.giuliani1@gmail.com

\* Corresponding author: luca.giuliani1@gmail.com

## Abstract

This paper will approach the ever-changing relationship between technical and technological inventions and film language innovations in the history of colour cinema. It will be outlined continuity and discontinuity elements in the transition from photo-chemical to digital cinema. The technological relationship between analog and digital cinema will be addressed under the paradigm of time/space-based color control for photochemical processes and digital software. All together, these analyses bring to some final considerations on the real nature expressed so far by digital cinema, and in particular on the relationship between cinema and other, seemingly more convincing, digital outcomes such as Virtual Reality, Augmented Reality and 3D technology.

**Keywords:** *colour film theory, photo-chemical colour processing systems, digital colour grading/correction, cinematography, digital colourist*

## COLOUR TECHNOLOGY AND FILM STUDIES: FEW MILESTONES AND NEW QUESTIONS

In the last 20 years, the transition to digital technology has had the undisputed merit of reinstating the focus of attention by critics and film studies on film technology, techniques, and especially colour. Since the 1950s, criticism on the issues of cinema apparatus and related modes of production, representation, and reception, increasingly intertwined with those of technology, has been marked by different seasons and approaches.

From André Bazin's (1958) "theological" and idealistic reflections in the 1950s (the myth of total cinema), to Jean-Louis Comolli (1971) & Co's Marxist-determinist approach (Baudry 1978; Heath 1981), to Kenneth Macgowan (1965) and Douglas Gomery's (1985) Darwinian causal linearity principles (back to the essence of the origins of cinema in order to demonstrate the perfection of the existing film apparatus), over the decades we have gradually reached the American neo-formalist theories of the 1990s, whose protagonists, David Bordwell (1985), Rick Altman (1984), John Belton (1982) and, in a certain way, Dudley Andrew (1979), inter alia, have vastly contributed to an updated and appropriate examination of the technological issues related to film history. Altman's "crisis historiography" specifically identified intensely productive moments for the analysis of the modes of the apparatus in the periods of transition and transformation (from silent to sound or, currently, from analogue to digital)<sup>1</sup>.

As mentioned, several historiographic errors have been incurred, due to exclusively technical and fetishist approaches, or too wide-ranging frameworks that took into account only industrial issues, forgetting the expressive elements of film making.

At the same time, however, some essential points have been established and consolidated as touchstones for studies on technique and technology.

For instance, the distinction between the three phases of technology proposed by Belton (1992) and previously stated by Gomery (1985): invention, introduction, and diffusion.

---

<sup>1</sup> For an in-depth analysis of the critical development mentioned here, see: Piva and Giuliani 2020.

Or the fact that the effectiveness and acceptance of new technology (in our case, colour realism) is not perceived by culture and spectators as a comparison with reality, but as a comparison with the degree of realism of the previous technology, the one being replaced (Altman 1984). In the history of cinema, progressive innovations in colour reproduction have always represented emblematic cases: the most striking one concerns Technicolor, accepted not for its realism (which has always aroused reservations) but for the augmented colour quality compared to previous reproduction systems (mostly developed at an experimental level) or even in comparison with the complete absence of colour in black and white films.

Finally, the twofold nature of film technology: as the mechanical base of representation and as a symbolic form – “the substance on which the work of giving meaning to and representation is carried out” (Aumont 1989). This places fundamental importance on the process of transformation from the *making* to the *expression* or rather, to the moment in which the technique becomes a plastic art form. Therefore, the technique should be seen as an integral part of the semantic operation of expressing the language of the film itself. This is the “*tèchne*”, seen as an art form in itself, capable of creating an expression (for further reading, see: Giuliani, 2007).

Therefore, distinguishing the different phases of a technology roadmap, considering expectations and audience satisfaction, and evaluating the expressive work of the filmmakers, amounts to greater complexity than a mere deterministic and Darwinian technological evolution: silent, sound, colour, digital. Even in this digital transition we perceive a situation in which, for instance, the technical work on set (today it would be better to say in post-production) produces anticipations of what is technologically available, retrieves obsolete or never fully developed techniques, everything that expresses and achieves an author’s vision and style<sup>2</sup>.

### ***DIS/CONTUINITIES BETWEEN PHOTO-CHEMICAL AND DIGITAL CINEMA***

Consequently, this queries the continuity or discontinuity of digital cinema from the previous photo-chemical technology, and the spotlight is on colour. Two different levels of analysis emerge. Firstly, the real and tangible technical-technological innovations brought by digital. Secondly, the actual outcomes, and aesthetic results of digital colour compared to the preceding chemical analogue.

On the technical level, digital technology has made the reproduction of colour (it would be better to say its production, in the sense of a colour that is generally detached from the real reference of the scene or set) an extremely simple procedure, perfectly controllable through two different processes. The first is colour grading, which concerns the overall chromatic aspect of an image (or a series of images): contrast, brightness, saturation. It is nothing but photography deploying the new digital technique.

The second process concerns the actual colour correction that selectively manipulates single portions of an image or a single colour. This is a ground-breaking process (unless we want to consider the stencil, tinting and toning techniques of the early cinema), and is set to becoming a real revolution as was the shift from painting to cinema. As Jacques Aumont (1989: 10-11) recalls, the astonishment in front of moving images at the beginnings of cinema was due not only to the movement but also to the multitude of small details, for example of a battle scene, or the volatile transparency of

---

<sup>2</sup> For an in-depth analysis of asynchrony between the market, technology and film language, related to color reproduction systems in history of cinema, see: Giuliani L. 2002a.

atmospheric effects (the real test of a painter's dexterity) which could now be resolved very simply by impressing the silver salts of the film in a fraction of a second.

On a technical level, therefore, colour correction introduced a real paradigm shift: the digital colourist works on the spatiality of an image composed of pixels; previously, the director of photography worked on the temporality of colour timing when printing the negative, he could control the exposure time (or light exposure) for each of the three main colours (red, green, blue), thus acting on the sensitometry and densitometry of the photo-chemical image.

However, the second level, the aesthetic-visual level, evidences a paradox. On one hand, the emergence of new skills required to manage this absolute digital control of the image (headed by the new figure of the colourist), have increasingly involved information technology, relegating photographic technique to a second place, and has overturned the historical importance of shooting and lighting on set, in favour of post-production. On the other hand, it is also true that the parameters and elements of the construction of an image still remain fully photographic and pictorial, in keeping with that visual arts tradition dating back to medieval times. The only difference is that now it is no longer a question of reproducing the colours, tones, and lights of reality, but it is necessary to manipulate the patterns (often standardised, as we will see later), palettes and colour libraries of the colour correction software.

### **AN INCOMPLETE TRANSITION**

The first considerations, albeit partial, start to emerge. The first leads us to think that, despite the radical digital technological change, the consequences of digital cinema on visual colour aesthetics do not look as innovative and radical as we could expect. The still dominant framework of a hybrid analogue/digital workflow explain the strong elements of continuity between the two different film technological eras.

The second is the idea that the digital era has not yet entered its technological specificity. Digital technology is not yet fully employed and seems to be navigating in that phase (as happened other times in the history of filmmaking) characterised by the transfer and replication of the results of the previous technology (photo-chemical) into the new digital media. For instance, the Aumont's observation (1989: 126-127) on the birth of modern colour in the mid-1960s remains emblematic, even in today's digital transition. The cinema of modernity revolutionized the reproduction of colours when it understood it had to abandon those systems based on the idea of replicating the processes of typographic printing (the Technicolor matrices, for example) and began to experiment and fully grasp the spirit and possibilities of photo-chemical technology, using the 3-layer monopack of the Agfacolor patent (already existing at the end of the 1930s) and then developed after the war by EastmanColor<sup>3</sup>.

In other words, following Aumont's example, the visual change that took place in the 1960s and led to a new chromatic aesthetic in the cinema of modernity (consider the difference between Gianni Di Venanzo's 1965 masterpiece *Giulietta degli spiriti* by Federico Fellini and the other *Giulietta*, in the Shakespearean *Romeo and Juliet* by Franco Zeffirelli in 1968) does not seem to have occurred yet in this digital age. At least not in cinema: in comparing cinema with the new digital techniques of Virtual Reality, 3D technology, and Augmented Reality, one fully understands in which areas digital technology has really made an unparalleled impact.

---

<sup>3</sup> For an in-depth history of Agfacolor's patents and their developments before and after WW2, see: Giuliani 2005.

A third consideration concerns elements of continuity between the two technologies, and in particular those more advanced and experimental outcomes of photo-chemical cinema that anticipated digital solutions by shifting from timing control to spatial selection of the image. Towards the end of the last century, a number of directors who were attentive to technical data as an expressive resource, experimented with solutions that did not technically exist yet, anticipating today's standardised normality of digital software.

The experiments by Vittorio Storaro and his *ante-litteram* colourist, Ernesto Novelli, relating to an additional b/w development bath for the colour-negative in order to resolve the difficult combination (today extremely simple in digital) of desaturated colours in the presence of very contrasting contours (a stylistic feature of many films of the last decade of the last century) are emblematic. These experiments led to the ENR "silver-retention processes" technology, which was later particularly enhanced by Darius Khondji's unprecedented formal and visual solutions for the David Fincher (in particular, *Seven*), Jean-Pierre Jeunet and Danny Boyle films, among others. This research was pursued and conducted for years in photochemical post-production laboratories, initially crafted, and then industrialised with the ENR patent, a sort of anticipation of the selective spatial control of the digital image<sup>4</sup>.

Finally, the fourth consideration concerns the continuity of role and skills between the director of photography and the new figure of the colourist, who somehow inherits and expands the boundaries. Reading the interviews and the still scarce comments by the most appreciated colourists<sup>5</sup>, the transfer of photographic proficiency, and the continuity of aesthetic challenges in the construction of the image is evident. Few things have changed since the days of *Brother Where Art Thou*, (Ethan and Joel Coen, 2000) the first film to make massive use of colour correction, and the elements of a colourist's skilfulness remain the same as those of a director of photography. Of course, the colourist does not intervene on set, but is a computer expert whose main dexterity is to select, but also tamper with, or in some way bypass the automatisms of the colour correction software, with a view to freeing the director's chromatic-visual choices from the obligatory and standardised solutions of the libraries, thus increasing their originality.

### **TOWARD DIGITAL CINEMA COLOUR**

In conclusion, this brief introduction to the analysis of the dis/continuity between analogue and digital highlights a situation of contamination and transfer between old and new technologies and leads to considering the "cultural series" approach, previously formalized by André Gaudreault (2011) for the early cinema, as more productive. The scholar identifies a series of nineteenth-century narrative and iconographic themes and exhibition modes, that were famous and widespread in the pre-cinema visual tradition (above all the Passion of Jesus or famous episodes from literature) and were transferred into the new technological form of cinema at its beginnings. These series, at that time, represented cultural landmarks and points of reference that helped the spectator to switch to the new technological form of film exhibition.

It does not seem different today, and we could add the "technological series" to the "cultural" ones, meaning traditional practices, techniques, and experiences that survive and renew themselves in a

---

<sup>4</sup> For an in-depth analysis of the advances and developments of the ENR system and of Bertolucci's crucial passage from the twenty-year collaboration with Vittorio Storaro to that with Darius Khondji (*lo ballo da sola*), see: Giuliani L. 2002b.

<sup>5</sup> Among the most appreciated colorists and among the few who have already intervened with their own reflections or testimonies, are to remember: Adam Inglis, Adam Glasman, Asa Shoul, Jean-Clément Soret. Among the directors who have first experienced the effects of color correction, Joel and Ethan Coen and Wes Anderson are to mention.

changed technological context<sup>6</sup>. It is not by chance that the challenge between analogue and digital quality is arguably ending only now, after twenty years of "battles" resulting in a substantial draw, with an outcome which until a few years ago was not entirely certain.

Moreover, it is necessary to consider the idea that digital technology did not stem from reproduction or preservation needs, but rather, and mainly, to replicate and disseminate anything, rapidly, anywhere. The unprecedented element of digital technology was established in the processes of circulation and distribution even before production, in the context of what has become known as "dematerialisation".

Colour therefore seems to guarantee the imaging quality standards of a technology, the digital one, conceived for other purposes and seems to assume a role of aesthetic-visual accreditation for the excellence of the results achieved by the previous analogue technology, and the pictorial-photographic tradition. A truly digital colour will have probably to await future evolutions in Virtual Reality, which has provided so far unmatched colour transparency since nitrate films and carbon lamps and, at the same time, seems particularly congenial to the new ethereal style of the Artificial Intelligence' society and era.

## REFERENCES

- Altman, R. 1984. A Semantic/Syntactic Approach to Film Genre. *Cinema Journal* 3: 6-18.
- Aumont, J. 1989. *L'oeil interminable. Cinéma et peinture*. Paris: Lignes.
- Belton, J. 1992. *Widescreen Cinema*. Cambridge: Harvard University Press.
- Baudry, J. L. 1978. *L'effet cinéma*. Paris: Editions Albatros.
- Bazin, A. 1958. *Qu'est-ce que le cinéma? 1. Ontologie et langage*. Paris: Éditions du Cerf.
- Bordwell, D., J. Staiger, and K. Thompson 1985. *The Classical Hollywood Cinema: Film Style and Mode of Production to 1960*. London: Routledge and Kegan Paul; New York: Columbia University Press.
- Comolli, J. L. 1971. Technique et idéologie. *Cahiers du cinéma* 229, 230, 233, 234/5.
- Dudley, A. 1979. The Postwar Struggle for Color. *Cinema Journal* 2: 41-52.
- Gaudreault, A. 2011. *Film and Attraction: From Kinematography to Cinema*. Chicago: University of Illinois Press.
- Giuliani, L. 2002a. I colori di Jour de fete: fra anticipazioni stilistiche e ritardi tecnologici. In: *Il gesto sonoro. Il cinema di Jacques Tati*, G. Placereani, F. Rosso ed. Milano: Il Castoro, 69-79.
- —. 2002b. Note sulla luce nel cinema di Bertolucci. *La valle dell'Eden* 10/11: 51-68.
- —. 2005. Una volta si scriveva così: ferrania. In: *La materia dei sogni: l'impresa cinematografica in Italia*, V. Buccheri, L. Malavasi ed: Roma: Carocci, 60-80.
- —. 2007. The Camera Tuned to the Sensitivity of the Eye. Origins and Heritage of Italian Neorealistic Style. In: *Film Style / Lo stile cinematografico*, E. Biasin et al. ed. Udine: Forum: 221-226.
- —. 2013. From Wonder to Propaganda: The Technological Context of Italian Silent Cinema. In: *Italian Silent Cinema. A Reader*, G. Bertellini, ed: New Barnet: John Libbey Publishing Ltd: 143-150.
- Gomery, D. 1985. *Film History: Theory and Practice*. New York: Knopf.
- Heath, S. 1981. *Questions of Cinema*. Bloomington: Indiana University Press.
- Macgowan, K. 1965. *Behind the Screen: The History and Techniques of the Motion Picture*. New York: Delta.

---

<sup>6</sup> For an example of the notion of "technological series", see: Giuliani L. 2013.

Piva, M., and L. Giuliani. 2020. Le corps et le regard: introduction à une histoire du cadrage. In: *Des avant-dernières machine. Cinéma, techniques, histoire*, S. Krichane, B. Turquety, ed. Lausanne: Editions L'Age d'Homme, 191-200.

# Film Repository for Restoration (FiRe2): identification of photographic and cinematographic films

Beatrice Sarti <sup>1, \*</sup>, Arianna Crespi <sup>1</sup>, Giulia Morabito <sup>1</sup>, Alice Plutino <sup>1</sup> and Alessandro Rizzi <sup>1</sup>

<sup>1</sup> MIPS Lab, Computer Science Department, Università degli Studi di Milano; [beatrice.sarti@unimi.it](mailto:beatrice.sarti@unimi.it); [arianna.crespi3@studenti.unimi.it](mailto:arianna.crespi3@studenti.unimi.it); [giulia.morabito@studenti.unimi.it](mailto:giulia.morabito@studenti.unimi.it); [alice.plutino@unimi.it](mailto:alice.plutino@unimi.it); [alessandro.rizzi@unimi.it](mailto:alessandro.rizzi@unimi.it)

\* Corresponding author: [beatrice.sarti@unimi.it](mailto:beatrice.sarti@unimi.it)

## Abstract

The identification and restoration of photographic and cinematographic films are often needed as they can undergo severe deterioration, aging, and color fading. Moreover, films also have to keep up with quick technological changes. In this context, knowing the material that composes the film is fundamental to restore the chromatic characteristics to their origins and to perform a correct retrieval faithful to the analog support. Nevertheless, the lack of technical information and the absence of open-source archives of the production companies underlines the actual and concrete need for a database of physical, chemical, and sensitometric data of films and photos. These are the motivations that lead to the creation of FiRe<sup>2</sup>, a unique database of cinematographic and photographic materials that can support the work of conservators, restorers, and researchers. With this project, we also aim at promoting cooperation between institutions and professionals.

**Keywords:** *Film Restoration, Color in Film, Color and Cinema, Film Database, Color Correction*

## INTRODUCTION

Film preservation is a challenging process: it involves many different fields and merges both humanistic and scientific knowledge. It is a complex framework, which requires a multidisciplinary background.

The first step of film restoration is historical and philological research, as many different copies of the same photo or motion picture are usually available (e.g., some copies may have suffered censorship and others can present intertitles): understanding the historical context in which the original negative and the copies have been produced as well as the film philology reconstruction are fundamental aspects for a correct restoration. However, this type of information is not just the only to be considered since scientific data are essential both for conservation and restoration purposes.

Every (motion or still) picture is the result of the interaction of different cameras, film stocks (with their specific emulsion, dyes, and sensitivity), printing machines, and projection technologies. The varied combination of all these elements produces a different final image. In this way, analyzing, studying and understanding the chemical and physical properties of materials that compose the film and the technical features behind the photographic and cinematographic filmmaking are fundamental to set up a solid restoration workflow faithful to the original materials.

The latest step of this evolution is the introduction of digital technologies, which has led to a deep development in the acquisition and fruition techniques and a consequent improvement of the post-production process and film restoration. Since the superior manageability and reversibility of digital intermediate, more and more archives are embarking on massive digitization initiatives to improve the access to their materials. However, most of the time, the conversion from analog to digital is made without effective color control and management. This leads to issues in color reproducibility in digital systems, since not all the current display and projection devices can reproduce the same color palette of an analog film. Reconstructing the exact set of colors of the original films is therefore a challenging task, even more complicated by the lack of technical information (e.g., physical data about film dyes, emulsions and sensitivity).



All these needs, lead to the creation of a unique open-source technical database, to be used as a starting point for film restoration. The preliminary analysis made on the materials provided by a team of experts has led to a first film classification. Then, many existing databases have been merged and supplied with more information and a relational database has been implemented. To make it available for the community of restores and researchers a completely free website has been created (Photo FiRe<sup>2</sup>), with the aim of promoting the sharing of data and the cooperation between professionals.

This work aims to raise awareness on the color reproduction problems that always affect the practice of digitization and digital restoration and to promote the collaboration between privates and institutions, to retrieve technical data that may be otherwise be lost.

### THE MOTIVATION BEHIND FIRE<sup>2</sup>

Over the years, the film industry has faced a lot of innovations: the development of different film base materials, the advancement of many acquisitions and projection instruments, as well as printing and developing machines. One of the most tangible and rapid changes has been the continuous introduction of new coloring techniques: indeed, since the invention of film, one of the great hurdles has been adding color to black-and-white motion pictures. Attempts to color films have been numerous and various during the years and many different techniques and dyes have been used (Read 2009), (Pierotti 2012), (Misek 2010), (Flueckiger 2012), (Rogers 2007).

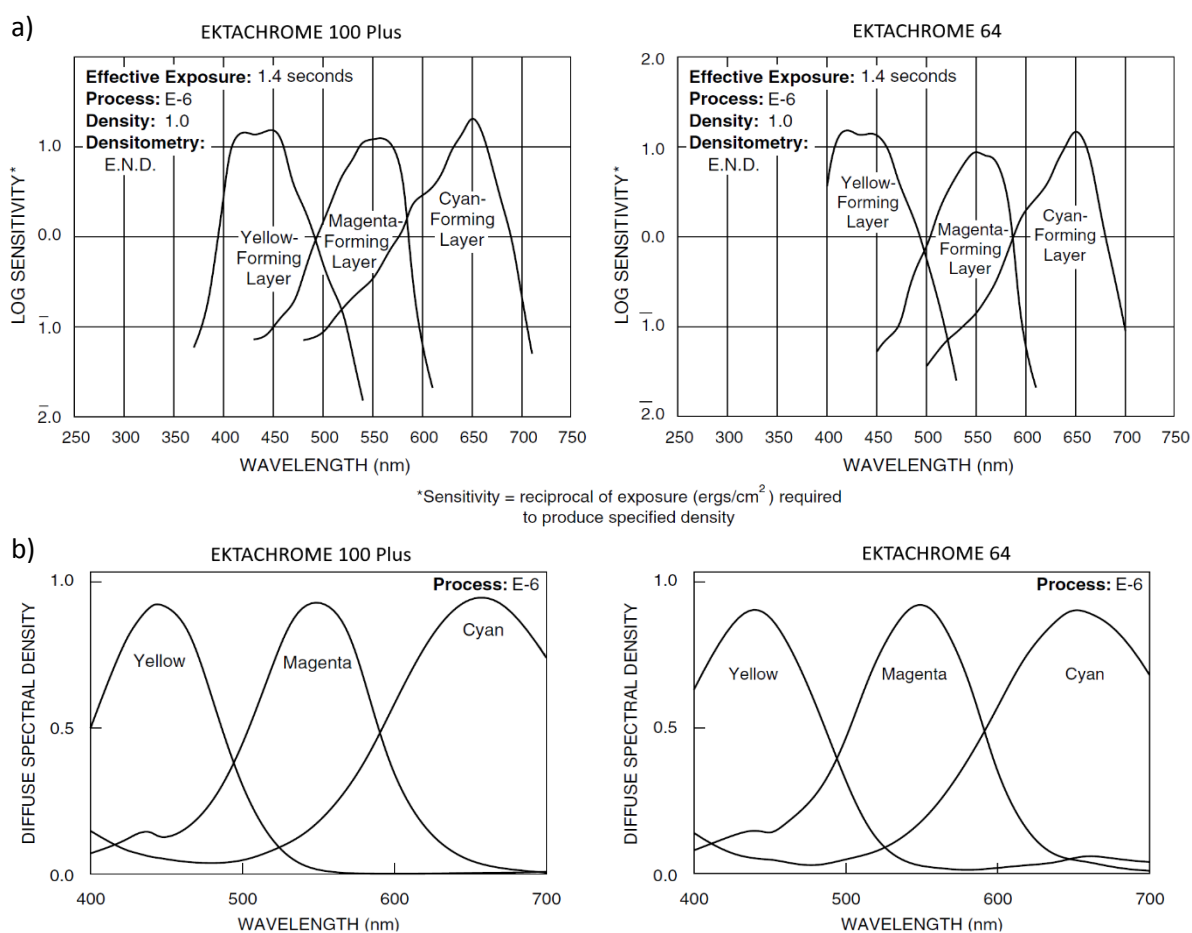

Figure 1: Comparison between the Spectral Sensitivity curves (a) and Spectral dye Density Curves (b) of two different reversal film stocks: Kodak Ektachrome 100 Plus Professional and Kodak Ektachrome 64 Professional.

Thinking about the images as separate and independent entities from the material of which they are composed is deeply wrong and can lead to incorrect conservation or unfaithful retrieval of the cultural object. Therefore, even though, the content of the film has always been considered more important than the support on which it relies on, the (motion or still) images are the result of the physical and chemical properties of the material of the film stock (with its specific emulsion, dyes, and sensitivity) and its interaction with light. That is because every film has a different gamut. In color theory, the gamut is the subset of colors that can be accurately represented within a given color space or by a certain device. To better understand this concept, Figure 1 shows the spectral sensitivity curves and the spectral dye density curves of two reversal films by Kodak: Ektachrome 100 Plus Professional and Ektachrome 64 Professional. The spectral sensitivity curves represent how the emulsion layers respond to a different wavelength of the electromagnetic spectrum. Higher values indicate a more light-sensitive emulsion (for example, the green curve for Ektachrome 64 is lower than that for Ektachrome 100 Plus, which can instead emphasize greens more), while the curve overlapping means a lower color saturation. The spectral dye density curves represent the percentage of absorbed/transmitted light as a function of wavelength. In the same way, the overlap in the curves leads to less-saturated colors in the resulting images and the evident differences between the two films implying that the same image produced by the two stocks will be different.

The concept of gamut and the relative color reproduction issues are even more evident nowadays with the advent of the digital intermediate and the development of digital technologies. The migration from analog to digital media leads to problems in color reproducibility in digital systems, since every reproduction instrument or projection technology, as well as every cinematographic or photographic film, has its own gamut. In Figure 2 is reported an example of this: in the CIE Chromaticity Diagram, the xy coordinates of the RGB primaries of Macbook air 12 monitor are compared to the once of a motion color negative film. The film stock has a wider gamut and consequently a common monitor cannot correctly reproduce its colors.

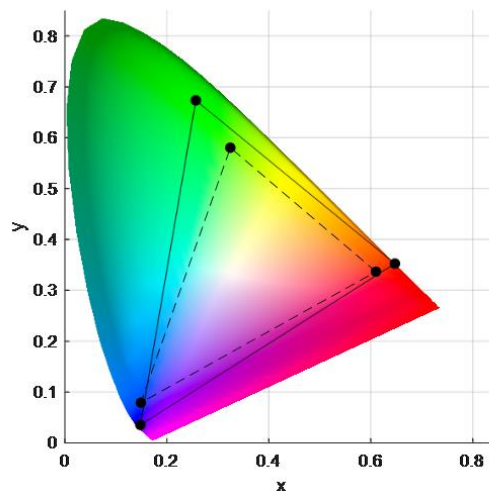

Figure 2: Comparison between the gamut of the Macbook air 12 monitor (dashed lines) and the Eastman EXR 200T color negative film (solid line).

This problem of color reproduction, even if it has been less studied, is clearly visible when comparing the original analog film and the digital media. Nowadays, to overcome this issue, film color correction is usually performed manually with a visual comparison. Nevertheless, even though the correction is performed by an expert, the subjectivity of the operations remains a limit in film restoration. In this context, the availability of technical and sensitometric data about the film would

make the preservation and restoration work easier and more objective: some errors in tones and color reproduction could be avoided and the specific film features could be supported by mathematical and physical models. From the spectral sensitivity curves and the spectral dye density curves of the films it is possible to build specific algorithms to reconstruct their gamut and to retrieve other colorimetric data. A possible outcome to this project is the creation of new LUT (Look-Up-Tables) to simulate the colors of a specific process, or the creation of film emulsions degradation models starting from the original film stocks datasheets. In this way some attempts have already been made (Gschwind and Frey 1997), (Rizzi et al. 2008) but many improvements need to be achieved in order to reproduce a faithful color film perception.

For all these reasons, the availability of such kind of information could be very useful in the restoration workflow and in the reproduction process to obtain a result faithful to the original film and materials. Production companies often provide informative datasheets of each film produced, which include all the technical features of the product as well as their sensitometric curves and the information for the film stock characterization. Nevertheless, these datasheets are not always available, especially for the oldest materials. The accessibility of information is indeed another problematic point. First of all, the openness of the archives is not always so obvious: many archives do not have public access or only provide partial information. Finally, while there is plenty of historical archives, the retrieval of scientific data is often hard.

### ***FIRE<sup>2</sup>: WEBSITE AND DATABASE***

Many works have been already published, to index and organize the different techniques and materials used in photography and cinema history. Nevertheless, many technical information on sensitometry and emulsions have been lost. Even if some efforts have been made to create dataset collections and catalogs, very few works are open source and have been published. Starting from this need, different existing databases have been merged to create Photo FiRe<sup>2</sup>. Sensitometric and technical information about films have been added, to provide a set of information as wide as possible.

The original materials on which the database has been built come from three main archives: the Historische Kleinbildfilm Datenbanke (Gschwind 2021), Nicola Mazzanti’s film archive (Mazzanti 2019) and Historical Timeline of Film colors (Flueckiger 2012).

After the analysis and the classification of the films indexed in these datasets, research of additional information about them was made, leading to a collection of film-related files of various kinds. In order to distinguish the different films, an alphanumeric code has been developed, which allowed their unique identification.

<b>Table name</b>	<b>Table content</b>
<b>Film</b>	List of films with their main features
<b>Attached Files</b>	Film-related materials
<b>Additional Material</b>	General information not related to a specific film
<b>Marketing</b>	Materials related to Marketing & Advertising
<b>Source</b>	List of references
<b>Film-Source</b>	Table to make (N, N) relation between Film and Source
<b>Log</b>	To keep a record of the updates

Table 1: List of database tables.

To store all the data collected a relational database has been implemented. It is composed of seven entity-tables (Table 1), five of them store the results of the research (Film, Attached Files, Additional Material, Marketing and Source), the other two are used for the database construction (Film-Source, Log).

The Film table contains a list of technical data (Table 2). The Attached Files table contains technical datasheets and sensitometric graphics useful for defining the qualitative aspects of a film such as exposure, wavelength of the dye used, spatial frequency and spectral density of the dye (Figure 3). All these data are useful to study the sensitometry of a film and to retrieve colorimetric information to perform a correct restoration.

ID code	Identification code of the film (primary key)
<b>ID source</b>	Serial number of the reference in the Table Source (foreign key)
<b>Name</b>	Film name
<b>Brand</b>	Production company
<b>Date</b>	Date of film stock production
<b>Origin</b>	Production country
<b>Photo/Movie</b>	Cinematographic or photographic film
<b>Type</b>	Color or black&white film / positive, negative, reversal film
<b>Principle</b>	Colouring principle
<b>ISO</b>	Film speed
<b>Grain</b>	Film granularity
<b>Latitude</b>	Film exposure latitude
<b>Contrast</b>	Film final contrast
<b>Format</b>	Film format (e.g. 16mm, 35mm)
<b>N° Camera Film</b>	Number if motion picture camera film
<b>Soundtrack</b>	Film with or without soundtrack
<b>Use</b>	General information about film use
<b>Update</b>	Date of the last update

Table 2: List of Film attributes.

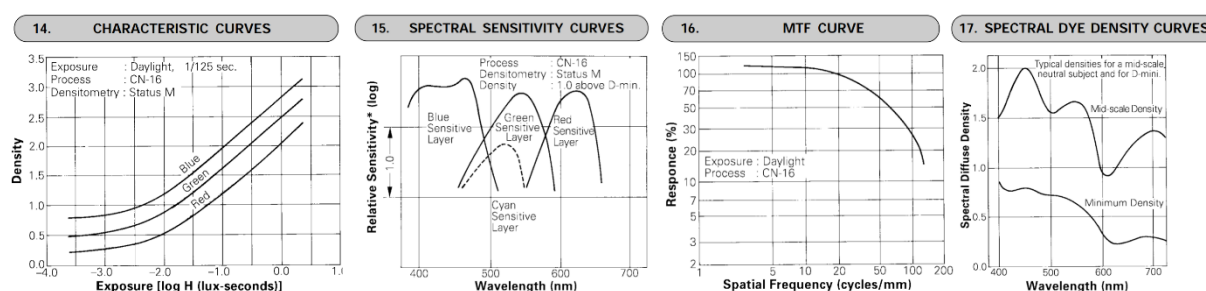

Figure 3: Example of sensitometric graphics of Fujicolor Superia 100.

To make this dataset accessible to the community, a website has been developed. It is available both in English and Italian and its structure is presented in Figure 4.

The Archive section is the backbone of the website: it is connected to the database and allows the users to explore the archive and look for information.

The possibility of involving other subjects in the research and creation of the archive is underlined in the Help us section, which is dedicated to anyone in possession of material useful to enrich the database: collaboration is very simple and takes place through a form compilation. There is always a control procedure for submitted material prior to publication.

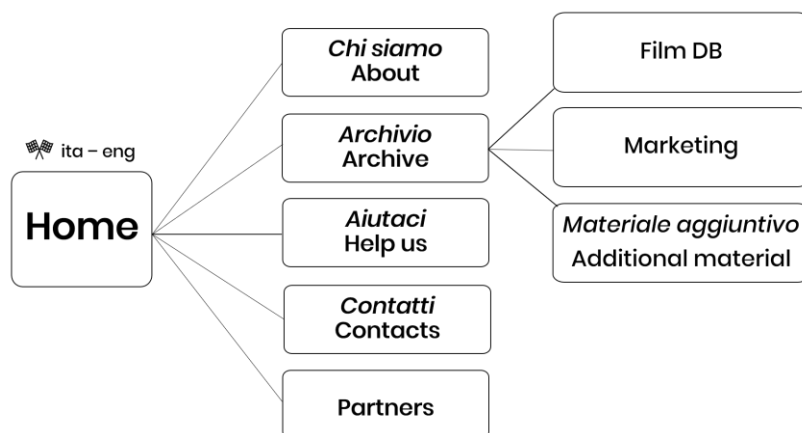

Figure 4: Website structure.

## CONCLUSION

In this work we have presented the motivation behind the creation of FiRe<sup>2</sup>, a large technical database that collects historical, technical, physical and sensitometric data of different photographic and cinematographic film materials.

This work intends to raise awareness of the need for retrieving and acquiring scientific data among conservators, restorers, and film professionals. Analyze, investigate, and comprehend the chemical and physical composition of films is crucial to properly conserve the film and obtain a faithful reconstruction for digital restoration.

Finally, the creation of this preliminary website aims to give a point of access for information sharing between experts, restorers and researchers.

## REFERENCES

- Flueckiger, B. 2012. *Timeline of Historical Film Colors*. 2012. <https://filmcolors.org/>.
- Gschwind, R. 2021. *Historische Kleinbildfilm Datenbank*. 2021. <http://www.bilderdienst.ch/node/3>.
- Gschwind, R., and F. Frey. 1997. Digital Reconstruction of Faded Color Photographs. In: *Extrait de La Revue Informatique et Statistique Dans Les Sciences Humaines XXXIII*. Université de Liège.
- Mazzanti, N. 2019. *Cinema Colors, Now and Then*. 2019. <https://coloursymposium.org/cinema-colors-now-and-then/>.
- Misek, R. 2010. *Chromatic Cinema: A History of Screen Color*. John Wiley & Sons.
- Pierotti, F. 2012. *La seduzione dello spettro. Una storia culturale del colore nel cinema*. Recco, Genova: Le Mani.
- Read, P. 2009. "Unnatural Colours": An Introduction to Colouring Techniques in Silent Era Movies. *Film History* 21 (1): 7-46.
- Rizzi, A., L. Gatti, B. Kránicz, and A. Jerry Berolo. 2008. A Mixed Perceptual and Physical-Chemical Approach for the Restoration of Faded Positive Films. *Conference on Colour in Graphics, Imaging, and Vision* 2008 (1): 292-95.
- Rogers, D. 2007. *The Chemistry of Photography: From Classical to Digital Technologies*. Royal Society of Chemistry.

**SPECIAL SESSION**  
**ALL THE RECENT BOOKS ON COLOR**

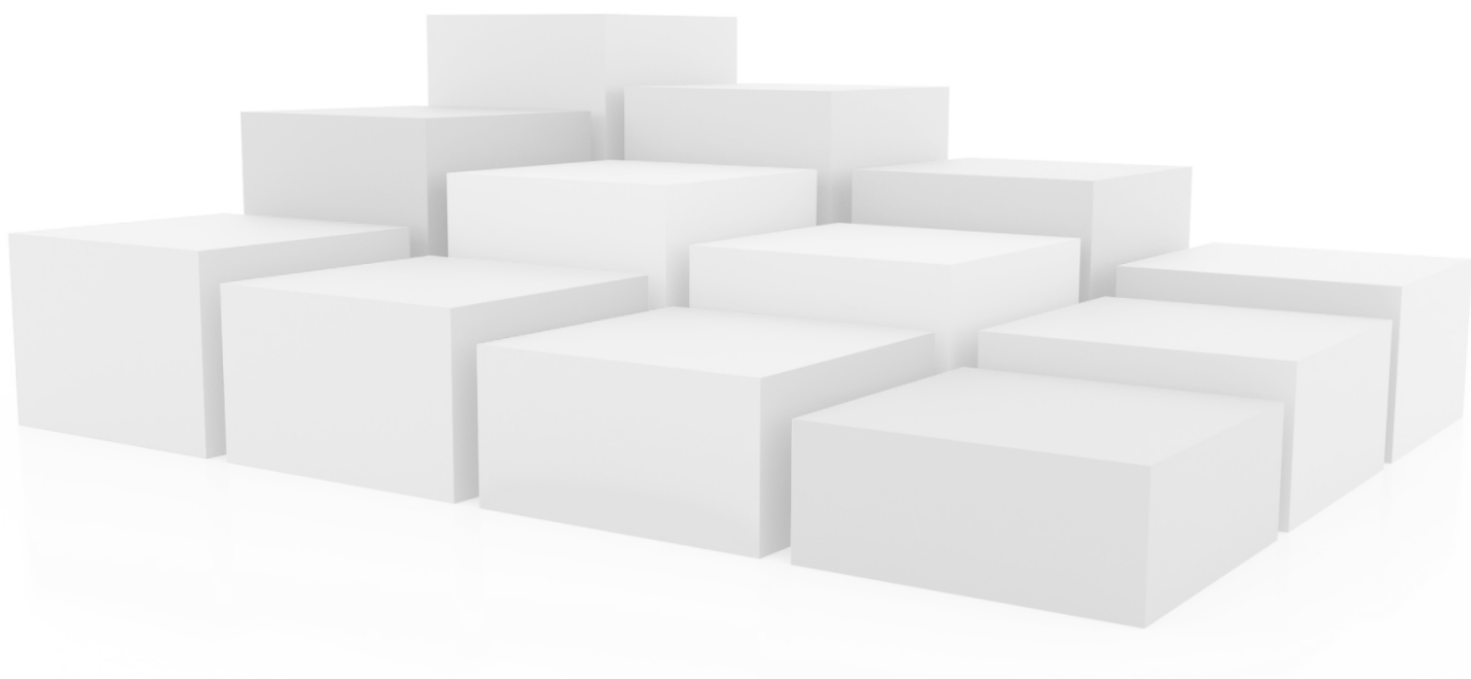

AIC 14<sup>th</sup> Congress Milano 2021 - August 30<sup>th</sup>– September 3<sup>rd</sup> 2021



# Colour: Urban Space, Architecture, and Design

Maria João Durão <sup>1,2,\*</sup>

<sup>1</sup> Faculdade de Arquitectura da Universidade de Lisboa; Laboratório da Cor / Grupo de Investigação de Cor e Luz | CIAUD - Centro de Investigação de Arquitectura, Urbanismo e Design, Universidade de Lisboa

<sup>2</sup> Associação Portuguesa da Cor, Lisboa; mariajoaodurao@gmail.com

\* Corresponding author: mariajoaodurao@gmail.com

## Abstract

Colour: Urban Space, Architecture, and Design is a bilingual publication on colour-in two separate volumes- with an international scientific committee of researchers, which aims to disseminate the research undertaken in the multidisciplinary area of colour. This book celebrates the existing collaboration between APCOR - Portuguese Colour Association and the Lisbon School of Architecture – Ulisboa’s colour research structures: Colour Lab and Colour and Light Research Group.

**Keywords:** *Colour, Urban Space, Architecture, Design*

## INTRODUCTION

Studies carried out at the Lisbon School of Architecture - U Lisboia have been guided by developments in knowledge of colour phenomena and the practical and sustainable use of their results in the environment. From the embryonic stage, it has been fully recognized that colour is ubiquitous in nature and always present in our experience, consciously or unconsciously. The earth, the sea, the sky, the cosmos have colour in their constitutive elements that animals and humans seek to interpret and use, both in material and virtual reality for cognitive, aesthetic, symbolic, cultural, civilisational, psychological, spiritual and epistemological effects. The chromatic substance itself exists in the animal, mineral and vegetable kingdom. Even where there is no light, underwater animals have adapted to produce light and colour and to recognise them in order to survive. It is not surprising, therefore, that colour is the subject of study in a wide range of fields: fine arts, terrestrial and aerospace architecture, urban planning, cinema, theater, virtual reality, lighting, light, product design, communication design, fashion design, textiles, paints and pigments, ceramics, physiology, neurophysiology, biology, vision, ergonomics, chemistry, psychology, history, symbology, aesthetics, phenomenology, sociology, anthropology, linguistics, marketing, advertising, geography, colorimetry, webdesign, nanotechnology, material technologies, audiovisual technologies as well as multiple other applications in art, science and technology.

The Lisbon School of Architecture – at one time belonging to the Technical University of Lisbon – was a worldwide pioneer in creating the Masters Degree in ‘Colour in Architecture’. This embryonic beginning was followed by the development of connecting organs for colour research in the same environment of interest. As it spiraled and radiated outwards, it was followed by the Portuguese Colour Association – a member of the International Colour Association (2003), the Colour Laboratory (2004), and the Colour and Light Research Group integrated in CIAUD (Research Centre of Architecture, Urbanism and Design) of the Lisbon School of Architecture – U Lisboia (2016).

While, in its initial phase, research was part of the Masters Degree in ‘Colour in Architecture’ modules, it later involved the wider community in doctoral and post-doctoral projects, initially in the area of pedagogy. Currently, the Lisbon School of Architecture has academic, entrepreneurial, industrial and other research projects – national and international – hosted in three organisations along with pedagogical input in undergraduate, Masters’, doctoral and postdoctoral programmes, at the University of Lisbon (U Lisboia) and other universities. The results are disseminated through



teaching and in practical aspects of projects carried out in the three major fields of architecture, arts and design.

### **SYNOPSIS OF ARTICLES**

This book begins with João Pernão's article "Teaching Light and Colour in Architecture: Objectives, Methodology and Results", resulting from his fifteen years of teaching Light and Colour at the Lisbon School of Architecture – ULisboa. The processes developed through the practice of preparing colour studies integrated into architectural projects make it possible to define a methodology that ensures coherent and well-founded results. These strategies are designed to interest and motivate architecture students to use colour and are developed in three distinct parts – Deconstruction, Construction and Application of Concepts –, with a multidisciplinary theoretical framework and a practical component in which students use the projects they develop within the Project Laboratory Course Unit. Furthermore, the existing architecture consultancy established through protocols between the Lisbon School of Architecture and various external entities, has opened up the interrelationship between theory, teaching and practice, and proved to be enriching in its pedagogical dynamics.

Contextualised in her doctoral project in Design, "Care for the Façade, Care for the City: Participatory Painting in Buenos Aires", Verónica Conte discusses three interventions made on residential façades in this capital that supported research on the participatory and creative processes of architectural façade transformation. Along with the motivating agents of the projects, the local population debated the choice and acceptance of façades as well as colour proposals that were presented to them. The research brings together interviews with actors and users, focusing on wall painting interventions that transform the city's image and encourage individual and popular expression, singularisation and revitalisation of public space, as well as the development of ties between participants. Cultural traits are thereby explored, memories are recovered and new place identities are created, especially for local communities. The study highlights the painting process itself, as it reveals civic engagement and responsibility and inspires other design processes.

"Colour in Social Housing: Routes of Discovery", by Cristina Pinheiro, recognises the importance of colour as a decisive factor in improving the urban environment by affecting people's well-being and influencing behaviour and emotional balance. The research project shows that the application of colour must be conscientious, have criteria that underlie it, and be guided by scientific knowledge-based principles. The Masters in Colour in Architecture dissertation that was the basis for this article, answers questions such as what the criteria and fundamentals used by the designers are, when deciding on the colours to use and in the execution of colour plans; if colour choices were integrated into the conceptual phase of the projects and what principles have guided their application in the social neighborhoods of Lisbon. The outcomes of the research indicate that colour can and should have a positive influence on users, increasing their self-esteem and contributing to their social and emotional integration.

Included in her Masters in 'Colour in Architecture' dissertation, Helena Soares chooses the theme "Porto: Harmonies and Chromatic Memories in the City". She adopts a methodology aligned with that used by Jean-Philippe Lenclos, and presents an experience of approximation between the built environment and the concept of 'place'. Highlighting the chromatic memories and chromatic symbolic values, Porto is revealed in three representative periods of its urban and architectural evolution. Thus, centred on the chromatic qualities of architecture, an analysis of visual space identifies the elements that influence the formation of defining images that constitute the character of place. These architectural elements led to chromatic syntheses of the environments, respecting the attributes of

colour and the relations of chromatic contrasts. The aesthetic quality of the place was gauged from synoptic tables, and the intervention of three observation scales – global perception, elemental perception and detail perception – within a framework of historical, cultural and aesthetic data.

“Bairro Alto: Chromatic Proposal”, by Filipa Santos and Zélia Simões presents a case study on the phenomenon of colour and light in Bairro Alto - a historical nucleus in the city of Lisbon. The study developed within a curricular unit of the Masters in Colour in Architecture, circumscribes some streets and lanes and analyses the relationship between them and the exterior of the neighborhood: Rua da Rosa, Rua Diário de Notícias, Rua da Atalaia, Rua das Gáveas and the Travessa da Queimada. Based on the theoretical and methodological foundations of Jean Philippe Lenclos, Dominique Lenclos and Antal Nemcsics, the contextualisation of the place integrates historical, aesthetic, social and functional points of view and safeguards regional and geographical identities. The inventory and determination of frequencies and chromatic values in the urban and architectural space produced a series of considerations as well as the creation of a palette that was graphically tested on a standard street. The results of the study highlight the importance of adopting an interdisciplinary light and colour planning methodology for the environmental space, through the recognition and establishment of harmonious relationships.

“Colour in the City: Symbolic and Environmental Qualities”, by Rui Barreiros Duarte, addresses the symbolic and environmental qualities of colour in the city, in a text about sets of place variables and conditions of colour use that interact with conceptual determinants established from cultural anthropology, cultural or acculturation typologies, markets, taste and sensibility. Phenomenology, semiology, and sociology intersect the purely physical perspective of the city and architecture. It is concluded that the meaning, the incidence and the influence exerted by colours depend on phenomenological, cultural and perceptual relations. In order to understand the use of colour in the city, concepts of identity, new myths and new ideologies, the architectural thinking underlying aesthetic discourse and the symbolism codified in the appropriacy of colour and light materials and technologies are also important.

Maria João Durão’s “Atmospheres of Mystical Beauty in the Work of Barragán” focuses on the chromatic atmospheres in Luís Barragán’s architectural work. His architecture is saturated with the colours of Mexico, in a mystical attempt to reconstruct an earthly Paradise, where the human being is in communion with nature, and thus attains serenity of mind, in the face of the mystery of insecure ontological existence. In Barragán’s work, mystical beauty results from the sensitive interconnection of the personal and collective memories of the ancestral, mythical and ritualised environments of pre-Hispanic architecture. Atmospheres are accessed at the level of the mysterious and the dreamlike, whose metaphysical qualities continue the ancestry of tradition and collective memories, which Barragán accepted in order to transmute them into his unique and timeless work.

Sarah Frances Dias’s “The Colours of Eternity in Islamic Art and Architecture” deals with relationships between light, geometry and colour as agents of transcending worldly boundaries for the consciousness of the divine and spiritual dimensions. As in nature, light is only fully revealed through geometry and colour: geometry is the structure by which light manifests and colour is the essence that materialises intangible beauty in sacred spaces through symbolic, metaphysical and spiritual meanings. The article provides examples to show that colours, geometry, and light are not just three indivisible essences, but are the essential means by which Islamic spirituality physically manifests itself as transcendence.

Margarida Gamito and Joana Sousa’s “New Chromatic Planning Methodology for Street Furniture” explores the application of colour in street furniture, according to a chromatic methodology that

highlights the surroundings, through improved readability, identification and orientation in cities. The assessment of the methodology is made by focus groups composed of locals of different ages and genders, colour application specialists, municipal technical officers, architects, urban planners, equipment designers, landscape architects, and engineers. The results serve to encourage a more rigorous approach to colour plans for street furniture and contribute to the identification of city colours.

Ultimately, we welcome achievements of this nature as they always bring contributions to the science of colour and its careful use, as well as its beneficial effects on the improvement of urban space and development of architecture, design and the arts. Equally, they are an incentive for new studies to emerge, and update and develop information.

### **EDITORIAL, SCIENTIFIC AND DESIGN COMMITTEES**

*Editor:* Maria João Durão.

*Guest Editor:* Fernando Moreira da Silva.

*Editorial Committee:* Filipa Santos | Simone Maffei Simacek | Verónica Conte | Zélia Simões.

*Scientific Committee:* Annamaria di Cara – Design Centre Enmore, Sydney Tafe | Byron Mikellides – The School of Architecture, Oxford Brookes University | Carl Jennings – University of Hawaii, Kapiolani | Diana Soeiro – Faculdade de Ciências Sociais e Humanas, Universidade Nova de Lisboa | Fernando Moreira da Silva – Faculdade de Arquitectura, Universidade de Lisboa | Joaquim Santos – Universidade Lusíada de Lisboa | Jose Luis Caivano – Facultad de Arquitectura, Diseño y Urbanismo, Universidad de Buenos Aires | Mário Kong – Faculdade de Arquitetura, Universidade de Lisboa | Natacha Antão Moutinho – Escola de Arquitetura, Universidade do Minho | Nuno Alão – Faculdade de Arquitetura, Universidade de Lisboa | Pedro George – Faculdade de Arquitetura, Universidade de Lisboa | Ralf Weber – Technische Universität Dresden | Robert Hirschler – SENAI Centro de Tecnologia da Indústria Química e Têxtil | Simone Maffei Simacek – UNISO, Universidade de Sorocaba | Stephen Westland – University of Leeds | Valter Cardim – IADE, Universidade Europeia.

*Graphic Design:* Filipa Santos | Helena Soares.

### **ACKNOWLEDGEMENTS**

We thank Professor Fernando Moreira da Silva for the fruitful cooperation between the APCOR - Portuguese Colour Association, the Colour and Light Research Group, and ColourLab – Lisbon School of Architecture, ULisboa. We acknowledge the joint efforts of the researchers and organisations involved in the making of this book.

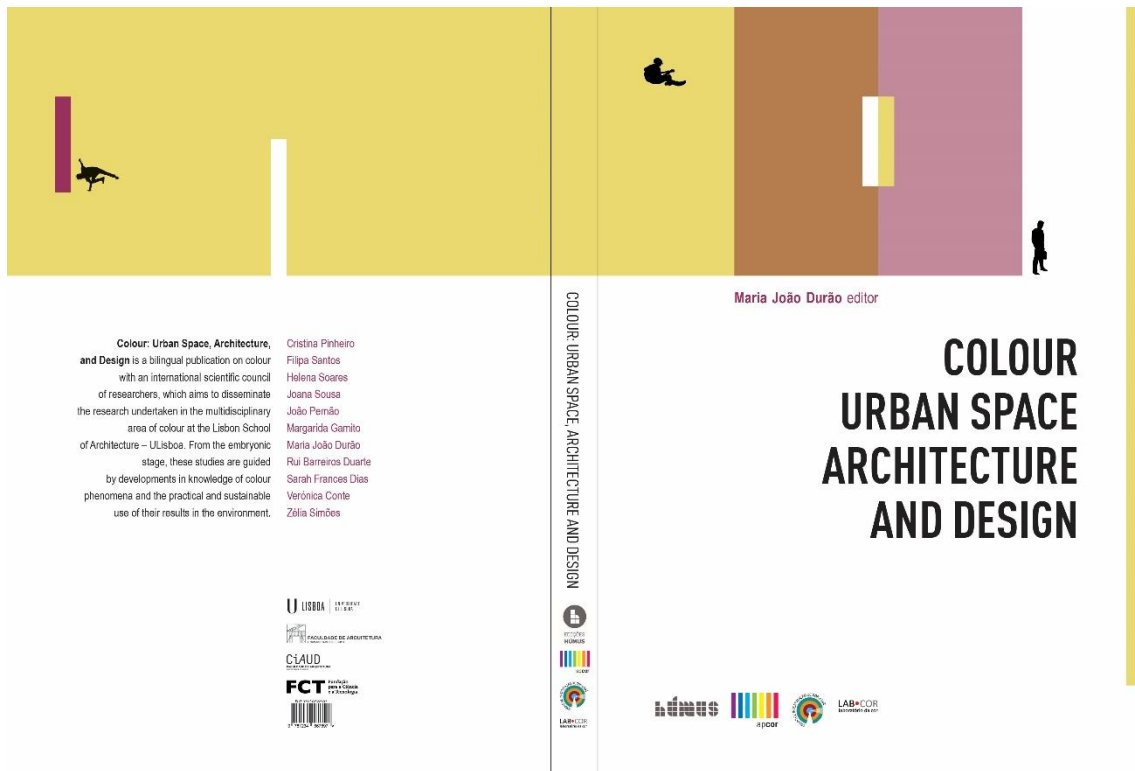

Figure 1: Book cover-English version.

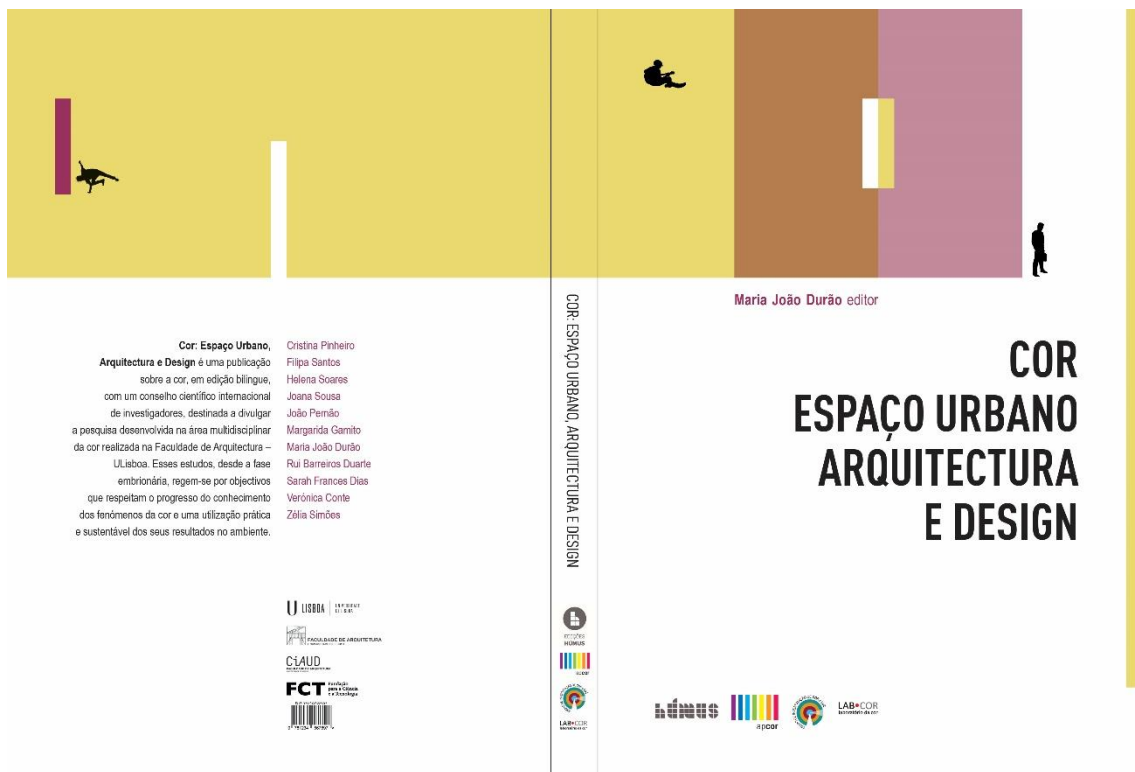

Figure 2: Book cover-Portuguese version.



# The Sense of Color: An introduction to the book

Jodi L. Sandford <sup>1,\*</sup>

<sup>1</sup> University of Perugia; jodi.sandford@unipg.it

\* Corresponding author: jodi.sandford@unipg.it

## Abstract

The aim here is to introduce the book “The Sense of Color: A Cognitive Linguistic analysis of color words” that brings together my research in color semantics conducted within the cognitive linguistic paradigm concentrating on the linguistic representation of conceptual structure. It unravels this approach to the analysis of the color frame as it emerges in English. Stress is put on the aspects of embodiment, cognitive operations, and conceptualization of COLOR and SEEING terms. It presents a model specifying the primary conceptual metaphors and metonymies, with the complex that works together to structure our usage of color/seeing terms in natural language. The model includes COLOR as a source domain yielding SEEING IS COLOR, COLOR as a target domain yielding COLOR IS A LOCATION, COLOR IS AN OBJECT, etc., and color metonymy: COLOR ATTRIBUTE IS ACCESS FOR COLOR ENTITY. It further elaborates on color in grammatical functions and specific linguistic constructions the book illustrates in each section.

**Keywords:** *cognitive linguistics, cognitive semantics, conceptual color metaphor, conceptual color metonymy, linguistic embodiment*

## INTRODUCTION

The sense of color refers both to the meaning of color and to our perception mode of color. When we are born, though we really cannot consciously remember it, one of our first experiences is seeing light filtered through our eyelids. We probably already have had a sense of lightness and darkness, and maybe even color, before being born. This could be in part why vision is so predominant in our understanding of the world around us. When we open our eyes, we see, if there is light. When we close our eyes, it is dark. In the same way, when we wake up we see if there is light or not. It is a primary experience. We connect this sensory experience to a series of correlating sensations and observations. We can better understand what something is, what is happening, and whether it is good or bad, if it is in the light and can be seen clearly. The distance of the object we have chosen to pay attention to will also affect how well we can see it. The object we see may reflect more or less light. It may be more or less colored. It may be more or less textured. It may be holding still or in movement. We use all this information by combining our visual experience with our other senses to understand and categorize our experience of the object. We may smell something in relation to it, or be able to touch it. We may even taste it, or the object/event may make or cause a sound.

This book concentrates on the linguistic representation of conceptual structure in our experience of vision and color and how it evolves in language. Color, as we all know, is a major part of our primary experience as human beings. The faculty of vision and the physical properties of color represent a universal process, as does language. This book illustrates some of the universal aspects of the experience, while it discusses only one language, English, specifically. Cognitive Linguistics furnishes the approach for this linguistic analysis of “seeing” and “color”, and the vocabulary and concepts we use to talk about objects and experiences as the basis of our cognition of any given thing.

The aim is threefold. First of all, it is to illustrate how a single linguistic frame may be analyzed through the Cognitive Linguistic approach. Second, my aim is not only to reveal the method of analysis, but also to make available information on the sensory domain of SEEING and COLOR for linguists, while illustrating aspects of the approach, and specifying some of the appropriate theoretical terminology.

Third, the goal is to divulge the linguistic approach to color for colorists and color specialists, who often know the psychological or physical aspects of color appearance, color contrast, and color preference, but are not fully aware of color semantics. In other words, the purpose of this text should be to describe the semantics of 'SEEING and COLOR' words to color specialists, or people interested in different aspects of color, and at the same time to illustrate how Cognitive Linguistics may be used to analyze a linguistic frame such as 'SEEING and COLOR', for those who are interested especially in linguistics or in understanding what linguistics may deal with.

The information presented in this volume has been drawn from my publications and past research, which I specify; including work presented at AIC and Gruppo del Colore conferences. Although each scientific theory is backed with bibliographical references in the book, I do not use space to identify each of them here. The essential framework I would like to stress in "The Sense of Color" is:

- Color is the combination of two systems (light and substance), which at a basic level correspond to the same basic color terms of human physiology, and constitute the same basic (semi)universal color terms. That is, the couples BLACK-WHITE, RED-GREEN, and YELLOW-BLUE correspond to what is recognized as the receptor cell types in our vision process. They further correspond with the combination of sensations that therein form the eleven basic color terms used most frequently in English, which further include: GREY, BROWN, PURPLE, PINK, and ORANGE.
- Embodied motivation of vision language is thus bilateral and allows us to access the positive or negative connotations of each color as dictated by the relations perception/cognition, situation/surround, and figure/ground. Our bodies allow us to process the specific meaning of a color by elaborating all of these aspects beginning with the categorization of light and substance in understanding if the color is as it should be or is it wrong.
- We use the figure-ground relation to access the desired meaning of a color concept. In order to understand what a color term means in a given utterance, we need to know what it is backgrounding or foregrounding. Implicitly we conceptualize the desired objective that the speaker has in mentioning the color and visual attributes of the object or concept s/he are speaking about.
- To varying degrees the eleven basic color terms are salient in conceptual metaphors and metonymies of SEEING. This aspect of color term usage in different domains through the cognitive mechanisms of metaphor and metonymy serve us in developing and establishing the relevant patterns of linguistic reference.
- Perceptual conceptual mappings pattern a cognitive mechanism that accommodates connotations in relation to both conventional and non-conventional object associations and serve us to establish the entrenchment of these meanings on an individual basis.

The book is divided into eleven chapters, one named for each basic color category. Each chapter consists in two key parts: information about single basic color term and a theoretical linguistic specification of color usage. I start by explaining the COLOR and SEEING terms I am interested in analyzing; such as the basic color terms (Kay et al. 2009), and color specifications like light/dark, shiny/matt, bright/dull, and warm/cool. I am keeping them to a limited number, although I am aware that the possibilities are indeed vast. I then move into the linguistic explanation of the color frame and my model of the conceptualization process. Moreover, I illustrate some of the details of linguistic methodology with the objective of allowing each chapter to be read by itself according to what interest the reader may have. Each chapter starts with a couple of color quotes and a generic table of reference

including the etymology of the term and some conventional color object couples to set the scene of the color and how it is may be viewed creatively and philosophically.

The chapters are divided in the following manner. The first three chapters include the general aspects of color that part from the assumptions: Color is that what we see because there is light. Color is a visual sensation. It is perceived, cognized, and categorized before reaching a linguistic form. The color sensation and consequential perception is processed in our mind, through our bodies. We categorize the information and then name it with color words. More specifically, Chapter 1 introduces color terms in general, their evolution, the dimensions of color, and the concept of basicness. The concept of color evolves individually and collectively in a complex and variegated manner through life experience and scientific analysis. The choice of how to 'call' things becomes an experiential cognitive act, which must be conventional. This process of selecting and recognizing a stimulus, perceiving it, feeling the sensation, conceptualizing it, and giving it a name allows us to communicate and to express ourselves through language (Biggam 2012).

Chapter 2 gives a brief explanation of color vision: illustrating the peculiarities of color appearance and color constancy. Color as a pigment or a material is very different from color as light. We can say that color sensations are fewer than the possible spectral combinations. Each class of spectra yields a same color sensation. The same color may appear differently in different circumstances, situations, and contexts.

Chapter 3 presents the concept of color categorization, and how it relates to Vantage Theory and color prototypes (a.o. MacLaury 1995; Rosch 1973). It further mentions Gestalt Theory and its relevance in color identification and interpretation (Evans 2015). Color is an experience. It represents itself and its opposite (or complement). For example, white is positive, pure, innocence, and light. At the same time white is negative, absence, lack of circulation, and death. Whereas black is positive, fertile, deep, but also negative, emptiness, and darkness. Each color is related to our experience of it as a material and as a light, which is often a sort of ying yang relation. Color is universal, all humans ideally have the ability to see color, and at the same time it is culturally significant in that we assign a meaning to color according to how our culture establishes the relation and point of view. Color is crucially omnipresent in our lives, and linguistic discourse on color is in constant revolution. Most importantly, meaning change, and dynamics are motivated. They are not arbitrary.

The next three chapters introduce the Idealized Cognitive Model (ICM) of COLOR that I have developed through my research. Each Chapter has a figure that illustrates the relation of the topic to the ICM of COLOR. It is based on all the different aspects of language in use, such as informant intuition or explicit query responses, and implicit associations, combined with corpora analysis. I discuss our embodied experience of color and how we categorize and conceptualize it in terms of projections or mappings between conceptual domains. The mappings activate the emergence of conceptual metaphors and metonymies.

Elucidating on primary mappings, Chapter 4 discusses Conceptual Metaphor and COLOR METAPHOR as stemming from the metaphor KNOWING IS SEEING, SEEING IS COLOR. I advance that color –*the sense of color*– is a metaphor. By this I mean that color meaning results from the projection of our sensation, to perception, and then to its conception. Color terms are metaphors themselves, because they specify the projection of a sensation domain to the domain of our initial identification process. We map similarities between the abstract domain of color sensation as we perceive it and the concrete domain of our object/situation experience of color. The synaptic firing makes those metaphoric connections, as they fire together they wire together; for example, *red is blood, red is fire, or red is tomato*. We carry out the identification process of categorization, what color category the object belongs to, after having



already mapped the color concept between the domains of color light photons that are received by our retinas to the domain of color substance, which is again another metaphorical cross-domain projection. We could say we project the color input from the domain of color signals to the domain of color symbols. However, if one does not want to consider color a metaphor in itself, it most often becomes metaphorical when we try to communicate the sensation. We use color metaphorically in conventional expressions like *a red fury hit him*. The concept of metaphor is discussed throughout the book involving the correlations, metaphorical conceptual domains, and inference patterns—source and target domains—in the metaphorical sense of color.

Further expanding on the primary mapping, Chapter 5 illustrates Conceptual Metonymy as stemming from COLOR ATTRIBUTE IS ACCESS FOR COLOR ENTITY (Sandford 2014). Metonymy is where a part is used to access a whole, or the whole is used to access a part, or a part for another part. In color terminology metonymy is evident in examples like: *brick red, grass green, sky blue, steel grey, and coal black*. It is particularly relevant to observe both metonymic and metaphoric entailments, their development and variation. The color of the object, its attribute, may become a noun, a verb etc. It may be used to differentiate and describe an event, by calling to attention its color, its lack of color, its intensity, and its lightness. We can see how a color term often assumes a metonymic value in respect to the object that it describes, that is, THE PART FOR THE WHOLE, which in turn may activate a metaphoric meaning. Often a color name makes reference to its use. The color part is named in reference to the whole object: *hand me the red, please*, where *red* is for the object with that color; but in *there was red all over my test papers*, the *red* metonymy is also used to metaphorically express error.

Chapter 6 in turn goes back to more general overarching aspects and clarifies the role Cognitive Linguistics, Embodiment, and Conceptual Integration have in metaphor and metonymy (see Evans 2015). Cognitive Linguistics is based on Embodiment Theory (see Gibbs 2005). It considers the common body structure and cognitive dimensions as the fundamental basis or constraints through which we comprehend, express ourselves, and understand each other. Clearly our mind reflects the experiences, the patterns, and the possibilities of the human body. The human body is virtually identical for all individuals and is responsible for the creation and limits of the common range of potential experiences. The individual physical body comes into contact with the world. Through it the processes of categorization guarantee a degree of translatability and comparison between one linguistic system and another. Color informs us and moves us.

Chapters 7 and 8 discuss more detailed aspects of SEEING/COLOR and Embodiment of Lightness and Darkness, Positivity and Negativity, as they emerge in metaphoric realization. The fundamental idea this book aims to illustrate is how conceptual metaphors and metonymies are motivated through the embodiment of our visual experience which, as mentioned, includes both light—an optical factor that comes from a source, autoluminant—and substance—a factor of pigment that is of a reflecting surface, non-autoluminant (by autoluminant I mean something that lights up or gives off light by itself). This antagonistic duality between the two basic modes is embodied and reflected in our ability to tie color to both positive and negative associations (Sandford 2009, 2011, 2012, 2017, 2018).

Chapter 9 discusses the grammatical forms and constructions COLOR takes on to illustrate how the EVENT STRUCTURE METAPHOR develops a dual sub-system metaphor of COLOR as a LOCATION, e.g., “in red” or “went blue”; and as COLOR as a POSSESSION, e.g., “has red and white” or “got the blues”. After distinguishing the primary metaphors and the complex metaphor combinations with COLOR as a source domain, the next part of the cognitive model of color involves COLOR as a target domain, with the two major metaphor systems. The systems, discussed in Chapter 5, include the GREAT CHAIN OF BEING used to conceptualize *things* (see Lakoff and Turner 1989: Chapter 4) and the EVENT STRUCTURE METAPHOR

that captures the conceptualization of *relations* (see Kövecses 2010: Chapter 11). Each system serves to develop COLOR as a target domain, indicating that COLOR is the concept that is being understood through other sources. Cognitive patterns, STATES ARE LOCATIONS and ATTRIBUTES ARE POSSESSIONS, emerge in the metaphors that combine respectively with CHANGE IS MOTION and CAUSES ARE FORCES to form a dual EVENT STRUCTURE system.

Chapter 10 explains how semantics and the construction of meaning is elaborated through Image Schemas, attention, memory, and salience. The four basic instances of cognitive processes, or construal operations that are activated during linguistic activity include Attention, Judgement, Perspective, and Constitution (I follow Croft and Cruse 2004 for this breakdown of cognitive operations). Color represents an excellent example of these cognitive operations, which brings us to Specific-Level Metaphors that comprise PERCEPTS ARE ENTITIES, IDEAS ARE OBJECTS, LIGHT IS SUBSTANCE, COLORS ARE ENTITIES; that relate back specifically to Color Metonymy. The integration of all of these aspects together is what allows us to select and remember according to the pertinence what color the entity must have, and has, and consequently how to evaluate the association.

Chapter 11 concludes with an overview of the ICM of COLOR, and argues that we use color in language to actually say that we have seen what we are talking about. We have had experience of it, and hence we can be believed (Sandford 2010). Moreover, it discusses how color represents a primary embodied experience, a primary experiential frame, or a minimal concept. It is fundamental notion that we apply to understand the characterization of more complex structures. It is representative of image schematic ception (see Talmy 2000), or better, the passage from sensation to perception, through cognition, to linguistic elaboration of the conceptual structure. In other words, humans use color terms to describe things because it is one of the basic types of sensory information available to interpret and interact in our surrounds.

Summarizing, the objective of this book is to consider the various aspects of color and how they relate to three primary grades of metaphorical conceptualization: color itself, color terminology, and metonymic and metaphorical use of color terms. It explores how colors serve as a link to our sensory motor experiences, and activate specific elements in our cognitive models. Color is dynamic in its relation to the objects and associations made online while interpreting linguistic information. The idea of color is in some sense objective and subjective, and yet neither the objectivist nor the subjectivist tradition resolves the color enigma. I argue, in keeping with the Cognitive Linguistic approach, that the experientialist point of view disproves theoretical objectivism and subjectivism (see among others Croft and Cruse 2004; Evans 2015; Gibbs 2005; Johnson 2008; Kövecses 2010; Lakoff 1990; Lakoff and Johnson 1980, 1999; Talmy 2000). Experientialism responds well to the paradox of color and metaphor. Seeing and color, therefore, allow us to perceive, perception allows for experience, and conception allows for understanding. The question remains if we perceive the same thing when we name a color and agree on its name. Most likely, we are agreeing on what to call our personal perception that corresponds to another's personal perception. Yet no matter what the preference or ability, we use language to identify a sensation and conceive of a way to call it. It is this process of linguistically conceptualizing the sensation of seeing that I would like to illustrate. I would like to propose how we conceptualize visual input, and how we use experience to stand for a series of meanings.

## **ACKNOWLEDGEMENTS**

The research for this publication has been supported by 2018 – 2020 distributed research funds from the University of Perugia.

**REFERENCES**

- Croft, W., and D.A. Cruse. 2004. *Cognitive Linguistics*. Cambridge: Cambridge University Press.
- Biggam, C.P. 2012. *The Semantics of Colour*. Cambridge: Cambridge University Press.
- Evans, V. 2015. *The Crucible of Language*. Cambridge: Cambridge University Press.
- Gibbs, R.W., Jr. 2005. *Embodiment and Cognitive Science*. Cambridge: Cambridge University Press.
- Johnson, M. 2008. *The Meaning of the Body: Aesthetics of human understanding*. Chicago: University of Chicago Press.
- Kay, P., B. Berlin, L. Maffi, W. Merrifield, and R. Cook. 2009. *The World Color Survey. CSLI Lecture Notes 159*. Stanford, California: CSLI Publications.
- Kövecses, Z. 2010 [2002]. *Metaphor: A practical introduction*. Oxford: Oxford University Press.
- Lakoff, G. 1990 [1987]. *Women, Fire and Dangerous Things, What Categories Reveal about the Mind*. Chicago: The University of Chicago Press.
- Lakoff, G., and M. Johnson. 1980. *Metaphors We Live By*. Chicago: The University of Chicago Press.
- Lakoff, G., and M. Johnson. 1999. *Philosophy in the Flesh*. New York: Basic Books.
- Lakoff, G., and M. Turner. 1989. *More than Cool Reason*. Chicago: The University of Chicago Press.
- MacLaury, R.E. 1995. Vantage Theory. J. Taylor and R. MacLaury (eds.), *Language and the Cognitive Construal of the World*. J. 231–276. Berlin: Mouton de Gruyter.
- Rosch, E. 1973. *Natural Categories*. *Cognitive Psychology* 4, 328-350.
- Sandford, J. L. 2009. Seeing is color: The sky is blue. D. Smith, P. Green-Armytage, M. A. Pope, et al. (eds.), *Proceedings of the 11th Congress of the International Color Association, AIC 2009*. 1-4. Sydney: Colour Society of Australia.
- Sandford, J. L. 2010. I can tell you what color it is. M. Bertucelli Papi and F. J. Ruiz de Mendoza Ibáñez (eds.), *Cognition and the brain in language and linguistics. Textus* 23 (3): 719-735. Genova: Tilgher
- Sandford, J. L. 2011. Cool, warm, dark, light, or afterimage: dimensions and connotations of conceptual color metaphor/metonym. C. P. Biggam, C. A. Hough, C. J. Kay, et al. (eds.), *New directions in Colour Studies*. 205-218. Amsterdam: John Benjamins.
- Sandford, J. L. 2012. *Red Clover: Linguaggio e percezione dei colori: uno studio cognitivo applicato alla lingua inglese*. Rome: Aracne Editrice.
- Sandford, J. L. 2014. Her blue eyes are red. An idealized cognitive model of conceptual color metonymy in English. W. Anderson, C. P. Biggam, C. A. Hough, and C. J. Kay (eds.), *Colour Studies: A broad spectrum*. 109-125. Amsterdam: John Benjamins.
- Sandford, J. L. 2017. You are the color of my life: Impact of the positivity bias on figurativity in English. A. Baicchi and A. Bagasheva (eds.), *Figurative language we live by: The cognitive underpinnings and mechanisms of figurativity in language: Textus* 30 (1), 223-239.
- Sandford, J. L. 2018. Methodological Approaches and Semantic Construal of the Seeing Domain in English. A. Baicchi, R. Dignonnet, and J. L. Sandford (eds.), *Sensory Perceptions in Language, Embodiment, and Epistemology, Studies in Applied Philosophy, Epistemology and Rational Ethics*. 42: 111-132. Switzerland: Springer.
- Talmy, L. 2003a [2000]. *Toward a cognitive semantics*. Vol. 1 and 2. Cambridge, MA: MIT Press.

# Publications: The International Scientific Conference of the Color Society of Russia

Verena M. Schindler <sup>1,3,\*</sup> and Yulia A. Griber <sup>2,3</sup>

<sup>1</sup> Art and Architectural Historian, Zollikon, Switzerland; ecd.studygroup@yahoo.com

<sup>2</sup> Smolensk State University, Smolensk, Russia; y.griber@gmail.com

<sup>3</sup> Co-Chair of the AIC Study Group on Environmental Colour Design

\* Corresponding authors: ecd.studygroup@yahoo.com ; y.griber@gmail.com

## Abstract

This review includes four publications stemming from the International Scientific Conference of the Color Society of Russia, RUcolor2020, held online 1–5 December 2020. Two publications contain Russian and English contributions: *The International Scientific Conference of the Color Society of Russia: Book of Abstracts* (Smolensk: Smolensk State University Press, 2020), and *The International Scientific Conference of the Color Society of Russia: Selected Papers* (Smolensk: Smolensk State University Press, 2021). Two additional publications, *The Scientific Notes of the Color Society of Russia* (Vol. 2, 2020, a special issue on color design for the elderly) and *Sociological Studies* (1;3, 2020, a special issue for young scientists and students), further include nineteen papers written in Russian or translated from English. In total 182 authors from twenty-seven countries and seventeen regions of the Russian Federation presented their research findings at RUcolor2020 and published their papers in these books.

**Keywords:** *psychology of color, sociology of color, color in communication, color in art and design, color in science and technology*

## INTRODUCTION

This paper presents four publications resulting from the International Scientific Conference of the Color Society of Russia, RUcolor2020, held online 1–5 December 2020 (Figure 1).



Figure 1: Covers of the four publications stemming from the International Scientific Conference of the Color Society of Russia held in December 2020.

Participation was free to all conference attendees, becoming one of the largest international scientific events of the year in Russia. In total 182 authors from twenty-seven countries and seventeen regions of the Russian Federation presented their state-of-the-art color research and new research findings at the international RUcolor2020 conference (Figure 2). Fifty-two renowned color experts from twenty-two countries, members of the RUcolor2020 Scientific Committee, have rigorously peer-

reviewed both the submitted abstracts and the full papers. All contributions have been revised and carefully edited to ensure the highest standards throughout.

The contributions reflect the research results carried out in the fields of psychology of color, sociology of color, color in communication, color in art and design, and color in science and technology.

RUcolor2020 was jointly organized by the AIC Study Group on Environmental Colour Design, Smolensk State University, Research and Education Center “Color Lab”, the Institute of Scientific Information for Social Sciences of the Russian Academy of Sciences, and, the Moscow Soglasie publishing company. We are very excited to have the opportunity to present the four publications at the AIC2021 Congress.

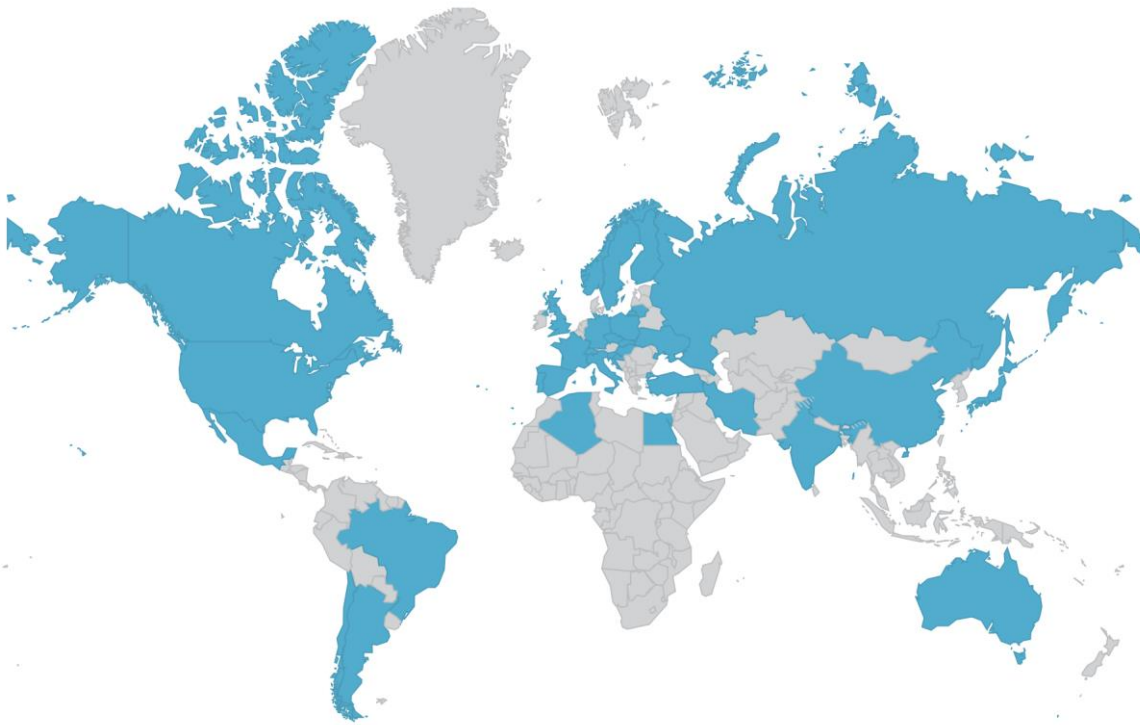

Figure 2: Geography of authors' provenience of the International Scientific Conference of the Color Society of Russia publications.

## **BOOK REVIEW**

### **The International Scientific Conference of the Color Society of Russia: Book of Abstracts (Smolensk: Smolensk State University Press, 2020)**

The publication, *Book of Abstracts*, includes 110 contributions divided into three parts: (1) Invited talks; (2) Oral presentations in Russian; and, (3) Oral presentations in English.

The first part of *Book of Abstracts* includes all sixteen invited speaker abstracts published in both Russian and English. The invited speakers represent seven different countries: *Enrique del Acebo Ibáñez* and *José Luis Caivano* from Argentina, *Jean-Philippe Lenclos* from France, *Axel Buether* from Germany, *Balaganapathi Devarakonda* from India, *Yuriy Burykin*, *Andrey Efimov*, *Vladimir Kagansky*, *Olga Lavrenova*, *Natalya Panova*, *Nicolay Serov*, and *Mikhail Shishin* from Russia, *Juan Serra* from Spain, and, *Domicile Jonauskaitė* and *VMS* (co-author of this paper) from Switzerland.

The second part contains forty-four abstracts in Russian written by authors from seventeen regions of the Russian Federation as well as from Belarus (*Tatyana Sivova*), India (*Tyagi Ruchi*), Poland (*Kristina Vorontzova*), Ukraine (*Boris Bazyma*, *Mikhail Krasikov*, *Svitlana Pryshchenko*, and *Yulia Romanenkova*), and the USA (*James W. Mantet*).

The third and final part incorporates fifty abstracts in English from twenty-five different countries: Argentina, Australia, Brazil, Chile, China, Croatia, Czech Republic, Egypt, France, Germany, Iran, Italy, Lithuania, Mexico, Poland, Portugal, Russia, Serbia, Slovakia, Spain, Sweden, Switzerland, Turkey, United Kingdom, and the USA.

### **The International Scientific Conference of the Color Society of Russia: Selected Papers (Smolensk: Smolensk State University Press, 2021)**

The publication, *Selected Papers*, includes a total of fifty papers, with fourteen in Russian and thirty-six in English.

A key feature of the Russian contributions is the shift of focus from the relationship between color and individual perception and experience—traditionally studied within the framework of the humanities—to the relationship between color and society (see e.g., the paper “Colors of the revolution” by *Igor Krasilnikov*), the analysis of the social differentiation of color codes in different cultures (“Color symbolism in the South Indian Kathakali Theater” by *Tatyana Kartashova*, “Color in the traditional Ukrainian folk culture” by *Mikhail Krasikov*), and the identification of the relationship between the structure of color space and social structures (see e.g., paper “Color representations of different professions by young people” by *Faina and Sergey Kremen*).

Another group of studies in Russian presented in the book is devoted to color symbolism (“The associative potential of color symbols” by *Elena Solovyova*, “Environmental motifs in the stage clothing design” by *Rimma Fatkullina et al.*, “The role of color symbolism in Oscar Wilde’s Drama ‘Salomé’” by *Vladislav Shalaev and Yulia Marinina*), linguistics of color (“Color concept in the floristic space of Konstantin G. Paustovsky’s prose” by *Tatyana Sivova*) and color education (“Coloristics in an architectural school” by *Natalya Panova*).

One of the novelties of *Selected Papers* is the Russian translation of papers by renowned color researchers: “The Geography of Colour” by *Jean-Philippe Lenclos*, “Color order systems, color mixtures and the role of cesia” by *José Luis Caivano*, and “Antarctica as the white continent: color, values and magic” by *Enrique del Acebo Ibañez*. As well, it includes the English translation of “The theory of urban color environment” by renowned Russian color designer *Andrey Efimov* who, in 1990, published two volumes resulting from a memorable international color conference he organized in Moscow.

The papers in English are published in the second part of *Selected Papers*.

Some papers deal with color in psychology and sociology such as “Depression to expression: color as visual language to communicate complex emotions” by *Puja Kumar and Carla Lobo*, “Color profiling: a visual archetypal blueprint for the process of Jungian individuation” by *Mark Wentworth* (translated into Russian), “Visual grouping: a study on preponderances of color or shape in match-three games” by *Joyce C. Cavallini and Paula Csillag*, “The construction of the chromatic sign in the Brazilian political and social environments” by *Ítalo José de Medeiros Dantas et al.*, and “Quantifying colors of traditional academic gowns in Spain” by *Manuel Melgosa et al.* Psychology also plays a crucial role in two fascinating analyses: “Color as a visual language: exploring the chromatic palette in Suzan Pitt’s animation” by *Elizaveta Kushnirenko*, and “Color as a narrative tool in the tale ‘The Yellow Wallpaper’ by Charlotte Perkins Gilman: a discursive semiotics analysis” by *Ítalo José de Medeiros Dantas et al.*

A paper deals with color in communication and includes an interesting analysis of color in brand design: “Color as a distinctive quality in visual identity: analysis of dominant color in brand identity in relation to the perception of the recipient” by *Carlos Esteban Prause*.

Color education has become an important part of research in determining, defining and translating color terms (“Basic parameters for color education: a proposition of concepts on color theory for Brazilian elementary and middle schools” by *Milena Quattrer and Anna Paula Silva Gouveia*), developing color courses for people with different backgrounds (“Color as a way of communication in design education” by *Banu Manav*, and “The role of color training in industrial environments” *Xavière Ollier et al.*), exploring new teaching methods (“A colour is worth a thousand words! A colour-based tool to foster communication in culturally-plural teams” by *Ingrid Calvo Ivanovic and Francesca Mattioli*), and introducing recent technology (“Augmented reality in interactive color experience: commemorating Bauhaus 100” by *María Marta Mariconde et al.*, and “Rethinking the role of technologies in teaching colour design” by *Galya McLellan*).

Another captivating paper shows that restoration techniques of films have been substantially developing in recent years: “The colors of ‘Toute Une Nuit’: a study of color restoration in film” by *Arianna Brivio et al.*

Papers relating to color in the built environment reveal fundamental insights and constant elements (“Color tectonics: enhancing and modifying form and space with color” by *Galen Minah*), an analytical approach to a specific cultural context and standing (“The use of color in spaces central to social life in contemporary residential housing in Recife, Brazil” by *Gisele Melo de Carvalho and Camila Brito da Cruz*), a specific context (“The philosophy of colour in the French period of environmental colour design” by the authors of this paper), and how new technological means are used to differently perceive an urban landscape (“Technology in the walk: experiential reading of color of urban landscape” by *María Marta Mariconde et al.*). Another strength of *Selected Papers* is the insight that researchers and designers deal with color in very different ways, forming art and science in an entangled pair. One such interesting approach is “Beyond hue: the affective response to value and chroma” by *Ellen Divers*.

Research and analysis recurrently focus on one single color such as in “Color as a sign in minimalist architecture” by *Dragana Vasilski*, “Phenomenon of white in contemporary architecture, art and design in Europe and Russia” by *Alena Grigorash and Davide Bossi*, “Yellow color in European architecture and the built environment: traditions and contemporary applications” by *Justyna Tarajko-Kowalska* (Figure 3, right), and “Blue in Alentejo: authenticity and sustainability” by *Ana Paula Pinheiro and Rui Duarte*.

Enlightening insights also include ancient cultures: “Analytical study of pigments (colors) of the Wildlife Scene at Ra-shepses Burial Chamber (Saqqara, Egypt)” by *Ashraf Youssef Ewais*, and “The impact of Spanish colonization on color semiotics and worldview in Prehispanic Mexico” by *Tania Eréndeni Fuentes Villa and Claudia Ayari Fuentes Villa*.

Striking artistic and philosophical cross-cultural inquiries are manifest in “Colour: extensive and intensive approaches” by *Rui Grazina and Fernando Moreira da Silva*.

The interaction of color and light has become a topical subject matter and is discussed from different points of view: “Using coloured lights in physical and immersive VR environments as material for design” by *Marjan Kooroshnia and Jan Tepe* (Figure 3, left), “Unveiling the potentials of colored light in relation to other sensory stimuli for atmosphere design” by *Eglė Prokopavičiūtė*, and “Unique experiential benefits that multispectral lighting may provide” by *Markus Reisinger*.



Papers relating to color in science and technology explore a specific building material (“Surface quality evaluation in cementitious mixtures: the grey color of mortars and concretes from a qualitative-quantitative point of view” by *Anahí López and Alejandro R. Di Sarli*), natural dyes (“Analysis of natural dyes color characteristics: subjective vs. objective” by *Martina Ira Glogar et al.*), ultraviolet radiation effects (“Effect of illuminant UV component on colorimetric attributes of eco-friendly dyed wool yarns” by *Razieh Jafari and Kamaladin Gharanjig*), scaling of brownness (“Characterization of the full-scale of browning degrees in liquid food models” by *Lorena Sofía Pepa et al.*), the calibration of computer-aided design systems (“A practical procedure for obtaining calibrated material colors for CAD Systems” by *Gianluca Guarini and Maurizio Rossi*), and the monitors’ quality (“A color performance comparison of LCD and CRT monitors: considering black offset, white point, and linearity” by *Mahdi Safi et al.*)

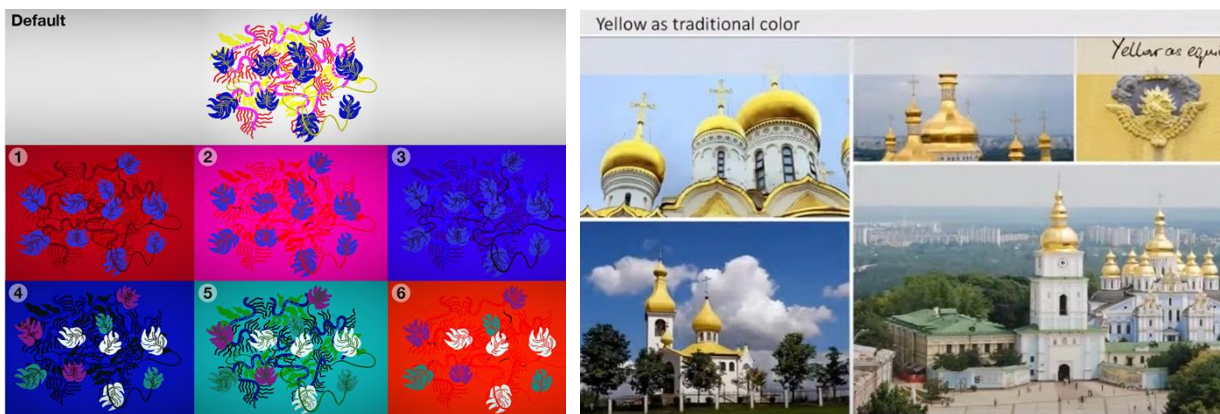

Figure 3: The image to the left shows design patterns that appear differently depending on the colored light used (Kooroshnia and Tepe); To the right, yellow is also discussed as a traditional color equivalent to gold (Tarajko-Kowalska).

The electronic version of *Selected Papers* includes an Appendix containing abstracts of thirty-six books on color published in the last five years by conference participants and presented at RUcolor2020 during a special book session.

### ***The Scientific Notes of the Color Society of Russia, Vol. 2, 2020, a special issue on color design for the elderly***

Volume 2 of *The Scientific Notes of the Color Society of Russia* includes ten contributions in Russian focused on color design for the elderly.

Half of the papers have been translated from English in order to introduce the most advanced research findings in the field to a wide range of Russian readers: the results of research projects on the application of color and light effects in intensive care units by *Axel Buether* (DE) and on interior colors for senior housing by *Juan Serra, Ana Torres, and Jorge Llopis* (ES); experimental research on color design in healthcare institutions by *Silvia Cejpková and Andrea Urland* (SK); a case study of color for packaging and brand identity of Brazilian medicines based on documentary research by *Silva Camila Assis Peres and Rebeca Fernandes Leal* (BR); and, UV protective properties of cotton material dyed with cochineal dyestuff by *Ana Sutlović, Martina Ira Glogar, and Anita Tarbuk* (HR).

In their contributions Russian researchers present the results of the use of computer stabilometrics in assessing the postural stability of a person in the visual perception of color information (*Yuriy Burykin*), the exploration of color characteristics of “flat” design and its perception by elderly people (*Aleksandra Pankratova*), the analysis of the specifics of how people of different ages interact with



color (*Nicolay Serov*), the exploration of different levels of vision and comprehension of color phenomena (*Leonid Tchertov*), and the use of color contrast in the choice of LED radiation spectral characteristics for operating rooms (*Margarita Shumskaya, Vladimir Snetkov, and Nikolay Eliseev*).

### **Sociological Studies, 1(3), 2020**

This special issue of *Sociological Studies* for young scientists and students includes nine papers written in Russian.

Papers by BA, MA and PhD students discuss a wide range of issues relating to the theory and practice of color in design. The authors analyze color symbolism (*Lubov Kulemina*), healing properties of color (*Darya Zakharova*), and the importance of color in nutrition and its influence on human well-being, activity, and mood (*Sofya Apkaeva and Victorya Voloshko*). They discuss Russian students' emotional responses to color (*Yulia Kovaleva, Maria Drozdova, and Daria Orlova*), as well as color influence on civil servants (*Svetlana Kuzmenkova*), on TV audience (*Darya Leshchenkova*), and on the perception and memorization of information by elderly people (*Olga Filatenkova*). The issue also contains a research review of color categorization published over the past fifteen years in Google Scholar, eLIBRARY.RU and CyberLeninka databases (*Alyona Nankevich*), and an analysis of the experience of using color in design of the electronic glossary of conservation terms for wall paintings and architectural surfaces «EwaGlos» (*Karina Tsygankova and Alexey Delov*).

### **CONCLUSIONS**

The RUcolor2020 books bring together a wealth of topics that reflect the scope of work being undertaken within color theory and color research.

All four publications were sent free of charge to professional, scientific and educational institutions. Electronic versions of the four publications are freely available online at the website of the Scientific and Education Center "Color Lab" (<http://www.color-lab.org/publikacii/>).

### **ACKNOWLEDGEMENT**

The RUcolor2020 conference was funded by the Presidential Grant Foundation, which helped to create an amazing platform for sharing and discussing color research findings from around the world.

### **REFERENCES**

- Griber, Y. A., and V. M. Schindler, eds. 2020. *The International Scientific Conference of the Color Society of Russia: Book of Abstract*. Smolensk: Smolensk State University Press, 186 p. ISBN 978-5-88018-656-3 (Russian/English), [http://color-lab.org/files/283/boa\\_rucolor2020\\_with0.pdf](http://color-lab.org/files/283/boa_rucolor2020_with0.pdf).
- Griber, Y. A., and V. M. Schindler, eds. 2021. *The International Scientific Conference of the Color Society of Russia: Selected Papers*. Smolensk: Smolensk State University Press, 332 p. ISBN 978-5-88018-660-0 (Russian/English), [http://color-lab.org/files/283/bop\\_rucolor2020\\_with0.pdf](http://color-lab.org/files/283/bop_rucolor2020_with0.pdf).
- Griber, Y. A., and V. M. Schindler, eds. 2020. *The Scientific Notes of the Color Society of Russia. Volume II: The International Scientific Conference of the Color Society of Russia: Selected Papers*. Smolensk: Smolensk State University Press, 102 p. ISBN 978-5-88018-642-6 ISSN 2712-987X (Russian), [http://color-lab.org/files/283/sn\\_2020\\_2\\_compressed0.pdf](http://color-lab.org/files/283/sn_2020_2_compressed0.pdf).
- Griber, Y. A., and V. M. Schindler, eds. 2020. *Sociological Studies, 1(3). Special Issue: The International Scientific Conference of the Color Society of Russia*. Smolensk: Smolensk State University Press, 60 p. ISBN 978-5-88018-615-0 (Russian), [http://color-lab.org/files/283/ss\\_2020\\_1-3-\\_with-cover.pdf](http://color-lab.org/files/283/ss_2020_1-3-_with-cover.pdf).

## **SPECIAL SESSION**

# **COLOUR, LIGHT & SOUND: HOLISTIC APPROACH FOR WELLBEING**

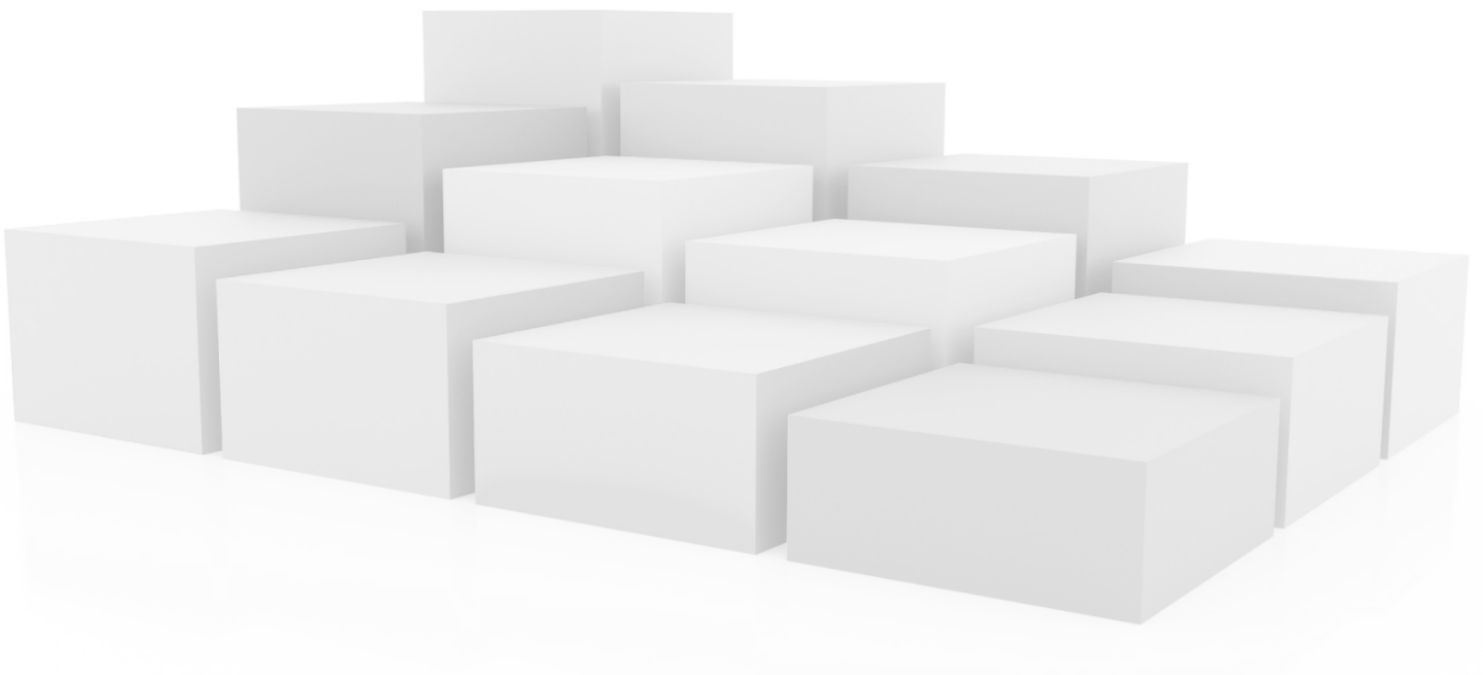

AIC 14<sup>th</sup> Congress Milano 2021 - August 30<sup>th</sup>– September 3<sup>rd</sup> 2021



# Colour as a coaching tool with Colournostics

Mary Ashby-Green <sup>1,\*</sup> and Thelma van der Werff <sup>1</sup>

<sup>1</sup> Creators of Colournostics; m.ashbygreen@gmail.com, thelma@colournostics.com

\* Corresponding author: m.ashbygreen@gmail.com, thelma@colournostics.com

## Abstract

Colournostics is a unique self-empowerment tool that combines Neuro-Linguistic Programming (NLP) and colour psychology to enable you to articulate your concerns, identify the barriers that prevent you from overcoming them, visualise how you would feel if your problems were solved, and empower you with a plan to get you to that point.

The method, based on NLP and the psychology of colour, removes the blockages from your subconscious mind. The development of this method, by Thelma van der Werff and Mary Ashby-Green, took 5 years and was tested with thousands of people, after which it was designed in the colourful 'process board'. Colournostics has been developed in such a way that your clients (and/or you) can leave behind long-lasting patterns, get clear insight and answers so that a positive change can take place. The Colournostics method can be applied in different ways and you can follow the different modules that suit your way of working and integrate them seamlessly in coaching sessions.

**Keywords:** *colour, individual coaching, perspective, shift*

## INTRODUCTION

Colournostics is a unique self-empowerment tool that combines Neuro-Linguistic Programming (NLP) and colour psychology to enable you to articulate your concerns, identify the barriers that prevent you from overcoming them, visualise how you would feel if your problems were solved, and empower you with a plan to get you to that point.

The method, based on NLP and the psychology of colour, removes the blockages from your subconscious mind. The development of this method, by Thelma van der Werff and Mary Ashby-Green, took 5 years and was tested with thousands of people, after which it was designed in the colourful 'process board'. Colournostics has been developed in such a way that your clients (and/or you) can leave behind long-lasting patterns, get clear insight and answers so that a positive change can take place. The Colournostics method can be applied in different ways and you can follow the different modules that suit your way of working and integrate them seamlessly in coaching sessions.

Colournostics is a unique self-empowerment tool that combines Neuro-Linguistic Programming (NLP) and colour psychology to enable you to articulate your concerns, identify the barriers that prevent you from overcoming them, visualise how you would feel if your problems were solved, and empower you with a plan to get you to that point.

The method, based on NLP and the psychology of colour, removes the blockages from your subconscious mind. The development of this method, by Thelma van der Werff and Mary Ashby-Green, took 5 years and was tested with thousands of people, after which it was designed in the colourful 'process board'. Colournostics has been developed in such a way that your clients (and/or you) can leave behind long-lasting patterns, get clear insight and answers so that a positive change can take place. The Colournostics method can be applied in different ways and you can follow the different modules that suit your way of working and integrate them seamlessly in coaching sessions.

## SIMPLE, PRACTICAL & EASY-TO-USE

Much like a board game in design, Colournostics, in reality, is a platform that enables you to literally lay your problems out on the table in front of you. You then follow the step-by-step process to release the subconscious thoughts, feelings and beliefs that are holding you back, so that you experience a sense of freedom, light-heartedness, and confidence.

### **WHO USES COLOURNOSTICS?**

- Life coaches
- Counsellors
- Therapists
- Business Coaches
- Teachers
- Career Consultants
- Tutors
- Mindfulness teachers
- Yoga teachers
- Web designers
- Massage Therapists

### **HOW DOES IT WORK?**

The process of Colournostics comes from the techniques we use with our clients in our professional practices. It is designed as a simple 5 step process -but don't be fooled, as it is harnessing the power of colour and the precision of NLP. You can use it to solve problems, or set goals for yourself or your clients. These problems can range from relationship issues, challenges at work, worries about something or someone, money concerns, or to improve your performance in exams, or sports.

Once you've established the issue you want to focus on, you go through the five simple questions, relating it to the issue. Rather than replying in words to each question, you instead select one of the 19 colours that seem to best represent your answer. For every colour chosen, you then refer to the 150-page guide book that outlines the meanings of each colour at every stage of the process. Every colour has many hidden meanings, and you won't necessarily identify with all of them. It may just be one 'aha' statement that unlocks deeply buried feelings or beliefs that enables you to move forward to the next part of the process.

The Colournostics process can be applied in different ways, and in all applications we use the language of colour to not only reveal the inner conflict that is blocking someone from moving forward but also to provide insight to solve the issue, and also change inner dialogue.

Colournostics can be used to identify the emotional origin of physical symptoms, and at the same time change negative inner dialogue to a supportive empowering inner dialogue, bringing emotional harmony where physical symptoms can simply disappear.

The Colournostics Vision Board is another application of this methodology, where instead of using images, the chosen colours and related statements provide clarity and focus.

Colournostics enables the client to tap into their subconscious because it connects the image of colour to their emotions, thereby bypassing logical and rational type of thinking that has kept the person stuck in their problem. It is not until these subconscious thoughts and feelings are brought to the surface into the conscious mind, that permanent changes can be made.

[www.colournostics.com](http://www.colournostics.com)



Figure 1.



# Photonic Medicine, the therapeutic use of light and colors in Medicine

Pascal Vidal <sup>1,\*</sup>

<sup>1</sup> Institute of Photonomedicine, Chateauvieux-les-Fossés, France; pascalv62@yahoo.com

\* Corresponding author: pascalv62@yahoo.com

## Abstract

Photonic Medicine, a medical diagnostic and therapeutic method founded by Professor Pierre Magnin (†), uses photonic application, first to the pinna (reflex microsystem discovered by Dr Paul Nogier) and then to the corresponding somatic areas, always under strict neuro-vegetative control, through the VAS perception. Results in some relevant cases will first be shown, prior to a brief overview of this method.

**Keywords:** *pinna, photon, VAS (Vascular Autonomic Signal), limbic system*

## A/ CLINICAL CASES

### 1/ Case of very serious trauma (Professor P. Magnin)

In September 2009, a forty-year-old man of athletic build fractured his vertebral column at the pelvis during a failed hang-gliding landing.



Figure 1: Lumbar spine condition of this patient just after surgery.



The result of this was paraplegia with “horse tail” (cauda equina) syndrome. The debris from L3 were taken out by anterior surgical approach. The patient was then treated exclusively by photonic intervention, after the implantation of lumbar “Tecorps” and bone screw material (see photo above). The patient was catheterised.

In April 2011, the commentary of the surgeon was as follows: “The patient presents most importantly with bladder sphincter sequelae with difficult micturation necessitating regular monitoring of the bladder; there persist erectile issues and residual paresthesia of the lower left limb. These problems, which are going to endure, require 100% medical care because it concerns handicapping after effects of lingering spinal cord trauma.

In July 2012, the patient was well. He was regularly followed up and controlled by photonic therapy which normalised the residual problems. He has resumed his professional activities (cabinet-maker and carpenter).

## **2/ Case of peritono-pleural and juxta hepatic omental mesothelioma (Professor Pierre Magnin)**

The patient was a Vietnamese born in 1932. He had contracted peritono-pleural and juxta hepatic omental mesothelioma in 2001. He was hospitalised in 2002 for assessment and surgical intervention. The lesions were so extensive, multiple and diffuse that the surgeon closed up the incision without attempting to do whatever might have been possible.

The patient was transferred to Oncology. A course of chemotherapy was begun in February 2002 (Cisplatine), and continued until August that year. I demanded the treatment be stopped. The patient was dying, cadaverous, prostrate, bed-ridden, and had stopped eating. He had uraemia and his liver tests were extremely negative. The doctors consider him lost and advised pain-killing medication and palliative care.

With his consent I then tried photonic medicine treatment. From the end of August 2002, all other therapy was abandoned. The patient would be treated at the rate of one session weekly in two parts:

- for diagnosis and treatment under VAS control;
- for local colour treatment under VAS control in sufficient quantity through light pulsed on the intestinal areas, liver, and right pleura.

In two months, the patient gained weight, strength and a normal life. I attributed this spectacular turnaround to the abandonment of chemotherapy, but expected a relapse as time passed (VAS assessment on the pathological points was not good)

However, the improvement continued. The symptoms eased, and the VAS also. As of the time of writing, the patient was well, he got around, and lived normally. I was unable to obtain his consent for new investigations. He no longer wanted to hear talk of such matters.

I knew through the VAS emissions that he was not cured. The pathological signs persisted, but much decreased. The VAS was a trifling matter then. I can say nothing else. I saw him each week and we “counted” the VAS reactions as it concerned a score. He registered no relapse nor any additional pathology except a spike of ascites in July 2003 which was drained by a medical friend of mine.

Before his illness the patient weighed 50 kilos. At the end of the chemotherapy two and a half years later he had fallen to 30 kgs. At the time of writing, he was at 45 kgs. Our colleague treated him every week, each time for one to two hours. The patient never felt bad.

What to think of this observation? Inevitably, a tenet of modern medicine advances in this case the possibility of delayed action of the chemotherapy. Likewise, we all know of exceptional cases of an unexplained survival in this type of illness. An inventive mind would put forward the hypothesis of

the action of coloured frequencies to stabilise the development of the tumoral process. As for the surgeon who operated on the patient, he did not understand because, for him “he should have been dead a long time ago!”

### **3/ Case of a lung cancer recurrence (Dr. P. Vidal)**

A 71-year-old woman having as notable precedents hypertension and hypercholesterolemia treated by her general practitioner. After an episode of diverticulitis in January 2009, she had an abdomino-pelvic CT scan which by good fortune discovered bilateral pulmonary nodules. Following the advice of a pulmonologist and a three-month course of antibiotics, a check CT scan was done which showed no evolution and calcification of the two earlier discovered nodules, but also the suspiciously appearing presence of a third nodule of more than 10mm under the left pleura.

In 2010 she underwent a lower left lobectomy which confirmed the diagnosis: early broncho-pulmonary adeno-carcinoma, for which she received chemotherapy by gemcitabine and cisplatin, then carboplatin was introduced.

In April 2011 a new 25mm<sup>3</sup> low back left nodule, appeared, which when checked in September 2011, had augmented in volume to a highly suspect 125mm<sup>3</sup>. A thoracic CT examination was scheduled for January 2012 to decide on possible intervention if the ganglion had continued to grow.

The patient was seen in October 2011, and thence once a week she was administered photonic treatment under VAS control, with auricular and local thoracic work. Over the course of these sessions, the VAS of points of entry and exit, of the hypothalamus and the left pulmonary zone gradually diminished.

During her end of January check-up, the nodule had regressed, and returned to being barely visible. She is currently receiving follow-up care about once every two months, and it is to be remarked that to this day there has been no perceptible return of pulmonary tumoral activity.

### **4/ Case of a COVID 19 patient with sequellar lesions of the lungs (Dr Pascal Vidal)**

Patient born in 1967, suffering from migraine, high blood pressure and obesity, with hypercholesterolemia and oedemas of lower limbs. She got COVID 19 in early February 2021, with anosmia and agueusia, fever, dyspnoea. Confirmed by a PCR test she was treated with Azithromycine and Zinc.

Dyspnoea and chest tightness have since worsened, especially on brisk walking, despite good oxygen saturation measured on oximeter...

A CT scan on 19/2 showed: Several discrete ground glass opacities, mainly peripheral in topography, not sparing any lobe, slightly predominant in the upper lobes, with a minimum involvement of about 10% of the lung volume. No associated alveolar condensation or signs of fibrosis.

After 3 photonic treatments performed in June, and breathing exercises shown for a daily performance, a control CT Scan is done in early June. Its conclusion is: ““Complete disappearance of the discrete ground glass opacities that were visible in all the lobes at the peripheral level. No evidence of scarring pulmonary fibrosis. No other pulmonary parenchymal features. Restitution ad integrum with complete regression of signs of Covid 19 lung disease”.

## ***B/ PHOTONIC MEDICINE: A BRIEF OVERVIEW***

Tightly controlled by the autonomic nervous system, Photonic Medicine is a medical technique used in both diagnosis and treatment. At the therapeutic level it represents direct harnessing of the

physics of medicine. It is not about responding to disturbing and energy-consuming stimulation, but rather, bringing positive invigouration by using light's energy<sup>1</sup> and enriching the body's own energy (Magnin et al. 2016)

Let us look briefly at what Photonic Medicine consists of, how we practise it, what the modes of action are, and the significance for us of the ear pinna, the auricular points and the phases.

First a history is taken and a detailed clinical evaluation done by the medical physician to gather information needed to make a pre-diagnosis. Following this, we proceed to an in-depth examination of the ear pinna by projecting light of various colours via an optic fibre. Throughout this process the pulse is continuously monitored to determine which point and which colour will trigger VAS (Vascular Autonomic Signal), which is counted until its eventual fading out (Magnin 2010; Magnin et al. 2016).

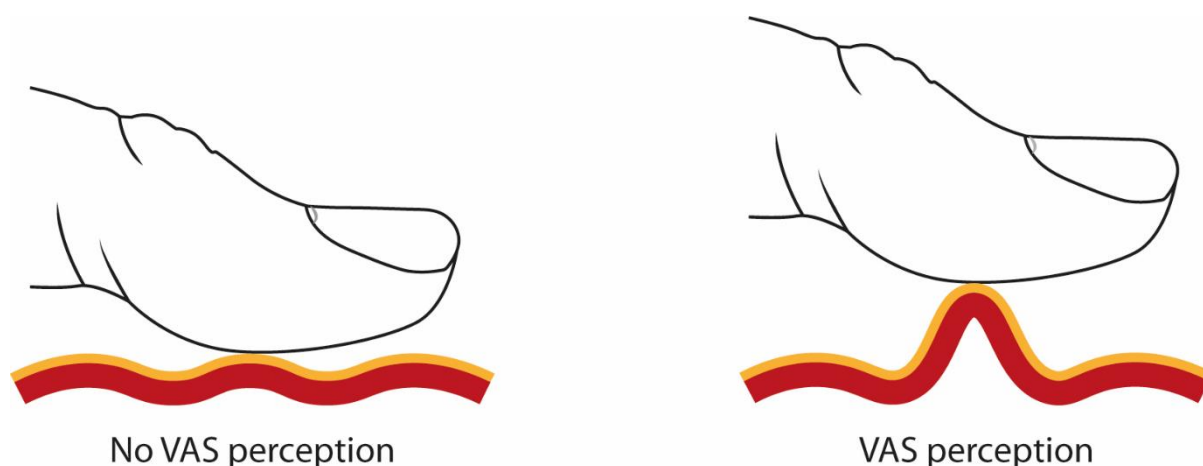

Figure 2: The Vascular Autonomic Signal (VAS)

*The exploration of the pinna is basic because the auricle is an outward aspect of the brain, and from both anatomical and functional viewpoints allows us to question the brain, and to work with it (this door, once open, gives access to cerebral sensibilities). To consciously explore the pinna allows the interrogation<sup>2</sup> of the brain – which has given its consent to the pathology – and its involvement in the healing process. The use of the sympathetic arterial reflex allows the detection, identification, and localisation of the points and zones of pathological tissue disturbances, and to ensure control of the therapeutic photon activity.*

This method is as applicable to the pinna, interface of the limbic system, as it is to patients' bodies.

The pinna exploration always begins with Green 53<sup>3</sup>, followed by the presentation of other colours<sup>4</sup> in the zones where Green 53 has detected some VAS response. The reactions thus discovered by the presentation of different colours<sup>5</sup> allow the characterisation of the response, and the gathering of an amount of information from which the answers to the following questions can be determined:

- identification of the trouble
- Its place (we use the auricular charts of Dr Paul Nogier as reference (Nogier 1977))

<sup>1</sup> According to  $E = h \cdot \nu$  (where E is the energy, h the Planck's constant and  $\nu$  the electromagnetic frequency).

<sup>2</sup> A rough comparison could be made with a computer mouse and keyboard giving access to the hard disc, analysing the content and eventually modifying it.

<sup>3</sup> From the Wratten-Kodak colour chart.

<sup>4</sup> Magnin et al. (2016).

<sup>5</sup> Professor Pierre Magnin has described several physiological, metabolic and tissular properties to each colour used in this diagnostic and therapeutic method.

- its importance or lack thereof.

From this a diagnosis can be confirmed or rejected, and screening done: it tells us the number of pathologies involved, but more, identifies clinically silent symptoms which can be thus treated and disappear before they manifest. And if this is the case, these “pre-pathologies” can be investigated by allopathic medical means (ultrasound, X-ray, blood tests, etc.) Additionally, beyond the diagnosis, this exploration provides us a complete “landscape” of the patient, and of the long- and short-term implications of the pathology.

The pinna will then be used for a treatment not only of the apparent trouble, but also of its cause. Colours are successively maintained on an ear point from the moment a VAS reaction is triggered until that response is extinguished, indicating a return to normal functioning, or state of balance.

Treating the pinna is thus an indispensable prerequisite to any other action, because it is also the way of ensuring central nervous system participation in the healing process, and in reestablishment of health. The *loco dolenti*, place of pain, is then treated with the same sequence of colours that was used on the ear in order to bring about a brain-body reconnection.

In certain cases, to support at a central level the action at the periphery of the body, Dr. Wilder Penfield’s homunculus - where body areas are represented in the brain - can serve to guide the placement of colour light.<sup>3</sup>

What makes this method effective is that it seeks out the cause of a pathology, identifies the ways in which this may show up in the tissues, and brings harmony through the therapeutic application of photons.

The limbic system represents the central and functional structure of the brain through which, towards the cortex, pass all sensing and sensory information. These informations are classified, analysed, indexed according to already memorised criteria, and given priority or dismissed. It allows the cortical zones to play their roles of integrating reconnaissance, of sensing, and of applying remembered knowledge. These brain regions can induce the actions and reactions best adapted to functional harmony of the individual. The key limbic structures therefore represent the functional centres indispensable for the integration of information for a living being.

This brain area, which is situated on the lower edge of the encephalon, constitutes an anatomical complex which brings together the systems of encoding information. In a functional and operational situation, it takes for remembering, the adaptation of instincts, attitudes, behaviours and the reflexes on which they depend, the instinctive or reactional mechanisms.

From this perspective it is not absurd to consider the pinna as the indirect anatomical and outward manifestation of the limbic brain. In this case, the exteriorised evolution represents the radar system of which the brain has need, as well as the relational interface between the limbic system and the whole body.

This tissue relation interpretation is the only way to explain the proven empirical reality of the ear point correlations with stressed or dysfunctional tissues or organs.

*The limbic system plays an incontestable role in the practice of photonic emissions, because, thanks to the VAS, the central integration and yet separate distribution of which throughout the entire organism to the most hidden parts, puts at our disposal the understanding and the use of a signals of alert or alarm.*

*The pinna can be considered as an information vehicle revealing the limbic system, and may thus in some regard be thought of as a «snapshot» of this system. The pinna does not offer the investigator points or projections of body areas, but zones relative to where lesions have introduced*

*functional disturbances, or where lesions are causing slowing down of activity or of autonomic system adaptations. This approach, at the second remove from somatic and autonomic tissular events, supposes, even demands, a relay phase which can play an essential role of receptor-emitter but also the integration of information. This relay step seems to be mediated by a specific cerebral area, the limbic diencephalon<sup>6</sup>. These images, "snapshots" are thus the analogue projections of possible or eventual limbic representations.*

For us, *the auricular points are not projections of organs but the expressive manifestations (or expressions) of organs in the context of the limbic system.* All form of stimulation of the pinna and notably of the conch, the part of the ear surrounding the opening, by the nature of its protective covering, translates as a limbic system response. Photonic Medicine is not a reflex therapy. *It is an energetic therapy.* It reveals the response of a living organism to an energetic injection, via photonic stimulation.

*In the case of photonic usage, the colour exploration of the ear according to the different usable frequencies, corresponds to an identification of both a threat and of the nature of disturbances, thereby clearly showing the interruption of electromagnetic interaction, both tissular and cellular. It is all about an examination much broader in scale and over time, since it can encompass the detection of somatic assault before lesions show up (prevention). Equally, the evolution and/or remission of a disease state can be monitored, ultimately giving the possibility of identifying a recovery, indeed, of healing.*

## **C/ IN CONCLUSION**

We must stress a point of utmost importance - Photonic Medicine bypasses the morbid symptoms and does not limit itself to their disappearance, seeking rather to understand the primary energetic cause of whatever issue there is. Through Photonic Medicine's fundamental characteristic of restoration and reconnection of disturbed electromagnetic energy in tissues suffering chronic assault (Szent-Gyorgyi 1960), and through its external energetic provision, it allows the reestablishment of health thanks to the photons, *agents of homeostatic and thermodynamic regulation* (Magnin 2010), which put the organism back into a state of autonomous functioning.

## **ACKNOWLEDGEMENTS**

Properly acknowledge funding agencies. Also, acknowledge anyone that has assisted with your research and is not listed as a co-author.

## **REFERENCES**

- Magnin, P. 2010. *Des photons et de la Vie*. Montpellier: Sauramps.
- Magnin, P., P. Vidal, and P. Bécu. 2016. *De la chromothérapie à la Médecine Photonique*. Escalquens: Dangles.
- Nogier, P. 1977. *Introduction pratique à l'auriculothérapie*. Paris: Maisonneuve.
- Szent-Gyorgyi, A. 1960. *Introduction to a Submolecular Biology*. New York and London: Academic Press.

---

<sup>6</sup> According to Pr. P. Magnin's hypothesis.

# How the Sensory Systems Impact our Journey Through Life

Pauline Allen <sup>1,\*</sup>, Heather Benghiat <sup>1</sup> and Phil Stickland <sup>1</sup>

<sup>1</sup> The Sound Learning Centre, London, UK; info@thesoundlearningcentre.co.uk

\* Corresponding author: pauline@thesoundlearningcentre.co.uk

## Abstract

Human function is predicated on sensory systems performance. Sensory difficulties are often '*hidden disabilities*' difficult for those '*without them*', to understand those '*with them*'.

Efficient, integrated, systems are needed for optimum function. Disintegrated, inefficient, over-loaded systems are unable to accurately process sensory information affecting performance. Frequently present, in those with learning difficulties, they cause behaviours leading to labels. The '*underlying reasons*' are often poorly recognised, misunderstood, ignored, or attributed to '*behavioural problems*'. Assessments establish baseline function using formal tests or critical observations. Therapies, such as **Lightwave Stimulation (LWS)** - coloured pulsed light to help address light sensitivity and light processing deficiencies, **Auditory Integration Training (AIT)** - to help improve auditory processing and reduce over and under sensitivity to sound, **Neuro-developmental Programme (NDP)** - a sensory integration programme to inhibit Primitive Reflexes enabling Postural Reflexes emergence for development to progress. These therapies help improve social, emotional, behavioural and academic performance.

**Keywords:** Sensory, Processing, Light, Sound, Therapies

## INTRODUCTION

The Sound Learning Centre opened its doors in 1994 and specialises in providing assessments, coloured light therapy, sound therapy and developmental programmes for those with sensory difficulties. Our purpose is providing people with sensory difficulties (which often underlie many learning difficulties) support, information, helpful therapies and hope that we can improve their social, emotional, behavioural or academic performance and that things can get better for them or their loved ones.

### Identifying Sensory Difficulties

Largely our work is with a relatively niche sector of the population, and many of us will know someone who, on some level, has sensory difficulties. We see a lot of children with a variety of conditions such as speech and language difficulties, Dyslexia, Dyspraxia, and Attention Deficit Hyperactivity Disorder. Some are on the Autism spectrum, non-verbal and with quite obvious difficulties. We also see a number of high functioning adults who under perform against their intellectual ability.

Many individuals are able to compensate for sensory difficulties using '*coping mechanisms*'. However, these strategies may come at an emotional, physical or academic cost and be difficult and exhausting to sustain. Additional pressures or responsibilities can mean things reach a tipping point. That's often when people find us.

### How our Sensory Systems Work

Human function is really predicated on how well our sensory systems work for us. If our systems are disintegrated, inefficient and over-loaded, then accurately filtering sensory information can become impaired, affecting our overall performance and wellbeing. We believe it's our job to help identify areas where a child or adult struggles and see how we can help.

Our Assessment establishes how the sensory systems are functioning and where appropriate, we provide coloured light therapy, sound therapy and developmental programmes, to help make a difference. We also provide a unique insight and detailed explanation to those involved. Understanding why we function the way we do, can be very healing and enlightening. Many clients we have worked with didn't realise they have sensory difficulties – they just thought that everyone functioned that way!

### Unusual Sensory Processing

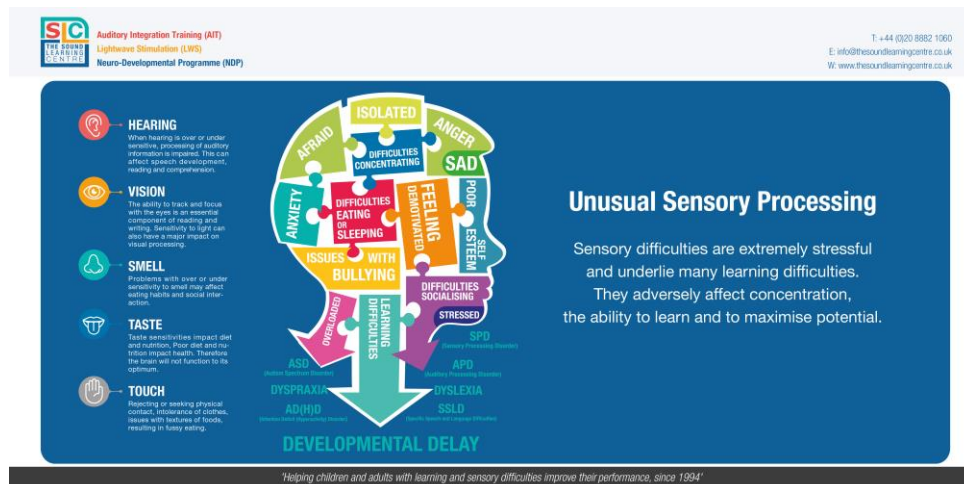

Figure 1: Unusual Sensory Processing.

So, what are sensory difficulties? You can see here what we call the five direct senses, hearing, vision, smell, taste and touch. The job of our senses is to collect information about our environment for our brain to interpret. Our brain then makes sense of this information using a combination of previous experiences and subsequent learning. However, if the senses are over-loaded, and unable to filter extraneous information, then that can lead to feeling overwhelmed and switching off as a defence mechanism, impacting confidence, self esteem and mental health. Clearly, this is not ideal in a classroom, at college or University, and definitely not at work!

### Impact of COVID-19 Global Pandemic

In the past 18 months, we have seen how the COVID-19 global pandemic has permeated the very fabric of our societies, having a huge impact on the entire world.

‘Trauma’ can come in many guises, be it in the form of a road accident, relationship breakdown, bereavement or even job insecurity or loss. In this instance we have been denied normal social interaction and contact with our friends and family, with most important communication taking place via video conferencing apps.

### Alice through the looking glass

It's as though we've stepped through into Lewis Carroll's Alice in Wonderland, and peered 'through the looking glass' into a world of illogical behaviour, where all the 'norms' we are used to, have been reversed.

For many, it has been a shocking glimpse into the world of sensory overload that so many of our clients deal with on a daily basis. For the first time in many people's lives, they have felt a

combination of anxiety, poor concentration and lethargy, as well as problems with eating and sleeping. COVID-19 has been a catalyst for disrupted and over-loaded sensory systems.

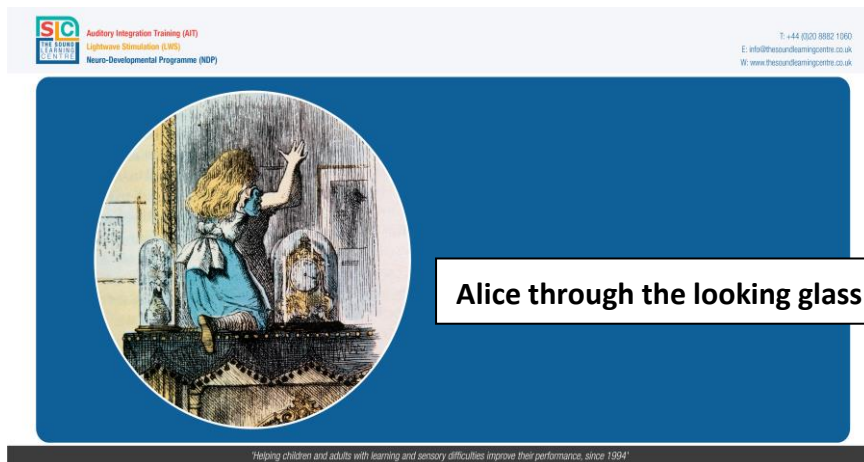

Figure 2: Alice through the looking glass ...

### **The Road back to 'Normality'**

Through comprehensive vaccination programmes around the world, the effects of COVID-19 are now receding, however, there are still the issues of variants which may be vaccine resistant.

The path back to 'normality' may be twisting and turning, and this lack of certainty, continues to impact mental health and wellbeing.

From our point of view, from working with a 'niche sector' of the population with sensory issues, it seems almost everyone has experienced what we describe as 'overloaded systems'.

We believe a greater understanding of what it means to have sensory overload and difficulties is essential. For many people now experiencing this 'overload', their anxieties will recede as the world steadies again on its axis. Some of them, however, may need understanding, compassion and therapeutic support to get back on track.

### **Interpretation and Explanation**

An individual's ability to help themselves and understand their difficulty or that of a family member, is often all in the interpretation of investigations or tests they have done. We provide clear, detailed explanations of our tests and observations to ensure our clients understand the meaning of their results, and our Assessment is our starting place, exploring the visual, auditory and developmental systems.

### **Visual and Non-Visual Systems**

We frequently see clients with visual processing difficulties, unrelated to visual acuity, that are more about how an individual is taking light into the brain through the eyes. As well as the rods and cones for vision, there is a third set of receptors in the eye known as intrinsically photosensitive retinal ganglion cells (ipRGCs) that drive the Autonomic Nervous System which plays a major role in synchronising the circadian rhythms.

When people are stressed they are often light sensitive, their colour visual fields tend to reduce and these non-visual systems are driven less efficiently.



### Visual Fields of Awareness (VFA)

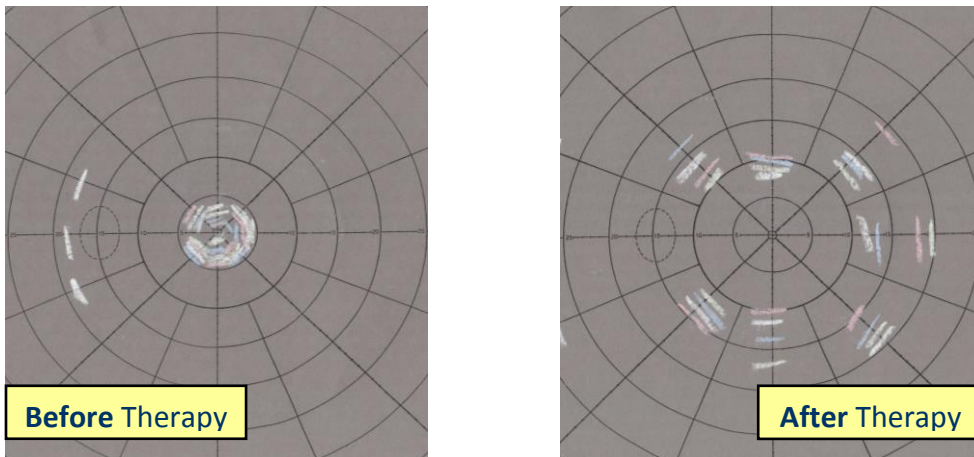

Figure 3: Visual Fields of Awareness (VFA).

We have found that the presence of restricted colour Visual Fields of Awareness is an indicator that light energy is not being efficiently processed through the eye to the brain and may relate to stressed systems. Reduced Visual Fields of Awareness can make it difficult to construct a complete internal ‘picture’ of the surrounding environment, leading to uncertainty that may trigger feelings of insecurity and unease.

In the Figure 3 comparison of a client’s left eye, you can see the colour visual fields have expanded after therapy.

As mentioned earlier, light helps to influence the Autonomic Nervous System, which acts largely unconsciously regulating bodily functions, such as heart rate, digestion, respiratory rate, emotions and pupillary response. If an individual is light sensitive, they will tend to avoid light whereas in reality they may need ‘more’ light exposure in order to help balance their Autonomic Nervous System which is divided into the Sympathetic and Parasympathetic branches.

Generally, the sympathetic division prepares the body for stressful situations, such as ‘fight or flight’, while the parasympathetic division controls ordinary body functions and is involved in ‘rest and repair’. The Sympathetic and Parasympathetic Nervous Systems work in opposition to maintain homeostasis. If this process is disrupted, identification is crucial, to accurately interpret the impact it has on an individual.



Figure 4: Autonomic Nervous System.

### Auditory System

This issue of interpretation can also extend into other sensory areas, such as the auditory system. When speech and language, comprehension, sound sensitivity or auditory processing is an issue, it's common practice to have the hearing tested, typically on 4 or 5 frequencies and the results then averaged to determine any 'deafness' and need for intervention. Parents are frequently told their child's hearing is 'within normal limits', without really understanding the concept of the hearing test.

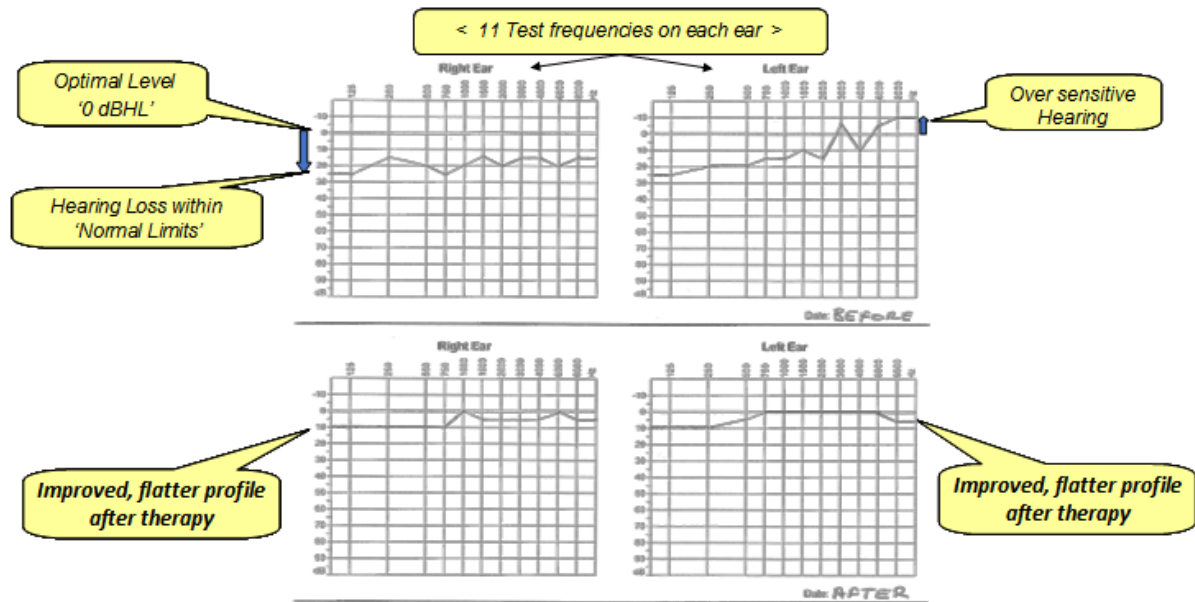

Figure 5: Typical Audiograms – Before and After Therapy.

We test on 11 frequencies and take particular note of any over sensitivity as well as hearing loss.

We also observe the pattern of any peaks and troughs on the hearing profile and do not average the results, since this may give a false degree of confidence that hearing is not related to the learning and sensory difficulties experienced.

### Reflex Development

Another example of the importance of our observations, is our understanding of the developmental systems.

During foetal development, the Primitive Reflexes emerge, and begin to inhibit during the first year of life. Following this period, the Postural Reflexes should fully emerge to help deal with the demands of a gravity-based environment.

If there are clusters of retained Primitive Reflexes, or underdeveloped Postural Reflexes, this may lead to performance issues, in areas such as, co-ordination, balance and fine and gross motor skills.

### Summary

There's a good deal of overlap between the visual, non-visual, auditory and developmental reflex systems and they all contribute to our overall performance.

Part of our approach is looking holistically across all these systems. We believe that it's only when these systems are viewed together that we can see how they are all related. We firmly believe, it is

never just 'one thing' that is the problem. It is often lots of small things, that when viewed as a whole, can become quite challenging if not identified, understood and helped.

We use three independent therapies to help improve people's performance, they are Lightwave Stimulation (LWS), Auditory Integration Training (AIT) and Neuro-developmental Programme (NDP).



Figure 6: What the therapies lead to.

When the sensory systems are well integrated we see improvements in areas such as: Listening skills, Concentration, Self-confidence, Co-ordination and overall well-being, Happiness and social skills.

27 years of working with sensory difficulties has taught us a lot. We now share that knowledge and experience. Our approach is one of 'authenticity', dealing with 'real people' and 'real lives' and providing practical help in the form of coloured light, sound and developmental therapies. We are honest and open and do all we can to empower the families we see and enable them to feel 'heard'.

**Sample Testimonials received following therapy**

- The first is from a 20 year old Female University Student who had experienced Sensory Difficulties throughout school: "I would like to thank you for all of your help – I cannot tell you how much improved my life is now! Since visiting with you, I have lived as an independent adult for the first time – held down a full time job, had an active social life, made and regained friendships, changed almost every aspect of my life and had almost no problems doing so, and moved away from the boyfriend I used as a crutch. Really, I thank you".
- The second testimonial is from the parent of a 4 year old boy with Auditory Processing Problems: "Thank you so much for everything – you saved my son from a life of frustration, isolation and academic failure. Thank you".

**CONCLUSION**

Sensory difficulties have been 'hidden disabilities' and it's been difficult for those 'without them', to understand those 'with them'.

Our new world order has given us all a telling insight into sensory difficulties, and we hope this new-found knowledge will encourage understanding and compassion in all areas of life, at home, in school and in the workplace.

In conclusion, sensory system functioning can be improved through non-invasive therapies and better integrated sensory systems can positively impact social, emotional, behavioural and academic performance, smoothing our journey through life.

# ***Bodygraphy* - Chromatic performance on surrounding space**

**Susana Ribeiro** <sup>1,\*</sup>

<sup>1</sup> Faculty of Fine Arts of University of Porto, Portugal, i2ADS - Institute of Investigation in Design, Art and Society, Member of Association Portuguese of Color; susanaribeiro001@gmail.com

\* Corresponding author: susanaribeiro001@gmail.com

## **Abstract**

This article presents a reflection that aims to analyze “*Bodygraphy*”, an artistic project that proposes to think about color, body and space in contemporary art. As a researcher, artist and author of this investigation project, I will present a performance reported by the series of photographs developed in the city of Porto. It was necessary to create a colorful costume to use and shelter the body in the chosen places, thus creating body experiences and photographs where new landscapes are inserted as my body/color. Reflections about the dialogues between color, body and space are presented to visualize a process of creation in which the body/color is thought of as an element that delimits a territory. An organic body/color that interferes and claims a geographic place and becomes a part of it. Understanding the role of color in the relationship with the body and space, therefore, became an important starting point for a reflection on this *Bodygraphical* trilogy.

**Keywords:** *color, body, space, Bodygraphy*

## **INTRODUCTION**

This arts-based research action is the result of my experience as an artist and researcher. This reflective process presupposes a continuous discovery of the need to make sense of the artistic experience and, through it, obtain a multisensory response, allowing for a type of learning at the level of the senses (Hernández 2008: 54). Performance was the artistic process chosen for this investigation, it is the guiding principle, the methodology. It is the performative journey through the city of Porto that allows me to gather new perceptions about the surrounding landscape, under the experience of a place through the intervention of the body dressed with a cloak created exclusively for this experience.

The photographic series of registration of the *Bodygraphy* performance reflects the experiences of the body/color in the natural and urban space. These records trigger reflections, and may even be a receptacle of knowledge generated from the chromatic relationships of the body with its surroundings. The spaces were chosen so that the body could be involved and available for a corporeal and chromatic experience of intervention in space. The photographic records demonstrate the deceleration of the body and its contamination in the landscape. This experience moves in the search for forms in space through the use of body/color, thus creating new landscapes. There is also the desire to intensify bodily sensations through clothing and the choice of places where nature is abundant, such as the city park and the beach, as well as the more cosmopolitan places in the city center, thus creating an area of contrasts, not just between color/body and places but also between places themselves. This involvement of body/color/space, captured through photography, reflects a growing movement of union, complementarity and the perception of landscape as a possible potential space for aesthetic and poetic experiences. This conception, construction and perception of space take place in an individual way.

As in the performative work of the reference artist Paim (2015), I have a common performative interest in the union of body and space, which gives us a chance to reflect on the body as part of it, as a constituent element of the landscape. The photographic records show the integration and experience of the body in space, becoming an artistic element. This experience becomes a mixture of

body and color that spontaneously interact in the search for a space in the topography. Body/color/space, elements that interact, invade, merge until they become one. It is a relationship of continuous movement in the composition with the other and with the inhabited space, an emotional construction of a place that awakens the narrative of landscapes that enhance all forms of interpretation of the observer's senses.

### **BODY AND COLOR – THE PERCEPTION**

During the investigation, I put my body in motion and available for experiments. I decided to browse, look for poetry through color, new experiences and self-knowledge. The trajectory intensely carried out by the body that walks to activate the senses, awakens and perceives the poetic potential existing in the path, in the body, in color, in space. In the routes taken, I realized how important perceptions and sensations were, as well as the experience of the present in space and time. The active body artistically transits terrains where poetics and life live together, acting on knowledge based on duality. The body knowledge becomes indispensable and inseparable from artistic and poetic practice. The body materializes ideas, actions, articulates itself so that the performance can be manifested in that space and time where only the artist exists.

Merleau-Ponty's *Phenomenology of Perception* is also an important reference for my work process, his investigations critically review the understanding of the sense of perception through the analysis of sensations allied to the body. In this way, the perception is configured as an action by which the conscience captures a given element or a certain object, using sensations as a kind of tool to apprehend such impressions. These impressions constitute an innovation in the way of understanding perception, including the notion of the field as the main focus. Therefore, perception ceased to be understood through a linear stimulus-response causality and started to be understood as a corporeal action. Thus, the author observes: "Blue is what asks me for a certain way of looking, what can be felt by a defined movement of my gaze. It is a certain field or a certain atmosphere offered to the power of my eyes and off my whole body" (Merleau-Ponty 1999: 284).

Both the cognitive sciences and the artistic field fed on these studies to find stimuli that would dialogue with these revealed meanings that bodies carry. This is achieved by developing research that intends to move these senses of the body and proposing a synesthetic recognition of all this load of information contained in a certain color. At this moment in history, the body comes into evidence in art, just as art becomes processual, relational. When it becomes experiential, it gets so close to everyday life that both get confused.

I was surprised by the potentization of the chromatic sensations that occurred by using the cloak on my body, especially when I came across the photographic material produced and the power of its imagery and poetic quality. I emphasize that even though the cloak is an object of great importance in this process, it is not only an object of research, it is an extender of the body that seeks poetic experiences, activation of perception and place. The cloak was the environment for the body to make its journey through space, a third skin that enables the occupation and habitation of the chosen place.

### **ROUTE AND MOVEMENT – THE SIGNIFICANCE**

"Corre o rio para o mar..." (GNR 1992)

*River runs to the sea...* is part of the lyrics of a song entitled *Pronúncia do Norte*, which echoes in me from the beginning to the end of this art project, and it was it that defined the route to be done during the experience. It is a kind of poetic lever that defines the territory, the reflection, the

experience, which led me to understand cloak as a form of intersection between the body, color and space, acting as an element of shelter/protection. The cloak, as an artistic creation, surrounds my body with fabrics, transforming itself into a kind of magical wrapping that welcomes the experience.



Map of the route of *Bodygraphy*, performance art in the city of Porto.

The route was very important for the recognition of the space, as well as for the interaction and integration of the chosen places. Movement times and breaks were equally important for the body to feel the cloak in each of the created landscapes. The start of the trail took place near the Douro River and ended on the beach, just right in the Atlantic Ocean.

The movement of all orders of the body's senses is a proposal of experience that allows us to conceive landscapes that lead us to different reflections, new perceptions of living space. The movement promotes imagination, enchantment, the enigma arising from a special contemplative state, which echoes in the most distinct senses, inciting artistic creation in all its forms. A different shift from the daily journeys, from the bureaucratic practices of coming and going in the city, and from the anaesthesia that we are subjected to by the consumption system and by the (dys)functional world. The experience became an excursion, a state of wandering as a tactic for a deviation from passive reception, a "*flaneur*" appropriation of the city, of tactile visions, of slowness, of delay to the poetic meeting of the construction of the gaze. Movement becomes relevant to the experience as a synonym for uncertainty, provisionality, body, fleeting, finitude. The claim of experience, not based on reason or clear, distinct and pure ideas, but experienced as a deviation, linked to contextual situations, linked to the body, to passion, to the pulse of life. As Larrosa (2015) says, experience is something that belongs to the very foundations of life, without any technical or practical methodology.

## **EXPERIMENTAL**

In this sensory experience, I approach color through the expression of my considerations about the realization of this study, while developing my artistic practice. In my artistic career, which I have been developing for over twenty years, color is central and will always be a determining factor in my creative process. The artistic research project *Bodygraphy* was born with the urgency of creating a cloak for an intervention performance. This was materialized using a fabric of specific color and texture to produce an effect of great contrast with the surrounding space, fuchsia-colored tulle and taffeta. This color is chosen in order not to merge with the elements that make up the spaces, it is a color that imposes itself, inflexible, which allows me to dedicate myself to the sensations of my body



in each place. The piece was designed and produced by me with the purpose of identity and interface of relationship with space.



Figure 2: *Bodygraphy*, performance art in the city of Porto: Photography by Fernando Xabier, 2021.

Through cloak, I make my body available for a phenomenological experience that offers itself as a condiment between the artistic and the color in the surrounding space. In this process of chromatic reconstruction of the landscape, it is necessary to overcome the difficulty of perceiving, feeling and absorbing time. Merleau-Ponty's phenomenology of perception was present throughout the journey, it helped me to expose myself to the gaze, to inhabit and invade the landscape that was already in me. I silently occupy the city, making connections with human beings and the world, it's the last exit from the comfort zone. I'm not alone, my act resonates with everything and everyone around me. The first contacts with the selected spaces are made in a shy way, still with the cloak on the arm and with a photographic look searching for the best general framing. However, the final decision of framing each record is delegated to the photographer accompanying me. As we were always on the move, there was no approach from a more curious audience. From the beginning of the photographic record, the body feels the cloak and seeks to inhabit the place, a way of feeling present in the transformation of the landscape. Body/color/space, these elements come together in a movement in search of forms in space for an occupation of the landscape, intending to discuss and highlight this spatial transformation.



Figure 3: *Bodygraphy*, performance art in the city of Porto: Photography by Fernando Xabier, 2021.

The choice of the landscapes where the experiments were carried out took place in an intuitive way inserted in the established structural route, from the river to the sea, trying to find spaces of

contrast where my body could feel welcomed or helpless. During the displacements, I tried to interfere in the landscape in order to transform it only during my presence/stay in the place. Landscapes are spaces that are part of my daily life, my research and poetic production of the re-signification of place/space.



Figure 4: *Bodygraphy*, performance art in the city of Porto: Photography by Fernando Xabier, 2021.

My initial involvement with the landscape throughout the experiences involved my body, at first as something to test, then as something to compose and show itself in the records. The experience more clearly connects the body, color and space, although my body is not seen unprotected from the cloak, it is in its entirety, dedicated to all the sensations and experiences of that moment and landscape. The issues related to the body were unveiled over time, shifts and pauses in the landscape, where I was paying attention to the sensations and events on my skin and my body as a whole. With that, I highlight my search and attention to knowledge acquired and built through the body.

The performative experience demonstrates that even if the cloak has great importance in the interactions and experiments carried out, and despite its strong presence, it needs a body to make it come alive. I see in the cloak the power of interface and establishing a relationship with the environment. The landscapes created by me are unique, as well as my experience in the feeling of the path, in the recreation of non-place and in the experience of this limbo as a point of reflection. The wind factor also appears as an intervening element on the sensations that the wear causes on my body, helping in a way to compose the sculptural forms found in the photographs.



Figure 5: *Bodygraphy*, performance art in the city of Porto: Photography by Fernando Xabier, 2021.



The performance presented in this experiment was photographed, so in addition to recording it, it is also a means of ensuring the legitimacy of artistic action. The importance of the route emerges in the sequential presentation of the images, with the intention that the viewer's eye travels through the photographed landscape and experience. The photographic records bring new sensations, capture the essence of the place excluding other perspectives, transforming the space into an icon.

### **DISCUSSION AS A POSSIBLE CONCLUSION**

When there is a production of unique narratives, the landscape is activated, the city space is reaffirmed as a field of artistic, aesthetic and social investigations. The image production and texts recreate the landscape and imagery related to the city. It should be noted that this experience can promote a rethinking about the concept of landscape, promoting a “state of suspension of certainties”, as in Cauquelin (2015: 25), which makes us think of the landscape singularly, infinitely reinventing the city, the landscape and ourselves.

The objective of this performance is to generate sensibilities, aesthetic experiences, or sensitive ones that produce meanings, doubts and concerns in the spectator's mind, thus creating a new concept of territory/space/landscape. I also try to think about performance as a conceptual art practice, a process that results from a cycle of thought, action, experimentation and learning. I look forward to new paths in other cities, displacements in space to, firstly, get to know them to develop new experiences, thus tracing relationships and reflections on the body and color in space through movements and pauses. In this investigation art project, the paths, the landscapes are formed, activating, enabling further dissemination and propagation of knowledge and images of experiential creations that cross the body. I can say that Bodygraphy is an artistic concept of intervention in the landscape through a performative action that involves the trilogy of body/color/space.

### **ACKNOWLEDGEMENTS**

I would like to thank the support of i2ADS - Institute of Investigation in Design, Art and Society and my dear friend Fernando Xabier for the photographs of my performance.

### **REFERENCES**

- GNR. 1992. Pronúncia do Norte. *On Rock in Rio Douro*. Porto: EMI.
- Hernández, F. 2008. La investigación basada en las artes. Propuestas para repensar la investigación en educación. *Educatio Siglo XXI, Revista de la Faculdade de Education*. ISSN-e 1699-2105, 26.
- Larrosa, J. 2015. *Tremores: escritos sobre experiência*. Autêntica, Coleção: Experiência e Sentido.
- Merleau-Ponty, M. 1999. Fenomenologia da Percepção. 2ª Edição. S. Paulo: Martins Fontes.
- Paim, C. 2015. Poros abertos: Corpo em Ação e Dispersão. *Simpósio 2- As cidades na cidade, Universidade Federal do Rio Grande*. claudia\_paim.pdf (anpap.org.br)

# Post-Pandemic Support with Colour, Light and Frequencies

Angelika Klotz <sup>1,\*</sup>

<sup>1</sup> Esogetics; angeliquehealing@yahoo.co.nz, info-de@esogetics.com

\* Corresponding author: angeliquehealing@yahoo.co.nz, info-de@esogetics.com

## Abstract

Colourpuncture, as conceived and introduced by Peter Mandel in the 1970s, has been used to support clients with health challenges, illnesses, and diseases for more than 40 years. During the recent pandemic Peter was able to find new ways to help those who needed it most. In this paper we will look at potential challenges with which we were faced during the pandemic as well as suggested new therapy approaches to support healing on all levels - physically, mentally, spiritually as well as bring the body-mind complex back into equilibrium.

**Keywords:** *Colourpuncture, Brainwaves, Insomnia, Stress, Gamma Waves*

## **PANDEMIC RECOVERY**

When we talk to people all over the world the common expression we hear is that life was on hold for most of 2020.

Many were living in anxiety and fear - fear of contracting a virus that was widely unknown and that seemed to cause many deaths.

For most this fear (and the additional pressure of changes in society and surrounding environment due to lockdowns, travel plans, challenges for businesses) put an entire new stress level on top of the already daily elevated stresses that were running lives.

We have not seen the total impact of the pandemic yet, neither in numbers of the infected nor in numbers of the people who were otherwise affected by the worldwide situation of the pandemic. But what we can already see is the psychological side effects that people are experiencing even if they are not directly affected by the virus.

In Japan for example the suicidal rate rose again for the first time in over a decade over 22 thousand deaths in 2020. In comparison the Covid related death toll was 13364.

This pandemic has shown us like never before how valuable our health is and how precious the state of wellbeing is. In this time of crisis, it has been more important than ever that our bodies are full of energy, balanced and strong, that our mind is flexible and resilient with an optimistic outlook, and that our spirit is connected and aware.

Offering Esogetic Colourpuncture treatments have been proven to be an intricate tool to sustain and bring forward a fully balanced body-mind complex. In addition to using light and colour, brainwave induction therapy has shown to be extremely effective in our modern-day world as it synchronizes energies and consciousness levels.

Especially when we are looking at potential psychological problems after long periods of lockdown or other negative impacts on the collective mental health status due to changes in society, brainwave induction can offer valuable solutions due to regulatory impulses on neurotransmitters and transmitting impulses through the thalamus.

## **COLOUR AND LIGHT SUPPORTING LIFE**

Life's characteristics are biological processes such as signalling and self-sustaining cycles, such as growth, reproduction, functional activity, and continual change.

Within Esogetic Therapy we have known that coloured light is supporting all cell functions and without any doubt life in general.

“We know today that man, essentially, is being of light. Modern science of photobiology has proven this. In terms of healing the implications are immense. We now know, for example, that quanta of light can initiate, or arrest, cascade-like reactions in the cells, and that genetic cellular damage can be virtually repaired, within hours, by faint beams of light. The entire metabolism is dependent on light.” *Dr. Fritz Albert Popp (1938-2018), renewed Biophysicist and Founder of Bio-Photon Theory.*

Dr. Popp’s research played an integral role in the creation of Esogetic therapy and the pioneering work of Peter Mandel that is colourpuncture. Peter was able to show that the use colour electromagnetic impulses would support the communication between cells and with that gave regulating impulses to the biophysical processes in the body.

### **APPLICATION OF FREQUENCIES**

Another discovery that influenced Peter greatly was electroencephalograph which became public though the work of German psychiatrist Hans Berger in 1929. He initially described the beta and alpha rhythms of the brainwaves. In 1935 delta waves were recorded and eight years later British researcher William Grey Walter discovered the theta waves.

Berger finally specified all EEG characteristics and divided the four brainwaves into single categories which correlated with different physiological states.

#### **Beta Rhythm**

The beta rhythm is an irregular small wave with a frequency of 13 - 40 Hz. It is characteristic for states of concentration and an alert state. The brain is awake and engaged. Logical thinking, intellectual and intense activity are an expression of beta as is restlessness and the proximity of anxiety. A high ratio of beta waves correlates with increased recreation of stress hormones.

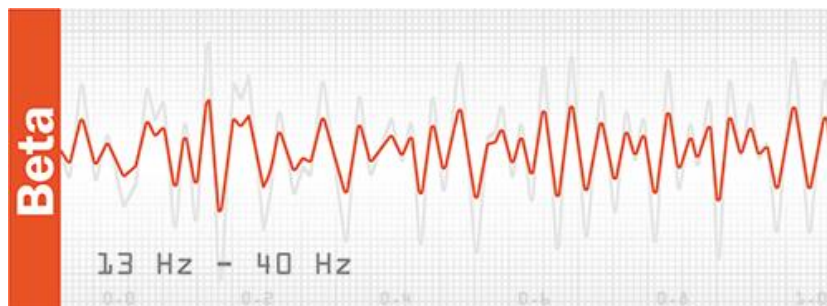

#### **Alpha Rhythm**

Alpha waves with a frequency between 7 and 13 Hz are characterised by relaxed states and intellectual calmness. Alpha waves are starting to be produced once the eyes are closed. They represent a sensation of comfortable rest, a feeling of quietness and contemplation. The beginning of meditative relaxation is correlated to the alpha rhythm, showing an especially good integration of body and mind.

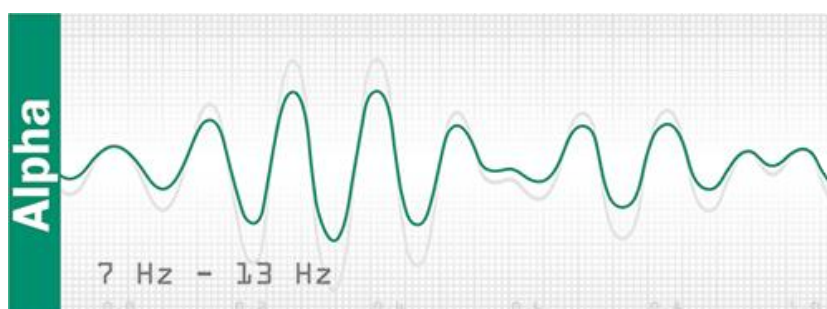

### Theta Rhythm

Theta waves in the frequency range 4 - 7 Hz represent certain phases of sleep and deep relaxation and meditation. The activation of deeper layers of consciousness enters the state of dreaming. Intellectual activity is being switched off in favour of fluidity, vivid imagery, image-oriented memories, and fantasy filled intuition. Learning contents are especially well imprinted in this frequency, because the filter of analytical thinking is absent. Children until the age of 6 are operating dominantly with theta waves.

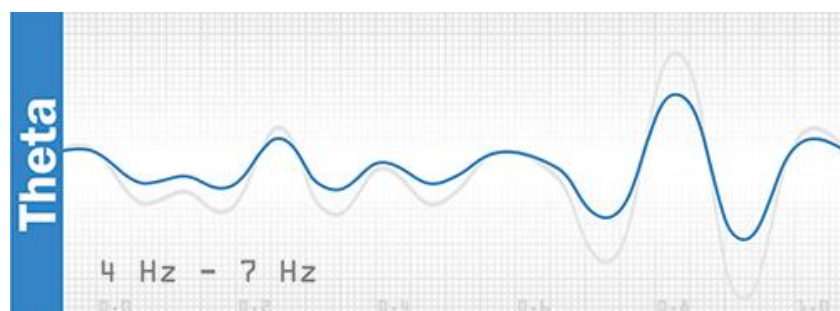

### Delta Rhythm

Delta waves occur in a range from 0.5 to 4 Hz. They are extremely low and slow and signify a deep and dreamless sleep (non-REM sleep). They are very rarely recorded during wake state. Delta frequencies are of great importance for healing processes, phases of regeneration and for a functioning immune system. Deep hypnosis and trance states could not happen without delta waves.

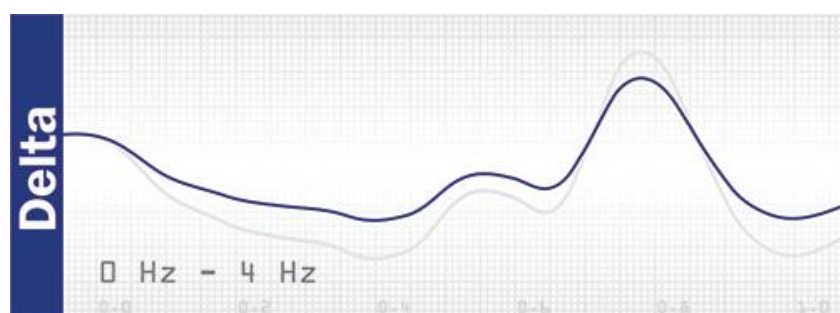

In the 1960s the insights of electroencephalography led to the development of bio-feedback research, where the focus was on the interplay between body and mind, between consciousness and brain frequencies.

Biofeedback used mechanics to bring an awareness to inner processes, this way a generation of specific brain waves were possible to regulate functions like blood pressure, heartbeat etc. To bring this process even further one could argue that biofeedback leads to a clearer Ego or I consciousness. In this stage of consciousness, a difference between voluntary and involuntary processes become minimal or even not existent, by making involuntary functions of the body conscious they become voluntary and therefore controllable.

The psychiatrist Dr. Charles Stroebel is convinced that the brain has the ability to reprogram itself if a person creates the necessary motivational structures. Peter took these findings further and he is certain that this motivational ability could be supported by particular brainwave patterns.

The mutual influence between consciousness and brainwaves, body cells, organs, and systems, was the most important focus in Peter's research. His premise is that all changes in life, including particular disease symptoms are a reflection of the four brain rhythms. Our brain could start to vibrate incorrectly

and over time loses its ability to adapt to the natural vibrational behaviour, which usually is a calibration towards rest and relaxation, concentration or wakefulness. This results into internal rhythms no longer being congruent with the external rhythm. Cellular changes and disturbance of organs and systems are preceded by regulatory disturbances of the four brain wave rhythms.

### ***LIFE IS A RHYTHM***

Peter was convinced early on that each irregularity in the human consciousness created changes and therefore consequences in the rhythms of the brain waves - and vice versa. Whenever there is a blockage in this system of interplay, dynamic reactions in the human being and his or her individual program is interfered with and no longer able to fully react.

To give the important impulses to the brain to activate a proper rhythm again, Peter chose an induction with subtle stimuli on the skin which were able to regulate the disturbed brain rhythms. Supported by his friend and colleague Robert Fuess, Peter was able to formulate numerous programs for a wholistic regulation through frequencies.

Induction therapy has the sole purpose to communicate to the human being a natural and familiar rhythm that is appropriate for a specific situation and to establish a normal brain rhythm and sustain it. Medical studies have shown that induction therapy does not affect the quality of the brainwaves themselves but their rhythmic behaviour. Therefore, induction does not work therapeutically on the brain but like the brain. It encompasses all four brainwave ranges in which humans constantly oscillate in alternating patterns.

### ***CASE STUDY***

#### **Let me give you an example**

Let me give you an example: Here is a typical Kirlian photo of a client who presents sleep issue. Kirlian photography makes the energy flow of the fingers and toes visible, and we use Energy Emission Analysis to determine where energy blockages are in the body. With this diagnostic tool we can determine imbalances in the brainwave rhythms as well.

This photo shows disturbances of the energy flow in the feet, which represent the theta and delta brain rhythms.



This would be an indication for the sleep program induction:

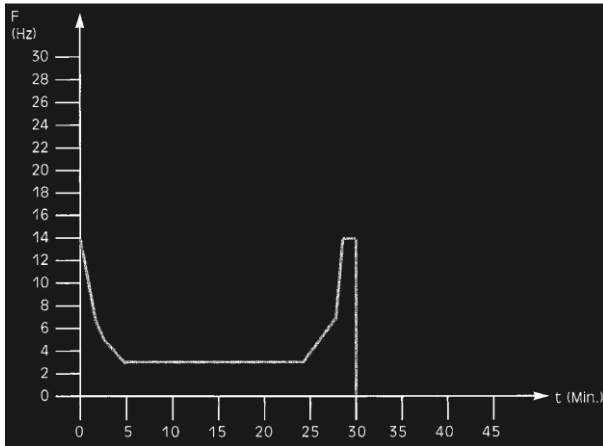

This sleep program helps with falling asleep and keeping asleep through the night.

It is also used for clients with a tendency to aggressive behaviour, or who have eating habits which have consequences that don't support health and well-being. Under this category also fall clients who are excessively indulging in stimulants or abusing substances.

We find that sleep is of major importance to regenerate the brain and body therefore this sleep program was indicated for most problems presented last year.

Here is the Kirlian photo of fully balanced brainwaves. The fingers of the left hand represent the alpha state while the fingers of the right hand represent beta; the left foot represents theta and the right foot delta.

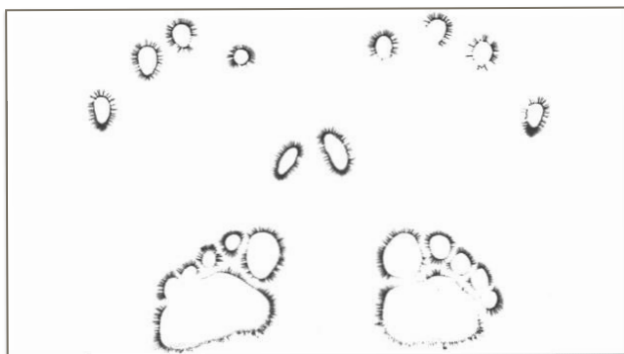

Kirlian photography is one of our major tools to detect stress signs in the body, not only physically, but also mentally, emotionally and spiritually.

### **IMPACT OF STRESS**

All rhythms are affected by stress. In the last two decade we observed most constant stress as a root cause for autonomic dysregulations. Originally stress was designed as a defence mechanism, most useful in the eye of danger. Stress leads the body to extreme performance through the excretion of hormones that increase blood circulation and elevate heartbeat, muscles are prepared for physical action, the digestive tract and sexual function are slowed down, and the immune system is suppressed. This was a regulating mechanism to fight and survive better.

These days the fight for survival is less physical and there is no immediate danger to our survival, yet the physical response to external stresses are still the same. Over time the ongoing tension in the stressed individual literally becomes a program with an inability to discharge the mobilised energy and the brain is no longer able to follow its original vibrational blueprint.

## **THALAMUS GOVERNING THE RHYTHMS**

In the 1980s Peter already determined that energetic and physiological signals within the regulation of the thalamus and the pineal are disturbed when under stress. Working with brainwave induction Peter decided to introduce the vibrational patterns that are inherent to the brain through the skin. There is no forceful change of the brain frequency, there is only a proposal and an offer which the brain can consciously consider accepting. This particular decision is made by the thalamus. The thalamus recognises impulses that are similar or related to the normal brainwave. By introducing natural oscillating patterns overworked and overstimulated areas of the brain can calm down and relax; blocked systems have a chance to return to normal, and disease symptoms that are related to specific blockages can resolve. This therapeutic concept of vibration in resonance has been proven a very successful supportive approach in recovery and long-term health maintenance.

## **GAMMA WAVES**

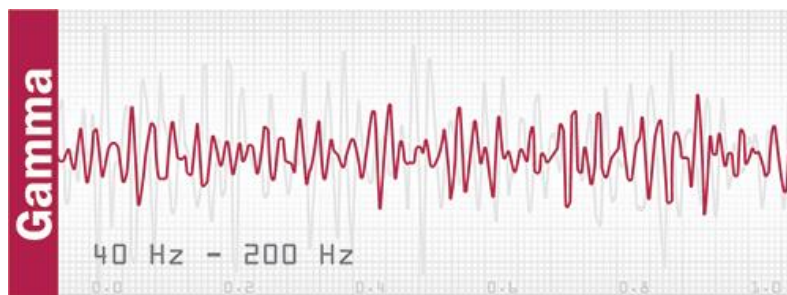

In 1988 there was an additional brainwave observed and discovered: the very fast gamma wave.

Gamma waves are the fastest known waves, and they oscillate between 30 - 100 Hz. They are connected to peak concentration and peak performance, strong focus, and mystic transcendental experiences. The gamma frequency seems to present superordinate coordination abilities which could offer higher perception and insights. Gamma waves show that the brain is hard at work, processing information and looking for solutions to problems. Research suggests that people with learning difficulties or impaired mental processing may not produce enough gamma waves. Studies on yoga practitioners suggests that one may be able to boost gamma wave production by meditation and attention to breathing.

American scientists observed Tibetan monks during their meditation. They found a dominance of gamma waves in their brains. They connected these with their state of happiness. There is possibly a link to hyper-communication as well. And a connection to spontaneous remissions which can increasingly be observed worldwide as been discussed as well.

This led Peter to the development of Gamma programs that have been proven most successful in synchronising perception, improvement of concentration and learning, regulation of stress, anxiety and depression and harmonisation of all physical systems. Any other therapeutic impulses given have better and faster effects.

The Gamma brainwave induction has been proven excellent in combination with any other therapy as the body is prepared and in a state of acceptance and has therefore become the preferred method of treatment in these unprecedented times.

We have found during pandemic challenges that treatment with sleep supporting programs and stress releasing gamma waves were helpful to increase reliance, keeping the body-mind system in relative calmness. This subsequently helps to maintain a healthy equilibrium despite adverse impulses from the outside.

# Colour, human experience and cyborgism

Valérie Bonnardel <sup>1,\*</sup>

<sup>1</sup> University of Winchester - United Kingdom; valerie.bonnardel@winchester.ac.uk

\*Corresponding author: valerie.bonnardel@winchester.ac.uk

## Abstract

In the Varela, Thompson and Rosch's embodied and enactive cognition framework, a middle way is proposed between the objectivism assuming a pre-existing world and subjectivism which consists in an outside projection of a living organism's organisation. In an enactive view, cognition emerges from a dynamic structural coupling between the organisms and their environment in which both determine each other.

With new technology, humans can be equipped with previously unseen sensory capacities (named as cyborgism), which offers an opportunity to reflect on the nature of the structural couplings arising from interactions between the cyborg and their environment.

Our paper will present a case of achromatopsia since birth who senses wavelengths through an antenna shaped detector (eyeborg) that transforms wavelength into sound waves.

Brain modifications consecutive to the continuous exposure to a new stimuli pairing (wavelengths-sounds) together with the cyborg behavioural performance such as colour-discrimination will be considered.

**Keywords:** colour perception, embodied cognition, enaction, cyborgism

## INTRODUCTION

### Embodied cognition and enaction

In their 1993 book "The Embodied Mind: Cognitive Science and Human Experience" (Varela et al. 1993), Francisco Varela, Evan Thompson and Eleanor Rosch propose a conception of cognition described as enactive. According to enaction, cognition emerges from the co-determination between living organisms, defined as autonomous systems, endowed with self-organization and generators of meaning, and the environment in which they are situated. Enaction draws a middle way between 'objectivism', where living organisms evolve in a predetermined environment and cognition merely consists in extracting the physical laws and 'subjectivism', where the living organism projects the regularities of its own functioning onto the environment. To illustrate enaction, the authors choose colour vision, first because colour is largely transdisciplinary from art to science, and second it has an immediate meaning in the human experience in terms of perception, cognition and emotion. Moreover, traditional accounts of colour vision experience remain problematic. Objectivism comes up against the fact that there is no simple and univocal causal relationship between the physical signal (luminous flux) reaching the eye and the perceived hue. The fact has been observed as early as 1789 when Gaspard Monge a French Engineer and mathematician invited members of the Academy to look at a red paper through a red glass which looked white, while when looking at the same red paper through a narrow tube with the extremity mounted with the same red glass looked, this time, as vivid red. This, then considered, paradox is a consequence of what is known today as colour constancy (Mollon 1985) and artificial systems performances still do not match that of human colour constancy. As for Subjectivism it fails to account for universally shared aspects of colour vision such as categorical perception or preferences. Since the initial work of Berlin and Kay in 1969 (Berlin and Kay 1969), the exclusively cultural and arbitrary origin of colour names and their categories has been questioned to integrate the existence of universal constraints giving rise to what the authors defined as 'Basic Color Terms'. Similarly, studies on colour preference highlight universal tendencies (preference of cold colours over warm colours) modulated by cultural and idiosyncratic factors (Bonnardel et al. 2017).



The enactive approach to colour vision reduces the tension between objectivity and subjectivity by considering cognition as "embodied", i.e. as a result of experiences made possible with a body endowed with sensorimotor capacities that are exercised in a physical, biological, psychological, social and cultural environment from which the experience emerges (enaction) and where perception and action are inseparable. Thus, the quality of the enacted experience of colour results from the structural coupling between the organism and its environment for which the intersubjectivity and cultural sharing are essential to extract the meaning of this experience.





Today, due to recent technology, the implementation of hitherto unseen sensory capacities offers a reflection on the nature of the structural couplings established from the interaction between an individual endowed with an innovative sensoriality that is disconnected from their physical, biological, social and cultural environment. This paper will discuss the example of a cyborg equipped with a system initially designed to compensate for the absence of colour vision.

**WHAT IS CYBORGISM?**

Cyborgism is related to sensory substitution systems intended to replace or modify defective natural sensory abilities, but in this case, the added sensory organ is not a pre-existing one to the species. This was the case of a subject with achromatopsia since birth (complete absence of colour vision). Although black and white vision did not present a major visual impairment as such, it is because of the omnipresence of colour in visual communication that its absence was experienced by the achromatic subject as an handicap for social communication.

**The eyeborg**

To overcome this condition, a system called ‘eyeborg’ was developed. It is a device with an antenna implanted at the base of the skull in the occipital region with at its end a small video camera sensitive to electromagnetic waves. Wavelengths transformed in sound frequencies which are transmitted through the skull and then perceived by the inner ear as sounds of different pitch. Through a table of correspondence a ‘sonochromatic’ scale links short wavelengths to high sound frequencies and long wavelengths to low sound frequencies. By including infrared and ultraviolet, the eyeborg is sensitive to a wider spectrum (350-750nm) than the human visible spectrum and is divided into 360 intervals (i.e. approximately 1 nanometer, we will come back to the issue of discrimination. spectral in the following paragraph). The association between wavelengths and sound frequencies required a 3-year learning phase (see Table 1).

Colour	Colour name	Hearing Frequency (Hz)	Musica I notes	Tonal threshold (2-3%) in nm	
not visible	ultraviolet	>718.59	350	1.4-2.1	
	violet	608.54	459	D	1.2-1.8
	blue	573.89	471	C#	1.1-1.7
	cyan	551.15	477	B	1.1-.6
	green	478.39	534	A	1.1-1.4
	yellow	462.01	571	G	0.9-1.4



	orange	440.19	590	F	0.9-1.3
	red	363.79	610	F#	0.7-1
not visible	Infra-red	<363.79	750		

Table 1: Table of correspondence wavelengths to wave sound of the sonochromatic scale<sup>1</sup>.

### Modification of the cyborg brain

The transformation of wavelengths into auditory waves is not part of any biological system innate ability and the question of the continued use of eyborg on the brain structure can be raised. This question was addressed by a Spanish scientific team (Alfaro et al. 2015) using brain imaging techniques.

Functional magnetic resonance imaging (fMRI) shows that in the presence of a colored test pattern, a large part of the normal trichromat brain is active. As it might be expected, activation concerns a large portion of the occipital cortex (site of visual information processing), but also temporal (pattern recognition, memory, language and processing of auditory information), parietal (processing of somesthetic information - resulting from the senses of touch - movement and spatial information) and prefrontal (cognitive functions and decision-making). This stimulus elicits in a cyborg's brain an activation limited to the occipital lobes (V1 and V2). These differences suggest that visual stimulation in the normal trichromat subject produces, in addition to the activation of the visual cortex, activation in structures involved in pattern recognition, memory, language and decision. These brain regions, not exclusively visual and linked to semantic information are not activated in the cyborg.

On the other hand, connections between the two cerebral hemispheres (corpus callosum) and those between the visual and auditory centers and visual and decision centers are increased in the cyborg.

### Comparative perspective of the cyborg colour vision

By increasing the range of visual frequencies to which the cyborg is sensitive and by converting electromagnetic waves into sound waves, the eyborg endows its user with sensory abilities unheard of in humans. As described, sonochromatism is embodied by means of a new sense organ "the antenna" directly inspired by insects and is an integral part of the body, but also of the identity of the cyborg.

If the animal world served as inspiration for the organ, what about its function? Is there a species in the animal kingdom that has developed a colour sense close to sonochromatism? To answer this question, let us consider the diversity of chromatic systems as described by neuroethologists Justin Marshall and Kentaro Arikawa (2014) who make a distinction between conventional systems and atypical systems.

a) Conventional systems have a limited number of different classes of receptors sensitive to wavelengths: their number, shape and location on the electromagnetic spectrum is not fortuitous but reflects the history of relationships between the organism and its environment and inform the

<sup>1</sup> The sonochromatic scale covers approximately 1 octave of hearing frequency (364 to 719 Hz) which corresponds to 400 nanometers. The scale is divided into 360 intervals non-linearly distributed over the wavelength interval. For the octave of hearing frequencies concerned, admitting a tonal threshold of 0.2 to 0.3%, the spectral discrimination threshold corresponds to approximately 1 nanometer over the entire spectral interval, which is much greater than the capacities of discrimination of any biological chromatic systems. The principle of sonochromatism is similar to a spectrometer which measures spectral energy distributions, from which the dominant wavelength is computed and then associated with a sound frequency according to a correspondence table.

researcher about the type of colour vision. For example, the extent of the visible spectrum varies depending on the species which, for some, are sensitive to ultraviolet rays (insects, fish, birds, mice). The number of classes of receptors also varies; there are dichromatic systems (two classes of photoreceptors) found in most mammals, trichromatic (three classes of photoreceptors) as is the case with primates and insects or tetrachromatic (four classes of photoreceptors) which exist in birds, reptiles and freshwater fish.

It is important to note that these systems are equipped with complex neural circuitry which, by involving a large part of the brain, gives rise to elaborate behaviours such as categorization or color constancy.

b) Certain species (insects, stomatopods) are equipped with 5 or even 10 or 12 different classes of receptors, this is the case of the mantis shrimp (stomatopod). However, according to Marshall and Arikawa (2014), beyond 4 classes of receptors, the chromatic systems are probably atypical systems and the mantis shrimp, with 12 different types of photoreceptors, is an example. In mantis shrimp there is no additional neural coding step and its discriminating abilities are very reduced. Coloured surfaces are identified by the excitation patterns they produce in the detectors. The mantis shrimp have a correspondence table that allows them to respond to these patterns with stereotypical and wavelength-specific behaviours. The coloured vision of the mantis shrimp would be closer to satellite detectors that pick up terrestrial colours than to conventional colour systems.

With 360 detectors and the absence of any additional neural colour coding step, sonochromatism is more like the mantis shrimp system with a spectral resolution that is however thirty times greater. Unlike the shrimp, the spectral discrimination of the cyborg may well be greater than that of conventional systems. As wavelengths are immediately transformed into auditory waves, spectral discrimination performance is then determined by the ability of the inner ear to discriminate auditory frequencies. The tonal resolution for the frequency range corresponding to the sonochromatic scale (350 to 700 Hz) is of the order of 0.2-0.3% which allows a discrimination of about 1 nm over the entire spectrum detected by the eyeborg.

## **CONCLUSION**

With sensitivity to ultraviolet and infrared, sonochromatism increases the extent of spectral sensitivity as is the case with some animal species and has a number of detectors that far surpasses that known in the animal kingdom. The principle of sonochromatism based on the association of visual frequencies with auditory frequencies evokes synesthesia, but in the case of synesthesia, colored vision is present, and the coupling is really that of two sensory modalities " color and sound " and not " hearing wavelengths and frequencies ". Sonochromatism allows wavelengths to "be heard" and produces a simplified sensory apparatus that resembles the operation of a spectrometer. This new sensory device generates behavioral, cognitive and emotional reactions; the cyborg associates wavelength with auditory frequencies and reacts cognitively and emotionally to the sound signal. Sonochromatism allows him to develop an artistic production that he communicates to an audience, but this sensory faculty remains far from colour appearance as experienced in humans which results from a co-determination with their environment. In particular, sonochromatism does not result from a structural coupling developed across phylogeny and ontogeny, and cannot restore the intended interindividual communication based on an enacted experience of color that engages neurophysiological processes in relation to the physical and cultural environments. On the other hand, by using a physical dimension of the natural environment (wavelength) sonochromatism engages a structural coupling in its user which leads to a dynamic transformation of neuronal interactions, themselves modified by motor

action, cognitive and emotional behaviour that they arouses thus giving rise to the enaction of a singular experience which cannot find its meaning in intersubjectivity and cultural sharing.

## **REFERENCES**

- Alfaro, A., A. Bernabeu, C. Agullò, J. Parra, and E. Fernández. 2015. Hearing colors: an example of brain plasticity. *Frontiers in Systems Neuroscience*. doi.org/10.3389/fnsys.2015.00056.
- Berlin, B., and P. Kay. 1969. *Basic Color Terms: Their universality and evolution*. University of California Press.
- Bonnardel, V., S. Beniwal, N. Dubey, M. Pande, D. and Bimler. 2017. Gender difference in color preference across cultures: An archetypal pattern modulated by a female cultural stereotype. *Color Research and Application* 43: 209-223.
- Marshall, J. and K. Arikawa. 2014. Unconventional colour vision. *Current Biology* 24: R1150-R1154.
- Mollon, J. D. 1985. Colourful notions: Studies in Scarlet. *The Listener* 10 January: 6-7.
- Valera, F., E. Thompson, and E. Rosh. 1993. *The embodied mind: cognitive science and human experience*. Cambridge Massachusetts, London, England: The MIT Press.



# The power of earth colours

Margo Ruiter <sup>1,\*</sup>

<sup>1</sup> Kleurgevoel; info@kleurgevoel.nl

\* Corresponding author: info@kleurgevoel.nl

## Abstract

As light therapists, we are used to working with colours of light, the spectral colours. Working with reflected light asks for a different approach. These colours originate by the reflection of light on pigments. These are the colours of the earth.

In 2016 I described a new colour system for healing and empowerment, which comprises light into four different colour dimensions. The colours of the earth are one dimension. They are a true healing medium and foundation for creating a life that matters, literally. These colours help to ground ourselves, heal on a very deep level and transform old pain into wisdom. In this article I focus on the earth colours, because I found out that these are the colours my students and clients crave the most, just because the healing power of these colours is overlooked.

**Keywords:** earth colours, colour light healing, colour system, leg chakras, energy language

## INTRODUCTION

Have you ever had difficulty coming into action? Have you ever noticed thoughts spinning in your head over and over again? Or do you find yourself dreaming big goals, but you really have no clue how to manifest them?

I can assure you with 100% certainty, you are not alone. Of course, it seems that for some people, everything they touch turns into gold. But let's face it; this doesn't count for most people.

Why do I start my story with this? What does this have to do with colours, and more specifically, with earth colours?

### Let me take you on a trip through the desert

Can you imagine walking there alone, through the heat? Can you imagine seeing sand everywhere you look and seeing the shivering air just above the surface in the far distance? How does it feel being out there, all alone, while the sand burns under your feet?

I predict you're feeling hot, exhausted, thirsty and a little scared as well. Questions which will pop into your mind will probably sound like: 'How do I get out of this heat? Where do I find a sip of water in the next half hour? How long do I have to walk over this overheated sand?'

You have a couple of options: mentally leave your body and stop feeling anything in order to survive. Or, start feeling what you feel and fully accept that you would probably die out there.



Figure 1: Sinai desert, Egypt. Photograph by M. Ruiter 2004.

### **What is my point exactly?**

You have no choice other than to leave your body and try to survive.

This is what humans do daily, and we can't blame ourselves for doing that. This primal behavior will save us in crises. But usually, we are not in a crisis; we are just having another day in the office.

What would it be like if the walk in the desert would give us a similar experience as watching the rainbow? Seeing a rainbow is magical. Would it be possible to feel the magic in this desert walk?

Surrounded by all the different earth colours while being exposed to the true strengths of Mother Nature can be traumatizing.

If you choose to live your fully embodied self, you will experience this trip on a whole different level. Effortless strength you didn't even know you had will come up through your legs!

In fact, most therapists don't even know that they have a choice to incorporate earth colours while working with healing and transforming trauma or disease.

### **COLOUR FOR HEALING PRACTICES**

Colours are fascinating for the body-mind-soul connection, and luckily the healing power of colours is more and more known, accepted and used in both regular and complementary healing practices.

Pink, blue, green, and red are the most used healing colours. The colour pink is used in prisons and places where there is a lot of hostility. People seem to calm down while being in a pink room. Blue is cooling and works perfectly to ease over activity, lower blood pressure, calm inflammation, and prepare for a good night's sleep. Green reminds us of nature, brings peace into a room, and has a great healing and psychological effect. As a result, many hospitals use green in their operating rooms and throughout their facilities. Red activates and energizes the body, stimulates blood flow, and raises blood pressure.

Apart from these well-known healing colours, the rainbow colours also known as the colours of the spectrum are used by professionals. The majority of colour light practitioners will focus on these colours, while working with light devices on the skin or in the eye.

Energy healers work with the corresponding and well-known seven chakras which are based in the human torso. Chakras are big distribution centres of life force energy. Every chakra has its own frequency which can be perceived as a colour or a vibration. Finding our blockages and restoring the energy flow is healing for body, mind and soul.

### **Two types of colour**

While focusing on the magical spectral colours, the average colourlight therapist might forget that there are two types of colours: colours of light and colours of matter. The first group, as mentioned before, are the spectral colours which are intangible. The second group are the colours we see when light is reflected. It's still light, but we need a carrier to absorb and reflect the light. These colours are much more tangible and solid because they translate light into colour through their *body*.

Every colour, whether light or matter based, gives meaning to life on earth. The more conscious you are about the colours around you, the more you will see them. Some people, and I am not talking about blind people, don't see colour at all. This condition occurs because of people's lack of focus or urgency to see them. Becoming aware of the colours around you is equivalent to becoming aware of life itself.

## **COLOUR, ENERGY AND CHAKRAS**

You might have formed an opinion already, but I ask you to stay with me, for a little while. More than a decade ago, when I first started talking about chakras, people thought I was a weirdo. So much has changed, and more and more people are getting acquainted with the idea that the chakra system is a dividing and distributing system for energy in the body. Great mental and physical breakthroughs can be accomplished by becoming aware of them and working with them.

### **Subjective colour perception**

The different chakras are connected to different colours because they resonate on different frequencies. Every colour is always seen through the filters of its recipient; consequently, we need to be careful to point out one exact colour for each chakra or energy centre. The subjectivity is not only shaped by the past, what a person experienced and remembers, but it's also shaped by culture. Therefore, I also love to talk about colour areas.

Many people have highly developed senses of smell or taste. Others have a very good sense of colour. The sense of colour is divided into colour feeling, colour seeing, colour hearing, and colour knowing. I realize it can be difficult to believe. However, people with this specifically developed gift of seeing or sensing colours can see colours in places where there is no tangible object to connect them to. These people will passionately agree that chakras and colour energy exist. So keep an open mind and read more.

The seven primary chakras connect to the colours red, orange, yellow, green, blue, indigo and violet. These colours are very famous because their developmental themes reflect our modern-day society's focus on masculine energy: manifestation, action-driven presence and success. However, there are more chakras to be considered, as there are other qualities to life.



Figure 2: Silhouet with chakras in the legs, including the corresponding colours. Illustration: M. Ruitter 2016.

## **THE UNFAMILIAR LEG CHAKRAS AND IT'S EARTH COLOURS**

Few people know that there are more equally essential chakras. These colours help us live an embodied, authentic, and healthy life, where we feel genuinely worthy, nurtured, safe, and happy. We experience the sweet spot of unconditional love. Can you imagine all of that while walking through the desert?

The colours represented by the seven leg-based chakras connect to the colours of the earth: terra, ochre, rust-brown, dark-brown, brown-black, yellowish beige, and silver.

### **Corresponding themes of the earth chakras**

Choosing earth colours for healing purposes helps us in very specific areas of our lives. They literally help us grow our roots by shining light on our past, our family system and our bodies. In these chakras, we find data about the time when we weren't even born, before we were fully conscious, and before we could speak. This data was programmed into our nervous systems when all our senses were helping us to survive on a very basic level. "Am I nurtured, loved and kept safe?" These are the themes which are important to us. What we experience in our very young lives becomes our truth, whether it is true or not. We built our lives on this programming.



Having a solid foundation is essential for living a meaningful life. Being grounded and present in our bodies help us to stand strong, live authentically, fully embrace life as it is shown to us, and recover from moments when we were thrown completely out of balance.

### **Healing modalities for the earth chakras**

The healing practices vary from family constellation therapy and regression therapy to gardening and sculpting or walking barefoot every day. Using EFT/tapping to ground our body while voicing grief and pain is rather new to the list of helpful treatments. As the world develops at the speed of light, many are reluctant to go deep for healing. We prefer to take a pill instead of spending precious time healing our past and changing our wiring. Because we choose to play our recording over and over again, we often give up and tell ourselves, "It is always the same song after all."

**You can start healing today by noticing the earth colours and registering your senses as you connect to these colours. Perhaps you have pre-judgemental ideas about these colours, or your thoughts are of a very dualistic nature.**

By connecting to the earth colours, we are incarnating in our bodies in baby-steps. This helps us to live an embodied life, full of passion.

### **FULL RANGE OF COLOUR PERCEPTION**

As we heal ourselves by working with colour awareness, we will begin to perceive a full range colours. It doesn't matter if the colour comprises light or matter; we perceive colours through the dark light filter of our lives. As already mentioned, we see things in a way that is true to us. Some people are lighter in thinking than others. Their glass is half full. Others will see in darker areas and perceive the glass as half empty. Although this negative perception can be off putting, it can also be helpful. For example, the person's hypervigilance could warn us and keep us safe from making certain mistakes. We are continuously challenged to see without judgement, even though this might be a stretch.

Becoming more familiar with the energy language of colour light, we learn that we perceive things in dark or light or somewhere in between. Becoming aware of our shades helps us to overcome our difficulties, heal ourselves and start living more meaningful lives.

When we suffer a mental or physical crisis, we often find a new direction. We can change direction after being in a dark cave for a while. Somehow, we need to find the rising, empowerment energy to say, "No more of this." This rising energy is a beam of light coming from an unexpected direction, from somewhere deep inside ourselves. Having the courage to follow our inner light allows us to truly heal and transform.

### **The different hues of colour**

Identifying which hues we see the most helps us discover where we are on the dark/light scale. This is the same sort of scale as the numerical pain scale or the colour analog scale, which are used to indicate pain or discomfort. Hues that are more black and shady point out suppressed energies and the ability to keep things hidden for our conscious minds. Lighter and whiter hues indicate the ability to ignore darkness in our lives.

Note that this is an unconscious process and not at all a mistake or a fault. See this as our being in survival mode: the flight/fright response of our lower chakras. The lower chakras start with the first chakra of the masculine series, the red chakra at our tailbone, and continue down our legs into the feminine chakras that end under our feet.

### The subjectivity of colour

Every colour is observed through the veil of the past. We see and interpret colour subjectively, according to what we knew, learned and remembered (conscious or unconsciously). Our subjective seeing keeps us in the past, reliving memories on a daily basis.

You might say: "I don't like that colour. I ban this out of my life!" But by doing so, you reject a certain quality of the self. Therefore, by refusing a colour, you decide not to be whole. Being open to and curious about the other perspective gives us opportunities to grow and evolve. This eventually will lead to a brighter view of the world around us.

Not liking a colour is only resonating with the negative. Every colour has a negative and a positive meaning. It's like seeing the colour in a shady grey or in a lighter version of the full, radiating colour. Our life on earth is a constant dance between light and matter. In the evolutionary colour map, spectral colours and pigments are all represented. All colours are experienced through the veils of dark and light.

Figure 3: Evolutionary colourmap, Illustration by T. Moor 2016.



### THE EVOLUTIONARY COLOURMAP FOR HEALING AND SELF DEVELOPMENT

In my Dutch book\*: 'In je kracht door kleur' which means: 'Empower yourself with colour', I reveal a new colour system. A map to help you work through your difficulties in life and create a lighter version of yourself. It helps you to evolve more quickly and become more authentic every time you work it through.

#### This colour system comprises four colour dimensions.

- The first dimension is Dark-light: We all see our world through the veils of our past. We see dark, light and somewhere in between, in shades.
- The second is the Red dimension: The colours of this dimension are also known as the spectral colours or the seven colours of the chakra system.
- The third is the Terra dimension: These colours are corresponding to the seven chakra's in the legs, connected with the earth colours. They stand for the roots or our existence, which help us incarnate in our bodies.
- The fourth is the Magenta dimension: These colours are corresponding with the seven chakras in the neck and the arms, as the wings to our freedom. The theme resonates on egoless contribution. They help us to make the connection with the other person, situation or matter. Sustainable entrepreneurship, community thinking and authenticity are part of the Magenta dimension.

The first step requires us to grow our roots in order to be able to spread our wings. When we refuse to connect to our host, Mother Earth, we are not able to create according to our evolutionary plan.

**Better said: When you want to contribute and live a life that matters, start ground and heal your body and your past. Transform pain into wisdom and merge darkness with light. Balance yourself between matter and light, and you will become resilient, flexible, resourceful and creative in every aspect of your life.**

### **Connect to the quantum colour frequencies**

Taking the evolutionary colour map for healing and empowerment as a guide, we learn that every colour has its own frequency and is, therefore, a carrier of data. Learning to merge with the colour frequencies allows us to heal on a deep, foundational level. Every colour has a developmental theme and draws you into the non-dual existence of the crystalline colour. I call these quantum colour frequencies – the place where we are everything and nothing simultaneously.

**Open your senses to really start feeling colour for what it is: the true quantum colour frequencies. You must be honest with yourself about what you feel. By doing so, you help yourself embody this big, beautiful cosmic energy creature who lives underneath your appearance, behavioural patterns and emotions.**

What you feel when you step into the room, reveals more of who you are than what we see. This unspoken truth we feel, our intuition, is stronger and more active than most people believe. Colours help us to become acquainted with our intuition because of their pure frequencies.

Some people spend a lifetime searching for their roots, trying to understand what happened, because life as they know it doesn't represent the person they silently and secretly know they are. Connecting on a quantum frequency level with colour helps in this process of soul-searching.

### **WHAT IS NEW?**

In the well-known chakra system, red is connected to our base, the ground or our root system. In the evolutionary colour map, this base chakra is only the mountaintop of the iceberg which lies underneath – the little explored earth colours.

In order to become more whole, it is important to connect heaven and earth, light and dark, head and heart, and energy and matter. We incarnate in a body when we are born. We immediately resist the confinement of our bodies when we become aware of the separation. To connect into this duality in which we live, we need to come into our body, instead of flipping out of them.

Learning to truly connect with these earth colours will give us a feminine response to a masculine oriented world, as these colours resonate the powers of Mother Earth, the soothing and nourishing qualities of every single person. We all have masculine and feminine energies running through our systems. In order to live a balanced life, we need to know and be able to fully experience both.

**When you are able to embody every cell of your being, you immediately start living a healthier and happier life, a life that matters, literally.**

For experiencing the earth colour frequencies, please visit [kleurveoel.nl/earth-colour-experience](http://kleurveoel.nl/earth-colour-experience) and download the free meditation.

### **REFERENCES**

Ruiter, M. 2016. *In je kracht door kleur*. Geesteren, the Netherlands, A3 boeken, ISBN 9789491557279.

# The imagined Body (2001-2021)

**Claudia Bonollo** <sup>1,\*</sup>

<sup>1</sup> Claudia Bonollo, Artist, architect, colour consultant, eco & biophilic designer and researcher with a multidisciplinary background. Claudia Bonollo developed different research projects and didactic activities. Graduated from the International University of Art, she completed her degree in 1990 at IUAV in Venice. Took part in Bruno Munari's liberating laboratories. Post graduate studies and training in London (Bartlett School of Architecture) and in Madrid (ETSAM), where she founded and directed the ATELIER CROMATICO, (former ATELIER META-MORPHIC) an international platform for arts and research on colour.

[www.claudiabonollo.com](http://www.claudiabonollo.com) / [www.lecorpssimagine.com](http://www.lecorpssimagine.com); blog: <https://claudiabonolloatelier.wordpress.com/> / <https://creativeinsomnia.wordpress.com/>; linkedin: <https://www.linkedin.com/in/claudia-bonollo-01085b13/> / Facebook: <https://www.facebook.com/claudia.bonollo/>; instagram: #claudiabonollo

\* Corresponding author: [info@claudiabonollo.com](mailto:info@claudiabonollo.com)

**Keywords:** *The Imagined Body, Inner Landscapes, Sensitive Spaces, Cartographies of Being, Colour And Emotion*

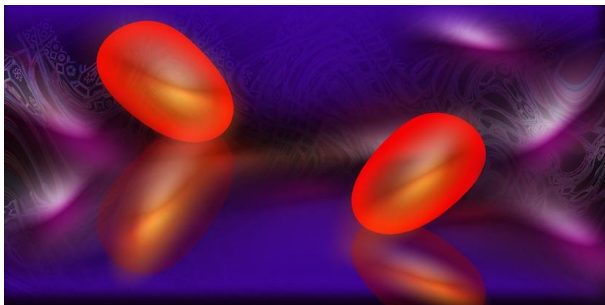

Cells in love, Metabiologies – The Imagined Body - © Claudia Bonollo.



## **INTRODUCTION**

My research THE IMAGINED BODY, was born in 2001, twenty years ago, with the title BEAUTY IS ITSELF A CURE in an attempt to create through art, architecture and colour, a multisensory project that would bring a different point of view on human body, disease and healing.

My starting point was the histological report of a hopeless pathological cell, the scientific data of the disease that I poetically transformed with the computer and its algorithms. I was looking for a gesture of redemption, something that could find a mysterious connection between disease and beauty. The possibility of a vision that went beyond the relentless statistics and that was capable of overturning the "panic" in Echo, his nymph. In short, I was looking for a different awareness of the disease, a dialogue with the cell that took into account its polarity.

When it all began, I would never have suspected that the evolution of my research encompassing the whole human body, emotions, happiness and the holographic paradigm (a controversial hypothesis proposed by the latest scientific studies), would lead me to a multidisciplinary project with multiple applications.

Transfigured cells (cells are transformed into a map of consciousness), biological landscapes (cartographies of being in which the body is represented as a sacred object), sensitive spaces (virtual surroundings, projections where one can experience various levels of well-being), chromatic narratives (short films and different experimental techniques of visualization with colours) applied in the "therapeutic liberating laboratories" with international psychologists and therapists, have been transformed over time into a multidisciplinary project of *therapy as art*.

Keith Floyd, a psychologist at *Virginia Intermont College*, underlined that reality is nothing more than a holographic illusion, thus we could no longer claim that the mind creates consciousness (the philosophical motto *cogito ergo sum*). On the contrary, it would be consciousness that creates the illusory sensation of a brain, a body and any other object around us that we interpret as physical. Such a revolution in the way we study biological structures leads researchers to claim that medicine and everything we know about the healing process could also be transformed by the holographic paradigm. Indeed, if the apparent physical structure of the body is nothing more than a holographic projection of consciousness, it is clear that each one of us is much more responsible for one's own health than current knowledge in the field of medicine is



willing to recognize. What we now consider miraculous healings may actually be due to a change in the state of consciousness that causes changes in the body hologram. Likewise, it may be that some controversial alternative healing techniques such as visualizations are so effective because in the holographic domain of thought, images are basically as real as reality. (See Dr. Richard J. Boylan, *Consciousness and Visualization*).

I am indebted to the unexpected contributions of professionals from different fields of knowledge (art critics, philosophers, anthropologists, doctors and therapists, biologists, neurobiologists, mathematicians, physicists, psychoanalysts, psychologists and theologians) who have shown interest in my work.

The *mundus imaginalis* referred to is the *intermundi* described by Henry Corbin's studies. It is an intermediate world, suspended between the celestial and the earthly, in which all transfigurations are possible, representations become hierophanies, displays of the sacred. The imaginary can be harmless, active imagination never is.

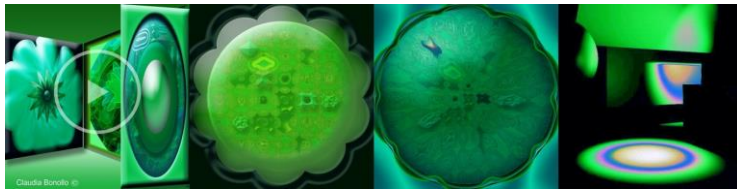

Heart's Rooms – interactive installation – – The Imagined Body - © Claudia Bonollo.

The study of texts related to Iranian worldviews, Ib'n Arabi, Sohrawardi and especially Najmuddin Kobra, an 11th century mystic, have contributed to an artistic work that is even more attentive to the phenomena of light and colour. As Corbin says in one of his famous conferences in Éranos - If we want to recover *the imaginal*, we must first recover its organ, the heart, and elaborate its philosophy. This imaginative rhetorical capacity is the *himma* that Henri Corbin speaks of in his study of Ibn 'Arabi. "That power of the heart is what specifically designates the word *himma*, a word whose content perhaps better clarifies the Greek term *enthimesys* which means the action of meditating, imagining, projecting, ardently desiring: in other words, of having (something) present in the thymus, which is vital force, soul, heart, intention, thought, desire. (*Ibidem*, p. 224)

As I had already foretold, my research was not an achievement but the beginning of something. It all started as a project on active imagination and the body in order to create through art (a discipline crossing many borders) a healthy and transformed body. This was only the starting point.



The Chakras' rooms - – The imagined Body – © Claudia Bonollo.

### THE INNER COLOUR

Colour is a fundamental element of my work and research. Not only or not so much the colour, pigment or matter, the chromatic layer that embellishes things, but the colour-light, the colour as the primary element of vision and metamorphosis, the colour that makes visible things that are not yet so, the threshold colour suspended between different and apparently irreconcilable worlds, unclassifiable, incomprehensible, impossible to categorize. Colour as an inner landscape. Colour as a generator of sensitive spaces.

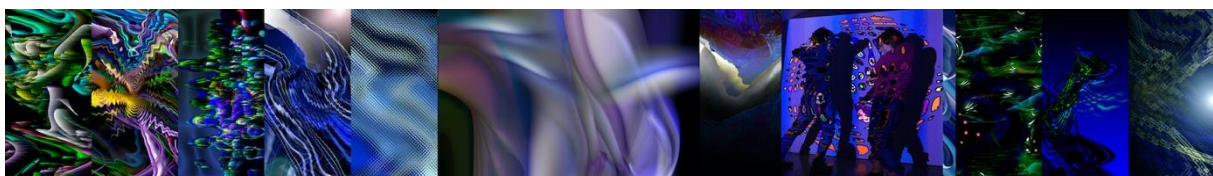

"Metamorphosis" – The imagined Body – © Claudia Bonollo.

## **THE RESEARCH: VOYAGE WITHIN THE BODY**

*In the fable of Eros and Psyche narrated by Apuleius, Pan protects Psyche from suicide. Heartbroken, loveless, denied divine help, the soul is possessed by panic. Psyche is made in the river that rejects her. In the same moment of panic, Pan appears with his other thoughtful side, Echo, and persuades the nymph to some natural truths. Pan is both destroyer and preserver, and his two aspects appear to the psyche in close proximity. When we panic, we never know if it will be the first movement with which nature is about to make us aware, if we are able to hear the echo of the reflection, a new vision of itself. James Hillman, Essay on Pan, 1977.*

The Imagined Body is a sort of mythical journey. The myth is an open book of infinite interpretations and diverse versions. My mythical journey is not a circular journey like the *Odyssey* but a crossing that transforms with the purpose of a deep metamorphosis.

Each twist of fate can have its own interpretation and its own beauty. The nostalgia for beauty that the human heart harbours is never taken into consideration, not even to heal. And the simple use of this word has created more than one problem for me.

The beauty I was referring to, in the initial title of my research (Beauty is itself a cure), does not have an esthetical value. It is not the classic beauty nor is classically interpreted, but represents a possibility, a threshold where “panic could turn into the nymph Echo and transforms its destiny” (Hillman). It is the beauty recounted by Rilke in his *Duinese Elegies*, always terrifying at the beginning as it overcomes us, and because of its edge condition, is a key to meanings.

Umberto Galimberti reminds us that the destruction of the body’s symbolic ambivalence and the introduction of a disjunctive logic separating the good (the soul) from the evil (the body) damaged the body. The body was transformed into “the soul’s tomb, the place where for the time being the soul is interred”. My work suggests to overcome this limit.

## **GRAPHIC AND VISUAL MATERIAL: FROM BIOLOGY TO THE METABIOLOGIES**

My artistic work developed digitally and changed a lot over the years. To my first collection of images on a histological sample, I have added transmuted cells taken from the liver and the colon; I have studied the functioning of our immunological and nervous system, the sight, the brain, the dream activity, the biological concept of wellbeing and pleasure.

Each transformed image, be it a cell or a neuron, or an inner landscape is digitally created in such a way that it can be enlarged on large scale. It can be printed on any material, a rigid or soft support, opaque or transparent.

The ensemble of these narrative metamorphoses can be turned into sensitive spaces, ephemeral and multisensorial installations, little books or short films (whose duration is variable) to be projected on a wall or some screens.

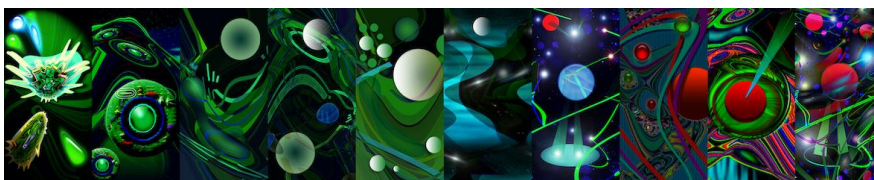

The Inner Cosmos – The imagined Body – © Claudia Bonollo

## **THE ORIGIN: THE INITIAL REPRESENTATION OF THE DISEASE**

I have transformed sick cells into stories, myths, homecomings. Emerald visions, auroras in which pink is morning and evening knowledge – *cognitio matutina et vespertina*. I have changed their colour, scale, I have folded them on themselves, I have crossed them, I have turned them into cosmos, galaxies, I have illuminated them with coloured lights.

I have tried to "inform" each diseased cell, I have tried to dialogue with its nucleus, to reorient it with chromatic analogies. I have gone through the colours, whatever their evidence was. Choosing between the

colours of the pathology (the analysed and coloured tissues reveal the disease in a histological sample), the intermediate state, the weak states in their weakness. Not *mysterium tremendum*, but *mysterium fascinans*, to transform a vicious circle into a virtuous one.

If cancer cells have a different time with respect to the others, I have worked on files used by some schizophrenic patients to heal themselves, described by James Hillman in his essay "On Paranoia."

I have treated the pathogenic cell as a delusional paranoid cell, as if it were the victim of a mental imbalance. Going through this appearance, I've used the imagination to heal the imagination, in an attempt to avoid a common mistake, common to many believers: the fear of doubt.

### **HEALING IMAGES: A DIALOGUE WITH THE DISEASE. THE ORIENTATION**

This voyage within the human body has soon become a cycle of tales, with their own discoveries and wrecks. A sort of visual diary, scheduled by a cyclic rhythm, in the tiring process of metamorphosis. Those circular landscapes, changed by colour, created with minimal variations and tempos that constantly revealed the obscure meanders of the internal, the unconscious, were the source of many stories, stories that I told to my audience in order to examine the subject in depth. They were their own stories.

This work that identifies itself, "that is absorbed in the other" is an entropathic process of vivification that includes the action of meditating, conceiving, imagining, ardently desiring. Creating with art is giving life, building a regenerative movement.

The artist is both creator and creature. He/she cannot be himself/herself without the second person, without the you, that is, without the image that reflects himself/herself, because it is with her/his own eyes and at the same time with the eyes of the other, that he/she looks at himself/herself.

The pathological cell transforms itself into a body of light that imagines its own liberation.

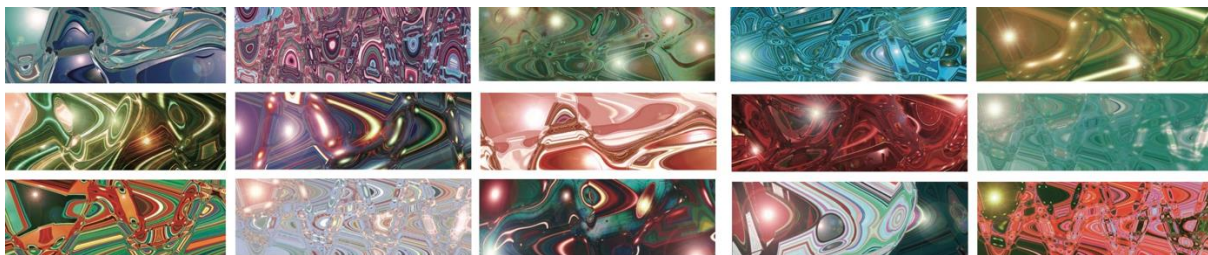

Journey inside the Intestine - The Imagined Body – © Claudia Bonollo

### **THE ENCOUNTER WITH BIOLOGY**

I took biology lessons. What are my visions? Are these cells or not? Which was the criterion for selecting colours? What is colour according to biology? What is the scale? Does colour cure? What is contained inside my images and why do they enact such a strong emotional response? Why are they either relaxing or frightening? What does it make alter heartbeats and salivation while watching transmuted cells? I could not find any definite answers, but had some surprising revelations; in my hybrid images, there were fragments of human body at a microscopic scale and mitoses of healthy cells. I had guessed the functioning of cancer without having studied it and sketched recognisable cells starting from a histological sample, almost unreadable. The meetings with the biologist became more regular and offered new and stimulant viewpoints on my research. I was put in contact with Professor Walker's work (Hull University). During the past twenty years, Dr. Walker has been proving that the power of imagination and hypnosis is effective in treating patients suffering from cancer.

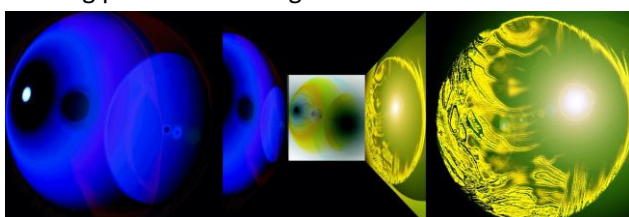

The Contemplation Room I - Cell Tryptic: Indigo Mitosis/Projections Room/The Golden Cell – installation - © CB



## **THE CELL**

The word cell comes from the Latin *cella*, literally a small room. Originally it indicated the subdivision of a larger space. In the late Latin, the “cell” becomes the room of a monk and only later does it become the definition of a specific place, the basement or the cellar, as if to allude to its deep and hidden meanings. In an eighteenth-century scientific glossary, the word cell refers to a part of the brain that is the imaginary seat of some faculties that are not specified. In the early twentieth century, the term is associated with the current meaning of enclosed space.

The cell is the absolute protagonist of my research THE IMAGINED BODY. I imagined it, studied it, analysed it, transformed it with new vivifying movements, I seduced it with lights and colours, I cured it through my personal therapies, I admired its beauty in my stories of metamorphosis, movements and narratives, I made spaces: ephemeral architectures and installations.

## **SHAMANIC ART?**

Galimberti warns us: “today the vision of science represents the real and it has changed our point of view on the world, the subject is reduced to be another object of this world. Our senses are no longer a way to open up to the world and live in it, but scientifically seen just as organs and functions. We abandon our experience to adopt an idea, which aims to be valid for everyone, in all times and places.”. (See Umberto Galimberti’s essay on the body)

"What is art? Why is it called that way? Who called it art? Who owes its definition? Emmanuel Kant or Joseph Beuys, Deleuze or Virilio, or neither of them? You or me? Art, originally, was not what it is today. It was not a painting or an object to hang somewhere, it was not a sculpture, it was not a video, it was not a contest reserved for under thirty-five, it was not classified, it was not to participate in the “biennali”, It was not being collected in museums, art was just ART. It was the art of living. Even today, the first art at all is that of being in the world. The most difficult is to be well in it. The multi-mediality and technology in which we live have brought us in contact with every possible expressive potentiality that undoubtedly improves our understanding. With which, paradoxically, today, while everyone can choose his own medial path, art returns to the shaman, to whom it teaches the greatest art in the world, which is of course THE ART OF LIVING. Today that we have to survive too many stimuli and harmful effects, today that our being is threatened by continuous catastrophes: the loss of happiness, love, unity with oneself, with the cosmos in which our ancestors lived... (From Maria Grazia Torri’s article, published in Kult, November, 2002).

The encounter with Gérard Baraillé, a French psychoanalyst who gave up psychotherapy for art, raised many questions. Who is the shaman? Does art cure? What are the myths of a recovery? Was Orpheus the first shaman?

## **STORY TELLING: INTERGEDANKE**

“Watching the sun descending behind a hill covered by flowers, wandering for a long time in a great forest without thinking about the return, being on the bank of the river fixing a distant boat, contemplating the flight of the jungle geese that appear and disappear among the clouds ... All these states of mind are contained in a single word: *hintergedanke*, that means, perception that occurs silently, in the background of the mind.”

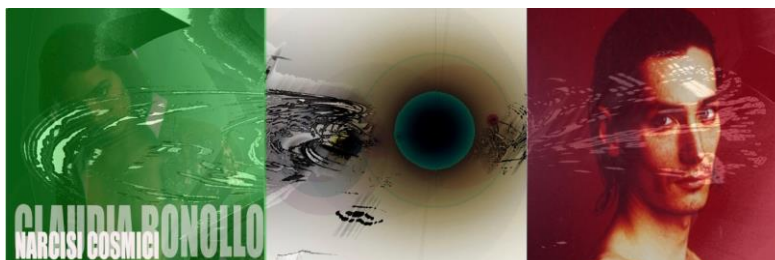



### ***COSMIC NARCISISSUS AND THE PORTRAIT INSIGHT***

In Narcissus Joachim Gasquet states that "the world is an immense thinking Narcissus". Where should he be thinking if not before his own image?

After the cells-cosmos, I have lately inserted other figures. They are portraits of people, friends and acquaintances. Maybe they are not even portraits, but reflections. The images are reflected on cells or on physiological processes linked to moods. Sometimes the image is clear, others is dissolved in thousands of colours and turned into an abstraction.

Narcissus does not only look at himself, but also at the microcosm secluded in his own body and becomes aware of his image's complexity. He is seduced by the reflected endorphin-cell (with a healing subliminal message) and cured by a shapeless image that is imbued with the fertile power of corporeality and erotic energy. He is thus induced to self-healing.

### ***CELLULAR AND SENSITIVE SPACES***

I have also created a series of installations, cells-spaces where a more active participation of the spectator is intended, who is an integral part of the work. "The viewer is not simply subjugated or seduced, he allows himself to be seduced, he succumbs to his own free will, contributing to his physical-physiological system as a tool for building that non-material sensitive space ..." ... "In a cellular portrait, the body escapes from its own cutaneous limit, even energetic or thermal, of its presence, to project itself freely on the architectural support, cancelling its materiality and replacing it with a new, more flexible and immaterial boundary. The inside-out body thus becomes a tool for the sensory construction of the space of unlimited possibilities, whether they are merely aesthetic or more specialized, ritual, therapeutic, religious, or hypnotic. The value and importance of Bonollo's work does not lie at all in its effects, which are mainly therapeutic for the portrayed person, nor in its material or aesthetic qualities for the non-portrayed external viewer, but rather in its possibilities as a tool, in its constitution, as a system with its own laws. In Bonollo's work there is only body and space." (Fernando Quesada, Claudia Bonollo's Cellular Spaces).

The interest in the mystical visions of Sufism and in the studies on active imagination illustrated masterfully by Henri Corbin, induced me to attend the intense annual meetings of philosophy, theology and history of religions, organized by the CEEC (Centro Estudios Espirituales Comparados) in Arena de San Pedro (Ávila-Spain). The artistic and theoretical work was selected by Bernard Légé, Head of Research Projects and Delegate of "Image et Science" in Paris and by the Director of CAMERA (Conseil Mondial pour les Études et le Réalisations sur l'Art) in France.

### ***THE CONTEMPLATION ROOM/ QUANTIC ROOMS/INNER LANDSCAPES***

The Contemplation Room is an interactive series of video installations with transformed biological or abstract images focused on colour and emotions and showed in a loop with a timed session that enacts the bystander's emotional reactions. The chromatic rooms and the colour's holograms are the result of a creative process based on an endless moods investigation: the colour-emotion becomes space, a path that is built from within, narration, contemplation, a tool for designing and building meta-architectures that are born and transformed by colour and whose colour causes transformations in us all. Attracted by the idea of architecture as an interior mirror, in which intimacy becomes landscape, I have created "total installations" where I combine light, colour, projections. In my sensitive spaces, senses and the dormant parts of the brain are stimulated and endorphins are activated. Thought-architectures become virtual and changing environments as thoughts are changing, chromatic narratives (short films and different experimental techniques of visualization with colours) converge in a narrative architecture that becomes the very essence of consciousness.

# Auricular chromotherapy for the treatment of psychological trauma

Daniel Asis <sup>1,\*</sup>

<sup>1</sup> danielasis1953@gmail.com

\* Corresponding author: danielasis1953@gmail.com

## Abstract

Auricular chromotherapy has shown promising results in the treatment of psychological trauma . With its relatively easy and quick technical application, this procedure, could be an indispensable tool for therapists. However, its mechanism of action is not yet understood completely.

Objective: To treat patients suffering from trauma, and PTSD, with auricular chromotherapy.

Materials and Methods: The protocol was applied in 160 patients (135 who experienced traumas; 15 patients with specific phobias and 10 patients with panic disorder). They are 134 women, 26 men, ages 20–60.

Results: The treatment showed 93% of positive response.

Conclusion: This procedure shows the possibility of drawing a path from the external ear to traumatic memories, anxiety disorders and phobias.

**Keywords:** *Auricular Chromotherapy, psychological trauma, PTSD*

## INTRODUCTION

The discovery of auriculotherapy goes back to the year 1956, when Dr. Paul Nogier, from Lyon, France, presented his first article on “The ear pavilion and reflex points” at a conference in the French Society of Acupuncture. In this paper he describes in detail the “cartographic” or somatotopic pattern of the human body on the human ear pavilion.

An easy, practical way of finding a point is to press a thumb with a clamp, causing a certain amount of pain; after a few minutes it is possible to identify the corresponding point in the ear; it is quite a painful area. It is possible to verify a decrease of electrical activity in the same spot, which can be measured with an ammeter type device. When the clamp is removed, both events, the pain and the electrical decrease, disappear within minutes (see Figure 1).

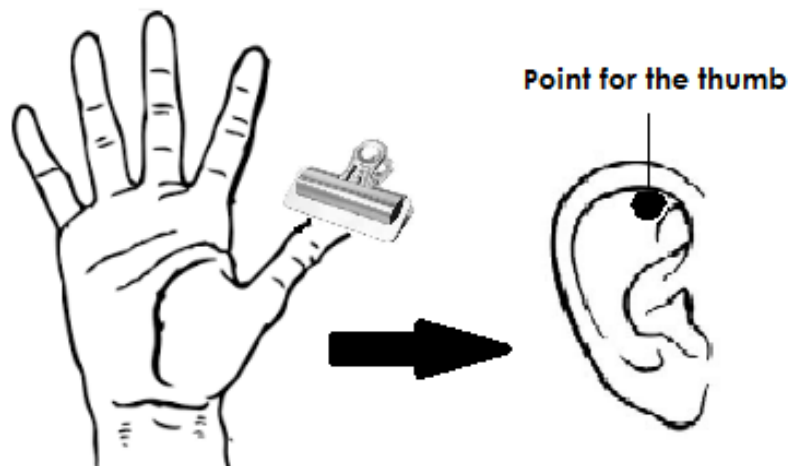

The stimulation of an auricular point generates an afferent stimulus which will reach the Reticular Formation, the Thalamus and the Cortex; this elicits visceral and somatic cortico-limbic responses and hormonal responses as well. Descending pathways from the Reticular Formation will reach the horn of the dorsal spinal cord after opioids and other neurotransmitters (like serotonin) produce an inhibitory, efferent, central-origin, response to pain. It is important to highlight in this brief description, the influence of auricular therapy on the higher-level structures of the Limbic System

(Hippocampus, Amygdala, Thalamus, Cingulate Gyrus) where emotion and memory regulation functions are located.

The fact that the ear lobe represents the Central Nervous System is easily verifiable in patients with a history of psychological trauma, because both ear lobes are painful to palpation. At first, the effect of laser and yellow pen applied to the hippocampus, amygdala, and 'psychic scar' areas of the ear (Figure 1) (Nogier 2009) were studied for the treatment of emotional trauma.

In Post-Traumatic Stress Disorder (PTSD) (DSM-IV 1995) individuals develop a group of symptoms in the aftermath of a severe emotionally traumatic event, especially re-experience (e.g. flashbacks, which can occur spontaneously or in response to reminders of the traumatic event), avoidance (e.g. avoiding situations that remind the individual of the traumatic event) and hyperarousal (e.g. exaggerated startle response).

It has been hypothesized that PTSD is characterized by exaggerated amygdale responsivity, abnormal activation and reduced hippocampus volume, the rostral anterior cingulated cortex is hyporesponsivity and initial evidence suggests that the dorsal anterior cingulated cortex may be hyperactive (Shin and Handwerker 2009).

The formulation of this technique was a combination of three different areas: Psychological trauma, Auriculotherapy and Chromotherapy.

Chromotherapy is the treatment of several different pathologies using the interaction of specific electromagnetic wavelengths with biological systems.

### **AURICULAR CHROMOTHERAPY PROTOCOL FOR THE TREATMENT OF PSYCHOLOGICAL TRAUMA**

Dr. Daniel Asis-Dr. Federico Zarragoicoechea

1. Both lobes are palpated in order to find the most painful points or two points that might be painful.
2. Then the patient is asked to close his /her eyes and to try to remember the most terrible image of the trauma, at least for one minute.
3. After that, the patient is asked to tell which emotion accompanies the image (anxiety or sadness) and describe the intensity of this emotional perturbation, on a scale of 0 to 10, which is called the SUDS Scale (Subjective Units Stress).
4. The patient will tell, which negative words or thoughts accompany the image, for example « I will never overcome his/her death » (Negative Cognition).
5. The patient is asked, which body sensation links with the emotion (oppression in the chest, for example).
6. The positive points will be detected using a pressure probe (painful points), electronic detection or using the pulse on the antitragus and the border.
7. The points will be treated with a yellow light chromopuncture device , and the patient is asked to maintain the traumatic image in mind.
8. The expression on the face, respiration and gestures will be observed.
9. Then wait for 2 minutes, and ask the patient to describe the image, generally, the image will disappear.
10. Measure once again with the help of the SUDS scale, which willgive a very low score (0 - 2).

Material and methods:

The 'Dr Asis and Dr Zarragoecoechea protocol' was applied.

## RESULTS

The distribution of trauma reasons/number according gender was as follows

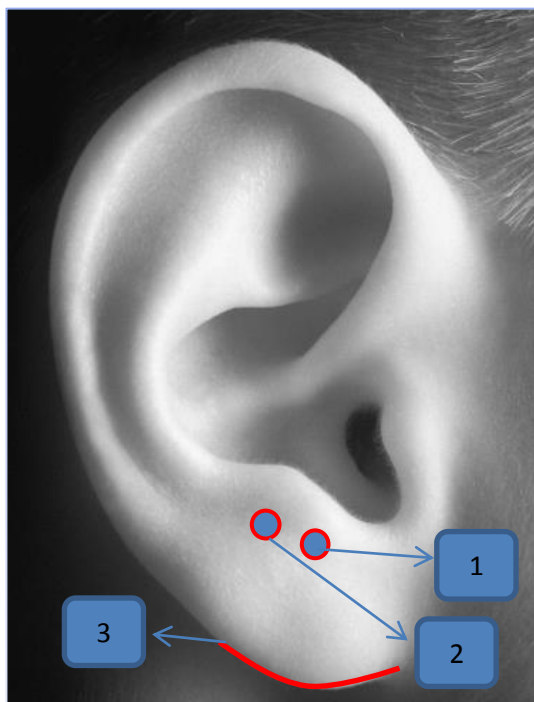

Figure 1: Psychic areas in lobe: 1. amygdala 2. hippocampus. 3. psychological scars

The results showed, 149 patients (93%) reported that the traumatic image and emotional pain connected with it was erased completely or almost completely. Eleven of them (7%) reported no deleted image (1 ♀ traumatized by brother in prison, 1 ♀ suffering after the abortion, 1 ♀ traumatized by fighting with her husband, 1 ♂ and 1 ♀ traumatized by a car accident, 1 ♀ traumatized by breakup, 1 ♀ family accident, 1 ♂ family illness, 1 ♀ infidelity, 1 ♂ and 1 ♀ after panic attack), but all of them with a failure response were said to have felt a little bit better after treatment. In short, this is 93% positive response.

Cause of trauma	Men	Women
Abortion	0	8
Aerophobia (Fear of flying)	1	5
Agoraphobia (Fear of elevators)	1	1
Amazophobia (Fear of driving)	0	4
Assault	2	8
Breakup	1	3
Brother in prison	0	1
Car accident	2	4
Childhood Trauma	4	11
Divorce	0	4
Family accident	0	1
Family death	5	25
Family fight	0	8
Family illness	2	7
Fight with friends	0	1
Homophobia	0	1
Hospital trauma	0	2
Husband whipping her	0	1
Illness anxiety disorder	1	2
Infidelity	0	12
Kidnapping	0	1
Legal problems	1	1
Loneliness	0	1
Marital abandonment	0	2
Panic Attack	1	9
Saw uncle in the coroner's office	1	0
Sexual abuse	1	8
Somniphobia (Fear of sleep)	1	0
Suicide	0	2
Thalassophobia (Fear of the ocean)	1	0
Unemployment	0	1
Workplace fight	1	0
<b>Total</b>	<b>26</b>	<b>134</b>

## **DISCUSSION**

Having used this simple and easy technique for almost 14 years the results found have shown considerably positive results.

A final thing to note is that during follow-ups most of the patients continued to have the positive effects of the treatment even after many years.

## **CONCLUSION**

This procedure shows the possibility of drawing a path from the external ear to traumatic memories in the brain, and to apply on the ear lobe a kind of dressing, with yellow color, on the emotional wound 'living' in the amygdala. These findings pave the way for other similar experiments connecting diseases of the mind with the external ear, depending on the confirmation which future research can bring.

## **REFERENCES**

- Asis, D. et al. 2009. *Cromo-Psicoterapias – cromoterapia auricular, Cromo-TIC, Anteojos Cromoterapeuticos*. Ediciones Lux, Santa Fe. Argentina.
- DSM-IV. 1995. *Transtorno de Estresse Pós-Traumático*. Editora Artes Médicas. Porto Alegre. São Paulo, Brazil.
- Shin, L. M. and K. Handwerker. 2009. Is Posttraumatic Stress Disorder A Stress-Induced Fear Circuitry Disorder? *Journal of Traumatic Stress* 22(5, October): 409-415.
- Henckens, M. J. A. G et al. 2009. Stressed Memories: How Acute Stress Affects Memory Formation in Humans. *The Journal of Neuroscience* 29 (32): 10111-10119.
- Levine, P. A. 1999. *O Despertar do Tigre – Curando o Trauma*. Summus Editorial: São Paulo.
- Lu, D. P. 2010. Using alternating bilateral stimulation of eye movement desensitization for treatment of fearful patients. *General Dentistry*, May/june. [www.agd.org](http://www.agd.org).
- Shapiro, F. 1999. Eye Movement Desensitization and Reprocessing (EMDR) and the Anxiety Disorders: Clinical and Research Implications of an Integrated Psychotherapy Treatment. *Journal of Anxiety Disorders* 13( 1-2): 35-67.
- Nogier, R. 2009. *Auriculotherapy*. Thime Publishers. Stuttgart, Germany.
- Ray, N. J., S. Fowler, and J. F. Stein. 2005. *Yellow Filters Can Improve Magnocellular Function: Motion Sensitivity, Convergence, Accomodation, and Reading*.

# Principles of regenerative therapy with low-intensity laser, colour, ultrasound and magnetic field (coMra)

Arzhan Surazakov <sup>1,\*</sup>

<sup>1</sup> Radiant Life Technologies Ltd; arzhan@radiant-life-technologies.com

\* Corresponding author: arzhan@radiant-life-technologies.com

## Abstract

For decades the main focus of global public health has been on the quantity of years lived, even though the quality of living those years is declining. The burden of disability as a result of chronic diseases is rapidly growing worldwide, due to the simple fact that methods of fighting against various causes of death are not suited to the purposes of building up health. We propose that therapeutic technologies that enhance the quality of health should follow the same fundamental principles that underpin the organisation of life at all levels: regeneration, self-sufficiency, evolution, interconnectedness and intelligence. The regenerative technology of coMra therapy implements these fundamental principles of life by combining low-intensity laser, colour, ultrasound and magnetic field into a united coherent vortex that comprehensively supports self-regeneration of the body.

**Keywords:** *coMra, low level infrared laser, magnetic field, ultrasound, colour LEDs, regeneration*

## INTRODUCTION

Healing with light, colour, magnetic field and sound holds a remarkable opportunity for improving the quality of health through regeneration. This opportunity is particularly important owing to an urgent need for holistic medical technologies that are safe, effective and supportive of the natural self-repairing ability, immune defences and self-sufficiency of the body.

Introduced in 2009, the technology of coMra therapy represents a concept of supporting the body's innate ability to heal itself through regeneration. The technological developments that form part of coMra therapy were brought about mostly during the 20th century, with the development of biophysics and therapeutic applications of colour, ultrasound, laser and magnetic field. The introduction of coMra therapy followed the vision of synthesising these radiances into a united coherent vortex that comprehensively supports regenerative processes in the body. The method of such synthesis was inspired by the fundamental principles of life.

Previously we described the biophysics of coMra therapy (Surazakov et al. 2020). In this paper we introduce the conceptual background of coMra therapy and our vision for supportive regenerative technologies in general.

## FROM QUANTITY TO QUALITY OF HEALTH

The main focus of global public health has been on the quantity of years lived, even though the quality of living those years is declining. The largest systematic study of the global burden of 369 diseases and injuries revealed that life expectancy from 1990 to 2019 has increased in 202 out of 204 countries and territories (Vos *et al.* 2020). Undoubtedly, this marks a remarkable and most welcomed achievement. However, the study also revealed stagnation and even degradation in the quality of health, measured as the number of years lived with disability. There is a nearly universal trend towards increased disability due to chronic diseases such as diabetes, musculoskeletal conditions and mental disorders. And most strikingly, in many countries with very high healthcare expenditures the overall burden of disease started to worsen, as a result of disability.

The key challenge of the global increase in disability is that methods of fighting against various causes of death are not suited to the purposes of building up health (Ayres 2020). This is clear to see if we consider cell injury, a cornerstone of manifestation of a disease. The vast majority of methods in

medical practice today eliminate cause of cell injury or block pathogenic responses. For example, if a person is experiencing weakness due to atherosclerotic plaque that is reducing blood supply to the heart, then the plaque can be mechanically removed. But if the weakness is caused by deterioration of the heart muscle, then the problem cannot be simply removed or blocked. The symptoms will persist until the structure of muscle cells is restored to a healthy state. Therefore, treatments that work exceptionally well in emergency medicine and prevention of death, in cases of chronic heart failure, chronic kidney disease, diabetes mellitus, osteoarthritis, etc., do very little in terms of quality of health.

There is an urgent need for medical technologies designed for the effective repair of injured cells, organs and systems of the human body. As the study of the global burden of disease suggests, this universal challenge is not solvable by increasing spending on the same paradigm of medical care. A conceptual shift is required to develop medical technologies that promote physiological health.

## ***FOUNDATION FOR REGENERATIVE MEDICINE***

We propose that therapeutic technologies that enhance quality of health should follow the same fundamental principles that underpin the organisation of life at all levels. A number of such principles have been formulated, for example see Capra and Luisi (Capra and Luisi 2014). For the purposes of this article we use a simple and self-evident approach to describe these principles and show how they could form a foundation for supportive regenerative technologies.

### **Principle 1. Regeneration**

By looking at gradually disappearing skin cuts we can easily see that our body heals itself through regeneration, an inherent ability of all living organisms to self-renew (Carlson 2007). Consider a single living cell. Every moment it faces the threat of disintegration. To counteract that threat and to maintain internal order, the cell absorbs energy and matter from the environment and completely rebuilds itself. A cardiomyocyte, for example, replaces nearly all its molecules in about two weeks. In a similar but much slower way, a multicellular organism recreates itself via cellular regeneration (maintenance regeneration). When conditions change, the body also changes by rebuilding itself in an adjusted form (adaptation). And if trauma or disease has damaged the body, it starts to mend the affected tissues (injury induced regeneration).

The human body has a relatively limited capacity to self-repair, and although regeneration is initiated after injury or disease, this frequently results in forming a scar instead of normal functioning tissue. Therefore, a technology that supports physiological health must be aimed at overcoming deficiencies of regeneration.

It is important to note that attempts to gain direct control of the body's regenerative ability by using injections of stem cells, or induction of regeneration by biologically active molecules and various genetic methods have not produced an effective solution. Despite colossal research efforts and some 2500 clinical trials, the mechanistic regenerative technologies are far away from routinely restoring tissue after trauma or disease (Badylak and Rosenthal 2017).

### **Principle 2. Self-sufficiency**

In nature an organism can flourish only if it is self-sufficient and self-sustaining in the context of its environment. In human society it is also a common wisdom that the only way truly to help anyone is to help them to help themselves. This implies that a regenerative technology should support the natural ability of the body to self-repair, rather than attempting to replace it. Artificial substitution as a medical intervention may be a last resort or a palliative option, but it is never a sound long term

treatment strategy because it leads to weakness, development of dependency and finally to further degeneration.

Since the ability to self-regenerate is inherent in the existence of all organisms, we need to ask the question – why is it so different even among humans? Why do some people fall ill when exposed to a certain stress, while others do just fine? Why do some people recover from an infectious disease such as COVID-19 in a matter of days, while others become severely ill?

One way to describe these differences is to consider the aspect known as functional reserve, the extent to which the function of a cell, organ or whole organism can be intensified in response to a stressor, without going into pathological dysfunction. We experience high functional reserve when we do not get sick, even in the most challenging situations. For example, elite cyclists can sustain a five-fold(!) increase in metabolic rates during a race without ending up in hospital. On the other hand, a person with low functional reserves may fall ill even after a 5-minute walk. In these circumstances the overall resilience and vitality of the person are decreased, the course of the illness may be extended, with multiple complications such as non-healing wounds, weakened immunity and numerous degenerative changes.

Generally speaking, there are four closely interrelated aspects that may decrease functional reserve (Kurzanov et al. 2016):

- Lack of energy - cells and organs do not have power to function;
- Sluggish metabolism - supply of nutrients, synthesis of new molecular building blocks and removal of waste are too slow in a cell;
- Disregulation - conflicting signals interfere with regulation of flows of energy and matter;
- Lack of positive intent - a person who is severely ill often feels despair and gives up on helping himself or herself.

We used this fourfold framework to demonstrate, for example, why SARS-CoV-2 infections develop along remarkably different trajectories: from completely asymptomatic to a severe course of disease (Surazakov et al. 2020). Furthermore, it is important to note that these deficiencies of functional reserve are not limited only to certain specific conditions. Instead, they are a common denominator of practically all pathologies, stress, failed adaptation and aging (Seppet *et al.* 2009, McCance and Huether 2014).

### **Principle 3. Evolution**

Life is a gentle, natural process of evolution. Even though stress and injury often follow radical and sudden changes, growth, adaptation and healing always proceed at a gradual, step-by-step pace of removal of old or damaged tissue and replacement with newly synthesised structures. Therefore, by evolution we refer not only to changes in heritable characteristics of biological populations but to a broader concept of enhancement of quality of life through the accumulation of small incremental changes.

The implication of this fundamental principle is that natural regeneration cannot be forced by the same high-intensity interventions of fighting against causes of cell injury. A regenerative technology has to be of a supportive, non-invasive quality that is fully compatible with the natural evolutionary process.

Indeed, during the second half of the 20th century research into on a number of low-intensity and non-destructive biophysical stimuli such as laser, colour light, ultrasound and magnetic field showed great promise in regenerative medicine. By 2014 over 3500 research reports and hundreds of clinical trials had been published in the English language on laser therapy alone (Hode and Tunér 2014). Overall, clinical practice has confirmed that when these radiances are carefully tuned to provide a non-



damaging and supportive stimulus the treated cells and organs demonstrate an enhanced ability to regenerate (Kartelishvili et al. 2012; Konchugova et al. 2014; Abrahamse and Hamblin 2017).

#### **Principle 4. Interconnectedness**

Life is fully interrelated, interactive and therefore completely interdependent. All the elements in a human body are so tightly interconnected that in essence the organism exists and acts as one coherent whole. Therefore, it will be correct to say that any biological function, including regeneration, is the sum total of the cooperative activity of an ensemble composed of a large number of individual elements (molecules, cells, organs). These ensembles in living organisms are held together by cooperative and synergistic relationships. But when a very large number of elements interact, the degree of coherency in their actions becomes of paramount importance.

In physics coherence represents the degree of synchronicity between oscillations of different objects or processes. During the last two decades a number of physicists have laid out the theoretical foundation for the "coherent state of living tissue" (Bischof and Del Giudice 2013). The significance of this concept is that from a biophysics point of view, biological efficiency depends on how individual microscopic processes combine into complex macroscopic effects. In the absence of coherence, elements spend their available energy on random movements, leaving little to no energy for their external joint work. The onset of coherence eliminates the "useless" motions, thus freeing energy towards external work. Coherence, therefore, is a natural result of cooperation in an ensemble, owing to its overall energy advantage.

Coherence can be used to enhance function in chemical and biophysical systems (Scholes et al. 2017). And here lies the opportunity for a medical technology that is completely noninvasive and, at the same time, fully supportive of the natural regenerative process. We can increase coherence of living tissue by using external sources of vibration. And since the functional reserve of a cell depends on energy, matter and regulation at the same time, in coMra therapy we use a coherent combination of low intensity radiances to increase the functional reserve of a cell, by raising the efficiency of the four key aspects of functional reserve (Surazakov et al. 2020):

- Near infrared laser and magnetic field induce a state of quantum coherence that leads to more efficient energy metabolism, the capacity of a cell to produce enough ATP under unfavourable conditions of hypoxia, impaired mitochondria, toxic load or elevated cell function;
- Ultrasound induces a state of coherent mechanical vibration that leads to enhanced molecular transport, thus accelerating repair of cell and tissue;
- Colour sequencing, generated with LEDs, produces a coherent sequence of messages that corresponds to the regenerative regulation.
- The safe and effective technology available for use at home creates an opportunity for transforming a passive recipient of complex and expensive medical procedures into an active builder of one's own health.

#### **Principle 5. Intelligence**

How do we distinguish a brick or a robot from a turtle or a human being? One way to answer this question is: self-organisation via self-regeneration from within (Capra and Luisi 2014). So when we describe life, inevitably we come to an intelligent self that is responsible for "its own making".

We define the term "intelligence" from its Latin roots *inter + legere* meaning the ability to "choose between". In its basic form it is the ability of a living organism to discriminate between that which is

harmful and that which is beneficial and to act accordingly. For example, a cell cannot survive without an ability to identify and absorb nutrients, to expel waste, avoid toxins and move away from danger, towards safety. Naturally, this cellular intelligence lies not within the realms of economics, literature or politics, but in the skilled handling of molecules in order to build itself from the inside, extracting and prudently using energy and communicating with other cells in order to cooperate in large groups in the form of tissue, organs or a whole organism. Consequently, the intelligence of the body is a form of collective intelligence of the whole community of cells.

The most important implication of intelligent self-organisation is that the main actor in regenerative medicine is the organism itself that chooses and enacts a response to an injury or disease.

Note that within the boundaries of mechanistic medicine the organising self is temporarily negated because medical intervention is performed by a physician. The patient's body is a passive recipient of a procedure that has a very specific effect on the target process – anti-inflammatory, immunosuppressive, anti-thrombotic, etc.

In a regenerative technology such as coMra therapy, the aim is to support the inherent regenerative ability of the body; the sum total of all self-repair processes carried out by the body in response to injury or disease. This aim is realised by addressing the reduced functional reserves that exist under conditions of high load and/or cellular injury in terms of energy supply, molecular transport and regulation. In other words, the aim of coMra therapy is not a disease-causing agent, pathological process or a symptom, but rather the capacity of a cell to self-repair. For this reason, coMra therapy can be used to support the body's self-repairing ability in practically any pathological state, as well as for supporting general well-being and quality of life.

The beneficial effects of coMra therapy follow the natural stages in healing and recovery. The coMra enhanced regenerative process is first of all manifested as restoration of energy supply within a cell. Symptomatically there is a feeling of relief of acute pain and an increased sense of wellbeing within minutes and hours after a coMra treatment. Once life-sustaining energy-dependent processes are restored in cells, tissue as a whole is able to resume its earlier, suppressed, tissue specific function, such as digestion, muscle contraction, immune function, hormone secretion, etc. Finally, as functionality of individual organs is at least partially restored, modulation of the activity of the central nervous system and the immune and endocrine organs occurs, by shifting the organism from states of acute stress or depletion towards the more physiologically adequate states that are most conducive to the process of healing.

For over 10 years we at Radiant Life Technologies have been introducing coMra therapy to people with a wide variety of different diseases, covering all ages and with the severity of their conditions ranging from minor aches to the most serious illnesses. And the natural outcome of this shift to quality of life is the gradual gaining in confidence in one's ability to handle health challenges and a sense of profound well-being. Once there is a realization that we are indeed in charge of our own health, we also learn how to correct not only physiological but also psychological and life style imbalances that lead to diseases in the first place.

## **CONCLUSION**

Our vision for holistic regenerative medicine is one of intelligent cooperation with life. The vision becomes reality once the fundamental principles of life are used as guidelines for creating life-supportive technological solutions, conducting research and supporting every individual in becoming self-sufficient.

## **ACKNOWLEDGEMENTS**

We are grateful to the late Théun Mares who inspired the vision behind this article. The author, Arzhan Surazakov thanks his colleagues at Radiant Life Technologies for support and insightful discussions. Charles Mitchley provided support with the English.

## **REFERENCES**

- Abrahamse, H., and M.R. Hamblin. 2017. *Photomedicine and Stem Cells*: Morgan & Claypool Publishers.
- Ayres, J.S. 2020. "The biology of physiological health." *Cell* 181 (2):250-269.
- Badylak, S., and N. Rosenthal. 2017. Regenerative medicine: are we there yet? *NPJ Regenerative Medicine* 2 (1):2.
- Bischof, M., and E. Del Giudice. 2013. Communication and the emergence of collective behavior in living organisms: a quantum approach. *Molecular Biology International* 2013.
- Capra, F., and P.L. Luisi. 2014. *The systems view of life: A unifying vision*. Cambridge: Cambridge University Press.
- Carlson, B.M. 2007. *Principles of Regenerative Biology*: Elsevier Science.
- Hode, L., and J. Tunér. 2014. *Laser Phototherapy. Clinical practice and scientific background*: Prima books AB.
- Kartelishev, A.V., A.G. Rumantsev, A.R. Evstigneev, A.V. Geinits, and S.V. Usov, eds. 2012. *Laser therapy and prophylaxis*. Moscow: Practical medicine.
- Konchugova, T.V., I.P. Bobrovnikskiy, E.M. Orekhova, and G.A. Puzyreva. 2014. The prospects for the development of regenerative physical therapy. *Problems of Balneology, Physiotherapy, and Exercise Therapy* 91 (5):42-49.
- Kurzanov, A.N., N.V. Zabolotskih, and D.V. Kovalev. 2016. *Functional reserves of organism*. Moscow: Izdatelskiy dom Akademii Estestovznaniy.
- McCance, K.L., and S.E. Huether. 2014. *Pathophysiology: The Biologic Basis for Disease in Adults and Children*. 7 ed: Elsevier Health Sciences.
- Scholes, G.D., G.R. Fleming, L.X. Chen, A. Aspuru-Guzik, A. Buchleitner, et al. 2017. Using coherence to enhance function in chemical and biophysical systems. *Nature* 543:647.
- Seppet, E., M. Gruno, A. Peetsalu, Z. Gizatullina, H.P. Nguyen, et al. 2009. "Mitochondria and energetic depression in cell pathophysiology." *International Journal of Molecular Sciences* 10 (5):2252-303.
- Surazakov, A., A. Klassen, and O. Gizinger. 2020. The bioenergetics of COVID-19 immunopathology and the therapeutic potential of biophysical radiances. *Journal of Photochemistry and Photobiology B: Biology*:112083.
- Vos, T., S. S. Lim, C. Abbafati, K. M. Abbas, M. Abbasi, et al. 2020. Global burden of 369 diseases and injuries in 204 countries and territories, 1990-2019: a systematic analysis for the Global Burden of Disease Study 2019. *The Lancet* 396 (10258):1204-1222.

# Soul-X: The Experience Center for Mind-Body Harmony

Abhay Wadhwa<sup>1,\*</sup>

<sup>1</sup> Founder - Soul Studio LLC; contact@soulstudio.world

\* Corresponding author: contact@soulstudio.world

## Abstract

With so many distractions and unrelenting work, we often forget who we are. This paper will provide insight into SOUL-X, an experience center dedicated to improving public health. It provides an experience that allows users to transcend the ordinary and realize the interconnectedness with the oneness of life. SOUL-X is an immersive light, color and sound installation which provides a sensory experience, that de-stresses and realigns the body, mind, and soul. It is a collaboration of artistry, healing wisdom, science, and universal health, and well-being to create a unique first-time experience.

**Keywords:** *Immersive light color & sound installation, Healing space, Sensory experience, Mind-body harmony, Urban sanctuary.*

## INTRODUCTION

Most of the urban working population live under immense stress, mainly because of the competitive work environment, Posttraumatic Stress Disorder (PTSD), depression, and various types of stresses including peer stress, bullying-related stress, race-related stress, sexual violence-related stress, domestic violence-related stress, uprooting related stress. People often fail to take out time to relax and rejuvenate, as a result, they suffer from multiple lifestyle diseases which may further lead to various physiological and psychological issues including problems related to metabolic activity and anxiety.

The Soul-X provides an illuminative space beyond the chaos, distractions, and obstacles of the world where one loses focus of who they are and, therefore, lives marginalized lives that deny our true potential. Since the mind, body, and soul are connected, so one must use a similarly holistic approach to integrate them to become a stronger, wiser version of themselves. In the Soul-X environment, a user is invited to free a closed mind, let go of stagnated emotions, create a new personal narrative, and destress the body. It does this by communicating through light baths, electronic visuals, healing sound frequencies, and color therapy.

## PHILOSOPHY & INSPIRATIONS BEHIND THE METHOD

The Soul-X is designed to transcend the physical and mental realms—to provide meaning, engagement, and transformation for the individual soul. Ease of assembly is also afforded by designing compatible parts, such as interchangeable structural columns, which have consistent measurements.

There are nine healing themes available, they are: you are the miracle, you are balanced, you are vibrant, you are loved, you are peaceful, you are prosperous, you are powerful, you are valuable and you are connected. All of them have their respective inventions which act as a healing tool for achieving the required needs. The theme of the Soul-X is 'you are the miracle'. With the help of nine sequential steps, Soul-X can optimize the outcomes, they are: revive the memory, recognize the problem, purify- insert equilibrium, energize the engines, reset your horizons, realign your navigation, reorient your responses, grounding- make it solid, protect your present and future. The Soul-X consists of nine core elements, they are Chromatherapy (via Super Wavelength of Light), Lateral Color Therapy, Elements from Nature, Healing Frequencies, Storytelling through Projection, Chakra Balancing, Sacred Geometry & Mandalas, Alternating Binaural Sound and the Sounds of

Planets, Chants, & Gongs. The installation intends to awaken and nourish each person's soul through the use of visuals, sound, and light. In this installation visual has a major part, which is divided into eight subparts and all are interrelated. A symbolic representation is presented through a seed's life from going back in the past to it come back in the present, and the intermediate parts are also illustrated by its journey.

## COMPONENTS

Soul-X consists of five components, they are Dome, Multimedia Projection, Light Shower Pods, Horizon Hammocks, Central Pillar.

- Dome

The dome consists of 2 parts—the exterior geodesic dome and the interior projection dome. The dome concept was chosen because it represents the constantly expanding and infinite cosmos, as there are no edges and boundaries.

- Multimedia projection (color and sound)

Artistic and dynamic forms of multimedia are projected from the central pillar on the interior projection dome, similar to a planetarium theatre. A featured film is projected in this installation, it utilizes a full-color spectrum with the benefits of the chakra system. A 360° mirror covering the central pillar act as the projection screen, the film presents a story about a seed discovering its soul.

- Light shower pods

Around the perimeter of the Soul-X structure, reside a total of 6, equidistant columns of light. From a bird's-eye view, the circular column tops form the circles or vertices of "sacred geometry," symbols based on ancient wisdom. Based on chromotherapy methodologies, the pods use light and color to activate and affect a person's mental, physical, and/or spiritual health.

- Horizon hammocks

The horizontal surfaces that project outwards around the base of the central pillar are "horizon hammocks." The horizon hammocks glow with relevant chakra colors, similar to colors of twilight and sunset along the horizon. Lights provide color therapy and are integrated along the edges of each hammock.

- Central pillar

The central pillar is located in the middle of the installation; it represents the joining and unification of elements. Starting from the base of the central pillar, it bridges a physical connection with users through the attached hammocks, which are distributed around the mirrored surface of the central pillar. Lined with healing lights of color, the pillar provides a spatial relationship to the Soul-X, with the hammocks representing the horizon. The custom-designed central pillar provides the 360° visual projections on the Soul-X walls. The pillar features a cylindrical mirror with light emanating from the top. Using a modularly designed exhibit allows the easy expansion of the Soul-X experience based on application, environmental needs, and the number of people. The modular design allows for ease of

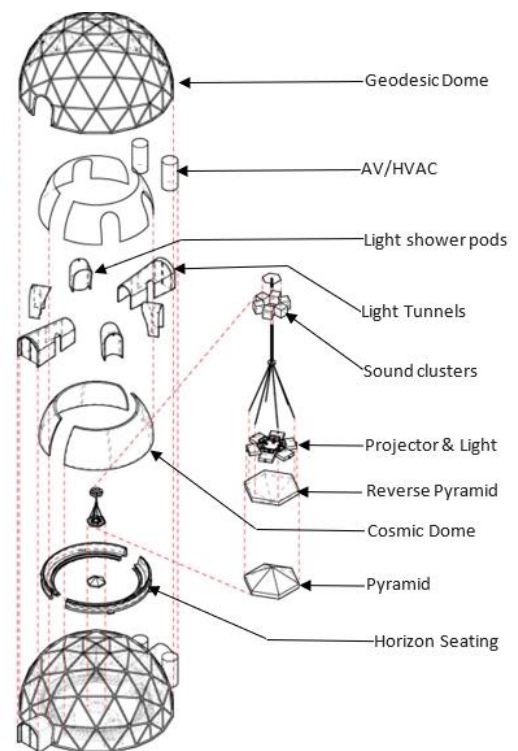

Fig. 1.1

assembly and disassembly, transportation, and portability. Fig 1.1 depicts the exploded axonometric view of Soul-X.

### **WORKING PRINCIPLE**

In this method, the modular enclosure is constructed utilizing sacred geometry, provided with benefits of light and color, and audio therapy with visual effects. The exterior geodesic dome establishes the shape of the ceiling and the interior projection dome functions as an expandable projection screen. Each of the light sources is capable of emitting multiple beams of color at the required wavelength and frequency in a specified pattern for a predetermined time. Frequencies of each of the sound sources vary from 6.05 Hz to 963 Hz, and higher frequencies are also used in some cases, and wavelengths of each of the light sources vary from 320-760nm. In this process, the produced light and color are configured to laterally penetrate the eyes of one or more individuals with complementary wavelengths. The wavelength range is predetermined and set in a narrow range for enhancing the required effect. With the help of two pyramidal reflectors, positioned to face each other, where, one centrally hanging from the ceiling of the enclosure and the other is centrally based on the floor developed a system for reflecting the light and sound at a required wavelength and frequency in the required direction for eliciting a desirable response within one's mind and body, inducing a sense of olfaction, gustation, and tactile perception.

In this installation, sound clusters produce sounds and vibrations. The interior dome projection screen is picturized in coordination with the output produced from sound clusters. The combination of sounds, vibrations, images, and video visuals in a specified pattern act as a stimulant that exerts its effect on the users sitting inside the dome for a definite period. The light emitted from the light showers after getting reflected or deflected from the light reflector at a predetermined wavelength followed by projecting on the interior geodesic dome, wherein the light coming off the interior projecting screen of a specific wavelength enters into the eyes of humans sitting inside the system and further exhibits Simultaneous Adjacent Chroma Stimulus (SACS) to influence the balance of human's brain hemisphere by penetrating wavelengths of complementary colors into each half of the human's visual field to re-balance the autonomous nervous system. While exhibiting the super chroma, the light coming off the interior projecting screen entering into the eyes of humans sitting inside the system comprises of a narrow band of wavelengths of at least 10 nm (single color), without any interference with other colors to influence the balance of human's brain hemisphere by penetrating the narrow band of wavelengths of complementary colors into each half of the human's visual field to re-balance the autonomous nervous system.

Equipment is interchangeably placed depending on the kind of healing to be carried for one or more users. The multipurpose integrated apparatus for producing and projecting lights, colors, and sounds comprises a frame supported by a shaft from the top and housed with a multiple light projecting system at its periphery and also in the center. The multiple sound-producing systems are situated above the frame and around the shaft. The exterior framework is provided with required heating, ventilation, and air-conditioning by placing HVAC (Heating, Ventilation, and Air-Conditioning) equipment on the outer periphery of the exterior framework, but this physical structure including HVAC equipment is configured to be transposable, interchangeable, and portable.

### **INSTALLATION SETUP**

Referring to Figure 2.1, a full cross-sectional latitudinal view of the system for improving the holistic health of humans is shown, where,

- The system is denoted by (1)
- The sound producer is denoted by (2)
- The alternating binaural sound system is denoted by (2a)
- The light projector is denoted by (3)
- Light producer /light source is denoted by (4)
- Two reflectors are denoted by (5)
- The upper reflector is denoted by (5a)
- The lower reflector is denoted by (5b)
- A vortex of reflection is denoted by (5c)
- Interior wall is denoted by (8)
- Seating surfaces are denoted by (8a)
- A projecting screen is denoted by (8b)
- Light source fitted behind the seating surfaces (8c)
- Light-producing system(8d)
- An enclosure is denoted by (9)
- Exterior frameworks/ the ceiling of the dome is denoted by (10)
- A multipurpose integrated apparatus is denoted by (11)
- A pair of the door is denoted by (13)
- A spatial-visual resonance is denoted by (v)
- The user is denoted by (p)

Referring to figure 2.2, a full cross-sectional longitudinal view of the system for improving the holistic health of humans is shown, where, spatial-visual and aural resonance is denoted by (V and A).

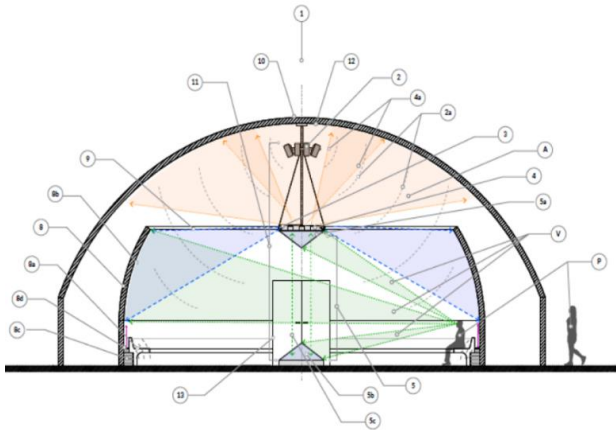

Fig. 2.1

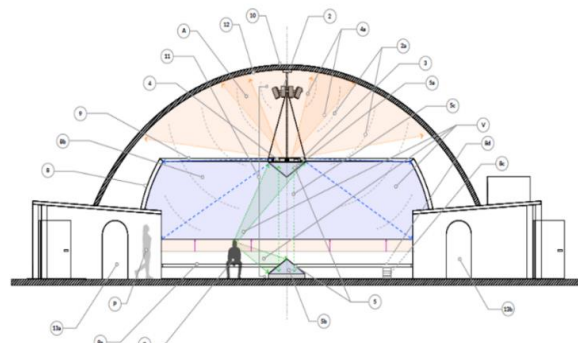

Fig. 2.2

Referring to figure 2.3, the front view of the upper portion below the sound system of the multipurpose integrated apparatus (11) of the system for improving the holistic health of humans is shown.

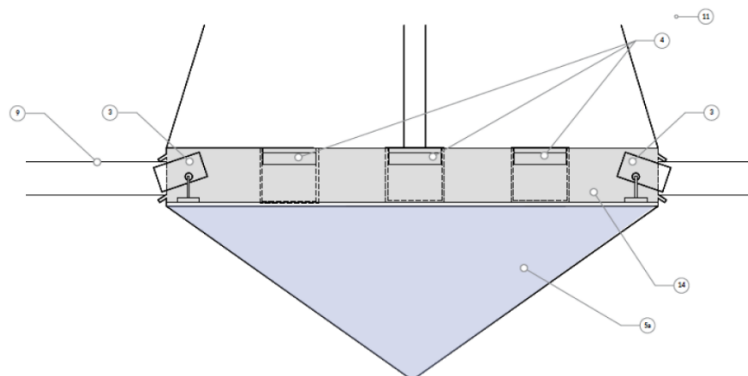

Fig. 2.3

Referring to Figure 2.4, a full cross-sectional top view of the system is shown, the system comprises an exterior framework forming the outer boundary of the system. The interior enclosure (9) is having walls provided with seating surfaces to accommodate users. There are openings (13d) being provided at the ends of the walls for providing passages (13c) via entry (13a) and exit door (13b), and HVAC unit (15) are placed on the outer part of the exterior framework at the doors (13). The integrated multipurpose apparatus is centrally located, hanging from the top and having a frame (14) that consists of the light projectors and the sound system. The sound system produces ABS (2a) downwardly towards the users sitting on the surfaces (8a). The Spatial Visual Resonance (V) is created in the sight of view of the users by reflecting lights from the ceiling (12) of the exterior framework and the reflectors. Also, the spatial aural resonance (A) is created by synergizing sounds produced from the sound system.

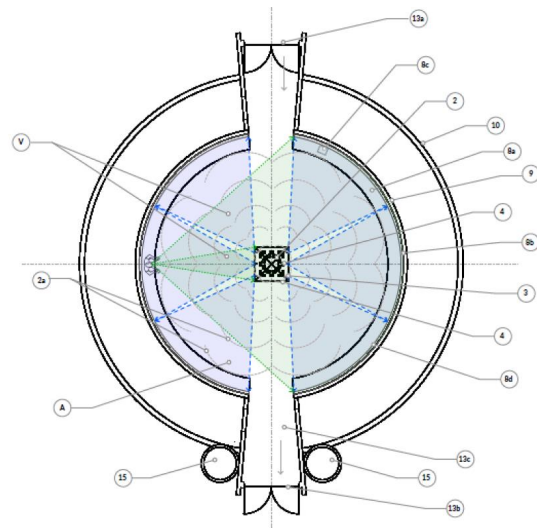

Fig. 2.4

## CONCLUSION

A collaboration of artistry, healing wisdom, science, and universal health, and well-being are brought together by the Soul-X. It is a therapeutic installation, an attempt at presenting the complexities of fusion between the arts and emotional, energetic, physical, mental, and soul health. In this modularly designed installation, which is sacredly and geometrically designed, where sequential visual sights in combination with geometric patterns developed with the sound frequencies corresponding to planets, gongs, chants, and healing frequencies to stimulate harmonizing and equilibrating the mind and body organs by synergizing the sound frequencies, light, and spectral wavelengths. The healing frequencies and wavelengths are used for showering upon one or more individuals to bring healing effects in their health, mainly: reviving the memory, recognizing the health-related problem, bringing the user's mental and physical state into a required healing mode for healing the particular recognized health-related problem and activating the body organs by vibrating the vital points of the user's body at vibratory healing frequency. In a nutshell, this therapy re-orienting the subsequent elicited response for self-actualizing the healing of the holistic health of the user. This installation can provide its users with a sacred experience with meaningful soul dialogue which can nourish and inspire them to live their fullest potential.

## ACKNOWLEDGEMENTS

Conceptualization and Direction: Abhay M Wadhwa.  
Team SS & LLC.

## REFERENCES

- Berry, T. "Reinventing the Human." The Great Work, Broadway Books, 2000.  
Berry, T. "The Spirituality of the Earth." The Sacred Universe, Columbia University Press, 2001.



- Blavatsky, H. P. 1889. *The Key to Theosophy*. Pasadena, Theosophical University Press, 1946.
- "A Practical Guide to Awakening and Expanding your Consciousness." YouTube, uploaded by Aaron Doughty, 18 Feb. 2017, [www.youtube.com/watch?v=Cm1H8q31zmk](http://www.youtube.com/watch?v=Cm1H8q31zmk). Accessed 28 June 2019.
- Shanmugav, S., et al. "How to Clear Your Karmic Debt and Set Your Soul Free." Ekatvam Blog, Ekatvam, 2018, [ekatvam.org/clear-karmic-debt/](http://ekatvam.org/clear-karmic-debt/). Accessed 20 July 2019.
- Stuckey, H. L., and J. Nobel. "The connection between art, healing, and public health: a review of current literature." *American journal of public health* vol. 100,2 (2010): 254-63. doi:10.2105/AJPH.2008.156497 World Health Organization, Director-General. *Traditional Medicine: Proposed Programme Budget for the Financial Period 1980-1981: Programme Review: Traditional Medicine*. Report no. EB63/ WP/2, Geneva, Switzerland, 1978 EB63.
- Zindel, P.. *The Effect of Gamma Rays on Man-in-the-Moon Marigolds*. 1971. Livingston Public Schools, [www.livingston.org/cms/lib9/NJ01000562/Centricity/Domain/762/male%20monologues%20including%20charlie%20brown%20and%20GEMINI.pdf](http://www.livingston.org/cms/lib9/NJ01000562/Centricity/Domain/762/male%20monologues%20including%20charlie%20brown%20and%20GEMINI.pdf). Accessed 23 July 2019
- The Health Benefits of Human-Centric Lighting Using LEDs. Yoelit H. Hiebert.
- Emerging Nature-Based Parameters for Health and Well-Being in the Built Environment. Catherine O. Ryan. 2014.
- Biophilia: Does Visual Contact with Nature Impact on Health and Well-Being? Bjørn Grinde and Grete Grindal Patil. 2009.
- How Do I Eliminate Stress with Color? Dr. Edward Group DC. 2015.
- The Power of Color in the Healthcare Environment. Laura Guido-Clark Design, LLC.
- Impact of Light on Outcomes in Healthcare Settings. Anjali Joseph. 2006.
- Red Light Therapy Benefits, Research & Mechanism of Action. Dr. Josh Axe.
- Electromagnetic Fields and Public Health: Intermediate Frequencies (IF). World Health Organization. 2005. *A New Approach to Understanding the Impact of Circadian Disruption on Human Health*. Mark S Rea, Mariana G. Figueiro. 2008.
- Research Recap. Mariana Figueiro. February 2003.

# Treating chronic pain and depression with color and sound: recent studies using the Sensora system

Anadi Martel <sup>1,2</sup> and Christophe Desteuque <sup>3</sup>

<sup>1</sup> International Light Association; anadi.martel@ilacolor.org

<sup>2</sup> Sensortech Inc (Canada); info@sensora.com

<sup>3</sup> Centre E-de (France); desteuquechristophe@gmail.com

\* Corresponding author: anadi.martel@ilacolor.org

## Abstract

We present the results of two recent studies performed in France using the Sensora, a multisensorial stimulation system generating an integrative, immersive therapeutic experience. The Sensora is representative of the novel therapeutic modalities brought about by modern light, color and sound technological innovations. The objective of the first study was to demonstrate the effectiveness of the Sensora system for 10 patients with a diagnosis of chronic pain. The second study examined the impact of the Sensora on 9 patients suffering from anxiety and/or depressive symptoms. Both studies led to the conclusion that the Sensora can be considered as an effective system in its capacity as a supplementary therapeutic modality for the treatment of patients presenting with chronic pain as well as depressive or anxiety symptoms.

**Keywords:** color therapy, light medicine, chronic pain, depression, Sensora

## INTRODUCTION

Colors were used for healing purposes by most ancient cultures (Hamblin and Huang 2013: 3-10). These traditional methods have been superseded by modern allopathic medicine, and during the 20<sup>th</sup> century colors have been mostly considered to only have relative psychological influence. This state of affairs has significantly changed since the 2000s, following important scientific discoveries about the effects of light on human biology, notably those of *photobiomodulation* and of the *non-visual optic pathway* (Martel 2018: 80-111). It has since become clear that light (and by extension colors) can have profound effects on both the body and mind, and therefore on health. The field of light medicine is now in significant expansion, involving thousands of scientific researchers around the world.

A number of novel therapeutic modalities based on various properties of light and colors are now appearing. In this presentation we examine the effects of one of these, the Sensora system.

## THE SENSORA SYSTEM

The first versions of this system were released in the 1990s and it has continued evolving since then. The Sensora simultaneously presents three types of sensory stimulation: visual, audio and kinesthetic. It features an advanced light projection system capable of generating complex color patterns. Its active principle is based on a new technique of light control called Light Modulation which generates light pulsations capable of interacting with diverse biorhythms such as brain waves, breath, or heart beats (Martel 2007). Color patterns are composed of five overlapping zones distributed horizontally along the projection screen, each zone having independent color and modulation properties. Different light patterns on the left and right halves of the visual field can thus differentially influence the two brain hemispheres, due to the crossing of the optic nerve in the optic chiasm.

Light is absorbed by the person's body thanks to the relaxed state induced by the reclining chair equipped with an array of special sound transducers (Figures 1 and 2). The Sensora is capable of

bringing a patient to a state of deep relaxation within a short span of time and complete sessions typically last 20 to 40 minutes (Ross et al. 2013).



Figure 1: The Sensora multi-sensorial therapeutic environment.

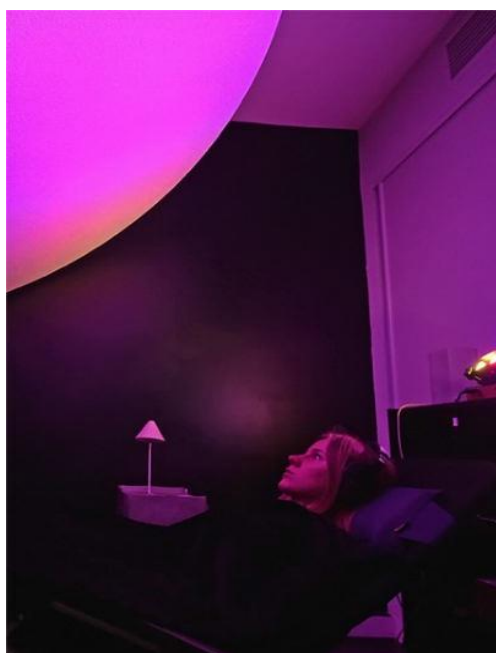

Figure 2: The Sensora room during a treatment session.

### ***STUDY #1: CHRONIC PAIN***

The objective of the first study was to demonstrate the effectiveness of the Sensora system for patients with a diagnosis of chronic pain, and thus to establish if there is an improvement after up to 11 treatment sessions with regard to mood, the level of energy and a reduction in problems related to sleep disruption, stress and anxiety (Desteuque et al. 2020). The study was directed by Dr. Philippe Diaz, chief of the Avignon Hospital's unit devoted to pain, in collaboration with Christophe Desteuque,

certified nurse specialist in Applied Neurosciences and assistant Director of E-de. It took place weekly from June 4 to November 15, 2019 in two different locations: Centre Hospitalier d'Avignon - Pain Unit (6 patients studied) and Centre E-de – Marseille (4 patients studied).

### **EVALUATION METHODS**

Four dimensions were evaluated:

- 1) **EVALUATION OF THE LEVEL OF ANXIETY AND DEPRESSION:** HAD standardized test (Hospital Anxiety Depression Scale, Zigmond 1983) which provides a score over 42 points.
- 2) **EVALUATION OF THE PAIN LEVEL:** numerical scale of self-evaluation by the patient on a scale of 0 (no pain) to 10 (intense pain) according to what he/she experiences.
- 3) **EVALUATION OF THE PATIENT'S GENERAL WELL-BEING:** numerical scale of self-evaluation on a scale of 0 (sad) to 10 (joyful) with regard to his/her current subjective state.
- 4) **EVALUATION OF THE RELAXATION LEVEL:** numerical scale of self-evaluation on a scale from 0 (tense) to 10 (very relaxed) denoting the degree of relaxation that was being experienced.

### **GENERAL RESULTS OF THE STUDY**

**Decrease in pain** felt by the patients at the end of the sessions was on average 68.5%. Session results obtained were very consistent: 9 patients out of 10 felt an average reduction of 75% of their pain. All patients stated having created a distance with regard to their painful sensations as well as a greater capacity to manage the pain on a daily basis. The evaluation of the **emotional state** of the patients at the end of the sessions showed on average an improvement of 52.4%. An improvement in reaching stable levels was noted, between 8 and 10 (on a scale of 10) at the end of the session. This was the case for 8 out of 10 patients, regardless of their emotional state before the beginning of the session. This enables establishment of the stabilizing effect of the Sensora sessions on the emotional state of the patients. The improvement in the **state of relaxation** was significant with average improvement of 65.6% at the end of the sessions. The decrease in the **level of anxiety and depression (HAD test)** was on average 39.8%. This result is to be correlated with the decrease in pain and the improvement in the emotional state and state of relaxation of the patient.

### ***STUDY #2: ANXIETY AND DEPRESSION***

The second study examined the impact of the Sensora on 9 patients suffering from anxiety and/or depressive symptoms (Desteuque and Altche 2021). It was directed by Christophe Desteuque and six specialists from the Hôpital de Jour Le Prélude (Aubagne, France) comprising two psychiatrists, two psychologists and two nurses. 90 color and sound sessions in total were administered over 12 weeks (November 2020 to February 2021).

### **EVALUATION METHODS**

Four dimensions were evaluated:

- 1) **SPIELBERGER STATE-TRAIT ANXIETY INVENTORY:** this questionnaire (Spielberger et al. 1983) is an indicator of the transitory modifications of anxiety provoked by different (therapeutic) situations. It provides scales for the sensations of apprehension, tension, nervousness and disquiet that the subject feels at the moment of filling out the questionnaire.
- 2) **PHYSIOLOGICAL MONITORING:** this was performed using the Physioner™, an ECG (electrocardiogram) feedback instrument allowing real time evaluation of the precise nature of the physiological imbalances produced by negative chronic stress and by uneasiness. The Physioner

provides three physiological markers: *Disequilibrium of the Autonomic Nervous system (ANS)* represents the imbalance between the two branches of the ANS (sympathetic and parasympathetic); *Heart Rate Variability Amplitude (HRV)* constitutes an indicator of vagal tone; *Cardio-respiratory alignment (CRA)* measures the delay between breath and cardiac response, and is related to the level of anxiety.

3) **SENSORA RECORD SHEET**: this tracking record is filled in by the carer, with questions about positive thoughts, perceived energy level, sleep quality and general state evaluated on scores of 0 to 10.

4) **THREE VERBAL SCALES**: three self-evaluation verbal scales were used, focussing on pain, emotional state and relaxation state, each rated on a score of 0 to 10.

### **GENERAL RESULTS OF THE STUDY**

The scores obtained from the **Spielberger questionnaire** showed a lessening in stress states for 100% of the patients, with a significant average drop of 29.3%. 8 of the 9 patients were thus able to bring down their stress level below the median for their category (41 for women and 37 for men).

The **ANS, HRV and CRA results**, thanks to the Physioner device, allowed light to be shone on the physiological state of the patients, which as we were able to observe, was on occasion at odds with how they felt their state to be. 50% of patients (4 of 8) saw their level of stress perceptively go down thus improving balance in their ANS. According to HRV, 75% of patients (6 of 8) saw their level of fatigue increase, this being allied to the process of becoming self-aware which took place at the start of the protocol and which allowed the patients to achieve a letting go. According to CRV, 75% of patients (6 of 8) saw their anxious state lessen significantly by the end of the protocol.

The results from the **Sensora record sheets** showed an impact predominantly on the level of fatigue and on the level of energy felt, thus on the general state of the patients. 78% of the patients (7 out of 9) saw an improvement in their capacity to have positive thoughts, with an average improvement of 72,4% and of more than 100% for 3 patients. 100% of the patients saw a lowering of the level of fatigue felt, with a very high average drop of -265%. Sleep quality improved for 78% of the patients (7 of 9), on average by 82.8%. 78% of the patients (7 of 9) felt improvement in their general state, on average by +94.1%. The results coming from the analysis of the **three verbal evaluation scales** show an impact predominantly on the level of pain, when it was present. 78% of the patients (7 of 9) saw an impressive lowering of the pain felt, with a median diminution in the pain of 63.1%.

### **DISCUSSION**

While light medicine is uncovering many biochemical pathways for the action of light on the body, the therapeutic action of colors (also known as chromotherapy) is less well understood and relatively few studies are available in this field. Part of the difficulty may lie in the fact that the perception of colors through vision is predominantly a cognitive phenomenon, rather than a biochemical one, and as such is less amenable to objective scientific study. It would therefore be expected that color therapy would be especially effective in conditions involving mind-body interactions, such as, for example, depression, fibromyalgia, insomnia or post traumatic stress syndrome (PTSD).

This is borne out by the results of the two studies presented here. How can these results, which in some instances compare favorably with those of standard medication-based treatments, be understood? While explaining the therapeutic action principles of colors is beyond the scope of this report, some indications can be proposed. Color information entering the eyes propagates through cortical areas of the brain via multiple pathways within the optic nerve:

- The **visual pathway** linking the retina to the visual cortex is naturally the best known; but beyond this the neuronal signals initiated by color are transmitted to a multitude of brain areas involved in cognition that are in the cortex, as well as in the regulation of emotions in the midbrain. Color information from the visual pathway is thus brought all the way to the limbic system, where the amygdala controls the most instinctive emotional reactions.
- The **non-visual optic pathway** links the retina to the hypothalamus and exerts a profound influence on our hormonal balance.
- The **retinotectal pathway** connects the retina directly with the superior colliculus (SC), the small midbrain structures involved in unconsciously perceived emotional stimuli also linked to other structures of the brain implicated in this function, such as the pulvinar and the amygdala (Tamietto and de Gelder 2010).
- The **accessory optic tract** connects the retina directly with the brainstem. Light is thus involved in the multiple physiological functions of the brain stem, including regulation of the heart rate and breathing, and managing our level of alertness and the quality of sleep (Hill and Marg 1963).

These four optical pathways stimulated by color are far-reaching, influencing every level of the cerebral processes: physiological, emotional, and cognitive, both conscious and unconscious. Such a complex, multilayered influence explains why the effects of color cannot be reduced to simple mechanisms. Clear-cut one-to-one effects of colors on particular symptoms have generally not been found, and successful color therapy systems require a more sophisticated approach taking into account the subjective reactions of individuals to specific colors.

## **CONCLUSION**

Virtually all subjects from both studies experienced significant reductions in stress and symptoms. Those with pain symptoms saw on average a decrease of over two thirds in their severity immediately after their sessions. Both studies led to the conclusion that the Sensora can be considered as an effective system in its capacity as an adjunct therapy for the treatment of patients presenting with chronic pain as well as depression and anxiety symptoms. In a number of cases, it enabled the treating physician to reduce prescribed medication.

The non-invasive and drug-free nature of this type of color therapy, as well as its absence of detrimental side effects, warrant further research into such interventions so that they can be eventually be adopted in a wider context. The results presented here offer a welcome glimpse into a possible future where color and sound will be implemented to enhance health and well-being.

## **DISCLOSURE**

First author Anadi Martel is a developer of the Sensora system. Second author Christophe Desteuque is a principal at Centre E-de and trains health professionals in the use of the Sensora system.

## **REFERENCES**

- Desteuque C., P. Diaz, and D. Altche. 2020. Sensora clinical study with persons suffering from chronic pain. *Private communication* [www.sensora.com/uploads/8/7/5/4/87541352/sensora\\_-\\_chronic\\_pain\\_study\\_2020\\_\\_summary\\_.pdf](http://www.sensora.com/uploads/8/7/5/4/87541352/sensora_-_chronic_pain_study_2020__summary_.pdf)
- Desteuque C. and D. Altche. 2021. Observational Study - What is the contribution of Sensora in the management of day care patients presenting with anxiety or depression. *Private communication*

- [www.sensora.com/uploads/8/7/5/4/87541352/sensora\\_depression\\_study\\_-\\_e-de\\_groupe\\_ramsay\\_2021.pdf](http://www.sensora.com/uploads/8/7/5/4/87541352/sensora_depression_study_-_e-de_groupe_ramsay_2021.pdf)
- Hamblin, M., and Y.-Y. Huang. eds. 2013. *Handbook of Photomedicine*. Boca Raton, Fla.: CRC Press.
- Hill, R.M., and Marg E. 1963. Single-cell responses of the nucleus of the transpeduncular tract in rabbit to monochromatic light on the retina. *Journal of Neurophysiology* 26 (2): 249–57.
- Martel A. 2007. Light Modulation, a new way of looking at lighting. In: *Professional Lighting Design magazine*, No 57 (Sept/Oct 2007): 44-47. Gütersloh: VIA-Verlag. [www.sensora.com/uploads/8/7/5/4/87541352/light\\_modulation\\_a\\_new\\_way\\_of\\_looking\\_at\\_lighting.pdf](http://www.sensora.com/uploads/8/7/5/4/87541352/light_modulation_a_new_way_of_looking_at_lighting.pdf)
- Martel, A. 2018. *Light Therapies, a complete guide to the healing power of light*. Rochester: Healing Arts Press
- Ross, M.J., P. Guthrie, and J.C. Dumont. 2013. The impact of modulated color light on the autonomic nervous system. *Advances in Mind-Body Medicine* 27 (4): 7–16. [www.sensora.com/uploads/8/7/5/4/87541352/the\\_impact\\_of\\_modulated\\_colored\\_light\\_on\\_the\\_ans\\_-\\_adv\\_mind\\_body\\_med\\_2013.pdf](http://www.sensora.com/uploads/8/7/5/4/87541352/the_impact_of_modulated_colored_light_on_the_ans_-_adv_mind_body_med_2013.pdf)
- Spielberger, C. D., R.L. Gorsuch, R. Lushene, P.R. Vagg, and G.A. Jacobs. 1983. *Manual for the State-Trait Anxiety Inventory*. Palo Alto, CA: Consulting Psychologists Press.
- Tamietto, M., and B. de Gelder. 2010. Neural bases of the non-conscious perception of emotional signals. *Nature Reviews Neuroscience* 11 (10): 697–709.
- Zigmond, A.S., and R.P. Snaith. 1983. The hospital anxiety and depression scale. *Acta Psychiatrica Scandinavia* 1983 Jun;67(6):361-70.

# **CITATIONS**

## **CADE Award and Judd Award 2021**

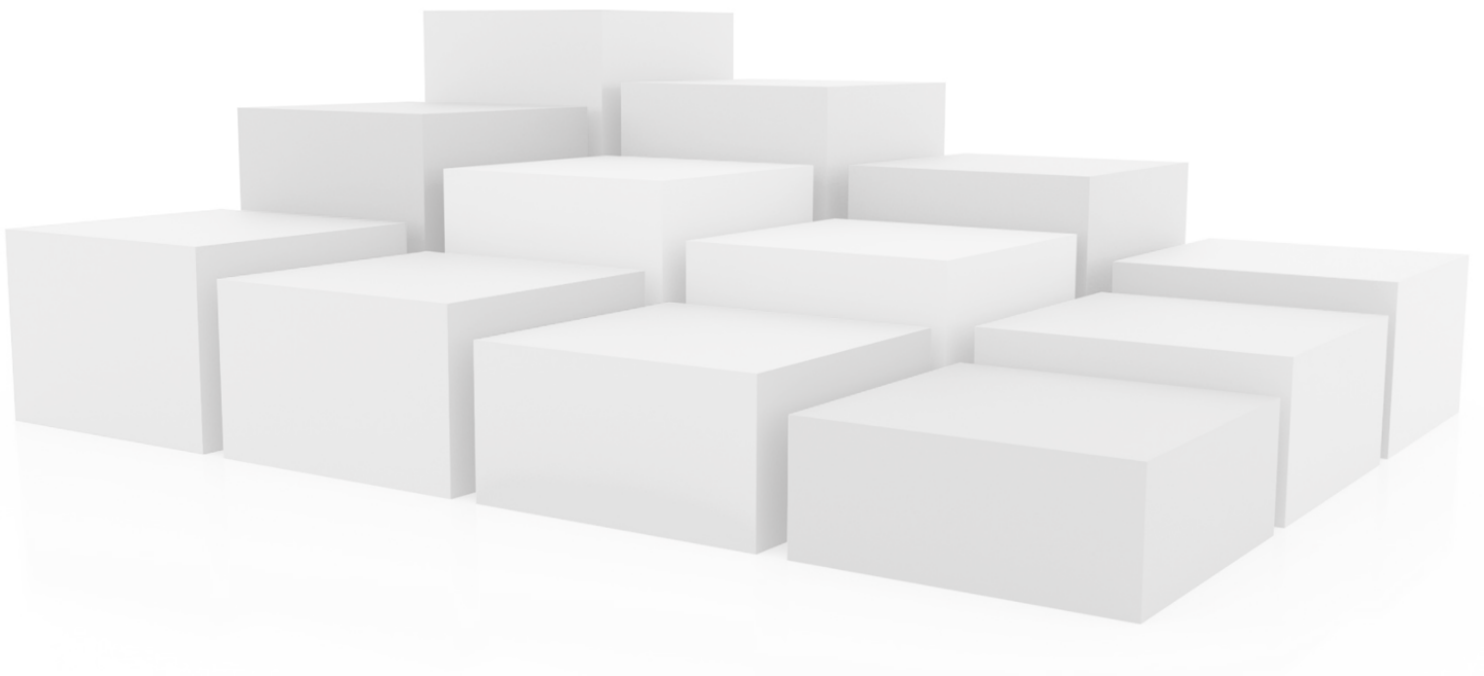

AIC 14<sup>th</sup> Congress Milano 2021 - August 30<sup>th</sup>– September 3<sup>rd</sup> 2021





# Jean-Philippe Lenclos: Recipient of the AIC Award for Colour in Art, Design and Environment (CADE)

Verena M. Schindler <sup>1,\*</sup>

<sup>1</sup> Art and Architectural Historian, Zollikon, Switzerland,  
Co-Chair, AIC Study Group on Environmental Colour Design ecd.studygroup@yahoo.com

\* Corresponding author: ecd.studygroup@yahoo.com

## Abstract

In 2021 Jean-Philippe Lenclos who is a colour designer, colour researcher, professor and visual artist has won the AIC Award for Colour in Art, Design and Environment (CADE). Established in 2015 the prize is to recognize those who excel in the areas of design, art, architecture and the humanities. The award is presented every two years at congresses of the International Colour Association (AIC). The selection is a rigorous procedure that includes nominations by AIC members and the analysis of the work of the nominees by a jury.

**Keywords:** Award for Colour in Art Design and Environment (CADE), International Colour Association (AIC), Colour, Excellence, Jean-Philippe Lenclos

## INTRODUCTION

This award is to honour the talent, vision, and commitment of the French colour designer, researcher, professor, and visual artist Jean-Philippe Lenclos whose work demonstrates an extraordinarily inventive and consistent contribution to the field of colour in urban planning and design, architecture, product design, textile design, art, research, and education (Figure 1).

With his intensity and passion, he has achieved excellence in the field, furthered the profession of colour designer with a new dimension, and influenced researchers, scholars, artists, and designers beyond France at an international level while serving as a leader and mentor.

Jean-Philippe Lenclos was awarded the Ordre des arts et lettres (Order of Arts and Letters) as a Chevalier (Knight) in 1981 by the French Minister of Culture Jack Lang for his significant contributions to the arts. His books have received four different prizes. Today 170 of his works are included in the Collection of the Musée National d'Art Moderne Centre Georges Pompidou in Paris.



Figure 1: Jean-Philippe Lenclos in 2018. Photo: Martin Lenclos.

## Colour Research: The Geography of Colour

What really sets Jean-Philippe Lenclos apart as a pioneer is his ground-breaking methodology of *The Geography of Colour*, which he developed and applied in analyzing and synthesizing colours of a country, town, or village. In 1965 as Artistic Director Jean-Philippe Lenclos joined the company Peintures Gauthier, which specializes in paint for buildings. He investigated colour collections of paints for architecture and conducted colour research with the aim of creating characteristic regional colour collections intended to identify the vernacular habitat colours in a rapidly developing urban landscape. Lenclos' research methodology is extraordinarily systematic and is based on a holistic approach of analysis-synthesis. His inventive and iconic representation of colours establishes palettes that are easily understandable and comparable.



Figure 2: Jean-Philippe Lenclos' early publications on his research findings of the vernacular habitat colours of twelve regions of France, a methodology he later called *The Geography of Colour*. Photo © Jean-Philippe Lenclos.

The findings of his research were first published in *La Maison de Marie Claire* (Hucliez 1969), in *L'Architecture d'aujourd'hui* (Lenclos 1972) and in the magazine *Maison Française* (Lenclos 1974) (Figure 2). Considering regional colours as belonging to the history, geography, and cultural identity of a place, the concept was extended beyond his native country to other European countries and other continents. In 1970–71 he successfully applied his methodology for the first time in practice while making the Color Plan for Tokyo. Nicknaming themselves as the three musketeers of colour, colour designer Lenclos, colour expert Tom Porter, and psychologist Byron Mikellides toured the United States together in 1976 presenting a series of lectures (Figure 3). A year later in 1977, the Centre Georges Pompidou in Paris organized a significant solo exhibition entitled *Géographie de la Couleur*.

These efforts resulted in a distinguished body of publications in collaboration with his wife Dominique Lenclos (1945–2012) including, e.g., *Colours of France*, 1982; *Colours of Europe*, 1995; *Colours of the World*, 1999; and *Colours of the Mediterranean Region*, 2016 (Figure 4, top row).

His work has been published in French, and also in English, Japanese, Korean, and Chinese (Figure 4, bottom row). His work has been widely published not only in books (see reference list below) but also in many prominent journals, magazines, and newspapers in several different languages. His research findings on *The Geography of Colour* have also been extensively exhibited in museums and galleries around the world.





Figure 3: Tom Porter, Jean-Philippe Lenclos, and Byron Mikellides (left to right) gave a series of lectures in the USA in 1976. To the right, a colour pencil drawing by Jean-Philippe Lenclos: Byron Mikellides, Tom Porter, and Jean-Philippe Lenclos (left to right). Photo © Jean-Philippe Lenclos.

Lenclos further applied his methodology to the fields of old city centres, new towns, architecture, industrial architecture, product design, textiles, and cosmetics.

Today his methodology has become so fundamental that it is applied by researchers, designers, architects and other professionals on an international level and taken as the starting point for further developments in the digital and technological era (Figure 5).

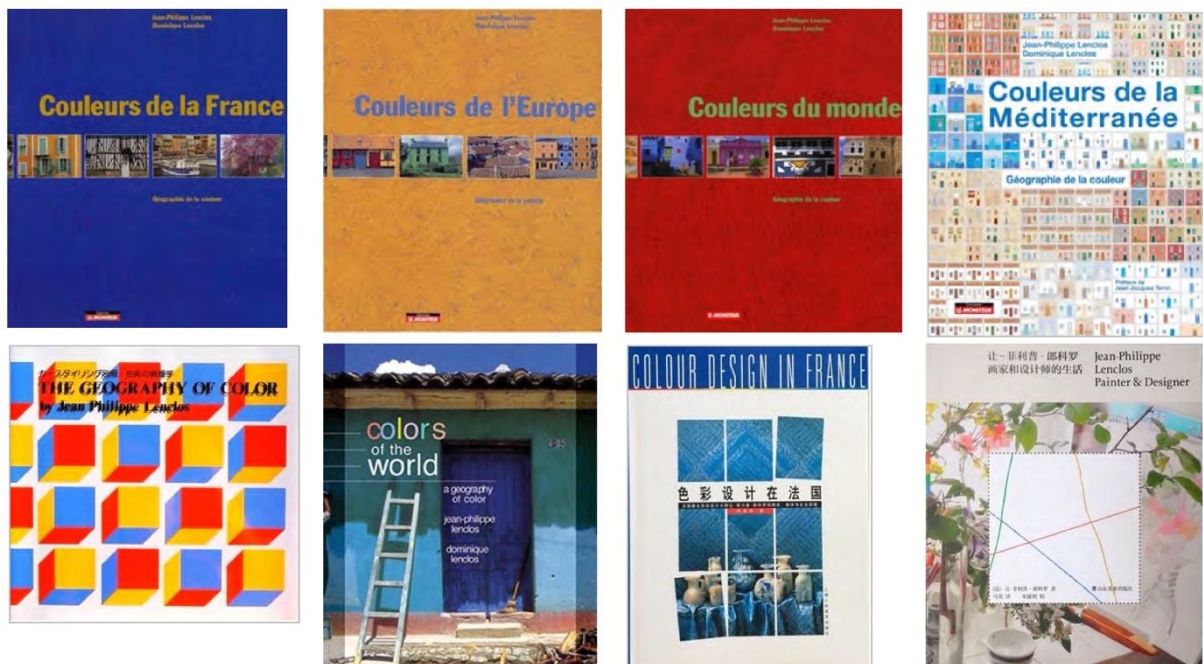

Figure 4: Top row: French Editions of *The Geography of Colour* (left to right): *Colours of France* (1982), *Colours of Europe* (1995), *Colours of the World* (1999), and *Colours of the Mediterranean Region* (2016). Paris: Éditions du Moniteur. Bottom row: *The Geography of Color* (1989, Japanese, English); *Colors of the World* (1999, English); *Colour Design in France* by Jianming Song (1999, Chinese); *Jean-Philippe Lenclos: Painter & Designer* (2017, Chinese, English).

## Design Studio

Born in Beuvry, France, in 1938, Jean-Philippe Lenclos founded his own firm the Atelier 3D Couleur in Paris in 1978, a design studio specializing in design and colour in urban planning, architecture and industrial products (Figure 6). With studies in cabinet-making at Ecole Boule and in fine arts in Lille, Paris and Kyoto, his talent combines rigorous thought with genuinely poetic qualities.



Figure 5: Le Morayshire, Scotland, elements of the analysis and synthesis: Narrative palettes (top, two left); General palettes of façade colours (right top, centre); Material samples of the façades, with corresponding colour swatches (central row); Material samples found on-site, with the colour range of the blues, and material samples of the surroundings, with corresponding colour swatches (bottom row). Photo © Jean-Philippe Lenclos.

He drew international attention with his captivating supergraphics design of an auditorium at the Salon des Artistes Décorateurs in Paris in 1967, which he further developed for building façades on a monumental scale. Over the thirty years of his leadership, the Atelier 3D Couleur met the clients' needs with imagination and state-of-the-art technology solutions. His work reflects a diversity of interests and accomplishments, with clients ranging from representatives from town administration bureaux, to transportation services, internationally renowned public and private companies, and industries. Among his clients were: Aérospatiale, Alcatel, Bridgestone Picnica René bicycles, Calor, China Starforest Plywood, DMC, Gitane, Hyundai, Hino Motors, Krups, L'Oréal, Marseille Metro, Mazda Motor Corporation, Michelin, Motobécane, Moulinex, Mira X Textiles AG, Nissan, Peintures Corona, Philips, RATP, Renault, Rowenta, Salomon, SEB Group, Shiseido, Siemens, Subaru, Tefal, Yamaha, Zolpan Peintures, and many more.





Figure 6: Jean-Philippe Lenclos in his design studio Atelier 3D Couleur. Photo © Jean-Philippe Lenclos.

### Teaching Colour

As a professor at the École Nationale Supérieure des Arts Décoratifs (ENSAD) in Paris from 1969 to 2003, Lenclos was greatly admired by his students. One of them is Professor Jianming Song at China Academy of Arts in Hangzhou, who since 1989 has extensively published Lenclos' work in China and published a beautiful monograph of his work in 2017. In 2006, Chloé Fontaine delivered a PhD thesis at the Sorbonne on Lenclos' work. He has served as visiting professor at Oxford, UK, and also at other universities in London, Teheran, and Martinique. He is a regular invited speaker at international conferences and institutions. In 1997, he delivered an exciting lecture at the AIC Congress in Kyoto and many AIC papers regularly refer to his work. Recently, he was a keynote speaker at the International Conference of the Color Society of Russia in 2020. He is an Honorary Member of the Portuguese Color Association (APCor), and the AIC Study Group on Environmental Colour Design (SG ECD).



Figure 7: Landscape painting. Private Collection. Photo © Jean-Philippe Lenclos.



### **Artistic Work**

Furthermore, as an artist he explores the properties of colour in his drawings, watercolours, and oil paintings. His unique artistic work, unknown to the general public, contains more than 3000 individual artworks. His artistic work creates vibrant optical patterns that capture light, rhythm, and movement with the intention “to make colours sing.”



Figure 8: Still Life with Mango, 2007. Watercolour, 29 cm x 42 cm. Private Collection. Photo © Jean-Philippe Lenclos.

For decades, he has produced watercolours dealing with the unpredictable and the fluid, the uncertain and the fragile, and the silent poetry of light falling on surfaces, objects, fruits, flowers and landscapes (Figures 7 and 8). Through their infallible chromatic transformation over time, the work of this artist reveals fascinating secrets of nature and his endless, inventive approach captures the breeze of his subjects.

### **CONCLUDING REMARKS**

Jean-Philippe Lenclos presently lives and works in Paris and believes that the link between nature, the built environment, and technology is colour because of its expressive power and its endless poetic dimensions. For his long-term commitment to a holistic and systematic understanding of colour that has inspired several generations through his example and seminal contribution to the world of colour in art, design, and the environment, Jean-Philippe Lenclos receives the AIC CADE Award 2021.

## **ACKNOWLEDGEMENTS**

Special thanks are due to Prof. Ulrich Bachmann and Ralf Studer, Co-Presidents of PRO COLORE Swiss Association for Colour, who unconditionally supported Jean-Philippe Lenclos' nomination as well as to Dr. Verónica Conte, President of APCor Portuguese Color Association, and AIC Individual Member Prof. Dr. Yulia A. Griber, President of Color Society of Russia, who enthusiastically endorsed this nomination. My fondest thanks go to Prof. Jean-Philippe Lenclos for his kind support and collaboration providing photographs and details about his curriculum vitae, and the many conversations we had about colour seen from multiple viewpoints. Recently, Jean-Philippe Lenclos opened his own website: <https://www.jeanphilippelenclos.com>

## **REFERENCES**

- Fontaine, C. 2006. *Jean-Philippe Lenclos designer-coloriste*. PhD Thesis Paris 1 Sorbonne, Paris.
- Jean-Philippe Lenclos: The Geography of Color*. 1989. Tokyo: Car Styling 71(1–2) Special Edition; San'ei Shobo Publishing Co. (Japanese, English).
- Jean-Philippe Lenclos: Couleurs du monde, Géographie de la couleur*. 2009. Translated by Seonghee Lee. Seoul: Mijinsa (Korean).
- Jean-Philippe Lenclos: Painter & Designer*. 2017. Text by Jean-Philippe Lenclos. Preface by Jianming Song. Introduction by Cloé Pitiot. Jinan: Shandong Fine Arts Publishing House (Chinese, English).
- Lenclos' Color Design*. 1991. Seoul: Kukje Publishing House (Korean).
- Lenclos, J.-P. 1972. Couleurs et paysages. In: *L'Architecture d'aujourd'hui* no. 164.
- . 1974. Les couleurs de la France. In: *Maison française* nos. 276–287.
- . 2021. Geografiya cveta [The Geography of Color]. In: *The International Scientific Conference of the Color Society of Russia: Selected Papers*. Y. A. Griber, V. M. Schindler, eds. Smolensk: Smolensk State University Press, 68–83 (Russian).
- Lenclos, J.-P. and D. Lenclos. 1982. *Les Couleurs de la France: Maisons et paysages*. Preface by Georges Henri Rivière. Paris: Éditions Le Moniteur.
- . 1995. *Les Couleurs de l'Europe: Géographie de la Couleur*. Preface by Michel Pastoureau and Tom Porter. Paris: Éditions Le Moniteur.
- . 1999a. *Couleurs du Monde: Géographie de la Couleur*. Preface by François Barré. Paris: Éditions Le Moniteur.
- . 1999b. *Colors of the World: The Geography of Color*. Preface by François Barré. Translated from the French by Gregory P. Bruhn. New York and London: W. W. Norton & Company.
- . 2001. *Portes du monde*. Paris: Éditions Le Moniteur.
- . 2001. *Fenêtres du monde*. Paris: Éditions Le Moniteur.
- . 2005. *Doors of the World*. New York, London: W.W. Norton.
- . 2005. *Windows of the World*. New York, London: W.W. Norton.
- . 2007. *Maisons du monde, couleurs et décors dans l'habitat traditionnel*. Paris: Éditions Le Moniteur.
- . 2016. *Couleurs de la Méditerranée: Géographie de la couleur*. Preface by Jean-Jacques Terrin. Antony: Éditions du Moniteur.
- Song, J. 1999. *Colour Design in France*. Shanghai: Shanghai People's Fine Arts Publishing House.

## **Further References (Selection)**

Baglioni, A., and G. Guarnerio. 1982. *La ristrutturazione edilizia*. Milano: Hoepli.



- Birren, F. 1982. *Light, Colour and Environment*. New York, NY: Van Nostrand Reinhold.
- Boulogne, D., and D. Durand. 1984. *Le livre du mur peint: art et technique*. Paris: Collection Architecture–Alternatives, Gallimard
- Brook, T., and A. Shaughnessy. 2010. *Supergraphics*. London: Unit Editions Düttmann, M., F. Schmuck and J. Uhl, eds., Farbe im Stadtbild. Berlin: Archibook.
- Éloge de la couleur. 2017. Catalogue. An exhibition on the occasion of the 40th anniversary of the Centre Pompidou. Roubaix: La Piscine – Musée d’art et d’industrie André Diligent.
- Griber, Y. A., V. M. Schindler, and M. Bouchier. 2019. *Francuzskij period istorii cvetovogo dizajna sredy v vospominanijah sovremennikov* [The French period in the history of environmental colour design]. *Social Transformations* 30: 48–52 (Russian).
- Hucliez, M. 1969. La maison à vos couleurs. In: *La Maison de Marie-Claire* no. 29.
- Hope, A., and M. Walch. 1989. *The color compendium*. New York, NY: Van Nostrand Reinhold.
- Krewinkel, H. W. 1985. Baugestaltung mit Farbe. Stuttgart: Deutsche Verlags-Anstalt.
- Lancaster, M. 1996. *Colorscape*. London: Academy Editions.
- L’expérience de la couleur. 2017. Paris: Lienart éditions; Sèvres: Cité de la céramique.
- Linton, H. 1985. *Color, Model, Environments*. New York, NY: Van Nostrand Reinhold.
- . 1994. *Color Forecasting*. New York, NY: Van Nostrand Reinhold.
- . 1999. *Color in Architecture: Design Methods for Buildings, Interiors and Urban Spaces*. New York, NY: McGraw Hill.
- Mikellides, B. 2018. Fifty Years of Colourful Reflections. In: *Proceedings of the International Colour Association (AIC) Conference 2018*. Newtown NSW: International Colour Association (AIC), 39–44.
- Porter, T. 1982. *Colour outside*. London: The Architectural Press.
- . *Color in architecture*. In: *Encyclopedia of architecture*. New York, NY: John Wiley & Sons.
- . 1993. *Companion to contemporary architectural thought*. Routledge Companion Encyclopedias. London: Routledge.
- Porter, T and B. Mikellides. 1976. *Colour for Architecture*. London: Studio Vista.
- . 2009. *Colour for Architecture Today*. London: Taylor & Francis.
- Quarante, D. 1984. *Éléments de design industriel*. Paris: Maloine.
- Sansot, P. 1985. *La France sensible*. Ceyzérieu: Champ Vallon.
- Schindler, V. M. 2019. Jean-Philippe Lenclos’ methodology of “The Geography of Colour”: back to the origins and its international impact. In: *Proceedings of the International Color Association (AIC) Conference 2019*. Newtown, José Luis Caivano, ed. NSW: AIC, 54–63
- Schindler V. M. and Y. A. Griber. 2021. The philosophy of colour in the French period of environmental colour design. In: *The International Scientific Conference of the Color Society of Russia: Selected Papers*. Yulia A. Griber, Verena M. Schindler, eds. Smolensk: Smolensk State University Press, 310–318.
- Schindler, V. M., Y. A. Griber, and M. Bouchier. 2019. The French period in the history of environmental colour design. In: *Proceedings of the International Color Association (AIC) Conference 2019*. José Luis Caivano, ed. Newtown, NSW: AIC, 544–549.
- Taverne, E. and C. Wagenaar, eds. 1992. *The Colour of the City*. Laren: V+K Publishing.

# Citation for John McCann: AIC Deane B. Judd Award 2021 recipient

Alessandro Rizzi <sup>1,\*</sup>

<sup>1</sup> Dept. Computer Science, Univ. Milano; alessandro.rizzi@unimi.it.com

\* Corresponding author: alessandro.rizzi@unimi.it.com

## Abstract

Color is the intersection of the physics of light, the psychophysics of appearance, and the art and technology of reproduction. John has a unique career; he is one of the few that deeply experimented in all these fields. This makes John one of the most influential persons in the field of color. These pages aim at summarizing his vast and fruitful work in which I had the honor and the opportunity to share a certain part. That made me a privileged observer. Many of the anecdotes reported come from direct experience, the others comes from a long series of personal communications with John.

**Keywords:** *Award for Colour in Art Design and Environment (CADE), International Colour Association (AIC), Colour, Excellence, Jean-Philippe Lenclo*

## JOHN'S INTEREST IN COLOR

John has always been interested in the science of color. At Lowell High School he did an unsupervised science fair project on chromatography. As a freshman at Harvard he participated in Eugene Rochow's Freshman Seminar. As an independent project, he synthesized by different reactions cis- and trans-isomers of cuprous chloride(CuCl<sub>2</sub>). The two compounds with the same chemical composition have different colors: pale blue, and pink. The idea of creating research projects for Freshmen at Harvard and MIT was sponsored by Edwin Land, the founder and chief of Polaroid. As a participant John learned of an opportunity for part-time work at Polaroid.

John's senior thesis in Biology, in John Dowling's laboratory, measured the pupil response to afterimages. He repeated Alpern and Campbell's experiments showing that the pupil response follows the state of retinal adaptation. The work was presented at the 4th Colloquium of the Pupil, Baltimore, 1964. John received a B.A. degree in Biology from Harvard College in 1964.

## RETINEX MODELS OF SPATIAL VISION

In the 1960's John assisted Edwin Land in his Mondrian experiments, and he made a major contribution to the Land and McCann (1971) computation model of Lightness. Land wrote:

"Our machine (computational model) should have a way of comparing areas that are distant from one another ... when we were contemplating an array of black, white, and grey papers and puzzling about the next step, John McCann invented ... a way of looking at the reflectance relationships between widely separated areas ... the product of the ratios across distant edges is the same as the ratio we would get if we placed the two remote areas next to each other. ... we can establish a series of sequential products which yields the relative reflectance of any area relative to the first area without knowing or involving the illumination." (Land, 1974: 36).

John began a career-long study of calculating Appearances using scenes with 20 by 24 pixels in a computer with hand-wound core memory in 1968. (McCann 2021:LM Retinex)

## ROD /LCONE COLOR

Also, in the 1960's John began his studies of rod and Lcone color in the production of color sensation. He integrated Edwin Land's Two Color photography with John Dowling's receptor dark-adaptation experiments. At Polaroid, John used dark-adaptation thresholds to study multicolor appearances with

fully dark-adapted eyes in very low-color-temperature illumination. John and Jeanne Benton used dark adaptation threshold to find absolute L-, M-, S-cone thresholds. Using radiances well below M- and S-cone absolute thresholds they observed multicolor scenes from rod and L-cone supra-threshold stimuli. (McCann 2021:rod-Lcone) At the AIC Interim Meeting Stockholm, McCann (2008) presented new appearance matches of rod /Lcone colors.

### **QUANTITATIVE COLOR CONSTANCY**

Traditionally, color constancy is a null experiment that considers two spots of light. In the 1970's John began to ask observers to match all areas in Color Mondrians. McCann, McKee and Taylor (1976) used 17 papers in 5 different illuminations. Observers matched all the papers in all the illuminants. The authors measured all the scene segments, using Paul Brown's 1964 spectral sensitivities of L-, M-, S-cones. Cone quanta catches of all segments were the input to John's spatial models. Observer matches measured ground truth for the model. The LM Retinex model calculated the appearances of all Mondrian areas to evaluate the entire scene in all illuminants. Illuminants cause subtle departures from perfect constancy that constancy models should predict.

The analysis of all his color constancy matching data showed little correlation between cone quanta catches and matching appearances. The calculation of Scaled Integrated Reflectance did correlate with observer matches. The analysis of all papers in all illumination showed very small departures from perfect color constancy (associated with the overlap of cone spectral sensitivities). LM Retinex model predicted observer matches. (McCann 2021:LandColorMondrian)

### **VISIBILITY OF GRADIENTS**

While Land's Color Mondrians showed near perfect Color Constancy, Land's Black and White Mondrians are a much greater challenge for computational models of vision. The multiplication of edges across the field of view approximates the appearances, but any calculation of appearance has to have a way of handling the radiance gradients between edges. Land and McCann (1971), in their LM Retinex Lightness Model used two operations that minimized the effects of gradients: threshold, and reset (normalization to local maxima). John studied the detection threshold of gradients. The results surprised him. He made a square photographic print with a luminance gradient between two parallel edges, on a uniform background. Observers had a 1 in 4 choice to identify the gradient's orientation (light to dark). Observers reported the orientation of a particular near-threshold gradient correctly 60% of the time. Repeating the same measurement with the observer twice as far away from the print doubled the rate of change of luminance on the retina. The surprise was that the observer reported the same 60% correct. Below the peak (3 cpd) of the contrast sensitivity curve, gradient detection threshold and contrast sensitivity of sine-wave gratings have abnormal responses. Below 3 cpd sine-wave detection threshold correlates with the number of cycles of sine wave, notspatial frequency. Low-spatial-frequency gradients respond to the spatial content of the rest of the scene. (McCann 2021:EdgesGradients)

### **DIGITAL IMAGE PROCESSING**

In 1975 John and Jon Frankle set up Polaroid's first digital imaging laboratory. It had a PDP computer with a large (for 1975) disc memory, and an I<sup>2</sup>S digital image storage with array processing hardware. Back then, digital memory chips were limited to 8k of storage, and were very expensive. The hardware used 768 of these 8k chips to store a single 512 X 512 by 24 bit image. Along with Karen Houston,

John used the system to study Color Constancy. With Jon Frankle, John developed, and patented efficient LM Retinex computation algorithms for HDR natural scenes.

The I<sup>2</sup>S digital images were displayed on a CRT monitor. John and Karen Houston calibrated the system, performed color constancy experiments on it, and presented the results at his first AIC meeting in 1980 (Harry Helson Memorial Symposium on Chromatic Adaptation, Williamsburg). Alan Robertson's (2007 Judd Medalist), Meeting Report said of McCann's talk: "An intriguing aspect of the work is the use of an advanced digital-image processor with a 512 X 512 pixel array. This apparatus permits the study of natural images viewed under different illuminants. The results can readily be analyzed in accordance with the Retinex processing model." (Robertson 1980) These experiments (McCann and Houston, 1983) were the first Natural Scene vision experiments, and maybe the first vision experiments performed on digital display devices.

Frankle and McCann (1983) developed a system that captured natural scenes, calculated appearances, and wrote the computed image on film. This system converted >1000:1 High Dynamic Range (HDR) scenes to the 30:1 range in prints. These Retinex models mimicked what a painter would do to reproduce a scene. John's work began with photography, progressed to papers in controlled illumination, to computational electronic imaging. He developed and patented efficient algorithms for making spatial comparisons among all pixels in an image. The essential component of its computational efficiency was the use of multi-resolution spatial comparisons. Using this 1975 digital hardware Frankle and McCann (1983) calculated apparent lightnesses of a 512x512 color separation in 53 seconds. This spatial process made the photograph "*John at Yosemite*" (Figure 8C in McCann's Judd Award paper). It was the first digital example that mimicked what painters do in creating renditions of HDR scenes. It captured the scene's >1000:1 range; digital transformed it using L-M Retinex, and rendered the appearance image on print film. (McCann and Rizzi 2012: 293-337)

### **CALCULATING THE ACTUAL LIGHT ON THE RETINA**

Stiehl, McCann and Savoy (1983) used Munsell's bisection procedure to make an HDR nine-step gray scale equal increment lightness target, using transparent filters on a 3,400nit lightbox. Stiehl calculated the retinal illuminances of the 9 equal lightness steps after intraocular scatter using the glare research of Vos (1991 Judd Medalist). Stiehl found a logarithmic relationship between retinal illuminance and the equal lightness steps. While CIE L\* lightness is the cube root of relative luminance from the scene, the receptor's logarithmic response to luminance is proportional to lightness. Their work highlights the importance of scatter-corrected retinal illuminance in any quantitative model of lightness, and in all evaluations of uniform color spaces.

### **COLOR CONSTANCY WITHOUT CHROMATIC ADAPTATION**

In Color Mondrians Land adjusted the illumination on a particular paper so that the light at the observer's eyes was identical to that of a different color paper in the Mondrian. Obviously, changing the uniform illumination changes the average L,M,S quanta catches (state of adaptation). The question is whether that change in adaptation state can affect the appearances of Mondrian areas viewed as an entire Natural Scene. Daw (1963) showed that afterimages, generated by light adaptation, are suppressed by scene edges that are different from the stabilized retinal afterimage. Nigel Daw formed a color afterimage. He then viewed the afterimage (maintaining the fixation point) on a black and white image of the same scene. The complementary color afterimage was clearly visible. He changed his fixation point, and the afterimage disappeared. The afterimage is suppressed when the edges in the real scene do not match the edges in the retinal afterimage. Daw then, moved his fixation

back to the original fixation point; the afterimage reappeared. Based on Daw's experiments, Land's Mondrians were made of irregular rectangles to suppress the chromatic adaptation of afterimages.

John's experiments added an additional step to cancel the changes in adaptation stimulus. He changed the Mondrian's reflectance patterns to change the Mondrian's adaptation state back to their original values. In short, Land changed illumination, that changed the scene's average L, M, S cone catches (state of adaptation); McCann changed Mondrian reflectances to cancel adaptation changes by restoring the original average L, M, S quanta catches. McCann's modified Mondrian's removed the chromatic adaptation component from the experiment. Observers made the same color matches with, or without, these changes in the state of chromatic adaptation. Despite many attempts to measure the effects of chromatic adaptation in complex and natural scenes, John never found substantial changes. John reported the first part of this long series of experiments in the AIC 1987, "Wyszecki-Stiles Memorial Symposium on Color Vision Models", Florence, Italy, and the second part at the AIC 1997, 8th Congress Kyoto, Japan. (McCann 2021:ConstancyWithoutAdaptation)

## **COLOR TECHNOLOGY**

In the 1980's, imaging revolution began with Akio Morita's introduction of Sony's Mavica prototype digital camera. All imaging companies began the process of converting from silver halide films to digital imaging. John's *Vision Research Laboratory* made and developed:

- With Jim Burkhardt and Jay Thornton, made a real-time 3-D LUT transformation hardware for MacDonald Detweiler digital color film recorders;
- Integrated color management in a digital driver-license system;
- Polaroid's 20x24, and Museum 40x80 inch film cameras;
- With Jay Thornton, used 3-D LUTs transform to make, color-corrected *Replicas* of Museum paintings. This calibrated process removed films' fixed nonlinear tone scale response.

## **POLAROID RESEARCH LABS TO MCCANN IMAGING**

In 1995 John retired from Polaroid as a Senior Laboratory Manager. He joined that lab first as a RandD lab tech, and had worked there for 35 years. During that period he was the administrator of Ansel Adams and John Sextant Consultants, Steve Benton's White Light Holography Lab, Bill Wray's Audio Research, Polaroid Replicas, Special Corporate Projects, and The Polaroid Research Machine Shop.

His wife Mary and John became McCann Imaging in 1994 consulting on Microscopy Imaging and Color Imaging. John consulted with Hewlett Packard. This work began in 1996, and it led HP's "Digital Flash" (alternatively called also "Adaptive lighting") cameras using L-M Retinex range compression in 2002. As well, his work at HP included studies of uniform color spaces, and 3-D LUT's to convert  $L^*a^*b^*$  (with serious non-uniformities) to Munsell rendition space (MLab). The idea was to use all available  $L^*a^*b^*$  instrumentation, but achieve perfect Munsell uniformity at all 3-D LUT nodes. (McCann 1999). Also, at HP, McCann and Hubel (2003) patented an edge comparison Gamut Mapping algorithm based on Frankle and McCann (1983). John consulted for Konica, Apple, Gemological Institute, and Boston Scientific.

## **OPTICAL VEILING GLARE SETS THE LIMITS OF HDR IMAGING**

In 2006 John heard a student's paper claiming that the student's HDR photographs had captured 7 log<sub>10</sub> units of accurate scene radiances. Having worked 35 years for a camera manufacture, John doubted that claim, and invited the student to have lunch to discuss optical veiling glare. John agreed

about the scene's range, but asked the student if he had measured the actual light on the sensor. The student had not. Right after, John and I began a 15 year collaboration of thinking, measuring, experimenting with glare and the actual light on sensors: film, electronic and visual. This collaboration led to two books (McCann and Rizzi, 2012; McCann, Vonikakis, and Rizzi, dozens of papers (McCann, 2012:GlareLimitsHDR), and many tutorials. Glare plays a major role both in the acquisition and in the display of HDR scenes. Multiple exposure algorithms assume that lenses have zero optical glare. If that were true, then Multiple Exposures can increase the range of scene radiance. However, glare is real, and sets the same HDR limit in every exposure (after calibrated removal of tone-scale nonlinearities).

Given accurate scene radiances (not possible using cameras), we can calculate the light on the human retina (McCann and Rizzi 2012: 145-171; McCann and Vonikakis 2018). Retinal luminance shows vision's responses to light varies with the content of every scene.

### **3-D COLOR CONSTANCY**

At the 2009 AIC 11th Congress in Sydney, John reported work associated with the CREATE FP6 EU Project. This talk featured Carinna Parraman's watercolor paintings of a pair of 3-D Mondrians. One was an HDR scene, and other was an LDR scene. The HDR scene had painted wooden blocks in highly directional illumination. Its shadows had sharp edges. The LDR scene had identical painted wooden blocks in almost uniform illumination. (McCann's Judd Address-Figure 7c and 7d). Carinna's paintings are remarkable. They record the Appearances of the two scenes that have identical painted surfaces, but viewed in different HDR and LDR illuminations in the same room at the same time. The act of painting a matching scene segment on a flat piece of paper in uniform illumination, surrounded by the entire matching scene is the best measurement of Color Appearance! Iteratively, Carinna matched all scene segments in both 3-D Mondrians. She adjusted all the segments until they matched. (McCann, Parraman, and Rizzi 2009). The second remarkable step was that Carinna used a Spectrolino<sup>®</sup> reflectance meter to measure full spectral plots, and CIE X, Y, Z values of all 104 block facets in LDR and HDR. All 208 individual matches are in a standard color space for analysis.

Perfect color constancy for reflective objects occurs when observers select the same reflectance spectra in standard and test surface in different illuminations. Using flat Mondrians in uniform illumination, McCann, McKee and Taylor (1976) reported nearly perfect correlation of Scaled Integrated Reflectances. Carinna's LDR painting reflectances showed good correction between standard and test areas, with some moderate departures from constancy. Her HDR painting reflectances showed many substantial departures from constancy. The HDR 3-D Mondrian, with its sharp edges in illumination, had poor color constancy. Even though this HDR Mondrian is the best approximation to real Natural Scenes, it had the least Color Constancy.

At the same time, test participants were invited to view and analyze the HDR and LDR Mondrians. They were given maps of block facets painted with the same paint. They were asked to make Magnitude Estimates of Color Appearances. This data also showed that HDR illumination with edges seriously eroded color constancy. (McCann, Parraman, and Rizzi 2016)

### **2013 AIC CAPSTONE LECTURE**

John gave the Capstone Lecture at the 2013 AIC 12th Congress Newcastle, UK. His talk, "Colour: Intersection of Art and Science", closed the meeting by summarizing the interconnections of the many different AIC fields of interest: Light/Matter interactions in Physics; Color-Opponency in Psychophysics; Color separation photography and printing; Appearances' dependence on edges in scenes; and Neurophysiology of the visual pathway.

## **COLOR APPEARANCES BEFORE AND AFTER CATARACTS SURGERY**

At the 11th AIC Congress Sydney, Prof. Mitsuo Ikeda's (2003 Judd Medalist) presented his studies on the color effects of his cataracts. In 2019, John and his wife Mary followed Ikeda example. They reported their experiments measuring their cataract changes in Color Appearances of Natural Scenes. Just prior to cataract surgery, the Farnsworth Munsell 100 Hue test results characterized them both as Tritanopic with serious loss of discrimination at 488 and 589 nm dominant wavelength chips. Both had taken the 100 Hue Test since the 1970's with close to zero scores until they developed operable cataracts. After surgery they returned to normal color vision scores in the 100 Hue Test.

With one implant and one cataract eye, they observed different Color Appearances in the two eyes. They tested many color filters to see if a filter over the implant eye could make appearance match in both eyes. They tested many scenes and found that the same filter (CC40Y) made the two eyes match. They performed this experiment as soon as their bandages were removed, and repeated it until the second operation. At first light the operated eye had substantial edema that affected optical clarity. Nevertheless, the CC40Y filter made the eyes have the best color match in all post-operation scenes. After the second implant, both eyes matched at first light. No long-term natural scenes adaptation was observed in after cataract removal. (McCann 2021:CataractColor)

## **JOHN'S COLOR AND IMAGING LEGACY**

John's earliest work began with building computational appearance models by multiplying edge ratios to calculate appearances in natural HDR scenes. Land and McCann laid the framework for modeling human vision, and making cameras that mimic vision's scene processing. Their L-M Retinex model was a starting point for many other Retinex models, the many from my lab called Milano Retinex (McCann and Rizzi 2012: 293-337). The Land and McCann (1971) paper is seminal to many papers regarded as the foundation of image processing: in spatial filtering (Stockham 1972), in early computational frameworks of vision and AI models, (Marr, 1974; Horn, 1974 ), in models of neural processing (Grossberg and Todorović 1988).

Fourteen years later in 1981, Morita stimulated the Digital revolution in photography that took 20 years to reach maturity. In the early 2000's HDR became a hot topic in digital image processing. All successful general solutions for HDR rendering optimize the scene's edge ratios.

All of John's work has the same pattern of research. It begins with a curious observation of an unanticipated result. It is followed by a novel experimental design to measure observer's responses to that curious visual stimulus. That design measures the appearance of the scene segment of interest, and many other scene segments in the field of view.

I like to underline a very important characteristics about John research attitude. John is meticulous about radiance calibration. John never uses estimates of display radiance made from digit values in computer memory. He always measures actual telephotometer radiances directly from scenes and display screens. Rarely does John describe observer preferences in image processing. He compares calculated results a with precisely defined ground truth. He embraced all aspects of human color research, and the entire digital imaging revolution. The idea connecting color, and natural HDR imaging is that appearance is controlled by spatial, multi-resolution processes.

Like all successful enthusiasts, John continues his study of color vision, photography, and fine art.

## **REFERENCES**

Daw, N.W. 1962. Why after-images are not seen in normal circumstances. Nature 196: 1143-1145.

- Frankle, J. and J.J. McCann. 1983. Method and apparatus of lightness imaging. US Patent 4,384,336. filed Aug 29,1980; issued May 17, 1983.
- Grossberg, S., and D. Todorović. Neural dynamics of 1-D and 2-D brightness perception: A unified model of classical and recent phenomena. *Perception and Psychophysics* 43: 241–277.
- Horn, B. 1974. Determining Lightness from an Image. *Comp. Gr. Img. Proc.* 3:277-99.
- Land, E.H. and J.J. McCann. 1971. Lightness and retinex theory. *J. Opt. Soc. Am.*, 61: 1-11, 1971.
- Land, E.H. 1974. The Retinex Theory of Colour Vision. *Proc. Royal. Institution Gr Brit.* 47: 23-58.
- Marr, D. 1974. The Computation of Lightness by the Primate Retina, *Vision Res.*, 14:1377-88.
- McCann, J. J., S.P. McKee and T. Taylor. 1976. Quantitative Studies in Retinex Theory, A Comparison Between Theoretical Predictions and Observer Responses to Color Mondrian Experiments. *Vision Research.* 16:445-58.
- McCann, J. J, and K. Houston. 1983. Color Sensation, Color Perception and Mathematical Models of Color Vision. in: *Colour Vision*, J.D. Mollon, and L.T. Sharpe, ed:Academic Press, London, 535-544.
- McCann, J.J. 1999. Color spaces for color-gamut mapping. *J. Electronic Imaging*, 8: 354-364.
- McCann, J.J. 2003. Image processing analysis of traditional Gestalt vision experiments," in 9th Congress AIC. Rochester, SPIE Proc. 442: 375-378.
- McCann, J.J., and P. M. Hubel. 2003. In-gamut image reproduction method using spatial comparison. US Patent, PN US 6,516,089, 2003.
- McCann, J. J. 2008. Color Matches in Dim Narrow-band Illumination. in *Proc.AIC*, Stockholm.
- McCann, J.J., C. E. Parraman, and A. Rizzi. 2009. REFLECTANCE, ILLUMINATION, AND EDGES IN 3-D MONDRIAN COLOUR-CONSTANCY EXPERIMENTS. *Proc. 2009 AIC*, 11th Congress, Sidney.
- McCann, J.J. and A. Rizzi. 2012, *The Art and Science of HDR Imaging*. Chichester:ISandT Wiley.
- McCann, J.J., C. Parraman, and A. Rizzi. 2014. Reflectance, illumination, and appearance in color constancy. *Frontiers in Psychology*.
- McCann, J.J., V. Vonikakis, and A. Rizzi. 2018. HDR Scene Capture and Appearance. *SPIE Spotlight Tutorial*, Chapters 1-15.
- McCann J.J. and V.Vonikakis. 2018. Calculating Retinal Contrast from Scene Content: A Program. *Front. Psychol.*
- McCann, J. J. and Mary McCann. 2019. Temporary Tritanopia:Effects of cataract surgery on color. *Proc. ISandT Color Imaging Conf.,Paris,22:278-1-236-6*
- McCann, J.J. 2021:CataractColor. "[retinex2.net/Publications/cataractcolor.html](https://www.retinex2.net/Publications/cataractcolor.html)".
- McCann, J.J. 2021: Constancy Without Adaptation. "<https://www.retinex2.net/Publications/constancywithoutadaptation.html>".
- McCann, J.J. 2021:EdgesGradients. "<https://www.retinex2.net/Publications/edgesgradients.html>".
- McCann, J.J. 2021:GlareLimitsHDR. "<https://www.retinex2.net/Publications/glarelimitshdr.html>".
- McCann, J.J. 2021:LandColorMondrian. "<https://www.retinex2.net/Publications/landcolormondrian.html>".
- McCann, J.J. 2021:LM Retinex. "<https://www.retinex2.net/Publications/lm-retinex.html>".
- McCann, J.J. 2021:rod-Lcone. "<https://www.retinex2.net/Publications/rod-lcone.html>".
- Roberson, A.R. 1980. Meeting Report: ISCC Helson Memorial Symposium on Chromatic Adaptation. *Color research and application.* 5: 180-181
- Stiehl, W. A., J. J. McCann and R. L. Savoy. 1983. Influence of intraocular scattered light on lightness-scaling experiments. *J. Opt. Soc. Am.*, 73; 1143-1148.
- Stockham, T, Jr. 1972 Image Processing in the Context of a Visual Model. *Proc. IEEE*, 60:828-42.





# PHOTO OF THE CLOSING CEREMONY

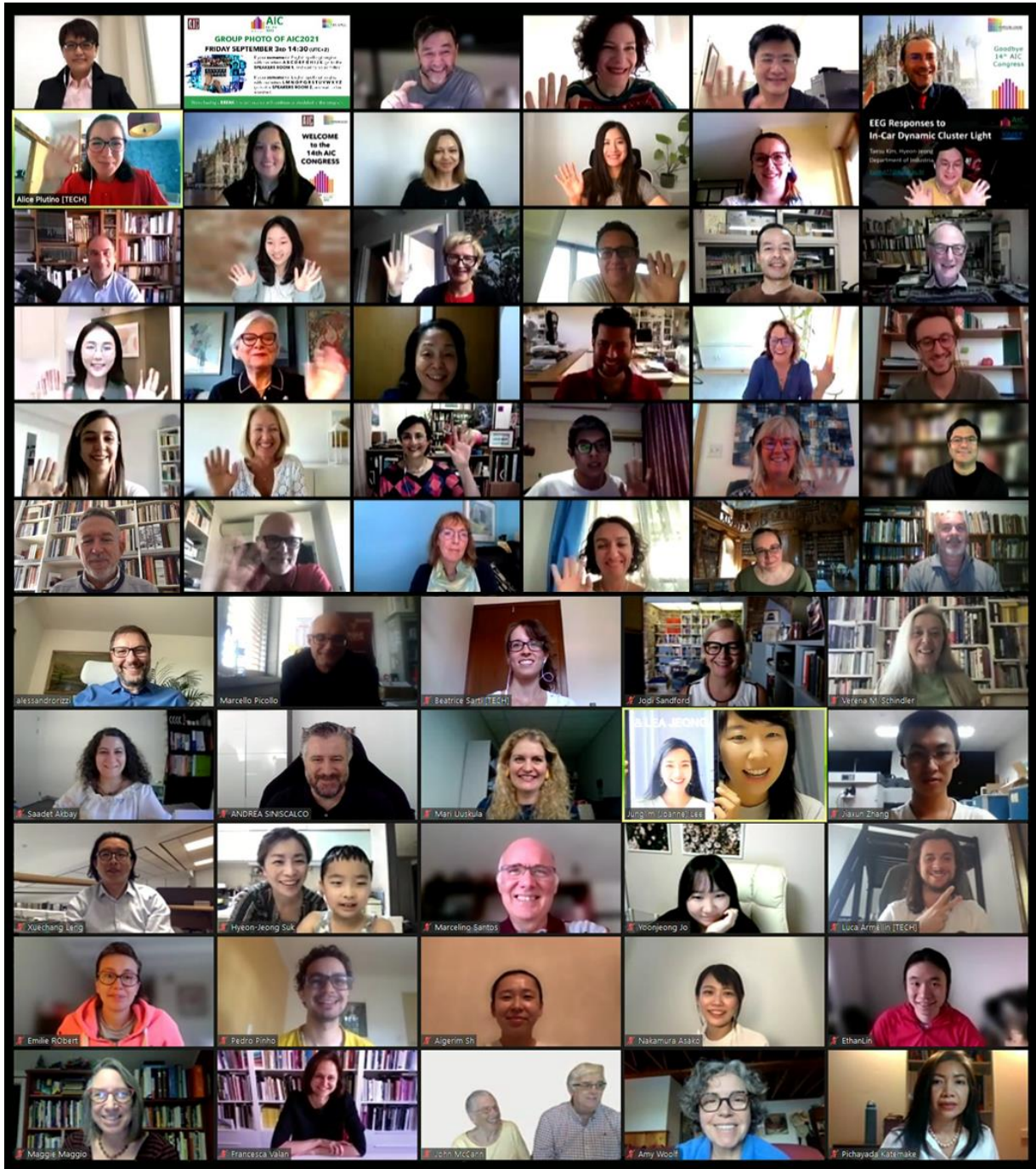



# INDEX OF AUTHORS

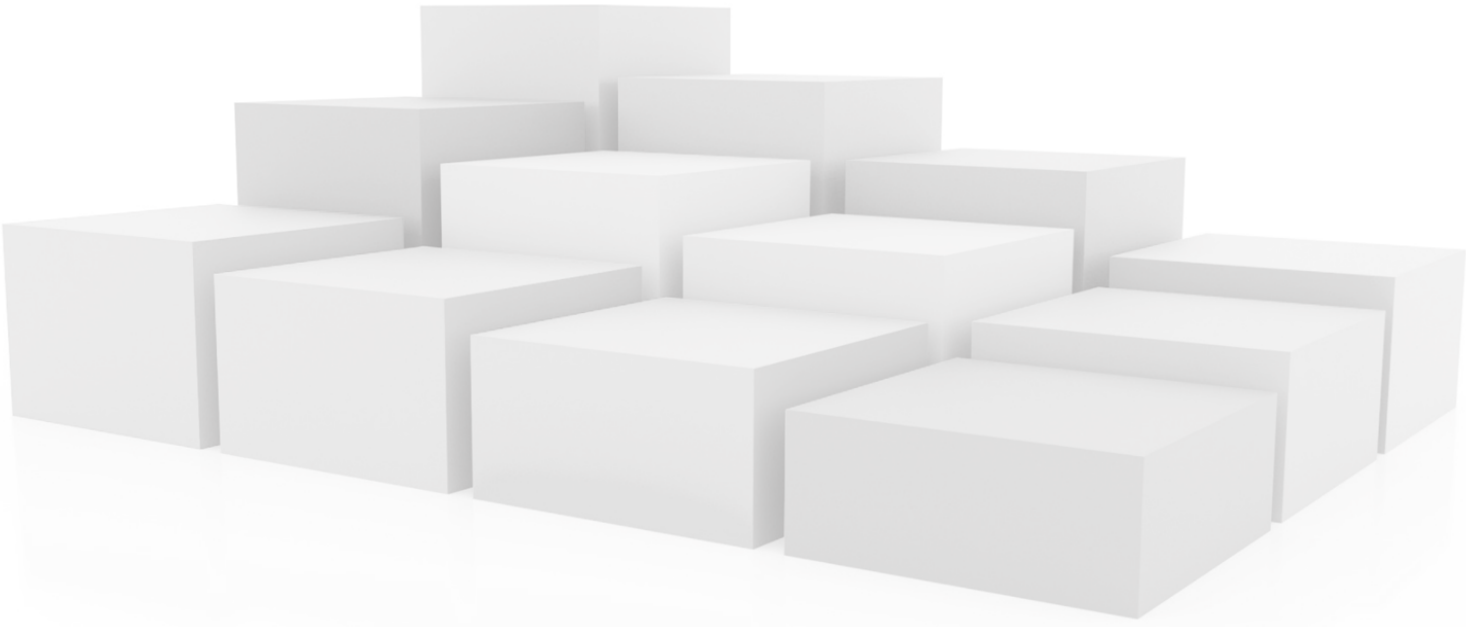

## INDEX OF AUTHORS

Abreu	Diamantino S.	515	Bouayed	Maliha	891
Aceto	Maurizio	627	Meziane		
Agostino	Angelo	627	Bouchez	Caroline	1127
Akbay	Saadet	355, 399, 1091	Bračko	Sabina	293
Akiba	Kota	387	Bremner	Julie	299
Albert-Vanel	Michel	867	Brevi	Fausto	1145
Aldhahir	Shahin	173	Briggs	David	1073
Allen	Pauline	1379	Brosio	Alessandra	545
Almeida	Teresa	1177	Burgos-	Francisco J.	427, 449
Alterini	Tommaso	449	Fernández		
Álvarez García	Maria Camila	855	Bustamante	Oscar Francisco	589
Angelo	Kine	551, 763	Buzzelli	Marco	233, 245
Anzani	Stefano	539	Calafiore	Paolo	1109
Apollonio	Fabrizio I.	703, 739	Calatroni	Alberto	627
Arosio	Riccardo	299	Calvo Ivanovic	Ingrid	879
Asano	Akira	475	Campos	Joaquín	179, 185
Ashby-Green	Mary	1369	Canal	Jose M.	903
Asis	Daniel	1415	Cannito	Loreta	539
Avci	Ayse Nihan	355	Capron	Jean-Luc	667
Awano	Yumi	817	Carpenter	Katherine	563
Ayama	Miyoshi	393, 813	Casini	Andrea	621, 745
Balabanoff	Doreen	733	Caumon	Céline	361
Baldoni	Vincenzo	959	Caumon	Lorrain	361
Balloni	Donatella	1145	Ceccarelli	Sofia	615
Baniani	Mahshid	457	Cecchi	Marta Elisa	879
Barbara	Anna	855	Chalmers	Andrew	485
Barbier	Rémi	287	Chang	Chien-Wei	481
Barbur	John L.	437	Chapoulie	Rémy	651
Bartolomei	Cristiana	1035	Chatterjee	Sreya	1329
Batistatou	Adamantia	709	Chen	Jing	603
Bécheras	Élodie	361	Chen	Kaiyin	161
Bell	Simon	757	Chen	Mengyuan	373
Bellia	Laura	325, 331	Chen	Ming-Hsiu Mia	481
Bendito	Petronio	1053	Chen	Qinyue	1165
Benghiat	Heather	1379	Cheng	Yun-Maw	481
Bianco	Simone	233, 245	Chenyang	Deng	203
Bizjak	Grega	293	Cherubini	Filippo	621, 745
Błaszczak	Urszula	331	Cheung	Vien	861, 885, 1059
Blaznik	Barbara	293	Chiang	Raymond	143
Boeri	Cristina	673	Choi	Jihye	1109
Bollini	Letizia	1011	Chorein	Blandine	1127
Bonanomi	Cristian	227	Cicala	Margherita	775
Bonnardel	Valérie	1397	Ciocca	Gianluigi	233
Bonollo	Claudia	1409	Corger	Dominique	1127
Borin	Ambra	879	Crespi	Arianna	1341
Bortolotti	Alessandro	539	Csillag	Paula	1317
			Cucci	Costanza	621, 745

<b>Cui</b>	Hao	263	<b>Gaiani</b>	Marco	703, 739
<b>Cwierz López</b>	Halina	305, 415	<b>Galasso</b>	Clorinda Sissi	879
<b>Da Cruz</b>	António José	515	<b>Game</b>	Chloe A.	239
<b>Rodrigues</b>	Macedo		<b>Garagnani</b>	Simone	959
	Coutinho		<b>Gassiot</b>	Susanna	427
<b>Dabagov</b>	Sultan	615	<b>Gaucci</b>	Andrea	959
<b>De Andrés</b>	David	557	<b>Ge</b>	Xiaochan	989
<b>de Clermont-</b>	Helene	1209	<b>Giani</b>	Camilla	673
<b>Gallerande</b>			<b>Gijsenij</b>	Arjan	281
<b>De La Codre</b>	Hortense	651	<b>Giuliani</b>	Luca	1335
<b>De la Torre</b>	Irene	751	<b>Gjærde</b>	Kari Bjerke	421
<b>De Lira</b>	Marley	1115	<b>Glogar</b>	Martinia Ira	577, 691, 903
<b>De Lucas Tron</b>	Alfonso	257	<b>Gökmenoğlu</b>	Firdevs	399
<b>Deeb</b>	Rada	191	<b>Gonçalves</b>	Berenice	1115
<b>Delevoye-</b>	Yvonne N.	709	<b>Gong</b>	Shi-Min	533
<b>Turrell</b>			<b>Green</b>	Phil	421
<b>Demirbaş</b>	Güler Ufuk	1091	<b>Green-</b>	Paul	1097
<b>Desteuque</b>	Christophe	1431	<b>Armytage</b>		
<b>Díaz Barrancas</b>	Francisco	305, 415	<b>Griber</b>	Yulia A.	833, 1017, 1361
<b>Díaz-Doutón</b>	Fernando	449	<b>Gryko</b>	Lukasz	331
<b>Diglio</b>	Francesca	325, 331	<b>Gu</b>	Lanqing	709
<b>Dolphin</b>	Tony	299	<b>Guarini</b>	Gianluca	939
<b>Duarte</b>	Rui	945	<b>Guerry</b>	Estelle	361, 679
<b>D'Ugo</b>	Rossella	1121	<b>Guglielmotti</b>	Valeria	615
<b>Dumitrescu</b>	Delia	915	<b>Guo</b>	Boshuo	1172, 1195
<b>Durão</b>	Maria João	1349	<b>Gutierrez</b>	Carolina	1311
<b>Elgani</b>	Elena E.	849	<b>Hampai</b>	Dariusz	615
<b>Epicoco</b>	Déborah	891	<b>Han</b>	Eunji	823
<b>Espinosa</b>	Isabel	1215	<b>Hardeberg</b>	Jon Y	1239
<b>Zaragoza</b>			<b>Hasle Bak</b>	Nanna	349
<b>Estribeau</b>	Magali	287	<b>Hazin</b>	Márcia	653
<b>Evans</b>	Benjamin E. W.	437	<b>Henry</b>	Philip	909
<b>Fairchild</b>	Mark	1047	<b>Hernández-</b>	Javier	311
<b>Falta</b>	Martina	1011	<b>Andrés</b>		
<b>Falzone</b>	Patrizia	727	<b>Hestbech</b>	Emma-Sofie	349
<b>Farnand</b>	Susan	563, 639	<b>Hira</b>	Shoko	393
<b>Farr</b>	Marcus	843	<b>Hirschler</b>	Robert	873
<b>Fernández-</b>	Juan Carlos	179	<b>Hobley</b>	Brandon	299
<b>Becáres</b>			<b>Horiuchi</b>	Takahiko	149, 387
<b>Fernández-</b>	Soledad	311	<b>Huang</b>	Yiming	199
<b>Carvelo</b>			<b>Hunjet</b>	Anica	1183
<b>Fernandez-</b>	Christine	1203	<b>Huraibat</b>	Khalil	179, 185
<b>Maloigne</b>			<b>Hutchings</b>	John	509
<b>Ferrero</b>	Alejandro	179, 185	<b>Infantes</b>	Christelle	361
<b>Finlayson</b>	Graham D.	191, 215, 239, 269, 275, 299	<b>Ishikawa</b>	Tomoharu	393, 813
			<b>Isola</b>	Ignacio	427
<b>Flinčec Grgac</b>	Sandra	903	<b>Isomi</b>	Mai	137
<b>Flueckiger</b>	Barbara	1329	<b>Iyota</b>	Hiroyuki	137
<b>Fragliasso</b>	Francesca	325, 331	<b>Jarild Koblanck</b>	Henriette	1065
<b>Frison</b>	Guido	627	<b>Jayaprakash</b>	Sandhiya	209
<b>Fuentes Villa</b>	Tania Eréndeni	1311	<b>Brindha</b>		
<b>Fukagawa</b>	Shimpei	137	<b>Jenkin</b>	Robin	75
<b>Fusari</b>	Daniele	1269			
<b>Gaetani</b>	Flora	1145			

Jeong	Lea	1103	Li	Mengqi	603
Jiang	Hao	155	Li	Qinyuan	167
Jiang	Yutong	609	Liang	Jinxing	167
Jo	YoonJeong	491	Liao	Ching Chih	1079
Jonauskaite	Domicela	891	Liberini	Simone	1251, 1257, 1263
Kakiyama	Koichiro	801	Lin	Jingyi	343
Kanthak	Thomas	763	Lin	Wensi	603
Katayama	Ichiro	497, 527	Lin	Yi-Tun	215
Kawabata	Yasuhiro	801	Liu	Tzuhao	509
Kikuchi	Kumiko	1239	Liu	Xiaoxuan	1227
Kim	Boram	795	Llopis	Jorge	751
Kim	Byeongjin	469	López-	Ana Belén	251
Kim	JinYoung	463	Baldomero		
Kim	Taesu	409, 469, 783	Lopez-	Pia	521
Kirchner	Eric	185, 645	Izquierdo		
Kirkwood	Craig	1151	Lotut	Zoriana	983
Kitamura	Kaoruko	131	Loureiro	Domingos	1177
Klotz	Angelika	1391	Louring Nielsen	Stine	349
Kmita	Anna	837	Lu	Yan	167, 1233
Knöll	Martin	709	Luo	Ming Ronnier	343, 503, 509, 1227
Koeckhoven	Pim	281, 645	Luzzatto	Lia	993
Koliousis	Alexandros	1005	Ma	Shulei	161
Konno	Terumi	801	Mackiewicz	Michal	299
Kooroshnia	Marjan	915	Macruz	Andrea	843
Koster	Tammo	645	Maggio	Maggie	1097
Kovač	Franci	293	Magnan	Pierre	287
Kovac	Koraljka	691	Magrin-	Ivan	1287
Dugandzic			Chagnolleau		
Križan	Sandra	1183	Makino	Kanoko	131
Küçükılıç	Esra	721	Mandić	Lidija	1189
Özcan			Mao	Xue	989
Kushnirenko	Elizaveta	921	Marani	Pietro C.	85
Kuzio	Olivia	639	Marembert	Charlotte	651
Kvitle	Anne Kristin	421	Marotta	Anna	545, 1023, 1029
Kwiatkowska-	Agata	827	Martel	Anadi	1431
Lubańska			Martinez-	Miguel Angel	311
Lai	Peihua	1172, 1195	Domingo		
Lauda	Luciano	775	Martini	Berta	1121
Laurent	Eric	891	Mastrantoni	Claudia	879
Lee	Bokyung	783	Matusiak	Barbara	551, 715
Lee	Chao-Lung	481		Szybinska	
Lee	Gyeonghwa	861	Mauger	Emmanuelle	1209
Lee	Gyunpyo	789	Mayer	Flávia	443
Lee	Ji Eun	583	Mazzoli	Cecilia	1035
Lee	JiYeon	463	McCann	John	117
Lee	Junglim	597	McVey	Jake	275
Lee	Wen-Yuan	533	Mercuri	Fulvio	615
Lei	Zhaohua	739, 1059	Michiels	Inez	897
Lenclos	Jean-Philippe	105	Mikhail	Reejy Atef	855
Leng	Xuechang	927		Abdelatty	
Lewis	Erin	915	Milosovic	Marjetka	179
Li	Luke	609			

<b>Mitsui</b>	Minoru	813	<b>Perales</b>	Esther	179, 185
<b>Mohr</b>	Christine	891	<b>Pérez</b>	Jorge	179
<b>Monchiero</b>	Umberto	849	<b>Pernão</b>	João Nuno	653
<b>Monteiro</b>	Gisela Costa Pinheiro	873	<b>Picollo</b>	Marcello	621, 745
<b>Morabito</b>	Giulia	1341	<b>Pinheiro</b>	Ana Paula	945
<b>Morales</b>	Andrea	179	<b>Pinheiro</b>	Daniela F.	1177
<b>Morganti</b>	Caterina	1035	<b>Pinho Souza</b>	Pedro Felipe	1293
<b>Morgenstern</b>	Orly	1311	<b>Pires</b>	Rebecka	933
<b>Moro</b>	Monica	1065	<b>Piscitelli</b>	Manuela	1299
<b>Mounier</b>	Aurélie	651	<b>Plantier</b>	Justin	287
<b>Mughal</b>	Muhammad Farhan	503	<b>Plutino</b>	Alice	1305, 1341
<b>Mullins</b>	Michael	349	<b>Pointer</b>	Michael R.	167, 503
<b>Muraki Asano</b>	Chie	475	<b>Pompas</b>	Renata	999
<b>Mutlu Tunca</b>	Gülru	1091	<b>Ponzo</b>	Giorgio	757
<b>Mylonas</b>	Dimitris	627, 1005, 1017	<b>Potočić</b>	Vesna Marija	577
<b>Nakajima</b>	Takumi	813	<b>Matković</b>		
<b>Nakamura</b>	Asako	703	<b>Pyykkö</b>	Saara	1133
<b>Nazari</b>	Marzieh	551	<b>Qian</b>	Huang	977
<b>Negretti</b>	Giannantonio	1263, 1275	<b>Queiroz</b>	Francisco	909
<b>Negri</b>	Sabrina	1323	<b>Quiblier</b>	Michael	891
<b>Netti</b>	Rossana	1023	<b>Redi</b>	Martina	615
<b>Ng</b>	Woon Lam	1085	<b>Rey Barroso</b>	Laura	427
<b>Nieves</b>	Juan Luis	311	<b>Reyes González</b>	Alberto	633
<b>Ningfang</b>	Liao	203	<b>Ribeiro</b>	Susana	1385
<b>Noguchi</b>	Sachiko	527	<b>Rivera</b>	Evelyn L.	1311
<b>Nussbaum</b>	Peter	421	<b>Rizzi</b>	Alessandro	1251, 1257, 1305, 1342, 1447
<b>O'Connor</b>	Zena	1159	<b>Robert</b>	Emilie	287
<b>Odetti</b>	Jimena Vanina	633	<b>Rodriguez- Carmona</b>	Marisa	437
<b>Oe</b>	Yuki	131	<b>Roe</b>	Jenny	709
<b>Ohkoba</b>	Minoru	393	<b>Roldán</b>	Mónica	427
<b>Ohtsuka</b>	Sakuichi	393	<b>Rolland</b>	Nicolas	1209
<b>Or</b>	Kazim Hilmi	433	<b>Romero</b>	Javier	311
<b>Orazi</b>	Noemi	615	<b>Rossi</b>	Maurizio	319, 539, 939
<b>Ortiz</b>	Carolina	251	<b>Rubiño</b>	Manuel	251
<b>Ortiz</b>	Maria I.	589	<b>Ruedel</b>	Ulrich	1329
<b>Hernández</b>	Georgina		<b>Ruiter</b>	Margo	1403
<b>Ortiz</b>	Citlali Q.	589	<b>Ruiz Llobet</b>	Anna	427
<b>Hernández</b>			<b>Sabião</b>	Amanda	1317
<b>Ramírez</b>			<b>Sakai</b>	Hideki	137, 403
<b>Osumi</b>	Masayuki	817	<b>Sakata</b>	Katsuaki	1245
<b>Otero</b>	Vanessa	659	<b>Sakurai</b>	Masato	807
<b>Padavić</b>	Ivana	691	<b>Salas</b>	Carlos	251
<b>Palumbo</b>	Riccardo	539	<b>Salveti</b>	Francesca	769
<b>Paramei</b>	Galina V.	1017	<b>Sandford</b>	Jodi L.	1355
<b>Pardo</b>	Pedro José	305, 415	<b>Santilli</b>	Oscar	379
<b>Park</b>	Hyeonju	337	<b>Santos</b>	Ângela	659
<b>Park</b>	YungKyung	463, 491, 597, 823, 1103	<b>Santos</b>	Joaquim	1041
<b>Pavignano</b>	Martino	953	<b>Sarti</b>	Beatrice	1305, 1341
<b>Peng</b>	Rui	1227	<b>Sasaki</b>	Kazuya	813
			<b>Sathaye</b>	Kedar	227



Scaglione	Michela	769	Van Der Lans	Ivo	185
Scagnoli	Martina	879	van Der Werff	Thelma	1369
Schettini	Raimondo	233, 245	van Wijk	Carola	645
Schindler	Verena M.	833, 1361, 1439	Vasques	Rui Pessoa	515
Scullica	Francesco	849	Vatteroni	Monica	209
Segawa	Kaori	527	Vendrami	Junior	1115
Sepúlveda	Marcela	965	Vidal	Pascal	1373
Serra	Juan	557, 751	Vilarigues	Márcia	659
Servant	Laurent	651	Vilaseca	Meritxell	427, 449
Shamey	Renzo	263, 569	Viqueira	Valentín	179
Shi	Keyu	343	Voss	Lupe	1279
Shimakura	Hitomi	1245	Vuković	Dijana	1183
Shimura	Ayaka	475	Wadhwa	Abhay	1425
Shunayeva	Aigerim	783	Walters	Kathryn	915
Silani	Michele	959	Wang	Jisheng	603
	Giovanni		Watanabe	Shuhei	149
Simone	Gabriele	209, 1305	Weber	Maya	763
Siniscalco	Andrea	367	Weber	Ralf	763
Spiers	Peter	281	Wenmin	Wu	203
Stefani	Lorenzo	621, 745	Wentworth	Mark	1311
Stickland	Phil	1379	Westland	Stephen	281, 373, 885, 909, 1171, 1195
Strgar Kurečić	Maja	1189			
Suardi	Roberta	1257, 1263	Wong	Sherman	1279
Suk	Hyeon-Jeong	337, 409, 469, 783, 789, 795, 1165, 1221	Wu	Jack H. C.	221
			Wu	Ray-Chin	481
Sun	Pei-Li	143	Xia	Guobin	885, 909
Surazakov	Arzhan	1419	Xiang	Changying	715
Sutlović	Ana	577, 691	Xiao	Kaida	167, 1233
Swiathy	Greggory	287	Xin	John H.	221
Takata	Rumiko	527	Xiong	Nian	569
Tanaka	Midori	387	Xu	Haisong	155, 199
Tang	Tang	861	Xu	Jie	989
Tantcheva- Burdge	Elza	1059	Yamaji	Kin'nosuke	497
Tarajko- Kowalska	Justyna	685	Yamamoto	Ryoma	807
Tartaglia	Camilla	971	Yamamoto	Sari	697
Tchobanou	Mikhail	233	Yan	Yuchun	1165, 1221
Terrei	Alessandra	615	Yanagida	Yoshiko	813
Thompson	Michael B.	239	Yao	Pengpeng	221
Tombolato	Monica	1121	Yasheng	Li	203
Tominaga	Shoji	1239	Ye	Zhengnan	199
Toninelli	Alice	1263	Yoshizawa	Nozomu	131
Torres	Ana	557	Yu	Beichen	757
Trini Castelli	Clino	97	Yu	Luwen	885, 909
Trumpy	Giorgio	1329	Yumei	Li	203
Trussell	Henry J.	569	Zampieri	Enrico	959
Tsuda	Haruno	131	Zanchi Sarwari	Antonia	903
Ünver	Fatma Rengin	721	Zhang	Jiaxun	155
Uusküla	Mari	891, 1005	Zhang	Mengyue	603
Valero	Eva M.	311	Zhang	Ye	161
van Beek	Henni	645	Zheng	Yihua	609
			Zhu	Yuteng	269

Zich	Ursula	953
Zini	Simone	233
Zissis	Georges	361
Zuccoli	Franca	1139



1 COLOR AND MEASUREMENT INSTRUMENTATION	2 COLOR AND DIGITAL	3 COLOR AND LIGHTING	4 COLOR AND PHYSIOLOGY
5 COLOR AND PSYCHOLOGY	6 COLOR AND PRODUCTION	7 COLOR AND RESTORATION	8 COLOR AND BUILT ENVIRONMENT
9 COLOR AND DESIGN	10 COLOR AND CULTURE	11 COLOR AND EDUCATION	12 COLOR AND COMMUNICATION MARKETING



Proceedings of the  
International Colour Association (AIC)  
Conference 2021  
Milan (Italy), August 30<sup>th</sup> - September 3<sup>rd</sup> 2021

